



FCC TEST REPORT

REPORT NO.: RF980601A06

MODEL NO.: WS200

RECEIVED: June 1, 2009

TESTED: June 12 ~ Aug. 25, 2009

ISSUED: Aug. 28, 2009

APPLICANT: PRIMAX ELECTRONICS LTD.

ADDRESS: No. 669, Ruey Kuang Road, Neihu, Taipei, Taiwan,
R.O.C.

ISSUED BY: Bureau Veritas Consumer Products Services (H.K.)
Ltd., Taoyuan Branch

LAB LOCATION: No. 47, 14th Ling, Chia Pau Tsuen, Lin Kou Hsiang,
Taipei Hsien, 244 Taiwan

This test report consists of 78 pages in total. It may be duplicated completely for legal use with the approval of the applicant. It should not be reproduced except in full, without the written approval of our laboratory. The client should not use it to claim product endorsement by TAF or any government agencies. The test results in the report only apply to the tested sample.





TABLE OF CONTENTS

1.	CERTIFICATION	4
2.	SUMMARY OF TEST RESULTS	5
2.1	MEASUREMENT UNCERTAINTY	6
3.	GENERAL INFORMATION	7
3.1	GENERAL DESCRIPTION OF EUT	7
3.2	DESCRIPTION OF TEST MODES	8
3.2.1	CONFIGURATION OF SYSTEM UNDER TEST	9
3.2.2	TEST MODE APPLICABILITY AND TESTED CHANNEL DETAIL	10
3.3.3	GENERAL DESCRIPTION OF APPLIED STANDARDS	12
3.3.4	DESCRIPTION OF SUPPORT UNITS	13
4.	TEST TYPES AND RESULTS	14
4.1	CONDUCTED EMISSION MEASUREMENT	14
4.1.1	LIMITS OF CONDUCTED EMISSION MEASUREMENT	14
4.1.2	TEST INSTRUMENTS	15
4.1.3	TEST PROCEDURES	16
4.1.4	DEVIATION FROM TEST STANDARD	16
4.1.5	TEST SETUP	16
4.1.6	EUT OPERATING CONDITIONS	17
4.1.7	TEST RESULTS	18
4.2	RADIATED EMISSION MEASUREMENT	20
4.2.1	LIMITS OF RADIATED EMISSION MEASUREMENT	20
4.2.2	TEST INSTRUMENTS	21
4.2.3	TEST PROCEDURES	22
4.2.4	DEVIATION FROM TEST STANDARD	22
4.2.5	TEST SETUP	23
4.2.6	EUT OPERATING CONDITIONS	23
4.2.7	TEST RESULTS	24
4.3	NUMBER OF HOPPING FREQUENCY USED	34
4.3.1	LIMIT OF HOPPING FREQUENCY USED	34
4.3.2	TEST INSTRUMENTS	34
4.3.3	TEST PROCEDURES	34
4.3.4	DEVIATION FROM TEST STANDARD	35
4.3.5	TEST SETUP	35
4.3.6	TEST RESULTS	35
4.4	DWELL TIME ON EACH CHANNEL	38
4.4.1	LIMIT OF DWELL TIME USED	38
4.4.2	TEST INSTRUMENTS	38
4.4.3	TEST PROCEDURES	38
4.4.4	DEVIATION FROM TEST STANDARD	38
4.4.5	TEST SETUP	39
4.4.6	TEST RESULTS	39
4.5	CHANNEL BANDWIDTH	47
4.5.1	LIMITS OF CHANNEL BANDWIDTH	47
4.5.2	TEST INSTRUMENTS	47
4.5.3	TEST PROCEDURE	47
4.5.4	DEVIATION FROM TEST STANDARD	48



4.5.5	TEST SETUP	48
4.5.6	EUT OPERATING CONDITION	48
4.5.7	TEST RESULTS	48
4.6	HOPPING CHANNEL SEPARATION	54
4.6.1	LIMIT OF HOPPING CHANNEL SEPARATION	54
4.6.2	TEST INSTRUMENTS	54
4.6.3	TEST PROCEDURES	54
4.6.4	DEVIATION FROM TEST STANDARD	55
4.6.5	TEST SETUP	55
4.6.6	TEST RESULTS	55
4.7	MAXIMUM PEAK OUTPUT POWER	61
4.7.1	LIMITS OF MAXIMUM PEAK OUTPUT POWER MEASUREMENT	61
4.7.2	TEST INSTRUMENTS	61
4.7.3	TEST PROCEDURES	61
4.7.4	DEVIATION FROM TEST STANDARD	61
4.7.5	TEST SETUP	62
4.7.6	EUT OPERATING CONDITION	62
4.7.7	TEST RESULTS	62
4.8	BAND EDGES MEASUREMENT	68
4.8.1	LIMITS OF BAND EDGES MEASUREMENT	68
4.8.2	TEST INSTRUMENTS	68
4.8.3	TEST PROCEDURE	68
4.8.4	DEVIATION FROM TEST STANDARD	68
4.8.5	EUT OPERATING CONDITION	68
4.8.6	TEST RESULTS	69
4.9	ANTENNA REQUIREMENT	75
4.9.1	STANDARD APPLICABLE	75
4.9.2	ANTENNA CONNECTED CONSTRUCTION	75
5.	PHOTOGRAPHS OF THE TEST CONFIGURATION	76
6.	INFORMATION ON THE TESTING LABORATORIES	77
7.	APPENDIX A – MODIFICATIONS RECORDERS FOR ENGINEERING CHANGES TO THE EUT BY THE LAB	78



1. CERTIFICATION

PRODUCT: Pen Tablet
BRAND NAME: SMART
MODEL NO.: WS200
APPLICANT: PRIMAX ELECTRONICS LTD.
TESTED: June 12 ~ Aug. 25, 2009
TEST SAMPLE: ENGINEERING SAMPLE
STANDARDS: FCC Part 15, Subpart C (Section 15.247)
ANSI C63.4-2003

The above equipment has been tested by **Bureau Veritas Consumer Products Services (H.K.) Ltd., Taoyuan Branch**, and found compliance with the requirement of the above standards. The test record, data evaluation & Equipment Under Test (EUT) configurations represented herein are true and accurate accounts of the measurements of the sample's EMC characteristics under the conditions specified in this report.

PREPARED BY : Jessica Cheng , **DATE:** Aug. 28, 2009
(Jessica Cheng / Specialist)

TECHNICAL ACCEPTANCE : Jamison Chan , **DATE:** Aug. 28, 2009
Responsible for RF (Jamison Chan / Supervisor)

APPROVED BY : Ken Liu , **DATE:** Aug. 28, 2009
(Ken Liu / Assistant Manager)

2. SUMMARY OF TEST RESULTS

The EUT has been tested according to the following specifications:

APPLIED STANDARD: FCC Part 15, Subpart C			
STANDARD SECTION	TEST TYPE AND LIMIT	RESULT	REMARK
15.207	AC Power Conducted Emission	PASS	Meet the requirement of limit. Minimum passing margin is -10.15dB at 0.568MHz.
15.247(a)(1)(iii)	Number of Hopping Frequency Used Spec.: At least 15 channels	PASS	Meet the requirement of limit.
15.247(a)(1)(iii)	Dwell Time on Each Channel Spec. : Max. 0.4 second within 31.6 second	PASS	Meet the requirement of limit.
15.247(a)(1)	1. Hopping Channel Separation Spec. : Min. 25 kHz or 20 dB bandwidth, whichever is greater (see Note) 2. Spectrum Bandwidth of a Frequency Hopping Sequence Spread Spectrum System	PASS	Meet the requirement of limit.
15.247(b)	Maximum Peak Output Power Spec.: max. 21dBm (see Note)	PASS	Meet the requirement of limit.
15.247(d)	Transmitter Radiated Emissions Spec.: Table 15.209	PASS	Meet the requirement of limit. Minimum passing margin is -3.23dB at 1654.00MHz.
15.247(d)	Band Edge Measurement	PASS	Meet the requirement of limit.

NOTE: If The Frequency Hopping System operating in 2400-2483.5MHz band and the output power less than 125mW. The hopping channel carrier frequencies separated by a minimum of 25kHz or two-thirds of the 20dB bandwidth of hopping channel whichever is greater.

2.1 MEASUREMENT UNCERTAINTY

Where relevant, the following measurement uncertainty levels have been estimated for tests performed on the EUT as specified in CISPR 16-4-2:

This uncertainty represents an expanded uncertainty expressed at approximately the 95% confidence level using a coverage factor of $k=2$.

MEASUREMENT	FREQUENCY	UNCERTAINTY
Conducted emissions	150kHz ~ 30MHz	2.44 dB
Radiated emissions	30MHz ~ 1GHz	3.72 dB
	1GHz ~ 40GHz	2.89 dB

3. GENERAL INFORMATION

3.1 GENERAL DESCRIPTION OF EUT

PRODUCT	Pen Tablet
MODEL NO.	WS200
FCC ID	EMJTWS200
POWER SUPPLY	3.7Vdc from battery, 5Vdc from PC
MODULATION TYPE	GFSK, $\pi/4$ -DQPSK, 8DPSK
RADIO TECHNOLOGY	FHSS
TRANSFER RATE	1/2/3Mbps
OPERATING FREQUENCY	2402 ~ 2480MHz
NUMBER OF CHANNEL	79
OUTPUT POWER	2.148mW
ANTENNA TYPE	Printed antenna with 1.03dBi gain
DATA CABLE	Shielded USB cable (1.5m)
I/O PORTS	N/A
ASSOCIATED DEVICES	Refer to note 2 as below

NOTE:

1. The EUT is a Pen Tablet, which is transceiver.
2. The EUT is the ideal tool to enhance user's presentations and documents. The pen (Model: LP-162E) will be sold together with the EUT.
3. For more detailed features description, please refer to the manufacturer's specifications or User's Manual.

3.2 DESCRIPTION OF TEST MODES

79 channels are provided to this EUT:

CHANNEL	FREQ. (MHz)	CHANNEL	FREQ. (MHz)	CHANNEL	FREQ. (MHz)	CHANNEL	FREQ. (MHz)
0	2402	20	2422	40	2442	60	2462
1	2403	21	2423	41	2443	61	2463
2	2404	22	2424	42	2444	62	2464
3	2405	23	2425	43	2445	63	2465
4	2406	24	2426	44	2446	64	2466
5	2407	25	2427	45	2447	65	2467
6	2408	26	2428	46	2448	66	2468
7	2409	27	2429	47	2449	67	2469
8	2410	28	2430	48	2450	68	2470
9	2411	29	2431	49	2451	69	2471
10	2412	30	2432	50	2452	70	2472
11	2413	31	2433	51	2453	71	2473
12	2414	32	2434	52	2454	72	2474
13	2415	33	2435	53	2455	73	2475
14	2416	34	2436	54	2456	74	2476
15	2417	35	2437	55	2457	75	2477
16	2418	36	2438	56	2458	76	2478
17	2419	37	2439	57	2459	77	2479
18	2420	38	2440	58	2460	78	2480
19	2421	39	2441	59	2461		

3.2.1 CONFIGURATION OF SYSTEM UNDER TEST

FOR MODE A (Charging + Operating Mode):

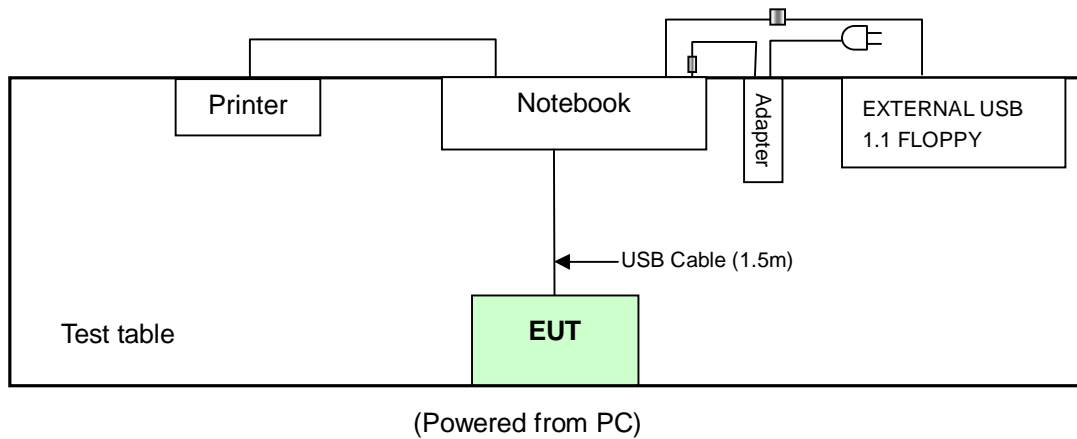

FOR MODE B (Operating Mode):

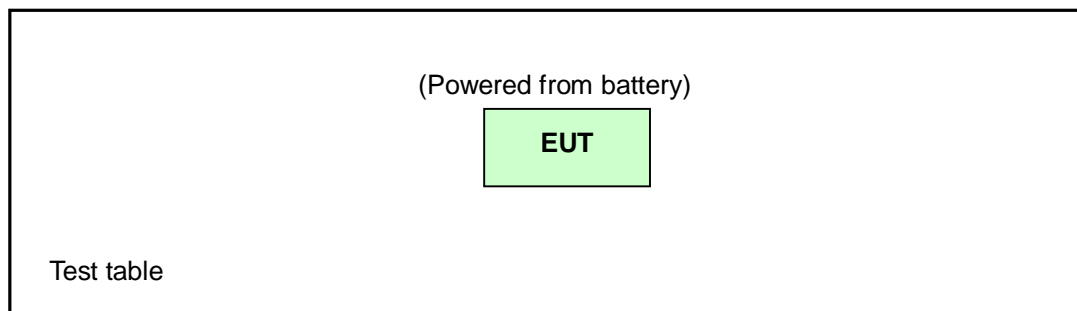

3.2.2 TEST MODE APPLICABILITY AND TESTED CHANNEL DETAIL

EUT CONFIGURE MODE	Applicable to				Description
	PLC	RE<1G	RE ^{>1G}	APCM	
A	√	√	√	√	Charging + Operating Mode (With Notebook)
B	-	√	-	-	Operating Mode (EUT only)

Where **PLC**: Power Line Conducted Emission

RE<1G: Radiated Emission below 1GHz

RE^{>1G}: Radiated Emission above 1GHz

APCM: Antenna Port Conducted Measurement

NOTE: No need to concern of Conducted Emission due to the EUT is powered by battery.

POWER LINE CONDUCTED EMISSION TEST:

- Pre-Scan has been conducted to determine the worst-case mode from all possible combinations between available modulations and packet types.
- Following channel(s) was (were) selected for the final test as listed below.

EUT CONFIGURE MODE	AVAILABLE CHANNEL	TESTED CHANNEL	MODULATION TECHNOLOGY	MODULATION TYPE	PACKET TYPE
A	0 to 78	0	FHSS	GFSK	DH5

RADIATED EMISSION TEST (BELOW 1 GHz):

- Pre-Scan has been conducted to determine the worst-case mode from all possible combinations between available modulations, data rates, packet types data rate, XYZ axis and antenna ports (if EUT with antenna diversity architecture).
- Following channel(s) was (were) selected for the final test as listed below.

EUT CONFIGURE MODE	AVAILABLE CHANNEL	TESTED CHANNEL	MODULATION TECHNOLOGY	MODULATION TYPE	PACKET TYPE	AXIS
A	0 to 78	0	FHSS	GFSK	DH5	X
B	0 to 78	0	FHSS	GFSK	DH5	X

RADIATED EMISSION TEST (ABOVE 1 GHz):

- Pre-Scan has been conducted to determine the worst-case mode from all possible combinations between available modulations, data rates, packet types data rate, XYZ axis and antenna ports (if EUT with antenna diversity architecture).
- Following channel(s) was (were) selected for the final test as listed below.

EUT CONFIGURE MODE	AVAILABLE CHANNEL	TESTED CHANNEL	MODULATION TECHNOLOGY	MODULATION TYPE	PACKET TYPE	DATE RATE	AXIS
A	0 to 78	0, 39, 78	FHSS	GFSK	DH5	1	X
A	0 to 78	0, 39, 78	FHSS	8DPSK	DH5	3	X

BANDEDGE MEASUREMENT:

- Pre-Scan has been conducted to determine the worst-case mode from all possible combinations between available modulations and packet types.
- Following channel(s) was (were) selected for the final test as listed below.

EUT CONFIGURE MODE	AVAILABLE CHANNEL	TESTED CHANNEL	MODULATION TECHNOLOGY	MODULATION TYPE	PACKET TYPE	DATE RATE
A	0 to 78	0, 78	FHSS	GFSK	DH5	1
A	0 to 78	0, 78	FHSS	8DPSK	DH5	3

ANTENNA PORT CONDUCTED MEASUREMENT:

- Pre-Scan has been conducted to determine the worst-case mode from all possible combinations between available modulations and packet types.
- Following channel(s) was (were) selected for the final test as listed below.

EUT CONFIGURE MODE	AVAILABLE CHANNEL	TESTED CHANNEL	MODULATION TECHNOLOGY	MODULATION TYPE	PACKET TYPE	DATE RATE
A	0 to 78	0, 39, 78	FHSS	GFSK	DH5	1
A	0 to 78	0, 39, 78	FHSS	8DPSK	DH5	3



3.3.3 GENERAL DESCRIPTION OF APPLIED STANDARDS

The EUT is a RF product. According to the specifications of the manufacturer, it must comply with the requirements of the following standards:

FCC Part 15, Subpart C (Section 15.247)

ANSI C63.4-2003

All test items have been performed and recorded as per the above standards.

NOTE: The product has been verified to comply with the requirements of FCC Part 15, Subpart B, Class B (DoC). The test report has been issued separately.

3.3.4 DESCRIPTION OF SUPPORT UNITS

The EUT has been tested as an independent unit together with other necessary accessories or support units. The following support units or accessories were used to form a representative test configuration during the tests.

NO.	PRODUCT	BRAND	MODEL NO.	SERIAL NO.	FCC ID
1	NOTEBOOK COMPUTER	ASUS	F3J	F3APT2YDD-FB QCCCA4266	FCC DoC Approved
2	PRINTER	LEXMARK	Z33	03331651419	FCC DoC Approved
3	EXTERNAL USB 1.1 FLOPPY	SONY	MPF82E	50042543	FCC DoC Approved

NO.	SIGNAL CABLE DESCRIPTION OF THE ABOVE SUPPORT UNITS
1	N/A
2	2.0 m foil shielded wire , terminated with USB connector via metallic frame, w/o core.
3	1.5 m shielded cable, terminated with USB connector, with 1 core.

NOTE: All power cords of the above support units are non shielded (1.8m).

4. TEST TYPES AND RESULTS

4.1 CONDUCTED EMISSION MEASUREMENT

4.1.1 LIMITS OF CONDUCTED EMISSION MEASUREMENT

FREQUENCY OF EMISSION (MHz)	CONDUCTED LIMIT (dB μ V)	
	Quasi-peak	Average
0.15 ~ 0.5	66 to 56	56 to 46
0.5 ~ 5	56	46
5 ~ 30	60	50

- NOTE:**
1. The lower limit shall apply at the transition frequencies.
 2. The limit decreases in line with the logarithm of the frequency in the range of 0.15 to 0.50 MHz.
 3. All emanations from a class A/B digital device or system, including any network of conductors and apparatus connected thereto, shall not exceed the level of field strengths specified above.

4.1.2 TEST INSTRUMENTS

DESCRIPTION & MANUFACTURER	MODEL NO.	SERIAL NO.	CALIBRATED DATE	CALIBRATED UNTIL
ROHDE & SCHWARZ Test Receiver	ESCS 30	838251/021	Mar. 05, 2009	Mar. 04, 2010
ROHDE & SCHWARZ Artificial Mains Network (for EUT)	ESH3-Z5	100218	Nov. 26, 2008	Nov. 25, 2009
LISN With Adapter (for EUT)	AD10	C10Ada-001	Nov. 26, 2008	Nov. 25, 2009
ROHDE & SCHWARZ Artificial Mains Network (for peripherals)	ESH3-Z5	100219	Nov. 20, 2008	Nov. 19, 2009
Software	ADT_Cond_V7.3.7	NA	NA	NA
Software	ADT_ISN_V7.3.7	NA	NA	NA
RF cable (JYEBAO)	5D-FB	Cable-C10.01	Feb. 26, 2009	Feb. 25, 2010
SUHNER Terminator (For ROHDE & SCHWARZ LISN)	65BNC-5001	E1-010773	Feb. 27, 2009	Feb. 26, 2010

- NOTE:**
1. The calibration interval of the above test instruments is 12 months and the calibrations are traceable to NML/ROC and NIST/USA.
 2. The test was performed in Shielded Room No. 10.
 3. The VCCI Site Registration No. C-1852.

4.1.3 TEST PROCEDURES

- a. The EUT was placed 0.4 meters from the conducting wall of the shielded room with EUT being connected to the power mains through a line impedance stabilization network (LISN). Other support units were connected to the power mains through another LISN. The two LISNs provide 50 ohm/ 50uH of coupling impedance for the measuring instrument.
- b. Both lines of the power mains connected to the EUT were checked for maximum conducted interference.
- c. The frequency range from 150kHz to 30MHz was searched. Emission levels under (Limit - 20dB) were not recorded.

4.1.4 DEVIATION FROM TEST STANDARD

No deviation

4.1.5 TEST SETUP

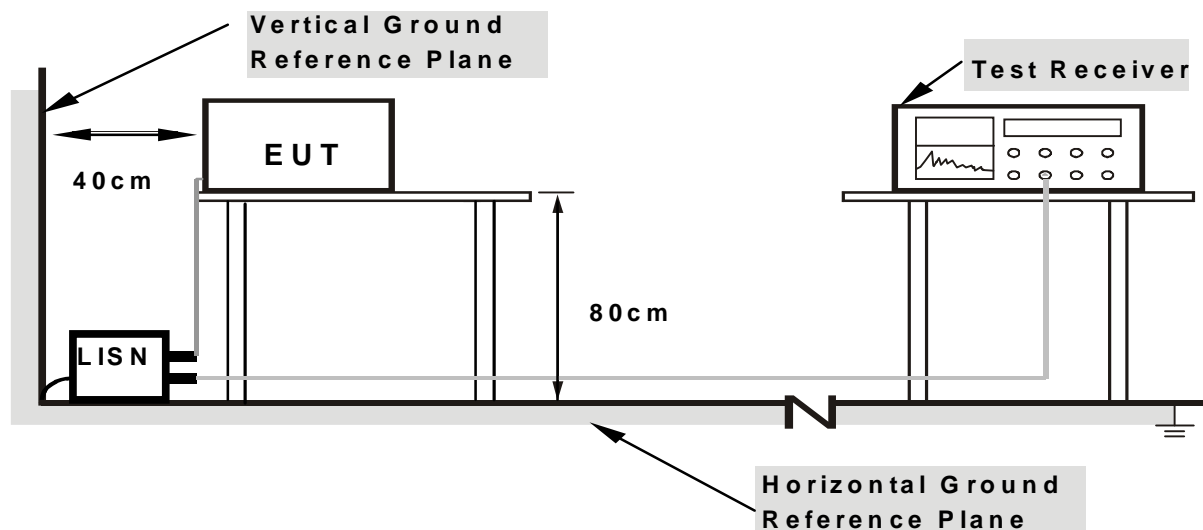

- Note:**
1. Support units were connected to second LISN.
 2. Both of LISNs (AMN) are 80 cm from EUT and at least 80 cm from other units and other metal planes support units.

For the actual test configuration, please refer to the related item – Photographs of the Test Configuration.

4.1.6 EUT OPERATING CONDITIONS

- a. Connected the EUT to Notebook via USB cable.
- b. Turned on the power of all equipment.
- c. Notebook ran a test program to enable all functions.
- d. Notebook read and wrote messages from HDD and ext. FDD.
- e. Notebook sent messages to printer and the printer printed them out.
- f. Set the EUT under transmission/receiving condition continuously at specific channel frequency and charging condition.
- g. Steps d-g were repeated.

4.1.7 TEST RESULTS

TEST MODE	A	CHANNEL	0
INPUT POWER (SYSTEM)	120Vac, 60 Hz	6dB BANDWIDTH	9 kHz
ENVIRONMENTAL CONDITIONS	25deg. C, 71% RH, 1008hPa	PHASE	Line 1
TESTED BY	Chad Lee		

No	Freq. [MHz]	Corr. Factor (dB)	Reading Value [dB (uV)]		Emission Level [dB (uV)]		Limit [dB (uV)]		Margin (dB)	
			Q.P.	AV.	Q.P.	AV.	Q.P.	AV.	Q.P.	AV.
			1	0.209	0.12	46.67	-	46.79	-	63.26
2	0.566	0.23	44.70	-	44.93	-	56.00	46.00	-11.07	-
3	0.717	0.23	38.76	-	38.99	-	56.00	46.00	-17.01	-
4	0.932	0.24	42.67	-	42.91	-	56.00	46.00	-13.09	-
5	1.418	0.26	42.86	-	43.12	-	56.00	46.00	-12.88	-
6	2.633	0.31	36.31	-	36.62	-	56.00	46.00	-19.38	-

- REMARKS:**
1. Q.P. and AV. are abbreviations of quasi-peak and average individually.
 2. "-": The Quasi-peak reading value also meets average limit and measurement with the average detector is unnecessary.
 3. The emission levels of other frequencies were very low against the limit.
 4. Margin value = Emission level - Limit value
 5. Correction factor = Insertion loss + Cable loss
 6. Emission Level = Correction Factor + Reading Value.

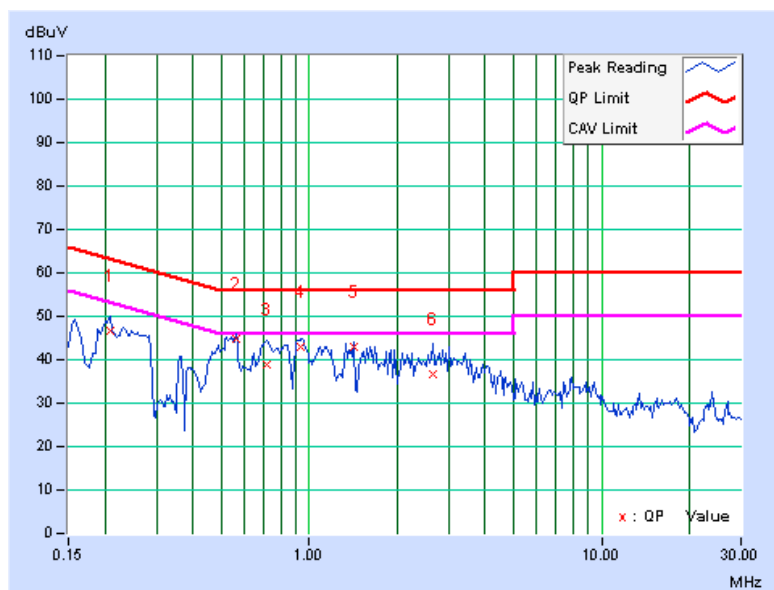



A D T

TEST MODE	A	CHANNEL	0
INPUT POWER (SYSTEM)	120Vac, 60 Hz	6dB BANDWIDTH	9 kHz
ENVIRONMENTAL CONDITIONS	25deg. C, 71% RH, 1008hPa	PHASE	Line 2
TESTED BY	Chad Lee		

No	Freq. [MHz]	Corr. Factor (dB)	Reading Value [dB (uV)]		Emission Level [dB (uV)]		Limit [dB (uV)]		Margin (dB)	
			Q.P.	AV.	Q.P.	AV.	Q.P.	AV.	Q.P.	AV.
			1	0.205	0.09	47.35	-	47.44	-	63.42
2	0.490	0.20	40.75	-	40.95	-	56.17	46.17	-15.22	-
3	0.568	0.21	45.64	-	45.85	-	56.00	46.00	-10.15	-
4	0.728	0.21	41.65	-	41.86	-	56.00	46.00	-14.14	-
5	1.129	0.22	39.18	-	39.40	-	56.00	46.00	-16.60	-
6	1.375	0.23	41.41	-	41.64	-	56.00	46.00	-14.36	-

- REMARKS:**
1. Q.P. and AV. are abbreviations of quasi-peak and average individually.
 2. "-": The Quasi-peak reading value also meets average limit and measurement with the average detector is unnecessary.
 3. The emission levels of other frequencies were very low against the limit.
 4. Margin value = Emission level - Limit value
 5. Correction factor = Insertion loss + Cable loss
 6. Emission Level = Correction Factor + Reading Value.

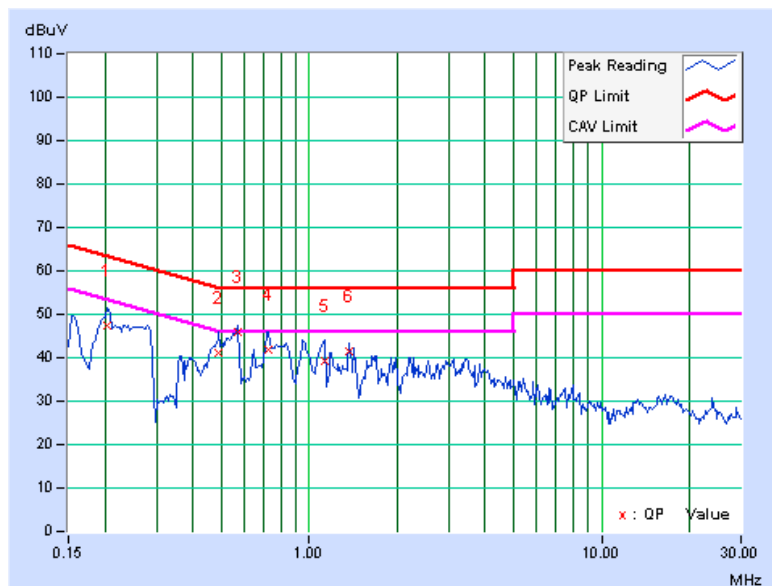

4.2 RADIATED EMISSION MEASUREMENT

4.2.1 LIMITS OF RADIATED EMISSION MEASUREMENT

Emissions radiated outside of the specified bands, shall be according to the general radiated limits in 15.209 as following:

FREQUENCIES (MHz)	FIELD STRENGTH (microvolts/meter)	MEASUREMENT DISTANCE (meters)
0.009 ~ 0.490	2400/F(kHz)	300
0.490 ~ 1.705	24000/F(kHz)	30
1.705 ~ 30.0	30	30
30 ~ 88	100	3
88 ~ 216	150	3
216 ~ 960	200	3
Above 960	500	3

NOTE:

1. The lower limit shall apply at the transition frequencies.
2. Emission level (dBuV/m) = 20 log Emission level (uV/m).
3. As shown in 15.35(b), for frequencies above 1000MHz, the field strength limits are based on average detector, however, the peak field strength of any emission shall not exceed the maximum permitted average limits, specified above by more than 20dB under any condition of modulation.

4.2.2 TEST INSTRUMENTS

DESCRIPTION & MANUFACTURER	MODEL NO.	SERIAL NO.	CALIBRATED DATE	CALIBRATED UNTIL
HP Preamplifier	8447D	2432A03504	May 04, 2009	May 03, 2010
HP Preamplifier	8449B	3008A01924	Sep. 03, 2008	Sep. 02, 2009
HP Preamplifier	8449B	3008A01292	Aug. 10, 2009	Aug. 09, 2010
ROHDE & SCHWARZ TEST RECEIVER	ESI7	836697/012	Dec. 04, 2008	Dec. 03, 2009
Schwarzbeck Antenna	VULB 9168	137	Apr. 29, 2009	Apr. 28, 2010
Schwarzbeck Antenna	VHBA 9123	480	Apr. 21, 2009	Apr. 20, 2010
EMCO Horn Antenna	3115	6714	Oct. 17, 2008	Oct. 16, 2009
EMCO Horn Antenna	3115	9312-4192	Apr. 17, 2009	Apr. 16, 2010
ADT. Turn Table	TT100	0306	NA	NA
ADT. Tower	AT100	0306	NA	NA
Software	ADT_Radiated_V 7.6.15.9.2	NA	NA	NA
SUHNER RF cable	SF104-26.5	CABLE-CH6-17m -01	Aug. 20, 2009	Aug. 19, 2010
ROHDE & SCHWARZ Spectrum Analyzer	FSP 40	100036	Apr. 03, 2009	Apr. 02, 2010

- NOTE:**
1. The calibration interval of the above test instruments is 12 months. And the calibrations are traceable to NML/ROC and NIST/USA.
 2. The horn antenna and HP preamplifier (model: 8449B) are used only for the measurement of emission frequency above 1GHz if tested.
 3. The test was performed in Chamber No. 6.
 4. The Industry Canada Reference No. IC 7450E-6.
 5. The FCC Site Registration No. is 447212.

4.2.3 TEST PROCEDURES

- a. The EUT was placed on the top of a rotating table 0.8 meters above the ground at a 3 meter semi-anechoic chamber room. The table was rotated 360 degrees to determine the position of the highest radiation.
- b. The EUT was set 3 meters away from the interference-receiving antenna, which was mounted on the top of a variable-height antenna tower.
- c. The height of antenna is varied from one meter to four meters above the ground to determine the maximum value of the field strength. Both horizontal and vertical polarizations of the antenna are set to make the measurement.
- d. For each suspected emission, the EUT was arranged to its worst case and then the antenna was tuned to heights from 1 meter to 4 meters and the rotatable table was turned from 0 degrees to 360 degrees to find the maximum reading.
- e. The test-receiver system was set to quasi-peak detect function and specified bandwidth with maximum hold mode when the test frequency is below 1 GHz.
- f. If the emission level of the EUT in peak mode was lower than the limit specified, then testing could be stopped and the peak values of the EUT would be reported. Otherwise the emissions would be re-tested one by one using peak, quasi-peak or average method as specified and then reported in a data sheet.

NOTE:

1. The resolution bandwidth of test receiver/spectrum analyzer is 120kHz for Quasi-peak detection at frequency below 1GHz.
2. The resolution bandwidth is 1MHz and video bandwidth of test receiver/spectrum analyzer is 3MHz for Peak detection at frequency above 1GHz. The resolution bandwidth of test receiver/spectrum analyzer is 1 MHz for Average detection (AV) at frequency above 1GHz.

4.2.4 DEVIATION FROM TEST STANDARD

No deviation

4.2.5 TEST SETUP

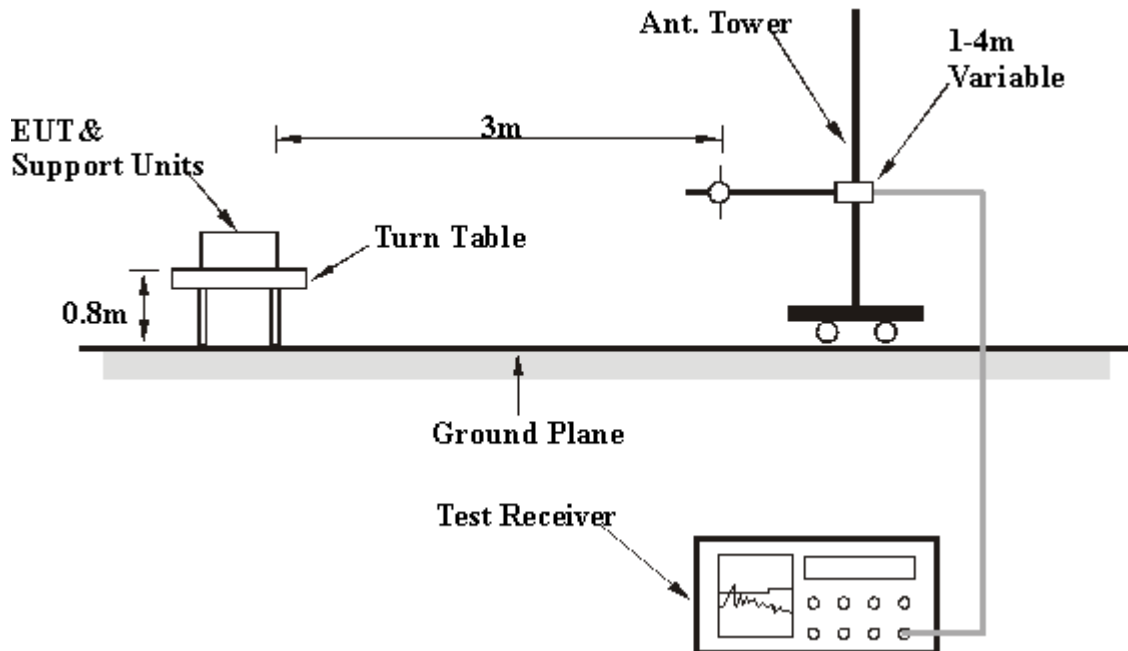

For the actual test configuration, please refer to the related item – Photographs of the Test Configuration.

4.2.6 EUT OPERATING CONDITIONS

Mode A

- Connected the EUT to Notebook via USB cable.
- Turned on the power of all equipment.
- Notebook ran a test program to enable all functions.
- Notebook read and wrote messages from HDD and ext. FDD.
- Notebook sent messages to printer and the printer printed them out.
- Set the EUT under transmission/receiving condition continuously at specific channel frequency and charging condition.
- Steps d-g were repeated.

Mode B

Set the EUT under transmission/receiving condition continuously at specific channel frequency.

4.2.7 TEST RESULTS

GFSK MODULATION

EUT TEST CONDITION		MEASUREMENT DETAIL	
CHANNEL	Channel 0	FREQUENCY RANGE	1 ~ 25GHz
INPUT POWER (SYSTEM)	120Vac, 60 Hz	DETECTOR FUNCTION	Peak (PK) Average (AV)
ENVIRONMENTAL CONDITIONS	25deg. C, 75%RH 1003 hPa	TESTED BY	Nick Chen
TEST MODE	A		

ANTENNA POLARITY & TEST DISTANCE: HORIZONTAL AT 3 M								
NO.	FREQ. (MHz)	EMISSION LEVEL (dBuV/m)	LIMIT (dBuV/m)	MARGIN (dB)	ANTENNA HEIGHT (m)	TABLE ANGLE (Degree)	RAW VALUE (dBuV)	CORRECTION FACTOR (dB/m)
1	1602.00	49.19 PK	74.00	-24.81	1.06 H	103	17.27	31.92
2	1602.00	45.89 AV	54.00	-8.11	1.06 H	103	13.97	31.92
3	2390.00	62.51 PK	74.00	-11.49	1.06 H	107	27.44	35.07
4	2390.00	48.65 AV	54.00	-5.35	1.06 H	107	13.58	35.07
5	#2400.00	68.22 PK	87.15	-18.93	1.06 H	107	33.13	35.09
6	#2400.00	38.12 AV	57.05	-18.93	1.06 H	107	3.03	35.09
7	*2402.00	107.15 PK			1.06 H	107	72.06	35.09
8	*2402.00	77.05 AV			1.06 H	107	41.96	35.09
9	4804.00	60.01 PK	74.00	-13.99	1.24 H	156	17.02	42.99
10	4804.00	29.91 AV	54.00	-24.09	1.24 H	156	-13.08	42.99

- REMARKS:**
1. Emission level (dBuV/m) = Raw Value (dBuV) + Correction Factor (dB/m).
 2. Correction Factor (dB/m) = Antenna Factor (dB/m) + Cable Factor (dB).
 3. The other emission levels were very low against the limit.
 4. Margin value = Emission level – Limit value.
 5. “ * “: Fundamental frequency.
 6. The DH5 packet was the worse case duty cycle for a transmit dwell time on a channel, based upon bluetooth theory the transmitter is on 0.625 * 5 per 296.25 ms per channel. Therefore, the duty cycle correlation factor be equal to: $20\log(3.125 / 100) = -30.1$ dB.
 7. Average value = peak reading + $20\log(\text{duty cycle})$.
 8. "#": The radiated frequency is out the restricted band.



A D T

EUT TEST CONDITION		MEASUREMENT DETAIL	
CHANNEL	Channel 0	FREQUENCY RANGE	1 ~ 25GHz
INPUT POWER (SYSTEM)	120Vac, 60 Hz	DETECTOR FUNCTION	Peak (PK) Average (AV)
ENVIRONMENTAL CONDITIONS	25deg. C, 75%RH 1003 hPa	TESTED BY	Nick Chen
TEST MODE	A		

ANTENNA POLARITY & TEST DISTANCE: VERTICAL AT 3 M								
NO.	FREQ. (MHz)	EMISSION LEVEL (dBuV/m)	LIMIT (dBuV/m)	MARGIN (dB)	ANTENNA HEIGHT (m)	TABLE ANGLE (Degree)	RAW VALUE (dBuV)	CORRECTION FACTOR (dB/m)
1	1602.00	45.08 PK	74.00	-28.92	1.08 V	185	13.16	31.92
2	1602.00	38.73 AV	54.00	-15.27	1.08 V	185	6.81	31.92
3	2390.00	58.72 PK	74.00	-15.28	1.07 V	63	23.65	35.07
4	2390.00	47.01 AV	54.00	-6.99	1.07 V	63	11.94	35.07
5	#2400.00	63.35 PK	82.28	-18.93	1.07 V	63	28.26	35.09
6	#2400.00	33.25 AV	52.18	-18.93	1.07 V	63	-1.84	35.09
7	*2402.00	102.28 PK			1.07 V	63	67.19	35.09
8	*2402.00	72.18 AV			1.07 V	63	37.09	35.09
9	4804.00	62.48 PK	74.00	-11.52	1.00 V	353	19.49	42.99
10	4804.00	32.38 AV	54.00	-21.62	1.00 V	353	-10.61	42.99

- REMARKS:**
- Emission level (dBuV/m) = Raw Value (dBuV) + Correction Factor (dB/m).
 - Correction Factor (dB/m) = Antenna Factor (dB/m) + Cable Factor (dB).
 - The other emission levels were very low against the limit.
 - Margin value = Emission level – Limit value.
 - " * ": Fundamental frequency.
 - The DH5 packet was the worse case duty cycle for a transmit dwell time on a channel, based upon bluetooth theory the transmitter is on 0.625 * 5 per 296.25 ms per channel. Therefore, the duty cycle correlation factor be equal to: $20\log(3.125 / 100) = -30.1$ dB.
 - Average value = peak reading + $20\log(\text{duty cycle})$.
 - "#": The radiated frequency is out the restricted band.



A D T

EUT TEST CONDITION		MEASUREMENT DETAIL	
CHANNEL	Channel 39	FREQUENCY RANGE	1 ~ 25GHz
INPUT POWER (SYSTEM)	120Vac, 60 Hz	DETECTOR FUNCTION	Peak (PK) Average (AV)
ENVIRONMENTAL CONDITIONS	25deg. C, 75%RH 1003 hPa	TESTED BY	Nick Chen
TEST MODE	A		

ANTENNA POLARITY & TEST DISTANCE: HORIZONTAL AT 3 M								
NO.	FREQ. (MHz)	EMISSION LEVEL (dBuV/m)	LIMIT (dBuV/m)	MARGIN (dB)	ANTENNA HEIGHT (m)	TABLE ANGLE (Degree)	RAW VALUE (dBuV)	CORRECTION FACTOR (dB/m)
1	#1628.00	49.06 PK	87.83	-38.77	1.00 H	284	17.02	32.04
2	#1628.00	45.44 AV	57.73	-12.29	1.00 H	284	13.40	32.04
3	*2441.00	107.83 PK			1.06 H	288	72.66	35.17
4	*2441.00	77.73 AV			1.06 H	288	42.56	35.17
5	4882.00	59.89 PK	74.00	-14.11	1.25 H	112	16.75	43.14
6	4882.00	29.79 AV	54.00	-24.21	1.25 H	112	-13.35	43.14
ANTENNA POLARITY & TEST DISTANCE: VERTICAL AT 3 M								
NO.	FREQ. (MHz)	EMISSION LEVEL (dBuV/m)	LIMIT (dBuV/m)	MARGIN (dB)	ANTENNA HEIGHT (m)	TABLE ANGLE (Degree)	RAW VALUE (dBuV)	CORRECTION FACTOR (dB/m)
1	#1628.00	45.41 PK	83.38	-37.97	1.02 V	14	13.37	32.04
2	#1628.00	38.51 AV	53.28	-14.77	1.02 V	14	6.47	32.04
3	*2441.00	103.38 PK			1.00 V	261	68.21	35.17
4	*2441.00	73.28 AV			1.00 V	261	38.11	35.17
5	4882.00	65.09 PK	74.00	-8.91	1.00 V	193	21.95	43.14
6	4882.00	34.99 AV	54.00	-19.01	1.00 V	193	-8.15	43.14

- REMARKS:**
1. Emission level (dBuV/m) = Raw Value (dBuV) + Correction Factor (dB/m).
 2. Correction Factor (dB/m) = Antenna Factor (dB/m) + Cable Factor (dB).
 3. The other emission levels were very low against the limit.
 4. Margin value = Emission level – Limit value.
 5. “ * “: Fundamental frequency.
 6. The DH5 packet was the worse case duty cycle for a transmit dwell time on a channel, based upon bluetooth theory the transmitter is on 0.625 * 5 per 296.25 ms per channel. Therefore, the duty cycle correlation factor be equal to: $20\log(3.125 / 100) = -30.1$ dB.
 7. Average value = peak reading + $20\log(\text{duty cycle})$.
 8. "#":The radiated frequency is out the restricted band.



A D T

EUT TEST CONDITION		MEASUREMENT DETAIL	
CHANNEL	Channel 78	FREQUENCY RANGE	1 ~ 25GHz
INPUT POWER (SYSTEM)	120Vac, 60 Hz	DETECTOR FUNCTION	Peak (PK) Average (AV)
ENVIRONMENTAL CONDITIONS	25deg. C, 75%RH 1003 hPa	TESTED BY	Nick Chen
TEST MODE	A		

ANTENNA POLARITY & TEST DISTANCE: HORIZONTAL AT 3 M								
NO.	FREQ. (MHz)	EMISSION LEVEL (dBuV/m)	LIMIT (dBuV/m)	MARGIN (dB)	ANTENNA HEIGHT (m)	TABLE ANGLE (Degree)	RAW VALUE (dBuV)	CORRECTION FACTOR (dB/m)
1	#1654.00	49.53 PK	85.03	-35.50	1.00 H	286	17.37	32.16
2	#1654.00	45.73 AV	54.93	-9.20	1.00 H	286	13.57	32.16
3	*2480.00	105.03 PK			1.03 H	284	69.78	35.25
4	*2480.00	74.93 AV			1.03 H	284	39.68	35.25
5	2483.50	61.43 PK	74.00	-12.57	1.03 H	284	26.17	35.26
6	2483.50	31.33 AV	54.00	-22.67	1.03 H	284	-3.93	35.26
7	4960.00	55.90 PK	74.00	-18.10	1.00 H	210	12.60	43.30
8	4960.00	25.80 AV	54.00	-28.20	1.00 H	210	-17.50	43.30
ANTENNA POLARITY & TEST DISTANCE: VERTICAL AT 3 M								
NO.	FREQ. (MHz)	EMISSION LEVEL (dBuV/m)	LIMIT (dBuV/m)	MARGIN (dB)	ANTENNA HEIGHT (m)	TABLE ANGLE (Degree)	RAW VALUE (dBuV)	CORRECTION FACTOR (dB/m)
1	#1654.00	45.33 PK	82.13	-36.80	1.00 V	7	13.17	32.16
2	#1654.00	39.05 AV	52.03	-12.98	1.00 V	7	6.89	32.16
3	*2480.00	102.13 PK			1.00 V	256	66.88	35.25
4	*2480.00	72.03 AV			1.00 V	256	36.78	35.25
5	2483.50	58.53 PK	74.00	-15.47	1.00 V	256	23.27	35.26
6	2483.50	28.43 AV	54.00	-25.57	1.00 V	256	-6.83	35.26
7	4960.00	61.79 PK	74.00	-12.21	1.00 V	179	18.49	43.30
8	4960.00	31.69 AV	54.00	-22.31	1.00 V	179	-11.61	43.30

- REMARKS:**
1. Emission level (dBuV/m) = Raw Value (dBuV) + Correction Factor (dB/m).
 2. Correction Factor (dB/m) = Antenna Factor (dB/m) + Cable Factor (dB).
 3. The other emission levels were very low against the limit.
 4. Margin value = Emission level – Limit value.
 5. “ * “: Fundamental frequency.
 6. The DH5 packet was the worse case duty cycle for a transmit dwell time on a channel, based upon bluetooth theory the transmitter is on 0.625 * 5 per 296.25 ms per channel. Therefore, the duty cycle correlation factor be equal to: $20\log(3.125 / 100) = -30.1$ dB.
 7. Average value = peak reading + $20\log(\text{duty cycle})$.
 8. "#": The radiated frequency is out the restricted band.



8DPSK MODULATION

EUT TEST CONDITION		MEASUREMENT DETAIL	
CHANNEL	Channel 0	FREQUENCY RANGE	1 ~ 25GHz
INPUT POWER (SYSTEM)	120Vac, 60 Hz	DETECTOR FUNCTION	Peak (PK) Average (AV)
ENVIRONMENTAL CONDITIONS	25deg. C, 75%RH 1008 hPa	TESTED BY	Chad Lee
TEST MODE	A		

ANTENNA POLARITY & TEST DISTANCE: HORIZONTAL AT 3 M								
NO.	FREQ. (MHz)	EMISSION LEVEL (dBuV/m)	LIMIT (dBuV/m)	MARGIN (dB)	ANTENNA HEIGHT (m)	TABLE ANGLE (Degree)	RAW VALUE (dBuV)	CORRECTION FACTOR (dB/m)
1	1602.00	47.32 PK	74.00	-26.68	1.00 H	129	15.40	31.92
2	1602.00	44.64 AV	54.00	-9.36	1.00 H	129	12.72	31.92
3	2390.00	58.61 PK	74.00	-15.39	1.00 H	6	23.54	35.07
4	2390.00	47.03 AV	54.00	-6.97	1.00 H	6	11.96	35.07
5	#2400.00	52.28 PK	81.51	-29.23	1.00 H	6	17.19	35.09
6	#2400.00	22.18 AV	51.41	-29.23	1.00 H	6	-12.91	35.09
7	*2402.00	101.51 PK			1.00 H	6	66.42	35.09
8	*2402.00	71.41 AV			1.00 H	6	36.32	35.09
9	4804.00	51.65 PK	74.00	-22.35	1.00 H	6	8.66	42.99
10	4804.00	21.55 AV	54.00	-32.45	1.00 H	6	-21.44	42.99

- REMARKS:**
1. Emission level (dBuV/m) = Raw Value (dBuV) + Correction Factor (dB/m).
 2. Correction Factor (dB/m) = Antenna Factor (dB/m) + Cable Factor (dB).
 3. The other emission levels were very low against the limit.
 4. Margin value = Emission level – Limit value.
 5. “ * “: Fundamental frequency.
 6. The DH5 packet was the worse case duty cycle for a transmit dwell time on a channel, based upon bluetooth theory the transmitter is on 0.625 * 5 per 296.25 ms per channel. Therefore, the duty cycle correlation factor be equal to: $20\log(3.125 / 100) = -30.1$ dB.
 7. Average value = peak reading + $20\log(\text{duty cycle})$.
 8. "#":The radiated frequency is out the restricted band.



A D T

EUT TEST CONDITION		MEASUREMENT DETAIL	
CHANNEL	Channel 0	FREQUENCY RANGE	1 ~ 25GHz
INPUT POWER (SYSTEM)	120Vac, 60 Hz	DETECTOR FUNCTION	Peak (PK) Average (AV)
ENVIRONMENTAL CONDITIONS	25deg. C, 75%RH 1008 hPa	TESTED BY	Chad Lee
TEST MODE	A		

ANTENNA POLARITY & TEST DISTANCE: VERTICAL AT 3 M								
NO.	FREQ. (MHz)	EMISSION LEVEL (dBuV/m)	LIMIT (dBuV/m)	MARGIN (dB)	ANTENNA HEIGHT (m)	TABLE ANGLE (Degree)	RAW VALUE (dBuV)	CORRECTION FACTOR (dB/m)
1	1602.00	43.92 PK	74.00	-30.08	1.00 V	132	12.00	31.92
2	1602.00	36.30 AV	54.00	-17.70	1.00 V	132	4.38	31.92
3	2390.00	58.66 PK	74.00	-15.34	1.10 V	80	23.59	35.07
4	2390.00	46.55 AV	54.00	-7.45	1.10 V	80	11.48	35.07
5	#2400.00	49.75 PK	78.98	-29.23	1.10 V	80	14.66	35.09
6	#2400.00	19.65 AV	48.88	-29.23	1.10 V	80	-15.44	35.09
7	*2402.00	98.98 PK			1.10 V	80	63.89	35.09
8	*2402.00	68.88 AV			1.10 V	80	33.79	35.09
9	4804.00	51.72 PK	74.00	-22.28	1.00 V	16	8.73	42.99
10	4804.00	21.62 AV	54.00	-32.38	1.00 V	16	-21.37	42.99

- REMARKS:**
1. Emission level (dBuV/m) = Raw Value (dBuV) + Correction Factor (dB/m).
 2. Correction Factor (dB/m) = Antenna Factor (dB/m) + Cable Factor (dB).
 3. The other emission levels were very low against the limit.
 4. Margin value = Emission level – Limit value.
 5. “ * “: Fundamental frequency.
 6. The DH5 packet was the worse case duty cycle for a transmit dwell time on a channel, based upon bluetooth theory the transmitter is on 0.625 * 5 per 296.25 ms per channel. Therefore, the duty cycle correlation factor be equal to: $20\log(3.125 / 100) = -30.1$ dB.
 7. Average value = peak reading + $20\log(\text{duty cycle})$.
 8. "#":The radiated frequency is out the restricted band.



A D T

EUT TEST CONDITION		MEASUREMENT DETAIL	
CHANNEL	Channel 39	FREQUENCY RANGE	1 ~ 25GHz
INPUT POWER (SYSTEM)	120Vac, 60 Hz	DETECTOR FUNCTION	Peak (PK) Average (AV)
ENVIRONMENTAL CONDITIONS	25deg. C, 75%RH 1008 hPa	TESTED BY	Chad Lee
TEST MODE	A		

ANTENNA POLARITY & TEST DISTANCE: HORIZONTAL AT 3 M								
NO.	FREQ. (MHz)	EMISSION LEVEL (dBuV/m)	LIMIT (dBuV/m)	MARGIN (dB)	ANTENNA HEIGHT (m)	TABLE ANGLE (Degree)	RAW VALUE (dBuV)	CORRECTION FACTOR (dB/m)
1	#1628.00	48.52 PK	80.55	-32.03	1.00 H	124	16.48	32.04
2	#1628.00	44.94 AV	50.45	-5.51	1.00 H	124	12.90	32.04
3	*2441.00	100.55 PK			1.00 H	1	65.38	35.17
4	*2441.00	70.45 AV			1.00 H	1	35.28	35.17
5	4882.00	52.60 PK	74.00	-21.40	1.00 H	69	9.46	43.14
6	4882.00	22.50 AV	54.00	-31.50	1.00 H	69	-20.64	43.14
ANTENNA POLARITY & TEST DISTANCE: VERTICAL AT 3 M								
NO.	FREQ. (MHz)	EMISSION LEVEL (dBuV/m)	LIMIT (dBuV/m)	MARGIN (dB)	ANTENNA HEIGHT (m)	TABLE ANGLE (Degree)	RAW VALUE (dBuV)	CORRECTION FACTOR (dB/m)
1	#1628.00	45.06 PK	79.07	-34.01	1.00 V	235	13.02	32.04
2	#1628.00	38.64 AV	48.97	-10.33	1.00 V	235	6.60	32.04
3	*2441.00	99.07 PK			1.02 V	88	63.90	35.17
4	*2441.00	68.97 AV			1.02 V	88	33.80	35.17
5	4882.00	56.37 PK	74.00	-17.63	1.00 V	10	13.23	43.14
6	4882.00	26.27 AV	54.00	-27.73	1.00 V	10	-16.87	43.14

- REMARKS:**
1. Emission level (dBuV/m) = Raw Value (dBuV) + Correction Factor (dB/m).
 2. Correction Factor (dB/m) = Antenna Factor (dB/m) + Cable Factor (dB).
 3. The other emission levels were very low against the limit.
 4. Margin value = Emission level – Limit value.
 5. “ * “: Fundamental frequency.
 6. The DH5 packet was the worse case duty cycle for a transmit dwell time on a channel, based upon bluetooth theory the transmitter is on 0.625 * 5 per 296.25 ms per channel. Therefore, the duty cycle correlation factor be equal to: $20\log(3.125 / 100) = -30.1$ dB.
 7. Average value = peak reading + $20\log(\text{duty cycle})$.
 8. "#":The radiated frequency is out the restricted band.



A D T

EUT TEST CONDITION		MEASUREMENT DETAIL	
CHANNEL	Channel 78	FREQUENCY RANGE	1 ~ 25GHz
INPUT POWER (SYSTEM)	120Vac, 60 Hz	DETECTOR FUNCTION	Peak (PK) Average (AV)
ENVIRONMENTAL CONDITIONS	25deg. C, 75%RH 1008 hPa	TESTED BY	Chad Lee
TEST MODE	A		

ANTENNA POLARITY & TEST DISTANCE: HORIZONTAL AT 3 M								
NO.	FREQ. (MHz)	EMISSION LEVEL (dBuV/m)	LIMIT (dBuV/m)	MARGIN (dB)	ANTENNA HEIGHT (m)	TABLE ANGLE (Degree)	RAW VALUE (dBuV)	CORRECTION FACTOR (dB/m)
1	#1654.00	48.50 PK	77.96	-29.46	1.00 H	108	16.34	32.16
2	#1654.00	44.63 AV	47.86	-3.23	1.00 H	108	12.47	32.16
3	*2480.00	97.96 PK			1.08 H	110	62.71	35.25
4	*2480.00	67.86 AV			1.08 H	110	32.61	35.25
5	2483.50	52.70 PK	74.00	-21.30	1.08 H	110	17.44	35.26
6	2483.50	22.60 AV	54.00	-31.40	1.08 H	110	-12.66	35.26
7	4960.00	54.95 PK	74.00	-19.05	1.00 H	67	11.65	43.30
8	4960.00	24.85 AV	54.00	-29.15	1.00 H	67	-18.45	43.30
ANTENNA POLARITY & TEST DISTANCE: VERTICAL AT 3 M								
NO.	FREQ. (MHz)	EMISSION LEVEL (dBuV/m)	LIMIT (dBuV/m)	MARGIN (dB)	ANTENNA HEIGHT (m)	TABLE ANGLE (Degree)	RAW VALUE (dBuV)	CORRECTION FACTOR (dB/m)
1	#1654.00	44.24 PK	75.85	-31.61	1.00 V	6	12.08	32.16
2	#1654.00	35.97 AV	45.75	-9.78	1.00 V	6	3.81	32.16
3	*2480.00	95.85 PK			1.00 V	51	60.60	35.25
4	*2480.00	65.75 AV			1.00 V	51	30.50	35.25
5	2483.50	50.59 PK	74.00	-23.41	1.00 V	51	15.33	35.26
6	2483.50	20.49 AV	54.00	-33.51	1.00 V	51	-14.77	35.26
7	4960.00	54.30 PK	74.00	-19.70	1.00 V	352	11.00	43.30
8	4960.00	24.20 AV	54.00	-29.80	1.00 V	352	-19.10	43.30

- REMARKS:**
1. Emission level (dBuV/m) = Raw Value (dBuV) + Correction Factor (dB/m).
 2. Correction Factor (dB/m) = Antenna Factor (dB/m) + Cable Factor (dB).
 3. The other emission levels were very low against the limit.
 4. Margin value = Emission level – Limit value.
 5. “ * “: Fundamental frequency.
 6. The DH5 packet was the worse case duty cycle for a transmit dwell time on a channel, based upon bluetooth theory the transmitter is on 0.625 * 5 per 296.25 ms per channel. Therefore, the duty cycle correlation factor be equal to: $20\log(3.125 / 100) = -30.1$ dB.
 7. Average value = peak reading + $20\log(\text{duty cycle})$.
 8. "#":The radiated frequency is out the restricted band.



A D T

BELOW 1GHz WORST-CASE DATA : GFSK MODULATION

EUT TEST CONDITION		MEASUREMENT DETAIL	
CHANNEL	Channel 0	FREQUENCY RANGE	Below 1000MHz
INPUT POWER (SYSTEM)	120Vac, 60 Hz	DETECTOR FUNCTION	Quasi-Peak
ENVIRONMENTAL CONDITIONS	26deg. C, 74%RH 1002 hPa	TESTED BY	Nick Chen
TEST MODE	A		

ANTENNA POLARITY & TEST DISTANCE: HORIZONTAL AT 3 M								
NO.	FREQ. (MHz)	EMISSION LEVEL (dBuV/m)	LIMIT (dBuV/m)	MARGIN (dB)	ANTENNA HEIGHT (m)	TABLE ANGLE (Degree)	RAW VALUE (dBuV)	CORRECTION FACTOR (dB/m)
1	475.15	31.90 QP	46.00	-14.10	1.27 H	262	11.54	20.36
2	500.42	32.33 QP	46.00	-13.67	1.03 H	205	11.24	21.09
3	564.57	37.13 QP	46.00	-8.87	1.59 H	37	14.62	22.51
4	702.59	37.33 QP	46.00	-8.67	1.68 H	91	12.47	24.86
5	764.79	37.82 QP	46.00	-8.18	1.42 H	106	11.78	26.04
6	834.77	36.35 QP	46.00	-9.65	1.10 H	91	9.19	27.16
ANTENNA POLARITY & TEST DISTANCE: VERTICAL AT 3 M								
NO.	FREQ. (MHz)	EMISSION LEVEL (dBuV/m)	LIMIT (dBuV/m)	MARGIN (dB)	ANTENNA HEIGHT (m)	TABLE ANGLE (Degree)	RAW VALUE (dBuV)	CORRECTION FACTOR (dB/m)
1	568.46	30.72 QP	46.00	-15.28	1.09 V	85	8.13	22.59
2	735.63	31.63 QP	46.00	-14.37	1.28 V	52	6.12	25.51
3	764.79	33.31 QP	46.00	-12.69	1.02 V	55	7.27	26.04
4	801.72	30.69 QP	46.00	-15.31	1.36 V	253	4.05	26.64
5	834.77	36.16 QP	46.00	-9.84	1.25 V	139	9.00	27.16
6	863.93	33.09 QP	46.00	-12.91	1.00 V	13	5.51	27.58

- REMARKS:**
1. Emission level (dBuV/m) = Raw Value (dBuV) + Correction Factor (dB/m).
 2. Correction Factor (dB/m) = Antenna Factor (dB/m) + Cable Factor (dB).
 3. The other emission levels were very low against the limit.
 4. Margin value = Emission level – Limit value.



A D T

EUT TEST CONDITION		MEASUREMENT DETAIL	
CHANNEL	Channel 0	FREQUENCY RANGE	Below 1000MHz
INPUT POWER	3.7Vdc	DETECTOR FUNCTION	Quasi-Peak
ENVIRONMENTAL CONDITIONS	25deg. C, 75%RH 1003 hPa	TESTED BY	Nick Chen
TEST MODE	B		

ANTENNA POLARITY & TEST DISTANCE: HORIZONTAL AT 3 M								
NO.	FREQ. (MHz)	EMISSION LEVEL (dBuV/m)	LIMIT (dBuV/m)	MARGIN (dB)	ANTENNA HEIGHT (m)	TABLE ANGLE (Degree)	RAW VALUE (dBuV)	CORRECTION FACTOR (dB/m)
1	38.33	30.85 QP	40.00	-9.15	1.32 H	124	17.84	13.01
2	79.92	27.63 QP	40.00	-12.37	1.24 H	115	17.86	9.77
3	838.66	25.85 QP	46.00	-20.15	1.27 H	241	-1.37	27.22
4	870.32	26.39 QP	46.00	-19.61	1.22 H	74	-1.27	27.66
5	900.84	27.25 QP	46.00	-18.75	1.08 H	36	-0.80	28.05
6	927.63	28.36 QP	46.00	-17.64	1.12 H	85	0.02	28.34
ANTENNA POLARITY & TEST DISTANCE: VERTICAL AT 3 M								
NO.	FREQ. (MHz)	EMISSION LEVEL (dBuV/m)	LIMIT (dBuV/m)	MARGIN (dB)	ANTENNA HEIGHT (m)	TABLE ANGLE (Degree)	RAW VALUE (dBuV)	CORRECTION FACTOR (dB/m)
1	39.72	31.28 QP	40.00	-8.72	1.12 V	19	17.98	13.30
2	80.54	26.59 QP	40.00	-13.41	1.01 V	292	16.93	9.66
3	838.66	24.64 QP	46.00	-21.36	1.21 V	58	-2.58	27.22
4	871.70	25.68 QP	46.00	-20.32	1.13 V	196	-2.00	27.68
5	900.86	26.30 QP	46.00	-19.70	1.22 V	79	-1.75	28.05
6	928.08	27.00 QP	46.00	-19.00	1.28 V	217	-1.35	28.35

- REMARKS:**
1. Emission level (dBuV/m) = Raw Value (dBuV) + Correction Factor (dB/m).
 2. Correction Factor (dB/m) = Antenna Factor (dB/m) + Cable Factor (dB).
 3. The other emission levels were very low against the limit.
 4. Margin value = Emission level – Limit value.



4.3 NUMBER OF HOPPING FREQUENCY USED

4.3.1 LIMIT OF HOPPING FREQUENCY USED

At least 15 channels frequencies, and should be equally spaced.

4.3.2 TEST INSTRUMENTS

Description & Manufacturer	Model No.	Serial No.	Calibrated Date	Calibrated Until
SPECTRUM ANALYZER	FSP 40	100036	Apr. 3, 2009	Apr. 2, 2010

NOTE: The calibration interval of the above test instruments is 12 months and the calibrations are traceable to NML/ROC and NIST/USA.

4.3.3 TEST PROCEDURES

- a. Check the calibration of the measuring instrument (SA) using either an internal calibrator or a known signal from an external generator.
- b. Turn on the EUT and connect its antenna terminal to measurement via a low loss cable. Then set it to any one measured frequency within its operating range and make sure the instrument is operated in its linear range.
- c. Set the SA on MaxHold Mode, and then keep the EUT in hopping mode. Record all the signals from each channel until each one has been recorded.
- d. Set the SA on View mode and then plot the result on SA screen.
- e. Repeat above procedures until all frequencies measured were complete.

4.3.4 DEVIATION FROM TEST STANDARD

No deviation.

4.3.5 TEST SETUP

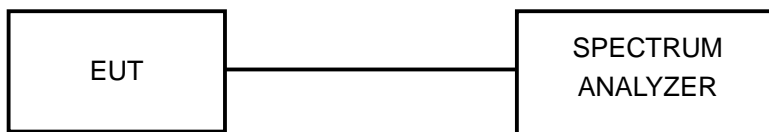

4.3.6 TEST RESULTS

There are 79 hopping frequencies in the hopping mode. Please refer to next two pages for the test result. On the plots, it shows that the hopping frequencies are equally spaced.



A D T

Mode A: FOR GFSK

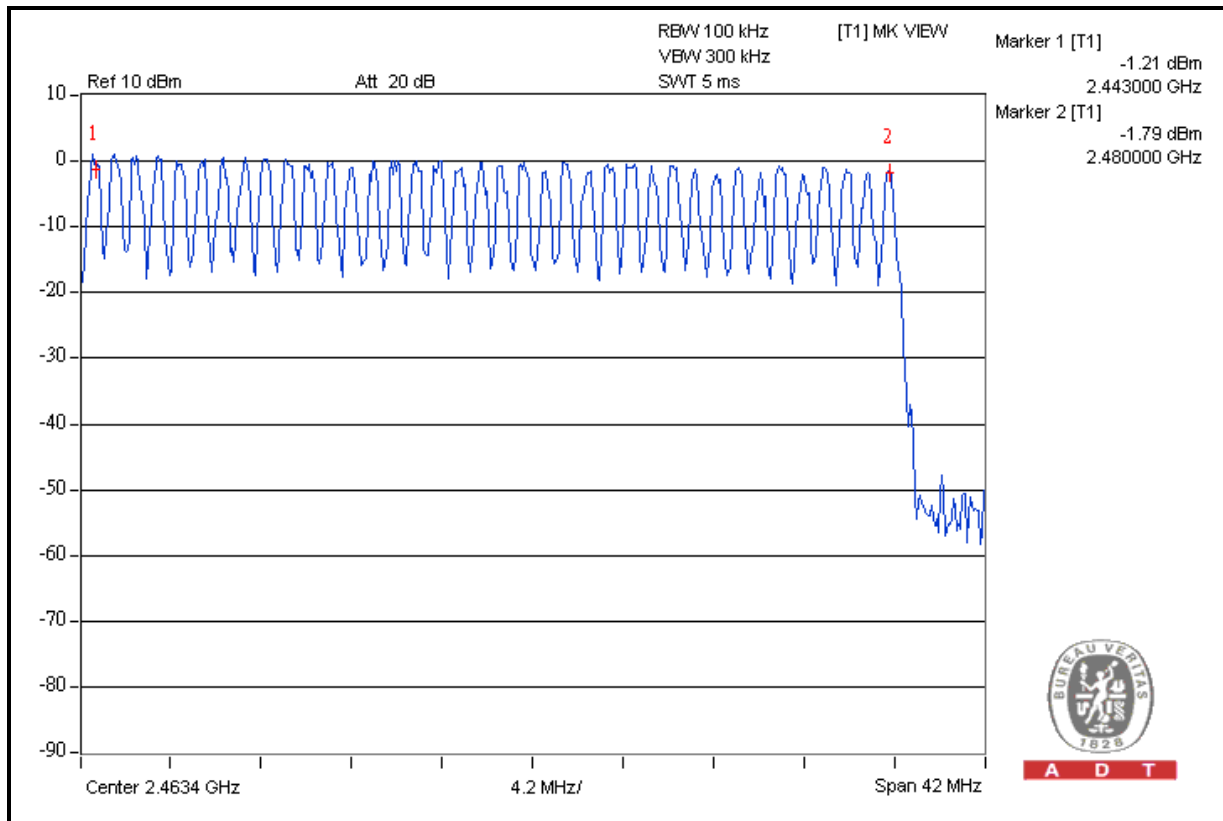
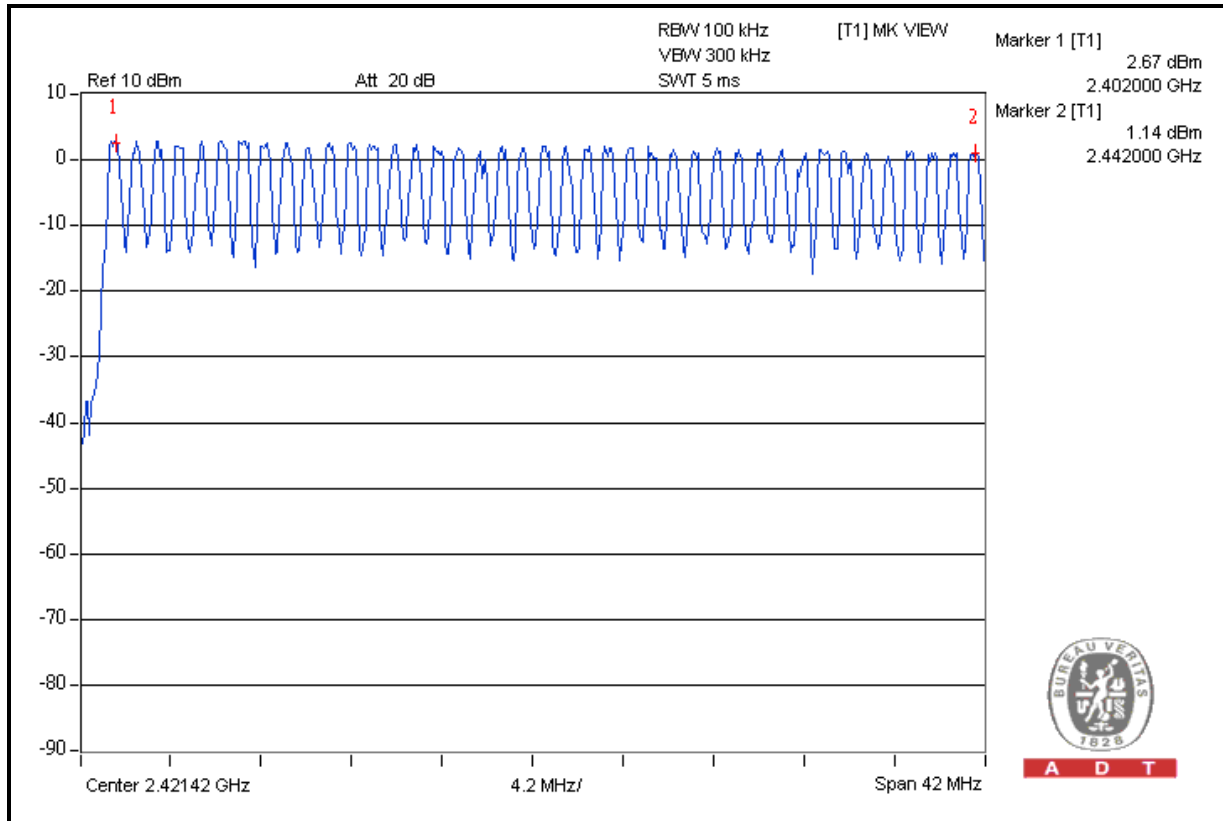



A D T

Mode A: FOR 8DPSK

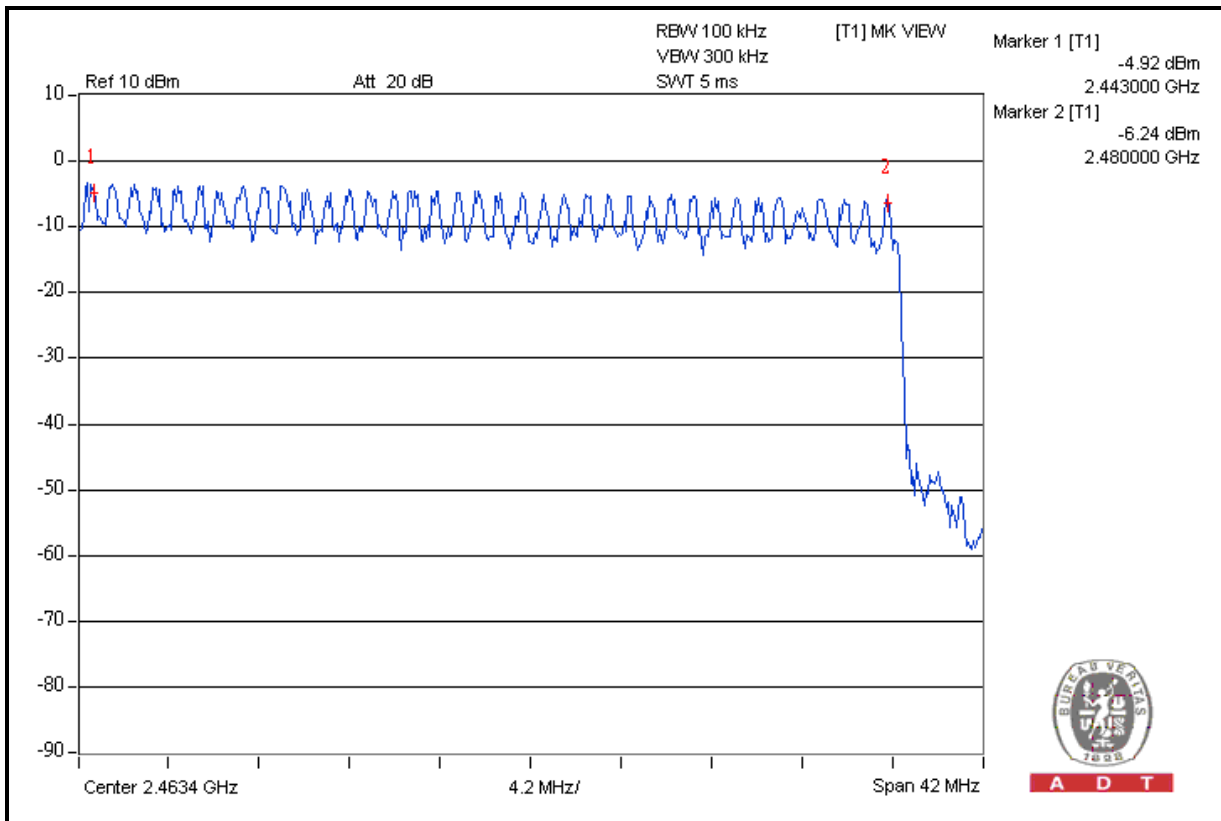
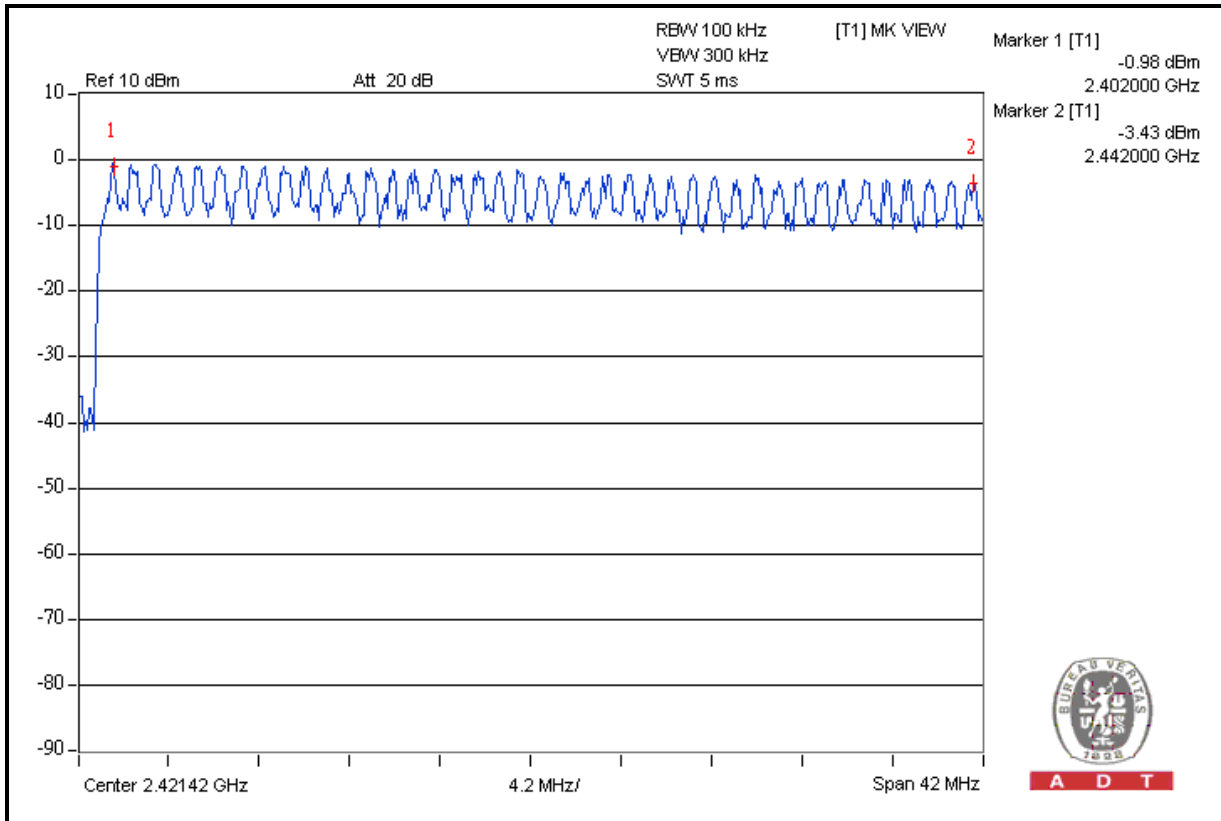



4.4 DWELL TIME ON EACH CHANNEL

4.4.1 LIMIT OF DWELL TIME USED

The average time of occupancy on any channel shall not be greater than 0.4 seconds within a period of 0.4 seconds multiplied by the number of hopping channels employed.

4.4.2 TEST INSTRUMENTS

Description & Manufacturer	Model No.	Serial No.	Calibrated Date	Calibrated Until
SPECTRUM ANALYZER	FSP 40	100036	Apr. 3, 2009	Apr. 2, 2010

NOTE: The calibration interval of the above test instruments is 12 months and the calibrations are traceable to NML/ROC and NIST/USA.

4.4.3 TEST PROCEDURES

- a. Check the calibration of the measuring instrument (SA) using either an internal calibrator or a known signal from an external generator.
- b. Turn on the EUT and connect its antenna terminal to measurement via a low loss cable. Then set it to any one measured frequency within its operating range and make sure the instrument is operated in its linear range.
- c. Adjust the center frequency of SA on any frequency be measured and set SA to zero span mode. And then, set RBW and VBW of spectrum analyzer to proper value.
- d. Measure the time duration of one transmission on the measured frequency. And then plot the result with time difference of this time duration.
- e. Repeat above procedures until all different time-slot modes have been completed.

4.4.4 DEVIATION FROM TEST STANDARD

No deviation.

4.4.5 TEST SETUP

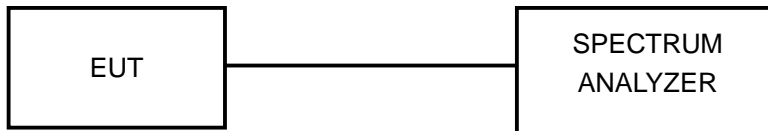

4.4.6 TEST RESULTS

Mode A: FOR GFSK

Mode	Number of transmission in a 31.6 (79Hopping*0.4)	Length of transmission time (msec)	Result (msec)	Limit (msec)
DH1	51 (times / 5 sec) *6.32=322.32 times	0.450	145.04400	400
DH3	26 (times / 5 sec) *6.32=164.32 times	1.716	281.97312	400
DH5	17 (times / 5 sec) *6.32=107.44 times	2.980	320.17120	400

NOTE: Test plots of the transmitting time slot are shown on next 3 pages.



A D T

DH1

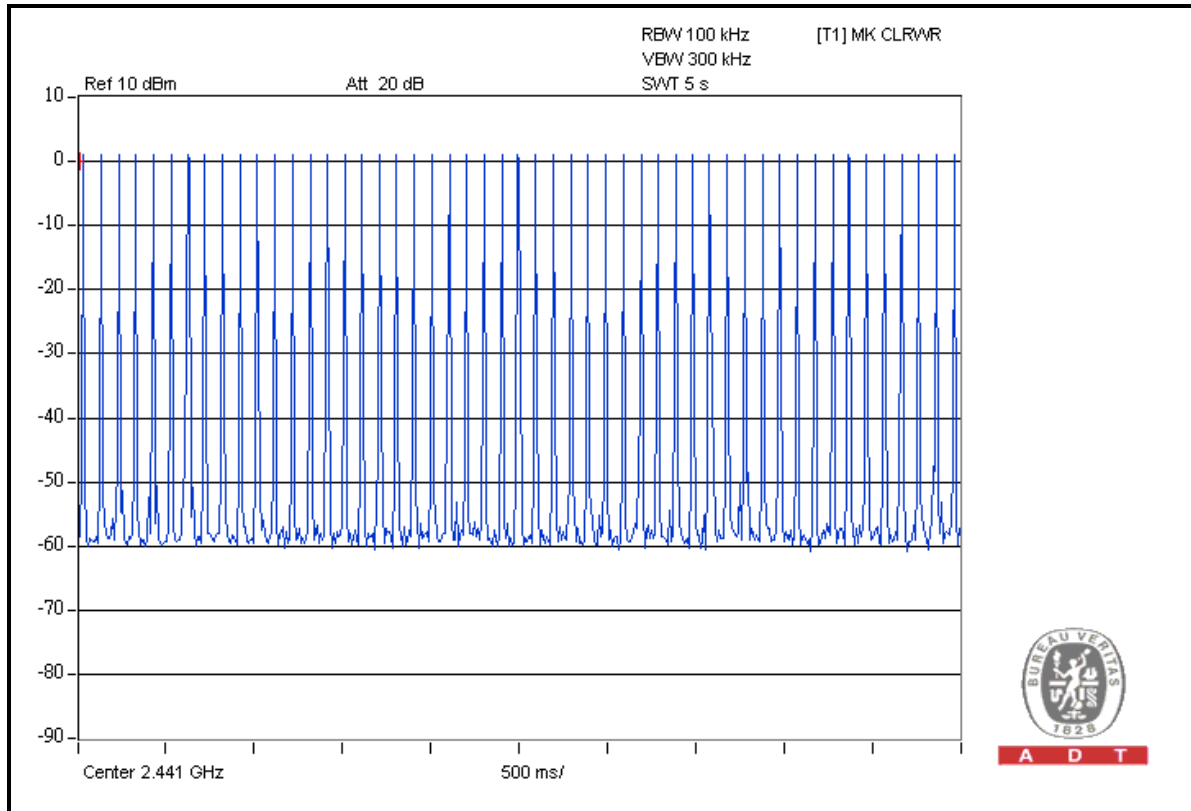

A D T

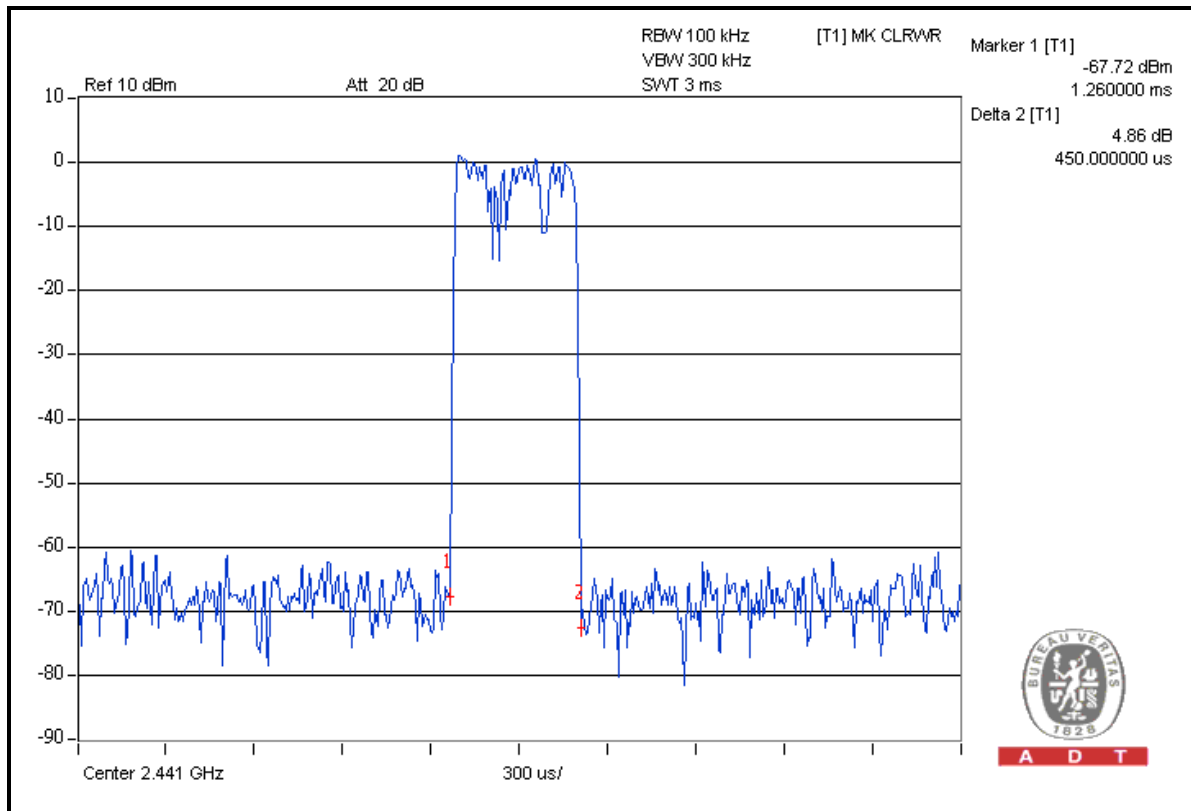

A D T



A D T

DH3

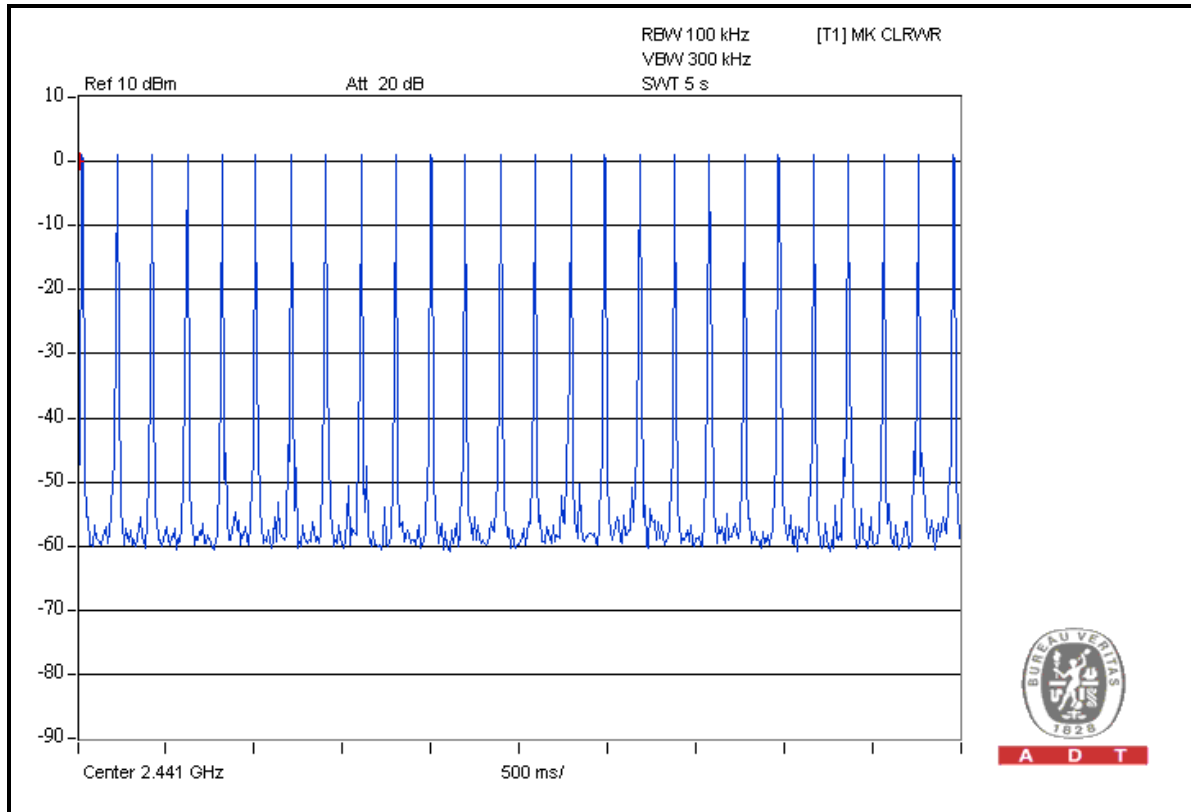

A D T

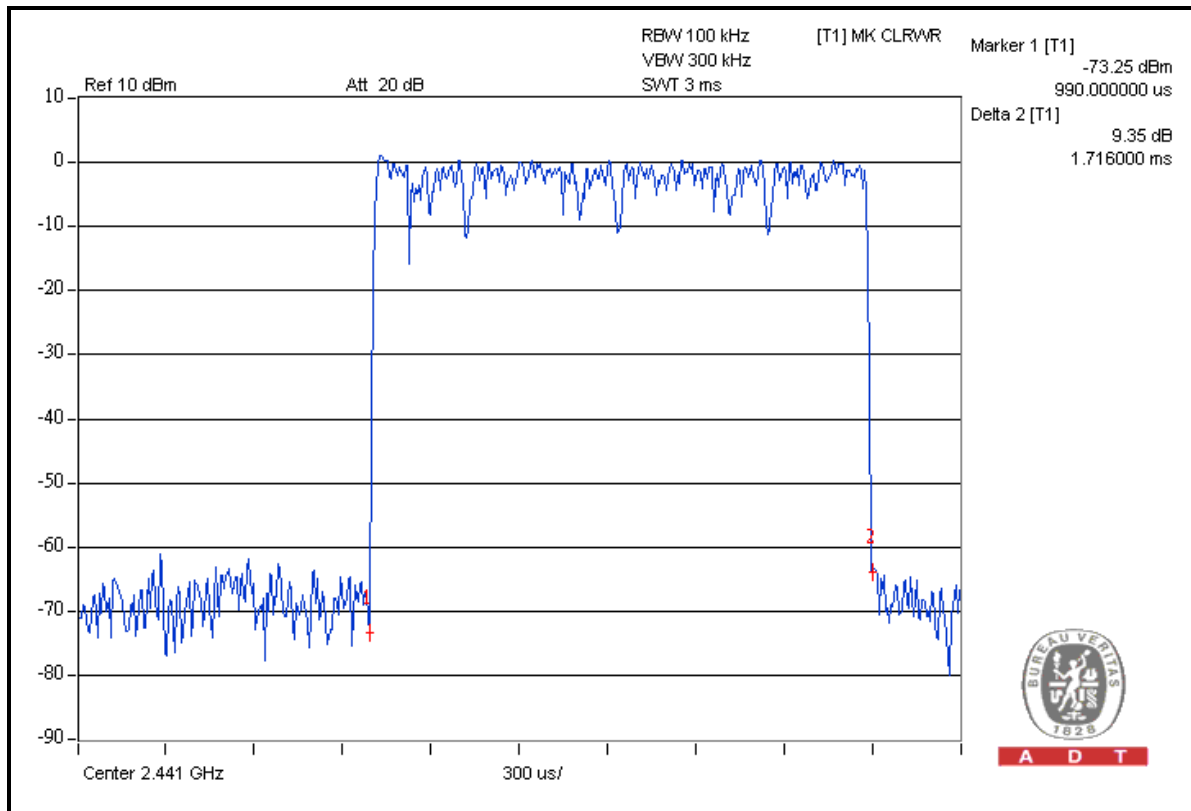

A D T



A D T

DH5

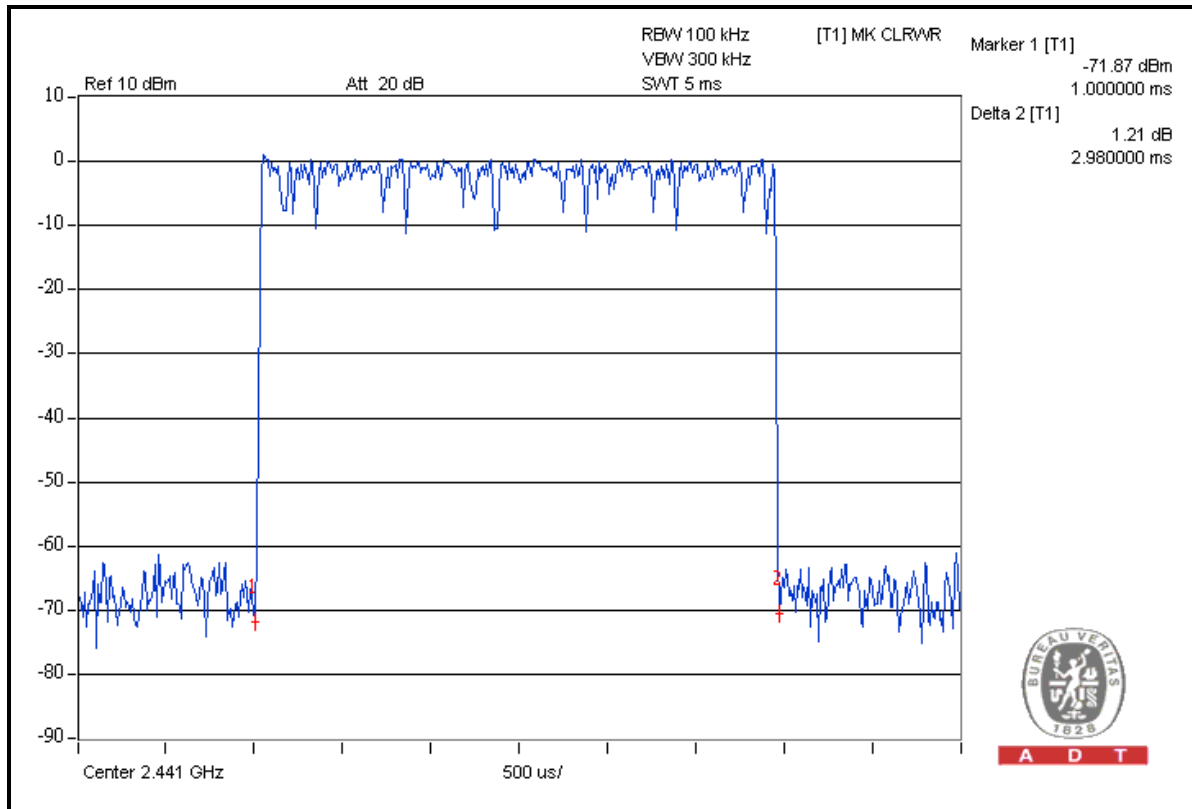
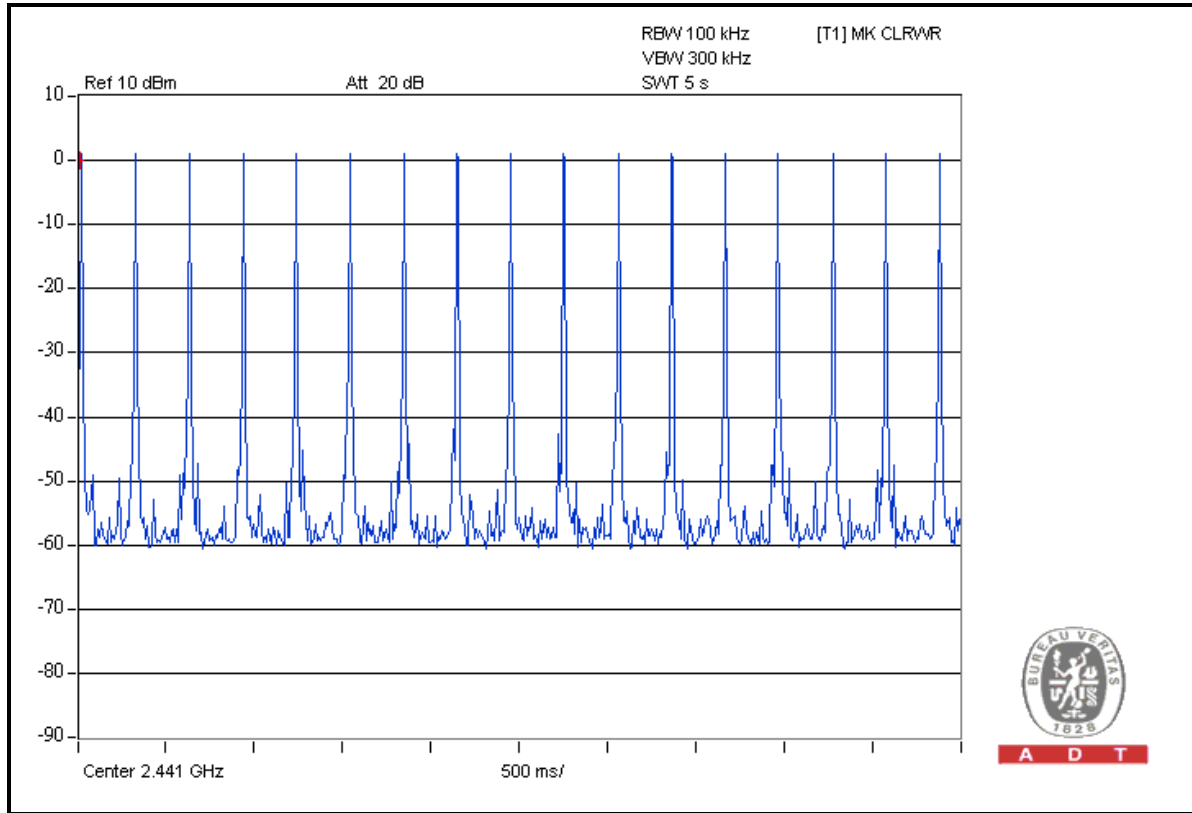

Mode A: FOR 8DPSK

Mode	Number of transmission in a 31.6 (79Hopping*0.4)	Length of transmission time (msec)	Result (msec)	Limit (msec)
DH1	51 (times / 5 sec) *6.32=322.32 times	0.522	168.25104	400
DH3	25 (times / 5 sec) *6.32=158.00 times	1.758	277.76400	400
DH5	17 (times / 5 sec) *6.32=107.44 times	3.030	325.54320	400

NOTE: Test plots of the transmitting time slot are shown on next 3 pages.



A D T

DH1

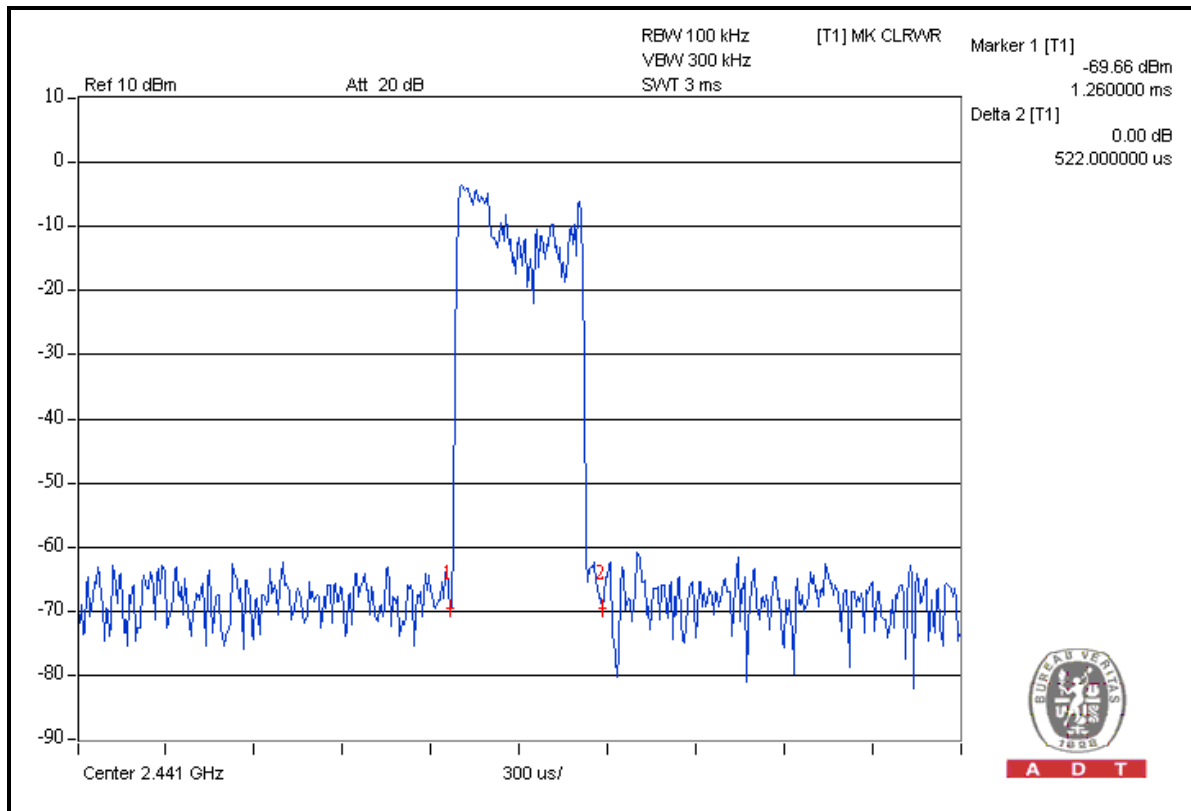
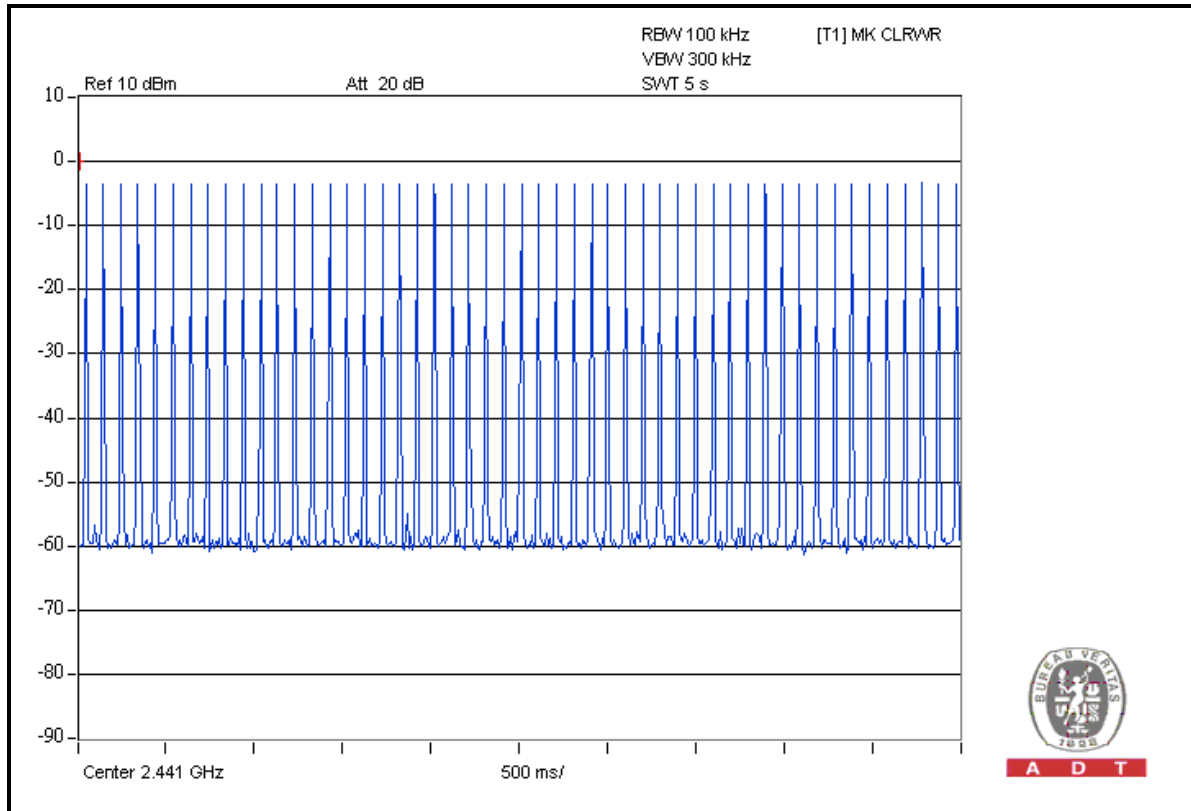



A D T

DH3

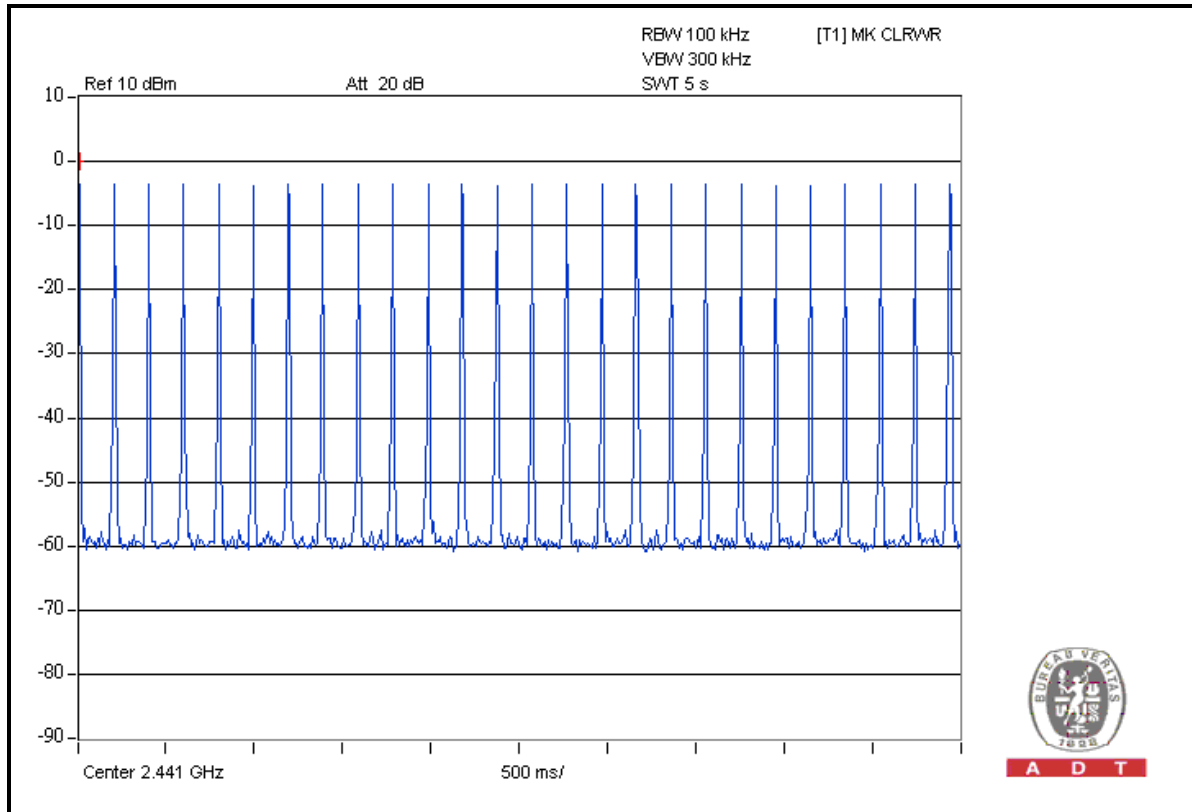

A D T

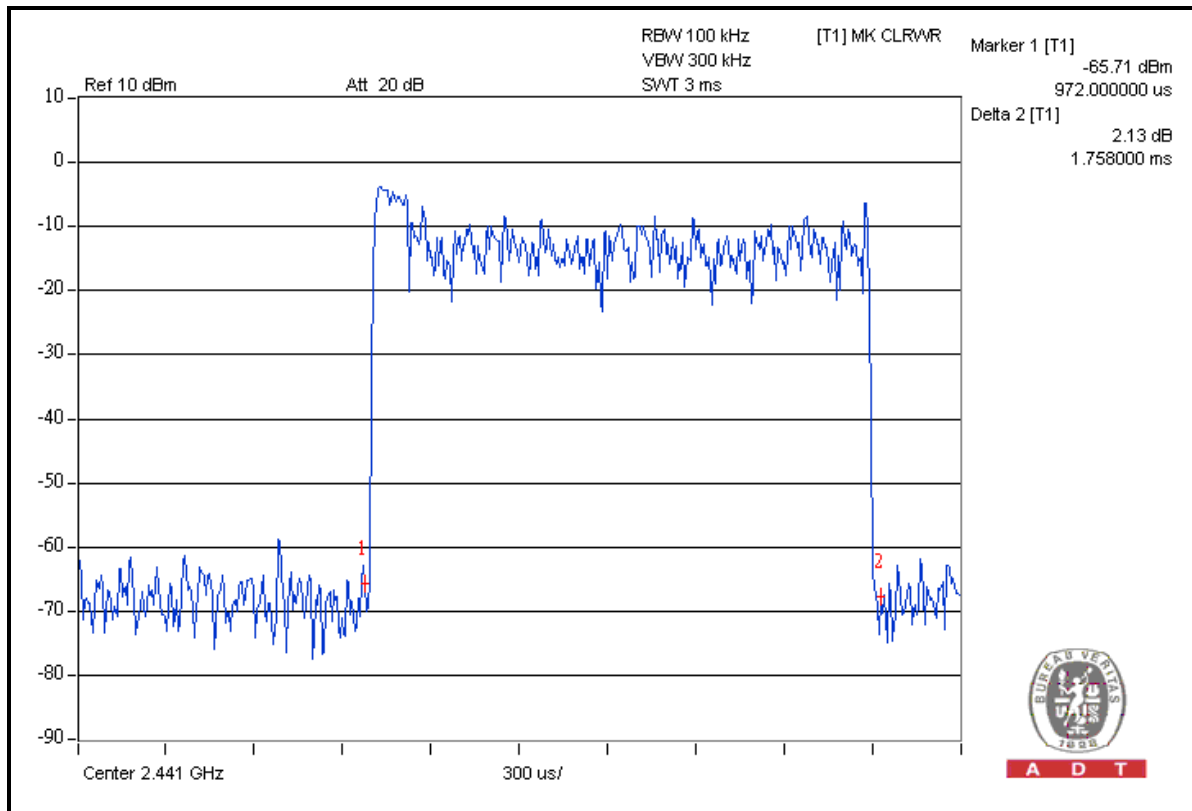

A D T



A D T

DH5

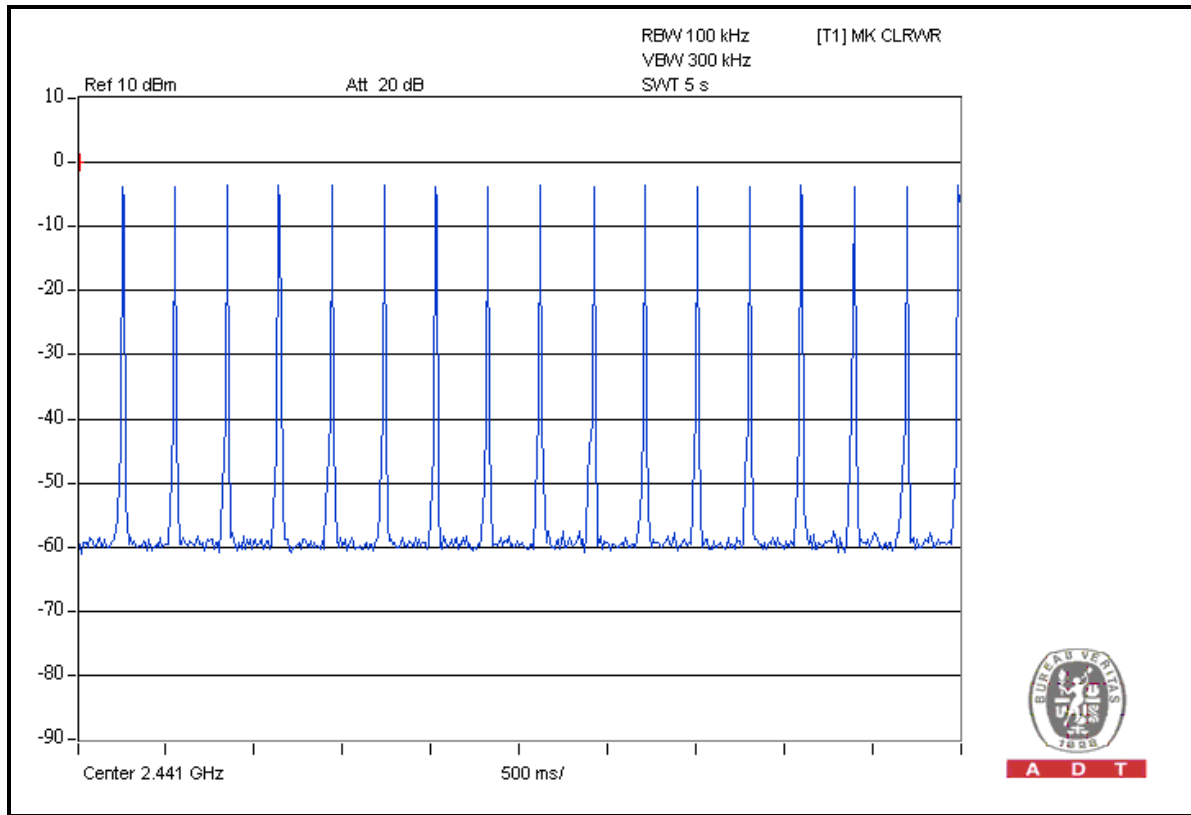

A D T

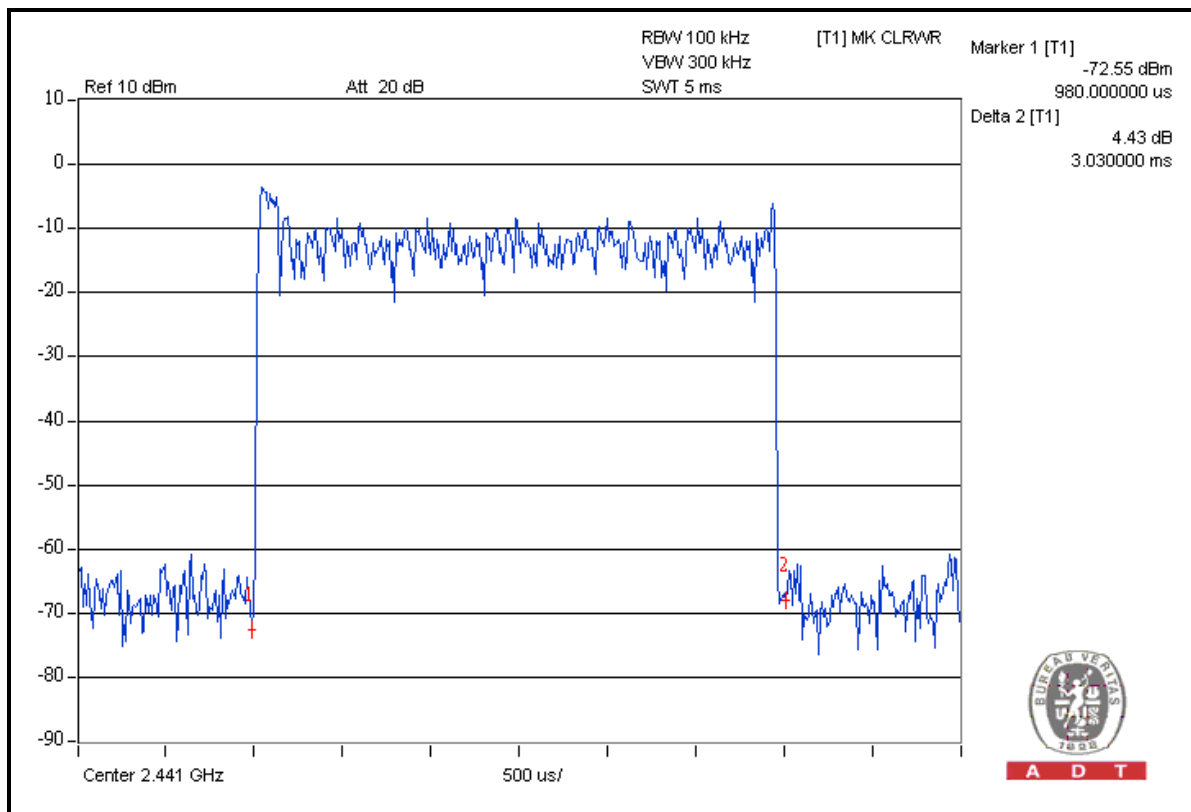

A D T



4.5 CHANNEL BANDWIDTH

4.5.1 LIMITS OF CHANNEL BANDWIDTH

For frequency hopping system operating in the 2400-2483.5MHz, If the 20dB bandwidth of hopping channel is greater than 25kHz, the 20dB bandwidth of hopping channel shall be a minimum limit for the hopping channel separation.

4.5.2 TEST INSTRUMENTS

Description & Manufacturer	Model No.	Serial No.	Calibrated Date	Calibrated Until
SPECTRUM ANALYZER	FSP 40	100036	Apr. 3, 2009	Apr. 2, 2010

NOTE: The calibration interval of the above test instruments is 12 months and the calibrations are traceable to NML/ROC and NIST/USA.

4.5.3 TEST PROCEDURE

- a. Check the calibration of the measuring instrument using either an internal calibrator or a known signal from an external generator.
- b. Turn on the EUT and connect it to measurement instrument. Then set it to any one convenient frequency within its operating range. Set a reference level on the measuring instrument equal to the highest peak value.
- c. Measure the frequency difference of two frequencies that were attenuated 20dB from the reference level. Record the frequency difference as the emission bandwidth.
- d. Repeat above procedures until all frequencies measured were complete.

4.5.4 DEVIATION FROM TEST STANDARD

No deviation.

4.5.5 TEST SETUP

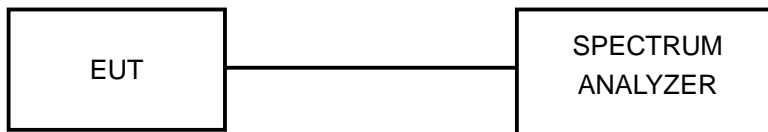

4.5.6 EUT OPERATING CONDITION

The software provided by client enabled the EUT to transmit and receive data at lowest, middle and highest channel frequencies individually.

4.5.7 TEST RESULTS

FOR GFSK

TEST MODE	A	CHANNEL	0, 39, 78
INPUT POWER (SYSTEM)	120Vac, 60 Hz	ENVIRONMENTAL CONDITIONS	25deg. C, 70% RH, 1008hPa
TESTED BY	Chad Lee		

CHANNEL	CHANNEL FREQUENCY (MHz)	20dB BANDWIDTH (MHz)
0	2402	0.843
39	2441	0.847
78	2480	0.867



A D T

CH 0

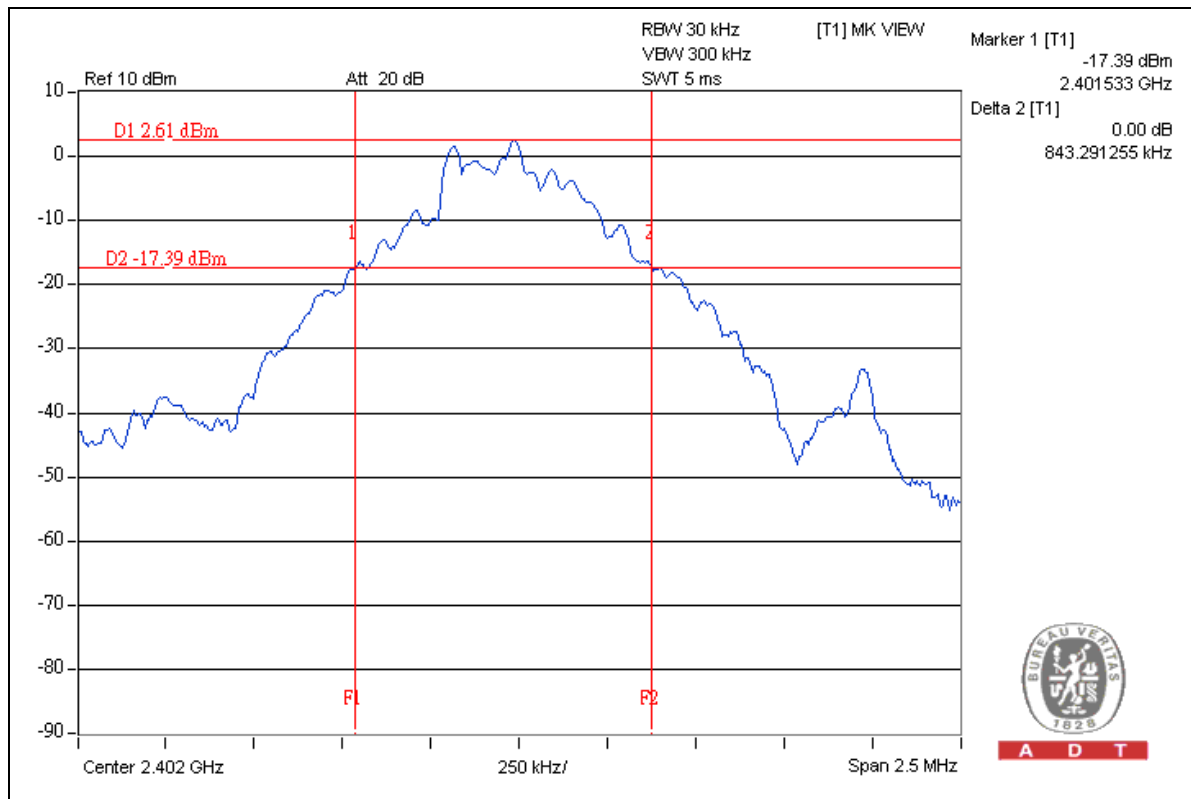

CH 39

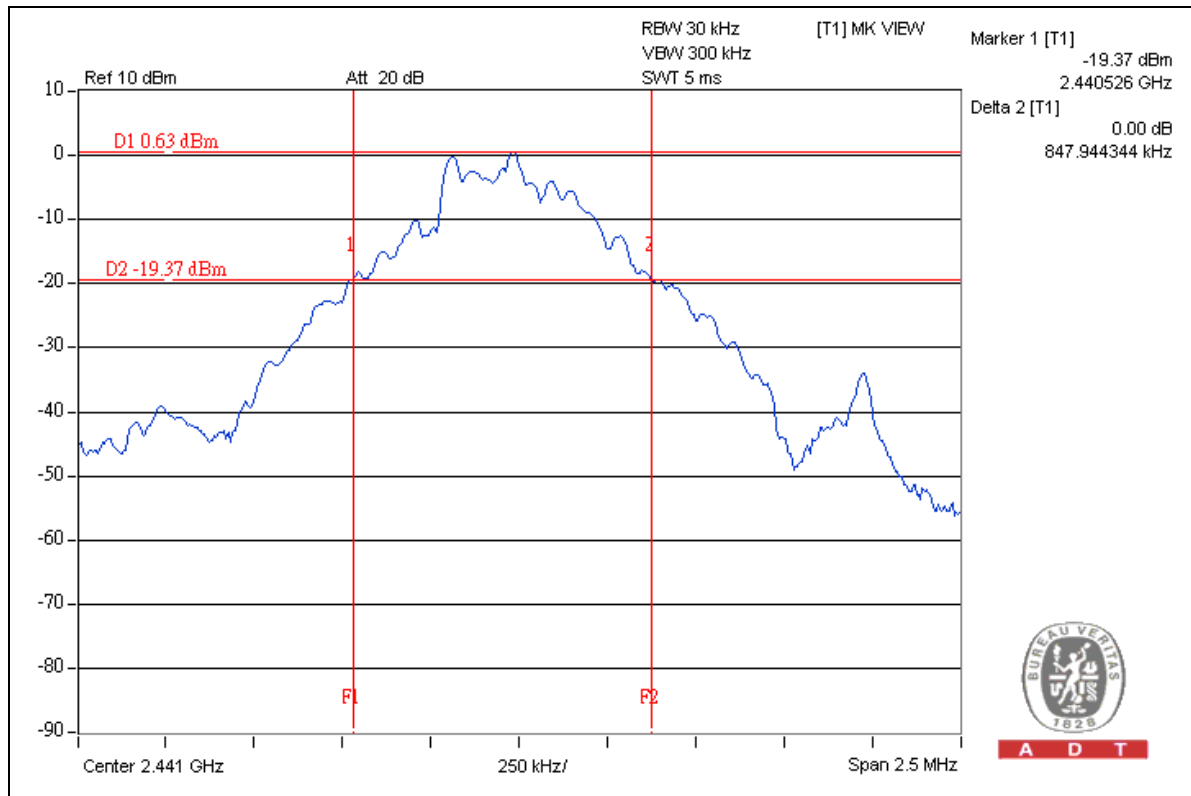



A D T

CH 78

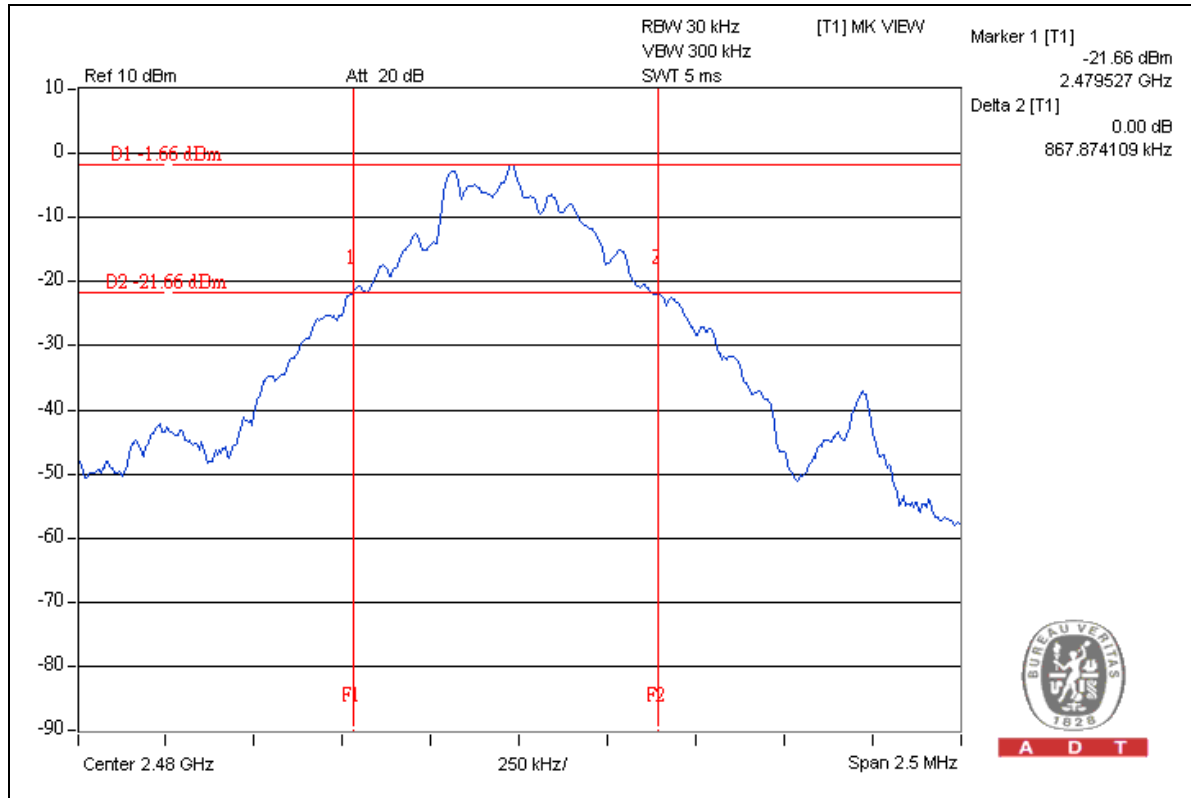

A D T



A D T

FOR 8DPSK

TEST MODE	A	CHANNEL	0, 39, 78
INPUT POWER (SYSTEM)	120Vac, 60 Hz	ENVIRONMENTAL CONDITIONS	25deg. C, 70% RH, 1008hPa
TESTED BY	Nick Chen		

CHANNEL	CHANNEL FREQUENCY (MHz)	20dB BANDWIDTH (MHz)
0	2402	1.189
39	2441	1.209
78	2480	1.209



A D T

CH 0

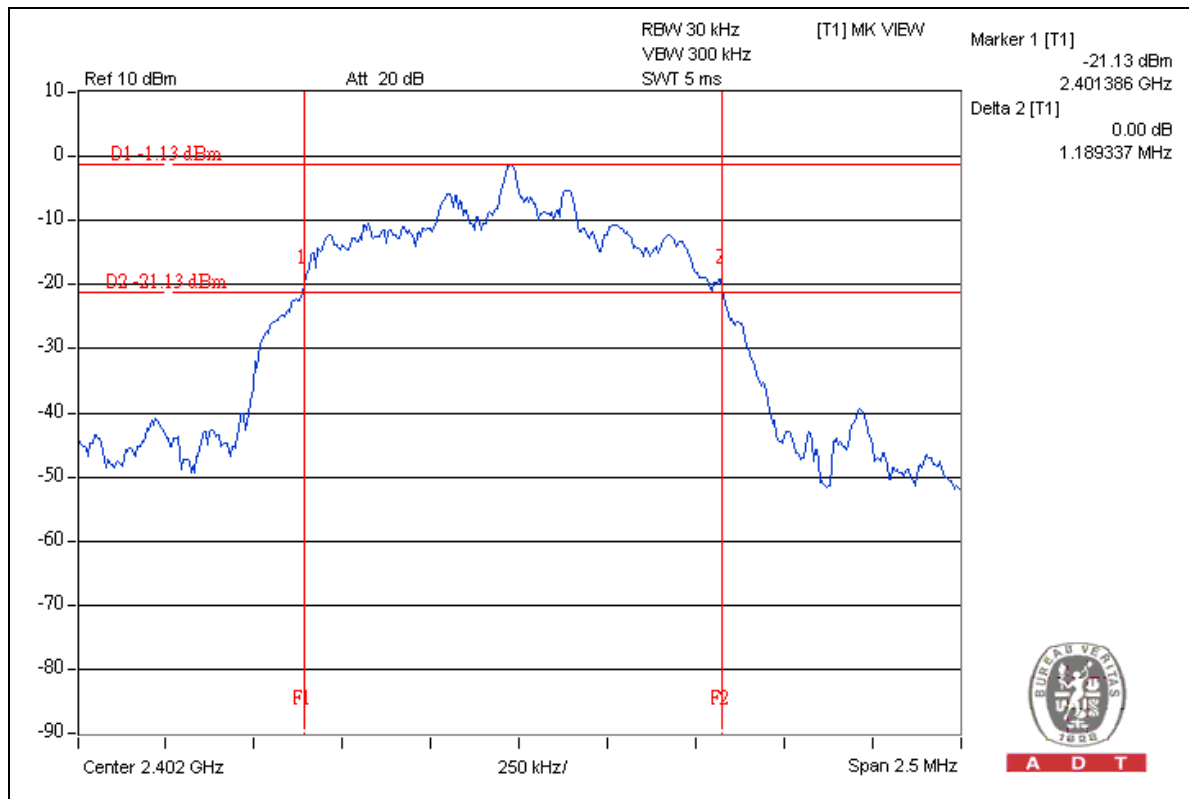

A D T

CH 39

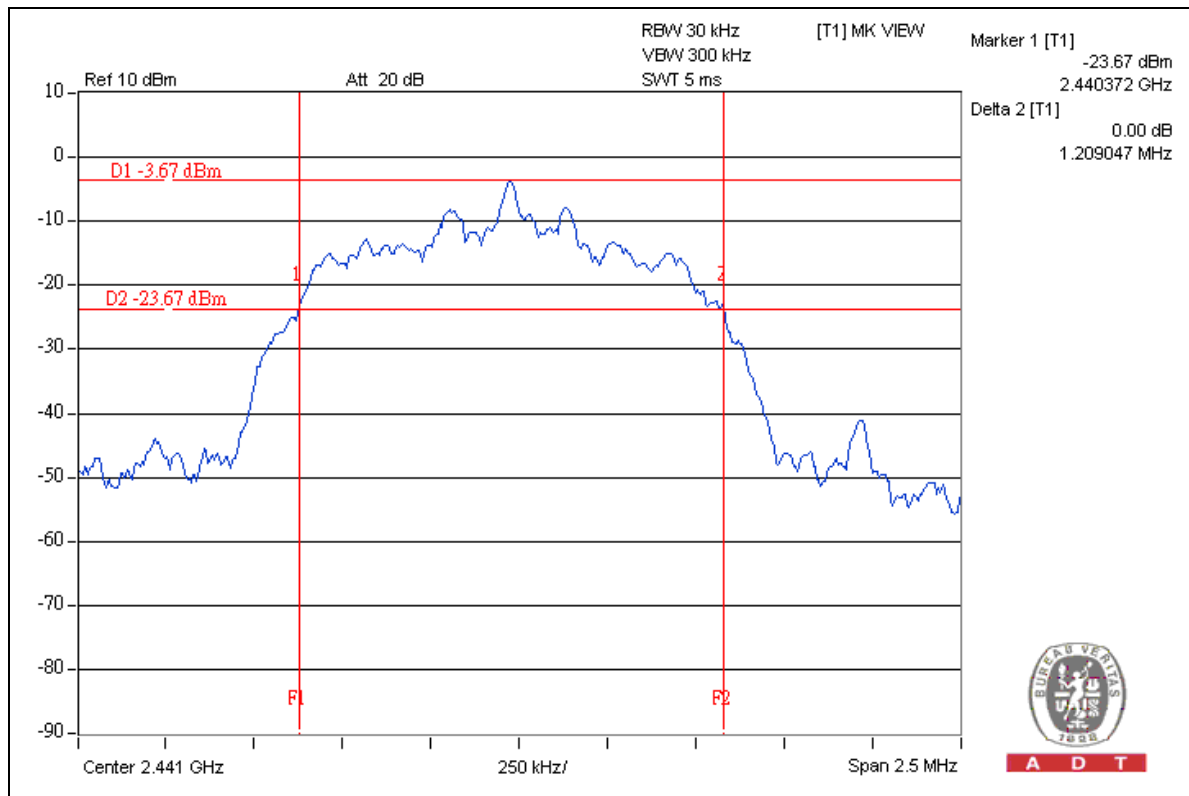

A D T



A D T

CH 78

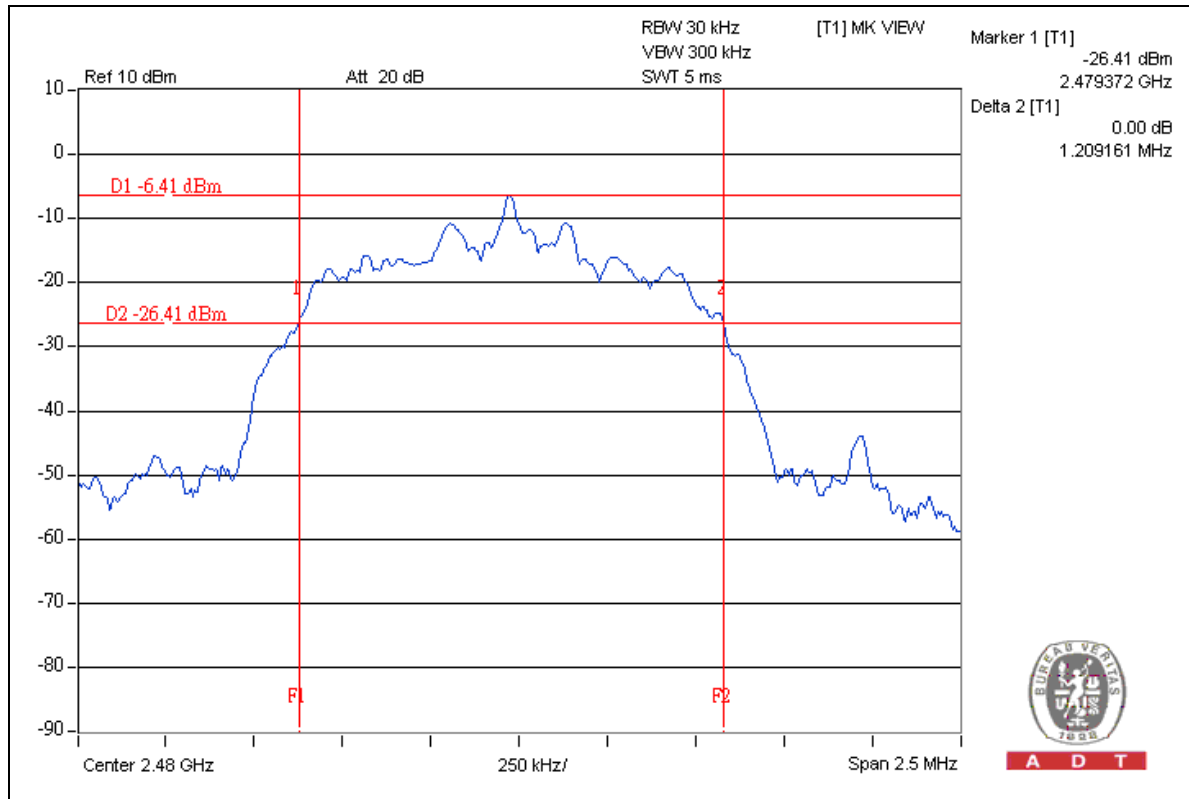

4.6 HOPPING CHANNEL SEPARATION

4.6.1 LIMIT OF HOPPING CHANNEL SEPARATION

At least 25kHz or two-third of 20dB hopping channel bandwidth (whichever is greater).

4.6.2 TEST INSTRUMENTS

Description & Manufacturer	Model No.	Serial No.	Calibrated Date	Calibrated Until
SPECTRUM ANALYZER	FSP 40	100036	Apr. 3, 2009	Apr. 2, 2010

NOTE: The calibration interval of the above test instruments is 12 months and the calibrations are traceable to NML/ROC and NIST/USA.

4.6.3 TEST PROCEDURES

1. Check the calibration of the measuring instrument using either an internal calibrator or a known signal from an external generator.
2. Turn on the EUT and connect it to measurement instrument. Then set it to any one convenient frequency within its operating range.
3. By using the MaxHold function record the separation of two adjacent channels.
4. Measure the frequency difference of these two adjacent channels by SA MARK function. And then plot the result on SA screen.
5. Repeat above procedures until all frequencies measured were complete.

4.6.4 DEVIATION FROM TEST STANDARD

No deviation.

4.6.5 TEST SETUP

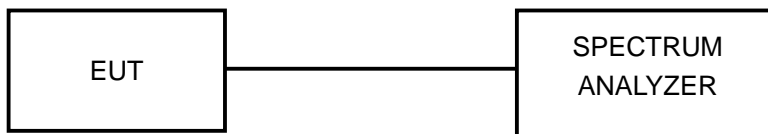

4.6.6 TEST RESULTS

FOR GFSK

TEST MODE	A	CHANNEL	0, 39, 78
INPUT POWER (SYSTEM)	120Vac, 60 Hz	ENVIRONMENTAL CONDITIONS	25deg. C, 70% RH, 1008hPa
TESTED BY	Chad Lee		

CHANNEL	FREQUENCY (MHz)	ADJACENT CHANNEL SEPARATION (MHz)	20dB BANDWIDTH (MHz)	MINIMUM LIMIT (MHz)	PASS / FAIL
0	2402	1.003	0.843	0.562	PASS
39	2441	1.007	0.847	0.565	PASS
78	2480	1.003	0.867	0.578	PASS

NOTE: The minimum limit is two-third 20dB bandwidth. Test results please refer to following three plots.



A D T

CH 0

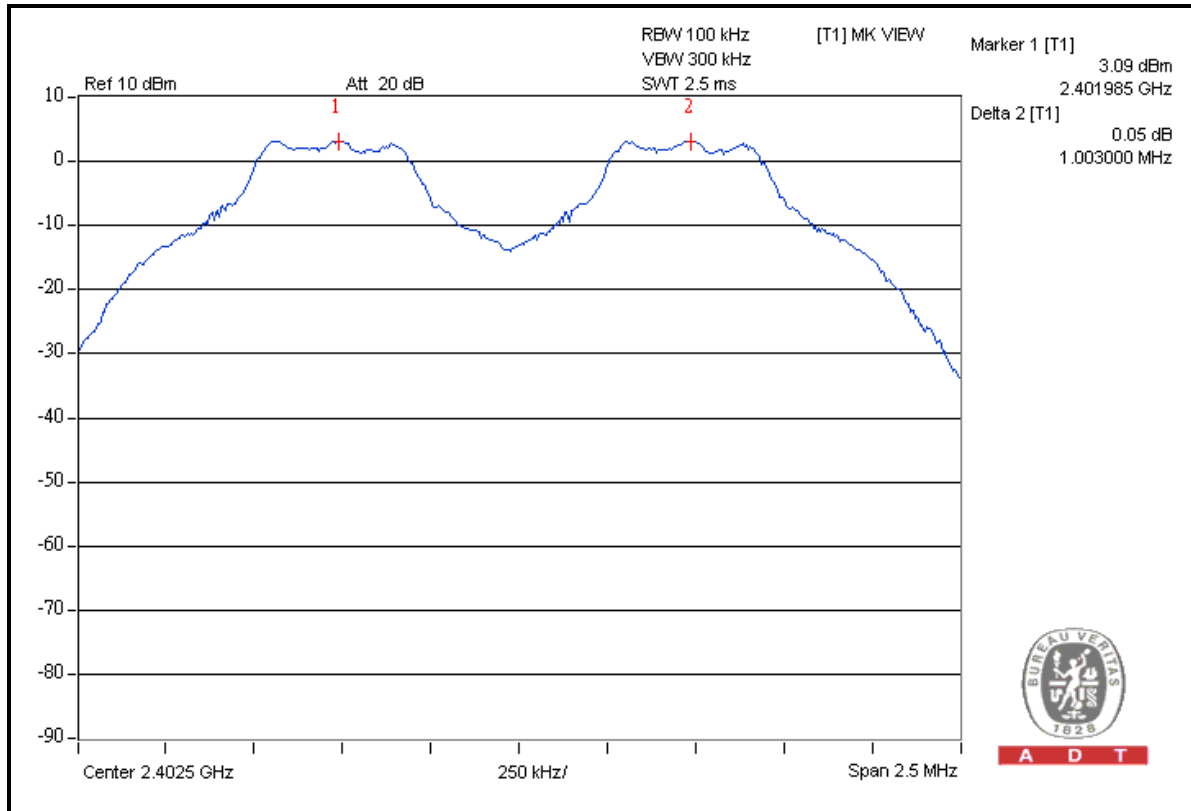

CH 39

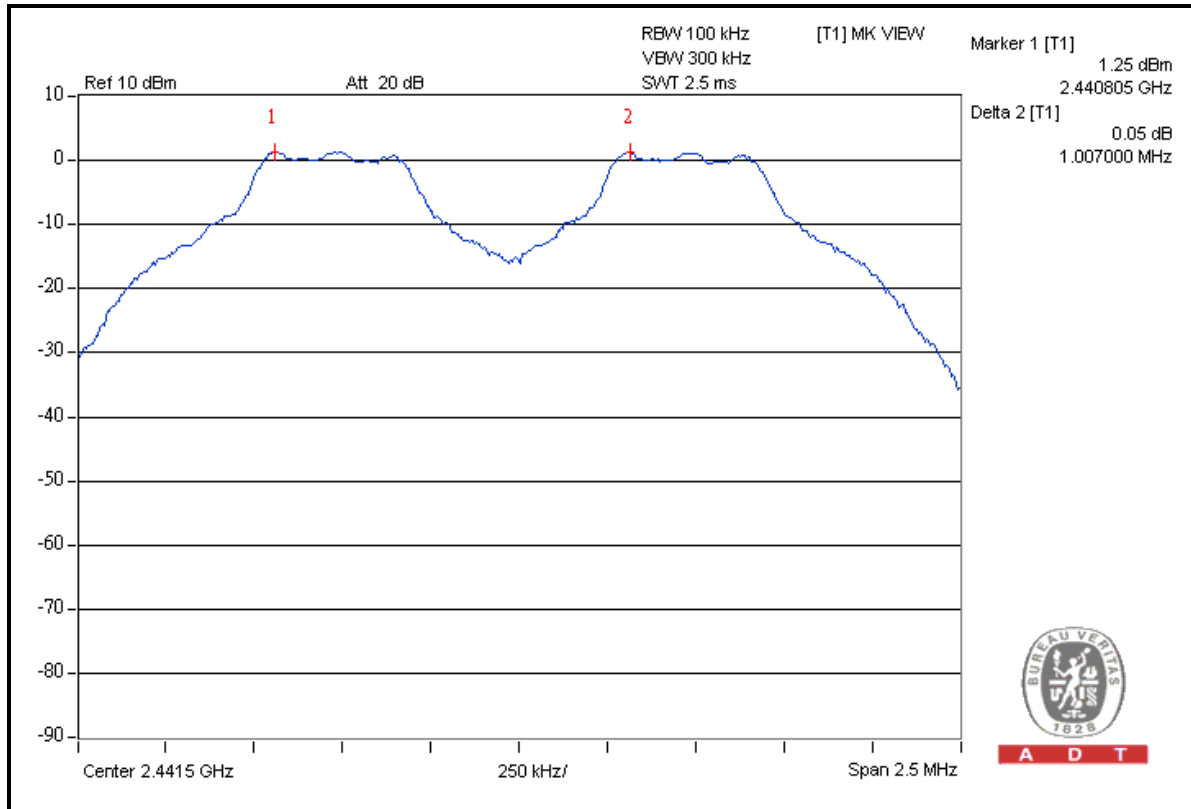



A D T

CH 78

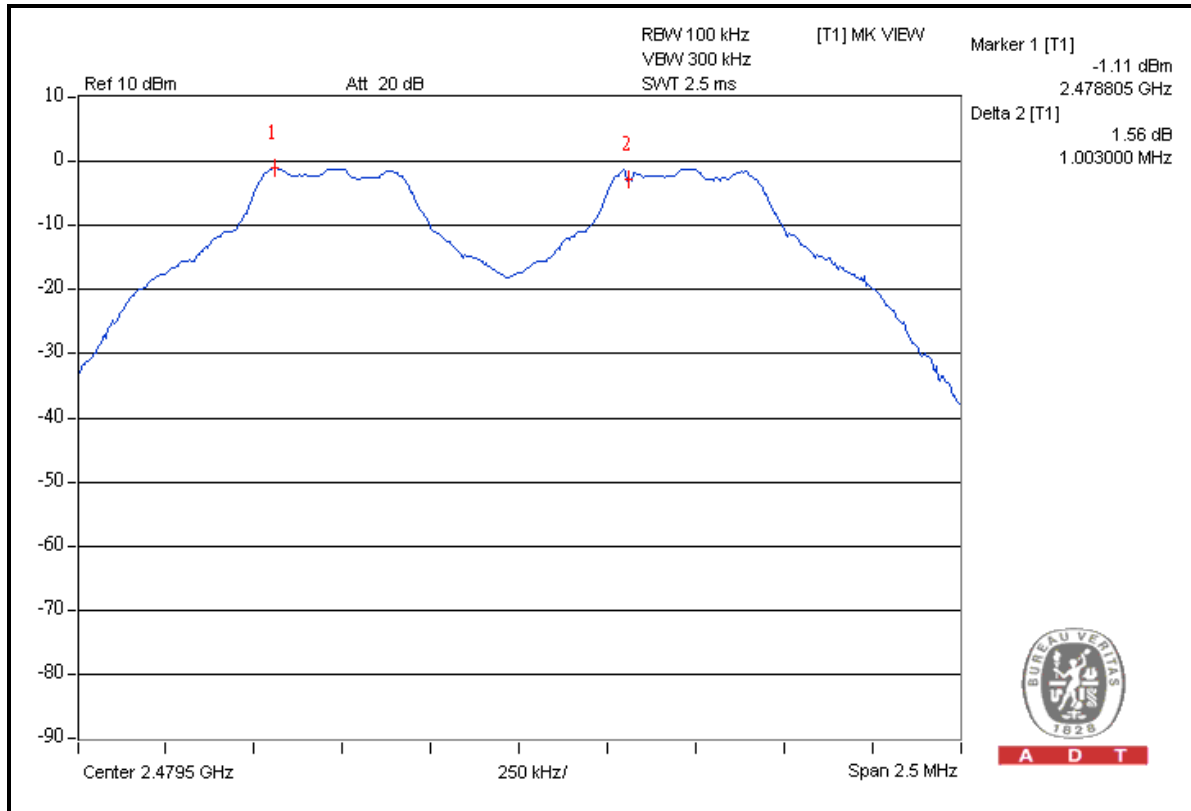

A D T



A D T

FOR 8DPSK

TEST MODE	A	CHANNEL	0, 39, 78
INPUT POWER (SYSTEM)	120Vac, 60 Hz	ENVIRONMENTAL CONDITIONS	25deg. C, 70% RH, 1008hPa
TESTED BY	Nick Chen		

CHANNEL	FREQUENCY (MHz)	ADJACENT CHANNEL SEPARATION (MHz)	20dB BANDWIDTH (MHz)	MINIMUM LIMIT (MHz)	PASS / FAIL
0	2402	1.005	1.189	0.793	PASS
39	2441	1.005	1.209	0.806	PASS
78	2480	1.007	1.209	0.806	PASS

NOTE: The minimum limit is two-third 20dB bandwidth. Test results please refer to following three plots.



A D T

CH 0

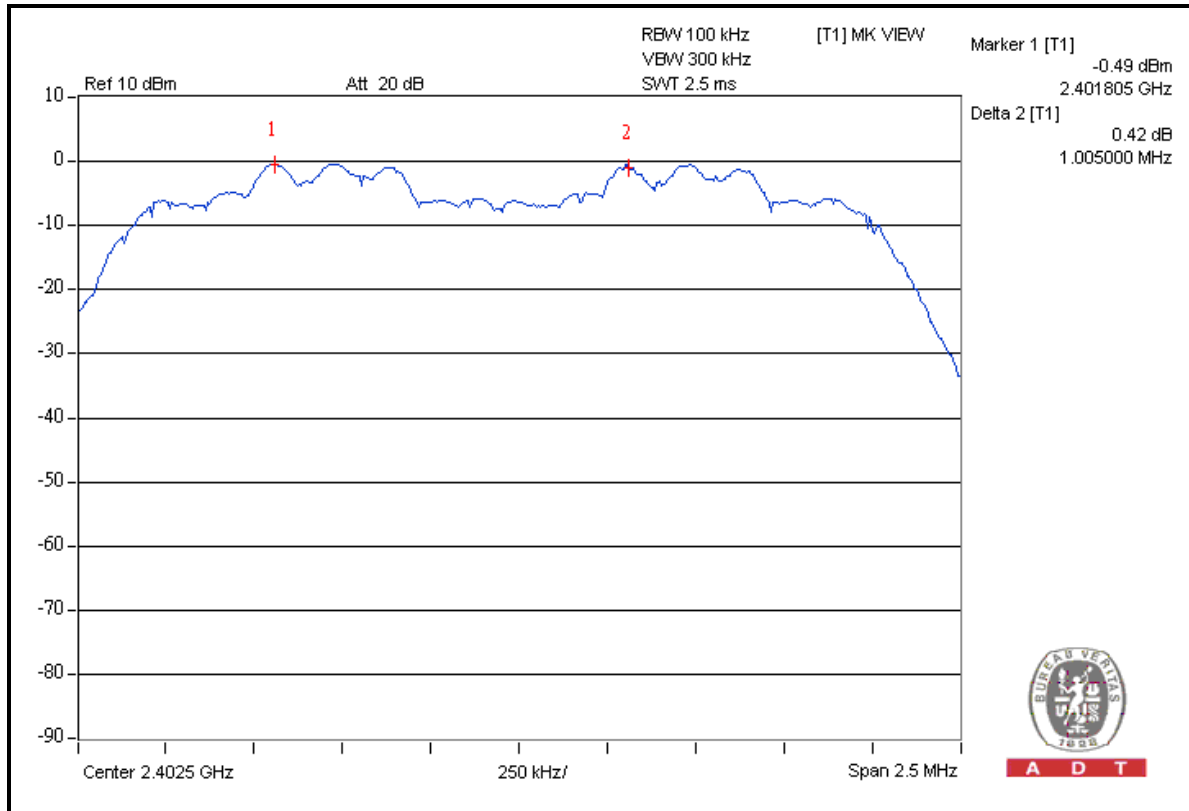

CH 39

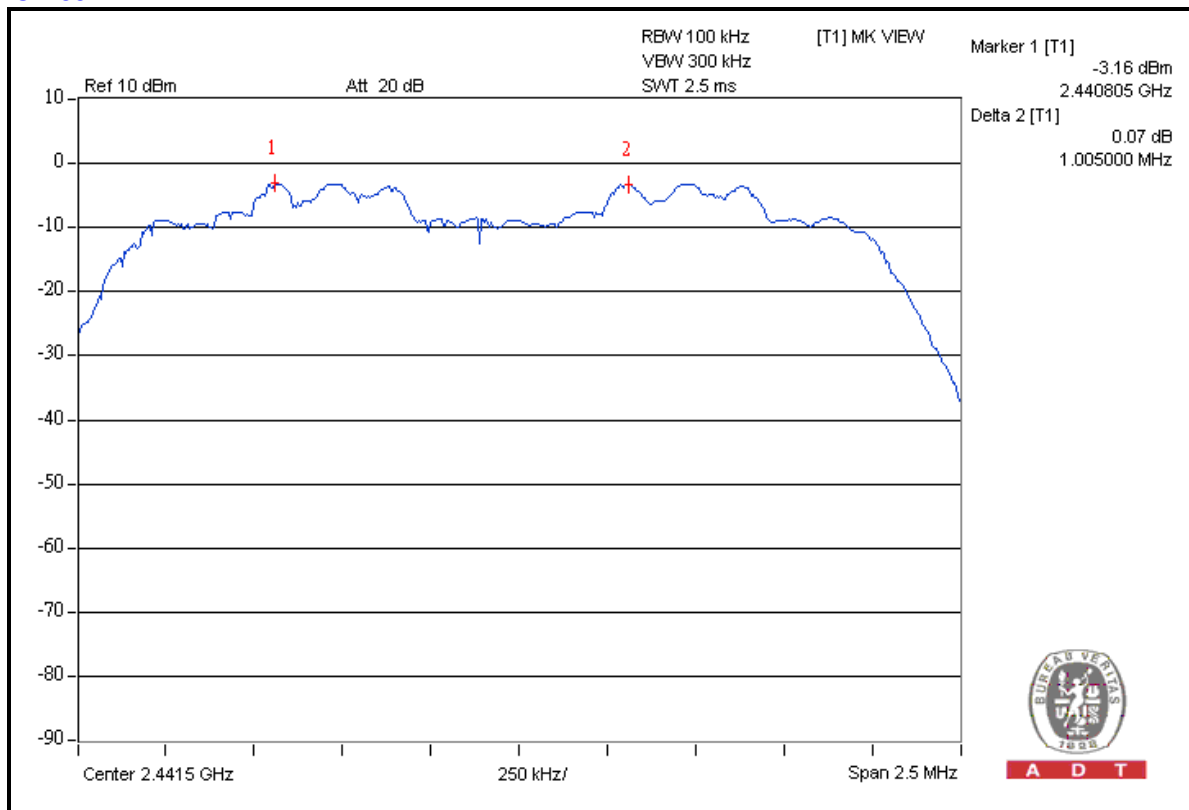



A D T

CH 78

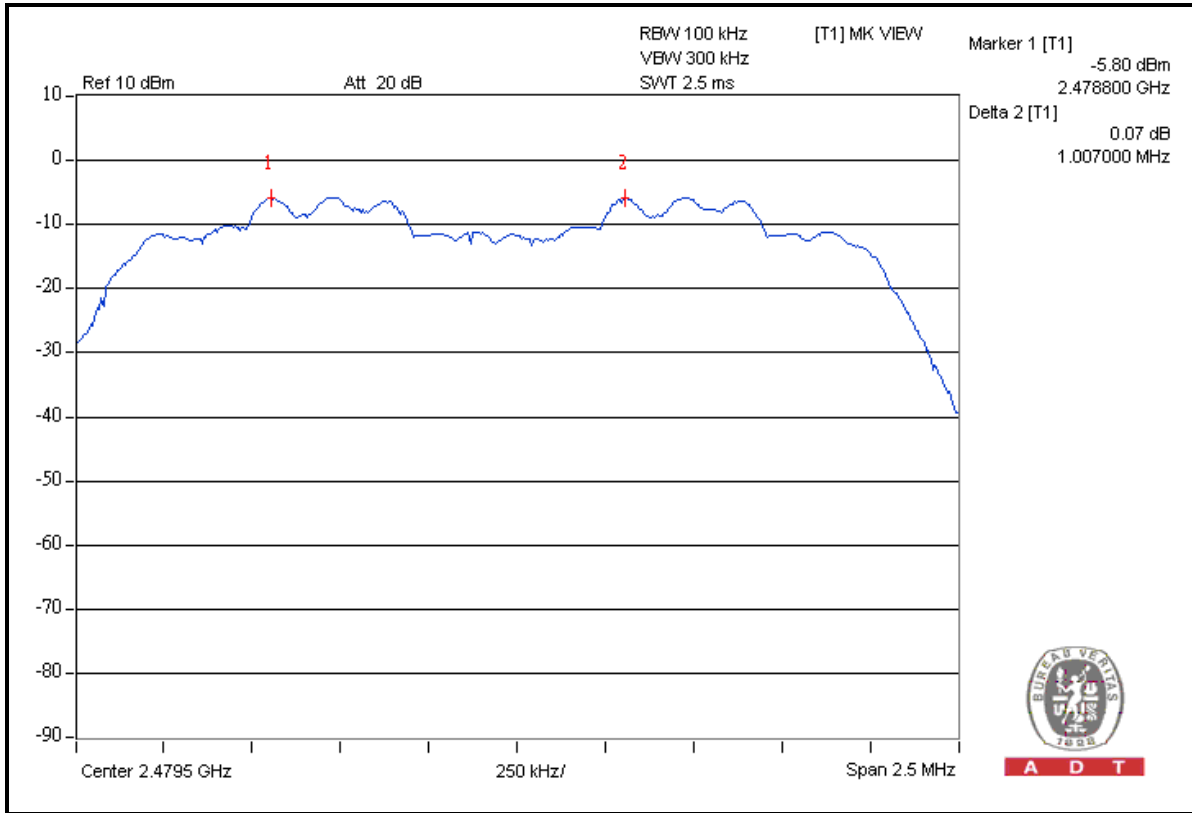

4.7 MAXIMUM PEAK OUTPUT POWER

4.7.1 LIMITS OF MAXIMUM PEAK OUTPUT POWER MEASUREMENT

The Maximum Peak Output Power Measurement is 30dBm.

4.7.2 TEST INSTRUMENTS

Description & Manufacturer	Model No.	Serial No.	Calibrated Date	Calibrated Until
SPECTRUM ANALYZER	FSP 40	100036	Apr. 3, 2009	Apr. 2, 2010

NOTE: The calibration interval of the above test instruments is 12 months and the calibrations are traceable to NML/ROC and NIST/USA.

4.7.3 TEST PROCEDURES

- a. Check the calibration of the measuring instrument using either an internal calibrator or a known signal from an external generator.
- b. Turn on the EUT and connect it to measurement instrument. Then set it to any one convenient frequency within its operating range. Set a reference level on the measuring instrument equal to the highest peak value.
- c. The center frequency of the spectrum analyzer is set to the fundamental frequency and using 3 MHz RBW and 10 MHz VBW.
- d. Measure the captured power within the band and recording the plot.
- e. Repeat above procedures until all frequencies required were complete.

4.7.4 DEVIATION FROM TEST STANDARD

No deviation

4.7.5 TEST SETUP

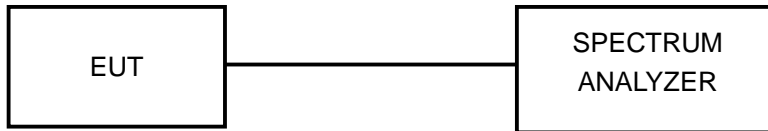

For the actual test configuration, please refer to the related Item – Photographs of the Test Configuration.

4.7.6 EUT OPERATING CONDITION

The software provided by client enabled the EUT to transmit and receive data at lowest, middle and highest channel frequencies individually.

4.7.7 TEST RESULTS

FOR GFSK

TEST MODE	A	CHANNEL	0, 39, 78
INPUT POWER (SYSTEM)	120Vac, 60 Hz	ENVIRONMENTAL CONDITIONS	25deg. C, 70% RH, 1008hPa
TESTED BY	Chad Lee		

CHANNEL	CHANNEL FREQUENCY (MHz)	PEAK POWER OUTPUT (mW)	PEAK POWER OUTPUT (dBm)	PEAK POWER LIMIT (dBm)	PASS/FAIL
0	2402	2.148	3.32	30	PASS
39	2441	1.387	1.42	30	PASS
78	2480	0.796	-0.99	30	PASS



A D T

CH 0

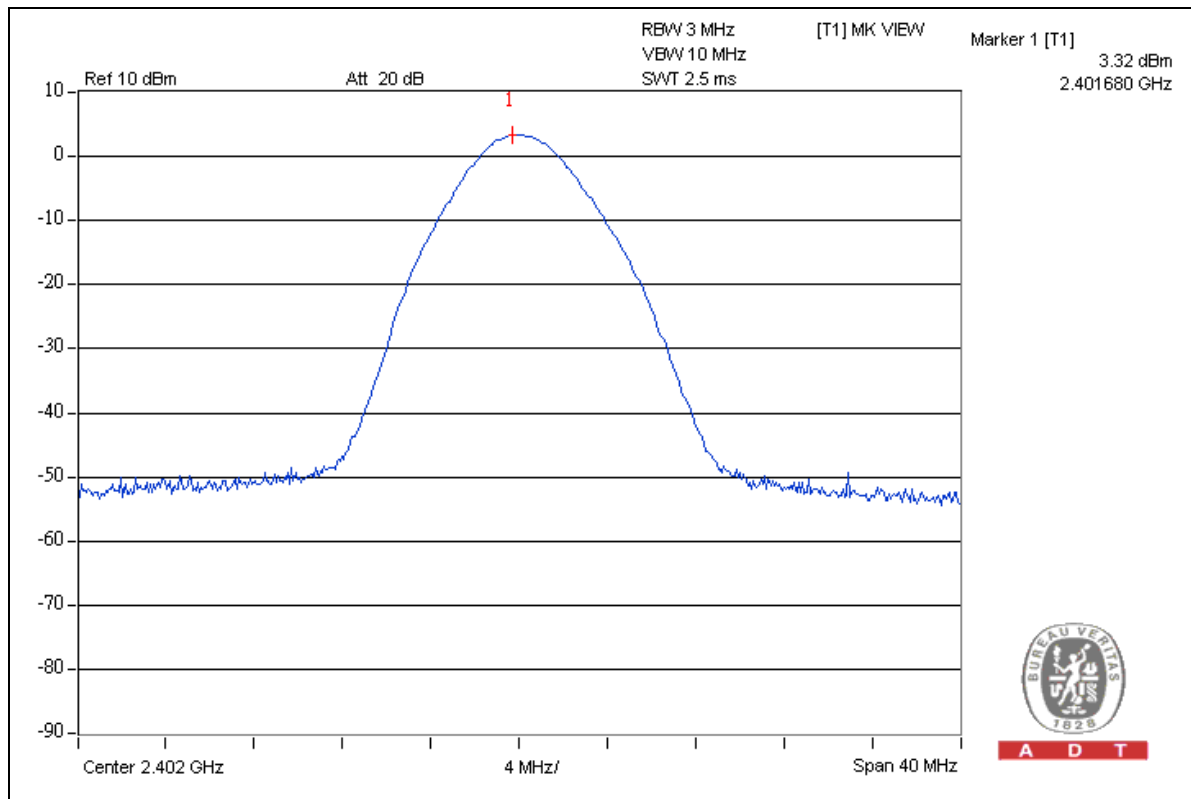

CH 39

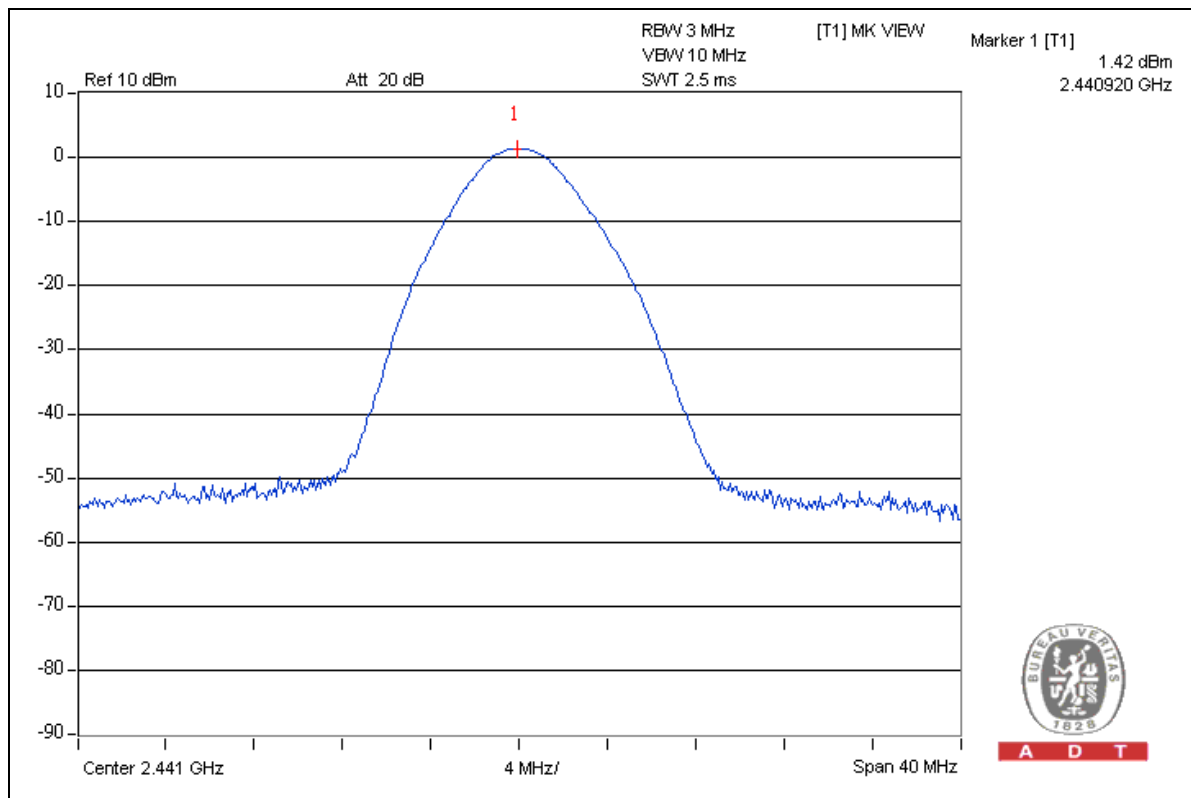



A D T

CH 78

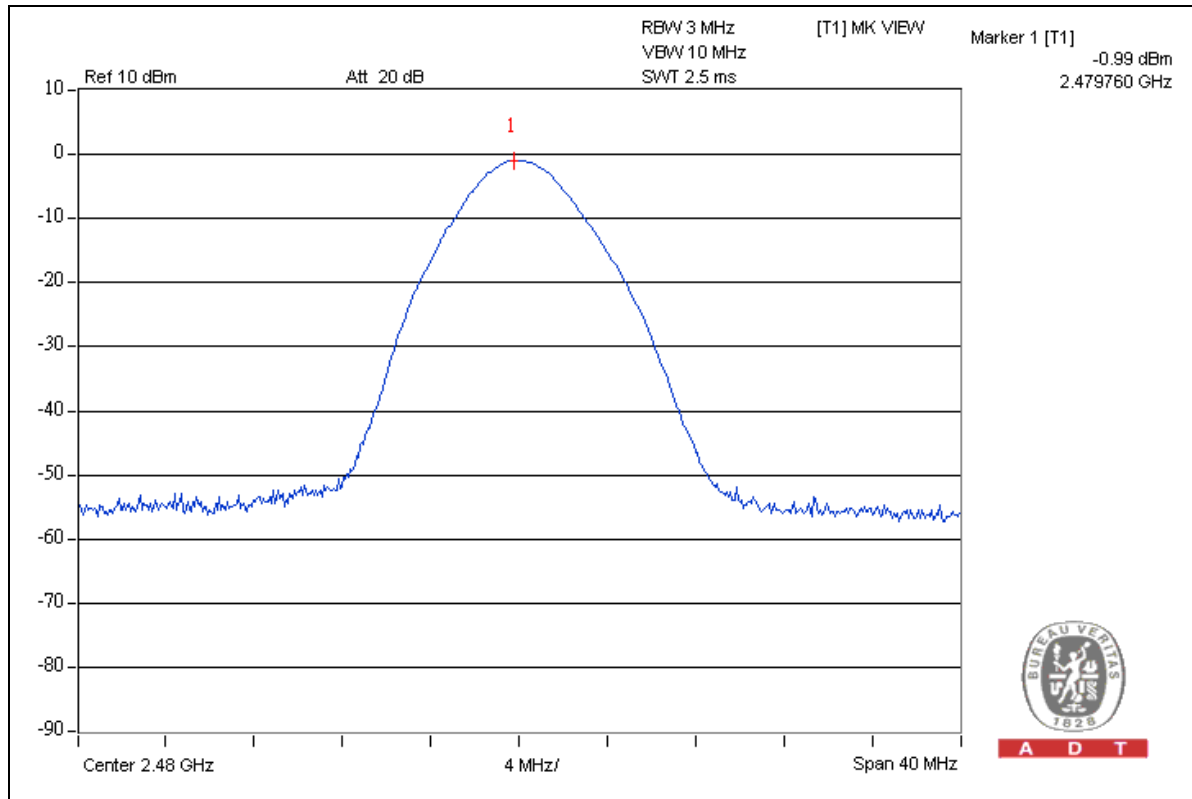



A D T

FOR 8DPSK

TEST MODE	A	CHANNEL	0, 39, 78
INPUT POWER (SYSTEM)	120Vac, 60 Hz	ENVIRONMENTAL CONDITIONS	25deg. C, 70% RH, 1008hPa
TESTED BY	Chad Lee		

CHANNEL	CHANNEL FREQUENCY (MHz)	PEAK POWER OUTPUT (mW)	PEAK POWER OUTPUT (dBm)	PEAK POWER LIMIT (dBm)	PASS/FAIL
0	2402	1.054	0.23	30	PASS
39	2441	0.585	-2.33	30	PASS
78	2480	0.310	-5.08	30	PASS



A D T

CH 0

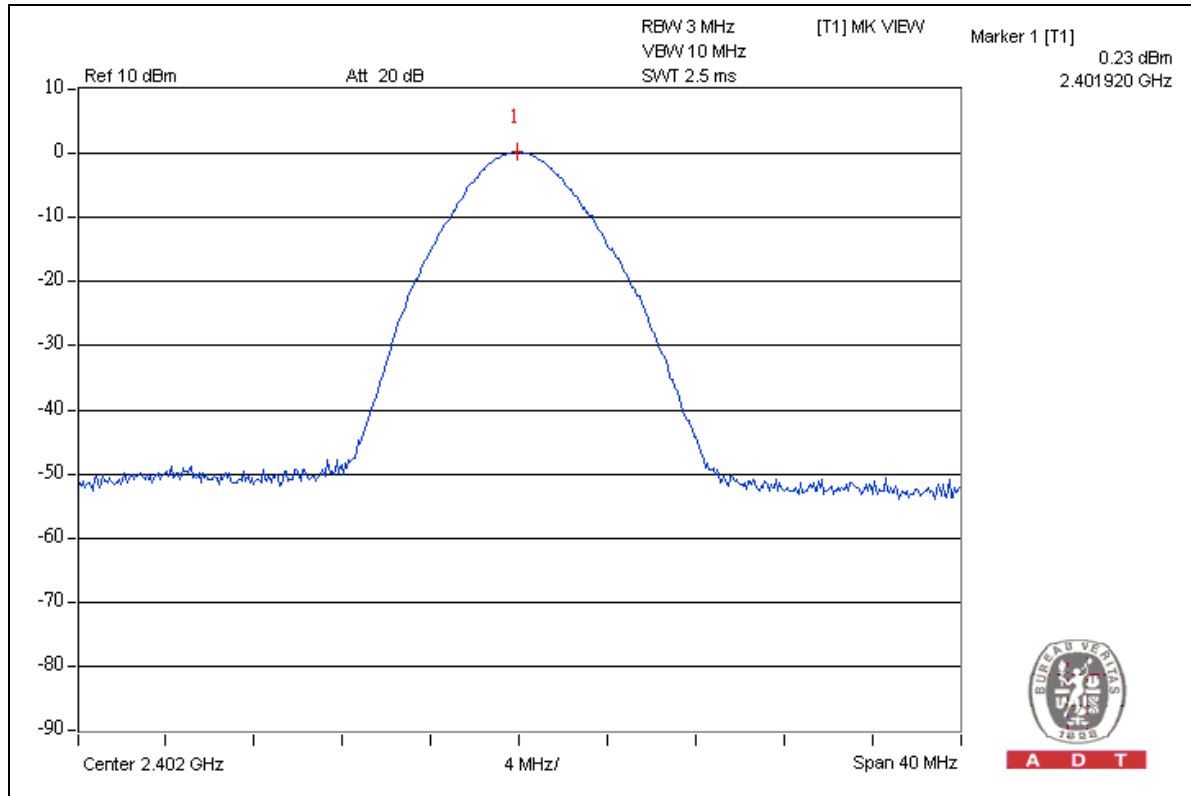

CH 39

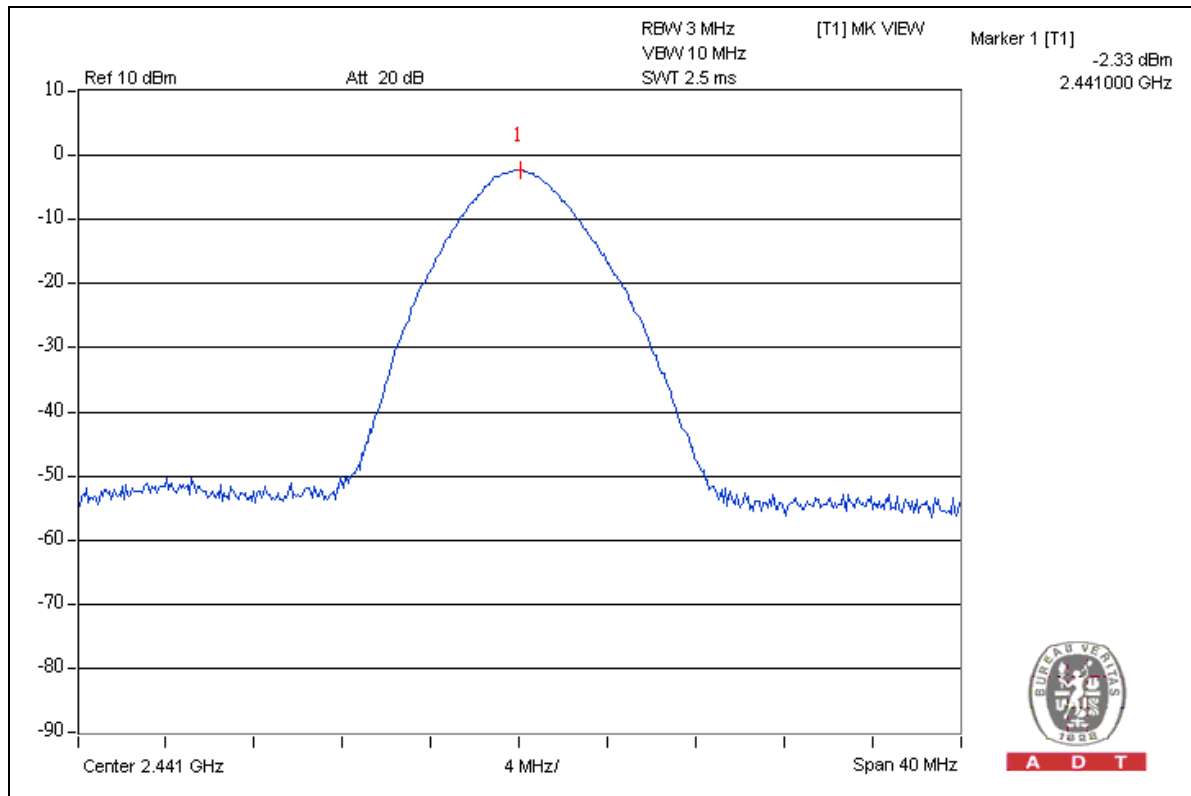



A D T

CH 78

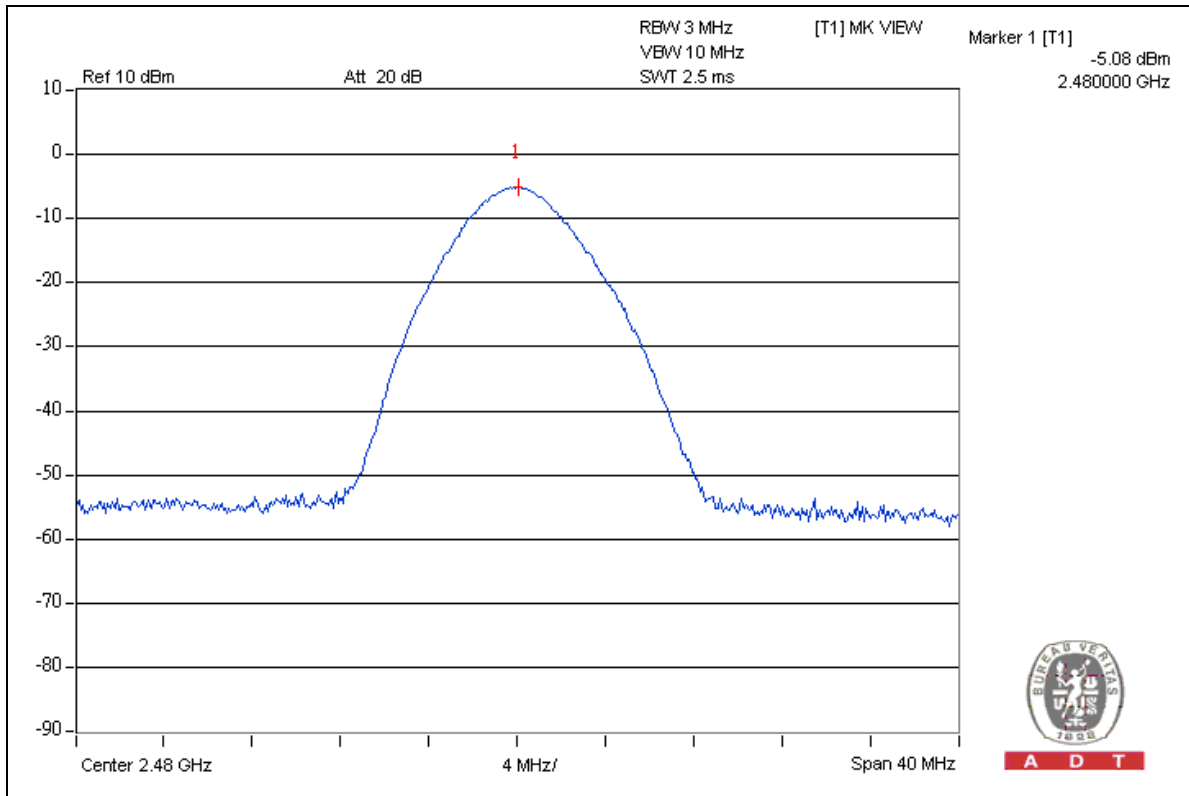

4.8 BAND EDGES MEASUREMENT

4.8.1 LIMITS OF BAND EDGES MEASUREMENT

Below -20dB of the highest emission level of operating band (in 100KHz RBW).

4.8.2 TEST INSTRUMENTS

Description & Manufacturer	Model No.	Serial No.	Calibrated Date	Calibrated Until
SPECTRUM ANALYZER	FSP 40	100036	Apr. 3, 2009	Apr. 2, 2010

NOTE: The calibration interval of the above test instruments is 12 months and the calibrations are traceable to NML/ROC and NIST/USA.

4.8.3 TEST PROCEDURE

The transmitter output was connected to the spectrum analyzer via a low lose cable. Set both RBW and VBW of spectrum analyzer to 100 kHz and 300 kHz with suitable frequency span including 100 MHz bandwidth from band edge. The band edges was measured and recorded.

The spectrum plots are attached on the following pages.

4.8.4 DEVIATION FROM TEST STANDARD

No deviation.

4.8.5 EUT OPERATING CONDITION

The software provided by client enabled the EUT to transmit and receive data at lowest, middle and highest channel frequencies individually.

4.8.6 TEST RESULTS

The spectrum plots are attached on the following 4 images. D1 line indicates the highest level, D2 line indicates the 20dB offset below D1. It shows compliance with the requirement in part 15.247(d).

Mode A: FOR GFSK

NOTE 1:

The band edge emission plot on the next page shows 60.05dBc between carrier maximum power and local maximum emission in restrict band (2.3762GHz). The emission of carrier strength list in the test result of channel 0 at the item 4.2.7 is 107.15dBuV/m (Peak), so the maximum field strength in restrict band is $107.15 - 60.05 = 47.1$ dBuV/m, which is under 74 dBuV/m limit.

Average value = $47.1 - 30.1 = 17$ dBuV/m, which is under 54dBuV/m limit.

*The DH5 packet was the worse case duty cycle for a transmit dwell time on a channel, based upon bluetooth theory the transmitter is on $0.625 * 5$ per 296.25 ms per channel. Therefore, the duty cycle be equal to: $20\log(3.125/100) = -30.1$ dB.

Average value = peak reading -30.10 .

NOTE 2:

The band edge emission plot on the next second page shows 46.01dBc between carrier maximum power and local maximum emission in restrict band (2.4844GHz). The emission of carrier strength list in the test result of channel 78 at the item 4.2.7 is 105.03dBuV/m (Peak), so the maximum field strength in restrict band is $105.03 - 46.01 = 59.02$ dBuV/m, which is under 74 dBuV/m limit.

Average value = $59.02 - 30.1 = 28.92$ dBuV/m, which is under 54dBuV/m limit.

*The DH5 packet was the worse case duty cycle for a transmit dwell time on a channel, based upon bluetooth theory the transmitter is on $0.625 * 5$ per 296.25 ms per channel. Therefore, the duty cycle be equal to: $20\log(3.125/100) = -30.1$ dB.

Average value = peak reading -30.10 .



A D T

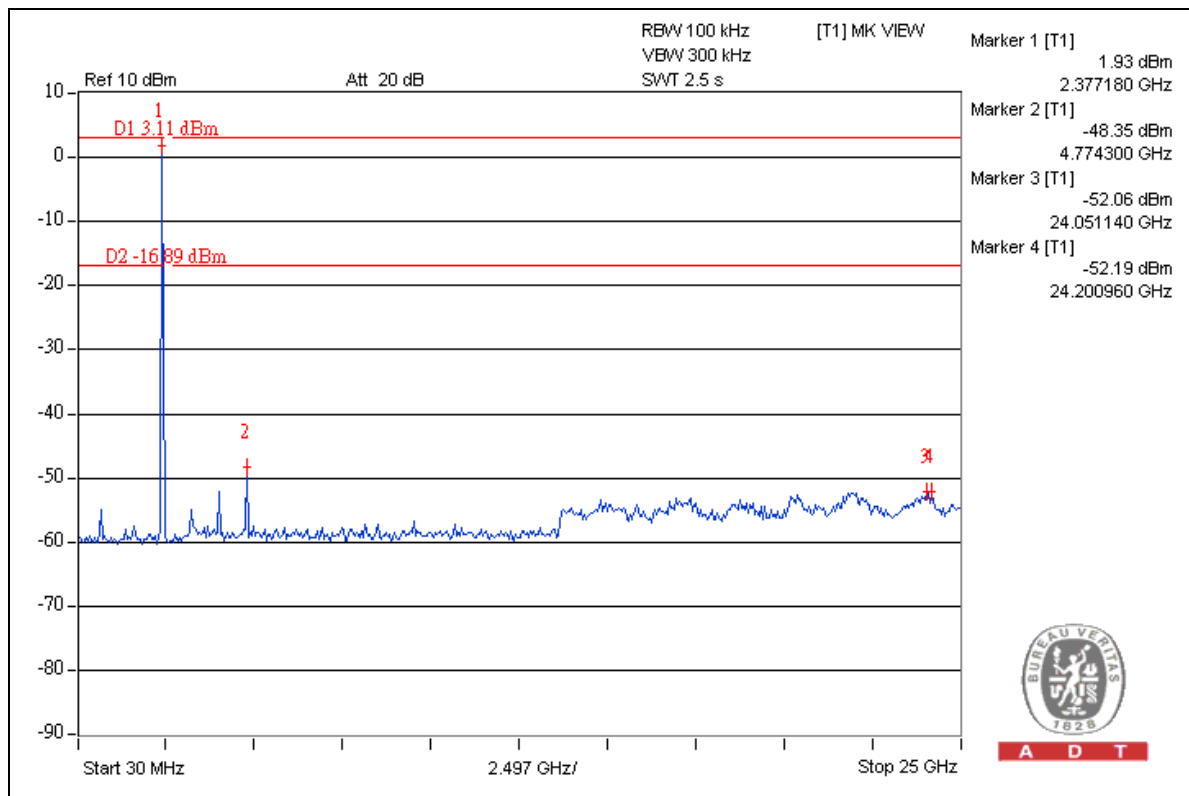
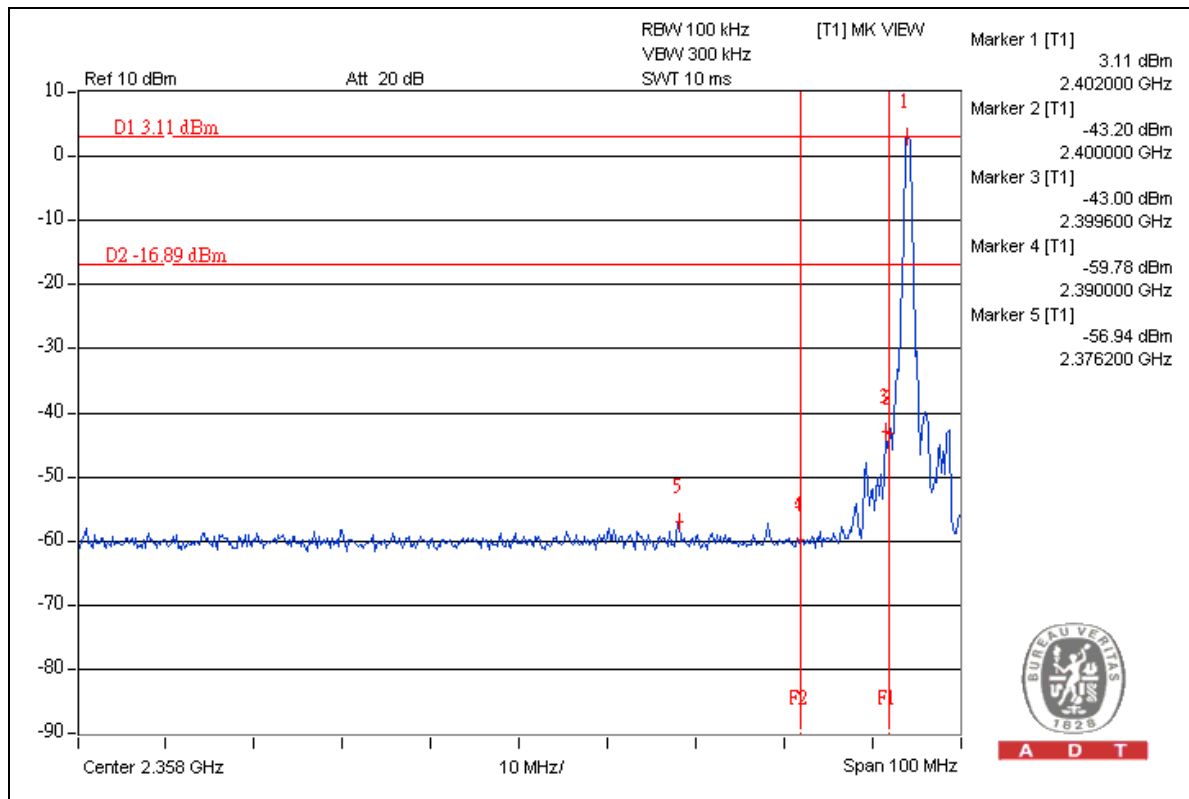



A D T

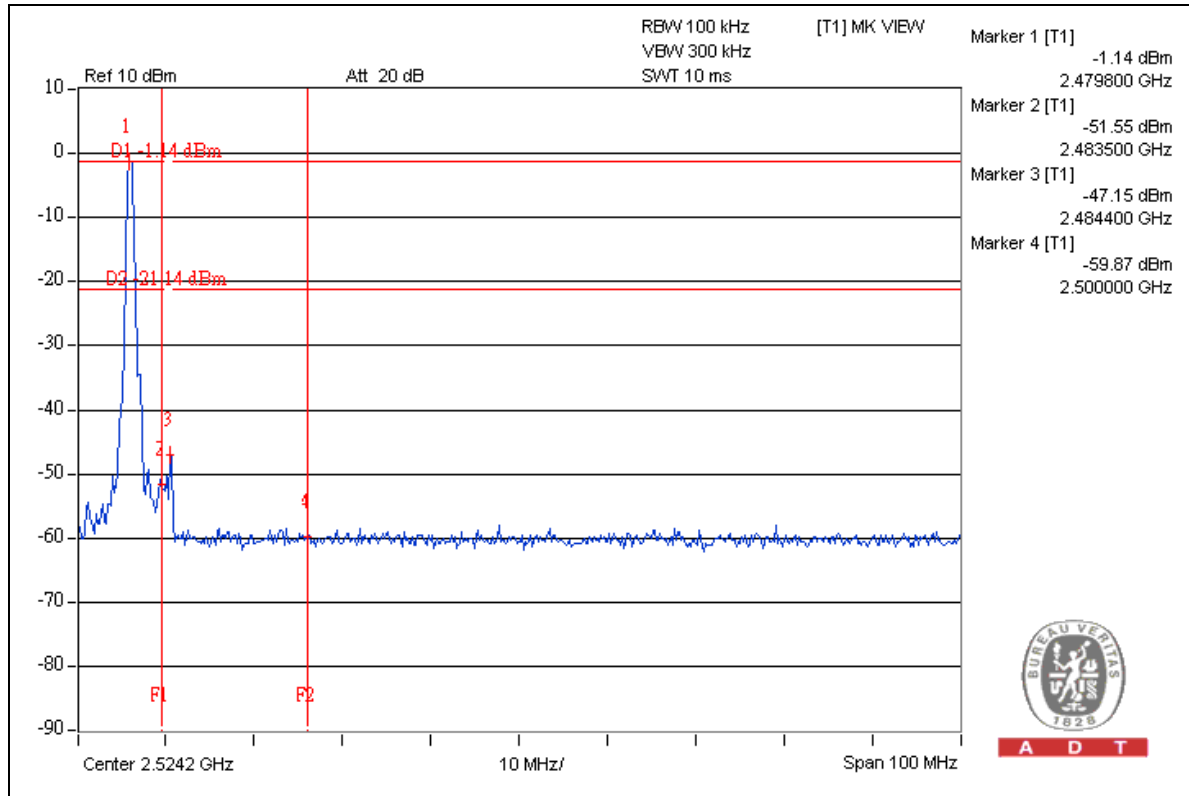

A D T

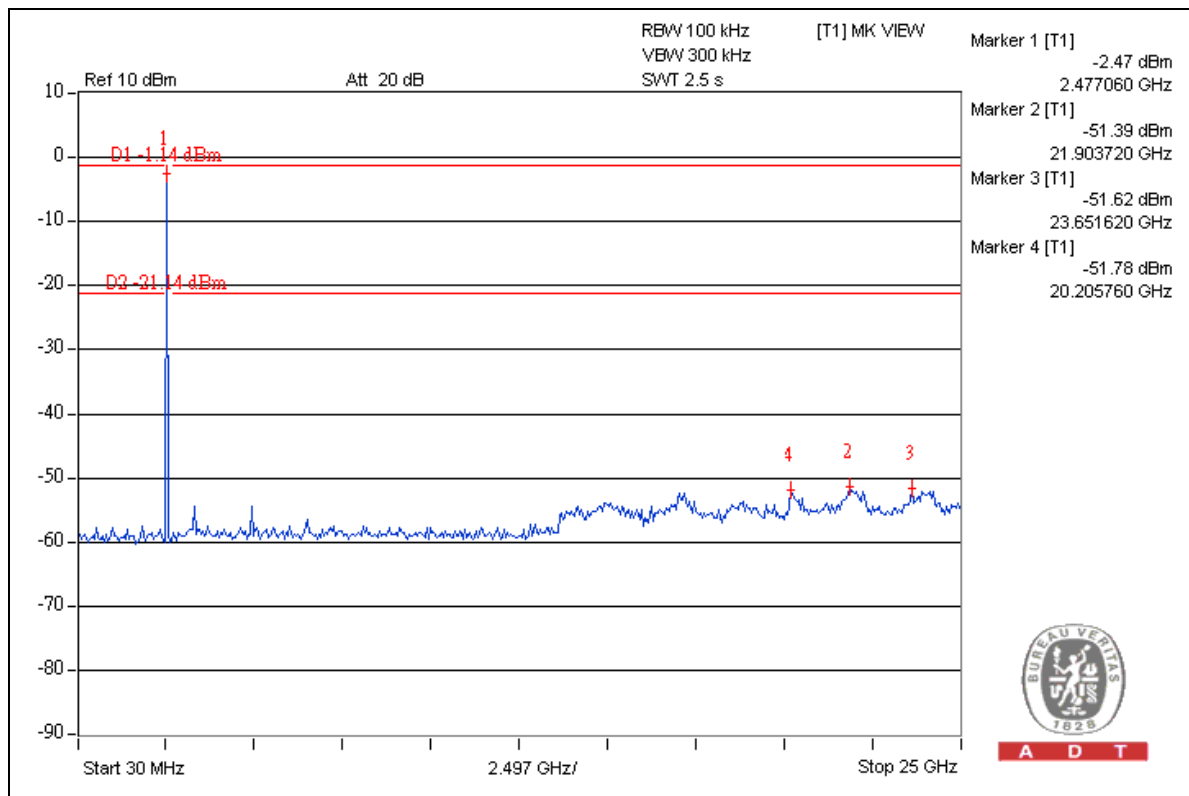

A D T

Mode A: FOR 8DPSK

NOTE 1:

The band edge emission plot on the next page shows 57.08dBc between carrier maximum power and local maximum emission in restrict band (2.3400GHz). The emission of carrier strength list in the test result of channel 0 at the item 4.2.7 is 101.51dBuV/m (Peak), so the maximum field strength in restrict band is $101.51 - 57.08 = 44.43$ dBuV/m, which is under 74 dBuV/m limit.

Average value = $44.43 - 30.10 = 14.33$ dBuV/m, which is under 54dBuV/m limit.

*The DH5 packet was the worse case duty cycle for a transmit dwell time on a channel, based upon bluetooth theory the transmitter is on $0.625 * 5$ per 296.25 ms per channel. Therefore, the duty cycle be equal to: $20\log(3.125/100) = -30.1$ dB.

Average value = peak reading -30.10 .

NOTE 2:

The band edge emission plot on the next second page shows 48.26dBc between carrier maximum power and local maximum emission in restrict band (2.4835GHz). The emission of carrier strength list in the test result of channel 78 at the item 4.2.7 is 97.96dBuV/m (Peak), so the maximum field strength in restrict band is $97.96 - 48.26 = 49.7$ dBuV/m, which is under 74 dBuV/m limit.

Average value = $49.7 - 30.10 = 19.6$ dBuV/m, which is under 54dBuV/m limit.

*The DH5 packet was the worse case duty cycle for a transmit dwell time on a channel, based upon bluetooth theory the transmitter is on $0.625 * 5$ per 296.25 ms per channel. Therefore, the duty cycle be equal to: $20\log(3.125/100) = -30.1$ dB.

Average value = peak reading -30.10 .



A D T

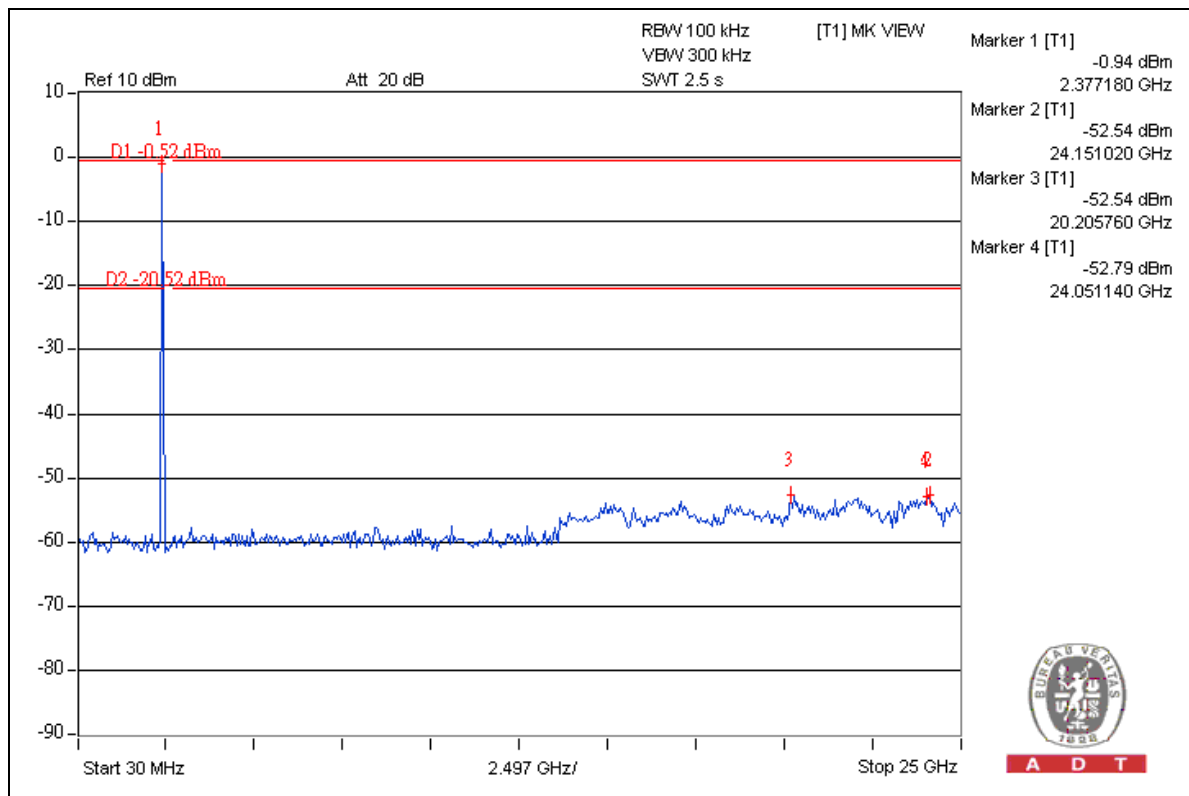
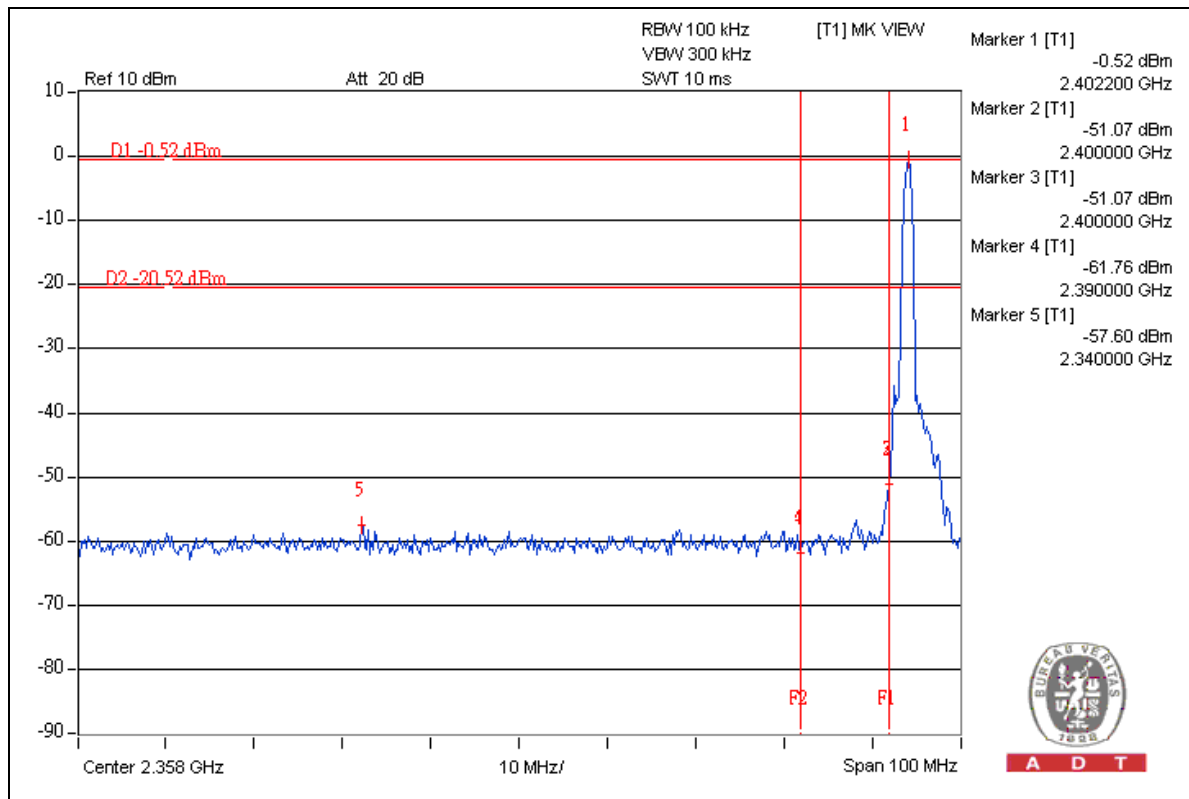



A D T

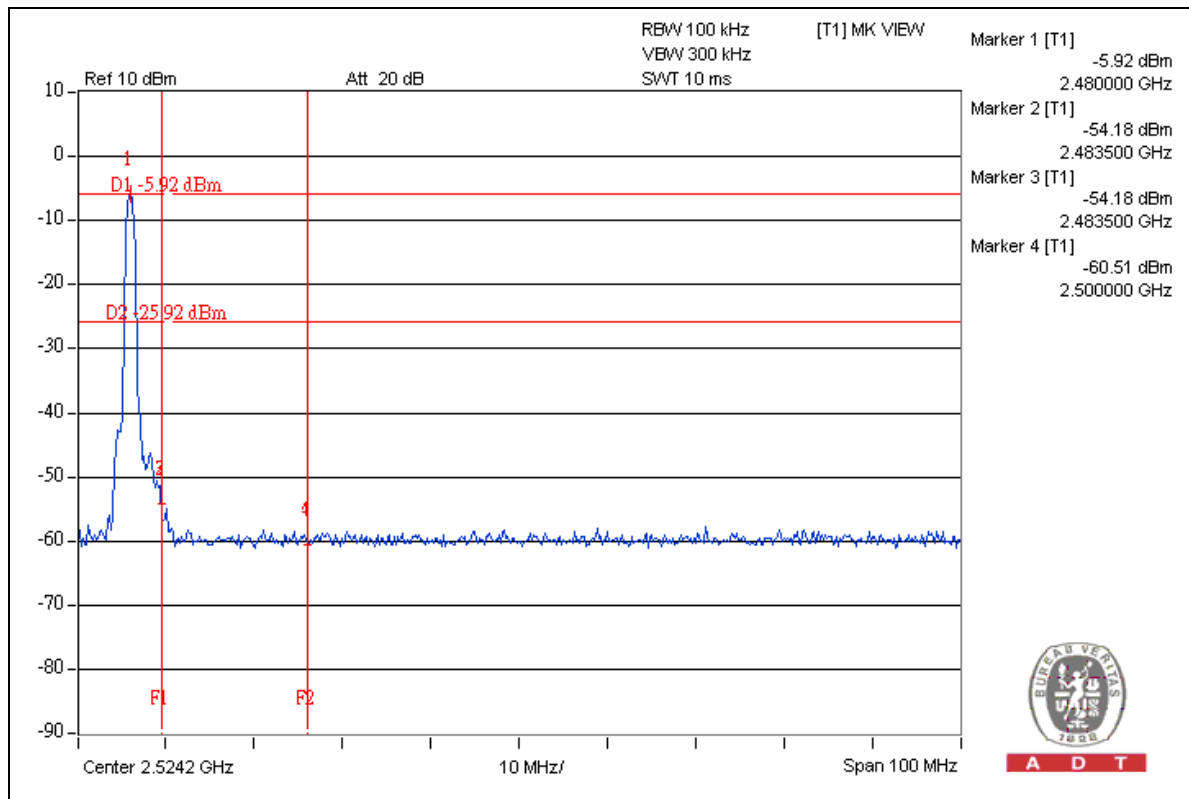

A D T

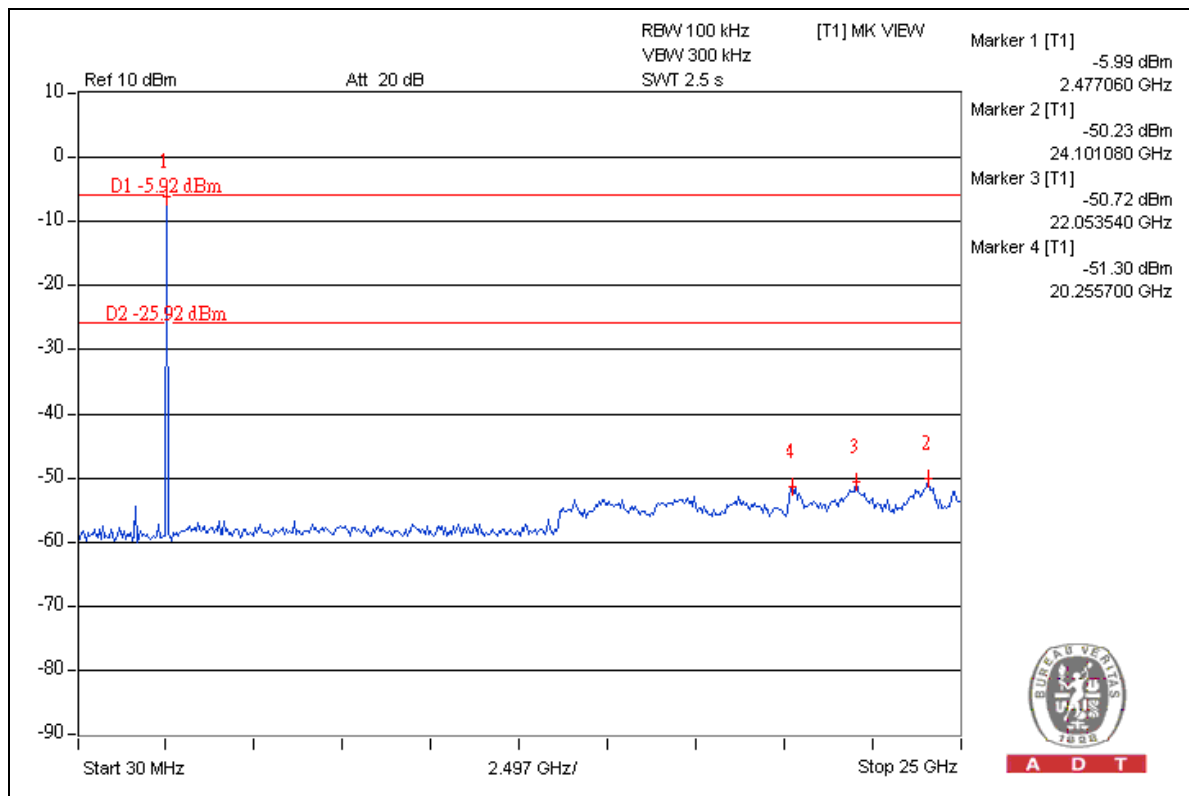

A D T

4.9 ANTENNA REQUIREMENT

4.9.1 STANDARD APPLICABLE

For intentional device, according to FCC 47 CFR Section 15.203, an intentional radiator shall be designed to ensure that no antenna other than that furnished by the responsible party shall be used with the device.

And according to FCC 47 CFR Section 15.247 (b), if transmitting antennas of directional gain greater than 6 dBi are used, the power shall be reduced by the amount in dB that the directional gain of the antenna exceeds 6 dBi.

4.9.2 ANTENNA CONNECTED CONSTRUCTION

The antenna used in this product is Printed antenna without antenna connector. The maximum gain of this antenna is 1.03dBi.

5. PHOTOGRAPHS OF THE TEST CONFIGURATION

Please refer to the attached file (Test Setup Photo).

6. INFORMATION ON THE TESTING LABORATORIES

We, Bureau Veritas Consumer Products Services (H.K.) Ltd., Taoyuan Branch, were founded in 1988 to provide our best service in EMC, Radio, Telecom and Safety consultation. Our laboratories are accredited and approved by the following approval agencies according to ISO/IEC 17025.

USA	FCC, NVLAP
Germany	TUV Rheinland
Japan	VCCI
Norway	NEMKO
Canada	INDUSTRY CANADA, CSA
R.O.C.	TAF, BSMI, NCC
Netherlands	Telefication
Singapore	GOST-ASIA(MOU)
Russia	CERTIS(MOU)

Copies of accreditation certificates of our laboratories obtained from approval agencies can be downloaded from our web site: www.adt.com.tw/index.5/phtml.
If you have any comments, please feel free to contact us at the following:

Linko EMC/RF Lab:
Tel: 886-2-26052180
Fax: 886-2-26051924

Hsin Chu EMC/RF Lab:
Tel: 886-3-5935343
Fax: 886-3-5935342

Hwa Ya EMC/RF/Safety Telecom Lab:
Tel: 886-3-3183232
Fax: 886-3-3185050

Web Site: www.adt.com.tw

The address and road map of all our labs can be found in our web site also.



A D T

7. APPENDIX A – MODIFICATIONS RECORDERS FOR ENGINEERING CHANGES TO THE EUT BY THE LAB

No any modifications are made to the EUT by the lab during the test.

---END---