



A D T

FCC TEST REPORT

REPORT NO.: RF140619D04

MODEL NO.: E2B

FCC ID: EMJSE2B

RECEIVED: Jun. 19, 2014

TESTED: Jul. 15 ~ 30, 2014

ISSUED: Aug. 1, 2014

APPLICANT: PRIMAX ELECTRONICS LTD.

ADDRESS: No. 669, Ruey Kuang Road, Neihu, Taipei, Taiwan,
R.O.C.

ISSUED BY: Bureau Veritas Consumer Products Services (H.K.)
Ltd., Taoyuan Branch

LAB ADDRESS: No. 47, 14th Ling, Chia Pau Vil., Lin Kou Dist., New
Taipei City, Taiwan (R.O.C.)

This report should not be used by the client to claim product certification, approval, or endorsement by TAF or any government agencies.



This report is for your exclusive use. Any copying or replication of this report to or for any other person or entity, or use of our name or trademark, is permitted only with our prior written permission. This report sets forth our findings solely with respect to the test samples identified herein. The results set forth in this report are not indicative or representative of the quality or characteristics of the lot from which a test sample was taken or any similar or identical product unless specifically and expressly noted. Our report includes all of the tests requested by you and the results thereof based upon the information that you provided to us. You have 60 days from date of issuance of this report to notify us of any material error or omission caused by our negligence, provided, however, that such notice shall be in writing and shall specifically address the issue you wish to raise. A failure to raise such issue within the prescribed time shall constitute your unqualified acceptance of the completeness of this report, the tests conducted and the correctness of the report contents. Unless specific mention, the uncertainty of measurement has been explicitly taken into account to declare the compliance or non-compliance to the specification.



A D T

TABLE OF CONTENTS

RELEASE CONTROL RECORD	4
1. CERTIFICATION.....	5
2. SUMMARY OF TEST RESULTS	6
2.1 MEASUREMENT UNCERTAINTY	6
3. GENERAL INFORMATION	7
3.1 GENERAL DESCRIPTION OF EUT	7
3.2 DESCRIPTION OF TEST MODES	9
3.2.1 TEST MODE APPLICABILITY AND TESTED CHANNEL DETAIL.....	10
3.3 DUTY CYCLE OF TEST SIGNAL	12
3.4 DESCRIPTION OF SUPPORT UNITS	13
3.4.1 CONFIGURATION OF SYSTEM UNDER TEST.....	13
3.5 GENERAL DESCRIPTION OF APPLIED STANDARDS.....	14
4. TEST TYPES AND RESULTS	15
4.1 RADIATED EMISSION AND BANDEDGE MEASUREMENT	15
4.1.1 LIMITS OF RADIATED EMISSION AND BANDEDGE MEASUREMENT	15
4.1.2 TEST INSTRUMENTS.....	16
4.1.3 TEST PROCEDURES	17
4.1.4 DEVIATION FROM TEST STANDARD.....	17
4.1.5 TEST SETUP	18
4.1.6 EUT OPERATING CONDITIONS	18
4.1.7 TEST RESULTS	19
4.2 CONDUCTED EMISSION MEASUREMENT.....	29
4.2.1 LIMITS OF CONDUCTED EMISSION MEASUREMENT	29
4.2.2 TEST INSTRUMENTS.....	29
4.2.3 TEST PROCEDURES	30
4.2.4 DEVIATION FROM TEST STANDARD.....	30
4.2.5 TEST SETUP.....	30
4.2.6 EUT OPERATING CONDITIONS	30
4.2.7 TEST RESULTS	31
4.3 6dB BANDWIDTH MEASUREMENT	33
4.3.1 LIMITS OF 6dB BANDWIDTH MEASUREMENT	33
4.3.2 TEST SETUP.....	33
4.3.3 TEST INSTRUMENTS.....	33
4.3.4 TEST PROCEDURE.....	33
4.3.5 DEVIATION FROM TEST STANDARD.....	33
4.3.6 EUT OPERATING CONDITIONS	33



4.3.7	TEST RESULTS	34
4.4	CONDUCTED OUTPUT POWER.....	36
4.4.1	LIMITS OF CONDUCTED OUTPUT POWER MEASUREMENT.....	36
4.4.2	TEST SETUP.....	36
4.4.3	TEST INSTRUMENTS.....	36
4.4.4	TEST PROCEDURES	36
4.4.5	DEVIATION FROM TEST STANDARD.....	36
4.4.6	EUT OPERATING CONDITIONS	36
4.4.7	TEST RESULTS - FOR PEAK POWER.....	37
4.4.8	TEST RESULTS - FOR AVERAGE POWER	38
4.5	POWER SPECTRAL DENSITY MEASUREMENT	39
4.5.1	LIMITS OF POWER SPECTRAL DENSITY MEASUREMENT	39
4.5.2	TEST SETUP.....	39
4.5.3	TEST INSTRUMENTS.....	39
4.5.4	TEST PROCEDURE.....	39
4.5.5	DEVIATION FROM TEST STANDARD.....	39
4.5.6	EUT OPERATING CONDITION.....	39
4.5.7	TEST RESULTS	40
4.6	CONDUCTED OUT OF BAND EMISSION MEASUREMENT	42
4.6.1	LIMITS OF CONDUCTED OUT OF BAND EMISSION MEASUREMENT	42
4.6.2	TEST SETUP.....	42
4.6.3	TEST INSTRUMENTS.....	42
4.6.4	TEST PROCEDURE.....	42
4.6.5	DEVIATION FROM TEST STANDARD.....	43
4.6.6	EUT OPERATING CONDITION.....	43
4.6.7	TEST RESULTS	43
5.	PHOTOGRAPHS OF THE TEST CONFIGURATION	48
6.	INFORMATION ON THE TESTING LABORATORIES.....	49
7.	APPENDIX A – MODIFICATIONS RECORDERS FOR ENGINEERING CHANGES TO THE EUT BY THE LAB.....	50



A D T

RELEASE CONTROL RECORD

ISSUE NO.	REASON FOR CHANGE	DATE ISSUED
RF140619D04	Original release	Aug. 1, 2014



A D T

1. CERTIFICATION

PRODUCT: My Passport Wireless
BRAND NAME: WD
MODEL NO.: E2B
APPLICANT: PRIMAX ELECTRONICS LTD.
TESTED: Jul. 15 ~ 30, 2014
TEST SAMPLE: ENGINEERING SAMPLE
STANDARDS: **FCC Part 15, Subpart C (Section 15.247)**
ANSI C63.10-2009

The above equipment has been tested by **Bureau Veritas Consumer Products Services (H.K.) Ltd., Taoyuan Branch**, and found compliance with the requirement of the above standards. The test record, data evaluation & Equipment Under Test (EUT) configurations represented herein are true and accurate accounts of the measurements of the sample's EMC characteristics under the conditions specified in this report.

PREPARED BY : Annie Chang , **DATE:** Aug. 1, 2014
(Annie Chang / Supervisor)

APPROVED BY : Rex Lai , **DATE:** Aug. 1, 2014
(Rex Lai / Assistant Manager)



2. SUMMARY OF TEST RESULTS

The EUT has been tested according to the following specifications:

APPLIED STANDARD: FCC PART 15, SUBPART C (SECTION 15.247)			
STANDARD SECTION	TEST TYPE	RESULT	REMARK
15.207	AC Power Conducted Emission	PASS	Meet the requirement of limit. Minimum passing margin is -11.88dB at 0.36484MHz.
15.205 & 15.209	Radiated Emissions	PASS	Meet the requirement of limit. Minimum passing margin is -6.3dB at 900.62MHz.
15.247(d)	Band Edge Measurement	PASS	Meet the requirement of limit. Minimum passing margin is -3.8dB at 2483.50MHz.
15.247(d)	Antenna Port Emission	PASS	Meet the requirement of limit.
15.247(a)(2)	6dB bandwidth	PASS	Meet the requirement of limit.
15.247(b)	Conducted power	PASS	Meet the requirement of limit.
15.247(e)	Power Spectral Density	PASS	Meet the requirement of limit.
15.203	Antenna Requirement	PASS	No antenna connector is used.

2.1 MEASUREMENT UNCERTAINTY

Where relevant, the following measurement uncertainty levels have been estimated for tests performed on the EUT as specified in CISPR 16-4-2:

Measurement	Frequency	Uncertainty
Conducted emissions	150kHz~30MHz	3.43 dB
Radiated emissions	30MHz ~ 1GHz	4.00 dB
	Above 1GHz	3.36 dB

This uncertainty represents an expanded uncertainty expressed at approximately the 95% confidence level using a coverage factor of $k = 2$.



3. GENERAL INFORMATION

3.1 GENERAL DESCRIPTION OF EUT

EUT	My Passport Wireless
MODEL NO.	E2B
POWER SUPPLY	3.7Vdc from Battery or 5Vdc from AC Adapter (For Charging only)
MODULATION TYPE	CCK, DQPSK, DBPSK for DSSS 64QAM, 16QAM, QPSK, BPSK for OFDM
MODULATION TECHNOLOGY	DSSS, OFDM
TRANSFER RATE	802.11b:11/ 5.5/ 2/ 1Mbps 802.11g: 54/ 48/ 36/ 24/ 18/ 12/ 9/ 6Mbps 802.11n: up to 144Mbps
OPERATING FREQUENCY	2412 ~ 2462MHz
NUMBER OF CHANNEL	11
OUTPUT POWER	80.2mW
ANTENNA TYPE	Main: Printed antenna with 3.18dBi gain Aux.: Metal antenna with 2.26dBi gain
ANTENNA CONNECTOR	N/A
DATA CABLE	Shielded USB cable (0.45m)
I/O PORTS	Refer to user's manual
ACCESSORY DEVICES	Refer to note as below

NOTE:

1. The EUT consumes power from an AC adapter or a battery, as follows:

Item	Brand	Model No.	Spec.
Adapter	APD	WA-10L05RU	AC I/P: 100-240Vac, 50-60Hz, 0.5A Max. DC O/P: 5Vdc, 2A AC 2 Pin
Battery 1	Future	-	3.7Vdc 3400mAh
Battery 2	Roofer	-	3.7Vdc 3400mAh

2. The EUT incorporates a MIMO function. Physically, the EUT provides two completed transmitters and two receivers.

Modulation Mode	Tx Function	Antenna Type
802.11b	1TX	Printed
802.11g	1TX	
802.11n (20MHz)	2TX	Printed + Metal



A D T

3. The EUT can't transmit under charging/discharging condition.

4. For Radiated Emissions test, following modes were pre-tested:

- ◆ Transmission mode with Battery 1 (EUT only)
- ◆ Transmission mode with Battery 2 (EUT only)
- ◆ Charging mode (EUT + Adapter)

The worst emission level was found when the EUT was tested under **Transmission mode with Battery 1 (EUT only)**, therefore, only its test data was recorded in this report.

5. The above EUT information is declared by manufacturer and for more detailed features description, please refer to the manufacturer's specifications or user's manual.



3.2 DESCRIPTION OF TEST MODES

11 channels are provided for 802.11b, 802.11g and 802.11n (20MHz):

CHANNEL	FREQUENCY	CHANNEL	FREQUENCY
1	2412MHz	7	2442MHz
2	2417MHz	8	2447MHz
3	2422MHz	9	2452MHz
4	2427MHz	10	2457MHz
5	2432MHz	11	2462MHz
6	2437MHz		



3.2.1 TEST MODE APPLICABILITY AND TESTED CHANNEL DETAIL

EUT CONFIGURE MODE	APPLICABLE TO				DESCRIPTION
	RE \geq 1G	RE<1G	PLC	APCM	
A	√	√	-	√	Transmission mode with Battery 1 (EUT only)
B	-	-	√	-	Charging mode (EUT + Adapter)

Where **RE \geq 1G**: Radiated Emission above 1GHz **RE<1G**: Radiated Emission below 1GHz
PLC: Power Line Conducted Emission **APCM**: Antenna Port Conducted Measurement

NOTE: The EUT had been pre-tested on the positioned of 3 axis. The worst case was found when positioned on X-plane.

RADIATED EMISSION TEST (ABOVE 1GHz):

- Pre-Scan has been conducted to determine the worst-case mode from all possible combinations between available modulations, data rates and antenna ports (if EUT with antenna diversity architecture).
- Following channel(s) was (were) selected for the final test as listed below.

EUT CONFIGURE MODE	MODE	AVAILABLE CHANNEL	TESTED CHANNEL	MODULATION TECHNOLOGY	MODULATION TYPE	DATA RATE (Mbps)
A	802.11b	1 to 11	1, 6, 11	DSSS	DBPSK	1
A	802.11g	1 to 11	1, 6, 11	OFDM	BPSK	6
A	802.11n (20MHz)	1 to 11	1, 6, 11	OFDM	BPSK	13

RADIATED EMISSION TEST (BELOW 1GHz):

- Pre-Scan has been conducted to determine the worst-case mode from all possible combinations between available modulations, data rates and antenna ports (if EUT with antenna diversity architecture).
- Following channel(s) was (were) selected for the final test as listed below.

EUT CONFIGURE MODE	MODE	AVAILABLE CHANNEL	TESTED CHANNEL	MODULATION TECHNOLOGY	MODULATION TYPE	DATA RATE (Mbps)
A	802.11n (20MHz)	1 to 11	1	OFDM	BPSK	13

POWER LINE CONDUCTED EMISSION TEST:

- Pre-Scan has been conducted to determine the worst-case mode from all possible combinations between available modulations, data rates and antenna ports (if EUT with antenna diversity architecture).
- Following channel(s) was (were) selected for the final test as listed below.

EUT CONFIGURE MODE	MODE	AVAILABLE CHANNEL	TESTED CHANNEL	MODULATION TECHNOLOGY	MODULATION TYPE	DATA RATE (Mbps)
B	-	-	-	-	-	-



BANDEDGE MEASUREMENT:

- Pre-Scan has been conducted to determine the worst-case mode from all possible combinations between available modulations, data rates and antenna ports (if EUT with antenna diversity architecture).
- Following channel(s) was (were) selected for the final test as listed below.

EUT CONFIGURE MODE	MODE	AVAILABLE CHANNEL	TESTED CHANNEL	MODULATION TECHNOLOGY	MODULATION TYPE	DATA RATE (Mbps)
A	802.11b	1 to 11	1, 11	DSSS	DBPSK	1
A	802.11g	1 to 11	1, 11	OFDM	BPSK	6
A	802.11n (20MHz)	1 to 11	1, 11	OFDM	BPSK	13

ANTENNA PORT CONDUCTED MEASUREMENT:

- This item includes all test value of each mode, but only includes spectrum plot of worst value of each mode.
- Pre-Scan has been conducted to determine the worst-case mode from all possible combinations between available modulations, data rates and antenna ports (if EUT with antenna diversity architecture).
- Following channel(s) was (were) selected for the final test as listed below.

EUT CONFIGURE MODE	MODE	AVAILABLE CHANNEL	TESTED CHANNEL	MODULATION TECHNOLOGY	MODULATION TYPE	DATA RATE (Mbps)
A	802.11b	1 to 11	1, 6, 11	DSSS	DBPSK	1
A	802.11g	1 to 11	1, 6, 11	OFDM	BPSK	6
A	802.11n (20MHz)	1 to 11	1, 6, 11	OFDM	BPSK	13

TEST CONDITION:

APPLICABLE TO	ENVIRONMENTAL CONDITIONS	INPUT POWER	TESTED BY
RE≥1G	24deg. C, 78% RH	3.7Vdc	Aaron You
RE<1G	23deg. C, 66% RH	3.7Vdc	Aaron You
PLC	26deg. C, 67% RH	3.7Vdc	Dalen Dai
APCM	25deg. C, 60%RH	3.7Vdc	Saxon Lee

3.3 DUTY CYCLE OF TEST SIGNAL

Duty cycle is < 98%, duty factor shall be considered.

802.11b: Duty cycle = $8.30/8.66 = 0.958$, Duty factor = $10 * \log(1/0.958) = 0.19$

802.11g: Duty cycle = $1.37/1.65 = 0.830$, Duty factor = $10 * \log(1/0.830) = 0.81$

802.11n (20MHz): Duty cycle = $1.27/1.58 = 0.804$, Duty factor = $10 * \log(1/0.804) = 0.95$

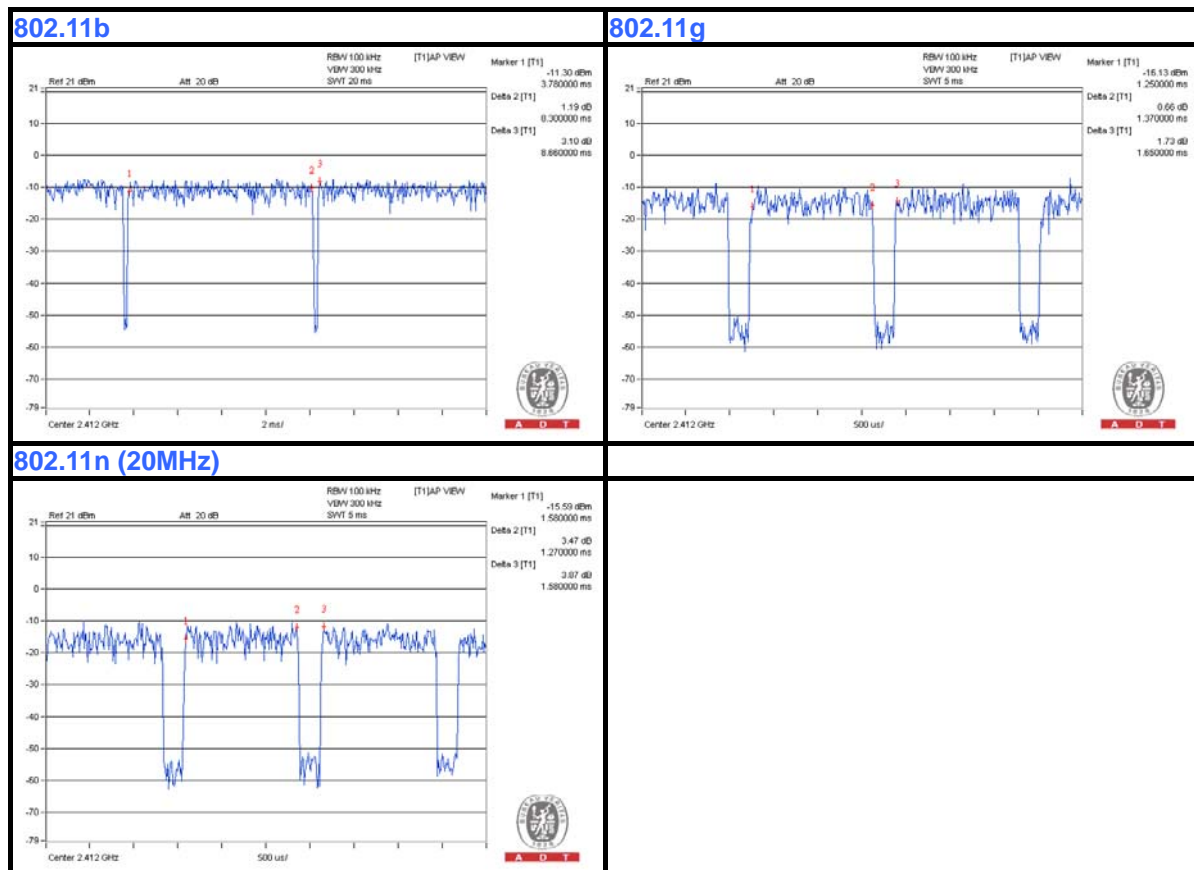

3.4 DESCRIPTION OF SUPPORT UNITS

The EUT has been tested as an independent unit together without other necessary accessories or support units.

3.4.1 CONFIGURATION OF SYSTEM UNDER TEST

Mode A (Transmission mode):

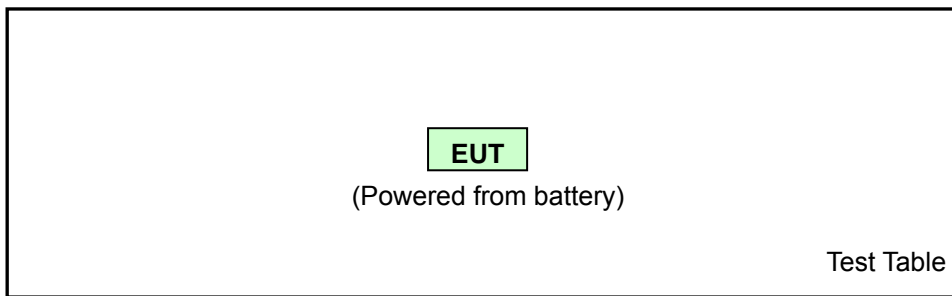

Mode B (Charging Mode):

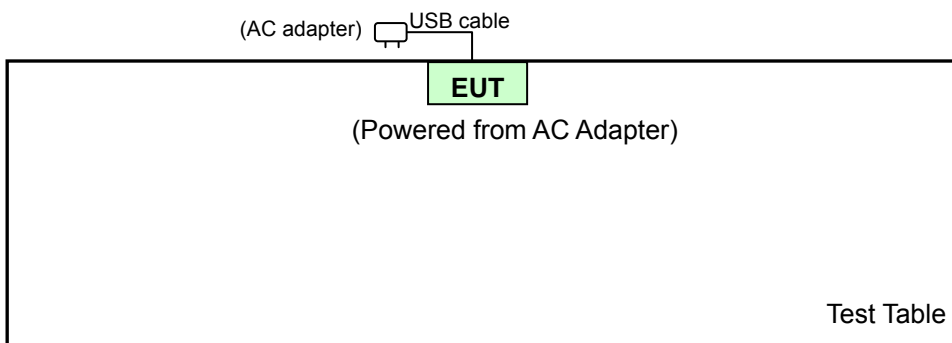



A D T

3.5 GENERAL DESCRIPTION OF APPLIED STANDARDS

The EUT is a RF Product. According to the specifications of the manufacturer, it must comply with the requirements of the following standards:

FCC Part 15, Subpart C (15.247)

558074 D01 DTS Meas Guidance v03r02

662911 D01 Multiple Transmitter Output v02r01

ANSI C63.10-2009

All test items have been performed and recorded as per the above standards.

NOTE: The product has been verified to comply with the requirements of FCC Part 15, Subpart B, Class B (DoC). The test report has been issued separately.



4. TEST TYPES AND RESULTS

4.1 RADIATED EMISSION AND BANDEDGE MEASUREMENT

4.1.1 LIMITS OF RADIATED EMISSION AND BANDEDGE MEASUREMENT

Radiated emissions which fall in the restricted bands must comply with the radiated emission limits specified as below table. Other emissions shall be at least 20dB below the highest level of the desired power:

FREQUENCIES (MHz)	FIELD STRENGTH (microvolts/meter)	MEASUREMENT DISTANCE (meters)
0.009 ~ 0.490	2400/F(kHz)	300
0.490 ~ 1.705	24000/F(kHz)	30
1.705 ~ 30.0	30	30
30 ~ 88	100	3
88 ~ 216	150	3
216 ~ 960	200	3
Above 960	500	3

NOTE:

1. The lower limit shall apply at the transition frequencies.
2. Emission level (dBuV/m) = 20 log Emission level (uV/m).
3. For frequencies above 1000MHz, the field strength limits are based on average detector, however, the peak field strength of any emission shall not exceed the maximum permitted average limits, specified above by more than 20dB under any condition of modulation.



A D T

4.1.2 TEST INSTRUMENTS

DESCRIPTION & MANUFACTURER	MODEL NO.	SERIAL NO.	CALIBRATED DATE	CALIBRATED UNTIL
HP Preamplifier	8447D	2432A03504	Feb. 26, 2014	Feb. 25, 2015
HP Preamplifier	8449B	3008A01201	Feb. 26, 2014	Feb. 25, 2015
Agilent TEST RECEIVER	N9038A	MY51210129	Jan. 18, 2014	Jan. 17, 2015
Schwarzbeck Antenna	VULB 9168	139	Feb. 24, 2014	Feb. 23, 2015
Schwarzbeck Antenna	VHBA 9123	480	May 29, 2013	May 28, 2015
ADT. Turn Table	TT100	0306	NA	NA
ADT. Tower	AT100	0306	NA	NA
Software	ADT_Radiated_V 7.6.15.9.4	NA	NA	NA
SUHNER RF cable	SF102	CABLE-CH6	Aug. 16, 2013	Aug. 15, 2014
EMCO Horn Antenna	3115	00028257	Sep. 27, 2013	Sep. 26, 2014
Highpass filter Wainwright Instruments	WHK 3.1/18G-10SS	SN 8	NA	NA
ROHDE & SCHWARZ Spectrum Analyzer	FSP 40	100036	May 17, 2014	May 16, 2015
Anritsu Power Sensor	MA2411B	0738404	Apr. 21, 2014	Apr. 20, 2015
Anritsu Power Meter	ML2495A	0842014	Apr. 21, 2014	Apr. 20, 2015

- NOTE:** 1. The calibration interval of the above test instruments is 12/24 months. And the calibrations are traceable to NML/ROC and NIST/USA.
 2. The horn antenna and HP preamplifier (model: 8449B) are used only for the measurement of emission frequency above 1GHz if tested.
 3. The test was performed in Chamber No. 6.
 4. The Industry Canada Reference No. IC 7450E-6.
 5. The FCC Site Registration No. is 447212.



A D T

4.1.3 TEST PROCEDURES

- a. The EUT was placed on the top of a rotating table 0.8 meters above the ground at a 3 meters semi-anechoic chamber. The table was rotated 360 degrees to determine the position of the highest radiation.
- b. The EUT was set 3 meters away from the interference-receiving antenna, which was mounted on the top of a variable-height antenna tower.
- c. The antenna is a broadband antenna, and its height is varied from one meter to four meters above the ground to determine the maximum value of the field strength. Both horizontal and vertical polarizations of the antenna are set to make the measurement.
- d. For each suspected emission, the EUT was arranged to its worst case and then the antenna was tuned to heights from 1 meter to 4 meters and the rotatable table was turned from 0 degrees to 360 degrees to find the maximum reading.
- e. The test-receiver system was set to Peak Detect Function and Specified Bandwidth with Maximum Hold Mode.
- f. If the emission level of the EUT in peak mode was lower than the limit specified, then testing could be stopped and the peak values of the EUT would be reported. Otherwise the emissions would be re-tested one by one using peak, quasi-peak or average method as specified and then reported in a data sheet.

NOTE:

1. The resolution bandwidth and video bandwidth of test receiver/spectrum analyzer is 120kHz for Quasi-peak detection at frequency below 1GHz.
2. The resolution bandwidth of test receiver/spectrum analyzer is 1MHz and video bandwidth is 3MHz for Peak detection at frequency above 1GHz.
3. The resolution bandwidth of test receiver/spectrum analyzer is 1MHz and the video bandwidth is $\geq 1/T$ (Duty cycle < 98%) or 10Hz (Duty cycle > 98%) for Average detection (AV) at frequency above 1GHz.
4. All modes of operation were investigated and the worst-case emissions are reported.

4.1.4 DEVIATION FROM TEST STANDARD

No deviation.

4.1.5 TEST SETUP

Frequency range 30MHz~1GHz

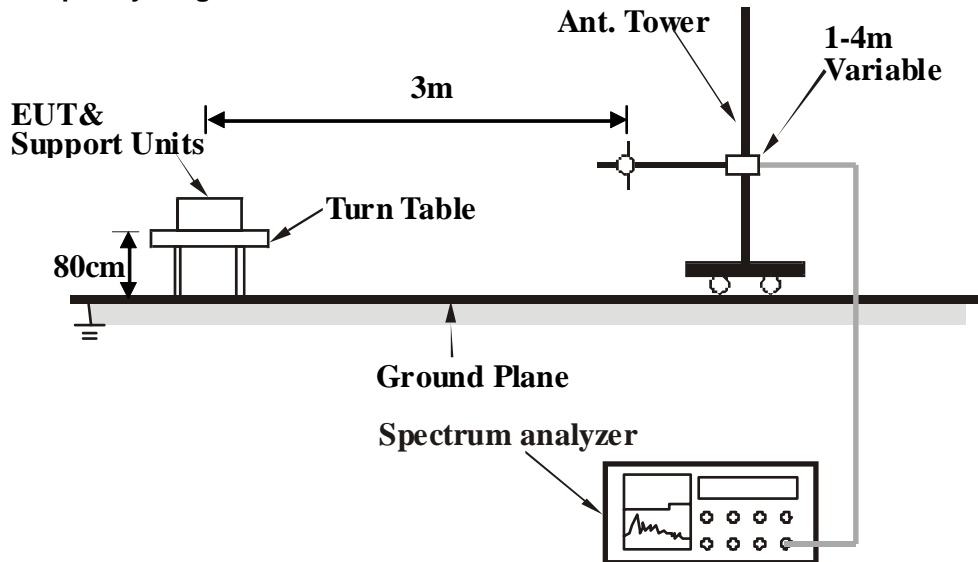

Frequency range above 1GHz

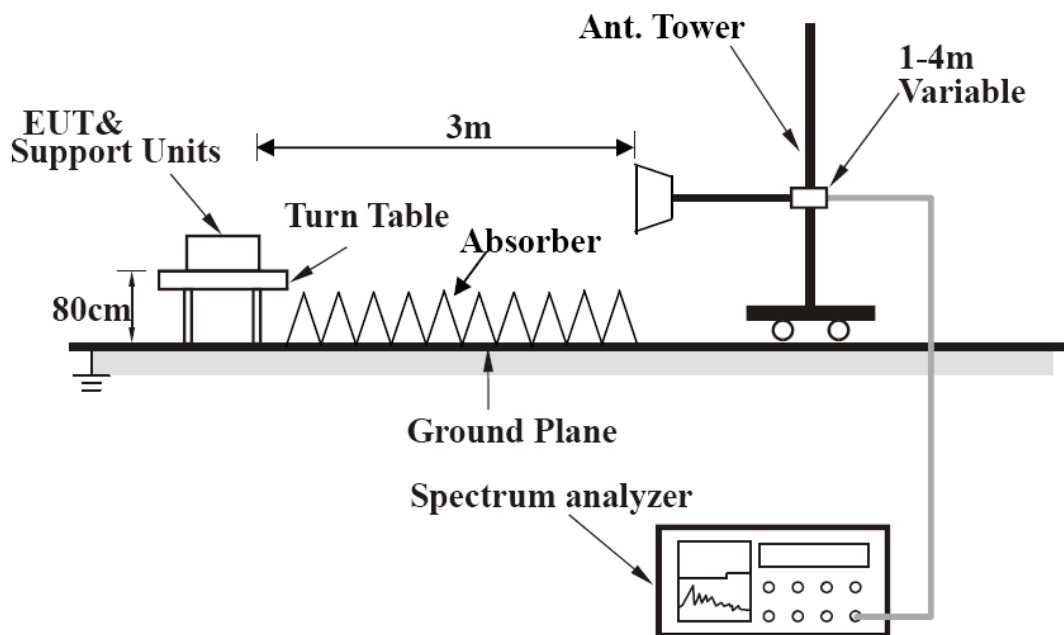

For the actual test configuration, please refer to the attached file (Test Setup Photo).

4.1.6 EUT OPERATING CONDITIONS

- a. Turn on the power of all equipment.
- b. Set the EUT under transmitting condition.



A D T

4.1.7 TEST RESULTS

ABOVE 1GHz DATA

802.11b

CHANNEL	TX Channel 1	DETECTOR FUNCTION	Peak (PK)
FREQUENCY RANGE	1GHz ~ 25GHz		Average (AV)
TEST MODE	A		

ANTENNA POLARITY & TEST DISTANCE: HORIZONTAL AT 3 M								
NO.	FREQ. (MHz)	EMISSION LEVEL (dBuV/m)	LIMIT (dBuV/m)	MARGIN (dB)	ANTENNA HEIGHT (m)	TABLE ANGLE (Degree)	RAW VALUE (dBuV)	CORRECTION FACTOR (dB/m)
1	2390.00	56.5 PK	74.0	-17.5	1.15 H	102	60.12	-3.58
2	2390.00	46.6 AV	54.0	-7.4	1.15 H	102	50.21	-3.58
3	*2412.00	104.6 PK			1.15 H	102	108.11	-3.51
4	*2412.00	99.1 AV			1.15 H	102	102.63	-3.51
5	4824.00	49.1 PK	74.0	-24.9	1.34 H	155	45.09	4.02
6	4824.00	36.0 AV	54.0	-18.0	1.34 H	155	32.01	4.02
ANTENNA POLARITY & TEST DISTANCE: VERTICAL AT 3 M								
NO.	FREQ. (MHz)	EMISSION LEVEL (dBuV/m)	LIMIT (dBuV/m)	MARGIN (dB)	ANTENNA HEIGHT (m)	TABLE ANGLE (Degree)	RAW VALUE (dBuV)	CORRECTION FACTOR (dB/m)
1	2390.00	53.4 PK	74.0	-20.6	1.02 V	12	57.01	-3.58
2	2390.00	40.8 AV	54.0	-13.3	1.02 V	12	44.33	-3.58
3	*2412.00	97.9 PK			1.02 V	12	101.40	-3.51
4	*2412.00	93.1 AV			1.02 V	12	96.57	-3.51
5	4824.00	43.3 PK	74.0	-30.7	1.10 V	167	39.27	4.02
6	4824.00	34.1 AV	54.0	-19.9	1.10 V	167	30.11	4.02

REMARKS:

1. Emission Level(dBuV/m) = Raw Value(dBuV) + Correction Factor(dB/m)
2. Correction Factor(dB/m) = Antenna Factor(dB/m) + Cable Factor(dB) – Pre-Amplifier Factor(dB)
3. The other emission levels were very low against the limit.
4. Margin value = Emission Level – Limit value
5. " * ": Fundamental frequency.



A D T

CHANNEL	TX Channel 6	DETECTOR FUNCTION	Peak (PK)
FREQUENCY RANGE	1GHz ~ 25GHz		Average (AV)
TEST MODE	A		

ANTENNA POLARITY & TEST DISTANCE: HORIZONTAL AT 3 M								
NO.	FREQ. (MHz)	EMISSION LEVEL (dBuV/m)	LIMIT (dBuV/m)	MARGIN (dB)	ANTENNA HEIGHT (m)	TABLE ANGLE (Degree)	RAW VALUE (dBuV)	CORRECTION FACTOR (dB/m)
1	*2437.00	105.2 PK			1.00 H	296	108.66	-3.43
2	*2437.00	100.3 AV			1.00 H	296	103.70	-3.43
3	4874.00	44.8 PK	74.0	-29.3	1.03 H	177	40.48	4.27
4	4874.00	30.1 AV	54.0	-23.9	1.03 H	177	25.80	4.27

ANTENNA POLARITY & TEST DISTANCE: VERTICAL AT 3 M								
NO.	FREQ. (MHz)	EMISSION LEVEL (dBuV/m)	LIMIT (dBuV/m)	MARGIN (dB)	ANTENNA HEIGHT (m)	TABLE ANGLE (Degree)	RAW VALUE (dBuV)	CORRECTION FACTOR (dB/m)
1	*2437.00	98.7 PK			1.33 V	14	102.12	-3.43
2	*2437.00	93.1 AV			1.33 V	14	96.53	-3.43
3	4874.00	42.6 PK	74.0	-31.4	1.00 V	134	38.36	4.27
4	4874.00	28.6 AV	54.0	-25.4	1.00 V	134	24.32	4.27

REMARKS:

1. Emission Level(dBuV/m) = Raw Value(dBuV) + Correction Factor(dB/m)
2. Correction Factor(dB/m) = Antenna Factor(dB/m) + Cable Factor(dB) – Pre-Amplifier Factor(dB)
3. The other emission levels were very low against the limit.
4. Margin value = Emission Level – Limit value
5. " * ": Fundamental frequency.



A D T

CHANNEL	TX Channel 11	DETECTOR FUNCTION	Peak (PK)
FREQUENCY RANGE	1GHz ~ 25GHz		Average (AV)
TEST MODE	A		

ANTENNA POLARITY & TEST DISTANCE: HORIZONTAL AT 3 M

NO.	FREQ. (MHz)	EMISSION LEVEL (dBuV/m)	LIMIT (dBuV/m)	MARGIN (dB)	ANTENNA HEIGHT (m)	TABLE ANGLE (Degree)	RAW VALUE (dBuV)	CORRECTION FACTOR (dB/m)
1	*2462.00	106.1 PK			1.07 H	342	109.46	-3.36
2	*2462.00	99.8 AV			1.07 H	342	103.15	-3.36
3	2483.50	55.2 PK	74.0	-18.8	1.07 H	342	58.46	-3.30
4	2483.50	42.6 AV	54.0	-11.4	1.07 H	342	45.86	-3.30
5	4924.00	48.6 PK	74.0	-25.5	1.58 H	218	44.05	4.50
6	4924.00	34.3 AV	54.0	-19.7	1.58 H	218	29.83	4.50

ANTENNA POLARITY & TEST DISTANCE: VERTICAL AT 3 M

NO.	FREQ. (MHz)	EMISSION LEVEL (dBuV/m)	LIMIT (dBuV/m)	MARGIN (dB)	ANTENNA HEIGHT (m)	TABLE ANGLE (Degree)	RAW VALUE (dBuV)	CORRECTION FACTOR (dB/m)
1	*2462.00	98.4 PK			1.28 V	360	101.76	-3.36
2	*2462.00	93.0 AV			1.28 V	360	96.36	-3.36
3	2483.50	53.8 PK	74.0	-20.3	1.28 V	360	57.05	-3.30
4	2483.50	39.5 AV	54.0	-14.5	1.28 V	360	42.81	-3.30
5	4924.00	49.3 PK	74.0	-24.7	1.17 V	74	44.81	4.45
6	4924.00	34.2 AV	54.0	-19.8	1.17 V	74	29.71	4.45

REMARKS:

1. Emission Level(dBuV/m) = Raw Value(dBuV) + Correction Factor(dB/m)
2. Correction Factor(dB/m) = Antenna Factor(dB/m) + Cable Factor(dB) – Pre-Amplifier Factor(dB)
3. The other emission levels were very low against the limit.
4. Margin value = Emission Level – Limit value
5. " * ": Fundamental frequency.



A D T

802.11g

CHANNEL	TX Channel 1	DETECTOR FUNCTION	Peak (PK)
FREQUENCY RANGE	1GHz ~ 25GHz		Average (AV)
TEST MODE	A		

ANTENNA POLARITY & TEST DISTANCE: HORIZONTAL AT 3 M								
NO.	FREQ. (MHz)	EMISSION LEVEL (dBuV/m)	LIMIT (dBuV/m)	MARGIN (dB)	ANTENNA HEIGHT (m)	TABLE ANGLE (Degree)	RAW VALUE (dBuV)	CORRECTION FACTOR (dB/m)
1	2390.00	68.8 PK	74.0	-5.2	1.02 H	62	72.42	-3.58
2	2390.00	45.4 AV	54.0	-8.6	1.02 H	62	49.02	-3.58
3	*2412.00	105.4 PK			1.02 H	62	108.88	-3.51
4	*2412.00	85.5 AV			1.02 H	62	89.03	-3.51
5	4824.00	45.5 PK	74.0	-28.5	1.04 H	186	41.52	4.02
6	4824.00	32.8 AV	54.0	-21.2	1.04 H	186	28.77	4.02

ANTENNA POLARITY & TEST DISTANCE: VERTICAL AT 3 M								
NO.	FREQ. (MHz)	EMISSION LEVEL (dBuV/m)	LIMIT (dBuV/m)	MARGIN (dB)	ANTENNA HEIGHT (m)	TABLE ANGLE (Degree)	RAW VALUE (dBuV)	CORRECTION FACTOR (dB/m)
1	2390.00	69.3 PK	74.0	-4.8	1.02 V	339	72.83	-3.58
2	2390.00	45.3 AV	54.0	-8.7	1.02 V	339	48.88	-3.58
3	*2412.00	104.4 PK			1.02 V	339	107.87	-3.51
4	*2412.00	85.8 AV			1.02 V	339	89.35	-3.51
5	4824.00	45.7 PK	74.0	-28.3	1.12 V	247	41.66	4.02
6	4824.00	34.1 AV	54.0	-19.9	1.12 V	247	30.11	4.02

REMARKS:

1. Emission Level(dBuV/m) = Raw Value(dBuV) + Correction Factor(dB/m)
2. Correction Factor(dB/m) = Antenna Factor(dB/m) + Cable Factor(dB) – Pre-Amplifier Factor(dB)
3. The other emission levels were very low against the limit.
4. Margin value = Emission Level – Limit value
5. " * ": Fundamental frequency.



A D T

CHANNEL	TX Channel 6	DETECTOR FUNCTION	Peak (PK)
FREQUENCY RANGE	1GHz ~ 25GHz		Average (AV)
TEST MODE	A		

ANTENNA POLARITY & TEST DISTANCE: HORIZONTAL AT 3 M								
NO.	FREQ. (MHz)	EMISSION LEVEL (dBuV/m)	LIMIT (dBuV/m)	MARGIN (dB)	ANTENNA HEIGHT (m)	TABLE ANGLE (Degree)	RAW VALUE (dBuV)	CORRECTION FACTOR (dB/m)
1	*2437.00	108.0 PK			1.00 H	59	111.38	-3.43
2	*2437.00	89.1 AV			1.00 H	59	92.50	-3.43
3	4874.00	45.6 PK	74.0	-28.4	1.06 H	157	41.33	4.27
4	4874.00	32.1 AV	54.0	-21.9	1.06 H	157	27.84	4.27

ANTENNA POLARITY & TEST DISTANCE: VERTICAL AT 3 M								
NO.	FREQ. (MHz)	EMISSION LEVEL (dBuV/m)	LIMIT (dBuV/m)	MARGIN (dB)	ANTENNA HEIGHT (m)	TABLE ANGLE (Degree)	RAW VALUE (dBuV)	CORRECTION FACTOR (dB/m)
1	*2437.00	101.1 PK			1.01 V	7	104.57	-3.43
2	*2437.00	82.5 AV			1.01 V	7	85.89	-3.43
3	4874.00	46.4 PK	74.0	-27.6	1.10 V	96	42.11	4.27
4	4874.00	31.3 AV	54.0	-22.7	1.10 V	96	27.01	4.27

REMARKS:

1. Emission Level(dBuV/m) = Raw Value(dBuV) + Correction Factor(dB/m)
2. Correction Factor(dB/m) = Antenna Factor(dB/m) + Cable Factor(dB) – Pre-Amplifier Factor(dB)
3. The other emission levels were very low against the limit.
4. Margin value = Emission Level – Limit value
5. " * ": Fundamental frequency.



A D T

CHANNEL	TX Channel 11	DETECTOR FUNCTION	Peak (PK)
FREQUENCY RANGE	1GHz ~ 25GHz		Average (AV)
TEST MODE	A		

ANTENNA POLARITY & TEST DISTANCE: HORIZONTAL AT 3 M

NO.	FREQ. (MHz)	EMISSION LEVEL (dBuV/m)	LIMIT (dBuV/m)	MARGIN (dB)	ANTENNA HEIGHT (m)	TABLE ANGLE (Degree)	RAW VALUE (dBuV)	CORRECTION FACTOR (dB/m)
1	*2462.00	105.1 PK			1.00 H	334	108.42	-3.36
2	*2462.00	86.9 AV			1.00 H	334	90.27	-3.36
3	2483.50	70.3 PK	74.0	-3.8	1.00 H	334	73.55	-3.30
4	2483.50	44.2 AV	54.0	-9.8	1.00 H	334	47.50	-3.30
5	4924.00	46.2 PK	74.0	-27.8	1.12 H	284	41.66	4.50
6	4924.00	31.3 AV	54.0	-22.7	1.12 H	284	26.77	4.50

ANTENNA POLARITY & TEST DISTANCE: VERTICAL AT 3 M

NO.	FREQ. (MHz)	EMISSION LEVEL (dBuV/m)	LIMIT (dBuV/m)	MARGIN (dB)	ANTENNA HEIGHT (m)	TABLE ANGLE (Degree)	RAW VALUE (dBuV)	CORRECTION FACTOR (dB/m)
1	*2462.00	100.9 PK			1.30 V	8	104.29	-3.36
2	*2462.00	82.5 AV			1.30 V	8	85.89	-3.36
3	2483.50	69.9 PK	74.0	-4.1	1.30 V	8	73.20	-3.30
4	2483.50	45.2 AV	54.0	-8.8	1.30 V	8	48.46	-3.30
5	4924.00	46.0 PK	74.0	-28.0	1.08 V	309	41.48	4.50
6	4924.00	31.2 AV	54.0	-22.8	1.08 V	309	26.71	4.50

REMARKS:

1. Emission Level(dBuV/m) = Raw Value(dBuV) + Correction Factor(dB/m)
2. Correction Factor(dB/m) = Antenna Factor(dB/m) + Cable Factor(dB) – Pre-Amplifier Factor(dB)
3. The other emission levels were very low against the limit.
4. Margin value = Emission Level – Limit value
5. " * " : Fundamental frequency.



A D T

802.11n (20MHz)

CHANNEL	TX Channel 1	DETECTOR FUNCTION	Peak (PK)
FREQUENCY RANGE	1GHz ~ 25GHz		Average (AV)
TEST MODE	A		

ANTENNA POLARITY & TEST DISTANCE: HORIZONTAL AT 3 M								
NO.	FREQ. (MHz)	EMISSION LEVEL (dBuV/m)	LIMIT (dBuV/m)	MARGIN (dB)	ANTENNA HEIGHT (m)	TABLE ANGLE (Degree)	RAW VALUE (dBuV)	CORRECTION FACTOR (dB/m)
1	2390.00	69.3 PK	74.0	-4.7	1.01 H	63	72.92	-3.58
2	2390.00	44.1 AV	54.0	-9.9	1.01 H	63	47.69	-3.58
3	*2412.00	107.3 PK			1.01 H	63	110.85	-3.51
4	*2412.00	80.2 AV			1.01 H	63	83.75	-3.51
5	4824.00	47.3 PK	74.0	-26.7	1.10 H	247	43.29	4.02
6	4824.00	32.1 AV	54.0	-21.9	1.10 H	247	28.05	4.02

ANTENNA POLARITY & TEST DISTANCE: VERTICAL AT 3 M								
NO.	FREQ. (MHz)	EMISSION LEVEL (dBuV/m)	LIMIT (dBuV/m)	MARGIN (dB)	ANTENNA HEIGHT (m)	TABLE ANGLE (Degree)	RAW VALUE (dBuV)	CORRECTION FACTOR (dB/m)
1	2390.00	59.1 PK	74.0	-14.9	1.25 V	341	62.68	-3.58
2	2390.00	39.9 AV	54.0	-14.1	1.25 V	341	43.45	-3.58
3	*2412.00	96.4 PK			1.25 V	341	99.88	-3.51
4	*2412.00	92.4 AV			1.25 V	341	95.92	-3.51
5	4824.00	47.2 PK	74.0	-26.8	1.07 V	206	43.19	4.02
6	4824.00	32.0 AV	54.0	-22.0	1.07 V	206	28.01	4.02

REMARKS:

1. Emission Level(dBuV/m) = Raw Value(dBuV) + Correction Factor(dB/m)
2. Correction Factor(dB/m) = Antenna Factor(dB/m) + Cable Factor(dB) – Pre-Amplifier Factor(dB)
3. The other emission levels were very low against the limit.
4. Margin value = Emission Level – Limit value
5. " * ": Fundamental frequency.



A D T

CHANNEL	TX Channel 6	DETECTOR FUNCTION	Peak (PK)
FREQUENCY RANGE	1GHz ~ 25GHz		Average (AV)
TEST MODE	A		

ANTENNA POLARITY & TEST DISTANCE: HORIZONTAL AT 3 M								
NO.	FREQ. (MHz)	EMISSION LEVEL (dBuV/m)	LIMIT (dBuV/m)	MARGIN (dB)	ANTENNA HEIGHT (m)	TABLE ANGLE (Degree)	RAW VALUE (dBuV)	CORRECTION FACTOR (dB/m)
1	*2437.00	105.4 PK			1.00 H	2	108.79	-3.43
2	*2437.00	79.1 AV			1.00 H	2	82.51	-3.43
3	4874.00	46.3 PK	74.0	-27.7	1.00 H	156	42.01	4.27
4	4874.00	32.2 AV	54.0	-21.8	1.00 H	156	27.96	4.27
ANTENNA POLARITY & TEST DISTANCE: VERTICAL AT 3 M								
NO.	FREQ. (MHz)	EMISSION LEVEL (dBuV/m)	LIMIT (dBuV/m)	MARGIN (dB)	ANTENNA HEIGHT (m)	TABLE ANGLE (Degree)	RAW VALUE (dBuV)	CORRECTION FACTOR (dB/m)
1	*2437.00	96.4 PK			1.27 V	329	99.81	-3.43
2	*2437.00	72.5 AV			1.27 V	329	75.97	-3.43
3	4874.00	46.2 PK	74.0	-27.8	1.04 V	191	41.92	4.27
4	4874.00	32.3 AV	54.0	-21.7	1.04 V	191	28.07	4.27

REMARKS:

1. Emission Level(dBuV/m) = Raw Value(dBuV) + Correction Factor(dB/m)
2. Correction Factor(dB/m) = Antenna Factor(dB/m) + Cable Factor(dB) – Pre-Amplifier Factor(dB)
3. The other emission levels were very low against the limit.
4. Margin value = Emission Level – Limit value
5. " * ": Fundamental frequency.



A D T

CHANNEL	TX Channel 11	DETECTOR FUNCTION	Peak (PK)
FREQUENCY RANGE	1GHz ~ 25GHz		Average (AV)
TEST MODE	A		

ANTENNA POLARITY & TEST DISTANCE: HORIZONTAL AT 3 M

NO.	FREQ. (MHz)	EMISSION LEVEL (dBuV/m)	LIMIT (dBuV/m)	MARGIN (dB)	ANTENNA HEIGHT (m)	TABLE ANGLE (Degree)	RAW VALUE (dBuV)	CORRECTION FACTOR (dB/m)
1	*2462.00	106.1 PK			1.00 H	358	109.42	-3.36
2	*2462.00	78.8 AV			1.00 H	358	82.13	-3.36
3	2483.50	69.1 PK	74.0	-5.0	1.00 H	358	72.35	-3.30
4	2483.50	43.7 AV	54.0	-10.3	1.00 H	358	46.99	-3.30
5	4924.00	46.2 PK	74.0	-27.8	1.06 H	87	41.79	4.45
6	4924.00	31.7 AV	54.0	-22.3	1.06 H	87	27.27	4.45

ANTENNA POLARITY & TEST DISTANCE: VERTICAL AT 3 M

NO.	FREQ. (MHz)	EMISSION LEVEL (dBuV/m)	LIMIT (dBuV/m)	MARGIN (dB)	ANTENNA HEIGHT (m)	TABLE ANGLE (Degree)	RAW VALUE (dBuV)	CORRECTION FACTOR (dB/m)
1	*2462.00	95.6 PK			1.00 V	313	98.94	-3.36
2	*2462.00	71.1 AV			1.00 V	313	74.45	-3.36
3	2483.50	57.9 PK	74.0	-16.2	1.00 V	313	61.15	-3.30
4	2483.50	39.2 AV	54.0	-14.8	1.00 V	313	42.48	-3.30
5	4924.00	47.3 PK	74.0	-26.7	1.13 V	54	42.83	4.45
6	4924.00	31.8 AV	54.0	-22.2	1.13 V	54	27.34	4.45

REMARKS:

1. Emission Level(dBuV/m) = Raw Value(dBuV) + Correction Factor(dB/m)
2. Correction Factor(dB/m) = Antenna Factor(dB/m) + Cable Factor(dB) – Pre-Amplifier Factor(dB)
3. The other emission levels were very low against the limit.
4. Margin value = Emission Level – Limit value
5. " * ": Fundamental frequency.



A D T

BELOW 1GHz WORST-CASE DATA : 802.11n (20MHz)

CHANNEL	TX Channel 11	DETECTOR FUNCTION	Quasi-Peak (QP)
FREQUENCY RANGE	30MHz ~ 1GHz		
TEST MODE	A		

ANTENNA POLARITY & TEST DISTANCE: HORIZONTAL AT 3 M								
NO.	FREQ. (MHz)	EMISSION LEVEL (dBuV/m)	LIMIT (dBuV/m)	MARGIN (dB)	ANTENNA HEIGHT (m)	TABLE ANGLE (Degree)	RAW VALUE (dBuV)	CORRECTION FACTOR (dB/m)
1	51.19	19.3 QP	40.0	-20.7	2.04 H	287	32.94	-13.65
2	103.72	19.0 QP	43.5	-24.5	1.50 H	68	36.54	-17.58
3	300.10	23.9 QP	46.0	-22.1	1.78 H	316	35.96	-12.08
4	396.37	38.9 QP	46.0	-7.1	1.00 H	286	49.48	-10.55
5	636.69	28.6 QP	46.0	-17.4	2.28 H	83	34.66	-6.06
6	800.86	34.1 QP	46.0	-11.9	1.00 H	42	37.87	-3.78
7	864.01	35.8 QP	46.0	-10.3	1.00 H	84	38.59	-2.84
8	900.62	39.7 QP	46.0	-6.3	1.00 H	42	41.96	-2.25
ANTENNA POLARITY & TEST DISTANCE: VERTICAL AT 3 M								
NO.	FREQ. (MHz)	EMISSION LEVEL (dBuV/m)	LIMIT (dBuV/m)	MARGIN (dB)	ANTENNA HEIGHT (m)	TABLE ANGLE (Degree)	RAW VALUE (dBuV)	CORRECTION FACTOR (dB/m)
1	31.84	31.6 QP	40.0	-8.4	1.27 V	332	46.91	-15.29
2	106.78	22.7 QP	43.5	-20.8	1.00 V	246	39.88	-17.18
3	300.29	24.2 QP	46.0	-21.8	1.44 V	160	36.28	-12.07
4	403.64	33.0 QP	46.0	-13.0	1.50 V	118	43.41	-10.45
5	499.58	29.0 QP	46.0	-17.0	2.00 V	200	37.69	-8.72
6	699.74	28.7 QP	46.0	-17.3	2.64 V	200	34.15	-5.45
7	799.60	33.3 QP	46.0	-12.7	2.89 V	77	37.05	-3.79

REMARKS:

1. Emission Level(dBuV/m) = Raw Value(dBuV) + Correction Factor(dB/m)
2. Correction Factor(dB/m) = Antenna Factor(dB/m) + Cable Factor(dB) – Pre-Amplifier Factor(dB)
3. The other emission levels were very low against the limit.
4. Margin value = Emission Level – Limit value



A D T

4.2 CONDUCTED EMISSION MEASUREMENT

4.2.1 LIMITS OF CONDUCTED EMISSION MEASUREMENT

FREQUENCY OF EMISSION (MHz)	CONDUCTED LIMIT (dB μ V)	
	Quasi-peak	Average
0.15 ~ 0.5	66 to 56	56 to 46
0.5 ~ 5	56	46
5 ~ 30	60	50

NOTE: 1. The lower limit shall apply at the transition frequencies.

2. The limit decreases in line with the logarithm of the frequency in the range of 0.15 to 0.50MHz.

4.2.2 TEST INSTRUMENTS

Description & Manufacturer	Model No.	Serial No.	Cal. Date	Cal. Due
ROHDE & SCHWARZ TEST RECEIVER	ESCS 30	100276	Apr. 18, 2014	Apr. 17, 2015
ROHDE & SCHWARZ Artificial Mains Network (for EUT)	ESH3-Z5	100219	Nov. 17, 2013	Nov. 16, 2014
LISN With Adapter (for EUT)	AD10	C10Ada-001	Nov. 17, 2013	Nov. 16, 2014
ROHDE & SCHWARZ Artificial Mains Network (for peripherals)	ESH3-Z5	100218	Nov. 25, 2013	Nov. 24, 2014
SCHWARZBECK Artificial Mains Network (For EUT)	NNLK8129	8129229	May 08, 2014	May 07, 2015
Software	ADT_Cond_V7.3.7	NA	NA	NA
RF cable (JYEBAO)	5D-FB	Cable-C10.01	Feb. 18, 2014	Feb. 17, 2015
SUHNER Terminator (For ROHDE & SCHWARZ LISN)	65BNC-5001	E1-011484	May 27, 2014	May 26, 2015

Notes: 1. The calibration interval of the above test instruments is 12 months and the calibrations are traceable to NML/ROC and NIST/USA.

2. The test was performed in Shielded Room No. 10.

3. The VCCI Site Registration No. C-1852.

4.2.3 TEST PROCEDURES

- The EUT was placed 0.4 meters from the conducting wall of the shielded room with EUT being connected to the power mains through a line impedance stabilization network (LISN). Other support units were connected to the power mains through another LISN. The two LISNs provide 50 ohm/ 50uH of coupling impedance for the measuring instrument.
- Both lines of the power mains connected to the EUT were checked for maximum conducted interference.
- The frequency range from 150kHz to 30MHz was searched. Emission levels under (Limit - 20dB) was not recorded.

NOTE: All modes of operation were investigated and the worst-case emissions are reported.

4.2.4 DEVIATION FROM TEST STANDARD

No deviation.

4.2.5 TEST SETUP

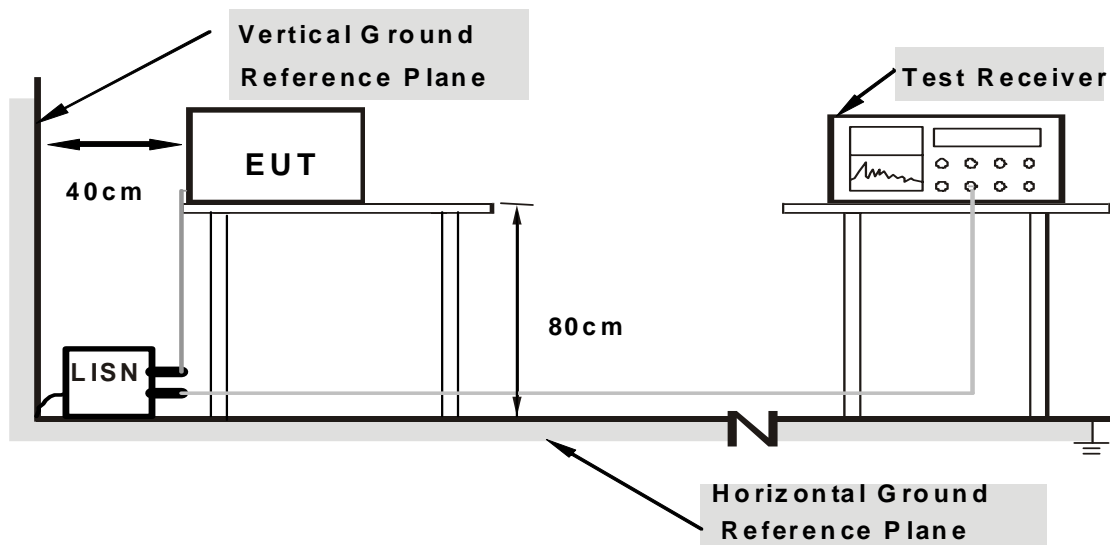

Note: Support units were connected to second LISN.

For the actual test configuration, please refer to the attached file (Test Setup Photo).

4.2.6 EUT OPERATING CONDITIONS

- Connected the AC Adapter to EUT.
- Set the EUT under charging condition.



A D T

4.2.7 TEST RESULTS

CONDUCTED WORST-CASE DATA :

PHASE	Line 1	6dB BANDWIDTH	9kHz
TEST MODE	B		

No	Frequency (MHz)	Correction Factor (dB)	Reading Value (dBuV)		Emission Level (dBuV)		Limit (dBuV)		Margin (dB)	
			Q.P.	AV.	Q.P.	AV.	Q.P.	AV.	Q.P.	AV.
1	0.15781	0.17	47.43	38.26	47.60	38.43	65.58	55.58	-17.98	-17.15
2	0.36484	0.20	46.36	36.54	46.56	36.74	58.62	48.62	-12.06	-11.88
3	0.57188	0.20	38.46	27.81	38.66	28.01	56.00	46.00	-17.34	-17.99
4	0.98594	0.20	34.48	24.54	34.68	24.74	56.00	46.00	-21.32	-21.26
5	2.50391	0.27	30.90	22.23	31.17	22.50	56.00	46.00	-24.83	-23.50
6	7.31641	0.54	27.26	18.66	27.80	19.20	60.00	50.00	-32.20	-30.80

Remarks:

1. Q.P. and AV. are abbreviations of quasi-peak and average individually.
2. The emission levels of other frequencies were very low against the limit.
3. Margin value = Emission level – Limit value
4. Correction factor = Insertion loss + Cable loss
5. Emission Level = Correction Factor + Reading Value

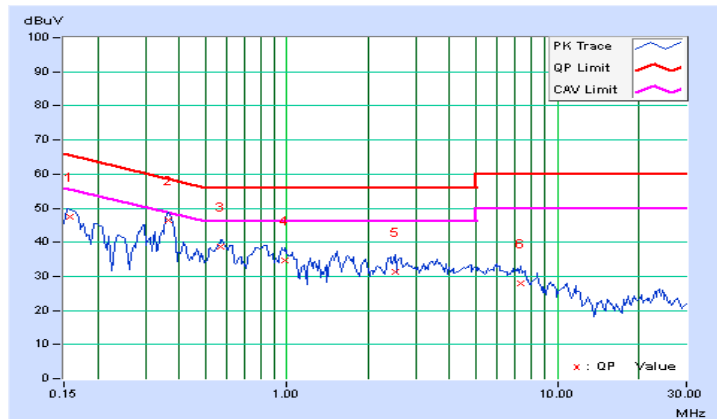



A D T

PHASE	Line 2	6dB BANDWIDTH	9kHz
TEST MODE	B		

No	Frequency (MHz)	Correction Factor (dB)	Reading Value (dBuV)		Emission Level (dBuV)		Limit (dBuV)		Margin (dB)	
			Q.P.	AV.	Q.P.	AV.	Q.P.	AV.	Q.P.	AV.
1	0.16172	0.56	48.98	41.11	49.54	41.67	65.38	55.38	-15.84	-13.71
2	0.36875	0.55	43.53	32.70	44.08	33.25	58.53	48.53	-14.45	-15.28
3	0.58359	0.56	35.91	23.28	36.47	23.84	56.00	46.00	-19.53	-22.16
4	0.97813	0.59	31.37	19.25	31.96	19.84	56.00	46.00	-24.04	-26.16
5	4.05859	0.55	24.59	14.87	25.14	15.42	56.00	46.00	-30.86	-30.58
6	7.53516	0.79	26.92	15.49	27.71	16.28	60.00	50.00	-32.29	-33.72

Remarks:

1. Q.P. and AV. are abbreviations of quasi-peak and average individually.
2. The emission levels of other frequencies were very low against the limit.
3. Margin value = Emission level – Limit value
4. Correction factor = Insertion loss + Cable loss
5. Emission Level = Correction Factor + Reading Value

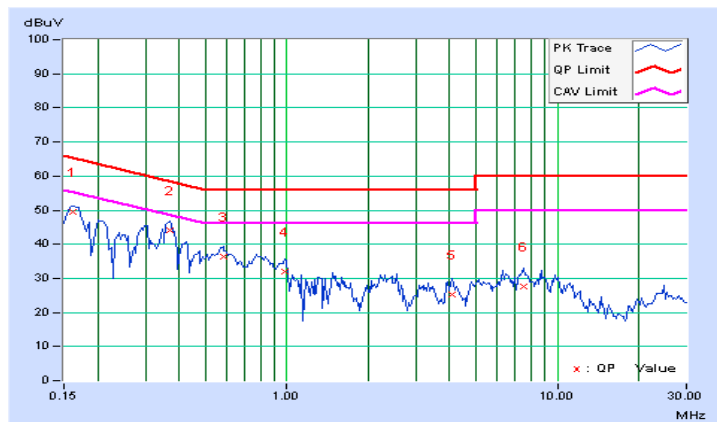

4.3 6dB BANDWIDTH MEASUREMENT

4.3.1 LIMITS OF 6dB BANDWIDTH MEASUREMENT

The minimum of 6dB Bandwidth Measurement is 0.5 MHz.

4.3.2 TEST SETUP

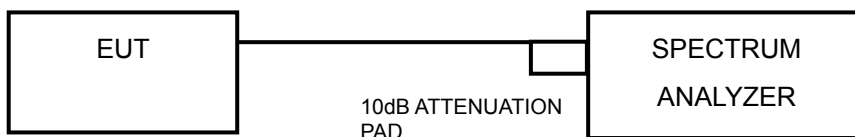

4.3.3 TEST INSTRUMENTS

Refer to section 4.1.2 to get information of above instrument.

4.3.4 TEST PROCEDURE

- a. Set resolution bandwidth (RBW) = 100kHz
- b. Set the video bandwidth (VBW) $\geq 3 \times$ RBW, Detector = Peak.
- c. Trace mode = max hold.
- d. Sweep = auto couple.
- e. Measure the maximum width of the emission that is constrained by the frequencies associated with the two amplitude points (upper and lower) that are attenuated by 6 dB relative to the maximum level measured in the fundamental emission

4.3.5 DEVIATION FROM TEST STANDARD

No deviation.

4.3.6 EUT OPERATING CONDITIONS

The software provided by client to enable the EUT under transmission condition continuously at lowest, middle and highest channel frequencies individually.



4.3.7 TEST RESULTS

Mode A:

CHANNEL	FREQUENCY (MHz)	6dB BANDWIDTH (MHz)	MINIMUM LIMIT (MHz)	PASS / FAIL
802.11b				
1	2412	10.08	0.5	PASS
6	2437	9.63	0.5	PASS
11	2462	10.05	0.5	PASS
802.11g				
1	2412	15.13	0.5	PASS
6	2437	15.09	0.5	PASS
11	2462	13.21	0.5	PASS

CHANNEL	FREQUENCY (MHz)	6dB BANDWIDTH (MHz)		MINIMUM LIMIT (MHz)	PASS / FAIL
		CHAIN 0	CHAIN 1		
802.11n (20MHz)					
1	2412	15.18	15.39	0.5	PASS
6	2437	15.17	15.15	0.5	PASS
11	2462	15.13	15.14	0.5	PASS



A D T

SPECTRUM PLOT OF WORST VALUE

802.11b

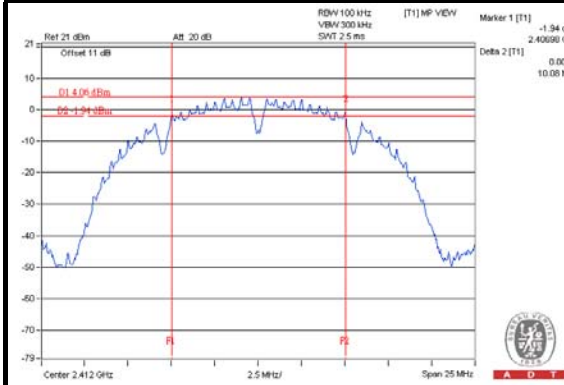

802.11g

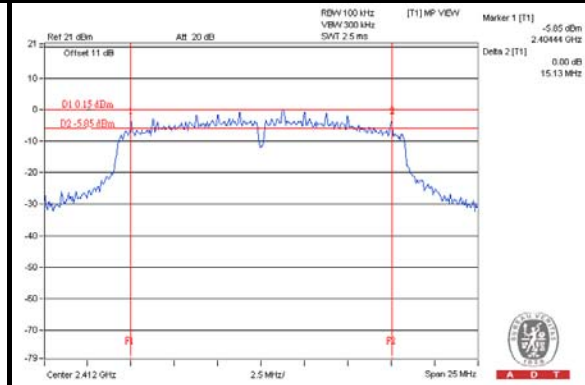

802.11n (20MHz)

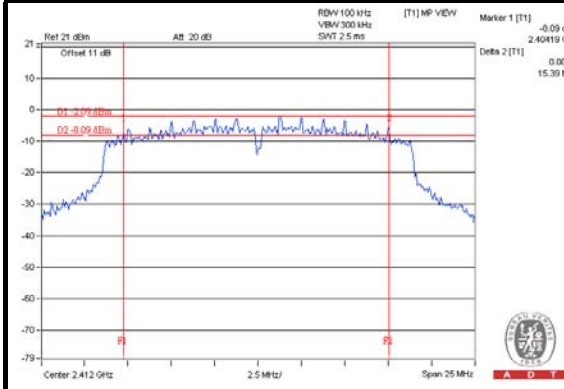

4.4 CONDUCTED OUTPUT POWER

4.4.1 LIMITS OF CONDUCTED OUTPUT POWER MEASUREMENT

For systems using digital modulation: 1 Watt (30dBm)

Per KDB 662911 D01 Multiple Transmitter Output v02r01 Method of conducted output power measurement on IEEE 802.11 devices,

Array Gain = 0 dB (i.e., no array gain) for $NANT \leq 4$;

Array Gain = 0 dB (i.e., no array gain) for channel widths ≥ 40 MHz for any NANT;

Array Gain = $5 \log(NANT/NSS)$ dB or 3 dB, whichever is less for 20-MHz channel widths with $NANT \geq 5$.

For power measurements on all other devices: Array Gain = $10 \log(NANT/NSS)$ dB.

4.4.2 TEST SETUP

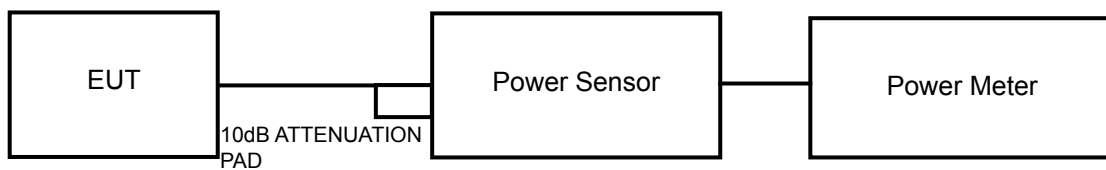

4.4.3 TEST INSTRUMENTS

Refer to section 4.1.2 to get information of above instrument.

4.4.4 TEST PROCEDURES

A peak / average power sensor was used on the output port of the EUT. A power meter was used to read the response of the peak / average power sensor. Record the peak power level.

4.4.5 DEVIATION FROM TEST STANDARD

No deviation.

4.4.6 EUT OPERATING CONDITIONS

Same as Item 4.3.6.



A D T

4.4.7 TEST RESULTS - FOR PEAK POWER

Mode A:

CHANNEL	FREQUENCY (MHz)	PEAK POWER (dBm)	PEAK POWER (mW)	LIMIT (dBm)	PASS/FAIL
802.11b					
1	2412	15.98	39.6	30	PASS
6	2437	16.03	40.1	30	PASS
11	2462	15.67	36.9	30	PASS
802.11g					
1	2412	17.73	59.3	30	PASS
6	2437	18.23	66.5	30	PASS
11	2462	17.79	60.1	30	PASS

CHAN.	CHAN. FREQ. (MHz)	POWER OUTPUT (dBm)		TOTAL POWER (mW)	TOTAL POWER (dBm)	POWER LIMIT (dBm)	PASS / FAIL
		CHAIN 0	CHAIN 1				
802.11n (20MHz)							
1	2412	14.42	17.20	80.2	19.04	30	PASS
6	2437	14.95	16.64	77.4	18.89	30	PASS
11	2462	14.02	14.95	56.5	17.52	30	PASS



A D T

4.4.8 TEST RESULTS - FOR AVERAGE POWER

Mode A:

CHANNEL	FREQUENCY (MHz)	AVERAGE POWER (dBm)
802.11b		
1	2412	14.10
6	2437	14.27
11	2462	13.80
802.11g		
1	2412	10.95
6	2437	14.29
11	2462	12.43

CHAN.	FREQUENCY (MHz)	AVERAGE POWER (dBm)		TOTAL POWER (dBm)
		CHAIN 0	CHAIN 1	
802.11n (20MHz)				
1	2412	6.86	9.45	11.36
6	2437	7.34	9.51	11.57
11	2462	6.74	9.38	11.27

4.5 POWER SPECTRAL DENSITY MEASUREMENT

4.5.1 LIMITS OF POWER SPECTRAL DENSITY MEASUREMENT

The Maximum of Power Spectral Density Measurement is 8dBm.

4.5.2 TEST SETUP

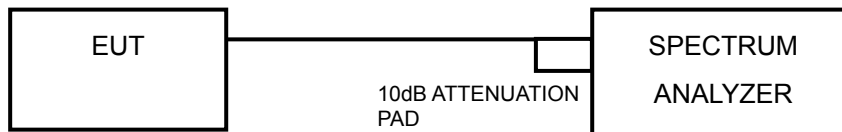

4.5.3 TEST INSTRUMENTS

Refer to section 4.1.2 to get information of above instrument.

4.5.4 TEST PROCEDURE

- a) Set analyzer center frequency to DTS channel center frequency.
- b) Set the span to 1.5 times the DTS bandwidth.
- c) Set the RBW to: $3 \text{ kHz} \leq \text{RBW} \leq 100 \text{ kHz}$.
- d) Set the VBW $\geq 3 \times \text{RBW}$.
- e) Detector = peak.
- f) Sweep time = auto couple.
- g) Trace mode = max hold.
- h) Allow trace to fully stabilize.
- i) Use the peak marker function to determine the maximum amplitude level within the RBW.

4.5.5 DEVIATION FROM TEST STANDARD

No deviation.

4.5.6 EUT OPERATING CONDITION

Same as Item 4.3.6



4.5.7 TEST RESULTS

Mode A:

Channel	Freq. (MHz)	PSD (dBm/3kHz)	Limit (dBm/3kHz)	PASS /FAIL
802.11b				
1	2412	-8.86	8	PASS
6	2437	-9.53	8	PASS
11	2462	-10.19	8	PASS
802.11g				
1	2412	-14.00	8	PASS
6	2437	-11.34	8	PASS
11	2462	-12.49	8	PASS

TX chain	Channel	Freq. (MHz)	PSD (dBm/3kHz)	10 log (N=2) dB	Total PSD (dBm/3kHz)	Limit (dBm/3kHz)	PASS /FAIL
802.11n (20MHz)							
0	1	2412	-18.38	3.01	-15.37	7.91	PASS
	6	2437	-18.13	3.01	-15.12	7.91	PASS
	11	2462	-19.46	3.01	-16.45	7.91	PASS
1	1	2412	-15.65	3.01	-12.64	7.91	PASS
	6	2437	-16.32	3.01	-13.31	7.91	PASS
	11	2462	-17.24	3.01	-14.23	7.91	PASS

NOTE:

- Method a) of power density measurement of KDB 662911 is using for calculating total power density. Total power density is summing entire spectra across corresponding frequency bins on the various outputs by computer.
- Directional gain = $3.18\text{dBi} + 10\log(2) = 6.09\text{dBi} < 6\text{dBi}$, so the power density limit shall be reduced to $8 - (6.09 - 6) = 7.91\text{dBm}$.



A D T

SPECTRUM PLOT OF WORST VALUE

802.11b

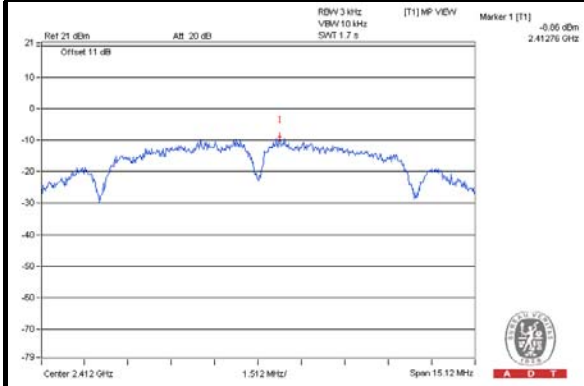

802.11g

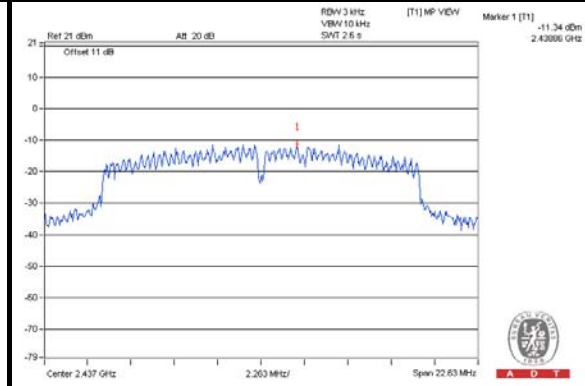

802.11n (20MHz)

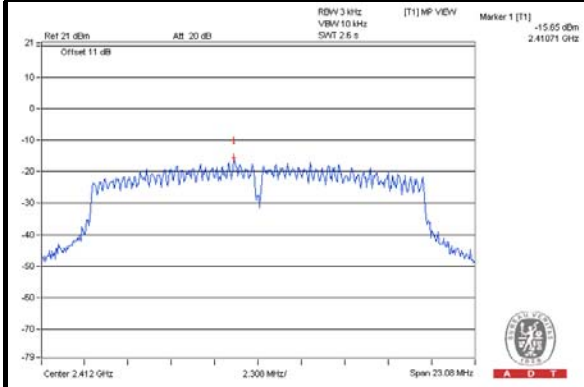

4.6 CONDUCTED OUT OF BAND EMISSION MEASUREMENT

4.6.1 LIMITS OF CONDUCTED OUT OF BAND EMISSION MEASUREMENT

Below -20dB of the highest emission level of operating band (in 100kHz Resolution Bandwidth).

4.6.2 TEST SETUP

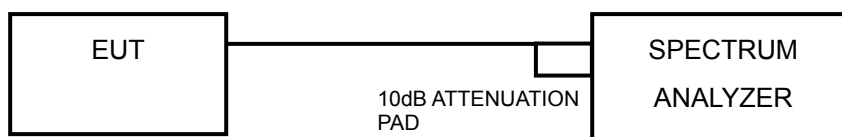

4.6.3 TEST INSTRUMENTS

Refer to section 4.1.2 to get information of above instrument.

4.6.4 TEST PROCEDURE

MEASUREMENT PROCEDURE REF

1. Set the RBW = 100 kHz.
2. Set the VBW \geq 300 kHz.
3. Detector = peak.
4. Sweep time = auto couple.
5. Trace mode = max hold.
6. Allow trace to fully stabilize.
7. Use the peak marker function to determine the maximum power level in any 100 kHz band segment within the fundamental EBW.



A D T

MEASUREMENT PROCEDURE OOB

1. Set RBW = 100 kHz.
2. Set VBW \geq 300 kHz.
3. Detector = peak.
4. Sweep = auto couple.
5. Trace Mode = max hold.
6. Allow trace to fully stabilize.
7. Use the peak marker function to determine the maximum amplitude level.

4.6.5 DEVIATION FROM TEST STANDARD

No deviation.

4.6.6 EUT OPERATING CONDITION

Same as Item 4.3.6

4.6.7 TEST RESULTS

The conducted emission test is performed on each TX port of operating mode without summing or adding $10\log(N)$ since the limit is relative emission limit.

The spectrum plots are attached on the following pages. D1 line indicates the highest level, and D2 line indicates the 20dB offset below D1. It shows compliance with the requirement.



A D T

Mode A: 802.11b

CH 1

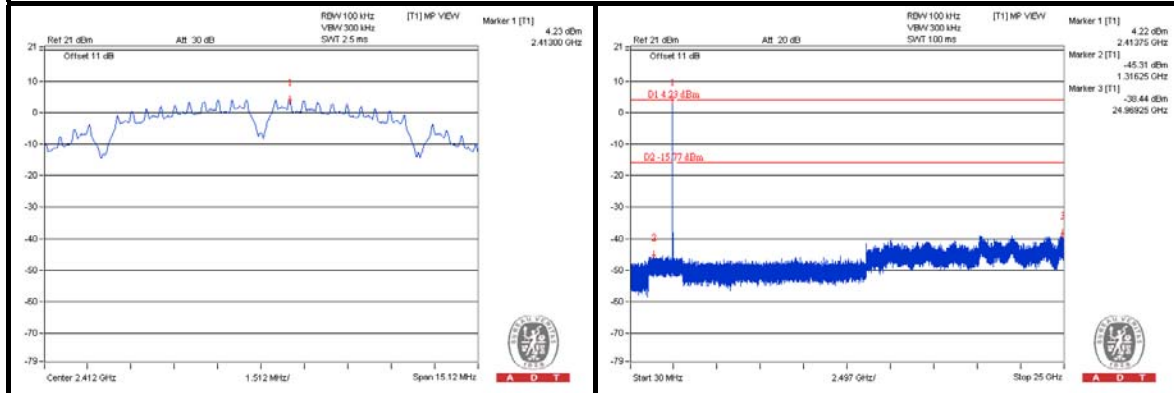

CH 6

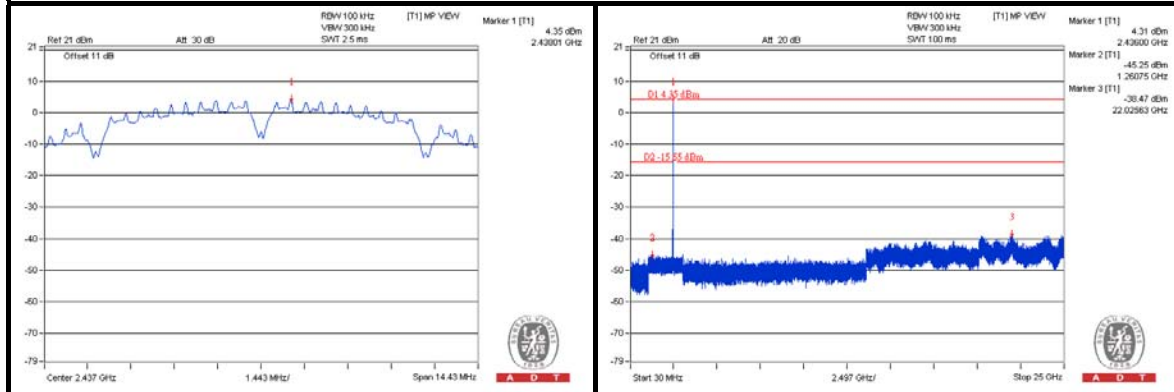

CH 11

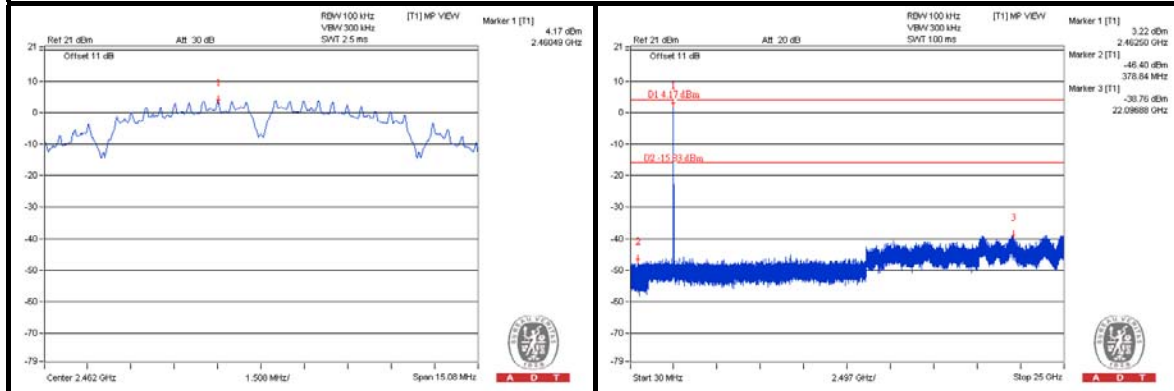

CH 1 Band edge

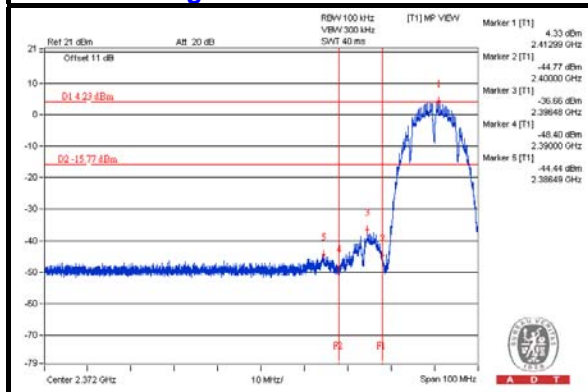

CH 11 Band edge

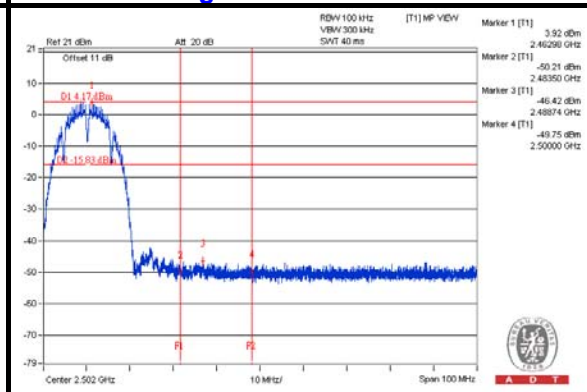



A D T

802.11g:

CH 1

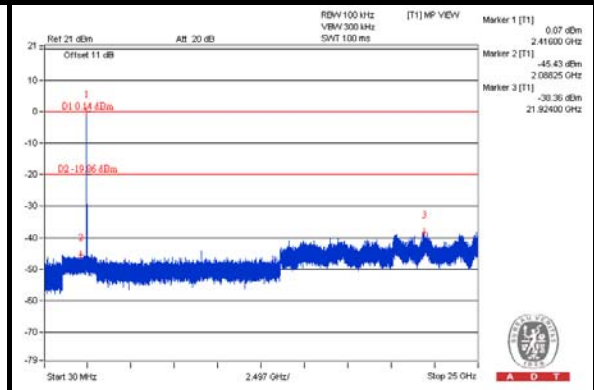
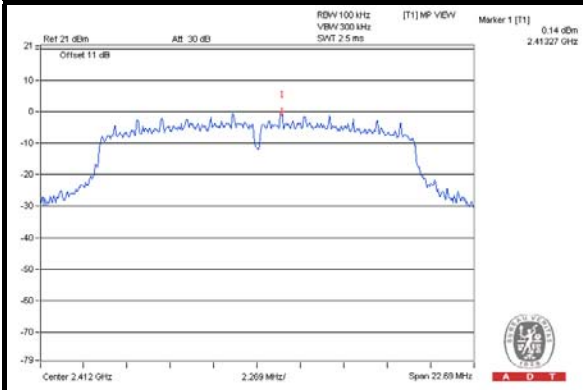

CH 6

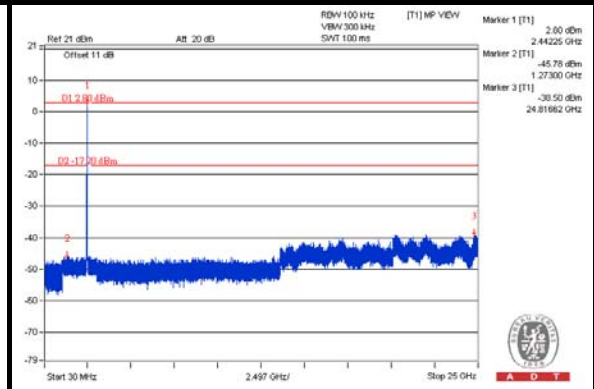
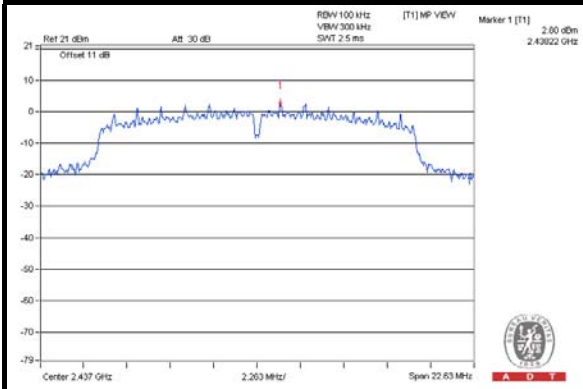

CH 11

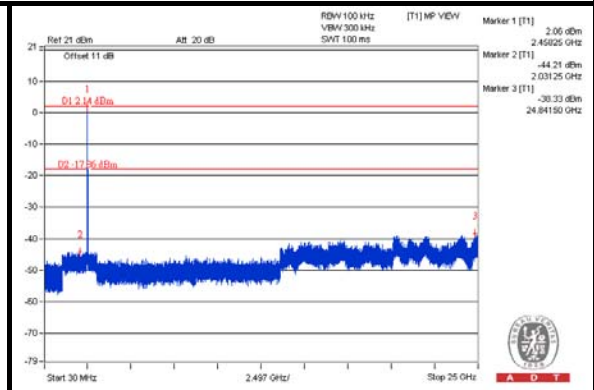
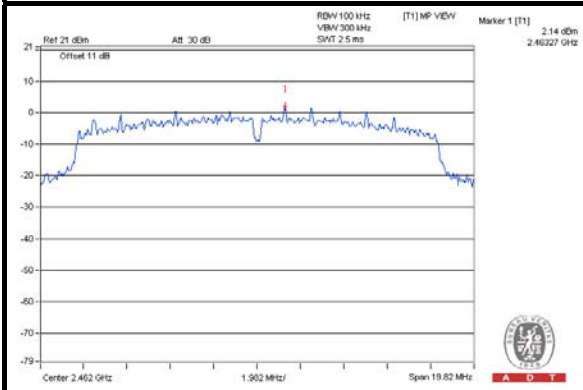

CH 1 Band edge

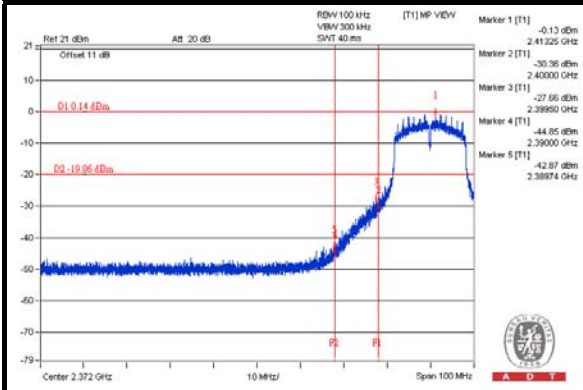

CH 11 Band edge

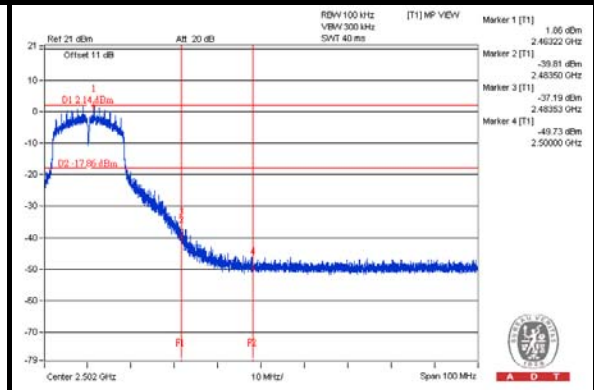



A D T

802.11n (20MHz): CHAN 0

CH 1

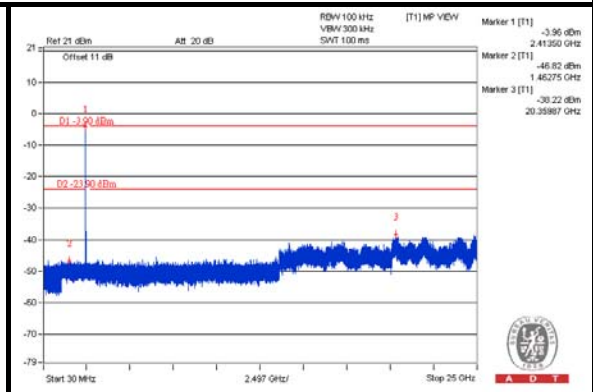
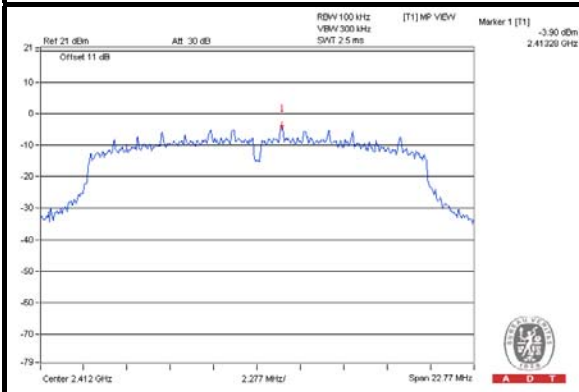

CH 6

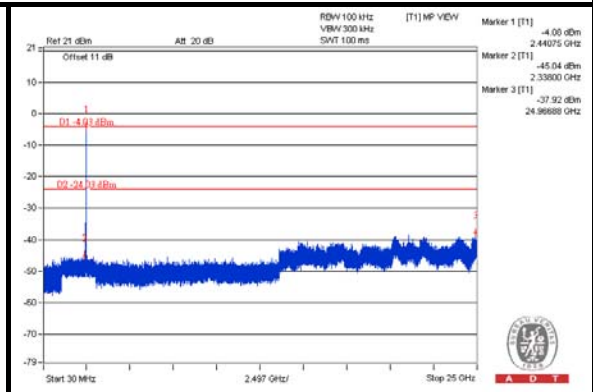
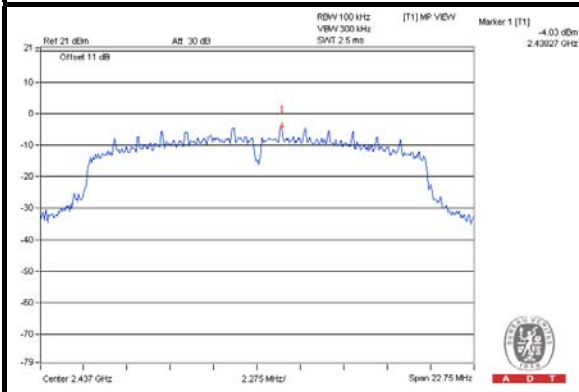

CH 11

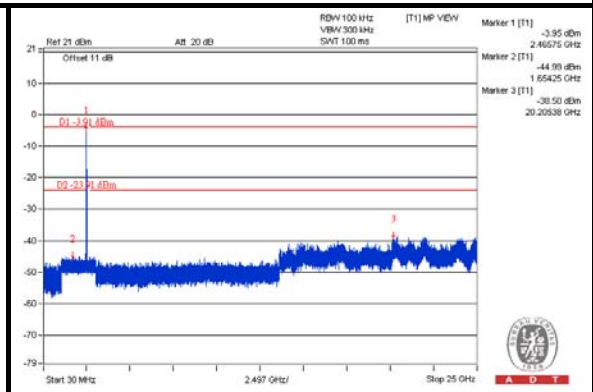
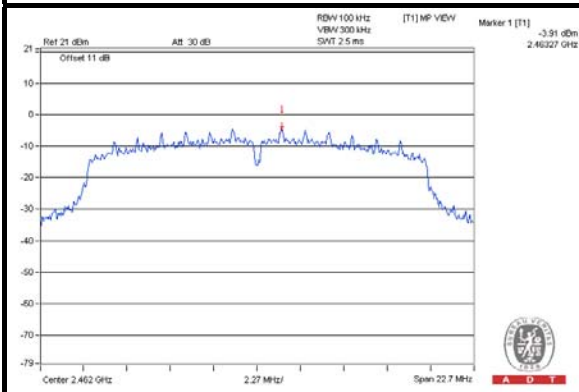

CH 1 Band edge

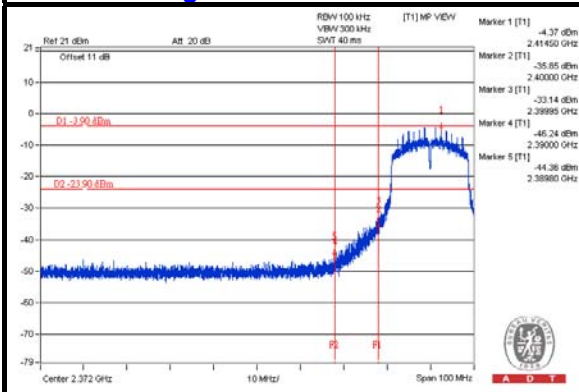

CH 11 Band edge

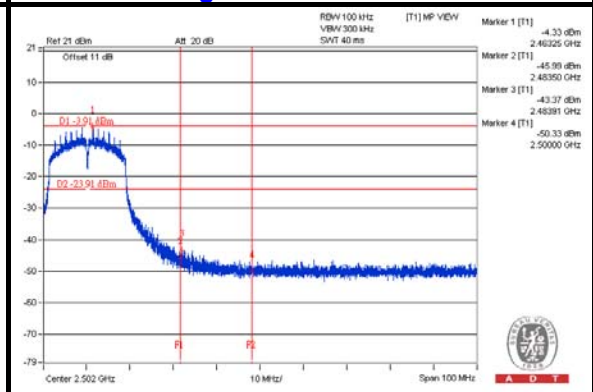



A D T

802.11n (20MHz): CHAIN 1

CH 1

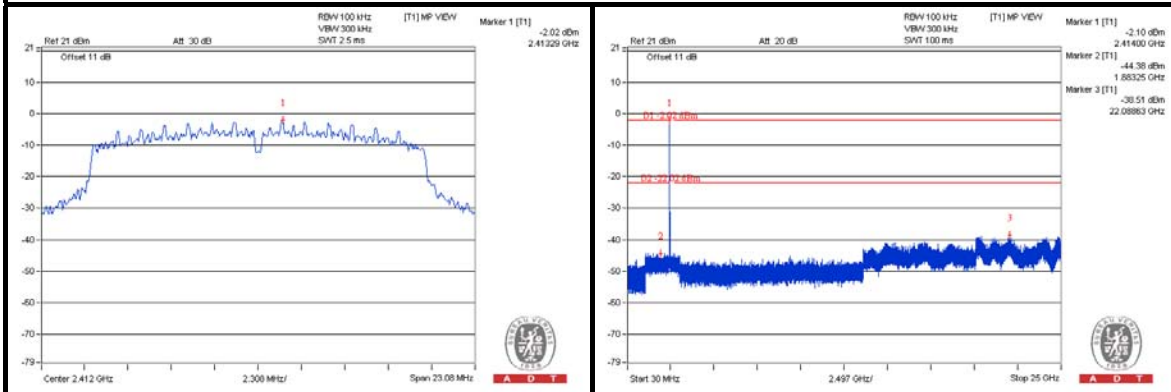

CH 6

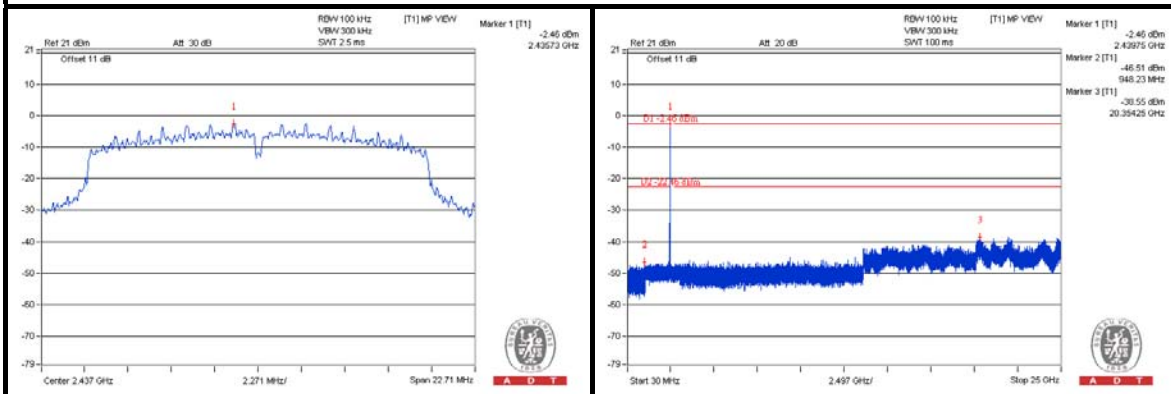

CH 11

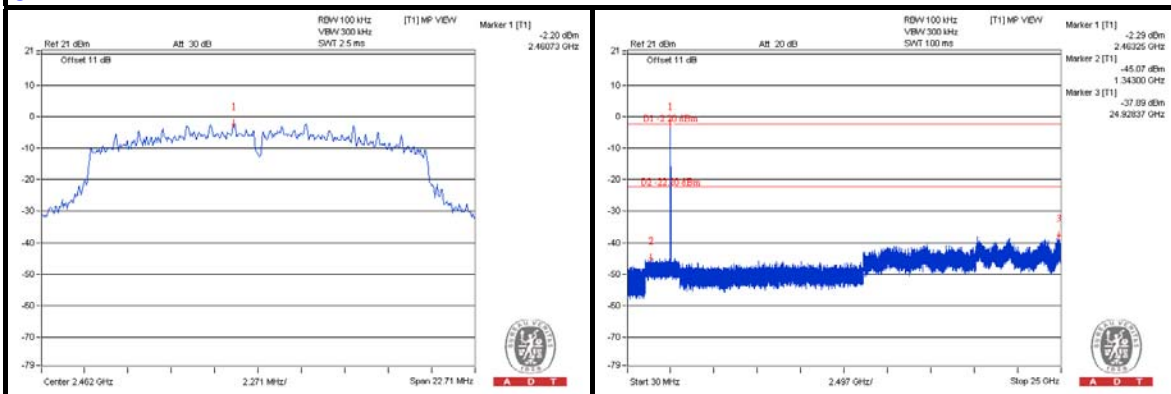

CH 1 Band edge

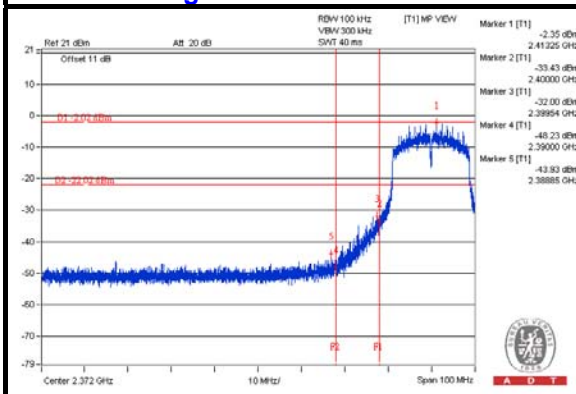

CH 11 Band edge

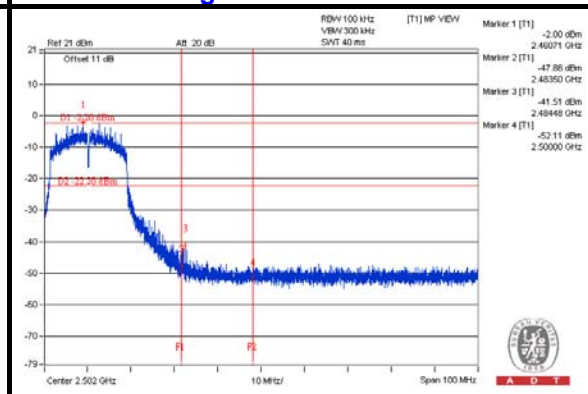



A D T

5. PHOTOGRAPHS OF THE TEST CONFIGURATION

Please refer to the attached file (Test Setup Photo).



A D T

6. INFORMATION ON THE TESTING LABORATORIES

We, Bureau Veritas Consumer Products Services (H.K.) Ltd., Taoyuan Branch, were founded in 1988 to provide our best service in EMC, Radio, Telecom and Safety consultation. Our laboratories are accredited and approved according to ISO/IEC 17025.

If you have any comments, please feel free to contact us at the following:

Linko EMC/RF Lab

Tel: 886-2-26052180

Fax: 886-2-26051924

Hsin Chu EMC/RF Lab

Tel: 886-3-5935343

Fax: 886-3-5935342

Hwa Ya EMC/RF/Safety/Telecom Lab

Tel: 886-3-3183232

Fax: 886-3-3270892

Email: service.adt@tw.bureauveritas.com

Web Site: www.bureauveritas-adt.com

The address and road map of all our labs can be found in our web site also.



A D T

7. APPENDIX A – MODIFICATIONS RECORDERS FOR ENGINEERING CHANGES TO THE EUT BY THE LAB

No modifications were made to the EUT by the lab during the test.

---END---