

FCC Test Report

Product Name	ROG BALTEUS Qi
Model No.	NH01(R)
FCC ID.	EMJMNH01R

Applicant	Primax Electronics Ltd
Address	669 Ruey Kuang Road Neihu 114, Taipei, Taiwan

Date of Receipt	Feb. 08, 2022
Issued Date	May 04, 2022
Report No.	2220075R-RFUSOTHV02-A
Report Version	V1.0



The test results relate only to the samples tested.

The test results shown in the test report are traceable to the national/international standard through the calibration of the equipment and evaluated measurement uncertainty herein.

This report must not be used to claim product endorsement by TAF or any agency of the government.

The test report shall not be reproduced without the written approval of DEKRA Testing and Certification Co., Ltd.

Measurement uncertainties evaluated for each testing system and associated connections are given here to provide the system information for reference. Compliance determinations do not take into account measurement uncertainties for each testing system, but are based on the results of the compliance measurement.

Test Report

Issued Date: May 04, 2022

Report No.: 2220075R-RFUSOTHV02-A



Product Name	ROG BALTEUS Qi
Applicant	Primax Electronics Ltd
Address	669 Ruey Kuang Road Neihu 114, Taipei, Taiwan
Manufacturer	Primax Electronics Ltd
Model No.	NH01(R)
FCC ID.	EMJMNH01R
EUT Rated Voltage	DC 5V (Power by USB)
EUT Test Voltage	DC 5V (Power by USB)
Trade Name	ASUS
Applicable Standard	FCC CFR Title 47 Part 15 Subpart C ANSI C63.4: 2014, ANSI C63.10: 2013
Test Result	Complied

Documented By

:



(Senior Project Specialist / Joanne Lin)

Tested By

:

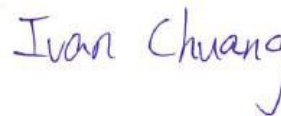

(Senior Engineer / Ivan Chuang)

Approved By

:

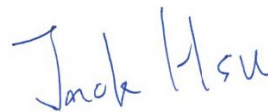

(Senior Engineer / Jack Hsu)

TABLE OF CONTENTS

Description	Page
1. GENERAL INFORMATION.....	5
1.1. EUT Description	5
1.2. Test System Details.....	6
1.3. Configuration of Test System	6
1.4. EUT Exercise Software.....	6
1.5. Test Facility.....	7
1.6. List of Test Equipment.....	8
1.7. Uncertainty.....	9
2. Conducted Emission	10
2.1. Test Setup.....	10
2.2. Limits	10
2.3. Test Procedure.....	11
2.4. Test Result of Conducted Emission	12
3. Radiated Emission	13
3.1. Test Setup.....	13
3.2. Limits	14
3.3. Test Procedure.....	15
3.4. Test Result of Radiated Emission	16
4. EMI Reduction Method During Compliance Testing.....	18
Appendix 1: EUT Test Photographs	
Appendix 2: Product Photos-Please refer to the file: 2220075R-Product Photos	

Revision History

Report No.	Version	Description	Issued Date
2220075R-RFUSOTHV02-A	V1.0	Initial issue of report.	2022-05-04

1. GENERAL INFORMATION

1.1. EUT Description

Product Name	ROG BALTEUS Qi
Trade Name	ASUS
Model No.	NH01(R)
FCC ID.	EMJMNH01R
Frequency Range	150kHz
Type of antenna	Coil Antenna
USB Cable	Shielded, 1m

Frequency of Channel:

Channel	Frequency
Channel 1:	150kHz

Note:

1. The EUT is a ROG BALTEUS Qi with a built-in 150kHz transceiver.
2. These tests were conducted on a sample of the equipment for the purpose of demonstrating compliance with Part 15 Subpart C Paragraph 15.209.

Test Mode	Mode 1: Transmit
-----------	------------------

1.2. Test System Details

The types for all equipment, plus descriptions of all cables used in the tested system (including inserted cards) are:

Product	Manufacturer	Model No.	Serial No.	Power Cord
1 Power Adapter	PI	AD83531	N/A	N/A
2 Notebook PC	DELL	Latitude E5440	FS9TK32	N/A
3 Mobile Phone	SONY	H8296	43027566	N/A
4 Mouse	Logitech	U0026	N/A	N/A

Signal Cable Type	Signal cable Description
A USB Cable	Shielded, 1m
B USB Cable	Shielded, 1.8m
C USB Cable	Non-Shielded, 1.8m

1.3. Configuration of Test System

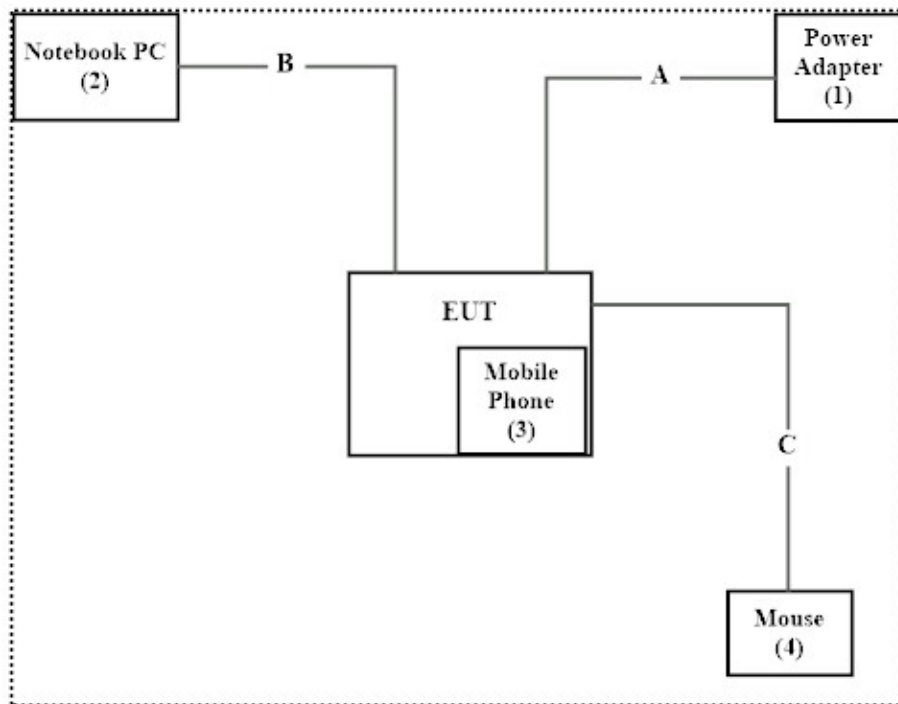

1.4. EUT Exercise Software

- (1) Setup the EUT as shown in Section 1.3.
- (2) Turn on the power of all equipment.
- (3) Start the continuous receiver.
- (4) Verify that the EUT works properly.

1.5. Test Facility

Ambient conditions in the laboratory:

Performed Item	Items	Required	Actual
Conducted Emission	Temperature (°C)	10~40 °C	22.5 °C
	Humidity (%RH)	10~90 %	60.5 %
Radiated Emission	Temperature (°C)	10~40 °C	23.4 °C
	Humidity (%RH)	10~90 %	62.5 %

USA : **FCC Registration Number: TW0033**

Canada : **CAB Identifier Number: TW3023 / Company Number: 26930**

Site Description : Accredited by TAF
Accredited Number: 3023

Test Laboratory : DEKRA Testing and Certification Co., Ltd
Address : No. 5-22, Ruishukeng Linkou District, New Taipei City, 24451,
Taiwan

Performed Location : No. 26, Huaya 1st Rd., Guishan Dist., Taoyuan City 333411, Taiwan,
R.O.C.

Phone number : +886-3-275-7255
Fax number : +866-3-327-8031
Email address : info.tw@dekra.com
Website : <http://www.dekra.com.tw>

1.6. List of Test Equipment

For Conduction measurements / SH1

	Equipment	Manufacturer	Model No.	Serial No.	Cal. Date	Due. Date
X	EMI Test Receiver	R&S	ESR7	101601	2021.06.19	2022.06.18
X	Two-Line V-Network	R&S	ENV216	101306	2021.04.08	2022.04.07
X	Two-Line V-Network	R&S	ENV216	101307	2021.05.04	2022.05.03
X	Coaxial Cable	SUHNER	RG400 BNC	RF001	2021.05.24	2022.05.23

Note:

1. All equipments are calibrated every one year.
2. The test instruments marked with "X" are used to measure the final test results.
3. Test Software version : AUDIX e3 V9.

For Radiated measurements / 966-3

	Equipment	Manufacturer	Model No.	Serial No.	Cal. Date	Due. Date
X	Loop Antenna	AMETEK	HLA6121	56736	2021.04.14	2022.04.13
X	Bi-Log Antenna	SCHWARZBECK	VULB9168	9168-675	2021.08.10	2022.08.10
	Horn Antenna	ETS-Lindgren	3117	00201259	2021.11.09	2022.11.08
	Horn Antenna	Com-Power	AH-840	101087	2021.06.16	2022.06.15
X	Pre-Amplifier	EMCI	EMC001330	980302	2021.07.26	2022.07.25
	Pre-Amplifier	EMCI	EMC051835SE	980313	2021.11.24	2022.11.23
	Pre-Amplifier	EMCI	EMC05820SE	980310	2021.07.07	2022.07.06
	Pre-Amplifier	EMCI	EMC184045SE	980369		
	Coaxial Cable	EMCI	EMC102-KM-KM-600	1160314	2021.04.27	2022.04.26
	Coaxial Cable	EMCI	EMC102-KM-KM-7000	170242		
	Filter	MICRO TRONICS	BRM50702	G251	2021.09.16	2022.09.15
	Filter	MICRO TRONICS	BRM50716	G188	2021.09.16	2022.09.15
X	EMI Test Receiver	R&S	ESR	102793	2021.12.15	2022.12.14
X	Spectrum Analyzer	R&S	FSV3044	101113	2022.01.25	2023.02.24
	Coaxial Cable	SGH	HA800	GD20110222-3	2022.01.05	2023.01.04
X	Coaxial Cable	SGH	SGH18	20110223-1		
	Coaxial Cable	SGH	SGH18	2021005-3		
	Coaxial Cable	SGH	SGH18	2021001-18		

Note:

1. All equipments are calibrated every one year.
2. The test instruments marked with "X" are used to measure the final test results.
3. Test Software version : AUDIX e3 V9.

1.7. Uncertainty

Uncertainties have been calculated according to the DEKRA internal document.

The reported expanded uncertainties are based on a standard uncertainty multiplied by a coverage factor of $k=2$, providing a level of confidence of approximately 95%.

Measurement uncertainties evaluated for each testing system and associated connections are given here to provide the system information for reference. Compliance determinations do not take into account measurement uncertainties for each testing system, but are based on the results of the compliance measurement.

Test item	Uncertainty	
Conducted Emission	± 3.42 dB	
Radiated Emission	Under 1GHz ± 4.06 dB	Above 1GHz ± 3.73 dB

2. Conducted Emission

2.1. Test Setup

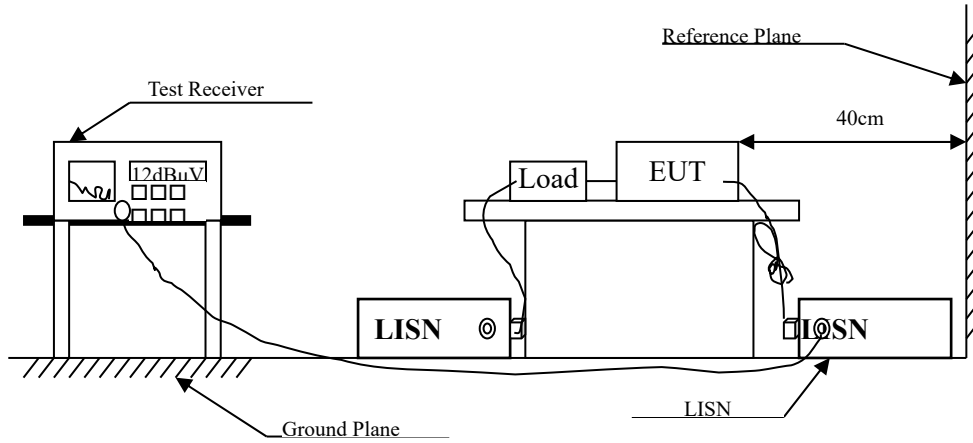

2.2. Limits

FCC Part 15 Subpart C Paragraph 15.207 (dB μ V) Limit		
Frequency MHz	Limits	
	QP	AV
0.15 - 0.50	66-56 ^(§§)	56-46 ^(§§)
0.50-5.0	56	46
5.0 - 30	60	50

2.3. Test Procedure

The EUT and simulators are connected to the main power through a line impedance stabilization network (L.I.S.N.). This provides a 50 ohm /50uH coupling impedance for the measuring equipment. The peripheral devices are also connected to the main power through a LISN that provides a 50ohm /50uH coupling impedance with 50ohm termination. (Please refers to the block diagram of the test setup and photographs.)

Both sides of A.C. line are checked for maximum conducted interference. In order to find the maximum emission, the relative positions of equipment and all of the interface cables must be changed according to ANSI C63.4: 2014 on conducted measurement.

Conducted emissions were investigated over the frequency range from 0.15MHz to 30MHz using a receiver bandwidth of 9kHz.

2.4. Test Result of Conducted Emission

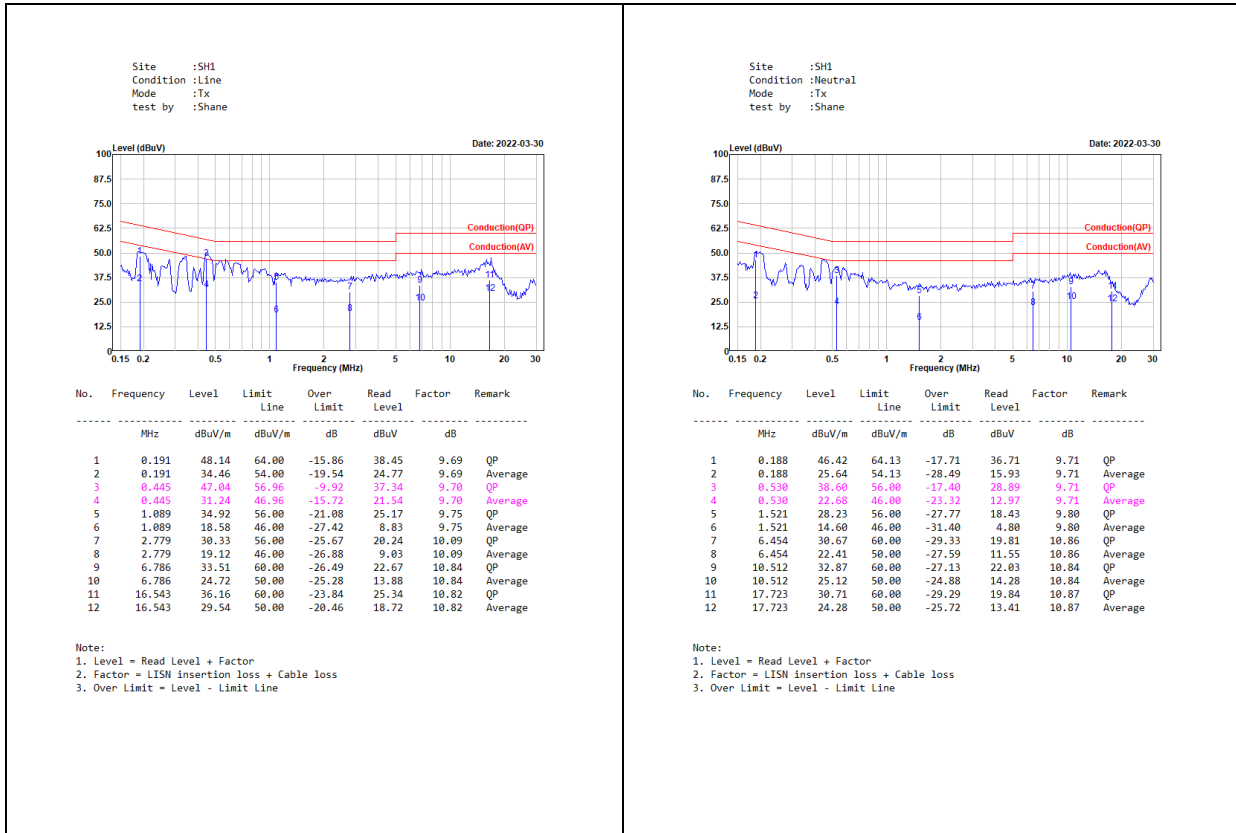

3. Radiated Emission

3.1. Test Setup

Radiated Emission Under 30MHz

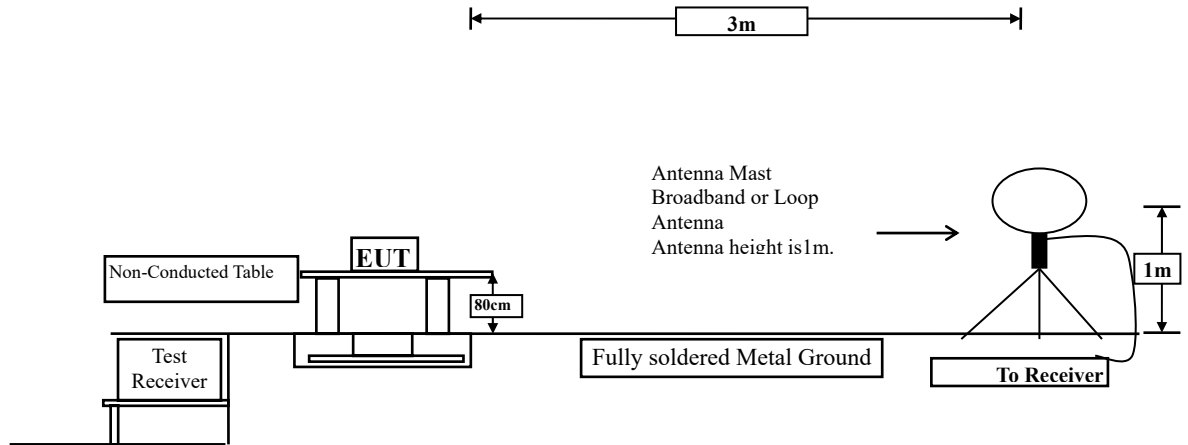

Radiated Emission Below 1GHz

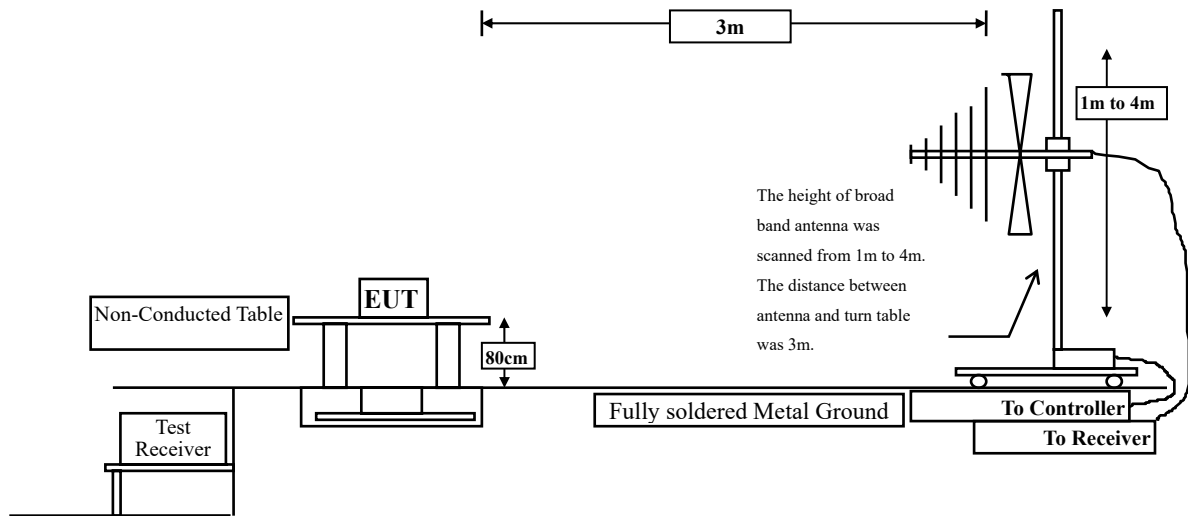

3.2. Limits

FCC Part 15 Subpart C Paragraph 15.209 Limits		
Frequency MHz	Field strength (microvolts/meter)	Measurement distance (meter)
0.009-0.490	2400/F(kHz)	300
0.490-1.705	24000/F(kHz)	30
1.705-30	30	30
30-88	100	3
88-216	150	3
216-960	200	3
Above 960	500	3

- Remarks :
1. RF Voltage (dB μ V) = 20 log RF Voltage (uV)
 2. In the Above Table, the tighter limit applies at the band edges.
 3. Distance refers to the distance in meters between the measuring instrument antenna and the closed point of any part of the device or system.

3.3. Test Procedure

The EUT was setup according to ANSI C63.10, 2013 and tested compliance to FCC 47CFR 15.209 requirements.

The EUT and its simulators are placed on a turn table which is 0.8 meter above ground. The turn table can rotate 360 degrees to determine the position of the maximum emission level. The EUT was positioned such that the distance from antenna to the EUT was 3 meters.

The antenna can move up and down between 1 meter and 4 meters to find out the maximum emission level.

Both horizontal and vertical polarization of the antenna are set on measurement. In order to find the maximum emission, all of the interface cables must be manipulated according to ANSI C63.10: 2013 on radiated measurement.

The resolution bandwidth below 30MHz setting on the field strength meter is 9kHz and 30MHz~1GHz is 120kHz and above 1GHz is 1MHz. Radiated emission measurements below 1GHz are made using broadband Bilog antenna and above 1GHz are made using Horn Antennas.

The measurement is divided into the Preliminary Measurement and the Final Measurement.

The suspected frequencies are searched for in Preliminary Measurement with the measurement antenna kept pointed at the source of the emission both in azimuth and elevation, with the polarization of the antenna oriented for maximum response. The antenna is pointed at an angle towards the source of the emission, and the EUT is rotated in both height and polarization to maximize the measured emission. The emission is kept within the illumination area of the 3 dB bandwidth of the antenna.

The worst radiated emission is measured on the Final Measurement.

The measurement frequency range form 9kHz - 10th Harmonic of fundamental was investigated.

3.4. Test Result of Radiated Emission

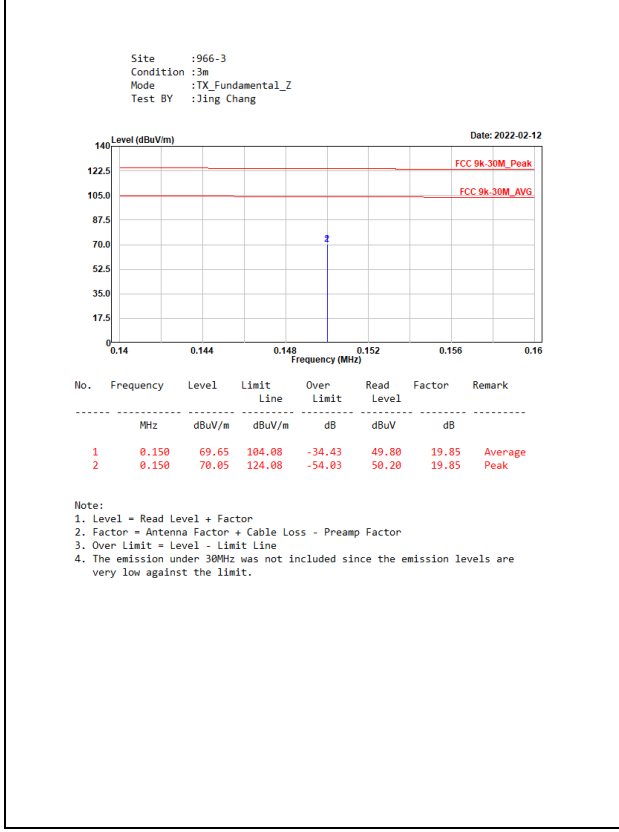
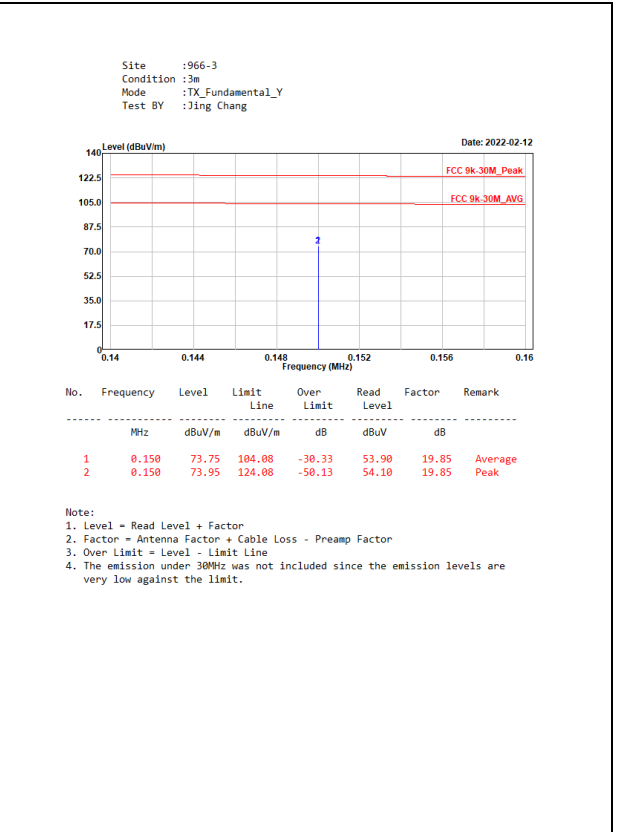
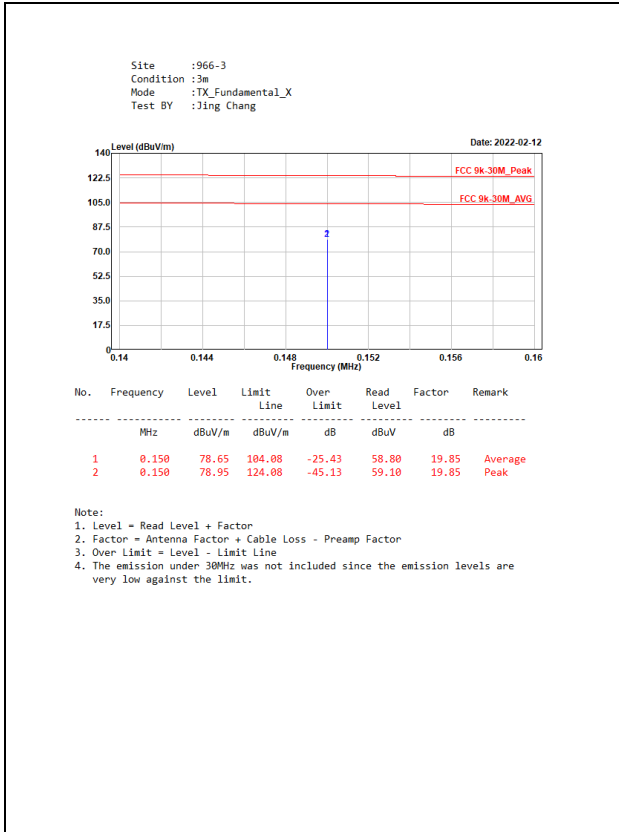

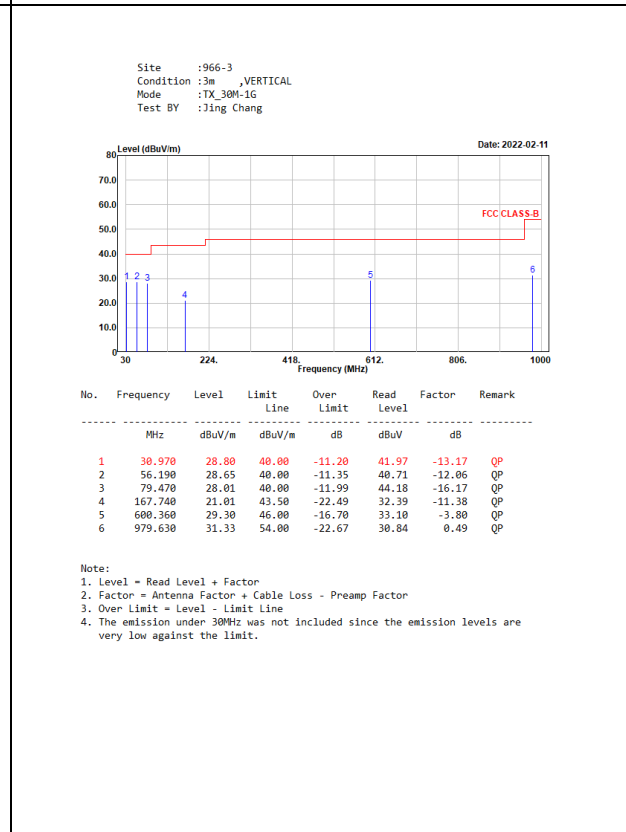
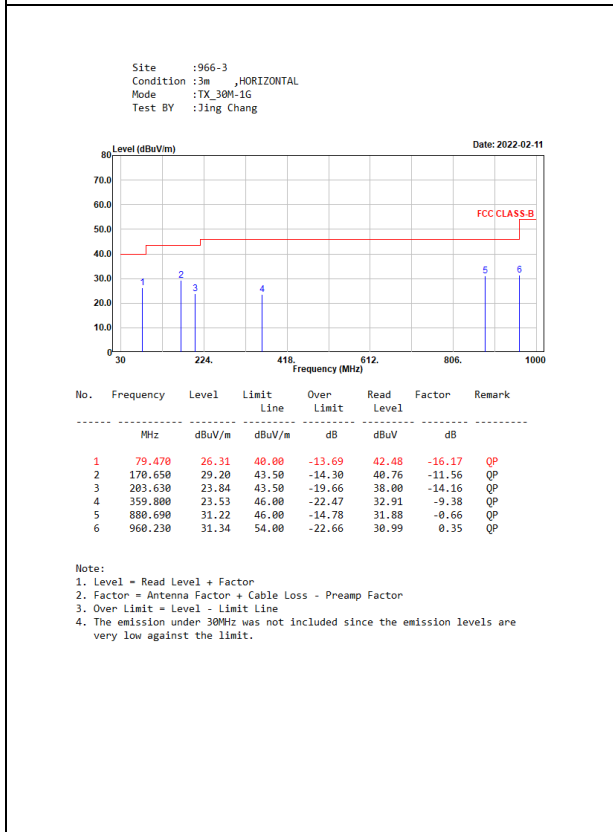
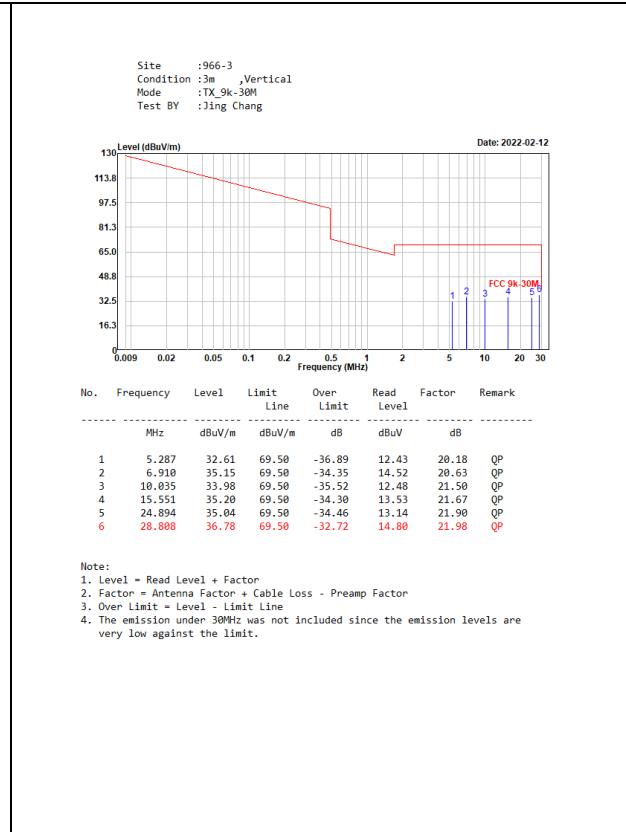
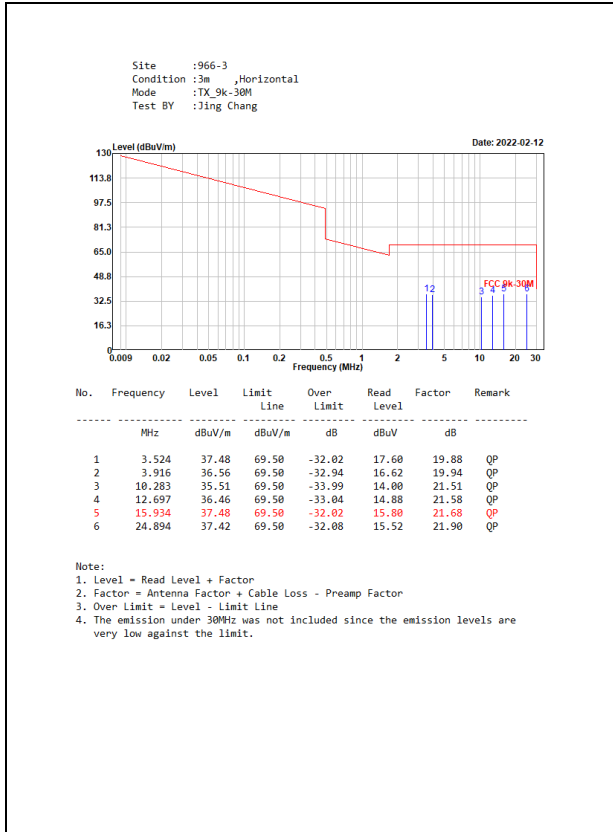

4. EMI Reduction Method During Compliance Testing

No modification was made during testing.