



Produkte
Products

Prüfbericht - Nr.: 10035761 001 <i>Test Report No.:</i>		Seite 1 von 36 <i>Page 1 of 36</i>	
Auftraggeber: <i>Client:</i>		Primax Electronics LTD No. 669 Ruey Kuang Road, Neihu, 114 Taipei, Taiwan R.O.C.	
Gegenstand der Prüfung: <i>Test item:</i>		ThinkPad Bluetooth Laser Mouse	
Bezeichnung: <i>Identification:</i>	MOBTC9LA	Serien-Nr.: <i>Serial No.:</i>	N/A
Wareneingangs-Nr.: <i>Receipt No.:</i>	TPE70137	Eingangsdatum: <i>Date of receipt:</i>	2012/02/23
Zustand des Prüfgegenstandes bei Anlieferung: <i>Condition of test item at delivery:</i>		The sample is ok for testing and not damaged	
Prüfört: <i>Testing location:</i>	TÜV Rheinland Taiwan Ltd. 11F., No.758, Sec. 4, Bade Rd., Songshan Dist., Taipei City 105 Taiwan FCC Registration No.: 365730		
Prüfgrundlage: <i>Test specification:</i>	FCC CFR47 Part 15: Subpart C Section 15.247 RSS-210 (Issue 8): Dec. 2010 RSS-Gen (Issue 3): Dec. 2010		
Prüfergebnis: <i>Test Result:</i>	Der Prüfgegenstand entspricht oben genannter Prüfgrundlage(n). <i>The test item passed the test specification(s).</i>		
Prüflaboratorium: <i>Testing Laboratory:</i>	TÜV Rheinland Taiwan Ltd. 11F., No.758, Sec. 4, Bade Rd., Songshan Dist., Taipei City 105, Taiwan, R.O.C.		
geprüft/ tested by:		kontrolliert/ reviewed by:	
<p>2012-03-05  Arvin Ho/Section Manager</p>		<p>2012-03-13  Rene Charton/Senior Project Manager</p>	
Datum <i>Date</i>	Name/Stellung <i>Name/Position</i>	Unterschrift <i>Signature</i>	Datum <i>Date</i>
			Name/Stellung <i>Name/Position</i>
			Unterschrift <i>Signature</i>
Sonstiges/ Other Aspects:			
Abkürzungen: P(ass) = entspricht Prüfgrundlage F(ail) = entspricht nicht Prüfgrundlage N/A = nicht anwendbar N/T = nicht getestet			
Abbreviations: P(ass) = passed F(ail) = failed N/A = not applicable N/T = not tested			
<p>Dieser Prüfbericht bezieht sich nur auf das o.g. Prüfmuster und darf ohne Genehmigung der Prüfstelle nicht auszugsweise vervielfältigt werden. Dieser Bericht berechtigt nicht zur Verwendung eines Prüfzeichens. <i>This test report relates to the a. m. test item. Without permission of the test center this test report is not permitted to be duplicated in extracts. This test report does not entitle to carry any safety mark on this or similar products.</i></p>			

TEST SUMMARY

5.1.1 ANTENNA REQUIREMENT*RESULT: Passed***5.1.2 PEAK OUTPUT POWER***RESULT: Passed***5.1.3 20dB BANDWIDTH***RESULT: Passed***5.1.4 99% BANDWIDTH***RESULT: Passed***5.1.5 CONDUCTED SPURIOUS EMISSIONS AND FREQUENCY BAND EDGE MEASURED IN 100KHZ BANDWIDTH***RESULT: Passed***5.1.6 SPURIOUS EMISSION***RESULT: Passed***5.1.7 FREQUENCY SEPARATION***RESULT: Passed***5.1.8 NUMBER OF HOPPING FREQUENCY***RESULT: Passed***5.1.9 TIME OF OCCUPANCY***RESULT: Passed***6.1.1 ELECTROMAGNETIC FIELDS***RESULT: Passed*

Contents

1.	GENERAL REMARKS	4
1.1	COMPLEMENTARY MATERIALS	4
2.	TEST SITES	5
2.1	TEST FACILITIES	5
2.2	LIST OF TEST AND MEASUREMENT INSTRUMENTS.....	5
2.3	TRACEABILITY	6
2.4	CALIBRATION	6
2.5	MEASUREMENT UNCERTAINTY.....	6
3.	GENERAL PRODUCT INFORMATION	7
3.1	PRODUCT FUNCTION AND INTENDED USE.....	7
3.2	RATINGS AND SYSTEM DETAILS	7
3.3	INDEPENDENT OPERATION MODES	8
3.4	NOISE GENERATING AND NOISE SUPPRESSING PARTS	9
3.5	SUBMITTED DOCUMENTS	9
4.	TEST SET-UP AND OPERATION MODES	10
4.1	PRINCIPLE OF CONFIGURATION SELECTION.....	10
4.2	TEST OPERATION AND TEST SOFTWARE	10
4.3	SPECIAL ACCESSORIES AND AUXILIARY EQUIPMENT	10
4.4	COUNTERMEASURES TO ACHIEVE EMC COMPLIANCE.....	11
4.5	TEST SETUP DIAGRAM.....	11
5.	TEST RESULTS	13
5.1	TRANSMITTER REQUIREMENT & TEST SUITES	13
5.1.1	<i>Antenna Requirement</i>	<i>13</i>
5.1.2	<i>Peak Output Power</i>	<i>14</i>
5.1.3	<i>20dB Bandwidth</i>	<i>17</i>
5.1.4	<i>99% Bandwidth</i>	<i>20</i>
5.1.5	<i>Conducted spurious emissions and Frequency Band Edge measured in 100kHz Bandwidth ..</i>	<i>23</i>
5.1.6	<i>Spurious Emission</i>	<i>26</i>
5.1.7	<i>Frequency Separation.....</i>	<i>27</i>
5.1.8	<i>Number of hopping frequency.....</i>	<i>29</i>
5.1.9	<i>Time of Occupancy</i>	<i>31</i>
6.	SAFETY HUMAN EXPOSURE	33
6.1	RADIO FREQUENCY EXPOSURE COMPLIANCE.....	33
6.1.1	<i>Electromagnetic Fields.....</i>	<i>33</i>
7.	PHOTOGRAPHS OF THE TEST SET-UP	34
8.	LIST OF TABLES	36
9.	LIST OF PHOTOGRAPHS	36

1. General Remarks

1.1 Complementary Materials

All attachments are integral parts of this test report. This applies especially to the following appendix:

Appendix 1: Photo

(File:10035484APPENDIX1)

Appendix 2: Test Result of Radiated Emissions

(File:10035484APPENDIX2)

Test Specifications

The following standards were applied (in bold: product standards, otherwise: basic standards).

Table 1: Applied Standard and Test Levels

Radio
FCC CFR47 Part 15: Subpart C Section 15.247 DA 00-705 of March 30, 2000

2. Test Sites

2.1 Test Facilities

TUV Rheinland Taiwan Ltd.

11F. No.758, Sec. 4, Bade Rd., Songshan Dist.
 Taipei City 105
 Taiwan (R.O.C.)
 FCC Registration No.: 365730

2.2 List of Test and Measurement Instruments

Table 2: List of Test and Measurement Equipment

Kind of Equipment	Manufacturer	Type	S/N	Calibrated until
EMI Test Receiver	R&S	ESCI 7	1166.5950K0 7-100797-Pt	Nov. 09, 2012
Bilog Antenna	TESEQ	CBL6111D	29802	Oct. 01, 2012
Pre-Amplifier	HP	8447F	2805A03335	Dec. 22, 2012
Spectrum Analyzer	R&S	FSV 40	100921	Oct. 12, 2012
Horn Antenna (1GHz~18GHz)	COM-POWER	AHA118	701101	Dec. 27, 2012
Horn Antenna (18GHz~25GHz)	COM-POWER	AH840	101031	Oct. 1, 2012
Power meter	R&S	NRVD	100439	Mar. 25, 2012
Power sensor	R&S	NRV-Z1	100013	Mar. 25, 2012
Temp. & Humid. Chamber	Giant Force	GCT-099-40-S	MAF0103-007	May. 13, 2013

2.3 Traceability

All measurement equipment calibrations are traceable to NML(Taiwan)/NIST(USA) or where calibration is performed outside Taiwan, to equivalent nationally recognized standards organizations.

2.4 Calibration

Equipment requiring calibration is calibrated periodically by the manufacturer or according to manufacturer's specifications. Additionally all equipment is verified for proper performance on a regular basis using in house standards or comparisons.

2.5 Measurement Uncertainty

The estimated combined standard uncertainty for radiated emissions and conducted emissions measurements are $\pm 3\text{dB}$.

Table 3: Emission Measurement Uncertainty

Parameter	Uncertainty
Radio Frequency	$\pm 1 \times 10^{-7}$
RF power, conducted	$\pm 1 \text{ dB}$
Adjacent channel power	$\pm 3 \text{ dB}$
Radiated emission of transmitter, valid up to 26 GHz	$\pm 6 \text{ dB}$
Radiated emission of receiver, valid up to 26 GHz	$\pm 6 \text{ dB}$
Temperature	$\pm 2 \text{ }^\circ\text{C}$
Humidity	$\pm 10 \%$

3. General Product Information

3.1 Product Function and Intended Use

ThinkPad Bluetooth Laser Mouse is a wireless mouse with Bluetooth technology. For details refer to the User Guide, Data Sheet and Circuit Diagram.

3.2 Ratings and System Details

Table 4: Technical Specification of EUT

Technical Specification	Value
Kind of Equipment	ThinkPad Bluetooth Laser Mouse
Brand Name	lenovo
FCC ID	EMJMMOBTC9LA
IC ID	4521A-MMOBTC9LA
Type Designation	MOBTC9LA
Operating Frequency	2402 MHz ~ 2480 MHz
Channel Spacing	1 MHz
Channel number	79
Operation Voltage	DC 3V, from two AAA Alkaline batteries
Modulation	GFSK
Antenna gain	0.5 dBi

Table 5: Frequency hopping information

Technical Specification	Description
Hopping Range	Hereby we declare that the maximum frequency of this device is: 2402-2480MHz. This is according the Bluetooth Core Specification V2.1+EDR for devices which will be operated in the USA. This was checked during the Bluetooth Qualification tests (Test Case: TRM/CA/04).
Hopping Sequence	Example of a 79 hopping sequence in data mode: 33,04,21,44,23,42,53,46,55,48,40,59,72,29,76,31,08,73,07,75,09,45,60,39,58,13,47,11,77,52,35,50,65,54,67,56,69,62,71,64, 7,25,27,66,57,70,74,61,78,63,10,41,05,43,15,44,64,68,02,70,06,01,51,03,55,05,03,66,53,49,36,47,
Receiver input bandwidth	<p>The input bandwidth of the receiver is 1MHz. In every connection one Bluetooth device is the master and the other one is the slave. The master determines the hopping sequence. The slave follows this sequence. Both devices shift between RX and TX time slot according to the clock of the master.</p> <p>Additionally the type of connection is set up at the beginning of the connection. The master adapts its hopping frequency and its TX/RX timing according to the packet type of the connection. Also the slave of the connection will use these settings.</p> <p>Repeating of a packer has no influence on the hopping sequence. The hopping sequence generated by the master of the connection will be followed in any case.</p> <p>That means a repeated packet will not be send on the same frequency, it is send on the next frequency of the hopping sequence.</p>

3.3 Independent Operation Modes

The basic operation modes are:

- A. Transmitting
 - 1. Low channel
 - 2. Middle channel
 - 3. High channel
- B. Receiving
- C. Standby
- D. Off

3.4 Noise Generating and Noise Suppressing Parts

Refer to the Circuit Diagram.

3.5 Submitted Documents

- Bill of Material
- PCB Layout
- Photo Document
- Technical Description
- Circuit Diagram
- Instruction Manual
- Rating Label

4. Test Set-up and Operation Modes

4.1 Principle of Configuration Selection

The equipment under test (EUT) was configured to measure its maximum power level. The test modes were adapted accordingly in reference to the instructions for use.

4.2 Test Operation and Test Software

Test operation refers to test setup in chapter 4. All testing were performed according to the procedures in ANSI C63.10: 2009 and DA 00-705 of March 30, 2000.

Full test was applied on all test modes, but only worst case was shown.

4.3 Special Accessories and Auxiliary Equipment

The product has been tested together with the following additional accessories:

Kind of Equipment	Manufacturer	Model Name	S/N
Laptop	MSI	MSI4532 (CX420MX)	CX420 MX-233TWK 1008000096

4.4 Countermeasures to achieve EMC Compliance

The test sample which has been tested contained the noise suppression parts as described in the Constructional Data Form or the Technical Construction File. No additional measures were employed to achieve compliance.

4.5 Test Setup Diagram

Diagram of Measurement Configuration for Radiation Test

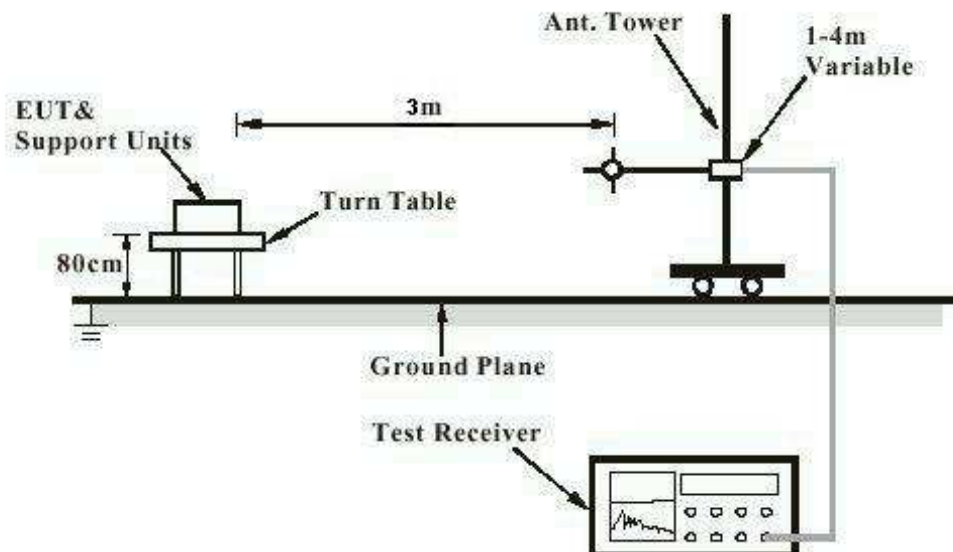
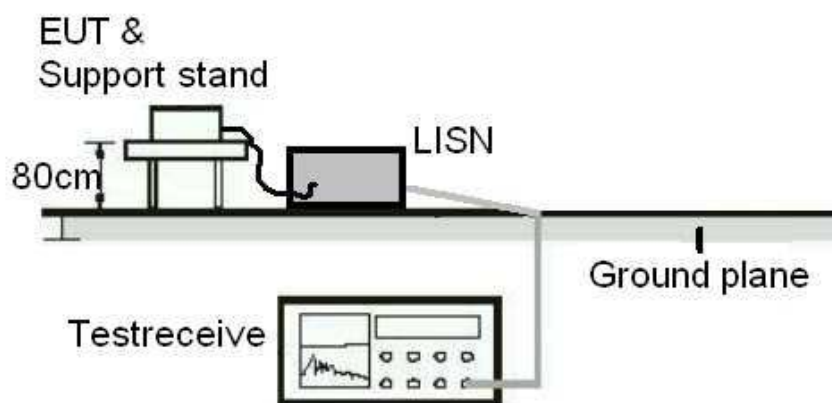
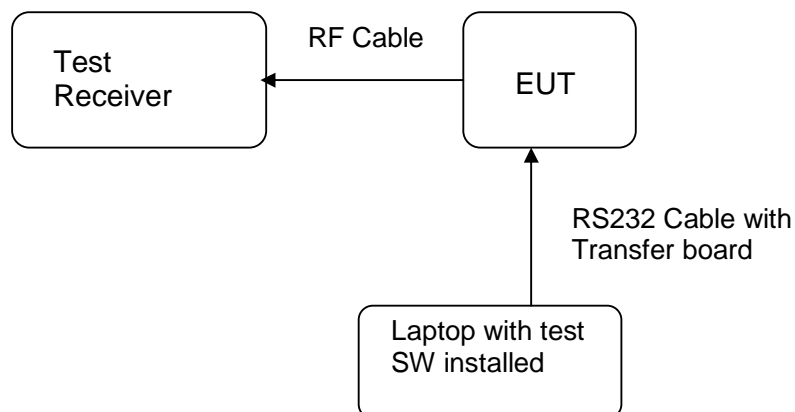

Diagram of Measurement Equipment Configuration for Mains Conduction Measurement

Diagram of Measurement Equipment Configuration for Conducted Transmitter Measurement

5. Test Results

5.1 Transmitter Requirement & Test Suites

5.1.1 Antenna Requirement

RESULT: **Passed**

Test date : 2012-02-23
Test standard : FCC Part 15.247(b)(4), Part 15.203 and
RSS-Gen 7.1.4
Limit : the use of antennas with directional gains that do
not exceed 6 dBi

According to the manufacturer declaration, the EUT has an internal antenna with an directional gain of 0.5 dBi, and the antenna is a printed PCB trace with no possibility of replacement. Therefore, the EUT is considered to comply the provision.

Refer to EUT photo for details.

5.1.2 Peak Output Power

RESULT:
Passed

Test date : 2012-02-23
 Test standard : FCC Part 15.247(b)(1), RSS-210 A8.4(2)
 Basic standard : DA 00-705 of March 30, 2000
 Limit : 1 Watt (EBW<1MHz) 0.125W (EBW>1MHz)
 Kind of test site : Shielded room

Test setup

Test Channel : Low/ Middle/ High
 Operation Mode : A
 Ambient temperature : 22°C
 Relative humidity : 52%
 Atmospheric pressure : 102 kPa

Table 6: Test result of Peak Output Power, GFSK modulation

Channel	Channel Frequency (MHz)	Peak Output Power		Limit (W)
		(dBm)	(W)	
Low Channel	2402	0.46	0.0011	1
Middle Channel	2441	1.19	0.0013	1
High Channel	2480	1.64	0.0015	1

Test Plot of Peak Output Power, GFSK modulation

Low Channel

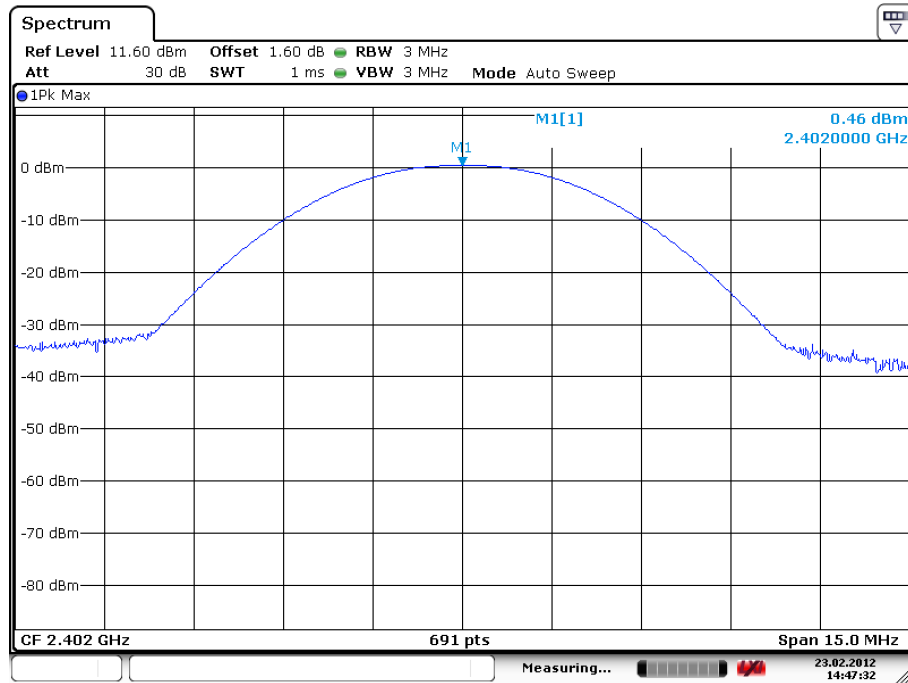

Date: 23.FEB.2012 14:47:33

Middle Channel

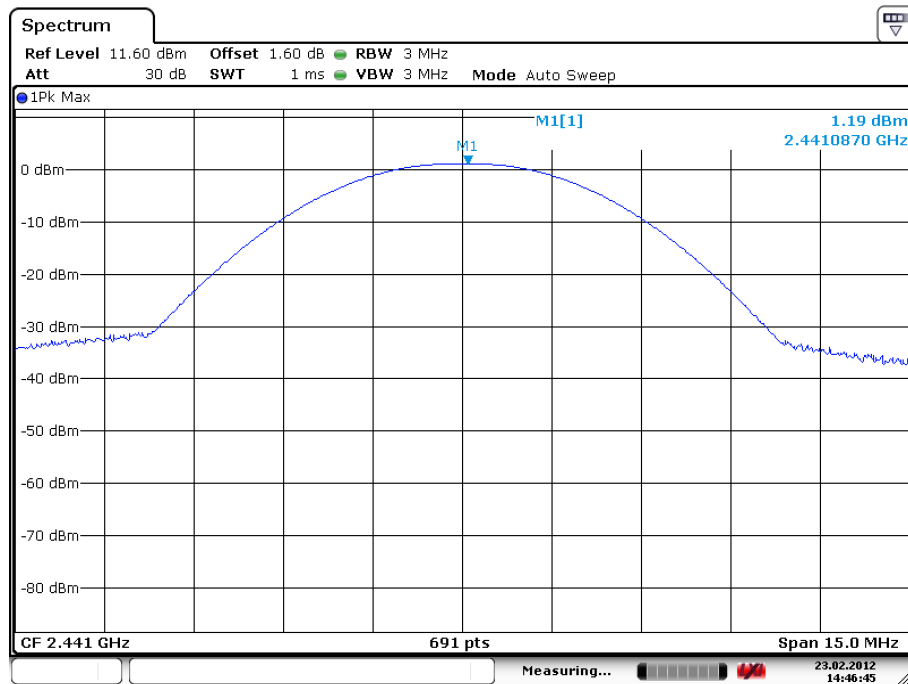

Date: 23.FEB.2012 14:46:45

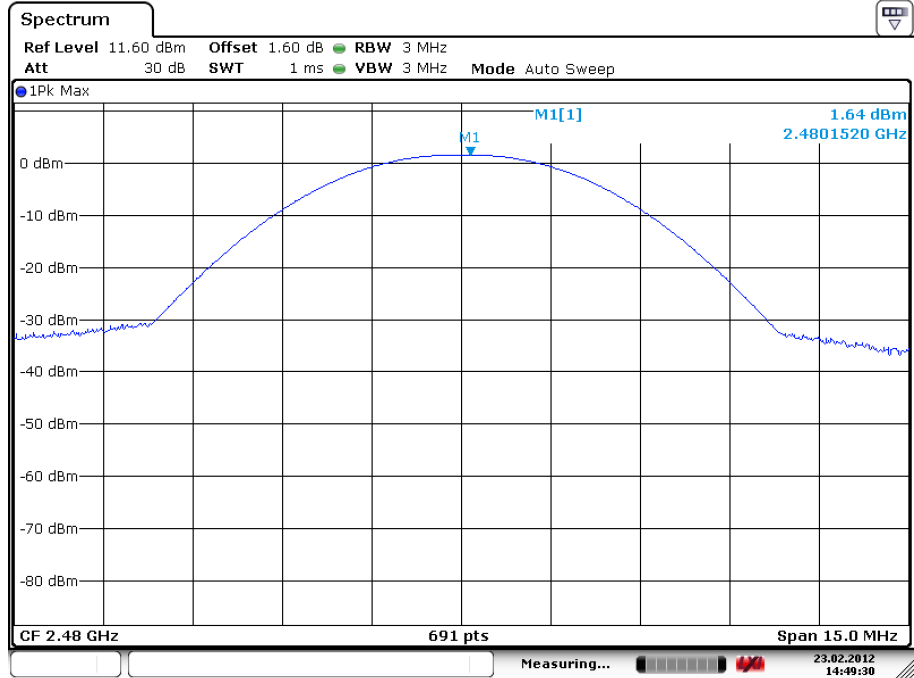
High Channel

Date: 23.FEB.2012 14:49:31

5.1.3 20dB Bandwidth

RESULT:**Passed**

Date of testing : 2012-02-23
Test standard : FCC Part 15.247(a)(1), RSS-210 A8.1(a)
Basic standard : DA 00-705 of March 30, 2000
Kind of test site : Shielded room

Test setup

Test Channel : Low/ Middle/ High
Operation Mode : A
Ambient temperature : 24°C
Relative humidity : 53%
Atmospheric pressure : 102 kPa

Table 7: Test result of 20dB Bandwidth, GFSK modulation

Channel	Channel Frequency (MHz)	20dB Bandwidth (kHz)	Limit (MHz)	Result
Low Channel	2402	987.0	/	Pass
Mid Channel	2441	984.1	/	Pass
High Channel	2480	989.9	/	Pass

Test Plot of 20dB Bandwidth, GFSK modulation

Low Channel

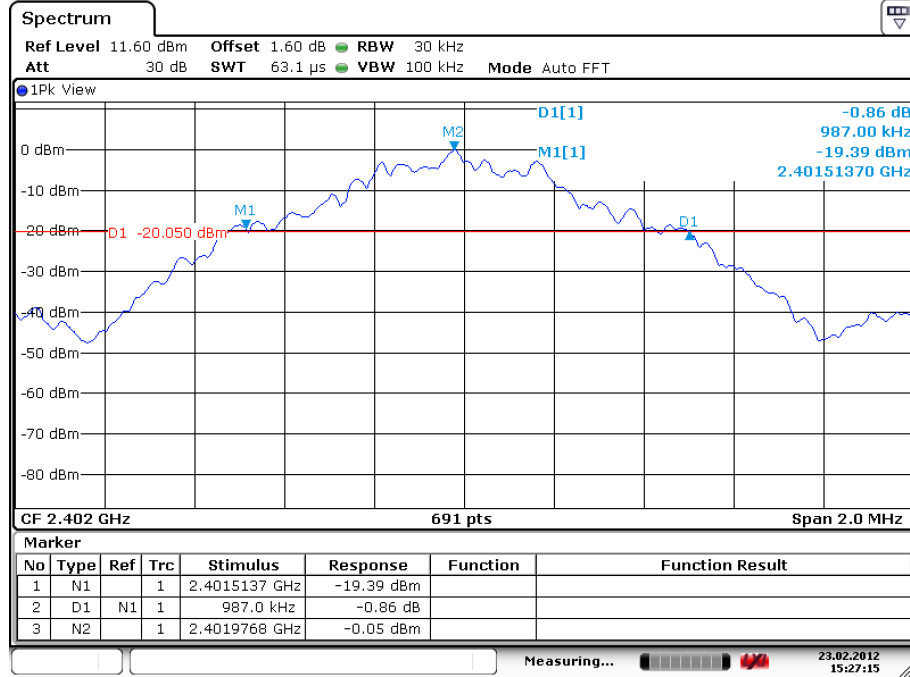

Date: 23.FEB.2012 15:27:15

Middle Channel

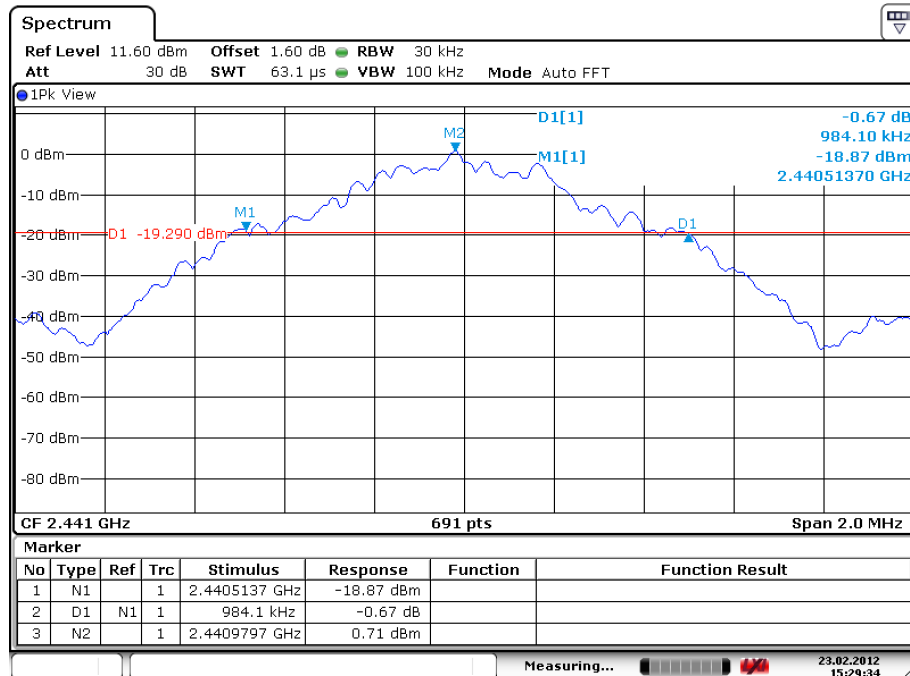

Date: 23.FEB.2012 15:29:35

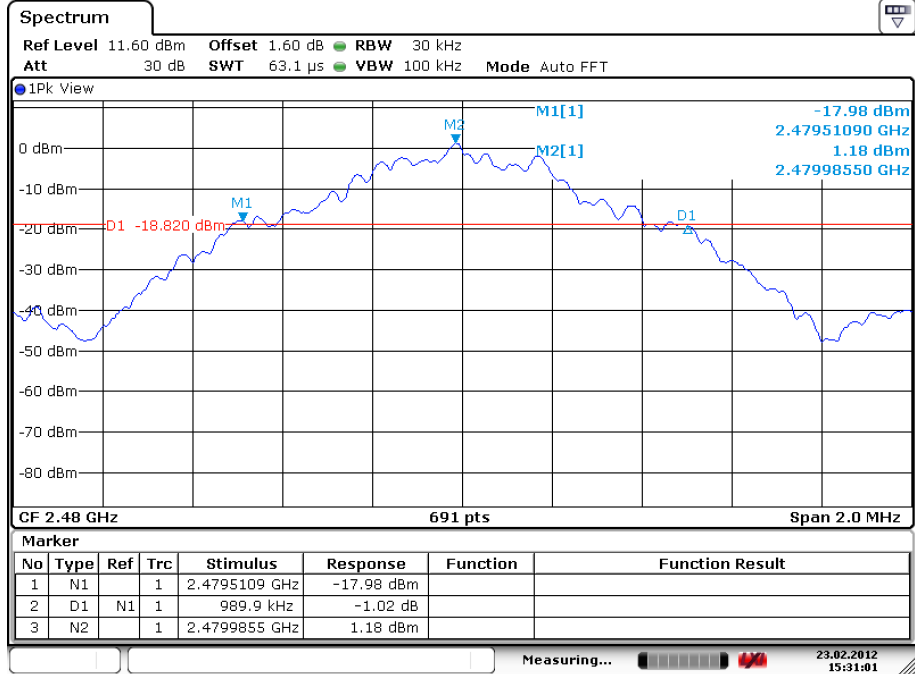
High Channel

Date: 23.FEB.2012 15:31:01

5.1.4 99% Bandwidth**RESULT:****Passed**

Date of testing : 2012-02-23
Test standard : RSS-Gen (Issue 3) Dec. 2010
Basic standard : RSS-Gen (Issue 3) Dec. 2010
Kind of test site : Shielded room

Test setup

Test Channel : Low/ Middle/ High
Operation Mode : A
Ambient temperature : 24°C
Relative humidity : 53%
Atmospheric pressure : 102 kPa

Table 8: Test result of 20dB Bandwidth, GFSK modulation

Channel	Channel Frequency (MHz)	99% Bandwidth (kHz)	Limit (MHz)	Result
Low Channel	2402	946.45	/	Pass
Mid Channel	2441	934.88	/	Pass
High Channel	2480	917.51	/	Pass

Test Plot of 99% Bandwidth, GFSK modulation

Low Channel

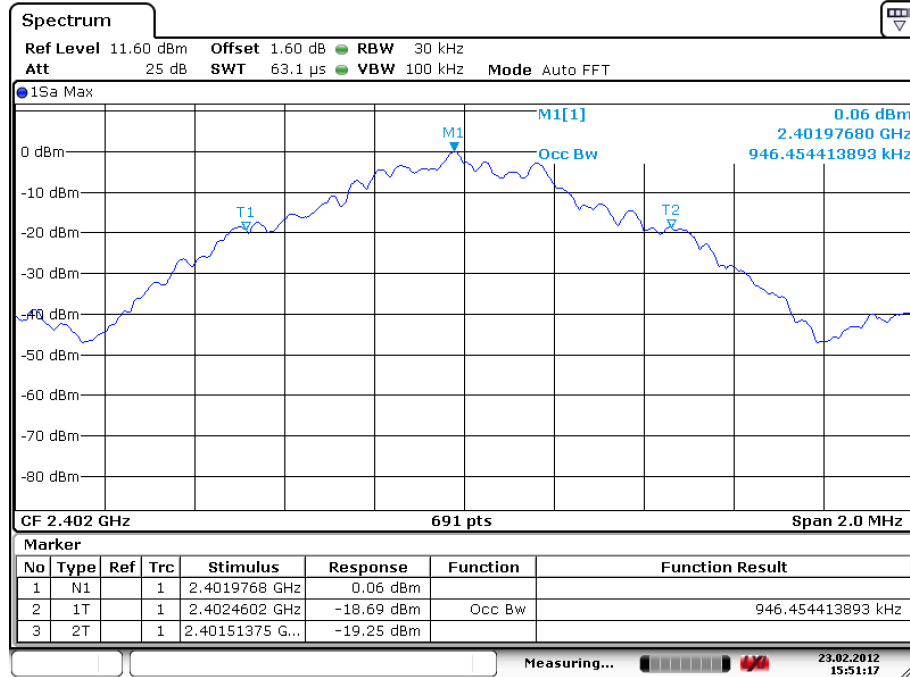

Date: 23.FEB.2012 15:51:17

Middle Channel

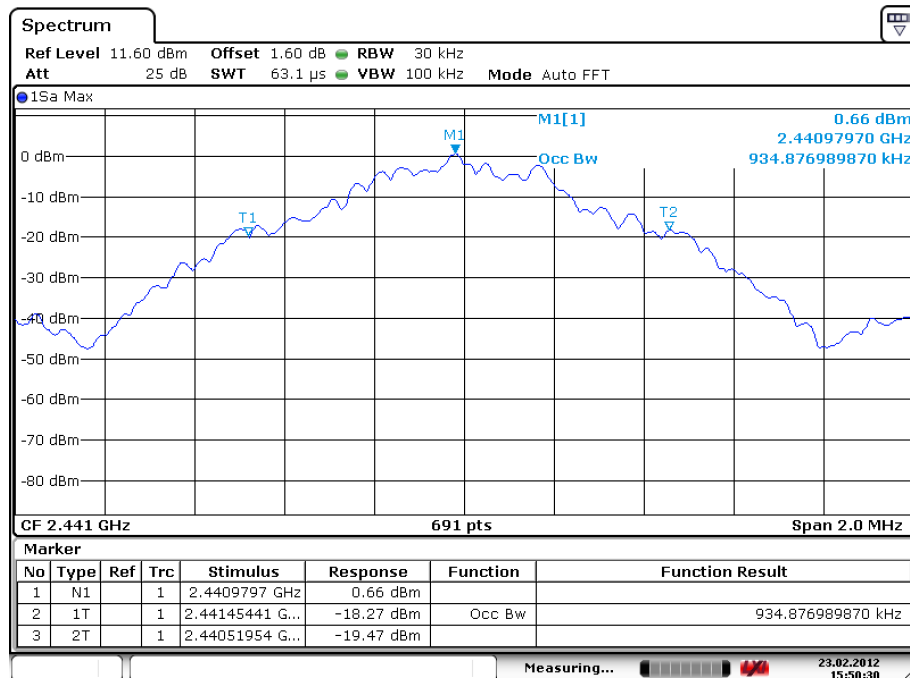

Date: 23.FEB.2012 15:50:30

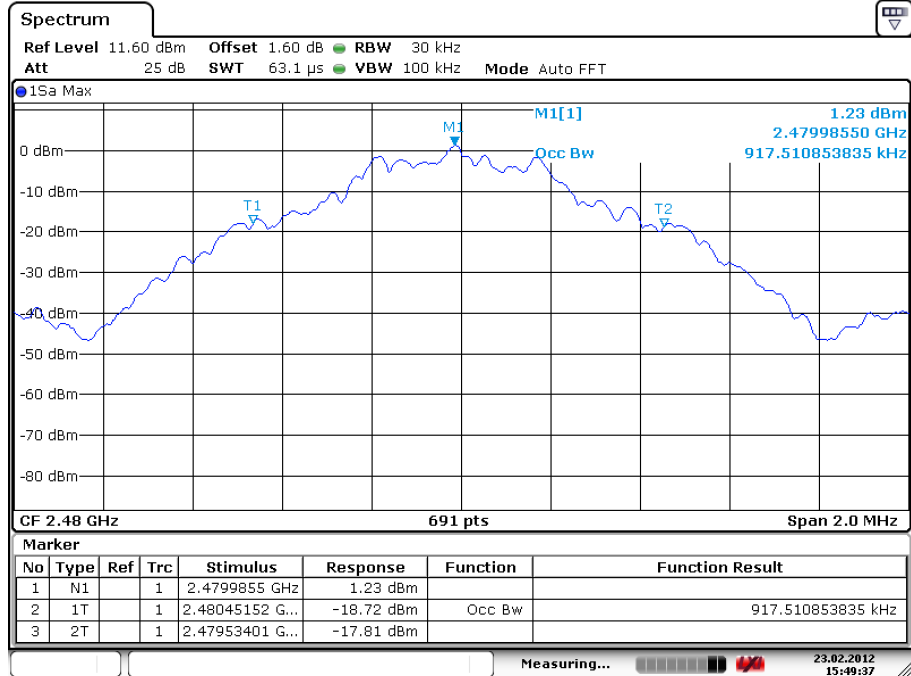
High Channel

Date: 23.FEB.2012 15:49:37

5.1.5 Conducted spurious emissions and Frequency Band Edge measured in 100kHz Bandwidth

RESULT: **Passed**

Date of testing : 2012-02-23
Test standard : FCC part 15.247(d), RSS-210 A8.5
Basic standard : DA 00-705 of March 30, 2000
Limit : 20dB (below that in the 100kHz bandwidth within the band that contains the highest level of the desired power)
Kind of test site : Shielded room

Test setup

Test Channel : Low/ High
Operation mode : A
Ambient temperature : 22°C
Relative humidity : 52%
Atmospheric pressure : 102 kPa

All emissions are more than 20dB below fundamental, details refer to following test plot, and compliance is achieved as well.

Due to the small size of the product and that there are no inductive components of significant size, 9kHz to 30MHz frequency range is not tested based on technical judgment.

Test Plot of 100kHz Conducted Emissions, GFSK modulation

Low Channel

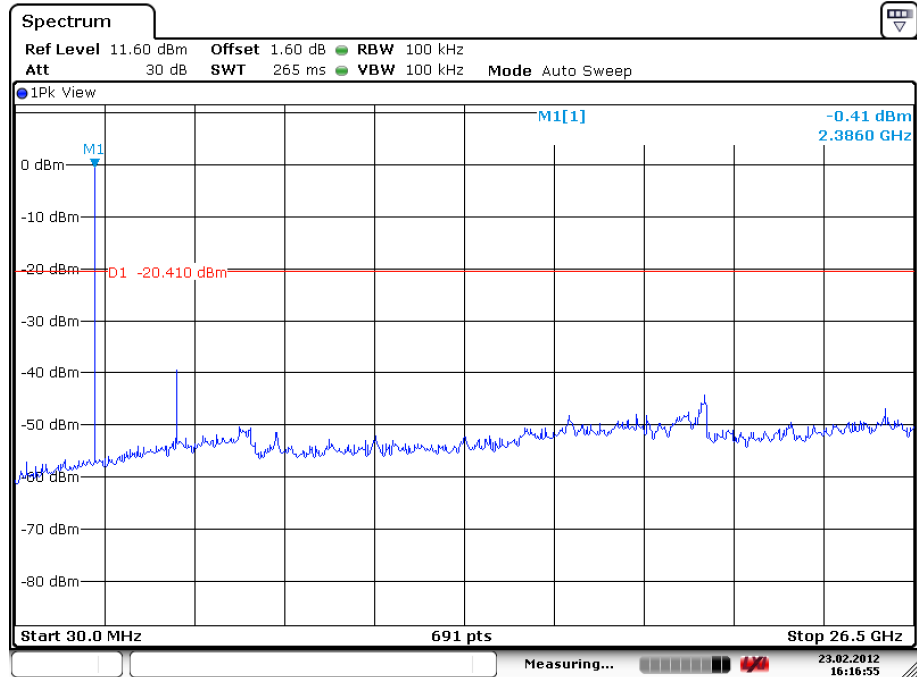

Date: 23.FEB.2012 16:16:55

High Channel

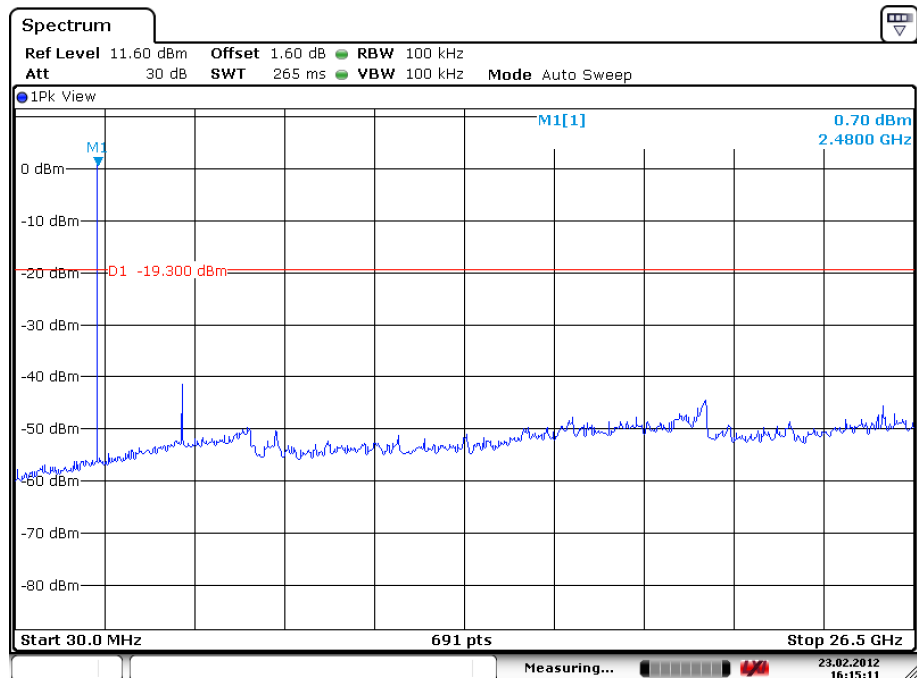

Date: 23.FEB.2012 16:15:11

Test Plot of 100kHz Bandwidth of Frequency Band Edge, GFSK modulation

Low Channel

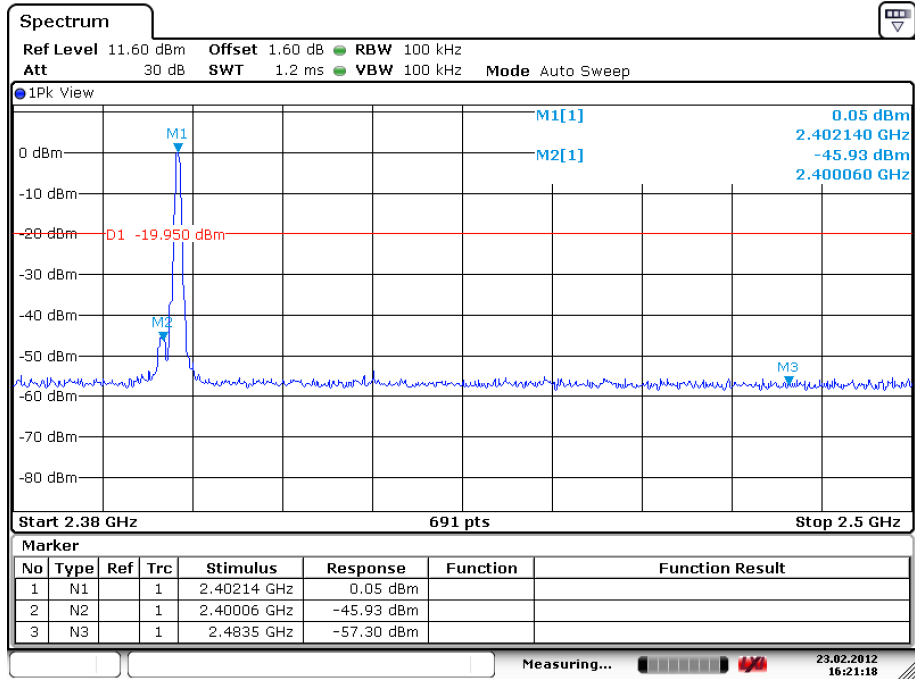

Date: 23.FEB.2012 16:21:18

High Channel

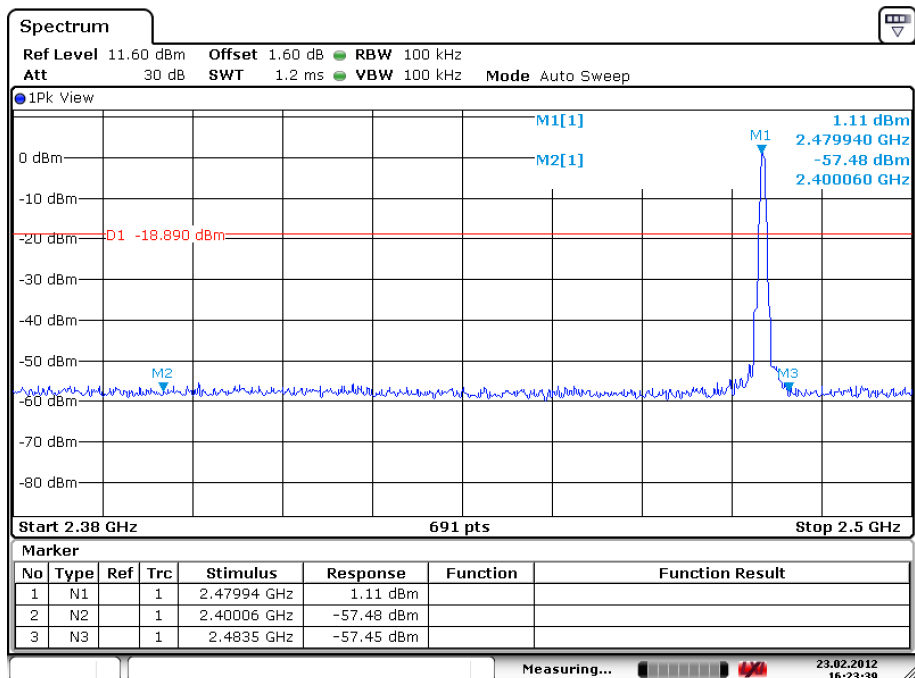

Date: 23.FEB.2012 16:23:40

5.1.6 Spurious Emission

RESULT:**Passed**

Date of testing	:	2012-02-29
Test standard	:	FCC part 15.247(d), FCC 15.205, FCC 15.209, RSS-210 2.2, RSS-210 A8.5 and RSS-Gen 7.2.1
Basic standard	:	ANSI C63.10: 2009
Limits	:	Radiated emissions which fall in the restricted bands, as defined in FCC 15.205(a) and RSS-210 2.7 (Table 1), must comply with the radiated emission limits specified in FCC 15.209(a) and RSS-210 2.7 (Table 2 and 3). Emission radiated outside the specified frequency bands must comply with the radiated emission limits specified in FCC 15.209(a) and FCC 15.249(a), RSS-210 2.7 (Table 2 and 3) and RSS-210 A2.9(a).
Kind of test site	:	3m Semi-Anechoic Chamber

Test setup

Test Channel	:	Low/ Middle/ High
Operation mode	:	A, C
Ambient temperature	:	24°C
Relative humidity	:	56%
Atmospheric pressure	:	102 kPa

Remark: Testing was carried out within frequency range 30MHz to the tenth harmonic. For details refer to Appendix 2. The Radiated Emissions testing was performed in the X, Y and Z axis orientation. The X Axis orientation is the worst-case and recorded in this test report. Due to the small size of the product and that there are no inductive components of significant size, 9kHz to 30MHz frequency range is not tested based on technical judgment.

5.1.7 Frequency Separation

RESULT:
Passed

Date of testing : 2012-02-23
 Test standard : FCC part 15.247(a)(1), RSS-210 A8.1(b)
 Basic standard : DA 00-705 of March 30, 2000
 Limit : $\geq 25\text{kHz}$ or $2/3$ of 20dB bandwidth, whichever is greater

Test setup

Test Channel : Low/ Middle/ High
 Operation Mode : A
 Ambient temperature : 24°C
 Relative humidity : 53%
 Atmospheric pressure : 102 kPa

Table 9: Test result of Frequency Separation

Channel	Channel Frequency (MHz)	Measured Channel Separation (MHz)	Limit (kHz)	Result
Record Channel	2441	1	$\geq 25\text{kHz}$ or $2/3$ of 20dB bandwidth	Pass
Record Channel adj 1	2440			
Record Channel adj 2	2442			

Test Plot of Frequency Separation

GFSK

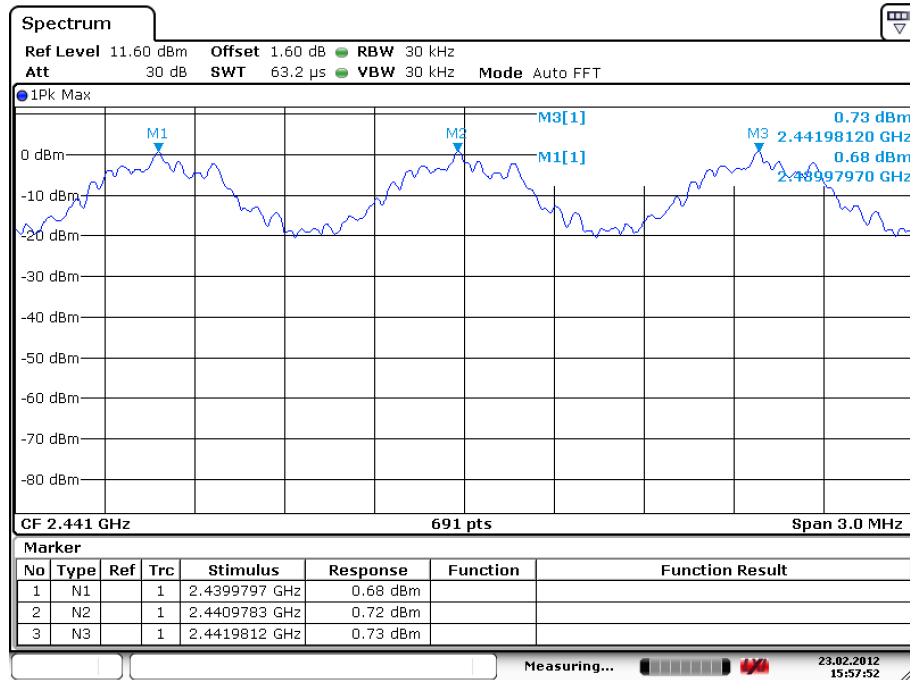

Date: 23.FEB.2012 15:57:52

5.1.8 Number of hopping frequency

RESULT:**Passed**

Date of testing : 2012-02-23
Test standard : FCC part 15.247(a)(1)(iii), RSS-210 A8.1(d)
Basic standard : DA 00-705 of March 30, 2000
Limits : ≥ 15 non-overlapping channels
Kind of test site : Shield room

Test setup

Test Channel : Low/ Middle/ High
Operation Mode : A
Ambient temperature : 24°C
Relative humidity : 53%
Atmospheric pressure : 102 kPa

Table 10: Test result of Number of hopping frequency

Frequency Range	Measured Quantity of Hopping Channel	Limit	Result
2400 to 2483.5 MHz	79	≥ 15	Pass

Test Plot of Number of hopping frequencies

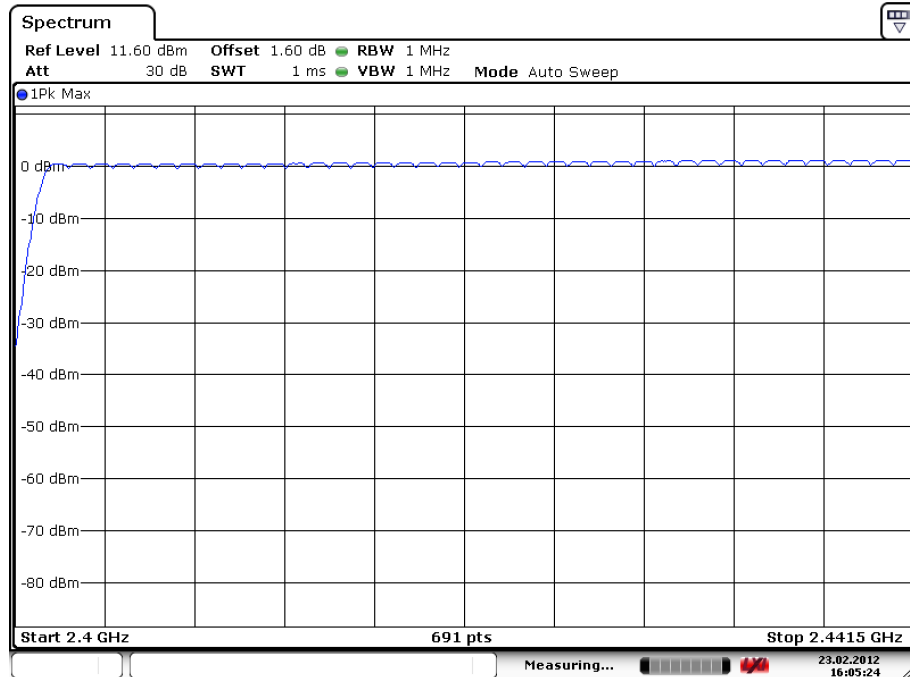

Date: 23.FEB.2012 16:05:24

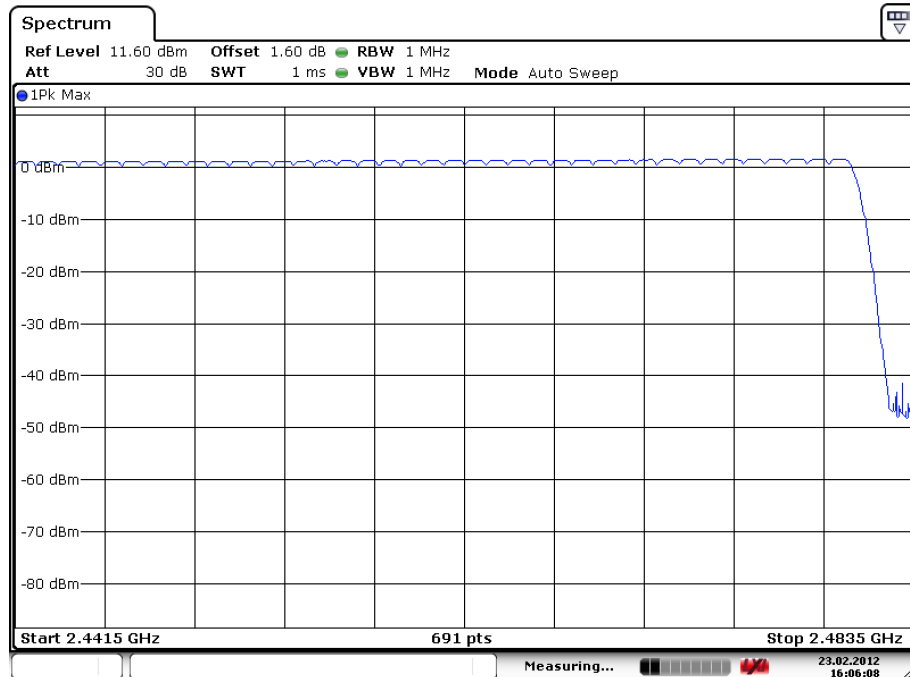

Date: 23.FEB.2012 16:06:08

5.1.9 Time of Occupancy

RESULT:
Passed

Date of testing : 2012-02-23
 Test standard : FCC part 15.247(a)(1)(iii) , RSS-210 A8.1(d)
 Basic standard : DA 00-705 of March 30, 2000
 Limits : 0.4s
 Kind of test site : Shield room

Test setup

Test Channel : Low/ Middle/ High
 Operation Mode : A
 Ambient temperature : 24°C
 Relative humidity : 53%
 Atmospheric pressure : 102 kPa

Table 11: Test result of Time of Occupancy

Data Mode	Captured Burst (s)	Dwell time (s)	Limit (s)	Result
DH5	0.0030	0.3197	0.4	Pass

Note:

$$\text{Dwell time} = \text{Pulse width} \times (\text{Hopping rate} / \text{Number of channels}) \times \text{Period}$$

$$\text{Period} = 0.4 \text{ (seconds/ channel)} \times 79 \text{ (channel)} = 31.6 \text{ seconds}$$

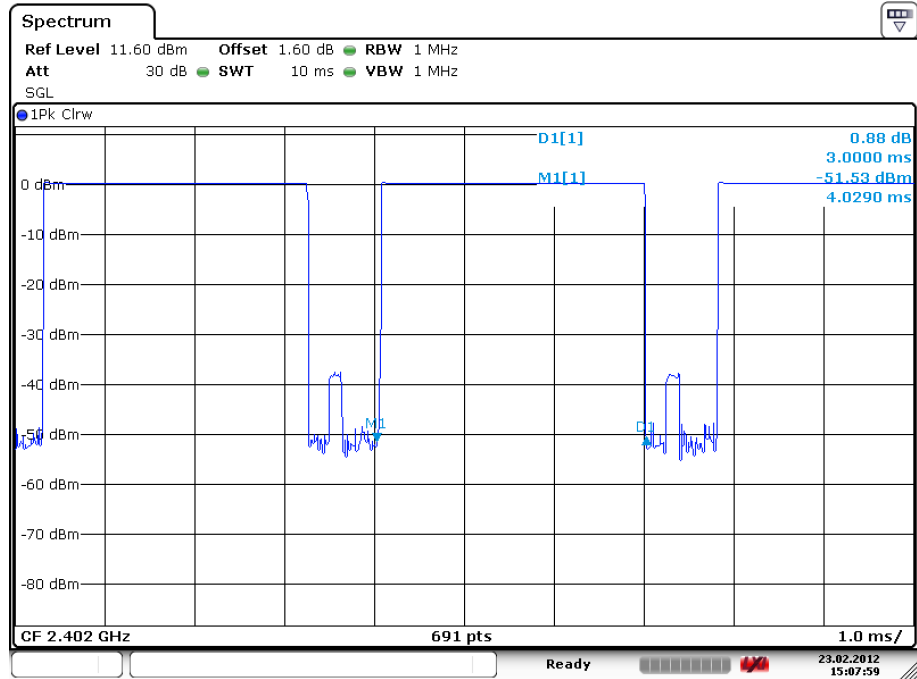
Test Plot of Time of Occupancy, GFSK modulation

Date: 23.FEB.2012 15:08:00

6. Safety Human exposure

6.1 Radio Frequency Exposure Compliance

6.1.1 Electromagnetic Fields

RESULT:**Passed**

Test standard : FCC KDB Publication 447498

Since maximum peak output power of the transmitter is $<60/f(\text{GHz})\text{mW}$, i.e.
 $1.5\text{mW} < 25(=60/2.4)\text{mW}$, hence the EUT is excluded from SAR evaluation according to FCC
KDB publication 447498 D01: Mobile Portable RF Exposure.

7. Photographs of the Test Set-Up

Photograph 1: Set-up for Spurious Emissions (Front View)



Photograph 2: Set-up for Spurious Emissions (Back View 1)



Photograph 3: Set-up for Spurious Emissions (Back View 2)



Photograph 4: Set-up for Conducted testing

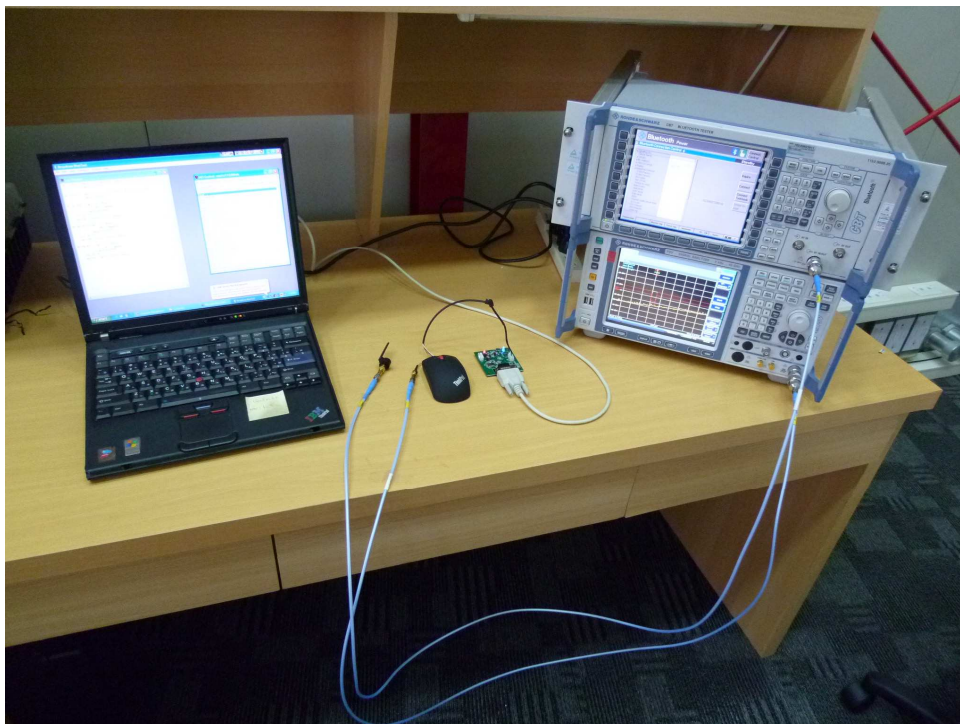

8. List of Tables

Table 1: Applied Standard and Test Levels	4
Table 2: List of Test and Measurement Equipment	5
Table 3: Emission Measurement Uncertainty.....	6
Table 4: Technical Specification of EUT	7
Table 5: Frequency hopping information.....	8
Table 6: Test result of Peak Output Power, GFSK modulation.....	14
Table 7: Test result of 20dB Bandwidth, GFSK modulation.....	17
Table 8: Test result of 20dB Bandwidth, GFSK modulation.....	20
Table 9: Test result of Frequency Separation	27
Table 10: Test result of Number of hopping frequency.....	29
Table 11: Test result of Time of Occupancy.....	31

9. List of Photographs

Photograph 1: Set-up for Spurious Emissions (Front View).....	34
Photograph 2: Set-up for Spurious Emissions (Back View 1).....	34
Photograph 3: Set-up for Spurious Emissions (Back View 2).....	35
Photograph 4: Set-up for Conducted testing.....	35

Test Report No. 10035761 001

Appendix 1: IUT Photos

(File: 10035761Appendix1)

Product: ThinkPad Bluetooth Laser Mouse

Type Designation: MOBTC9LA



Product: ThinkPad Bluetooth Laser Mouse

Type Designation: MOBTC9LA



Product: ThinkPad Bluetooth Laser Mouse

Type Designation: MOBTC9LA

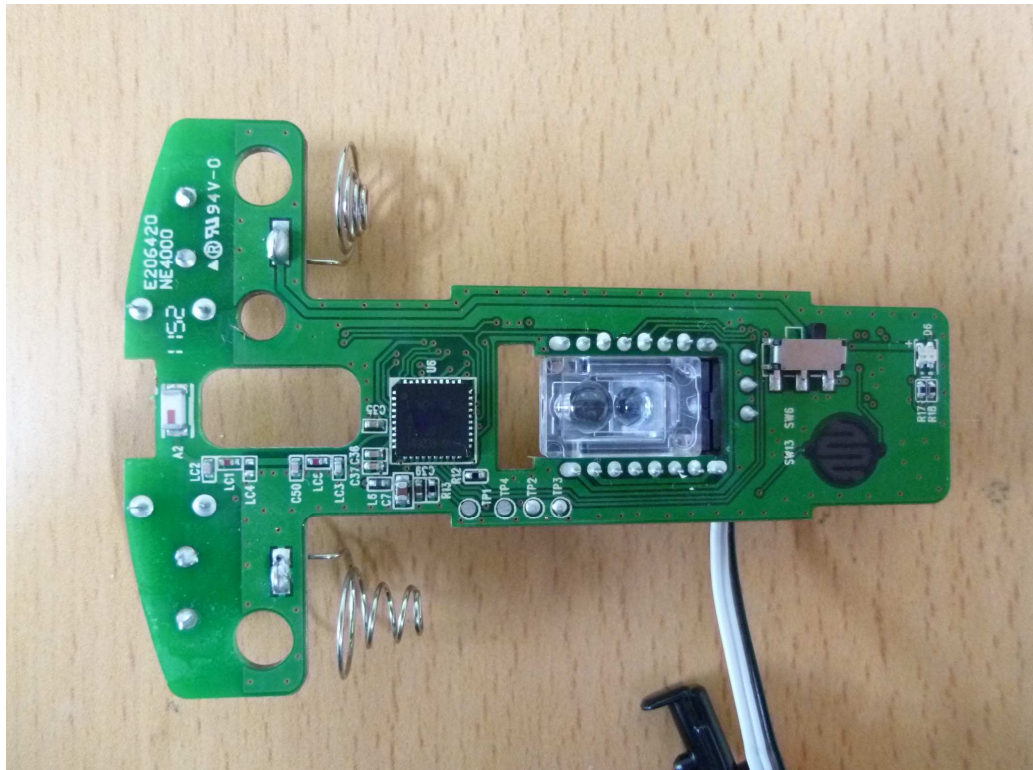
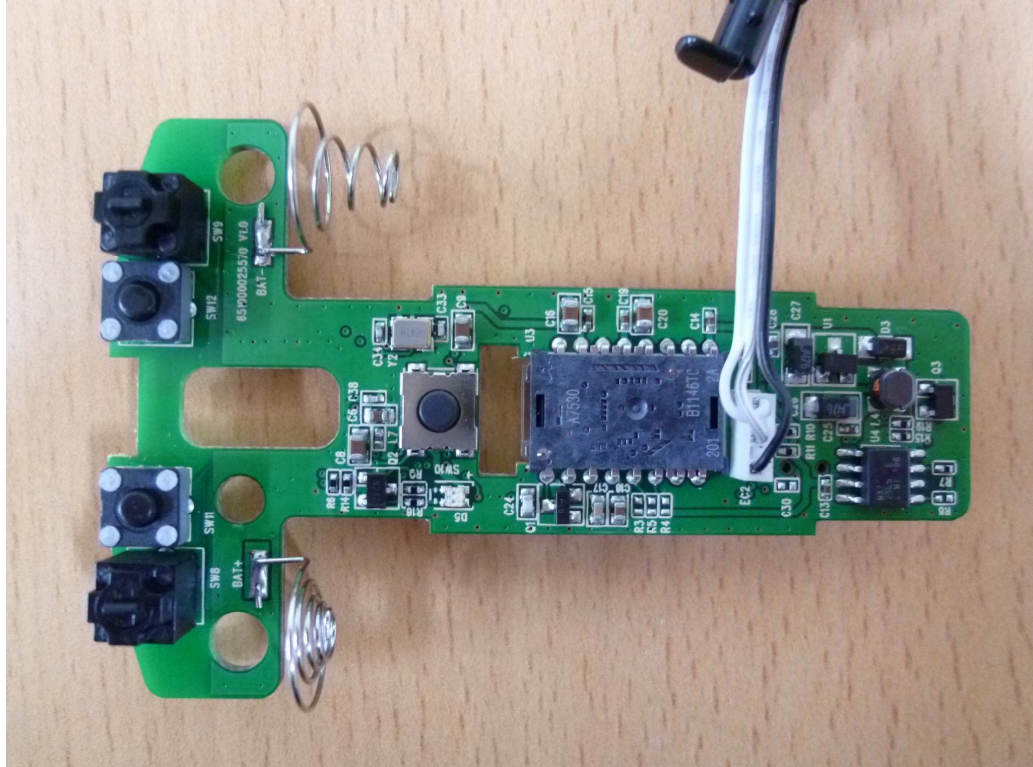

Product: ThinkPad Bluetooth Laser Mouse

Type Designation: MOBTC9LA

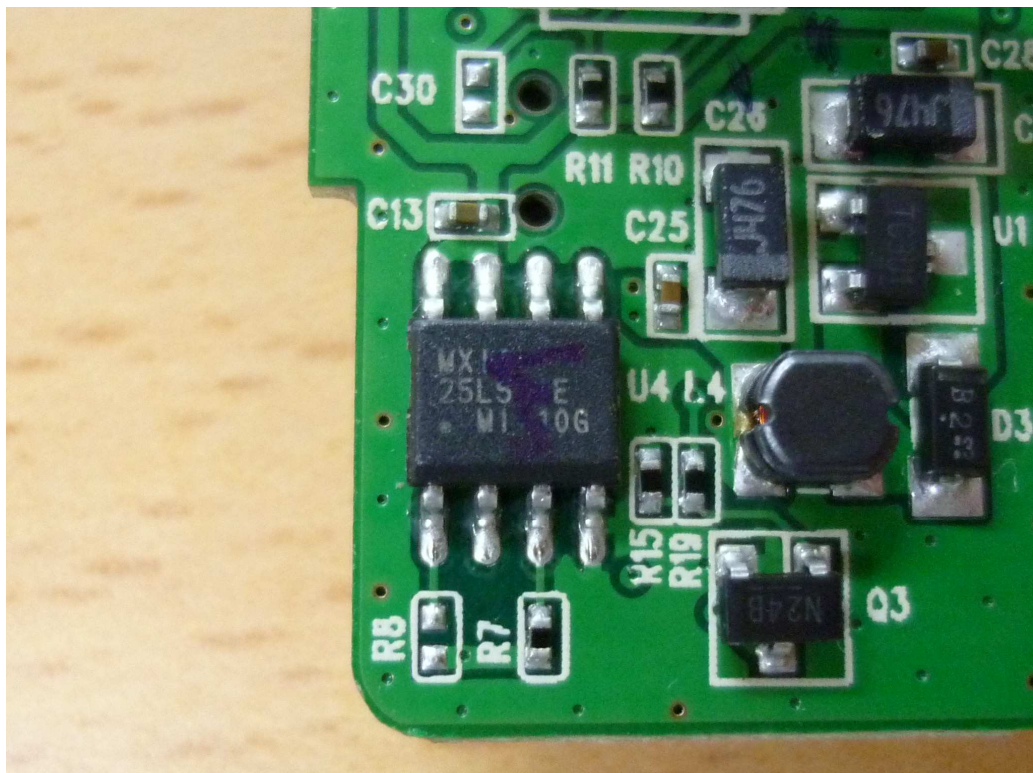
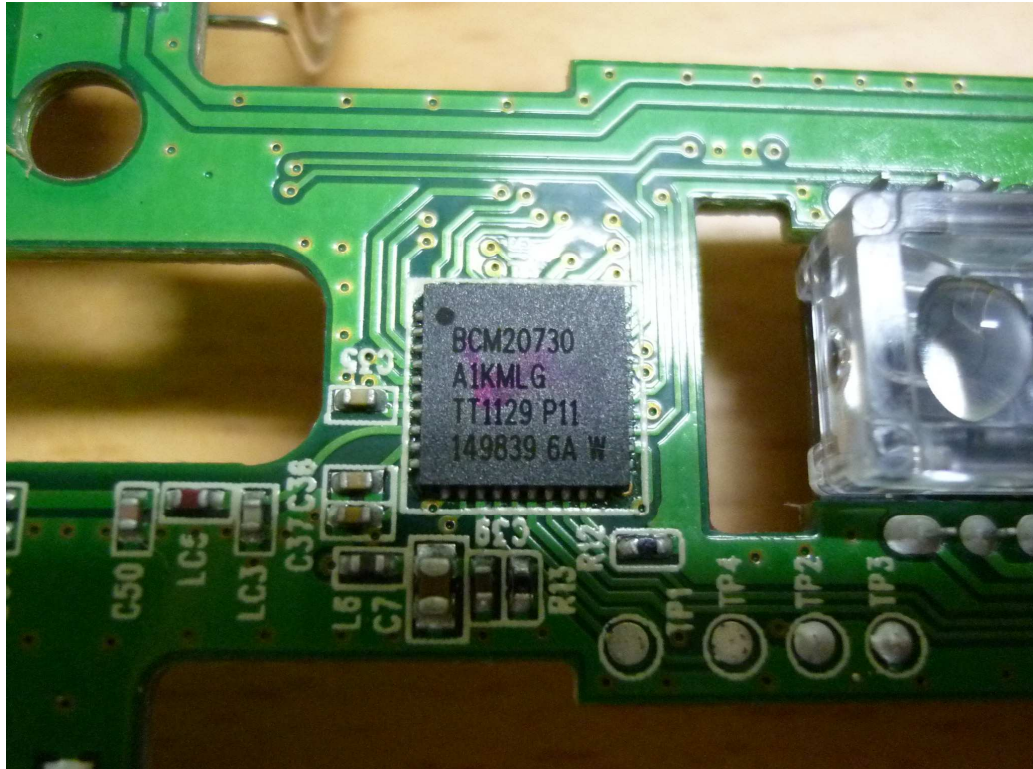

Product: ThinkPad Bluetooth Laser Mouse

Type Designation: MOBTC9LA

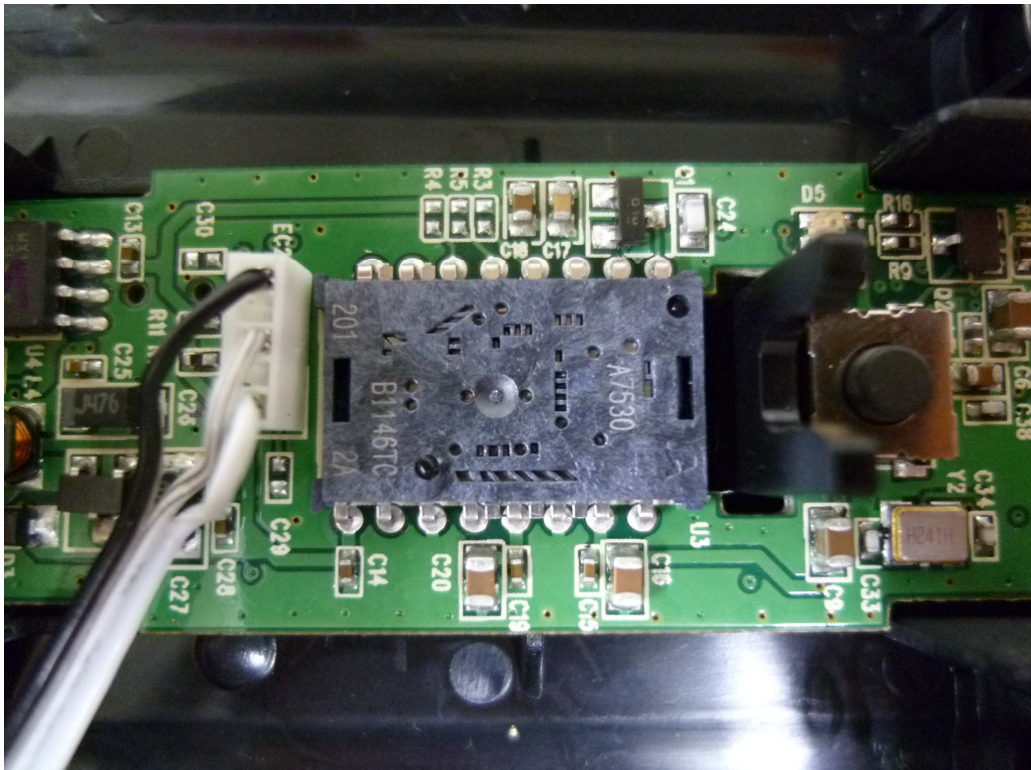

Test Report No. 10035761 001

Appendix 2: Radiated Spurious Emission

(File: 10035761Appendix2)

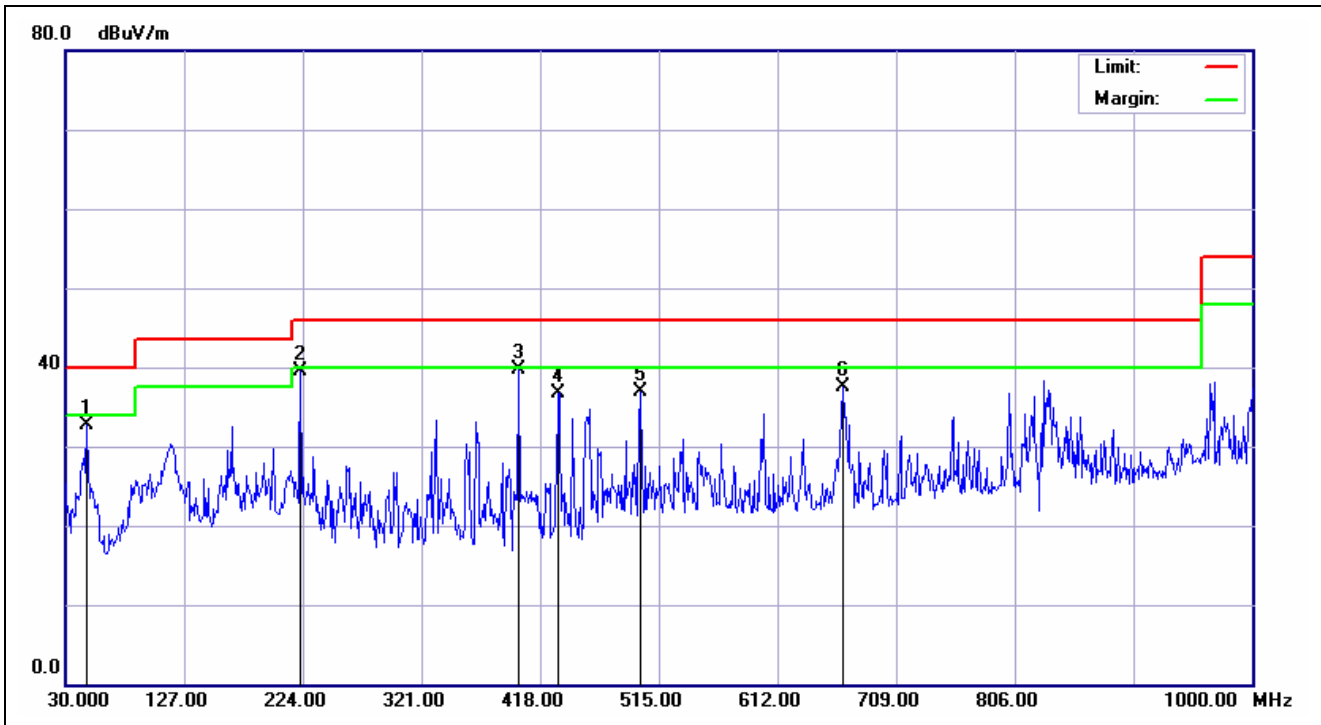

Service No.:	113152207-RF	Test Distance:	3m
Test Standard:	FCC Class B 3M Radiation	Ant. Polarization:	Vertical
Test item:	Radiation Emission	Test Time:	2012/2/23 AM 10:47:19
Applicant:	Lenovo	Test Rating:	DC 3V
Product:	Bluetooth mouse	Temp.(°C)/Hum.(%):	21(°C)/64%
Model No.:	MOBTC9LA	Test Engineer:	Howard Lin
Test Mode:	Operated mode		
Remark:	BT 2402		

No.	Frequency (MHz)	Factor (dB/m)	Reading (dBuV)	Level (dBuV/m)	Limit (dBuV/m)	Margin (dB)	Det.	Height (cm)	Azimuth (°)	Remark
1	47.4600	-17.01	49.68	32.67	40.00	-7.33	QP			
2	222.0600	-15.35	54.78	39.43	46.00	-6.57	QP			
3	400.5400	-8.91	48.67	39.76	46.00	-6.24	QP			
4	433.5199	-8.77	45.55	36.78	46.00	-9.22	QP			
5	500.4499	-7.58	44.54	36.96	46.00	-9.04	QP			
6	665.3500	-5.18	42.71	37.53	46.00	-8.47	QP			

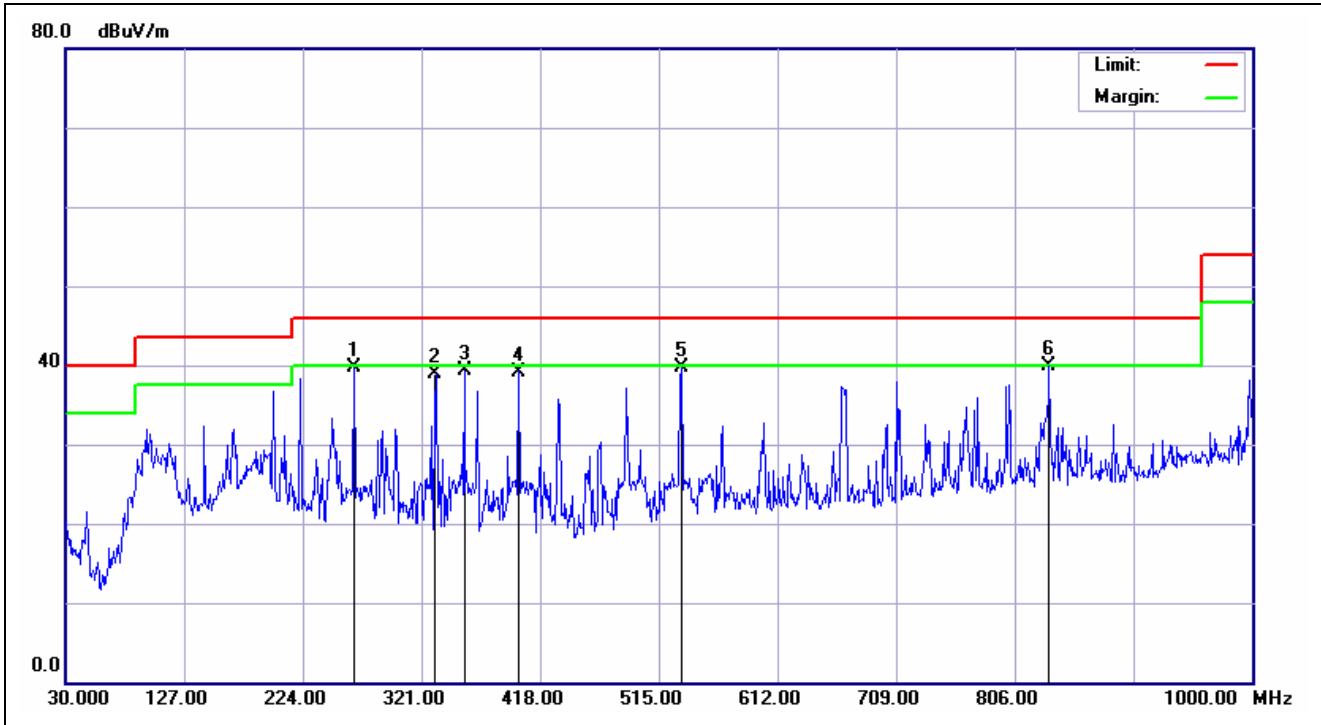

Service No.:	113152207-RF	Test Distance:	3m
Test Standard:	FCC Class B 3M Radiation	Ant. Polarization:	Horizontal
Test item:	Radiation Emission	Test Time:	2012/2/23 AM 10:42:20
Applicant:	Lenovo	Test Rating:	DC 3V
Product:	Bluetooth mouse	Temp.(°C)/Hum.(%):	21(°C)/64%
Model No.:	MOBTC9LA	Test Engineer:	Howard Lin
Test Mode:	Operated mode		
Remark:	BT 2402		

No.	Frequency (MHz)	Factor (dB/m)	Reading (dBuV)	Level (dBuV/m)	Limit (dBuV/m)	Margin (dB)	Det.	Height (cm)	Azimuth (°)	Remark
1	265.7099	-11.57	51.34	39.77	46.00	-6.23	QP			
2	332.6399	-10.56	49.46	38.90	46.00	-7.10	QP			
3	355.9200	-10.03	49.26	39.23	46.00	-6.77	QP			
4	400.5400	-8.91	48.11	39.20	46.00	-6.80	QP			
5	533.4298	-6.46	46.13	39.67	46.00	-6.33	QP			
6	834.1299	-2.39	42.24	39.85	46.00	-6.15	QP			

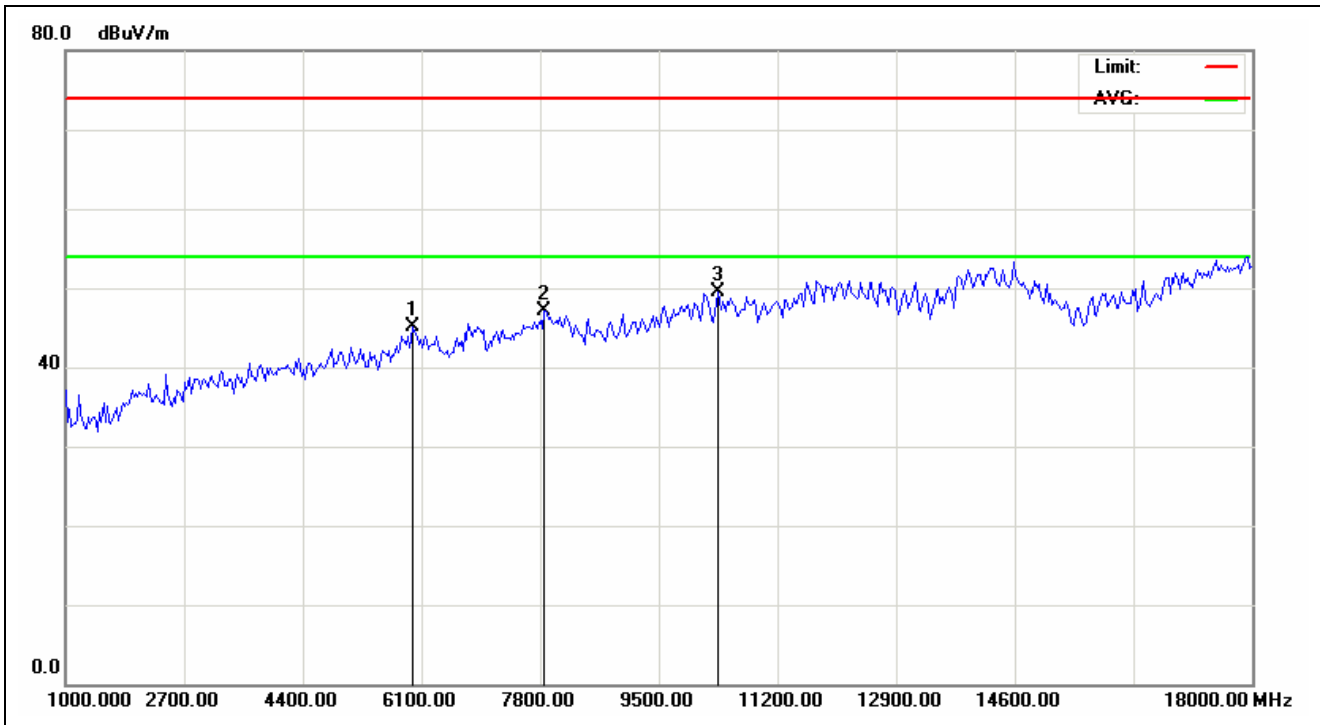

Service No.:	113152207-RF	Test Distance:	3m
Test Standard:	FCC above 1G PEAK	Ant. Polarization:	Horizontal
Test item:	Radiation Emission	Test Time:	2012/2/29 AM 09:53:38
Applicant:	Lenovo	Test Rating:	DC 3V
Product:	Bluetooth mouse	Temp.(°C)/Hum.(%):	22(°C)/62%
Model No.:	MOBTC9LA	Test Engineer:	Howard Lin
Test Mode:	Operated mode		
Remark:	BT 2402 TX		

No.	Frequency (MHz)	Factor (dB/m)	Reading (dBuV)	Level (dBuV/m)	Limit (dBuV/m)	Margin (dB)	Det.	Height (cm)	Azimuth (°)	Remark
1	5985.577	17.11	27.90	45.01	74.00	-28.99	peak			
2	7865.385	20.62	26.42	47.04	74.00	-26.96	peak			
3	10344.551	22.72	26.78	49.50	74.00	-24.50	peak			

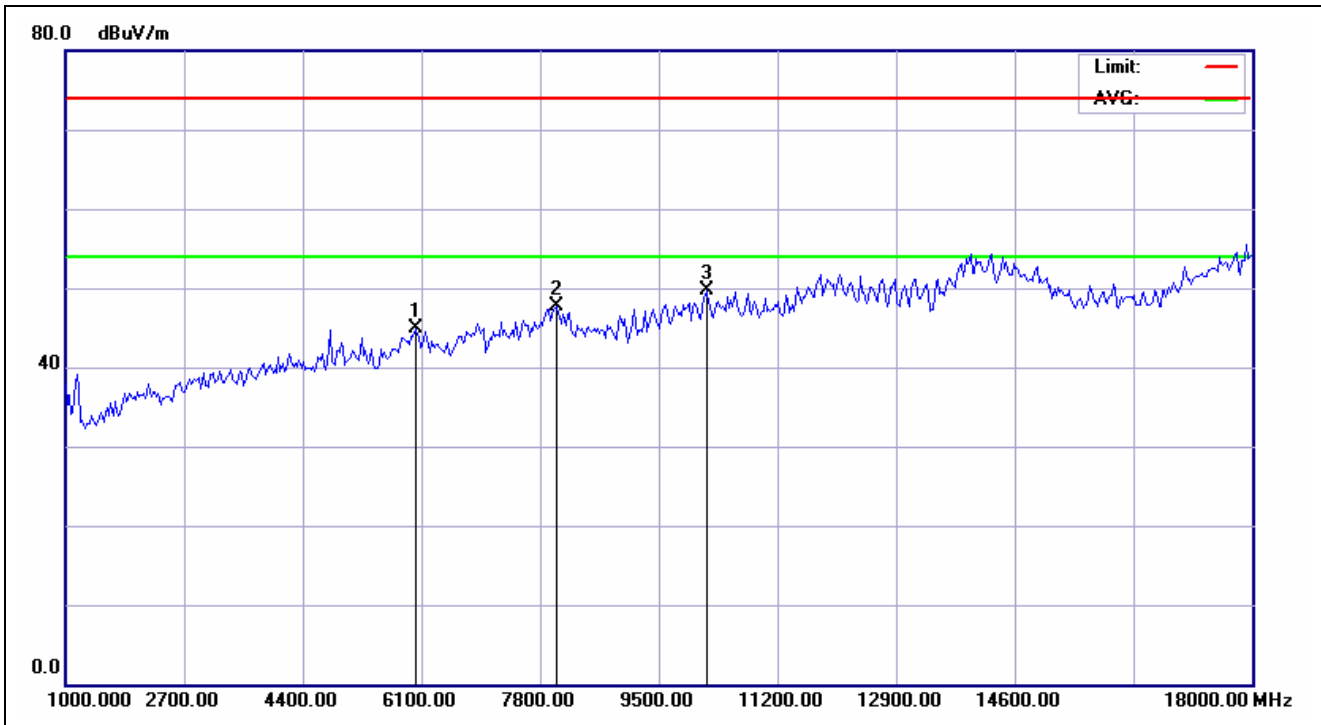

Service No.:	113152207-RF	Test Distance:	3m
Test Standard:	FCC above 1G PEAK	Ant. Polarization:	Vertical
Test item:	Radiation Emission	Test Time:	2012/2/29 AM 09:55:31
Applicant:	Lenovo	Test Rating:	DC 3V
Product:	Bluetooth mouse	Temp.(°C)/Hum.(%):	22(°C)/62%
Model No.:	MOBTC9LA	Test Engineer:	Howard Lin
Test Mode:	Operated mode		
Remark:	BT 2402 TX		

No.	Frequency (MHz)	Factor (dB/m)	Reading (dBuV)	Level (dBuV/m)	Limit (dBuV/m)	Margin (dB)	Det.	Height (cm)	Azimuth (°)	Remark
1	6012.821	17.18	27.80	44.98	74.00	-29.02	peak			
2	8028.846	21.02	26.60	47.62	74.00	-26.38	peak			
3	10181.090	22.33	27.34	49.67	74.00	-24.33	peak			

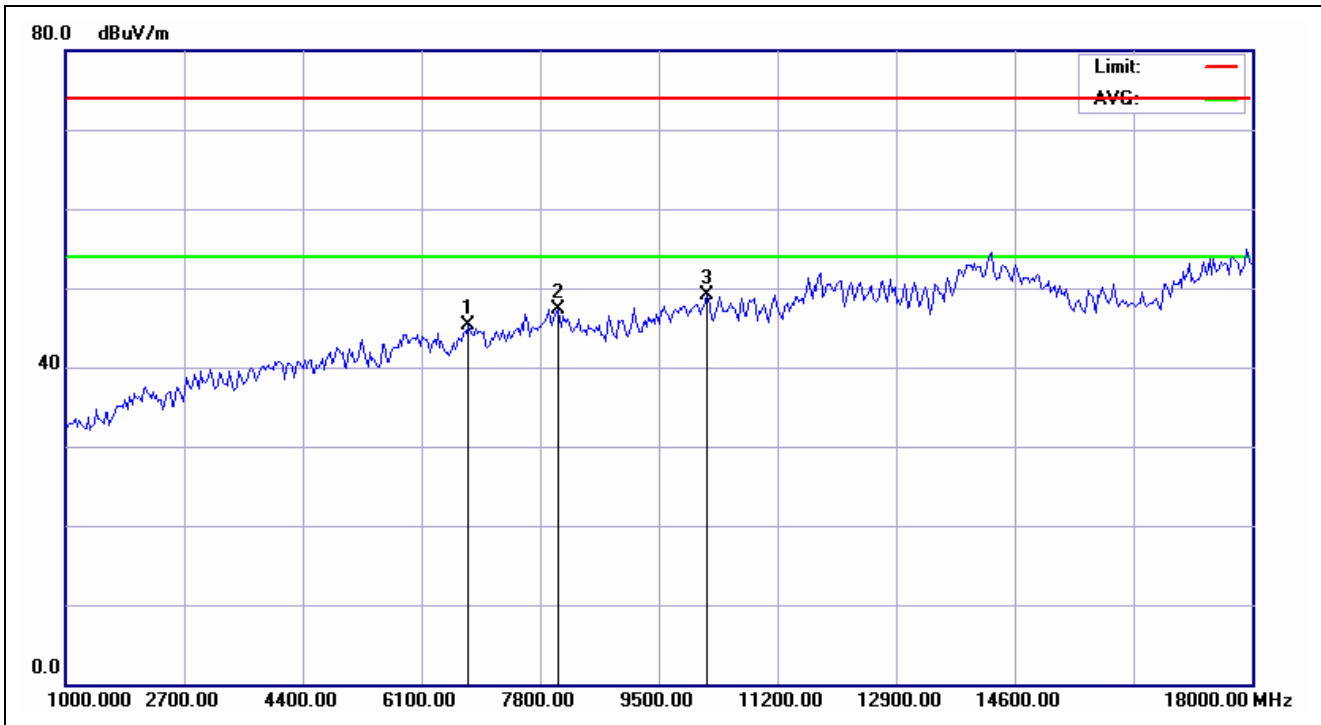

Service No.:	113152207-RF	Test Distance:	3m
Test Standard:	FCC above 1G PEAK	Ant. Polarization:	Horizontal
Test item:	Radiation Emission	Test Time:	2012/2/29 AM 10:04:02
Applicant:	Lenovo	Test Rating:	DC 3V
Product:	Bluetooth mouse	Temp.(°C)/Hum.(%):	22(°C)/62%
Model No.:	MOBTC9LA	Test Engineer:	Howard Lin
Test Mode:	Operated mode		
Remark:	BT 2441 TX		

No.	Frequency (MHz)	Factor (dB/m)	Reading (dBuV)	Level (dBuV/m)	Limit (dBuV/m)	Margin (dB)	Det.	Height (cm)	Azimuth (°)	Remark
1	6775.641	17.82	27.56	45.38	74.00	-28.62	peak			
2	8056.090	20.90	26.37	47.27	74.00	-26.73	peak			
3	10181.090	22.33	26.73	49.06	74.00	-24.94	peak			

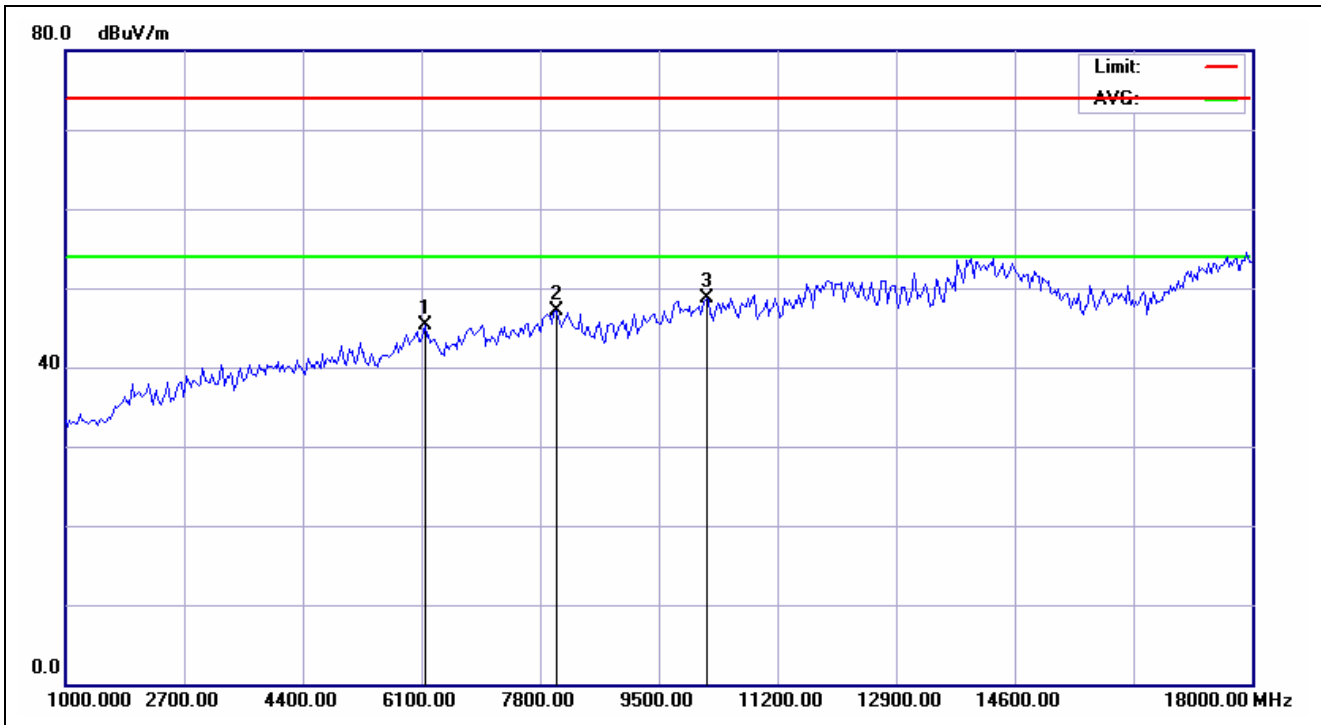

Service No.:	113152207-RF	Test Distance:	3m
Test Standard:	FCC above 1G PEAK	Ant. Polarization:	Vertical
Test item:	Radiation Emission	Test Time:	2012/2/29 AM 10:03:11
Applicant:	Lenovo	Test Rating:	DC 3V
Product:	Bluetooth mouse	Temp.(°C)/Hum.(%):	22(°C)/62%
Model No.:	MOBTC9LA	Test Engineer:	Howard Lin
Test Mode:	Operated mode		
Remark:	BT 2441 TX		

No.	Frequency (MHz)	Factor (dB/m)	Reading (dBuV)	Level (dBuV/m)	Limit (dBuV/m)	Margin (dB)	Det.	Height (cm)	Azimuth (°)	Remark
1	6149.038	17.09	28.14	45.23	74.00	-28.77	peak			
2	8028.846	21.02	26.04	47.06	74.00	-26.94	peak			
3	10181.090	22.33	26.28	48.61	74.00	-25.39	peak			

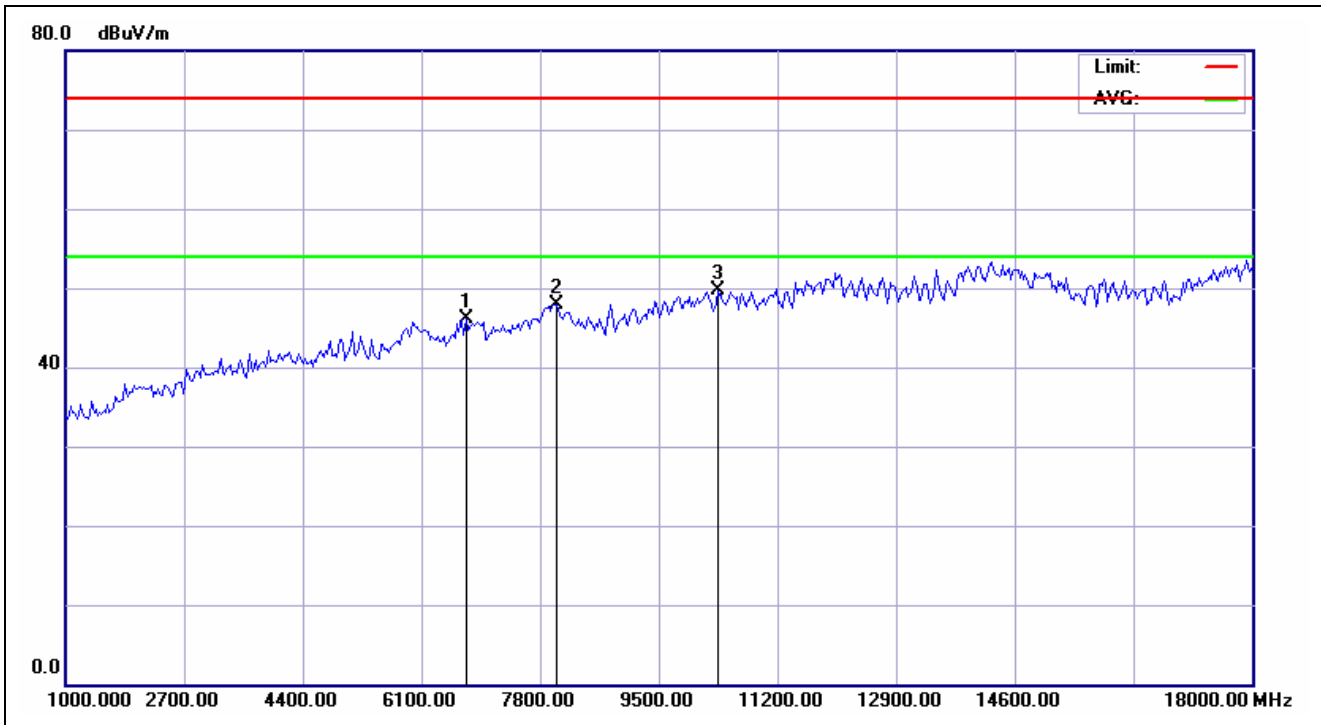

Service No.:	113152207-RF	Test Distance:	3m
Test Standard:	FCC above 1G PEAK	Ant. Polarization:	Horizontal
Test item:	Radiation Emission	Test Time:	2012/2/29 AM 10:05:58
Applicant:	Lenovo	Test Rating:	DC 3V
Product:	Bluetooth mouse	Temp.(°C)/Hum.(%):	22(°C)/62%
Model No.:	MOBTC9LA	Test Engineer:	Howard Lin
Test Mode:	Operated mode		
Remark:	BT 2480 TX		

No.	Frequency (MHz)	Factor (dB/m)	Reading (dBuV)	Level (dBuV/m)	Limit (dBuV/m)	Margin (dB)	Det.	Height (cm)	Azimuth (°)	Remark
1	6748.397	17.71	28.39	46.10	74.00	-27.90	peak			
2	8028.846	21.02	26.86	47.88	74.00	-26.12	peak			
3	10344.551	22.72	26.94	49.66	74.00	-24.34	peak			

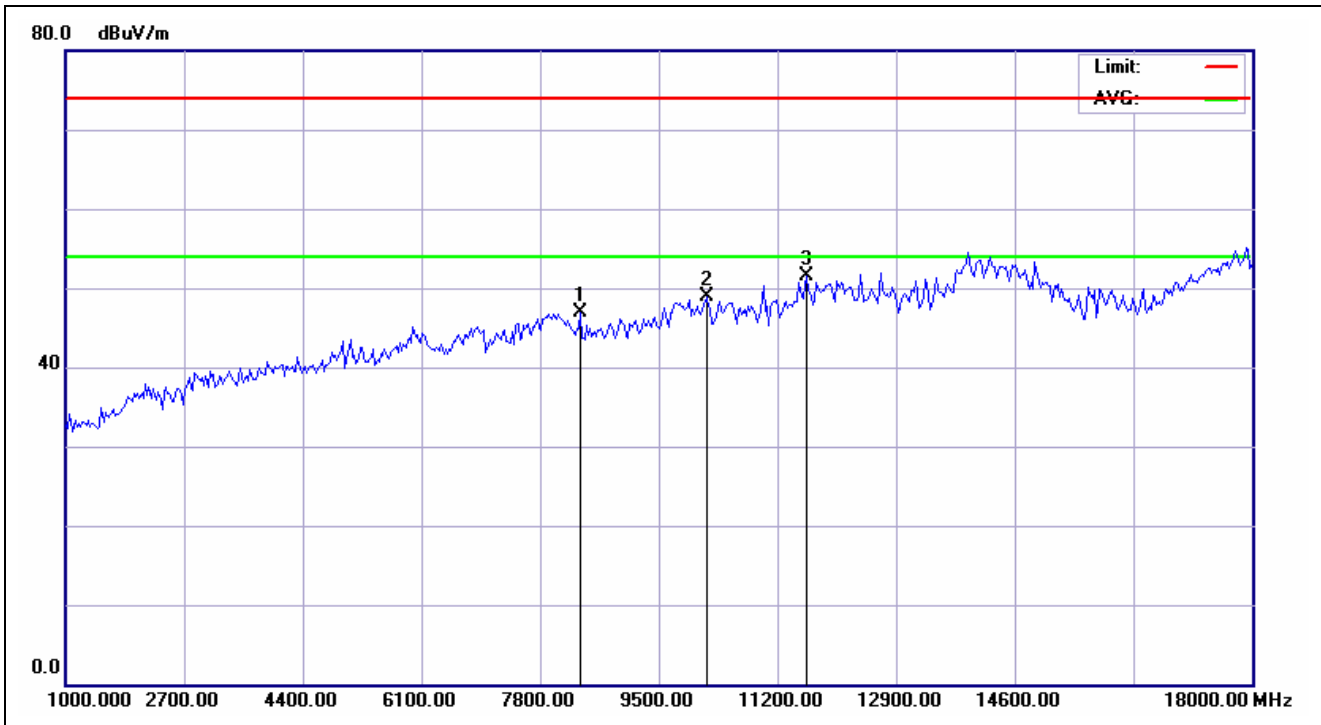

Service No.:	113152207-RF	Test Distance:	3m
Test Standard:	FCC above 1G PEAK	Ant. Polarization:	Vertical
Test item:	Radiation Emission	Test Time:	2012/2/29 AM 10:06:41
Applicant:	Lenovo	Test Rating:	DC 3V
Product:	Bluetooth mouse	Temp.(°C)/Hum.(%):	22(°C)/62%
Model No.:	MOBTC9LA	Test Engineer:	Howard Lin
Test Mode:	Operated mode		
Remark:	BT 2480 TX		

No.	Frequency (MHz)	Factor (dB/m)	Reading (dBuV)	Level (dBuV/m)	Limit (dBuV/m)	Margin (dB)	Det.	Height (cm)	Azimuth (°)	Remark
1	8383.013	19.38	27.60	46.98	74.00	-27.02	peak			
2	10181.090	22.33	26.48	48.81	74.00	-25.19	peak			
3	11625.000	24.52	26.93	51.45	74.00	-22.55	peak			

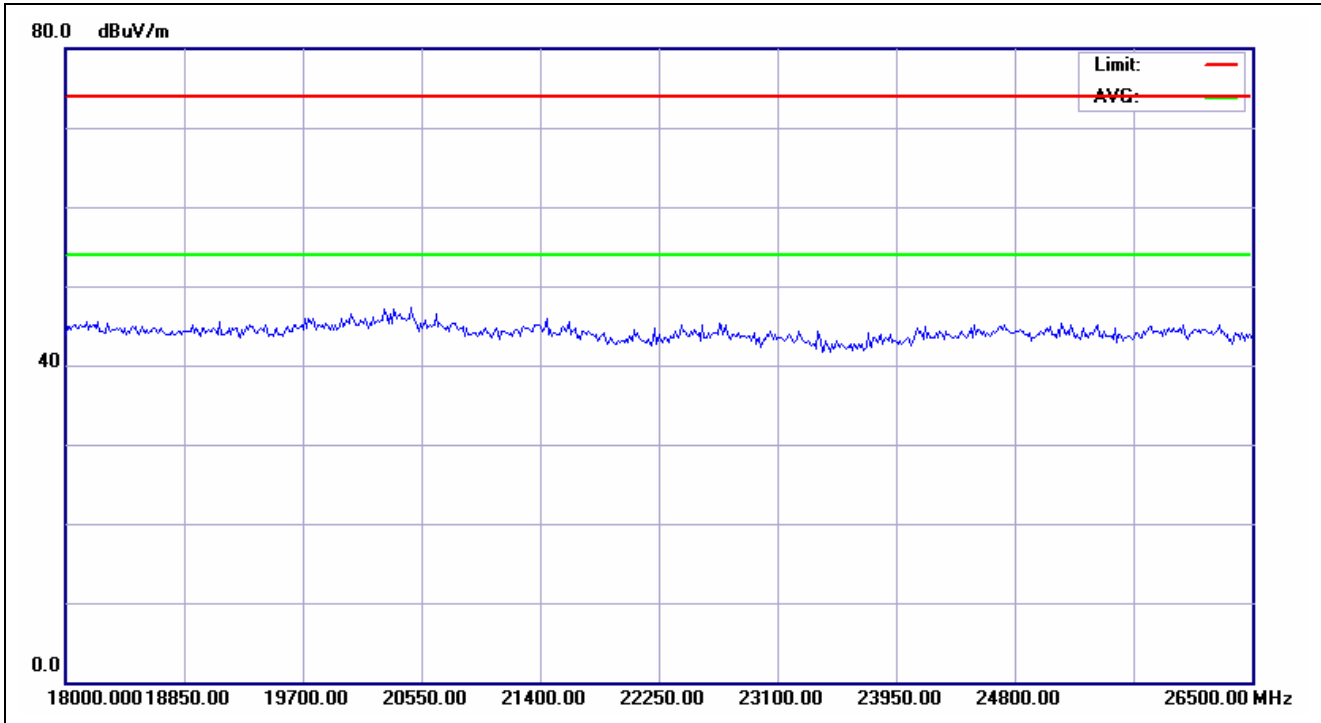

Service No.:	113152207-RF	Test Distance:	3m
Test Standard:	FCC above 1G PEAK	Ant. Polarization:	Horizontal
Test item:	Radiation Emission	Test Time:	2012/2/29 AM 11:29:47
Applicant:	Lenovo	Test Rating:	DC 3V
Product:	Bluetooth mouse	Temp.(°C)/Hum.(%):	22(°C)/62%
Model No.:	MOBTC9LA	Test Engineer:	Howard Lin
Test Mode:	Operated mode		
Remark:	BT 2402 TX		

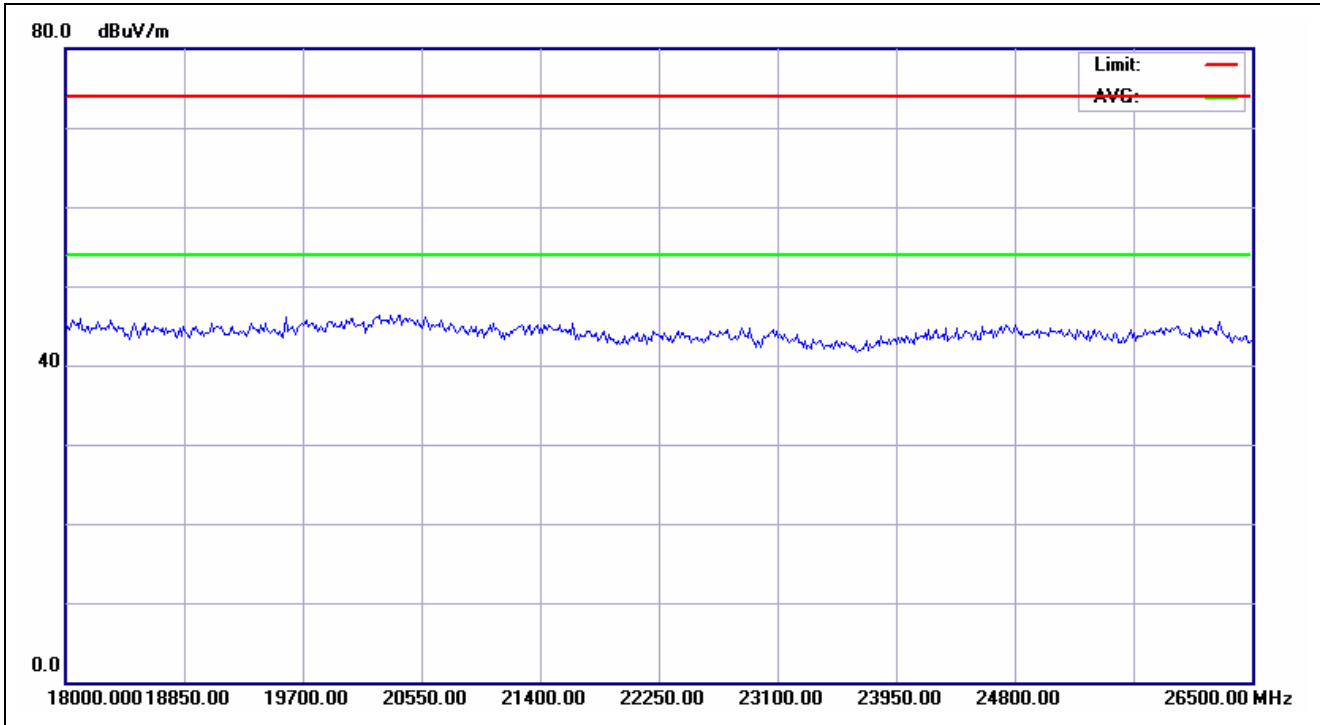

Service No.:	113152207-RF	Test Distance:	3m
Test Standard:	FCC above 1G PEAK	Ant. Polarization:	Vertical
Test item:	Radiation Emission	Test Time:	2012/2/29 AM 11:31:19
Applicant:	Lenovo	Test Rating:	DC 3V
Product:	Bluetooth mouse	Temp.(°C)/Hum.(%):	22(°C)/62%
Model No.:	MOBTC9LA	Test Engineer:	Howard Lin
Test Mode:	Operated mode		
Remark:	BT 2402 TX		

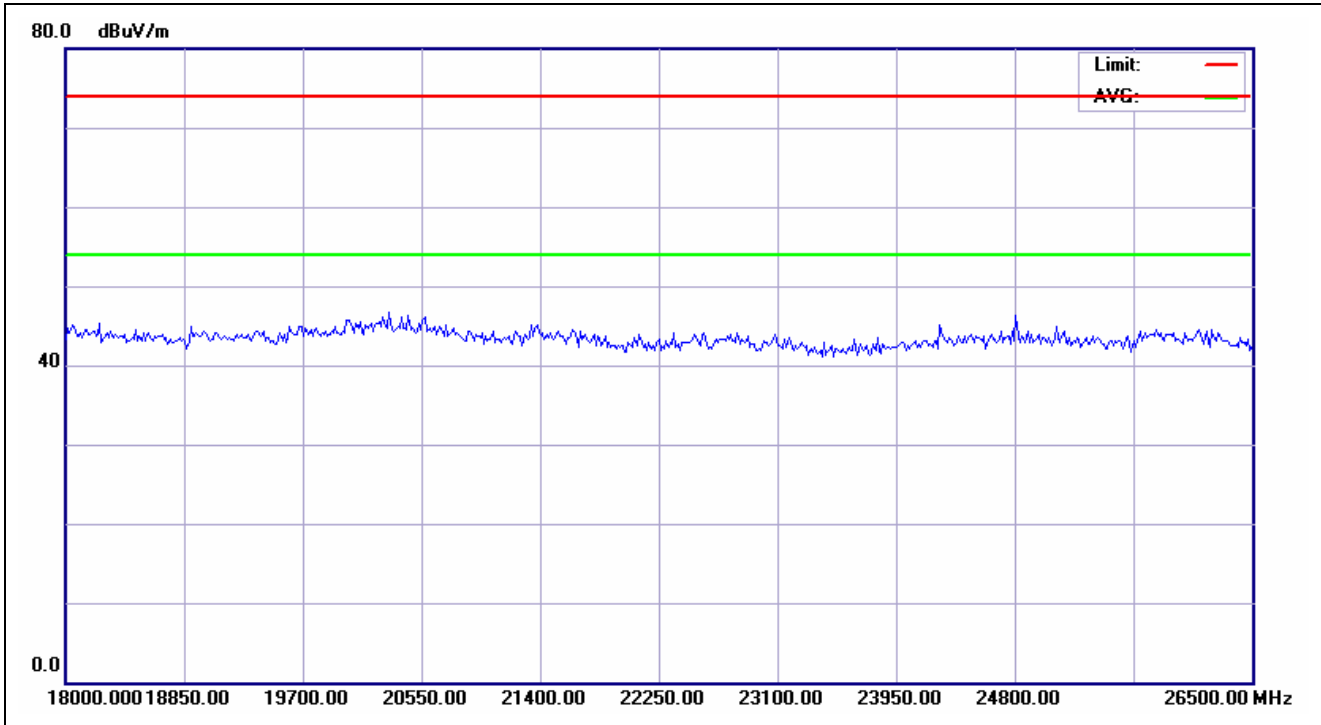

Service No.:	113152207-RF	Test Distance:	3m
Test Standard:	FCC above 1G PEAK	Ant. Polarization:	Horizontal
Test item:	Radiation Emission	Test Time:	2012/2/29 AM 11:27:54
Applicant:	Lenovo	Test Rating:	DC 3V
Product:	Bluetooth mouse	Temp.(°C)/Hum.(%):	22(°C)/62%
Model No.:	MOBTC9LA	Test Engineer:	Howard Lin
Test Mode:	Operated mode		
Remark:	BT 2441 TX		

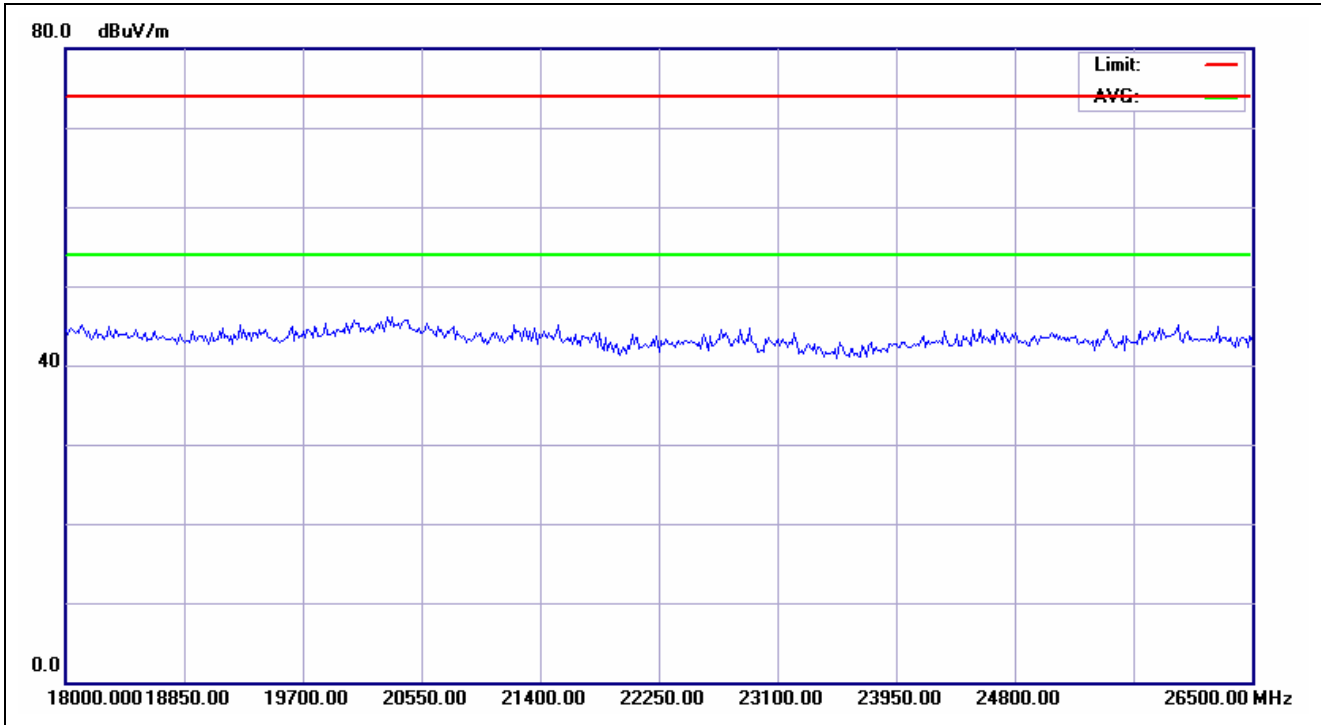

Service No.:	113152207-RF	Test Distance:	3m
Test Standard:	FCC above 1G PEAK	Ant. Polarization:	Vertical
Test item:	Radiation Emission	Test Time:	2012/2/29 AM 11:27:06
Applicant:	Lenovo	Test Rating:	DC 3V
Product:	Bluetooth mouse	Temp.(°C)/Hum.(%):	22(°C)/62%
Model No.:	MOBTC9LA	Test Engineer:	Howard Lin
Test Mode:	Operated mode		
Remark:	BT 2441 TX		

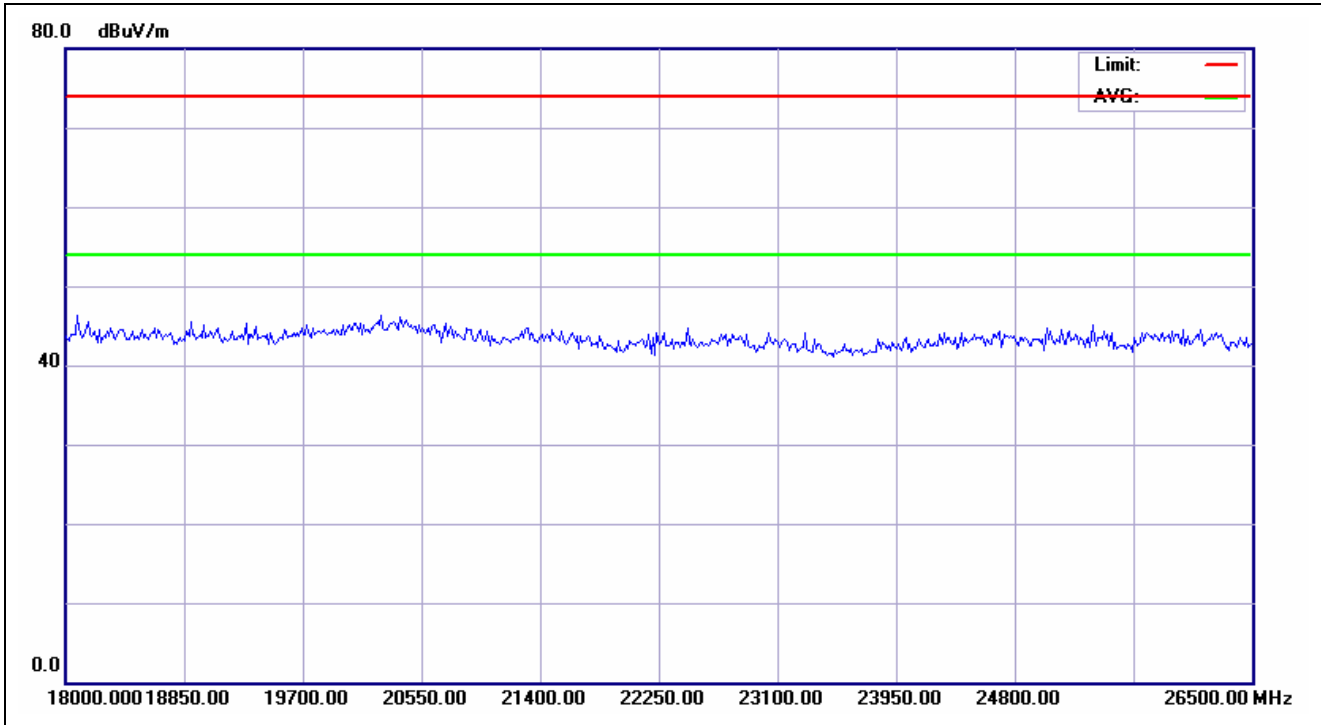

Service No.:	113152207-RF	Test Distance:	3m
Test Standard:	FCC above 1G PEAK	Ant. Polarization:	Horizontal
Test item:	Radiation Emission	Test Time:	2012/2/29 AM 11:24:01
Applicant:	Lenovo	Test Rating:	DC 3V
Product:	Bluetooth mouse	Temp.(°C)/Hum.(%):	22(°C)/62%
Model No.:	MOBTC9LA	Test Engineer:	Howard Lin
Test Mode:	Operated mode		
Remark:	BT 2480 TX		

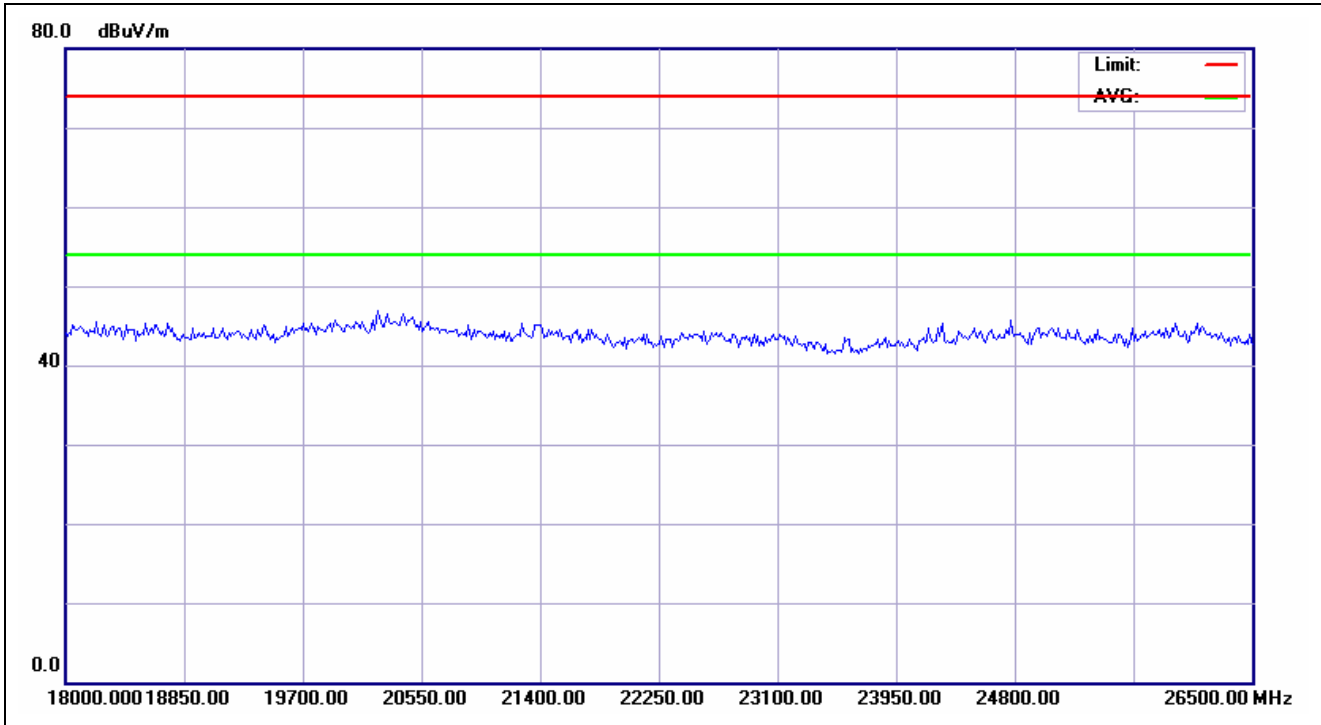

Service No.:	113152207-RF	Test Distance:	3m
Test Standard:	FCC above 1G PEAK	Ant. Polarization:	Vertical
Test item:	Radiation Emission	Test Time:	2012/2/29 AM 11:25:28
Applicant:	Lenovo	Test Rating:	DC 3V
Product:	Bluetooth mouse	Temp.(°C)/Hum.(%):	22(°C)/62%
Model No.:	MOBTC9LA	Test Engineer:	Howard Lin
Test Mode:	Operated mode		
Remark:	BT 2480 TX		

Radiated Bandedge (GFSK)

Low Channel (H)

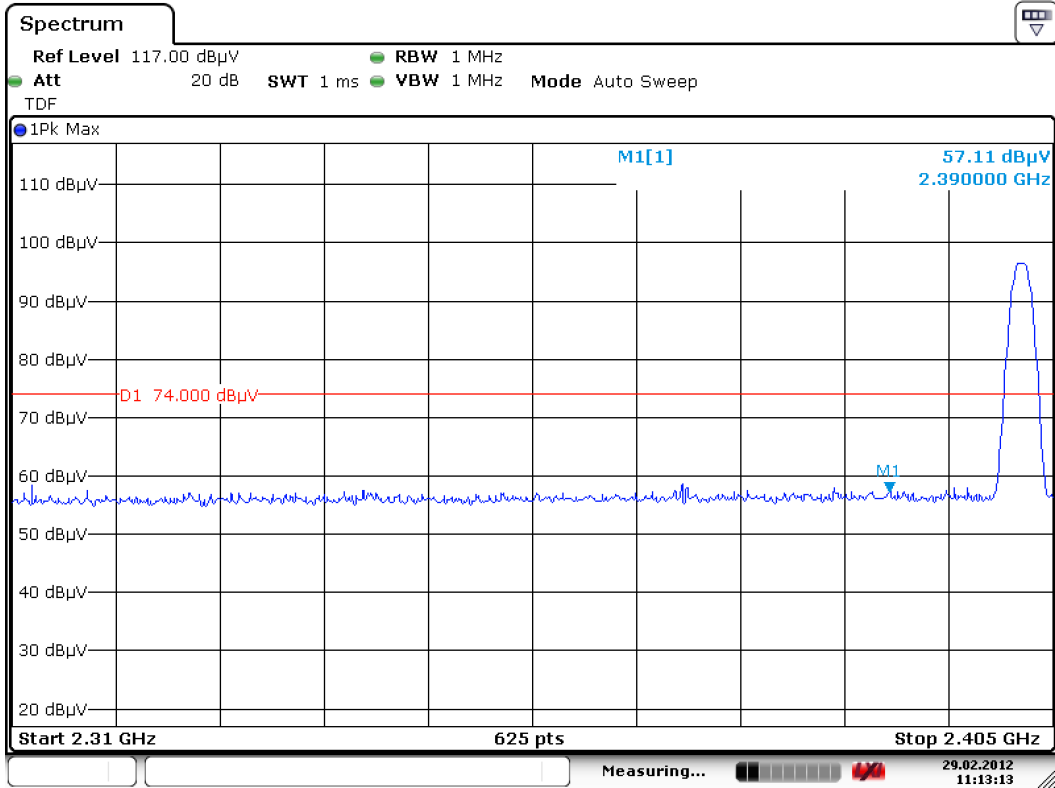

Date: 29.FEB.2012 11:13:13

High Channel (H)

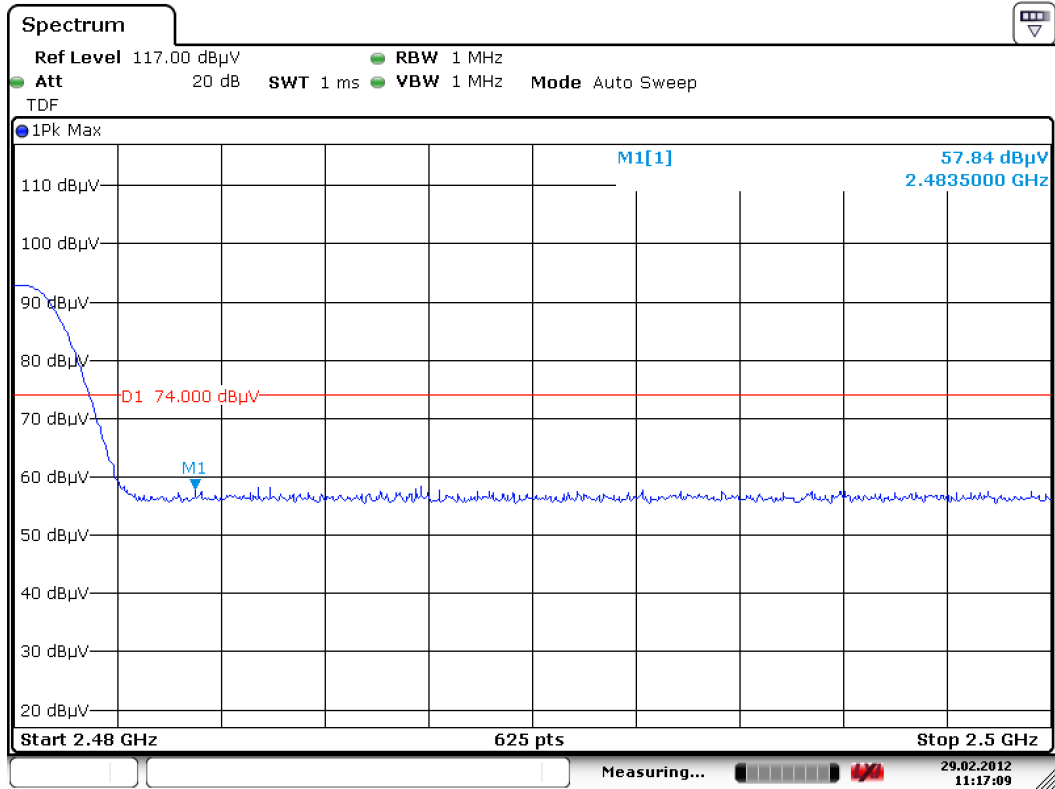

Date: 29.FEB.2012 11:17:09

Radiated Bandedge (GFSK)

Low Channel (V)

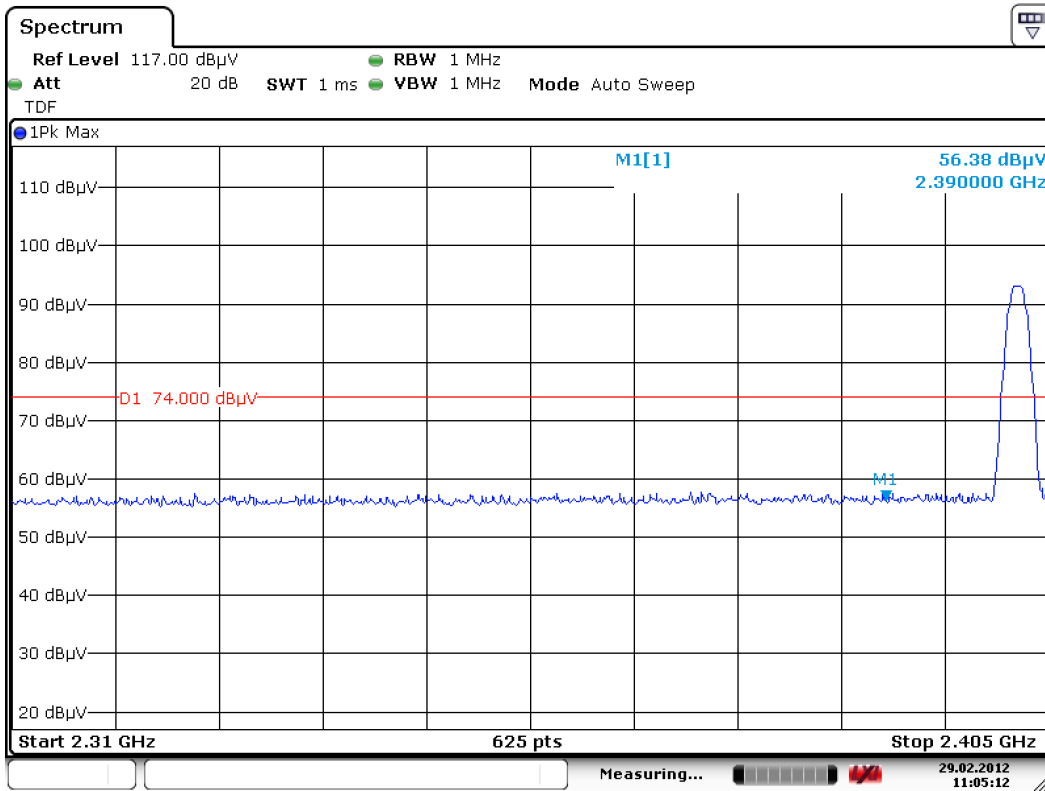

Date: 29.FEB.2012 11:05:12

High Channel (V)

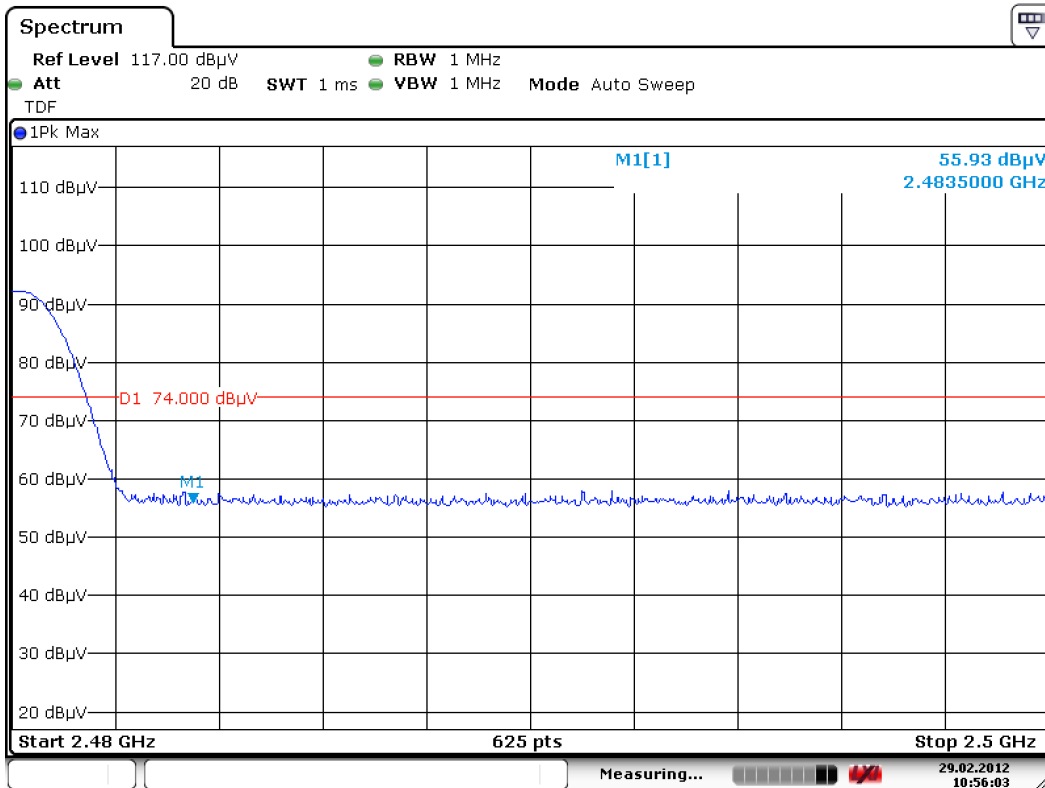

Date: 29.FEB.2012 10:56:03