



# FCC TEST REPORT

**REPORT NO.:** RF120913D02  
**MODEL NO.:** GA800  
**FCC ID:** EMJPGA800  
**RECEIVED:** Sep. 13, 2012  
**TESTED:** Sep. 13 ~ 14, 2012  
**ISSUED:** Sep. 28, 2012

**APPLICANT:** PRIMAX ELECTRONICS LTD.

**ADDRESS:** No. 669, Ruey Kuang Road, Neihu, Taipei,  
Taiwan, R.O.C.

**ISSUED BY:** Bureau Veritas Consumer Products Services  
(H.K.) Ltd., Taoyuan Branch

**LAB LOCATION:** No. 47, 14th Ling, Chia Pau Vil., Lin Kou Dist.,  
New Taipei City, Taiwan, R.O.C.

This report should not be used by the client to claim product certification, approval, or endorsement by TAF or any government agencies.



This report is for your exclusive use. Any copying or replication of this report to or for any other person or entity, or use of our name or trademark, is permitted only with our prior written permission. This report sets forth our findings solely with respect to the test samples identified herein. The results set forth in this report are not indicative or representative of the quality or characteristics of the lot from which a test sample was taken or any similar or identical product unless specifically and expressly noted. Our report includes all of the tests requested by you and the results thereof based upon the information that you provided to us. You have 60 days from date of issuance of this report to notify us of any material error or omission caused by our negligence, provided, however, that such notice shall be in writing and shall specifically address the issue you wish to raise. A failure to raise such issue within the prescribed time shall constitute your unqualified acceptance of the completeness of this report, the tests conducted and the correctness of the report contents. Unless specific mention, the uncertainty of measurement has been explicitly taken into account to declare the compliance or non-compliance to the specification.



## Table of Contents

RELEASE CONTROL RECORD.....	3
1. CERTIFICATION .....	4
2. SUMMARY OF TEST RESULTS.....	5
2.1 MEASUREMENT UNCERTAINTY .....	5
3. GENERAL INFORMATION .....	6
3.1 GENERAL DESCRIPTION OF EUT.....	6
3.2 DESCRIPTION OF TEST MODES.....	7
3.2.1 TEST MODE APPLICABILITY AND TESTED CHANNEL DETAIL .....	8
3.3 DESCRIPTION OF SUPPORT UNITS.....	10
3.3.1 CONFIGURATION OF SYSTEM UNDER TEST .....	10
3.4 GENERAL DESCRIPTION OF APPLIED STANDARDS .....	11
4. TEST TYPES AND RESULTS .....	12
4.1 CONDUCTED EMISSION MEASUREMENT .....	12
4.1.1 LIMITS OF CONDUCTED EMISSION MEASUREMENT.....	12
4.1.2 TEST INSTRUMENTS .....	13
4.1.3 TEST PROCEDURES.....	13
4.1.4 DEVIATION FROM TEST STANDARD .....	14
4.1.5 TEST SETUP .....	14
4.1.6 EUT OPERATING CONDITIONS.....	14
4.1.7 TEST RESULTS.....	15
4.2 RADIATED EMISSION AND BAND EDGE MEASUREMENT.....	17
4.2.1 LIMITS OF RADIATED EMISSION AND BAND EDGE MEASUREMENT .....	17
4.2.2 TEST INSTRUMENTS .....	18
4.2.3 TEST PROCEDURES.....	19
4.2.4 DEVIATION FROM TEST STANDARD .....	19
4.2.5 TEST SETUP .....	20
4.2.6 EUT OPERATING CONDITIONS.....	20
4.2.7 TEST RESULTS.....	21
5. PHOTOGRAPHS OF THE TEST CONFIGURATION.....	27
6. INFORMATION ON THE TESTING LABORATORIES .....	28
7. APPENDIX A – MODIFICATION RECORDERS FOR ENGINEERING CHANGES TO THE EUT BY THE LAB .....	29



## RELEASE CONTROL RECORD

ISSUE NO.	REASON FOR CHANGE	DATE ISSUED
RF120913D02	Original release	Sep. 28, 2012



## 1. CERTIFICATION

**PRODUCT:** Lenovo E-dice

**BRAND:** Lenovo

**MODEL NO.:** GA800

**APPLICANT:** PRIMAX ELECTRONICS LTD.

**TESTED:** Sep. 13 ~ 14, 2012

**TEST SAMPLE:** ENGINEERING SAMPLE

**STANDARDS:** FCC Part 15, Subpart C (Section 15.249)

ANSI C63.10-2009

The above equipment has been tested by **Bureau Veritas Consumer Products Services (H.K.) Ltd., Taoyuan Branch**, and found compliance with the requirement of the above standards. The test record, data evaluation & Equipment Under Test (EUT) configurations represented herein are true and accurate accounts of the measurements of the sample's EMC characteristics under the conditions specified in this report.

**PREPARED BY :** Annie Chang , **DATE:** Sep. 28, 2012  
( Annie Chang / Supervisor )

**APPROVED BY :** Ken Liu , **DATE:** Sep. 28, 2012  
( Ken Liu / Manager )

## 2. SUMMARY OF TEST RESULTS

The EUT has been tested according to the following specifications:

<b>APPLIED STANDARD: FCC Part 15, Subpart C (Section 15.249)</b>			
<b>STANDARD PARAGRAPH</b>	<b>TEST TYPE</b>	<b>RESULT</b>	<b>REMARK</b>
15.207	Conducted Emission Test	PASS	Meet the requirement of limit. Minimum passing margin is -11.37dB at 0.61484MHz.
15.209 15.249 15.249 (d)	Radiated Emission Test Band Edge Measurement Limit: 50dB less than the peak value of fundamental frequency or meet radiated emission limit in section 15.209	PASS	Meet the requirement of limit. Minimum passing margin is -7.2dB at 257.95MHz.

### 2.1 MEASUREMENT UNCERTAINTY

Where relevant, the following measurement uncertainty levels have been estimated for tests performed on the EUT as specified in CISPR 16-4-2:

This uncertainty represents an expanded uncertainty expressed at approximately the 95% confidence level using a coverage factor of k=2.

<b>Measurement</b>	<b>Frequency</b>	<b>Uncertainty</b>
Conducted emissions	150kHz ~ 30MHz	2.41 dB
Radiated emissions	30MHz ~ 1GHz	3.78 dB
	Above 1GHz	3.36 dB

### 3. GENERAL INFORMATION

#### 3.1 GENERAL DESCRIPTION OF EUT

<b>EUT</b>	Lenovo E-dice
<b>MODEL NO.</b>	GA800
<b>POWER SUPPLY</b>	3.7Vdc from battery 5Vdc from cradle
<b>MODULATION TYPE</b>	GFSK
<b>OPERATING FREQUENCY</b>	2405MHz ~ 2480MHz
<b>NUMBER OF CHANNEL</b>	16
<b>ANTENNA TYPE</b>	Printed antenna with 2dBi gain
<b>DATA CABLE</b>	0.1m USB cable (Cradle)
<b>I/O PORT</b>	USB Port (Cradle)
<b>ACCESSORY DEVICES</b>	Cradle, battery

**NOTE:**

1. The EUT is a Lenovo E-dice.
2. The USB function on this product (Cradle) is for battery charging only, no data transmitting and/or receiving function involved.
3. The above EUT information is declared by the manufacturer and for more detailed features description, please refer to the manufacturer's specifications or User's Manual.

### 3.2 DESCRIPTION OF TEST MODES

16 channels are provided to this EUT:

CHANNEL	FREQ. (MHz)	CHANNEL	FREQ. (MHz)	CHANNEL	FREQ. (MHz)
1	2405	7	2435	13	2465
2	2410	8	2440	14	2470
3	2415	9	2445	15	2475
4	2420	10	2450	16	2480
5	2425	11	2455		
6	2430	12	2460		

### 3.2.1 TEST MODE APPLICABILITY AND TESTED CHANNEL DETAIL

EUT CONFIGURE MODE	APPLICABLE TO				DESCRIPTION
	PLC	RE <sup>3</sup> 1G	RE<1G	BM	
A	Note 1	√	√	√	Operating Mode (EUT stand-alone)
B	√	-	√	-	Charging Mode (EUT + Cradle)

Where **PLC**: Power Line Conducted Emission      **RE<sup>3</sup>1G**: Radiated Emission above 1GHz  
**RE<1G**: Radiated Emission below 1GHz      **BM**: Bandedge Measurement

**NOTE 1:** No need to concern of Conducted Emission due to the EUT is powered by battery.

**NOTE 2:** "-" means no effect.

**NOTE 3:** The EUT had been pre-tested on the positioned of each 3 axis. The worst case was found when positioned on **X-plane**.

#### **POWER LINE CONDUCTED EMISSION TEST:**

- Pre-Scan has been conducted to determine the worst-case mode from all possible combinations between available modulations axis and antenna ports (if EUT with antenna diversity architecture).
- Following channel(s) was (were) selected for the final test as listed below.

EUT CONFIGURE MODE	AVAILABLE CHANNEL	TESTED CHANNEL	MODULATION TYPE
B	-	-	-

#### **RADIATED EMISSION TEST (ABOVE 1 GHz):**

- Pre-Scan has been conducted to determine the worst-case mode from all possible combinations between available modulations axis and antenna ports (if EUT with antenna diversity architecture).
- Following channel(s) was (were) selected for the final test as listed below.

EUT CONFIGURE MODE	AVAILABLE CHANNEL	TESTED CHANNEL	MODULATION TYPE
A	1 to 16	1, 9, 16	GFSK

#### **RADIATED EMISSION TEST (BELOW 1 GHz):**

- Pre-Scan has been conducted to determine the worst-case mode from all possible combinations between available modulations axis and antenna ports (if EUT with antenna diversity architecture).
- Following channel(s) was (were) selected for the final test as listed below.

EUT CONFIGURE MODE	AVAILABLE CHANNEL	TESTED CHANNEL	MODULATION TYPE
A	1 to 16	1	GFSK
B	-	-	-





A D T

**BANDEDGE MEASUREMENT:**

- Pre-Scan has been conducted to determine the worst-case mode from all possible combinations between available modulations and antenna ports (if EUT with antenna diversity architecture).
- Following channel(s) was (were) selected for the final test as listed below.

EUT CONFIGURE MODE	AVAILABLE CHANNEL	TESTED CHANNEL	MODULATION TYPE
A	1 to 16	1, 16	GFSK

**TEST CONDITION:**

APPLICABLE TO	EUT CONFIGURE MODE	ENVIRONMENTAL CONDITIONS	INPUT POWER	TESTED BY
PLC	B	26deg. C, 75% RH	120Vac, 60Hz (System)	Nick Chen
RE <sup>3</sup> 1G	A	26deg. C, 79% RH	3.7Vdc	Chad Lee
RE<1G	A	26deg. C, 79% RH	3.7Vdc	Chad Lee
	B	26deg. C, 79% RH	120Vac, 60Hz (System)	Chad Lee
BM	A	26deg. C, 79% RH	3.7Vdc	Chad Lee

### 3.3 DESCRIPTION OF SUPPORT UNITS

The EUT has been tested as an independent unit together with other necessary accessories or support units. The following support units or accessories were used to form a representative test configuration during the tests.

NO.	PRODUCT	BRAND	MODEL NO.	SERIAL NO.	FCC ID
1	NOTEBOOK COMPUTER	DELL	PP27L	8SNZ12S	FCC DoC Approved

NO.	SIGNAL CABLE DESCRIPTION OF THE ABOVE SUPPORT UNITS
1	N/A

**NOTE:** All power cords of the above support units are non shielded (1.8m).

#### 3.3.1 CONFIGURATION OF SYSTEM UNDER TEST

##### FOR MODE A:

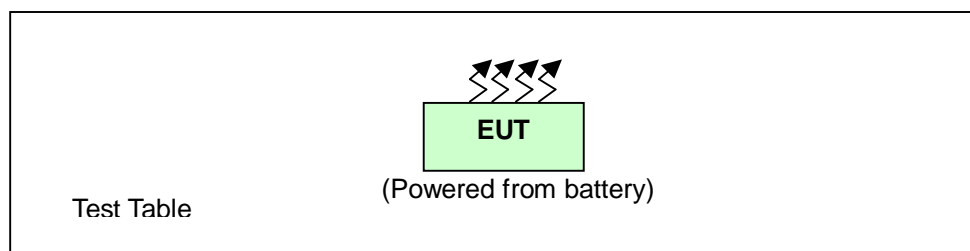

##### FOR MODE B:

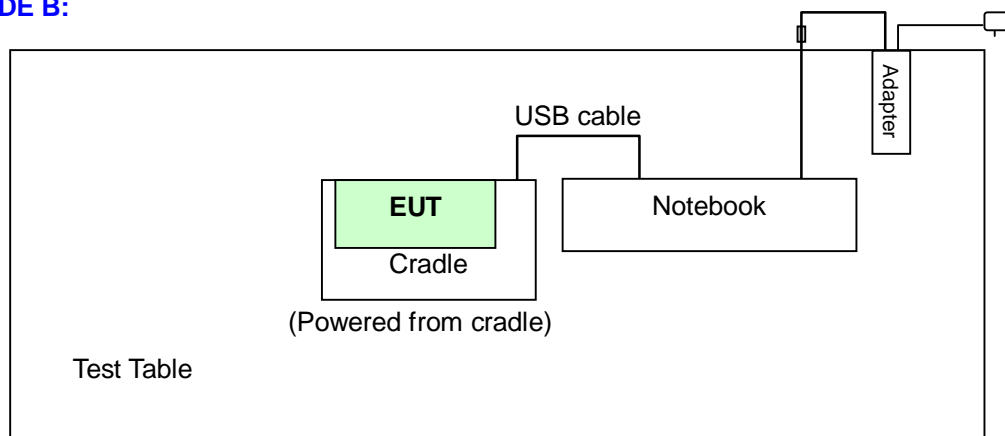



### **3.4 GENERAL DESCRIPTION OF APPLIED STANDARDS**

The EUT is a RF Product. According to the specifications of the manufacturer, it must comply with the requirements of the following standards:

**FCC Part 15, Subpart C (Section 15.249)**

ANSI C63.10-2009

All test items have been performed and recorded as per the above standards.

## 4. TEST TYPES AND RESULTS

### 4.1 CONDUCTED EMISSION MEASUREMENT

#### 4.1.1 LIMITS OF CONDUCTED EMISSION MEASUREMENT

FREQUENCY OF EMISSION (MHz)	CONDUCTED LIMIT (dB $\mu$ V)	
	Quasi-peak	Average
0.15 ~ 0.5	66 to 56	56 to 46
0.5 ~ 5	56	46
5 ~ 30	60	50

- NOTE:**
1. The lower limit shall apply at the transition frequencies.
  2. The limit decreases in line with the logarithm of the frequency in the range of 0.15 to 0.50 MHz.

## 4.1.2 TEST INSTRUMENTS

DESCRIPTION & MANUFACTURER	MODEL NO.	SERIAL NO.	CALIBRATED DATE	CALIBRATED UNTIL
ROHDE & SCHWARZ Test Receiver	ESCS 30	100276	Jan. 04, 2012	Jan. 03, 2013
ROHDE & SCHWARZ Artificial Mains Network (for EUT)	ESH3-Z5	100219	Nov. 24, 2011	Nov. 23, 2012
LISN With Adapter (for EUT)	AD10	C10Ada-001	Nov. 24, 2011	Nov. 23, 2012
ROHDE & SCHWARZ Artificial Mains Network (for peripherals)	ESH3-Z5	100218	Dec. 08, 2011	Dec. 07, 2012
Software	ADT_Cond_V7.3.7	NA	NA	NA
Software	ADT_ISN_V7.3.7	NA	NA	NA
RF cable (JYEBAO)	5D-FB	Cable-C10.01	Feb. 20, 2012	Feb. 19, 2013
SUHNER Terminator (For ROHDE & SCHWARZ LISN)	65BNC-5001	E1-010773	Feb. 22, 2012	Feb. 21, 2013

- NOTE:**
1. The calibration interval of the above test instruments is 12 months and the calibrations are traceable to NML/ROC and NIST/USA.
  2. The test was performed in Shielded Room No. 10.
  3. The VCCI Site Registration No. C-1852.

## 4.1.3 TEST PROCEDURES

- a. The EUT was placed 0.4 meters from the conducting wall of the shielded room with EUT being connected to the power mains through a line impedance stabilization network (LISN). Other support units were connected to the power mains through another LISN. The two LISNs provide 50 ohm/ 50uH of coupling impedance for the measuring instrument.
- b. Both lines of the power mains connected to the EUT were checked for maximum conducted interference.
- c. The frequency range from 150kHz to 30MHz was searched. Emission levels under (Limit - 20dB) were not recorded.

#### 4.1.4 DEVIATION FROM TEST STANDARD

No deviation

#### 4.1.5 TEST SETUP

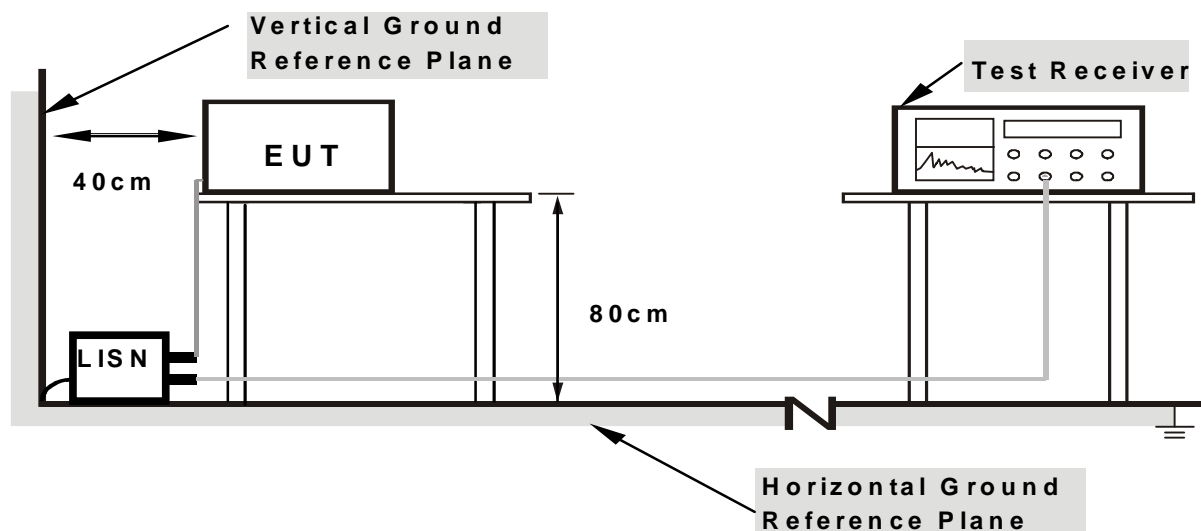

**Note:** 1. Support units were connected to second LISN.  
 2. Both of LISNs (AMN) are 80 cm from EUT and at least 80 cm from other units and other metal planes support units.

For the actual test configuration, please refer to the related item – Photographs of the Test Configuration.

#### 4.1.6 EUT OPERATING CONDITIONS

##### For Mode B

- a. The EUT was inserted into cradle.
- b. Connected the cradle with Notebook PC placed on testing table.
- c. Set the EUT under charging condition.

### 4.1.7 TEST RESULTS

6dB BANDWIDTH	9kHz	PHASE	Line 1
TEST MODE	B		

No	Freq. [MHz]	Corr. Factor (dB)	Reading Value [dB (uV)]		Emission Level [dB (uV)]		Limit [dB (uV)]		Margin (dB)	
			Q.P.	AV.	Q.P.	AV.	Q.P.	AV.	Q.P.	AV.
			1	0.24766	0.16	42.72	-	42.88	-	61.84
2	0.48984	0.20	43.12	-	43.32	-	56.17	46.17	-12.85	-
<b>3</b>	<b>0.61484</b>	<b>0.20</b>	<b>44.43</b>	-	<b>44.63</b>	-	<b>56.00</b>	<b>46.00</b>	<b>-11.37</b>	-
4	0.86484	0.22	40.00	-	40.22	-	56.00	46.00	-15.78	-
5	1.48828	0.26	33.51	-	33.77	-	56.00	46.00	-22.23	-
6	16.87500	1.11	33.08	-	34.19	-	60.00	50.00	-25.81	-

#### REMARKS:

1. Q.P. and AV. are abbreviations of quasi-peak and average individually.
2. "-": The Quasi-peak reading value also meets average limit and measurement with the average detector is unnecessary.
3. The emission levels of other frequencies were very low against the limit.
4. Margin value = Emission level - Limit value
5. Correction factor = Insertion loss + Cable loss
6. Emission Level = Correction Factor + Reading Value.

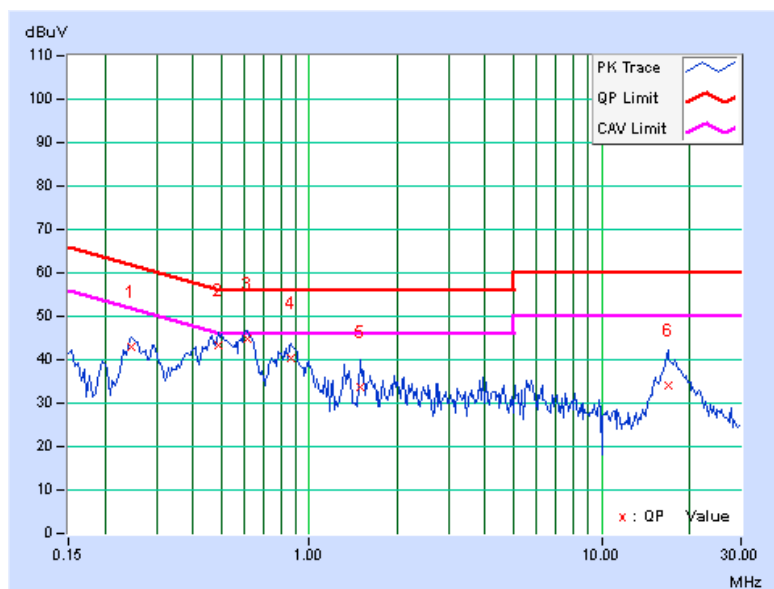



A D T

<b>6dB BANDWIDTH</b>	9kHz	<b>PHASE</b>	Line 2
<b>TEST MODE</b>	B		

No	Freq. [MHz]	Corr. Factor (dB)	Reading Value [dB (uV)]		Emission Level [dB (uV)]		Limit [dB (uV)]		Margin (dB)	
			Q.P.	AV.	Q.P.	AV.	Q.P.	AV.	Q.P.	AV.
1	0.29063	0.17	41.61	-	41.78	-	60.51	50.51	-18.73	-
2	0.54063	0.20	40.63	-	40.83	-	56.00	46.00	-15.17	-
3	0.73594	0.21	39.61	-	39.82	-	56.00	46.00	-16.18	-
4	1.33594	0.25	34.97	-	35.22	-	56.00	46.00	-20.78	-
5	2.14063	0.29	31.24	-	31.53	-	56.00	46.00	-24.47	-
6	18.15625	0.88	32.05	-	32.93	-	60.00	50.00	-27.07	-

**REMARKS:**

1. Q.P. and AV. are abbreviations of quasi-peak and average individually.
2. "-": The Quasi-peak reading value also meets average limit and measurement with the average detector is unnecessary.
3. The emission levels of other frequencies were very low against the limit.
4. Margin value = Emission level - Limit value
5. Correction factor = Insertion loss + Cable loss
6. Emission Level = Correction Factor + Reading Value.

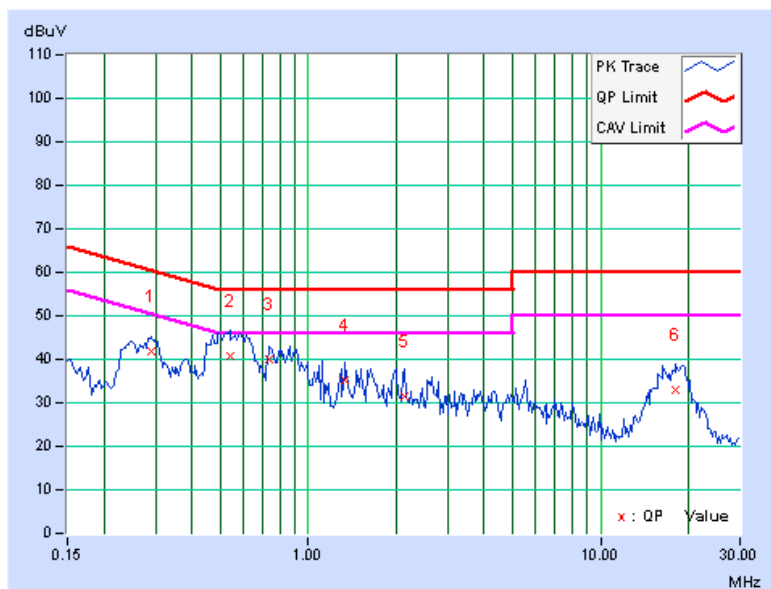



## 4.2 RADIATED EMISSION AND BAND EDGE MEASUREMENT

### 4.2.1 LIMITS OF RADIATED EMISSION AND BAND EDGE MEASUREMENT

The field strength of emissions from intentional radiators operated within these frequency bands shall comply with the following

Fundamental Frequency	Field Strength of Fundamental (millivolts/meter)	Field Strength of Harmonics (microvolts/meter)
902 ~ 928 MHz	50	500
2400 ~ 2483.5 MHz	50	500
5725 ~ 5875 MHz	50	500
24 ~ 24.25 GHz	250	2500

Emissions radiated outside of the specified frequency bands, except for harmonics, shall be attenuated by at least 50 dB below the level of the fundamental or to the general radiated emission limits as below table, whichever is the lesser attenuation

Frequencies (MHz)	Field strength (microvolts/meter)	Measurement distance (meters)
0.009 ~ 0.490	2400/F(kHz)	300
0.490 ~ 1.705	24000/F(kHz)	30
1.705 ~ 30.0	30	30
30 ~ 88	100	3
88 ~ 216	150	3
216 ~ 960	200	3
Above 960	500	3

**NOTE:**

1. The lower limit shall apply at the transition frequencies.
2. Emission level (dBuV/m) = 20 log Emission level (uV/m).
3. For frequencies above 1000MHz, the field strength limits are based on average detector, however, the peak field strength of any emission shall not exceed the maximum permitted average limits, specified above by more than 20dB under any condition of modulation.

## 4.2.2 TEST INSTRUMENTS

DESCRIPTION & MANUFACTURER	MODEL NO.	SERIAL NO.	CALIBRATED DATE	CALIBRATED UNTIL
HP Preamplifier	8447D	2432A03504	Feb. 29, 2012	Feb. 28, 2013
HP Preamplifier	8449B	3008A01201	Feb. 29, 2012	Feb. 28, 2013
Agilent Spectrum Analyzer	E4446A	MY46180403	Jun. 13, 2012	Jun. 12, 2013
ROHDE & SCHWARZ Test Receiver	ESCS 30	838251/021	Oct. 14, 2011	Oct. 13, 2012
Schwarzbeck Antenna	VULB 9168	137	Apr. 03, 2012	Apr. 02, 2013
Schwarzbeck Antenna	VHBA 9123	480	May 22, 2012	May 21, 2013
ADT. Turn Table	TT100	0306	NA	NA
ADT. Tower	AT100	0306	NA	NA
Software	ADT_Radiated_V 7.6.15.9.2	NA	NA	NA
SUHNER RF cable	SF102	CABLE-CH6	Aug. 19, 2012	Aug. 18, 2013
Schwarzbeck Horn Antenna	BBHA 9120-D1	D130	May 18, 2012	May 17, 2013
Highpass filter Wainwright Instruments	WHK 3.1/18G-10SS	SN 8	NA	NA

- NOTE:**
1. The calibration interval of the above test instruments is 12 months. And the calibrations are traceable to NML/ROC and NIST/USA.
  2. The horn antenna and HP preamplifier (model: 8449B) are used only for the measurement of emission frequency above 1GHz if tested.
  3. The test was performed in Chamber No. 6.
  4. The Industry Canada Reference No. IC 7450E-6.
  5. The FCC Site Registration No. is 447212.

### 4.2.3 TEST PROCEDURES

- a. The EUT was placed on the top of a rotating table 0.8 meters above the ground at a 3 meter semi-anechoic chamber. The table was rotated 360 degrees to determine the position of the highest radiation.
- b. The EUT was set 3 meters away from the interference-receiving antenna, which was mounted on the top of a variable-height antenna tower.
- c. The height of antenna is varied from one meter to four meters above the ground to determine the maximum value of the field strength. Both horizontal and vertical polarizations of the antenna are set to make the measurement.
- d. For each suspected emission, the EUT was arranged to its worst case and then the antenna was tuned to heights from 1 meter to 4 meters and the rotatable table was turned from 0 degrees to 360 degrees to find the maximum reading.
- e. The test-receiver system was set to Peak Detect Function and Specified Bandwidth with Maximum Hold Mode.
- f. If the emission level of the EUT in peak mode was lower than the limit specified, then testing could be stopped and the peak values of the EUT would be reported. Otherwise the emissions would be re-tested one by one using peak, quasi-peak or average method as specified and then reported in a data sheet.

**NOTE:**

1. The resolution bandwidth and video bandwidth of test receiver/spectrum analyzer is 120kHz for Quasi-peak detection at frequency below 1GHz.
2. The resolution bandwidth of test receiver/spectrum analyzer is 1MHz and video bandwidth is 3MHz for Peak detection at frequency above 1GHz.
3. All modes of operation were investigated and the worst-case emissions are reported.

### 4.2.4 DEVIATION FROM TEST STANDARD

No deviation.

## 4.2.5 TEST SETUP

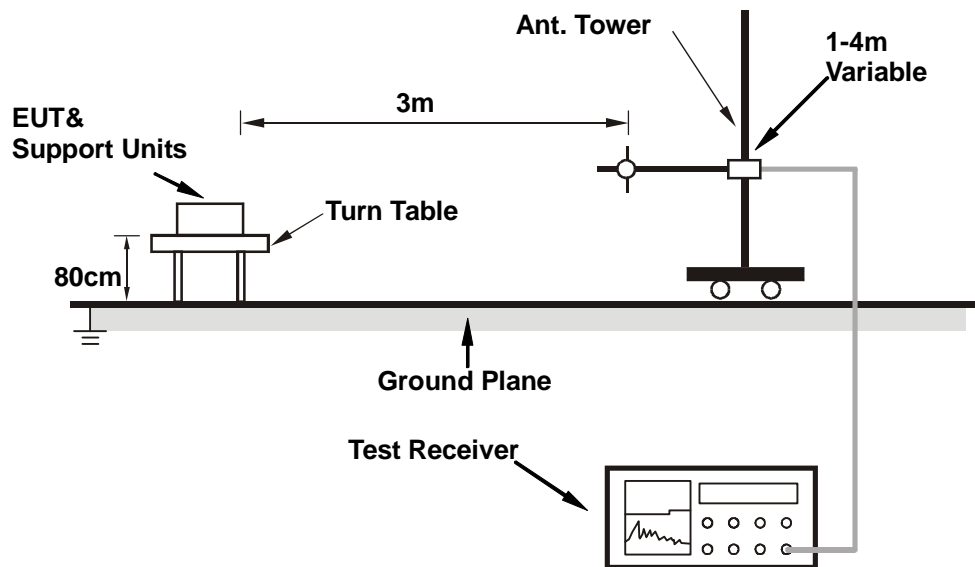

For the actual test configuration, please refer to the attached file (Test Setup Photo).

## 4.2.6 EUT OPERATING CONDITIONS

### Mode A:

Set the EUT under transmission condition continuously at specific channel frequency.

### Mode B:

- a. Connect the EUT to Notebook PC via cradle.
- b. Set the EUT under charging condition.



A D T

## 4.2.7 TEST RESULTS

### ABOVE 1GHz DATA

<b>CHANNEL</b>	TX Channel 1	<b>DETECTOR FUNCTION</b>	Peak (PK)
<b>FREQUENCY RANGE</b>	1GHz ~ 25GHz		Average (AV)
<b>TEST MODE</b>	A		

### ANTENNA POLARITY & TEST DISTANCE: HORIZONTAL AT 3 M

NO.	FREQ. (MHz)	EMISSION LEVEL (dBuV/m)	LIMIT (dBuV/m)	MARGIN (dB)	ANTENNA HEIGHT (m)	TABLE ANGLE (Degree)	RAW VALUE (dBuV)	CORRECTION FACTOR (dB/m)
1	2390.00	53.4 PK	74.0	-20.6	1.00 H	312	23.12	30.24
2	2390.00	43.3 AV	54.0	-10.7	1.00 H	312	13.05	30.24
3	2400.00	46.9 PK	74.0	-27.1	1.00 H	314	16.64	30.29
4	2400.00	18.9 AV	54.0	-35.1	1.00 H	314	-11.36	30.29
5	*2405.00	85.4 PK	114.0	-28.6	1.00 H	314	55.12	30.31
6	*2405.00	57.4 AV	94.0	-36.6	1.00 H	314	27.12	30.31
7	4810.00	45.7 PK	74.0	-28.3	1.00 H	16	9.08	36.61
8	4810.00	17.7 AV	54.0	-36.3	1.00 H	16	-18.92	36.61

### ANTENNA POLARITY & TEST DISTANCE: VERTICAL AT 3 M

NO.	FREQ. (MHz)	EMISSION LEVEL (dBuV/m)	LIMIT (dBuV/m)	MARGIN (dB)	ANTENNA HEIGHT (m)	TABLE ANGLE (Degree)	RAW VALUE (dBuV)	CORRECTION FACTOR (dB/m)
1	2390.00	54.4 PK	74.0	-19.6	1.00 V	349	24.13	30.24
2	2390.00	44.6 AV	54.0	-9.4	1.00 V	349	14.35	30.24
3	2400.00	50.4 PK	74.0	-23.6	1.00 V	349	20.10	30.29
4	2400.00	22.4 AV	54.0	-31.6	1.00 V	349	-7.90	30.29
5	*2405.00	88.9 PK	114.0	-25.1	1.00 V	349	58.58	30.31
6	*2405.00	60.9 AV	94.0	-33.1	1.00 V	349	30.58	30.31
7	4810.00	43.9 PK	74.0	-30.1	1.00 V	43	7.33	36.61
8	4810.00	15.9 AV	54.0	-38.1	1.00 V	43	-20.67	36.61

#### REMARKS:

1. Emission level (dBuV/m) = Raw Value (dBuV) + Correction Factor (dB/m).
2. Correction Factor (dB/m) = Antenna Factor (dB/m) + Cable Factor (dB).
3. The other emission levels were very low against the limit.
4. Margin value = Emission level – Limit value.
5. “ \* “ : Fundamental frequency
6. The average value of fundamental frequency is: Average = Peak value + 20log(Duty cycle) Where the duty factor is calculated from following formula:  
 $20 \log (\text{Duty cycle}) = 20 \log (4 \text{ ms} / 100 \text{ ms}) = -28.0 \text{ dB}$   
Please see page 24 for plotted duty.



A D T

<b>CHANNEL</b>	TX Channel 9	<b>DETECTOR FUNCTION</b>	Peak (PK)
<b>FREQUENCY RANGE</b>	1GHz ~ 25GHz		Average (AV)
<b>TEST MODE</b>	A		

**ANTENNA POLARITY & TEST DISTANCE: HORIZONTAL AT 3 M**

NO.	FREQ. (MHz)	EMISSION LEVEL (dBuV/m)	LIMIT (dBuV/m)	MARGIN (dB)	ANTENNA HEIGHT (m)	TABLE ANGLE (Degree)	RAW VALUE (dBuV)	CORRECTION FACTOR (dB/m)
1	*2445.00	80.8 PK	114.0	-33.2	1.00 H	313	50.33	30.44
2	*2445.00	52.8 AV	94.0	-41.2	1.00 H	313	22.33	30.44
3	4890.00	44.8 PK	74.0	-29.2	1.00 H	16	8.03	36.81
4	4890.00	16.8 AV	54.0	-37.2	1.00 H	16	-19.97	36.81

**ANTENNA POLARITY & TEST DISTANCE: VERTICAL AT 3 M**

NO.	FREQ. (MHz)	EMISSION LEVEL (dBuV/m)	LIMIT (dBuV/m)	MARGIN (dB)	ANTENNA HEIGHT (m)	TABLE ANGLE (Degree)	RAW VALUE (dBuV)	CORRECTION FACTOR (dB/m)
1	*2445.00	84.8 PK	114.0	-29.2	1.00 V	0	54.38	30.44
2	*2445.00	56.8 AV	94.0	-37.2	1.00 V	0	26.38	30.44
3	4890.00	46.0 PK	74.0	-28.0	1.00 V	58	9.16	36.81
4	4890.00	18.0 AV	54.0	-36.0	1.00 V	58	-18.84	36.81

**REMARKS:**

1. Emission level (dBuV/m) = Raw Value (dBuV) + Correction Factor (dB/m).
2. Correction Factor (dB/m) = Antenna Factor (dB/m) + Cable Factor (dB).
3. The other emission levels were very low against the limit.
4. Margin value = Emission level – Limit value.
5. “ \* “ : Fundamental frequency
6. The average value of fundamental frequency is: Average = Peak value + 20log(Duty cycle) Where the duty factor is calculated from following formula:  
 $20 \log (\text{Duty cycle}) = 20 \log (4 \text{ ms} / 100 \text{ ms}) = -28.0 \text{ dB}$   
Please see page 24 for plotted duty.



A D T

<b>CHANNEL</b>	TX Channel 16	<b>DETECTOR FUNCTION</b>	Peak (PK)
<b>FREQUENCY RANGE</b>	1GHz ~ 25GHz		Average (AV)
<b>TEST MODE</b>	A		

**ANTENNA POLARITY & TEST DISTANCE: HORIZONTAL AT 3 M**

NO.	FREQ. (MHz)	EMISSION LEVEL (dBuV/m)	LIMIT (dBuV/m)	MARGIN (dB)	ANTENNA HEIGHT (m)	TABLE ANGLE (Degree)	RAW VALUE (dBuV)	CORRECTION FACTOR (dB/m)
1	*2480.00	76.4 PK	114.0	-37.6	1.00 H	313	45.87	30.56
2	*2480.00	48.4 AV	94.0	-45.6	1.00 H	313	17.87	30.56
3	2483.50	37.3 PK	74.0	-36.7	1.00 H	313	6.76	30.57
4	2483.50	9.3 AV	54.0	-44.7	1.00 H	313	-21.24	30.57
5	4960.00	44.3 PK	74.0	-29.7	1.00 H	28	7.35	36.99
6	4960.00	16.3 AV	54.0	-37.7	1.00 H	28	-20.65	36.99

**ANTENNA POLARITY & TEST DISTANCE: VERTICAL AT 3 M**

NO.	FREQ. (MHz)	EMISSION LEVEL (dBuV/m)	LIMIT (dBuV/m)	MARGIN (dB)	ANTENNA HEIGHT (m)	TABLE ANGLE (Degree)	RAW VALUE (dBuV)	CORRECTION FACTOR (dB/m)
1	*2480.00	80.1 PK	114.0	-33.9	1.00 V	0	49.52	30.56
2	*2480.00	52.1 AV	94.0	-41.9	1.00 V	0	21.52	30.56
3	2483.50	41.0 PK	74.0	-33.0	1.00 V	0	10.41	30.57
4	2483.50	13.0 AV	54.0	-41.0	1.00 V	0	-17.59	30.57
5	4960.00	46.2 PK	74.0	-27.8	1.00 V	16	9.17	36.99
6	4960.00	18.2 AV	54.0	-35.8	1.00 V	16	-18.83	36.99

**REMARKS:**

1. Emission level (dBuV/m) = Raw Value (dBuV) + Correction Factor (dB/m).
2. Correction Factor (dB/m) = Antenna Factor (dB/m) + Cable Factor (dB).
3. The other emission levels were very low against the limit.
4. Margin value = Emission level – Limit value.
5. “ \* ” : Fundamental frequency
6. The average value of fundamental frequency is: Average = Peak value + 20log(Duty cycle) Where the duty factor is calculated from following formula:  
 $20 \log (\text{Duty cycle}) = 20 \log (4 \text{ ms} / 100 \text{ ms}) = -28.0 \text{ dB}$   
Please see page 24 for plotted duty.



A D T

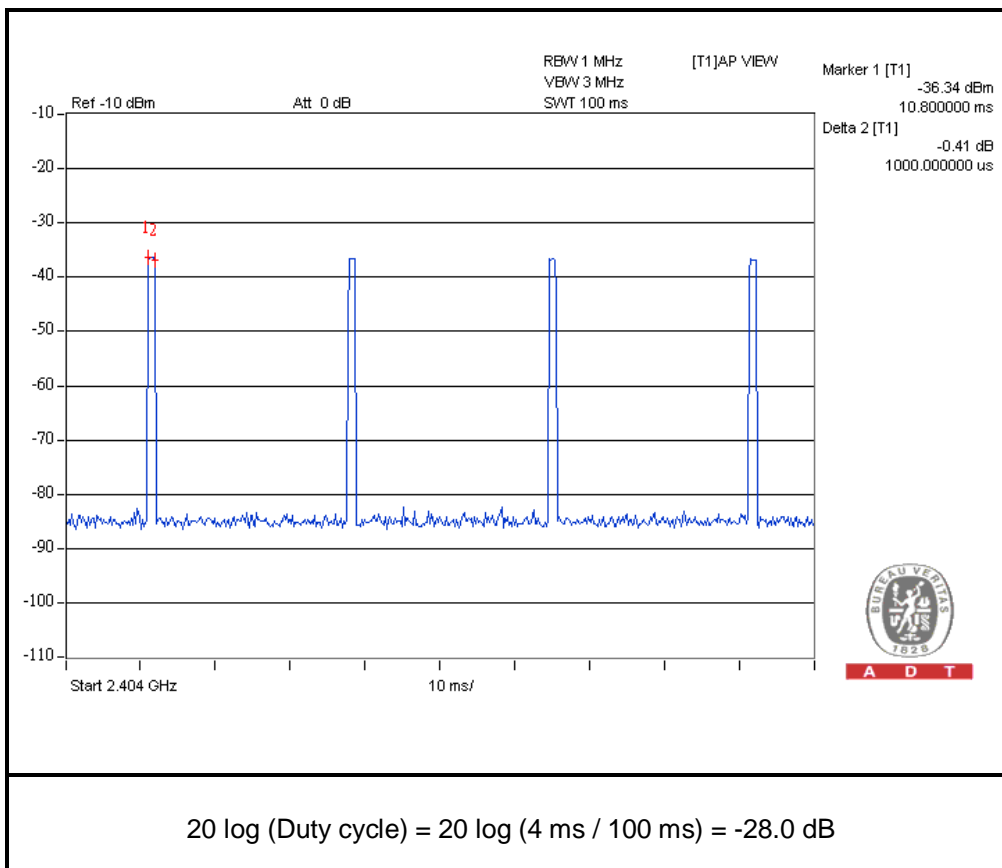

A D T





A D T

### BELOW 1GHz WORST-CASE DATA

<b>CHANNEL</b>	TX Channel 1	<b>DETECTOR FUNCTION</b>	Quasi-Peak
<b>FREQUENCY RANGE</b>	Below 1000MHz		
<b>TEST MODE</b>	A		

ANTENNA POLARITY & TEST DISTANCE: HORIZONTAL AT 3 M								
NO.	FREQ. (MHz)	EMISSION LEVEL (dBuV/m)	LIMIT (dBuV/m)	MARGIN (dB)	ANTENNA HEIGHT (m)	TABLE ANGLE (Degree)	RAW VALUE (dBuV)	CORRECTION FACTOR (dB/m)
1	160.95	35.8 QP	43.5	-7.7	1.00 H	143	21.74	14.08
2	215.92	35.5 QP	43.5	-8.0	1.00 H	11	23.66	11.88
3	227.23	37.9 QP	46.0	-8.1	1.00 H	258	25.53	12.40
4	257.95	35.7 QP	46.0	-10.3	1.50 H	62	21.90	13.80
5	299.98	36.8 QP	46.0	-9.2	1.00 H	25	21.15	15.62
6	665.35	37.1 QP	46.0	-8.9	1.00 H	74	12.91	24.18

ANTENNA POLARITY & TEST DISTANCE: VERTICAL AT 3 M								
NO.	FREQ. (MHz)	EMISSION LEVEL (dBuV/m)	LIMIT (dBuV/m)	MARGIN (dB)	ANTENNA HEIGHT (m)	TABLE ANGLE (Degree)	RAW VALUE (dBuV)	CORRECTION FACTOR (dB/m)
1	63.95	32.0 QP	40.0	-8.0	1.00 V	51	18.81	13.16
2	96.28	34.0 QP	43.5	-9.5	1.00 V	10	24.96	9.08
3	194.90	34.8 QP	43.5	-8.7	1.00 V	49	23.21	11.57
4	227.23	38.7 QP	46.0	-7.3	1.00 V	10	26.26	12.40
5	<b>257.95</b>	<b>38.9 QP</b>	<b>46.0</b>	<b>-7.2</b>	<b>1.00 V</b>	<b>10</b>	<b>25.05</b>	<b>13.80</b>
6	582.90	36.7 QP	46.0	-9.3	1.00 V	15	13.85	22.84

#### REMARKS:

1. Emission level (dBuV/m) = Raw Value (dBuV) + Correction Factor (dB/m).
2. Correction Factor (dB/m) = Antenna Factor (dB/m) + Cable Factor (dB).
3. The other emission levels were very low against the limit.
4. Margin value = Emission level – Limit value.



A D T

<b>FREQUENCY RANGE</b>	Below 1000MHz	<b>DETECTOR FUNCTION</b>	Quasi-Peak
<b>TEST MODE</b>	B		

ANTENNA POLARITY & TEST DISTANCE: HORIZONTAL AT 3 M								
NO.	FREQ. (MHz)	EMISSION LEVEL (dBuV/m)	LIMIT (dBuV/m)	MARGIN (dB)	ANTENNA HEIGHT (m)	TABLE ANGLE (Degree)	RAW VALUE (dBuV)	CORRECTION FACTOR (dB/m)
1	102.75	34.4 QP	43.5	-9.1	1.55 H	311	24.61	9.77
2	351.72	30.4 QP	46.0	-15.6	1.65 H	11	13.35	17.06
3	663.73	37.3 QP	46.0	-8.7	1.74 H	122	13.11	24.16
4	860.97	30.7 QP	46.0	-15.3	1.50 H	72	3.29	27.43
5	930.48	31.4 QP	46.0	-14.6	1.00 H	11	3.16	28.22
6	959.58	30.4 QP	46.0	-15.6	1.00 H	11	1.89	28.51
ANTENNA POLARITY & TEST DISTANCE: VERTICAL AT 3 M								
NO.	FREQ. (MHz)	EMISSION LEVEL (dBuV/m)	LIMIT (dBuV/m)	MARGIN (dB)	ANTENNA HEIGHT (m)	TABLE ANGLE (Degree)	RAW VALUE (dBuV)	CORRECTION FACTOR (dB/m)
1	38.08	31.0 QP	40.0	-9.0	1.00 V	10	18.06	12.92
2	67.18	29.2 QP	40.0	-10.8	1.36 V	10	16.35	12.83
3	101.13	31.9 QP	43.5	-11.6	1.52 V	82	22.30	9.58
4	726.78	30.0 QP	46.0	-16.0	1.44 V	9	4.94	25.07
5	799.53	31.1 QP	46.0	-15.0	1.36 V	10	4.55	26.50
6	860.97	31.2 QP	46.0	-14.8	1.08 V	300	3.77	27.43

**REMARKS:**

1. Emission level (dBuV/m) = Raw Value (dBuV) + Correction Factor (dB/m).
2. Correction Factor (dB/m) = Antenna Factor (dB/m) + Cable Factor (dB).
3. The other emission levels were very low against the limit.
4. Margin value = Emission level – Limit value.



## 5. PHOTOGRAPHS OF THE TEST CONFIGURATION

Please refer to the attached file (Test Setup Photo).



## 6. INFORMATION ON THE TESTING LABORATORIES

We, Bureau Veritas Consumer Products Services (H.K.) Ltd., Taoyuan Branch, were founded in 1988 to provide our best service in EMC, Radio, Telecom and Safety consultation. Our laboratories are accredited and approved according to ISO/IEC 17025.

If you have any comments, please feel free to contact us at the following:

**Linko EMC/RF Lab**

Tel: 886-2-26052180

Fax: 886-2-26051924

**Hsin Chu EMC/RF Lab**

Tel: 886-3-5935343

Fax: 886-3-5935342

**Hwa Ya EMC/RF/Safety/Telecom Lab**

Tel: 886-3-3183232

Fax: 886-3-3270892

**Email:** [service.adt@tw.bureauveritas.com](mailto:service.adt@tw.bureauveritas.com)

**Web Site:** [www.bureauveritas-adt.com](http://www.bureauveritas-adt.com)

The address and road map of all our labs can be found in our web site also.

## **7. APPENDIX A – MODIFICATION RECORDERS FOR ENGINEERING CHANGES TO THE EUT BY THE LAB**

No modifications were made to the EUT by the lab during the test.

**---END---**