



# FCC TEST REPORT

**REPORT NO.:** RF960726A13

**MODEL NO.:** MORFBZUO

**RECEIVED:** July 16, 2007

**TESTED:** July 26 ~ Aug. 21, 2007

**ISSUED:** Aug. 27, 2007

**APPLICANT:** PRIMAX ELECTRONICS LTD.

**ADDRESS:** No. 669, Ruey Kuang Road, Neihu, Taipei,  
Taiwan, R.O.C.

**ISSUED BY:** Advance Data Technology Corporation

**LAB LOCATION:** No. 47, 14th Ling, Chia Pau Tsuen, Lin Kou  
Hsiang 244, Taipei Hsien, Taiwan, R.O.C.

This test report consists of 32 pages in total. It may be duplicated completely for legal use with the approval of the applicant. It should not be reproduced except in full, without the written approval of our laboratory. The client should not use it to claim product endorsement by TAF, A2LA or any government agencies. The test results in the report only apply to the tested sample.





## Table of Contents

1.	CERTIFICATION.....	3
2.	SUMMARY OF TEST RESULTS.....	4
2.1	MEASUREMENT UNCERTAINTY.....	4
3.	GENERAL INFORMATION .....	5
3.1	GENERAL DESCRIPTION OF EUT .....	5
3.2	DESCRIPTION OF TEST MODES .....	6
3.2.1	CONFIGURATION OF SYSTEM UNDER TEST .....	6
3.2.2	TEST MODE APPLICABILITY AND TESTED CHANNEL DETAIL: .....	7
3.3	GENERAL DESCRIPTION OF APPLIED STANDARDS .....	8
3.4	DESCRIPTION OF SUPPORT UNITS .....	8
4.	TEST TYPES AND RESULTS.....	9
4.1	CONDUCTED EMISSION MEASUREMENT .....	9
4.1.1	LIMITS OF CONDUCTED EMISSION MEASUREMENT.....	9
4.1.2	TEST INSTRUMENTS .....	9
4.1.3	TEST PROCEDURES .....	10
4.1.4	DEVIATION FROM TEST STANDARD .....	10
4.1.5	TEST SETUP .....	10
4.1.6	EUT OPERATING CONDITIONS .....	11
4.1.7	TEST RESULTS.....	12
4.2	RADIATED EMISSION MEASUREMENT .....	18
4.2.1	LIMITS OF RADIATED EMISSION MEASUREMENT.....	18
4.2.2	TEST INSTRUMENTS .....	19
4.2.3	TEST PROCEDURES.....	20
4.2.4	DEVIATION FROM TEST STANDARD .....	20
4.2.5	TEST SETUP .....	21
4.2.6	EUT OPERATING CONDITIONS .....	21
4.2.7	TEST RESULTS.....	22
4.3	BAND EDGES MEASUREMENT .....	27
4.3.1	LIMITS OF BAND EDGES MEASUREMENT.....	27
4.3.2	TEST INSTRUMENTS .....	27
4.3.3	TEST PROCEDURE .....	27
4.3.4	DEVIATION FROM TEST STANDARD .....	27
4.3.5	EUT OPERATING CONDITION .....	27
4.3.6	TEST RESULTS.....	27
5.	PHOTOGRAPHS OF THE TEST CONFIGURATION.....	30
6.	INFORMATION ON THE TESTING LABORATORIES .....	31
7.	APPENDIX A – MODIFICATIONS RECORDERS FOR ENGINEERING CHANGES TO THE EUT BY THE LAB.....	32



## 1. CERTIFICATION

**PRODUCT:** Espresso Presenter Mouse  
**BRAND NAME:** PRIMAX, Fujitsu Siemens  
**MODEL NO.:** MORFBZUO  
**APPLICANT:** PRIMAX ELECTRONICS LTD.  
**TESTED:** July 26 ~ Aug. 21, 2007  
**TEST SAMPLE:** ENGINEERING SAMPLE  
**STANDARDS:** FCC Part 15, Subpart C (Section 15.249),  
ANSI C63.4-2003

The above equipment has been tested by **Advance Data Technology Corporation**, and found compliance with the requirement of the above standards. The test record, data evaluation & Equipment Under Test (EUT) configurations represented herein are true and accurate accounts of the measurements of the sample's EMC characteristics under the conditions specified in this report.

**PREPARED BY :** Annie Chang , **DATE:** Aug. 27, 2007  
( Annie Chang / Senior Specialist )

**TECHNICAL ACCEPTANCE :** Jamison Chan , **DATE:** Aug. 27, 2007  
Responsible for RF ( Jamison Chan / Senior Engineer )

**APPROVED BY :** Ken Liu , **DATE:** Aug. 27, 2007  
( Ken Liu / Deputy Manager )



## 2. SUMMARY OF TEST RESULTS

The EUT has been tested according to the following specifications:

<b>APPLIED STANDARD: FCC Part 15, Subpart C (Section 15.249)</b>			
<b>STANDARD PARAGRAPH</b>	<b>TEST TYPE</b>	<b>RESULT</b>	<b>REMARK</b>
15.207	Conducted Emission Test	PASS	Minimum passing margin is -13.16dB at 0.209MHz
15.209 15.249 15.249 (d)	Radiated Emission Test Band Edge Measurement Limit: 50dB less than the peak value of fundamental frequency or meet radiated emission limit in section 12.209	PASS	Minimum passing margin is -3.75dB at 74.709MHz

### 2.1 MEASUREMENT UNCERTAINTY

Where relevant, the following measurement uncertainty levels have been estimated for tests performed on the EUT as specified in CISPR 16-4-2:

This uncertainty represents an expanded uncertainty expressed at approximately the 95% confidence level using a coverage factor of  $k=2$ .

<b>Measurement</b>	<b>Frequency</b>	<b>Uncertainty</b>
Conducted emissions	9kHz ~ 30MHz	2.44 dB
Radiated emissions	30MHz ~ 1GHz	3.75 dB
	1GHz ~ 40GHz	2.89 dB

### 3. GENERAL INFORMATION

#### 3.1 GENERAL DESCRIPTION OF EUT

<b>EUT</b>	Espresso Presenter Mouse
<b>MODEL NO.</b>	MORFBZUO
<b>FCC ID</b>	EMJDMORFBZUO
<b>POWER SUPPLY</b>	5Vdc from host equipment
<b>MODULATION TYPE</b>	GFSK
<b>FREQUENCY RANGE</b>	2402MHz ~ 2474MHz
<b>NUMBER OF CHANNEL</b>	13
<b>ANTENNA TYPE</b>	Printed antenna with -1.12dBi gain
<b>DATA CABLE</b>	N/A
<b>I/O PORTS</b>	USB port
<b>ASSOCIATED DEVICES</b>	N/A

**NOTE:**

1. The EUT is a transceiver.
2. The above EUT information was declared by the manufacturer and for more detailed features description, please refer to the manufacturer's specifications or User's Manual.

## 3.2 DESCRIPTION OF TEST MODES

Thirteen channels are provided to this EUT.

Channel	Freq. (MHz)	Channel	Freq. (MHz)
1	2402	8	2444
2	2408	9	2450
3	2414	10	2456
4	2420	11	2462
5	2426	12	2468
6	2432	13	2474
7	2438		

### 3.2.1 CONFIGURATION OF SYSTEM UNDER TEST

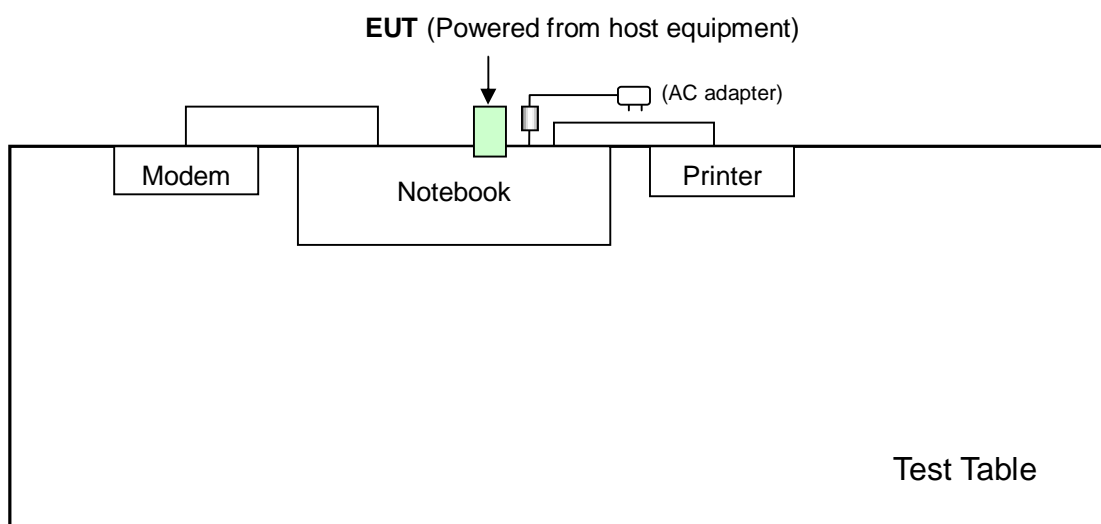

### 3.2.2 TEST MODE APPLICABILITY AND TESTED CHANNEL DETAIL:

EUT configure mode	Applicable to				Description
	PLC	RE<1G	RE≥1G	APCM	
-	√	√	√	√	-

Where PLC: Power Line Conducted Emission RE<1G RE: Radiated Emission below 1GHz  
 RE≥1G: Radiated Emission above 1GHz APCM: Antenna Port Conducted Measurement

#### **POWER LINE CONDUCTED EMISSION TEST:**

- Following channel(s) was (were) selected for the final test as listed below.

AVAILABLE CHANNEL	TESTED CHANNEL	MODULATION TYPE
1 to 13	1, 7, 13	GFSK

#### **RADIATED EMISSION TEST (BELOW 1 GHz):**

- Pre-Scan has been conducted to determine the worst-case mode from all possible combinations between available modulations, data rates and antenna ports (if EUT with antenna diversity architecture).
- Following channel(s) was (were) selected for the final test as listed below.

AVAILABLE CHANNEL	TESTED CHANNEL	MODULATION TYPE
1 to 13	1	GFSK

#### **RADIATED EMISSION TEST (ABOVE 1 GHz):**

- Pre-Scan has been conducted to determine the worst-case mode from all possible combinations between available modulations, data rates and antenna ports (if EUT with antenna diversity architecture).
- Following channel(s) was (were) selected for the final test as listed below.

AVAILABLE CHANNEL	TESTED CHANNEL	MODULATION TYPE
1 to 13	1, 7, 13	GFSK

#### **BANDEDGE MEASUREMENT:**

- Pre-Scan has been conducted to determine the worst-case mode from all possible combinations between available modulations, data rates and antenna ports (if EUT with antenna diversity architecture).
- Following channel(s) was (were) selected for the final test as listed below.

AVAILABLE CHANNEL	TESTED CHANNEL	MODULATION TYPE
1 to 13	1, 13	GFSK



### 3.3 GENERAL DESCRIPTION OF APPLIED STANDARDS

The EUT is a RF product. According to the specifications of the manufacturer, it must comply with the requirements of the following standards:

#### FCC Part 15, Subpart C. (15.249)

#### ANSI C63.4-2003

All test items have been performed and recorded as per the above standards.

### 3.4 DESCRIPTION OF SUPPORT UNITS

The EUT has been tested as an independent unit together with other necessary accessories or support units. The following support units or accessories were used to form a representative test configuration during the tests.

NO.	PRODUCT	BRAND	MODEL NO.	SERIAL NO.	FCC ID
1	PRINTER	EPSON	LQ-300+	DCGY017054	FCC DoC Approved
2	MODEM	ACEEX	1414	980020520	IFAXDM1414
3	NOTEBOOK COMPUTER	DELL	PP05L	20375526736	FCC DoC Approved

NO.	SIGNAL CABLE DESCRIPTION OF THE ABOVE SUPPORT UNITS
1	1.8m braid shielded wire, terminated with DB25 and Centronics connector via metallic frame, w/o core
2	1.2 m braid shielded wire, terminated with DB25 and DB9 connector via metallic frame, w/o core.
3	N/A

**NOTE:** All power cords of the above support units are non shielded (1.8m).



## 4. TEST TYPES AND RESULTS

### 4.1 CONDUCTED EMISSION MEASUREMENT

#### 4.1.1 LIMITS OF CONDUCTED EMISSION MEASUREMENT

FREQUENCY OF EMISSION (MHz)	CONDUCTED LIMIT (dB $\mu$ V)	
	Quasi-peak	Average
0.15-0.5	66 to 56	56 to 46
0.5-5	56	46
5-30	60	50

**NOTE:**

1. The lower limit shall apply at the transition frequencies.
2. All emanations from a class A/B digital device or system, including any network of conductors and apparatus connected thereto, shall not exceed the level of field strengths specified above.

#### 4.1.2 TEST INSTRUMENTS

DESCRIPTION & MANUFACTURER	MODEL NO.	SERIAL NO.	CALIBRATED UNTIL
ROHDE & SCHWARZ Test Receiver	ESCS 30	838251/021	Nov. 23, 2007
ROHDE & SCHWARZ Artificial Mains Network (for EUT)	ESH3-Z5	100218	Nov. 21, 2007
LISN With Adapter (for EUT)	AD10	C10Ada-001	Nov. 21, 2007
ROHDE & SCHWARZ Artificial Mains Network (for peripherals)	ESH3-Z5	100219	Nov. 07, 2007
ROHDE & SCHWARZ Artificial Mains Network (for peripherals)	ESH3-Z5	100220	Oct. 26, 2007
Software	ADT_Cond_V7.3.2	NA	NA
Software	ADT_ISN_V7.3.2	NA	NA
RF cable (JYEBAO)	5D-FB	Cable-C10.01	Mar. 01, 2008
SUHNTER Terminator (For ROHDE & SCHWARZ LISN)	65BNC-5001	E1-010773	Feb. 11, 2008

- NOTE:**
1. The calibration interval of the above test instruments is 12 months and the calibrations are traceable to NML/ROC and NIST/USA.
  2. The test was performed in ADT Shielded Room No. 10.
  3. The VCCI Site Registration No. C-1852.

### 4.1.3 TEST PROCEDURES

- a. The EUT was placed 0.4 meters from the conducting wall of the shielded room with EUT being connected to the power mains through a line impedance stabilization network (LISN). Other support units were connected to the power mains through another LISN. The two LISNs provide 50 ohm/ 50uH of coupling impedance for the measuring instrument.
- b. Both lines of the power mains connected to the EUT were checked for maximum conducted interference.
- c. The frequency range from 150kHz to 30MHz was searched. Emission levels under Limit - 20dB was not recorded.

### 4.1.4 DEVIATION FROM TEST STANDARD

No deviation.

### 4.1.5 TEST SETUP

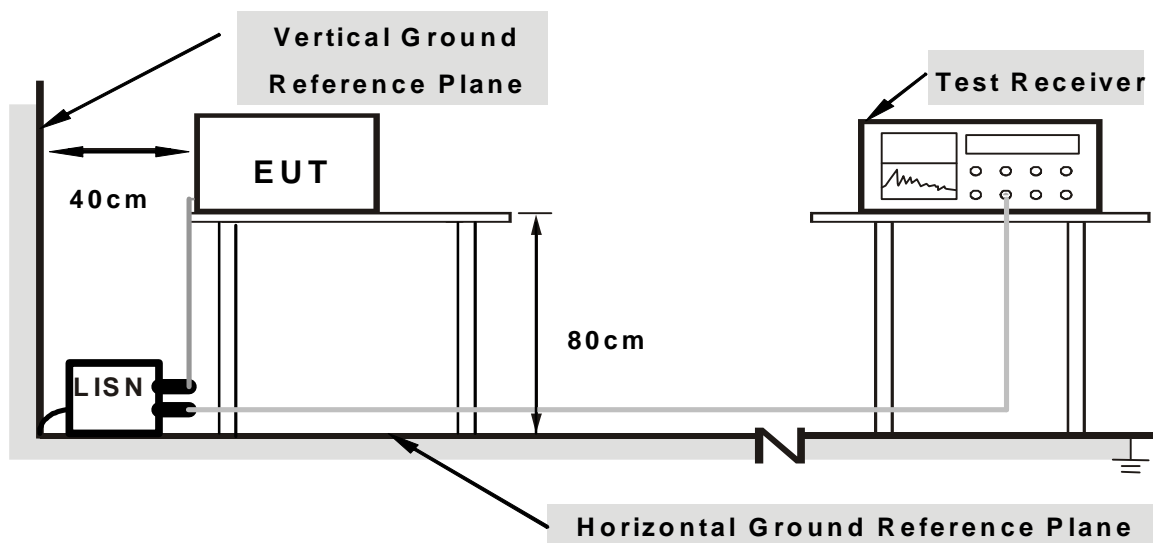

- Note:**
1. Support units were connected to second LISN.
  2. Both of LISNs (AMN) are 80 cm from EUT and at least 80 from other units and other metal planes

For the actual test configuration, please refer to the related item – Photographs of the Test Configuration.

#### **4.1.6 EUT OPERATING CONDITIONS**

- a. Connected the EUT to a notebook placed on a testing table.
- b. The notebook ran a test program (provided by manufacturer) to enable EUT under transmission/receiving condition continuously at specific channel frequency.
- c. The notebook sent "H" messages to its screen.
- d. The notebook sent messages to printer and the printer prints them out
- e. The notebook sent messages to modem.
- f. Repeated c ~ f.

## 4.1.7 TEST RESULTS

### CONDUCTED WORST CASE DATA

MODULATION TYPE	GFSK	CHANNEL	1
INPUT POWER (SYSTEM)	120Vac, 60 Hz	6dB BANDWIDTH	9 kHz
ENVIRONMENTAL CONDITIONS	26deg. C, 70%RH, 999hPa	PHASE	Line 1
TESTED BY	Jun Wu		

No	Freq. [MHz]	Corr. Factor (dB)	Reading Value		Emission Level		Limit		Margin	
			[dB (uV)]		[dB (uV)]		[dB (uV)]		(dB)	
			Q.P.	AV.	Q.P.	AV.	Q.P.	AV.	Q.P.	AV.
1	0.170	0.20	38.23	-	38.43	-	64.98	54.98	-26.55	-
2	0.216	0.20	49.55	-	49.75	-	62.96	52.96	-13.21	-
3	1.551	0.40	26.33	-	26.73	-	56.00	46.00	-29.27	-
4	2.195	0.41	25.91	-	26.32	-	56.00	46.00	-29.68	-
5	10.992	0.78	29.48	-	30.26	-	60.00	50.00	-29.74	-
6	17.418	1.25	23.92	-	25.17	-	60.00	50.00	-34.83	-

- REMARKS:**
1. Q.P. and AV. are abbreviations of quasi-peak and average individually.
  2. "-": The Quasi-peak reading value also meets average limit and measurement with the average detector is unnecessary.
  3. The emission levels of other frequencies were very low against the limit.
  4. Margin value = Emission level - Limit value
  5. Correction factor = Insertion loss + Cable loss
  6. Emission Level = Correction Factor + Reading Value.

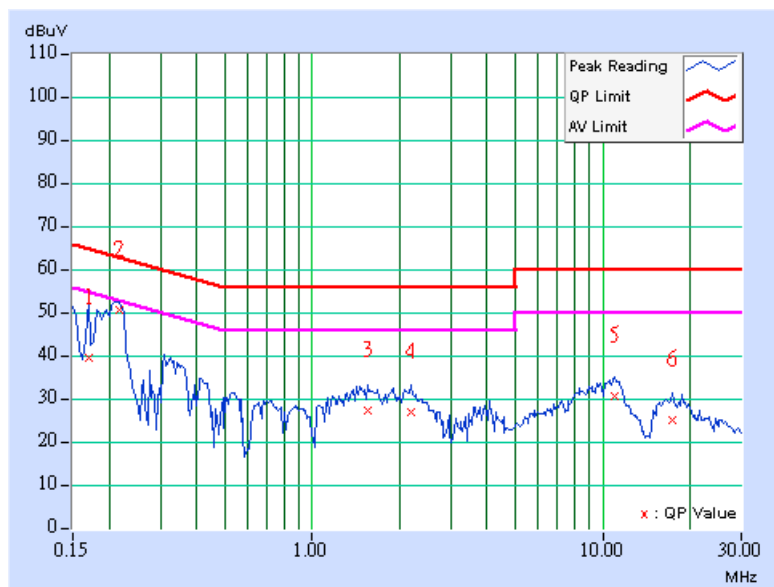

<b>MODULATION TYPE</b>	GFSK	<b>CHANNEL</b>	1
<b>INPUT POWER (SYSTEM)</b>	120Vac, 60 Hz	<b>6dB BANDWIDTH</b>	9 kHz
<b>ENVIRONMENTAL CONDITIONS</b>	26deg. C, 70%RH, 999hPa	<b>PHASE</b>	Line 2
<b>TESTED BY</b>	Jun Wu		

No	Freq. [MHz]	Corr. Factor (dB)	Reading Value		Emission Level		Limit		Margin	
			[dB (uV)]		[dB (uV)]		[dB (uV)]		(dB)	
			Q.P.	AV.	Q.P.	AV.	Q.P.	AV.	Q.P.	AV.
1	0.189	0.20	47.12	-	47.32	-	64.08	54.08	-16.76	-
<b>2</b>	<b>0.209</b>	<b>0.20</b>	<b>49.90</b>	-	<b>50.10</b>	-	<b>63.26</b>	<b>53.26</b>	<b>-13.16</b>	-
3	1.691	0.30	28.55	-	28.85	-	56.00	46.00	-27.15	-
4	2.098	0.30	27.91	-	28.21	-	56.00	46.00	-27.79	-
5	10.602	0.54	29.82	-	30.36	-	60.00	50.00	-29.64	-
6	18.004	0.92	24.82	-	25.74	-	60.00	50.00	-34.26	-

- REMARKS:**
1. Q.P. and AV. are abbreviations of quasi-peak and average individually.
  2. "-": The Quasi-peak reading value also meets average limit and measurement with the average detector is unnecessary.
  3. The emission levels of other frequencies were very low against the limit.
  4. Margin value = Emission level - Limit value
  5. Correction factor = Insertion loss + Cable loss
  6. Emission Level = Correction Factor + Reading Value.

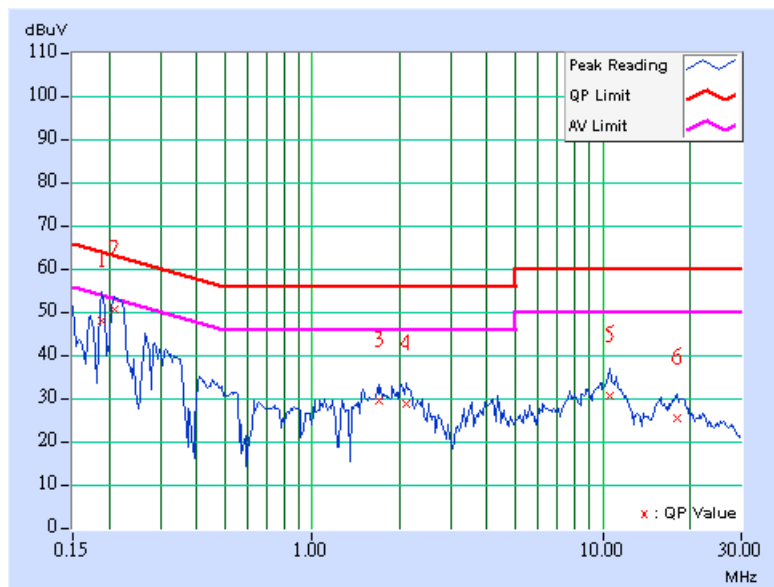

<b>MODULATION TYPE</b>	GFSK	<b>CHANNEL</b>	7
<b>INPUT POWER (SYSTEM)</b>	120Vac, 60 Hz	<b>6dB BANDWIDTH</b>	9 kHz
<b>ENVIRONMENTAL CONDITIONS</b>	26deg. C, 70%RH, 999hPa	<b>PHASE</b>	Line 1
<b>TESTED BY</b>	Jun Wu		

No	Freq. [MHz]	Corr. Factor (dB)	Reading Value [dB (uV)]		Emission Level [dB (uV)]		Limit [dB (uV)]		Margin (dB)	
			Q.P.	AV.	Q.P.	AV.	Q.P.	AV.	Q.P.	AV.
	1	0.171	0.20	37.82	-	38.02	-	64.90	54.90	-26.88
2	0.217	0.20	49.13	-	49.33	-	62.93	52.93	-13.60	-
3	1.551	0.40	26.73	-	27.13	-	56.00	46.00	-28.87	-
4	2.194	0.41	26.09	-	26.50	-	56.00	46.00	-29.50	-
5	10.991	0.78	29.63	-	30.41	-	60.00	50.00	-29.59	-
6	17.420	1.25	24.28	-	25.53	-	60.00	50.00	-34.47	-

- REMARKS:**
1. Q.P. and AV. are abbreviations of quasi-peak and average individually.
  2. "-": The Quasi-peak reading value also meets average limit and measurement with the average detector is unnecessary.
  3. The emission levels of other frequencies were very low against the limit.
  4. Margin value = Emission level - Limit value
  5. Correction factor = Insertion loss + Cable loss
  6. Emission Level = Correction Factor + Reading Value.

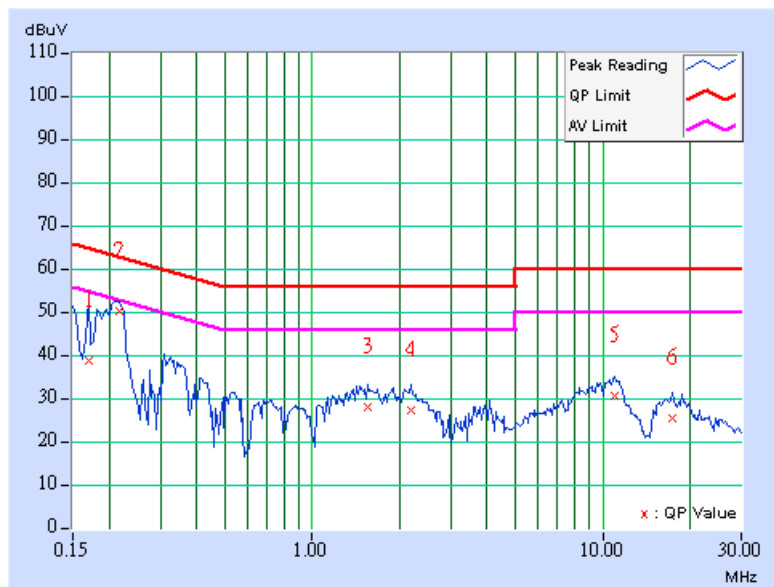

<b>MODULATION TYPE</b>	GFSK	<b>CHANNEL</b>	7
<b>INPUT POWER (SYSTEM)</b>	120Vac, 60 Hz	<b>6dB BANDWIDTH</b>	9 kHz
<b>ENVIRONMENTAL CONDITIONS</b>	26deg. C, 70%RH, 999hPa	<b>PHASE</b>	Line 2
<b>TESTED BY</b>	Jun Wu		

No	Freq. [MHz]	Corr. Factor (dB)	Reading Value		Emission Level		Limit		Margin	
			[dB (uV)]		[dB (uV)]		[dB (uV)]		(dB)	
			Q.P.	AV.	Q.P.	AV.	Q.P.	AV.	Q.P.	AV.
1	0.173	0.20	37.23	-	37.43	-	64.79	54.79	-27.36	-
2	0.216	0.20	49.46	-	49.66	-	62.96	52.96	-13.30	-
3	1.980	0.30	27.50	-	27.80	-	56.00	46.00	-28.20	-
4	3.668	0.38	22.58	-	22.96	-	56.00	46.00	-33.04	-
5	9.992	0.50	28.69	-	29.19	-	60.00	50.00	-30.81	-
6	11.180	0.57	29.99	-	30.56	-	60.00	50.00	-29.44	-

- REMARKS:**
1. Q.P. and AV. are abbreviations of quasi-peak and average individually.
  2. "-": The Quasi-peak reading value also meets average limit and measurement with the average detector is unnecessary.
  3. The emission levels of other frequencies were very low against the limit.
  4. Margin value = Emission level - Limit value
  5. Correction factor = Insertion loss + Cable loss
  6. Emission Level = Correction Factor + Reading Value.

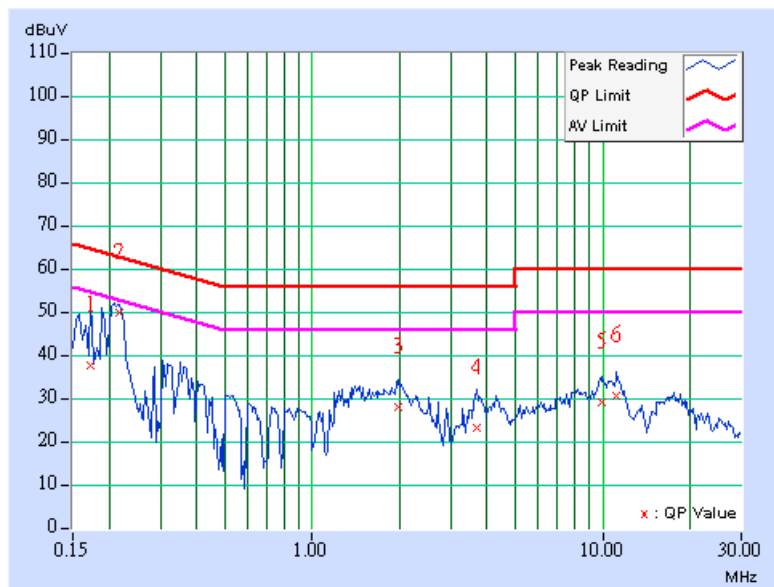

<b>MODULATION TYPE</b>	GFSK	<b>CHANNEL</b>	13
<b>INPUT POWER (SYSTEM)</b>	120Vac, 60 Hz	<b>6dB BANDWIDTH</b>	9 kHz
<b>ENVIRONMENTAL CONDITIONS</b>	26deg. C, 70%RH, 999hPa	<b>PHASE</b>	Line 1
<b>TESTED BY</b>	Jun Wu		

No	Freq. [MHz]	Corr. Factor (dB)	Reading Value [dB (uV)]		Emission Level [dB (uV)]		Limit [dB (uV)]		Margin (dB)	
			Q.P.	AV.	Q.P.	AV.	Q.P.	AV.	Q.P.	AV.
	1	0.173	0.20	37.72	-	37.92	-	64.79	54.79	-26.87
2	0.213	0.20	48.19	-	48.39	-	63.11	53.11	-14.72	-
3	1.441	0.40	24.05	-	24.45	-	56.00	46.00	-31.55	-
4	1.855	0.40	27.65	-	28.05	-	56.00	46.00	-27.95	-
5	8.457	0.65	26.93	-	27.58	-	60.00	50.00	-32.42	-
6	10.629	0.75	29.69	-	30.44	-	60.00	50.00	-29.56	-

- REMARKS:**
1. Q.P. and AV. are abbreviations of quasi-peak and average individually.
  2. "-": The Quasi-peak reading value also meets average limit and measurement with the average detector is unnecessary.
  3. The emission levels of other frequencies were very low against the limit.
  4. Margin value = Emission level - Limit value
  5. Correction factor = Insertion loss + Cable loss
  6. Emission Level = Correction Factor + Reading Value.

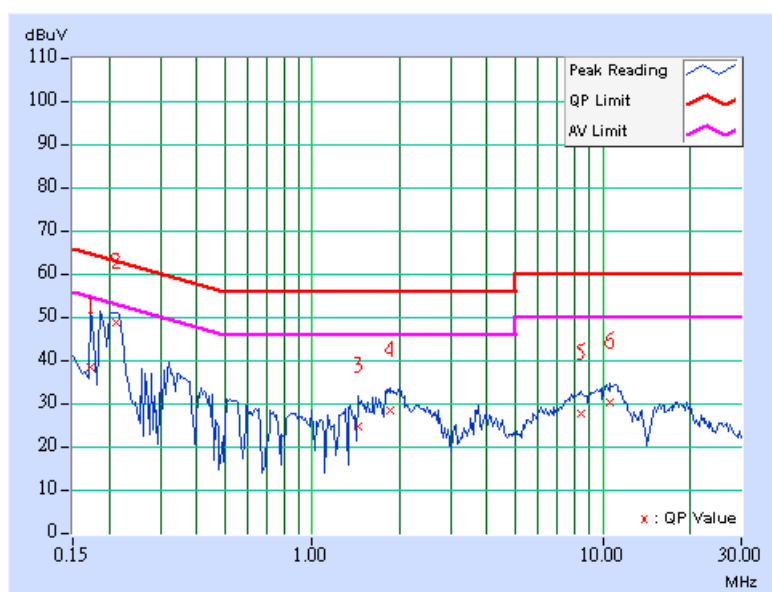



<b>MODULATION TYPE</b>	GFSK	<b>CHANNEL</b>	13
<b>INPUT POWER (SYSTEM)</b>	120Vac, 60 Hz	<b>6dB BANDWIDTH</b>	9 kHz
<b>ENVIRONMENTAL CONDITIONS</b>	26deg. C, 70%RH, 999hPa	<b>PHASE</b>	Line 2
<b>TESTED BY</b>	Jun Wu		

No	Freq. [MHz]	Corr. Factor (dB)	Reading Value		Emission Level		Limit		Margin	
			[dB (uV)]		[dB (uV)]		[dB (uV)]		(dB)	
			Q.P.	AV.	Q.P.	AV.	Q.P.	AV.	Q.P.	AV.
1	0.175	0.20	34.51	-	34.71	-	64.73	54.73	-30.02	-
2	0.215	0.20	48.86	-	49.06	-	63.01	53.01	-13.95	-
3	1.983	0.30	27.27	-	27.57	-	56.00	46.00	-28.43	-
4	3.671	0.38	22.99	-	23.37	-	56.00	46.00	-32.63	-
5	9.992	0.50	28.75	-	29.25	-	60.00	50.00	-30.75	-
6	11.180	0.57	29.87	-	30.44	-	60.00	50.00	-29.56	-

- REMARKS:**
1. Q.P. and AV. are abbreviations of quasi-peak and average individually.
  2. "-": The Quasi-peak reading value also meets average limit and measurement with the average detector is unnecessary.
  3. The emission levels of other frequencies were very low against the limit.
  4. Margin value = Emission level - Limit value
  5. Correction factor = Insertion loss + Cable loss
  6. Emission Level = Correction Factor + Reading Value.

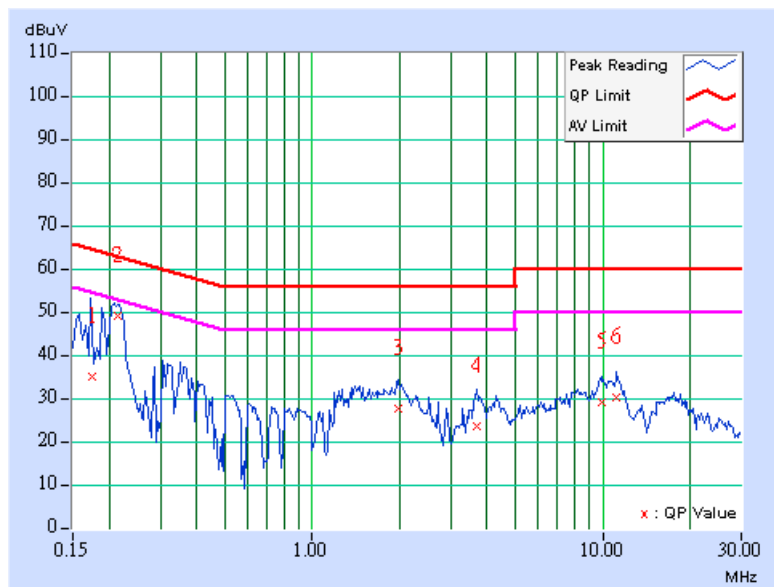

## 4.2 RADIATED EMISSION MEASUREMENT

### 4.2.1 LIMITS OF RADIATED EMISSION MEASUREMENT

Emissions radiated outside of the specified bands, shall be according to the general radiated limits in 15.209 as following:

Frequencies (MHz)	Field strength (microvolts/meter)	Measurement distance (meters)
0.009-0.490	2400/F(kHz)	300
0.490-1.705	24000/F(kHz)	30
1.705-30.0	30	30
30-88	100	3
88-216	150	3
216-960	200	3
Above 960	500	3

**NOTE:**

1. The lower limit shall apply at the transition frequencies.
2. Emission level (dBuV/m) = 20 log Emission level (uV/m).
3. As shown in 15.35(b), for frequencies above 1000MHz, the field strength limits are based on average detector, however, the peak field strength of any emission shall not exceed the maximum permitted average limits, specified above by more than 20dB under any condition of modulation.



## 4.2.2 TEST INSTRUMENTS

DESCRIPTION & MANUFACTURER	MODEL NO.	SERIAL NO.	CALIBRATED UNTIL
HP Preamplifier	8447D	2432A03504	May 09, 2008
HP Preamplifier	8449B	3008A01924	Sep. 05, 2007
HP Preamplifier	8449B	3008A01638	Sep. 17, 2007
ROHDE & SCHWARZ TEST RECEIVER	ESI7	836697/012	Oct. 24, 2007
Schwarzbeck Antenna	VULB 9168	137	Oct. 01, 2007
Schwarzbeck Antenna	VHBA 9123	480	Apr. 18, 2008
EMCO Horn Antenna	3115	6714	Oct. 24, 2007
EMCO Horn Antenna	3115	9312-4192	Apr. 19, 2008
ADT. Turn Table	TT100	0306	NA
ADT. Tower	AT100	0306	NA
Software	ADT_Radiated_V 7.6.15	NA	NA
SUHNER RF cable	SF104-26.5	CABLE-CH6-17m-01	Dec. 11, 2007
ROHDE & SCHWARZ Spectrum Analyzer	FSP 40	100036	Mar. 13, 2008

- NOTE:**
1. The calibration interval of the above test instruments is 12 months. And the calibrations are traceable to NML/ROC and NIST/USA.
  2. The horn antenna and HP preamplifier (model: 8449B) are used only for the measurement of emission frequency above 1GHz if tested.
  3. The test was performed in ADT Chamber No. 6.
  4. The Industry Canada Reference No. IC 3789-6.

### 4.2.3 TEST PROCEDURES

- a. The EUT was placed on the top of a rotating table 0.8 meters above the ground at a 3 meter semi- anechoic chamber. The table was rotated 360 degrees to determine the position of the highest radiation.
- b. The EUT was set 3 meters away from the interference-receiving antenna, which was mounted on the top of a variable-height antenna tower.
- c. The antenna is a broadband antenna, and its height is varied from one meter to four meters above the ground to determine the maximum value of the field strength. Both horizontal and vertical polarizations of the antenna are set to make the measurement.
- d. For each suspected emission, the EUT was arranged to its worst case and then the antenna was tuned to heights from 1 meter to 4 meters and the rotatable table was turned from 0 degrees to 360 degrees to find the maximum reading.
- e. The test-receiver system was set to Peak Detect Function and Specified Bandwidth with Maximum Hold Mode.
- f. If the emission level of the EUT in peak mode was lower than the limit specified, then testing could be stopped and the peak values of the EUT would be reported. Otherwise the emissions would be re-tested one by one using peak, quasi-peak method or average method as specified and then reported in data sheet.

#### NOTE:

1. The resolution bandwidth of test receiver/spectrum analyzer is 120kHz for Quasi-peak detection at frequency below 1GHz.
2. The resolution bandwidth is 1MHz and video bandwidth of test receiver/spectrum analyzer is 3MHz for Peak detection at frequency above 1GHz. The resolution bandwidth of test receiver/spectrum analyzer is 1 MHz for Average detection (AV) at frequency above 1GHz.
3. The resolution bandwidth of test receiver/spectrum analyzer is 1 MHz and the video bandwidth is 10 Hz for Average detection (AV) at frequency above 1GHz.

### 4.2.4 DEVIATION FROM TEST STANDARD

No deviation

## 4.2.5 TEST SETUP

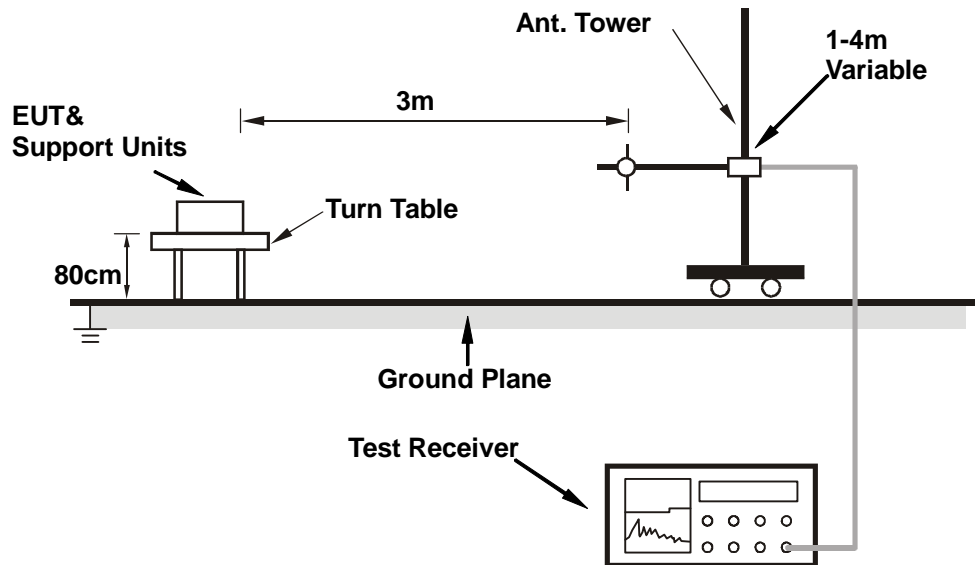

For the actual test configuration, please refer to the related item – Photographs of the Test Configuration.

## 4.2.6 EUT OPERATING CONDITIONS

Set the EUT under transmission condition continuously at specific channel frequency.



## 4.2.7 TEST RESULTS

### RADIATED WORST CASE DATA: BELOW 1GHz

<b>MODULATION TYPE</b>	GFSK	<b>CHANNEL</b>	1
<b>INPUT POWER (SYSTEM)</b>	120Vac, 60 Hz	<b>FREQUENCY RANGE</b>	Below 1000MHz
<b>ENVIRONMENTAL CONDITIONS</b>	26deg. C, 68%RH, 1001Pa	<b>DETECTOR FUNCTION</b>	Quasi-Peak
<b>TESTED BY</b>	Jun Wu		

### ANTENNA POLARITY & TEST DISTANCE: HORIZONTAL AT 3 M

No.	Freq. (MHz)	Emission Level (dBuV/m)	Limit (dBuV/m)	Margin (dB)	Antenna Height (m)	Table Angle (Degree)	Raw Value (dBuV)	Correction Factor (dB/m)
1	53.327	30.10 QP	40.00	-9.90	1.42 H	346	15.63	14.47
2	63.046	31.20 QP	40.00	-8.80	1.38 H	358	17.50	13.70
3	304.088	29.77 QP	46.00	-16.23	1.34 H	325	13.02	16.75
4	521.804	31.85 QP	46.00	-14.15	1.28 H	358	9.11	22.74
5	735.631	32.78 QP	46.00	-13.22	1.16 H	289	5.42	27.36
6	799.780	29.59 QP	46.00	-16.41	1.07 H	10	1.42	28.17
7	867.816	30.14 QP	46.00	-15.86	1.00 H	172	1.09	29.05

### ANTENNA POLARITY & TEST DISTANCE: VERTICAL AT 3 M

No.	Freq. (MHz)	Emission Level (dBuV/m)	Limit (dBuV/m)	Margin (dB)	Antenna Height (m)	Table Angle (Degree)	Raw Value (dBuV)	Correction Factor (dB/m)
<b>1</b>	<b>74.709</b>	<b>36.25 QP</b>	<b>40.00</b>	<b>-3.75</b>	<b>1.00 V</b>	<b>136</b>	<b>24.14</b>	<b>12.10</b>
2	134.970	33.63 QP	43.50	-9.87	1.00 V	7	20.26	13.37
3	166.072	30.85 QP	43.50	-12.65	1.00 V	70	17.18	13.68
4	521.804	31.51 QP	46.00	-14.49	1.05 V	10	8.77	22.74
5	735.631	29.23 QP	46.00	-16.77	1.24 V	127	1.87	27.36
6	867.816	31.33 QP	46.00	-14.67	1.32 V	55	2.28	29.05

- REMARKS:**
1. Emission level(dBuV/m)=Raw Value(dBuV) + Correction Factor(dB/m)
  2. Correction Factor(dB/m) = Antenna Factor (dB/m) + Cable Factor (dB)
  3. The other emission levels were very low against the limit.
  4. Margin value = Emission level – Limit value.



**RADIATED WORST CASE DATA: ABOVE 1GHz**

<b>MODULATION TYPE</b>	GFSK	<b>CHANNEL</b>	1
<b>INPUT POWER (SYSTEM)</b>	120Vac, 60 Hz	<b>FREQUENCY RANGE</b>	1 ~ 25GHz
<b>ENVIRONMENTAL CONDITIONS</b>	25deg. C, 60%RH, 995Pa	<b>DETECTOR FUNCTION</b>	Peak(PK) Average (AV)
<b>TESTED BY</b>	Jun Wu		

**ANTENNA POLARITY & TEST DISTANCE: HORIZONTAL AT 3 M**

No.	Freq. (MHz)	Emission Level (dBuV/m)	Limit (dBuV/m)	Margin (dB)	Antenna Height (m)	Table Angle (Degree)	Raw Value (dBuV)	Correction Factor (dB/m)
1	2390.000	58.23 PK	74.00	-15.77	1.18 H	160	23.81	34.42
2	2390.000	24.79 AV	54.00	-29.21	1.18 H	160	-9.63	34.42
3	*2402.000	92.52 PK	114.00	-21.48	1.18 H	160	58.08	34.44
4	*2402.000	59.08 AV	94.00	-34.92	1.18 H	160	24.64	34.44
5	4804.000	57.40 PK	74.00	-16.60	1.00 H	176	16.01	41.39
6	4804.000	23.96 AV	54.00	-30.04	1.00 H	176	-17.43	41.39

**ANTENNA POLARITY & TEST DISTANCE: VERTICAL AT 3 M**

No.	Freq. (MHz)	Emission Level (dBuV/m)	Limit (dBuV/m)	Margin (dB)	Antenna Height (m)	Table Angle (Degree)	Raw Value (dBuV)	Correction Factor (dB/m)
1	2390.000	55.02 PK	74.00	-18.98	1.00 V	157	20.60	34.42
2	2390.000	21.58 AV	54.00	-32.42	1.00 V	157	-12.84	34.42
3	*2402.000	91.44 PK	114.00	-22.56	1.00 V	157	57.00	34.44
4	*2402.000	58.00 AV	94.00	-36.00	1.00 V	157	23.56	34.44
5	4804.000	59.45 PK	74.00	-14.55	1.00 V	196	18.06	41.39
6	4804.000	26.01 AV	54.00	-27.99	1.00 V	196	-15.38	41.39

- REMARKS:**
1. Emission level(dBuV/m)=Raw Value(dBuV) + Correction Factor(dB/m)
  2. Correction Factor(dB/m) = Antenna Factor (dB/m) + Cable Factor (dB)
  3. The other emission levels were very low against the limit.
  4. Margin value = Emission level – Limit value.
  5. “ \* “ : Fundamental frequency
  6. The average value of fundamental frequency is: Average = Peak value + 20log(Duty cycle) Where the duty factor is calculated from following formula:

$$20\log(\text{Duty cycle}) = 20\log \frac{0.346\text{ms}}{16.275 \text{ ms}} = -33.44\text{dB}$$

Please see page 26 for plotted duty.



<b>MODULATION TYPE</b>	GFSK	<b>CHANNEL</b>	7
<b>INPUT POWER (SYSTEM)</b>	120Vac, 60 Hz	<b>FREQUENCY RANGE</b>	1 ~ 25GHz
<b>ENVIRONMENTAL CONDITIONS</b>	25deg. C, 60%RH, 995Pa	<b>DETECTOR FUNCTION</b>	Peak(PK) Average (AV)
<b>TESTED BY</b>	Jun Wu		

#### ANTENNA POLARITY & TEST DISTANCE: HORIZONTAL AT 3 M

No.	Freq. (MHz)	Emission Level (dBuV/m)	Limit (dBuV/m)	Margin (dB)	Antenna Height (m)	Table Angle (Degree)	Raw Value (dBuV)	Correction Factor (dB/m)
1	*2438.000	94.20 PK	114.00	-19.80	1.16 H	160	59.68	34.52
2	*2438.000	60.76 AV	94.00	-33.24	1.16 H	160	26.24	34.52
3	4876.000	57.14 PK	74.00	-16.86	1.00 H	210	15.56	41.58
4	4876.000	23.70 AV	54.00	-30.30	1.00 H	210	-17.88	41.58

#### ANTENNA POLARITY & TEST DISTANCE: VERTICAL AT 3 M

No.	Freq. (MHz)	Emission Level (dBuV/m)	Limit (dBuV/m)	Margin (dB)	Antenna Height (m)	Table Angle (Degree)	Raw Value (dBuV)	Correction Factor (dB/m)
1	*2438.000	91.85 PK	114.00	-22.15	1.00 V	156	57.33	34.52
2	*2438.000	58.41 AV	94.00	-35.59	1.00 V	156	23.89	34.52
3	4876.000	59.21 PK	74.00	-14.79	1.00 V	208	17.63	41.58
4	4876.000	25.77 AV	54.00	-28.23	1.00 V	208	-15.81	41.58

- REMARKS:**
1. Emission level(dBuV/m)=Raw Value(dBuV) + Correction Factor(dB/m)
  2. Correction Factor(dB/m) = Antenna Factor (dB/m) + Cable Factor (dB)
  3. The other emission levels were very low against the limit.
  4. Margin value = Emission level – Limit value.
  5. “ \* “ : Fundamental frequency
  6. The average value of fundamental frequency is: Average = Peak value + 20log(Duty cycle) Where the duty factor is calculated from following formula:

$$20\log(\text{Duty cycle}) = 20\log \frac{0.346\text{ms}}{16.275 \text{ ms}} = -33.44\text{dB}$$

Please see page 26 for plotted duty.





<b>MODULATION TYPE</b>	GFSK	<b>CHANNEL</b>	13
<b>INPUT POWER (SYSTEM)</b>	120Vac, 60 Hz	<b>FREQUENCY RANGE</b>	1 ~ 25GHz
<b>ENVIRONMENTAL CONDITIONS</b>	25deg. C, 60%RH, 995Pa	<b>DETECTOR FUNCTION</b>	Peak(PK) Average (AV)
<b>TESTED BY</b>	Jun Wu		

#### ANTENNA POLARITY & TEST DISTANCE: HORIZONTAL AT 3 M

No.	Freq. (MHz)	Emission Level (dBuV/m)	Limit (dBuV/m)	Margin (dB)	Antenna Height (m)	Table Angle (Degree)	Raw Value (dBuV)	Correction Factor (dB/m)
1	*2474.000	94.79 PK	114.00	-19.21	1.27 H	126	60.20	34.59
2	*2474.000	61.35 AV	94.00	-32.65	1.27 H	126	26.76	34.59
3	2483.500	62.12 PK	74.00	-11.88	1.27 H	126	27.51	34.61
4	2483.500	28.68 AV	54.00	-25.32	1.27 H	126	-5.93	34.61
5	4948.000	57.06 PK	74.00	-16.94	1.00 H	192	15.29	41.77
6	4948.000	23.62 AV	54.00	-30.38	1.00 H	192	-18.15	41.77

#### ANTENNA POLARITY & TEST DISTANCE: VERTICAL AT 3 M

No.	Freq. (MHz)	Emission Level (dBuV/m)	Limit (dBuV/m)	Margin (dB)	Antenna Height (m)	Table Angle (Degree)	Raw Value (dBuV)	Correction Factor (dB/m)
1	*2474.000	91.05 PK	114.00	-22.95	1.00 V	164	56.46	34.59
2	*2474.000	57.61 AV	94.00	-36.39	1.00 V	164	23.02	34.59
3	2483.500	61.29 PK	74.00	-12.71	1.00 V	164	26.68	34.61
4	2483.500	27.85 AV	54.00	-26.15	1.00 V	164	-6.76	34.61
5	4948.000	58.49 PK	74.00	-15.51	1.00 V	213	16.72	41.77
6	4948.000	25.05 AV	54.00	-28.95	1.00 V	213	-16.72	41.77

- REMARKS:**
1. Emission level(dBuV/m)=Raw Value(dBuV) + Correction Factor(dB/m)
  2. Correction Factor(dB/m) = Antenna Factor (dB/m) + Cable Factor (dB)
  3. The other emission levels were very low against the limit.
  4. Margin value = Emission level – Limit value.
  5. “ \* “ : Fundamental frequency
  6. The average value of fundamental frequency is: Average = Peak value + 20log(Duty cycle) Where the duty factor is calculated from following formula:

$$20\log(\text{Duty cycle}) = 20\log \frac{0.346\text{ms}}{16.275 \text{ ms}} = -33.44\text{dB}$$

Please see page 26 for plotted duty.

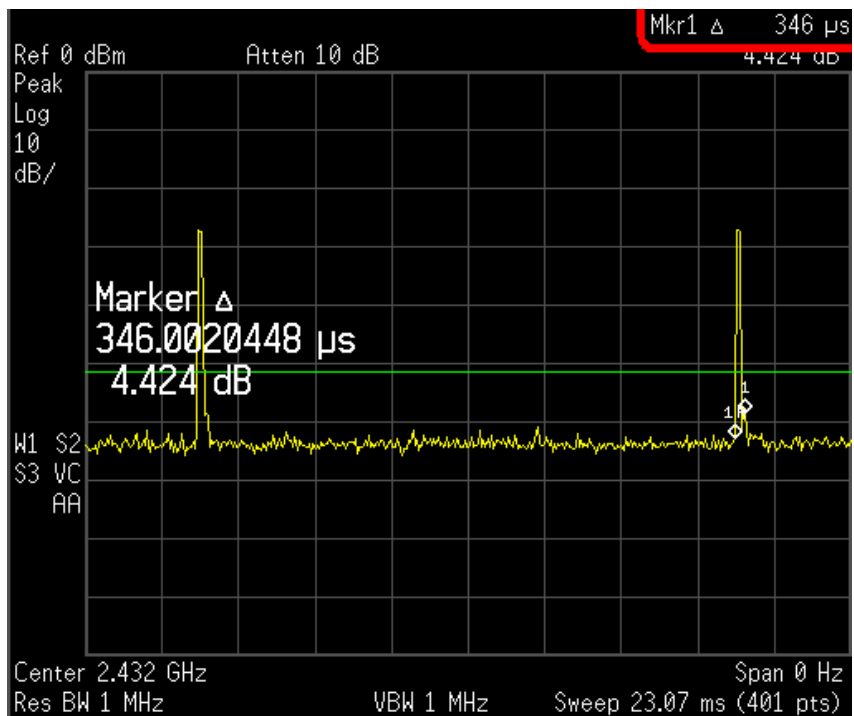
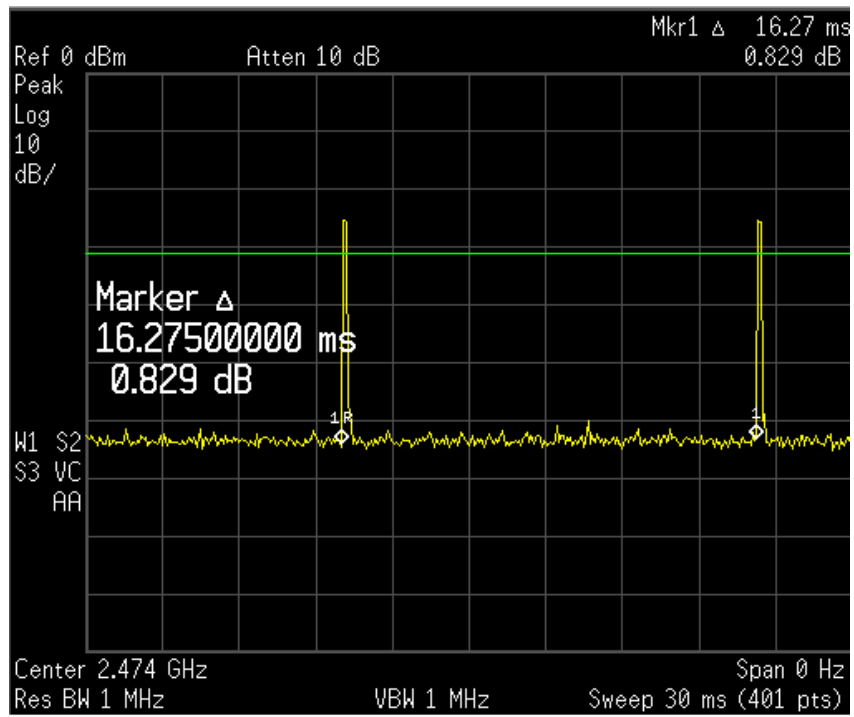

$$20\log(\text{Duty cycle}) = 20\log \frac{0.346\text{ms}}{16.275\text{ms}} = -33.44\text{dB}$$



### **4.3 BAND EDGES MEASUREMENT**

#### **4.3.1 LIMITS OF BAND EDGES MEASUREMENT**

Below –50dB of the highest emission level of operating band (in 100kHz Resolution Bandwidth).

#### **4.3.2 TEST INSTRUMENTS**

Description & Manufacturer	Model No.	Serial No.	Calibrated Until
SPECTRUM ANALYZER	FSP 40	100036	Mar. 13, 2008

**NOTE:** The calibration interval of the above test instruments is 12 months and the calibrations are traceable to NML/ROC and NIST/USA.

#### **4.3.3 TEST PROCEDURE**

The transmitter output was connected to the spectrum analyzer via a low loss cable. Set both RBW and VBW of spectrum analyzer to 100 kHz and 100 kHz with suitable frequency span including 100 MHz bandwidth from band edge. The band edges was measured and recorded.

The spectrum plots are attached on the following pages.

#### **4.3.4 DEVIATION FROM TEST STANDARD**

No deviation

#### **4.3.5 EUT OPERATING CONDITION**

Same as Item 4.2.6

#### **4.3.6 TEST RESULTS**

The spectrum plots are attached on the following 4 images. D1 line indicates the highest level, and D2 line indicates the 50dB offset below D1. It shows compliance with the requirement in part 15.249(d).

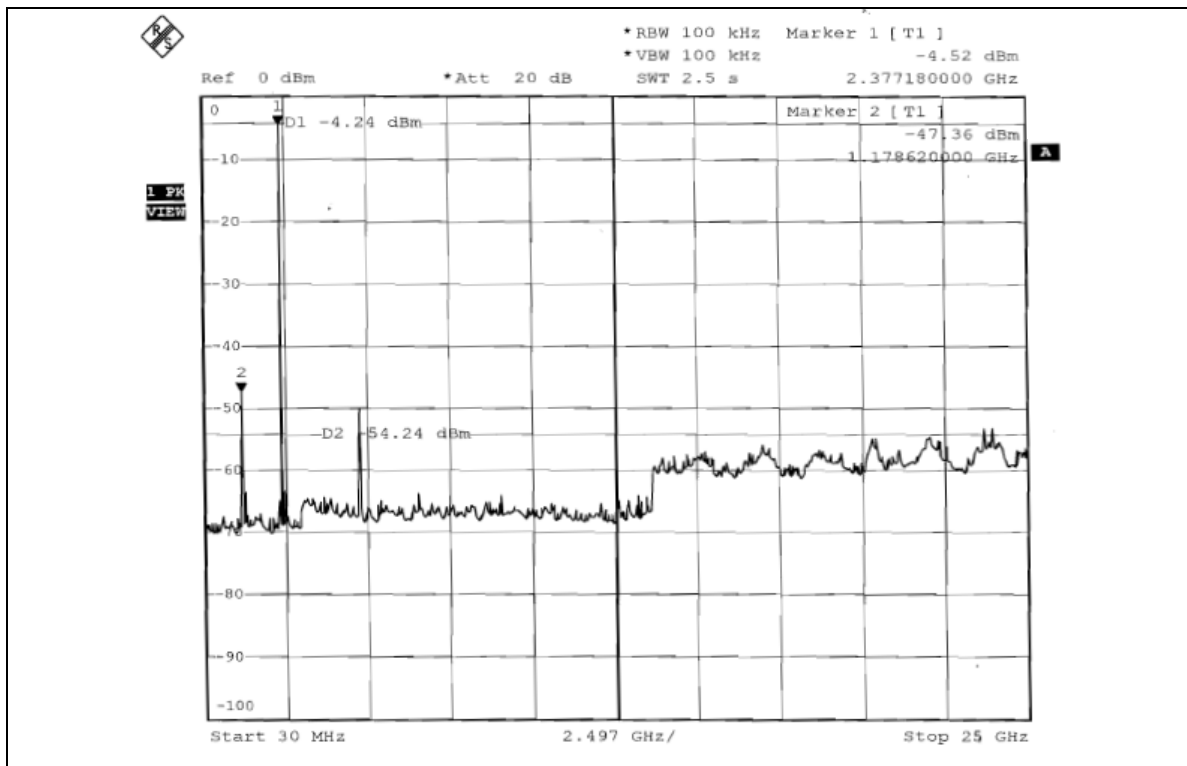
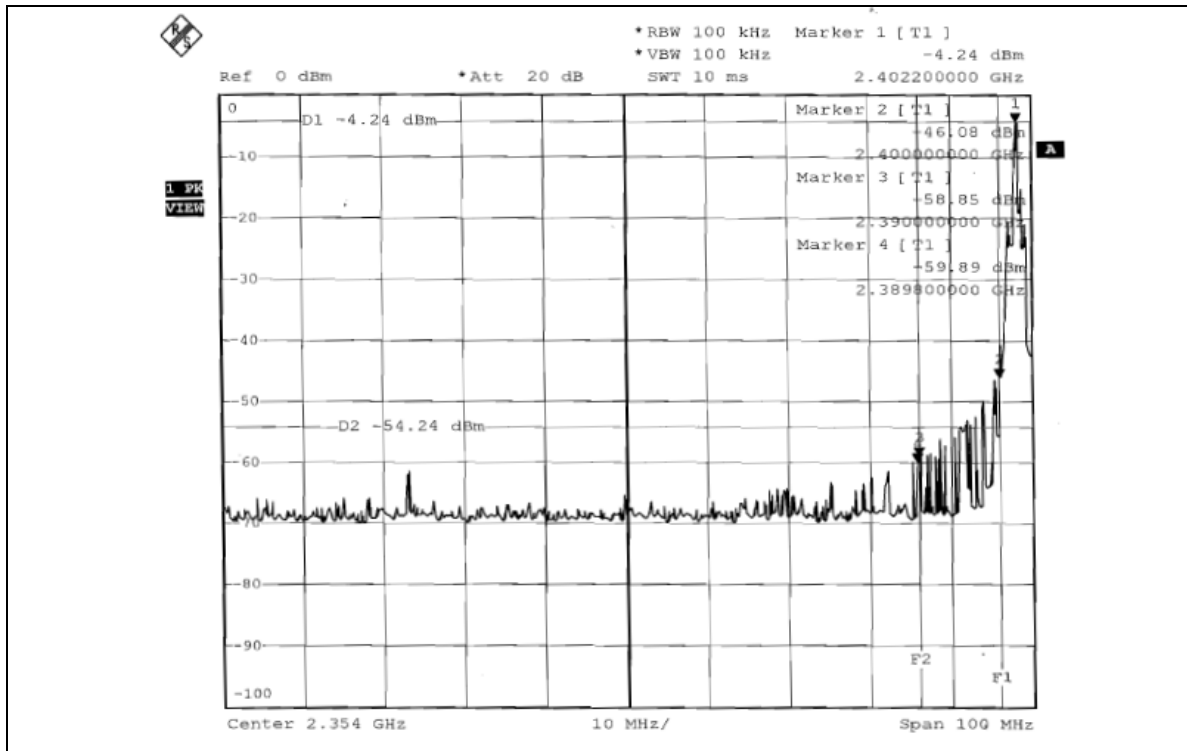

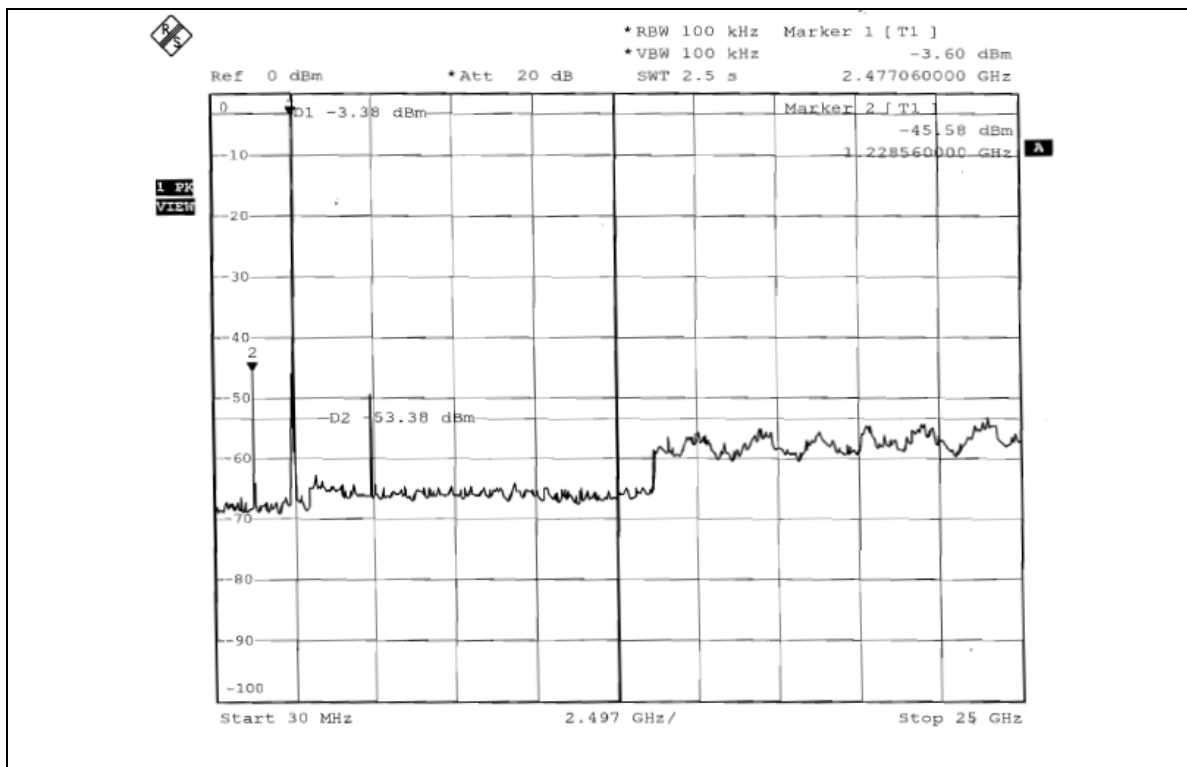
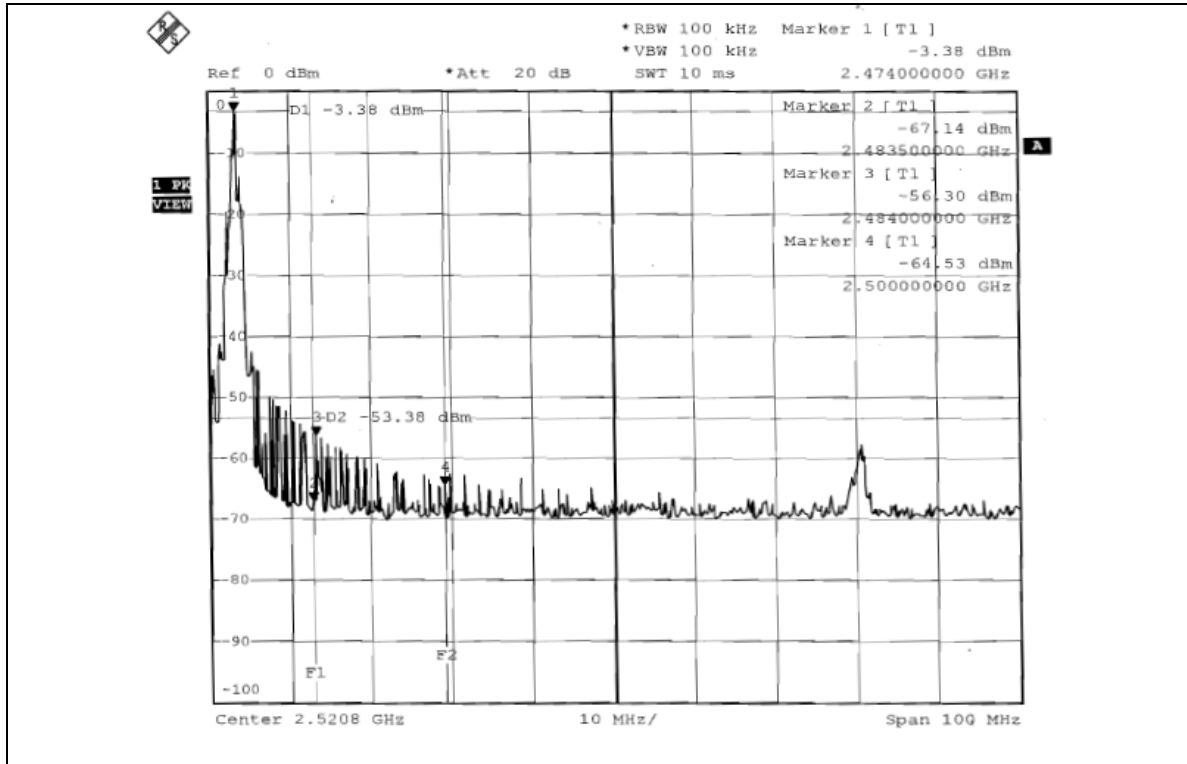



## 5. PHOTOGRAPHS OF THE TEST CONFIGURATION

Please refer to the attached file (Test Setup Photo).



## 6. INFORMATION ON THE TESTING LABORATORIES

We, ADT Corp., were founded in 1988 to provide our best service in EMC, Radio, Telecom and Safety consultation. Our laboratories are accredited and approved by the following approval agencies according to ISO/IEC 17025.

<b>USA</b>	FCC, UL, A2LA
<b>Germany</b>	TUV Rheinland
<b>Japan</b>	VCCI
<b>Norway</b>	NEMKO
<b>Canada</b>	INDUSTRY CANADA, CSA
<b>R.O.C.</b>	TAF, BSMI, NCC
<b>Netherlands</b>	Telefication
<b>Singapore</b>	PSB, GOST-ASIA(MOU)
<b>Russia</b>	CERTIS(MOU)

Copies of accreditation certificates of our laboratories obtained from approval agencies can be downloaded from our web site:

[www.adt.com.tw/index.5/phtml](http://www.adt.com.tw/index.5/phtml). If you have any comments, please feel free to contact us at the following:

**Linko EMC/RF Lab:**

Tel: 886-2-26052180

Fax: 886-2-26051924

**Hsin Chu EMC/RF Lab:**

Tel: 886-3-5935343

Fax: 886-3-5935342

**Hwa Ya EMC/RF/Safety Telecom Lab:**

Tel: 886-3-3183232

Fax: 886-3-3185050

**Web Site:** [www.adt.com.tw](http://www.adt.com.tw)

The address and road map of all our labs can be found in our web site also



## **7.APPENDIX A – MODIFICATIONS RECORDERS FOR ENGINEERING CHANGES TO THE EUT BY THE LAB**

No any modifications are made to the EUT by the lab during the test.