

FCC TEST REPORT

REPORT NO.: RF950601A12

MODEL NO.: PSH-1A

RECEIVED: July 25, 2006

TESTED: July 28 ~ Aug. 11, 2006

ISSUED: Aug. 22, 2006

APPLICANT: PRIMAX ELECTRONICS LTD.

ADDRESS: No. 669, Ruey Kuang Road, Neihu, Taipei, Taiwan,
R.O.C.

ISSUED BY: Advance Data Technology Corporation

LAB LOCATION: No. 47, 14th Ling, Chia Pau Tsuen, Lin Kou Hsiang
244, Taipei Hsien, Taiwan, R.O.C.

This test report consists of 64 pages in total. It may be duplicated completely for legal use with the approval of the applicant. It should not be reproduced except in full, without the written approval of our laboratory. The client should not use it to claim product endorsement by CNLA, A2LA or any government agencies. The test results in the report only apply to the tested sample.



TABLE OF CONTENTS

1.	CERTIFICATION	4
2.	SUMMARY OF TEST RESULTS	5
2.1	MEASUREMENT UNCERTAINTY	6
3.	GENERAL INFORMATION.....	7
3.1	GENERAL DESCRIPTION OF EUT.....	7
3.2	DESCRIPTION OF TEST MODES.....	8
3.2.1	CONFIGURATION OF SYSTEM UNDER TEST	9
3.2.2	TEST MODE APPLICABILITY AND TESTED CHANNEL DETAIL	10
3.3.3	GENERAL DESCRIPTION OF APPLIED STANDARDS	11
3.3.4	DESCRIPTION OF SUPPORT UNITS.....	12
4.	TEST TYPES AND RESULTS.....	13
4.1	CONDUCTED EMISSION MEASUREMENT	13
4.1.1	LIMITS OF CONDUCTED EMISSION MEASUREMENT.....	13
4.1.2	TEST INSTRUMENTS	13
4.1.3	TEST PROCEDURES.....	14
4.1.4	DEVIATION FROM TEST STANDARD	14
4.1.5	TEST SETUP	14
4.1.6	EUT OPERATING CONDITIONS.....	15
4.1.7	TEST RESULTS.....	16
4.2	RADIATED EMISSION MEASUREMENT	28
4.2.1	LIMITS OF RADIATED EMISSION MEASUREMENT.....	28
4.2.2	TEST INSTRUMENTS	29
4.2.3	TEST PROCEDURES.....	30
4.2.4	DEVIATION FROM TEST STANDARD	30
4.2.5	TEST SETUP	31
4.2.6	EUT OPERATING CONDITIONS.....	31
4.2.7	TEST RESULTS.....	32
4.3	NUMBER OF HOPPING FREQUENCY USED	38
4.3.1	LIMIT OF HOPPING FREQUENCY USED	38
4.3.2	TEST INSTRUMENTS	38
4.3.3	TEST PROCEDURES.....	38
4.3.4	DEVIATION FROM TEST STANDARD	39
4.3.5	TEST SETUP	39
4.3.6	TEST RESULTS.....	39
4.4	DWELL TIME ON EACH CHANNEL	41
4.4.1	LIMIT OF DWELL TIME USED.....	41
4.4.2	TEST INSTRUMENTS	41
4.4.3	TEST PROCEDURES.....	41
4.4.4	DEVIATION FROM TEST STANDARD	41
4.4.5	TEST SETUP	42
4.4.6	TEST RESULTS.....	42
4.5	CHANNEL BANDWIDTH	46
4.5.1	LIMITS OF CHANNEL BANDWIDTH.....	46
4.5.2	TEST INSTRUMENTS	46



4.5.3	TEST PROCEDURE	46
4.5.4	DEVIATION FROM TEST STANDARD	47
4.5.5	TEST SETUP	47
4.5.6	EUT OPERATING CONDITION	47
4.5.7	TEST RESULTS	47
4.6	HOPPING CHANNEL SEPARATION	50
4.6.1	LIMIT OF HOPPING CHANNEL SEPARATION	50
4.6.2	TEST INSTRUMENTS	50
4.6.3	TEST PROCEDURES	50
4.6.4	DEVIATION FROM TEST STANDARD	51
4.6.5	TEST SETUP	51
4.6.6	TEST RESULTS	51
4.7	MAXIMUM PEAK OUTPUT POWER	54
4.7.1	LIMITS OF MAXIMUM PEAK OUTPUT POWER MEASUREMENT	54
4.7.2	TEST INSTRUMENTS	54
4.7.3	TEST PROCEDURES	54
4.7.4	DEVIATION FROM TEST STANDARD	54
4.7.5	TEST SETUP	55
4.7.6	EUT OPERATING CONDITION	55
4.7.7	TEST RESULTS	55
4.8	BAND EDGES MEASUREMENT	58
4.8.1	LIMITS OF BAND EDGES MEASUREMENT	58
4.8.2	TEST INSTRUMENTS	58
4.8.3	TEST PROCEDURE	58
4.8.4	DEVIATION FROM TEST STANDARD	58
4.8.5	EUT OPERATING CONDITION	58
4.8.6	TEST RESULTS	59
4.9	ANTENNA REQUIREMENT	62
4.9.1	STANDARD APPLICABLE	62
4.9.2	ANTENNA CONNECTED CONSTRUCTION	62
5.	INFORMATION ON THE TESTING LABORATORIES	63
	APPENDIX-A	A-1



1. CERTIFICATION

PRODUCT: Bluetooth Wireless Stereo Headset
BRAND NAME: PRIMAX
MODEL NO.: PSH-1A
APPLICANT: PRIMAX ELECTRONICS LTD.
TESTED: July 28 ~ Aug. 11, 2006
TEST SAMPLE: ENGINEERING SAMPLE
STANDARDS: FCC Part 15, Subpart C (Section 15.247)
ANSI C63.4-2003

The above equipment has been tested by **Advance Data Technology Corporation**, and found compliance with the requirement of the above standards. The test record, data evaluation & Equipment Under Test (EUT) configurations represented herein are true and accurate accounts of the measurements of the sample's EMC characteristics under the conditions specified in this report.

PREPARED BY : Annie Chang , **DATE:** Aug. 22, 2006
(Annie Chang)

TECHNICAL ACCEPTANCE : Ken Liu , **DATE:** Aug. 22, 2006
Responsible for RF (Ken Liu)

APPROVED BY : Gary Chang , **DATE:** Aug. 22, 2006
(Gary Chang / Supervisor)

2. SUMMARY OF TEST RESULTS

The EUT has been tested according to the following specifications:

APPLIED STANDARD: FCC Part 15, Subpart C			
STANDARD SECTION	TEST TYPE AND LIMIT	RESULT	REMARK
15.207	AC Power Conducted Emission	PASS	Meet the requirement of limit. Minimum passing margin is -10.72dB at 0.526MHz.
15.247(a)(1)(iii)	Number of Hopping Frequency Used Spec.: At least 15 channels	PASS	Meet the requirement of limit.
15.247(a)(1)(iii)	Dwell Time on Each Channel Spec. : Max. 0.4 second within 31.6 second	PASS	Meet the requirement of limit.
15.247(a)(1)	1. Hopping Channel Separation Spec. : Min. 25 kHz or 20 dB bandwidth, whichever is greater (see Note 1) 2. Spectrum Bandwidth of a Frequency Hopping Sequence Spread Spectrum System	PASS	Meet the requirement of limit.
15.247(b)	Maximum Peak Output Power Spec.: max. 30dBm (see Note 1)	PASS	Meet the requirement of limit.
15.247(d)	Transmitter Radiated Emissions Spec.: Table 15.209	PASS	Meet the requirement of limit. Minimum passing margin is -3.54 dB at 81.00MHz.
15.247(d)	Band Edge Measurement	PASS	Meet the requirement of limit.

NOTE: If The Frequency Hopping System operating in 2400-2483.5MHz band and the output power less than 125mW. The hopping channel carrier frequencies separated by a minimum of 25kHz or two-thirds of the 20dB bandwidth of hopping channel whichever is greater.

2.1 MEASUREMENT UNCERTAINTY

Where relevant, the following measurement uncertainty levels have been estimated for tests performed on the EUT as specified in CISPR 16-4:

This uncertainty represents an expanded uncertainty expressed at approximately the 95% confidence level using a coverage factor of $k=2$.

MEASUREMENT	UNCERTAINTY
Conducted emissions	2.44 dB
Radiated emissions	3.55 dB

3. GENERAL INFORMATION

3.1 GENERAL DESCRIPTION OF EUT

PRODUCT	Bluetooth Wireless Stereo Headset
MODEL NO.	PSH-1A
FCC ID	EMJB81301
POWER SUPPLY	3.7Vdc from battery 5.0Vdc from adapter or host equipment
MODULATION TYPE	GFSK
RADIO TECHNOLOGY	FHSS
TRANSFER RATE	723Kbps
FREQUENCY RANGE	2402 MHz ~ 2480 MHz
NUMBER OF CHANNEL	79
OUTPUT POWER	1.866mW
ANTENNA TYPE	Inverted-F antenna with -1.95dBi gain
DATA CABLE	1.5m USB cable
I/O PORTS	USB port
ASSOCIATED DEVICES	N/A

NOTE:

1. The EUT is Headset with Bluetooth technology.
2. The EUT was power supplied from the following power adapter:

Brand	LEI
Model	MU03-5050035-A1
AC I/P Rating	100-240V, 0.15A, 50-60Hz
DC O/P Rating	5V, 350mA

3. For more detailed features description, please refer to the manufacturer's specifications or User's Manual.

3.2 DESCRIPTION OF TEST MODES

79 channels are provided to this EUT:

CHANNEL	FREQ. (MHz)	CHANNEL	FREQ. (MHz)	CHANNEL	FREQ. (MHz)	CHANNEL	FREQ. (MHz)
0	2402	20	2422	40	2442	60	2462
1	2403	21	2423	41	2443	61	2463
2	2404	22	2424	42	2444	62	2464
3	2405	23	2425	43	2445	63	2465
4	2406	24	2426	44	2446	64	2466
5	2407	25	2427	45	2447	65	2467
6	2408	26	2428	46	2448	66	2468
7	2409	27	2429	47	2449	67	2469
8	2410	28	2430	48	2450	68	2470
9	2411	29	2431	49	2451	69	2471
10	2412	30	2431	50	2452	70	2472
11	2413	31	2433	51	2453	71	2473
12	2414	32	2434	52	2454	72	2474
13	2415	33	2435	53	2455	73	2475
14	2416	34	2436	54	2456	74	2476
15	2417	35	2437	55	2457	75	2477
16	2418	36	2438	56	2458	76	2478
17	2419	37	2439	57	2459	77	2479
18	2420	38	2440	58	2460	78	2480
19	2421	39	2441	59	2461		

3.2.1 CONFIGURATION OF SYSTEM UNDER TEST

For Mode A:

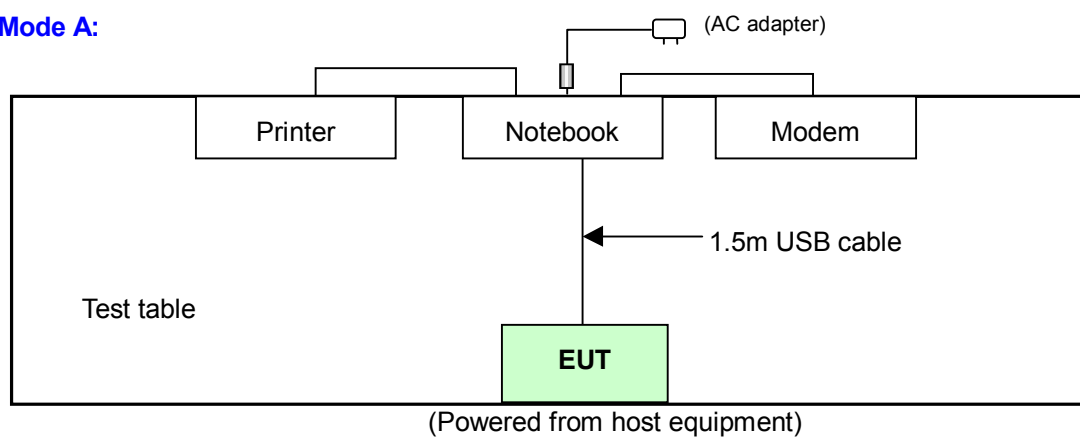

For Mode B:

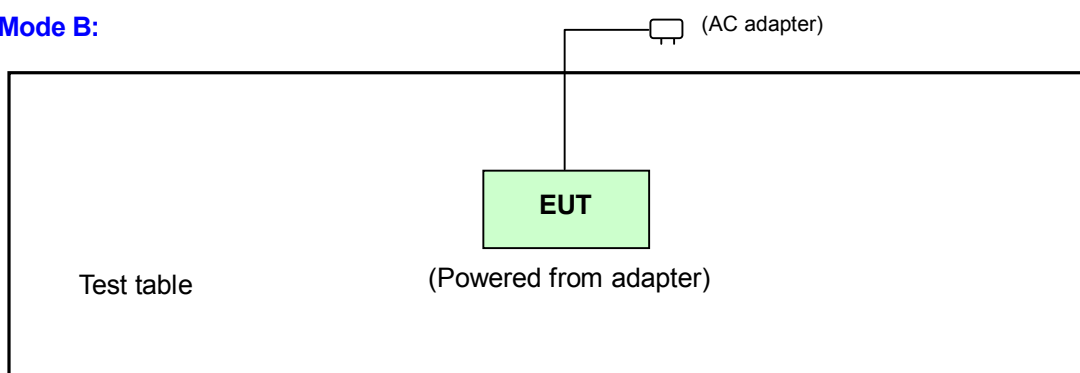

For Mode C:

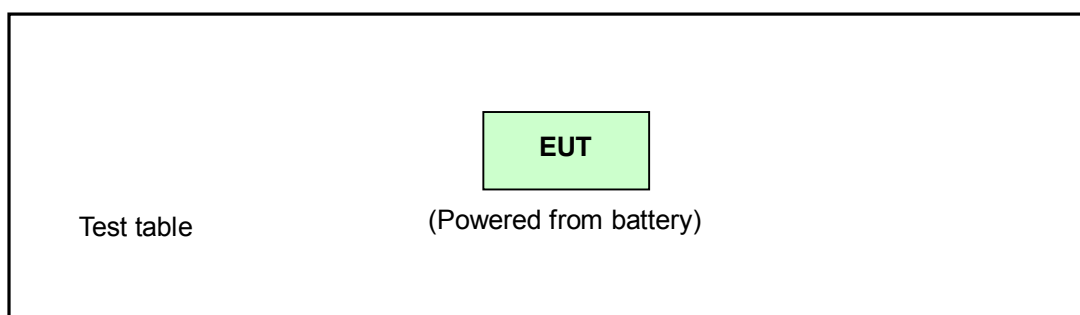

3.2.2 TEST MODE APPLICABILITY AND TESTED CHANNEL DETAIL

EUT CONFIGURE MODE	Applicable to					Description
	PLC	RE<1G	RE≥1G	BM	APCM	
A	√	√	√	√	√	Link to Notebook (powered from host equipment)
B	√	√	-	-	-	EUT with adapter (powered from adapter)
C	-	√	-	-	-	EUT only (powered from battery)

Where **PLC**: Power Line Conducted Emission **RE<1G**: Radiated Emission below 1GHz
RE≥1G: Radiated Emission above 1GHz **BM**: Bandedge Measurement
APCM: Antenna Port Conducted Measurement

POWER LINE CONDUCTED EMISSION TEST:

- Pre-Scan has been conducted to determine the worst-case mode from all possible combinations between available modulations and packet types.
- Following channel(s) was (were) selected for the final test as listed below.

EUT CONFIGURE MODE	AVAILABLE CHANNEL	TESTED CHANNEL	MODULATION TECHNOLOGY	MODULATION TYPE	PACKET TYPE
A	0 to 78	0, 39, 78	FHSS	GFSK	DH5
B	0 to 78	0, 39, 78	FHSS	GFSK	DH5

RADIATED EMISSION TEST (BELOW 1 GHz):

- Pre-Scan has been conducted to determine the worst-case mode from all possible combinations between available modulations, packet types and X, Y, Z Axis.
- Following channel(s) was (were) selected for the final test as listed below.

EUT CONFIGURE MODE	AVAILABLE CHANNEL	TESTED CHANNEL	MODULATION TECHNOLOGY	MODULATION TYPE	PACKET TYPE	AXIS
A	0 to 78	0	FHSS	GFSK	DH5	X
B	0 to 78	0	FHSS	GFSK	DH5	X
C	0 to 78	0	FHSS	GFSK	DH5	X

RADIATED EMISSION TEST (ABOVE 1 GHz):

- Pre-Scan has been conducted to determine the worst-case mode from all possible combinations between available modulations, packet types and X, Y, Z Axis
- Following channel(s) was (were) selected for the final test as listed below.

EUT CONFIGURE MODE	AVAILABLE CHANNEL	TESTED CHANNEL	MODULATION TECHNOLOGY	MODULATION TYPE	PACKET TYPE	AXIS
A	0 to 78	0, 39, 78	FHSS	GFSK	DH5	X



BANDEDGE MEASUREMENT:

- Pre-Scan has been conducted to determine the worst-case mode from all possible combinations between available modulations and packet types.
- Following channel(s) was (were) selected for the final test as listed below.

EUT CONFIGURE MODE	AVAILABLE CHANNEL	TESTED CHANNEL	MODULATION TECHNOLOGY	MODULATION TYPE	PACKET TYPE
A	0 to 78	0, 78	FHSS	GFSK	DH5

ANTENNA PORT CONDUCTED MEASUREMENT:

- Pre-Scan has been conducted to determine the worst-case mode from all possible combinations between available modulations and packet types.
- Following channel(s) was (were) selected for the final test as listed below.

EUT CONFIGURE MODE	AVAILABLE CHANNEL	TESTED CHANNEL	MODULATION TECHNOLOGY	MODULATION TYPE	PACKET TYPE
A	0 to 78	0, 39, 78	FHSS	GFSK	DH5

3.3.3 GENERAL DESCRIPTION OF APPLIED STANDARDS

The EUT is a RF product. According to the specifications of the manufacturer, it must comply with the requirements of the following standards:

FCC Part 15, Subpart C (Section 15.247)
ANSI C63.4-2003

All test items have been performed and recorded as per the above standards.

3.3.4 DESCRIPTION OF SUPPORT UNITS

The EUT has been tested as an independent unit together with other necessary accessories or support units. The following support units or accessories were used to form a representative test configuration during the tests.

NO.	PRODUCT	BRAND	MODEL NO.	SERIAL NO.	FCC ID
1	NOTEBOOK COMPUTER	DELL	PP05L	20375526736	FCC DoC Approved
2	PRINTER	EPSON	LQ-300+	DCGY017054	FCC DoC Approved
3	MODEM	ACEEX	1414	980020520	IFAXDM1414

NO.	SIGNAL CABLE DESCRIPTION OF THE ABOVE SUPPORT UNITS
1	N/A
2	1.8m braid shielded wire, terminated with DB25 and Centronics connector via metallic frame, w/o core
3	1.2 m braid shielded wire, terminated with DB25 and DB9 connector via metallic frame, w/o core.

NOTE: All power cords of the above support units are non-shielded (1.8m).

4. TEST TYPES AND RESULTS

4.1 CONDUCTED EMISSION MEASUREMENT

4.1.1 LIMITS OF CONDUCTED EMISSION MEASUREMENT

FREQUENCY OF EMISSION (MHz)	CONDUCTED LIMIT (dB μ V)	
	Quasi-peak	Average
0.15 ~ 0.5	66 to 56	56 to 46
0.5 ~ 5	56	46
5 ~ 30	60	50

- NOTE:**
1. The lower limit shall apply at the transition frequencies.
 2. The limit decreases in line with the logarithm of the frequency in the range of 0.15 to 0.50 MHz.
 3. All emanations from a class A/B digital device or system, including any network of conductors and apparatus connected thereto, shall not exceed the level of field strengths specified above.

4.1.2 TEST INSTRUMENTS

DESCRIPTION & MANUFACTURER	MODEL NO.	SERIAL NO.	CALIBRATED UNTIL
ROHDE & SCHWARZ Test Receiver	ESCS 30	838251/021	Nov. 23, 2006
ROHDE & SCHWARZ Artificial Mains Network (for EUT)	ESH3-Z5	100218	Nov. 22, 2006
LISN With Adapter (for EUT)	AD10	C10Ada-001	Nov. 22, 2006
ROHDE & SCHWARZ Artificial Mains Network (for peripherals)	ESH3-Z5	100219	Nov. 22, 2006
ROHDE & SCHWARZ Artificial Mains Network (for peripherals)	ESH3-Z5	100220	Nov. 22, 2006
Software	ADT_Cond_V7.3.2	NA	NA
Software	ADT_ISN_V7.3.2	NA	NA
RF cable (JYEBAO)	5D-FB	Cable-C10.01	Mar. 30, 2007
SUHNTER Terminator (For ROHDE & SCHWARZ LISN)	65BNC-5001	E1-010773	Feb. 23, 2007

- NOTE:**
1. The calibration interval of the above test instruments is 12 months and the calibrations are traceable to NML/ROC and NIST/USA.
 2. The test was performed in ADT Shielded Room No. 10.
 3. The VCCI Site Registration No. C-1852.

4.1.3 TEST PROCEDURES

- a. The EUT was placed 0.4 meters from the conducting wall of the shielded room with EUT being connected to the power mains through a line impedance stabilization network (LISN). Other support units were connected to the power mains through another LISN. The two LISNs provide 50 ohm/ 50uH of coupling impedance for the measuring instrument.
- b. Both lines of the power mains connected to the EUT were checked for maximum conducted interference.
- c. The frequency range from 150kHz to 30MHz was searched. Emission levels under (Limit - 20dB) was not recorded.

4.1.4 DEVIATION FROM TEST STANDARD

No deviation

4.1.5 TEST SETUP

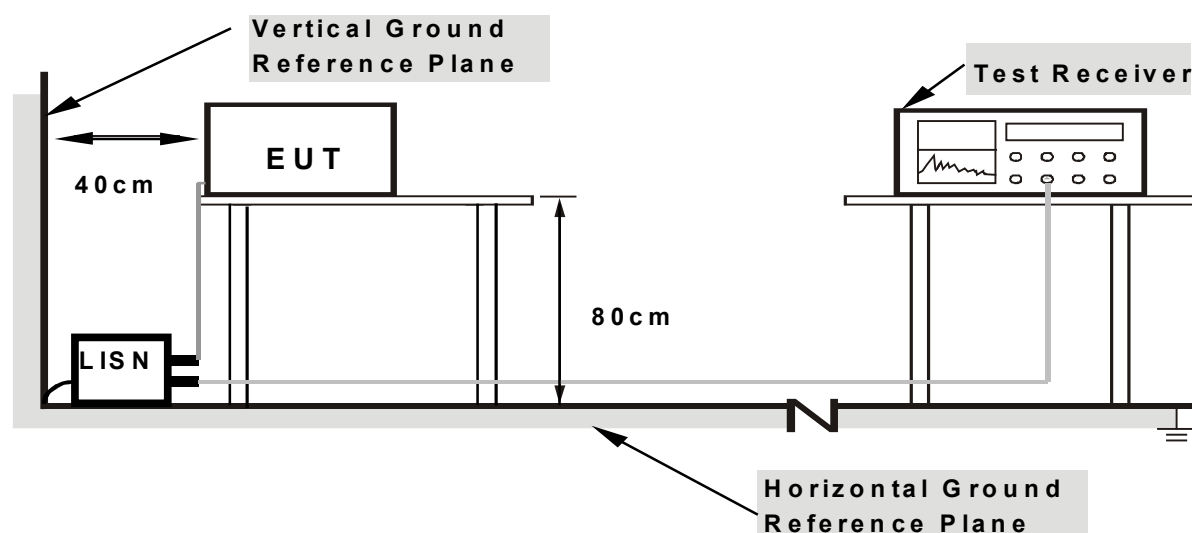

- Note:**
1. Support units were connected to second LISN.
 2. Both of LISNs (AMN) are 80 cm from EUT and at least 80 cm from other units and other metal planes support units.

For the actual test configuration, please refer to the related item – Photographs of the Test Configuration.

4.1.6 EUT OPERATING CONDITIONS

For Mode A:

- a. Connected the EUT to a notebook system via a USB cable and placed on a testing table.
- b. The notebook system ran a test program (provided by manufacturer) to enable EUT under transmission/receiving condition continuously at specific channel frequency.
- c. The notebook system sent "H" messages to its screen.
- d. The notebook system sent "H" messages to printer and the printer prints them out
- e. The notebook system sent "H" messages to modem.
- f. Repeated c ~ e.

For Mode B:

Set the EUT under transmission/receiving condition continuously at specific channel frequency.

4.1.7 TEST RESULTS

CONDUCTED WORST CASE DATA: FOR MODE A

TEST MODE	A		
MODULATION TYPE	GFSK	CHANNEL	0
INPUT POWER (SYSTEM)	120Vac, 60 Hz	6dB BANDWIDTH	9 kHz
ENVIRONMENTAL CONDITIONS	28deg. C, 60%RH, 996hPa	PHASE	Line 1
TESTED BY	Jamison Chan		

No	Freq. [MHz]	Corr. Factor (dB)	Reading Value [dB (uV)]		Emission Level [dB (uV)]		Limit [dB (uV)]		Margin (dB)	
			Q.P.	AV.	Q.P.	AV.	Q.P.	AV.	Q.P.	AV.
			1	0.173	0.20	48.16	-	48.36	-	64.79
2	0.240	0.20	36.63	-	36.83	-	62.10	52.10	-25.27	-
3	1.621	0.26	25.49	-	25.75	-	56.00	46.00	-30.25	-
4	3.695	0.47	17.08	-	17.55	-	56.00	46.00	-38.45	-
5	10.227	0.81	29.63	-	30.44	-	60.00	50.00	-29.56	-
6	16.680	1.10	24.24	-	25.34	-	60.00	50.00	-34.66	-

- REMARKS:**
1. Q.P. and AV. are abbreviations of quasi-peak and average individually.
 2. "-": The Quasi-peak reading value also meets average limit and measurement with the average detector is unnecessary.
 3. The emission levels of other frequencies were very low against the limit.
 4. Margin value = Emission level - Limit value
 5. Correction factor = Insertion loss + Cable loss
 6. Emission Level = Correction Factor + Reading Value.

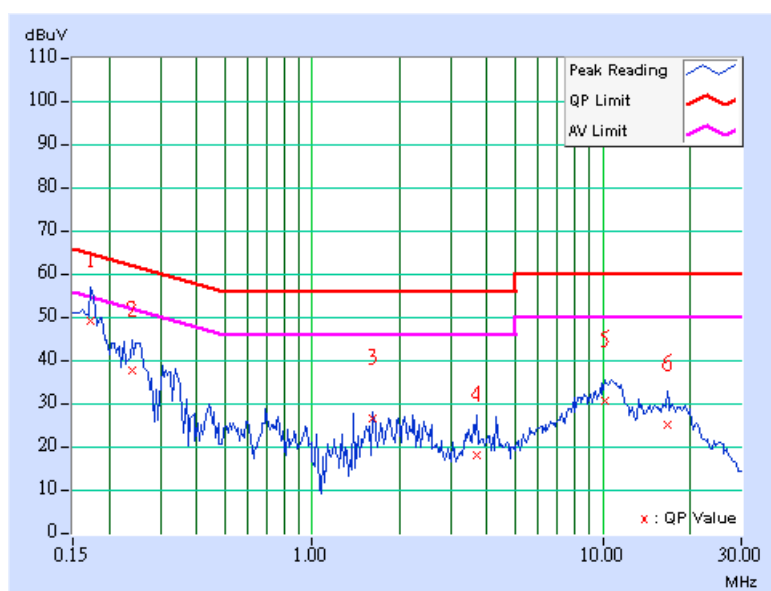

TEST MODE	A		
MODULATION TYPE	GFSK	CHANNEL	0
INPUT POWER (SYSTEM)	120Vac, 60 Hz	6dB BANDWIDTH	9 kHz
ENVIRONMENTAL CONDITIONS	28deg. C, 60%RH, 996hPa	PHASE	Line 2
TESTED BY	Jamison Chan		

No	Freq. [MHz]	Corr. Factor (dB)	Reading Value		Emission Level		Limit		Margin	
			[dB (uV)]		[dB (uV)]		[dB (uV)]		(dB)	
			Q.P.	AV.	Q.P.	AV.	Q.P.	AV.	Q.P.	AV.
1	0.170	0.20	48.00	-	48.20	-	64.98	54.98	-16.78	-
2	0.193	0.20	46.28	-	46.48	-	63.91	53.91	-17.43	-
3	1.547	0.10	27.33	-	27.43	-	56.00	46.00	-28.57	-
4	2.059	0.11	24.76	-	24.87	-	56.00	46.00	-31.13	-
5	9.473	0.48	26.40	-	26.88	-	60.00	50.00	-33.12	-
6	10.902	0.55	30.80	-	31.35	-	60.00	50.00	-28.65	-

- REMARKS:**
1. Q.P. and AV. are abbreviations of quasi-peak and average individually.
 2. "-": The Quasi-peak reading value also meets average limit and measurement with the average detector is unnecessary.
 3. The emission levels of other frequencies were very low against the limit.
 4. Margin value = Emission level - Limit value
 5. Correction factor = Insertion loss + Cable loss
 6. Emission Level = Correction Factor + Reading Value.

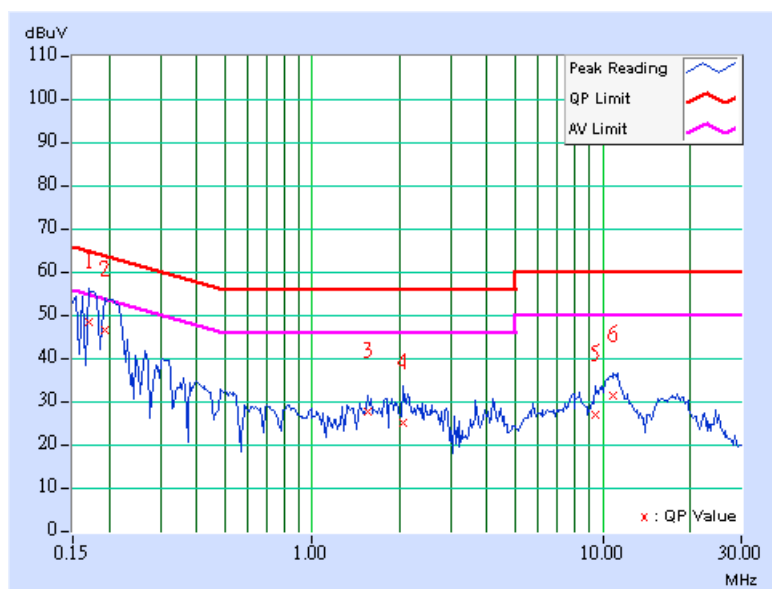

TEST MODE	A		
MODULATION TYPE	GFSK	CHANNEL	39
INPUT POWER (SYSTEM)	120Vac, 60 Hz	6dB BANDWIDTH	9 kHz
ENVIRONMENTAL CONDITIONS	28deg. C, 60%RH, 996hPa	PHASE	Line 1
TESTED BY	Jamison Chan		

No	Freq. [MHz]	Corr. Factor (dB)	Reading Value		Emission Level		Limit		Margin	
			[dB (uV)]		[dB (uV)]		[dB (uV)]		(dB)	
			Q.P.	AV.	Q.P.	AV.	Q.P.	AV.	Q.P.	AV.
1	0.173	0.20	51.35	-	51.55	-	64.80	54.80	-13.25	-
2	0.244	0.20	36.78	-	36.98	-	61.96	51.96	-24.98	-
3	1.628	0.26	23.82	-	24.08	-	56.00	46.00	-31.92	-
4	3.703	0.47	17.91	-	18.38	-	56.00	46.00	-37.62	-
5	10.232	0.81	29.22	-	30.03	-	60.00	50.00	-29.97	-
6	16.674	1.10	24.65	-	25.75	-	60.00	50.00	-34.25	-

- REMARKS:**
1. Q.P. and AV. are abbreviations of quasi-peak and average individually.
 2. "-": The Quasi-peak reading value also meets average limit and measurement with the average detector is unnecessary.
 3. The emission levels of other frequencies were very low against the limit.
 4. Margin value = Emission level - Limit value
 5. Correction factor = Insertion loss + Cable loss
 6. Emission Level = Correction Factor + Reading Value.

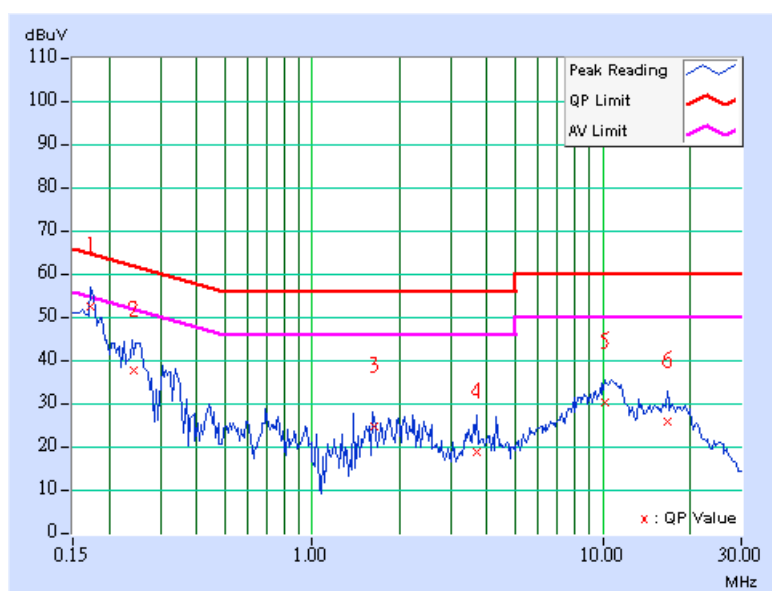

TEST MODE	A		
MODULATION TYPE	GFSK	CHANNEL	39
INPUT POWER (SYSTEM)	120Vac, 60 Hz	6dB BANDWIDTH	9 kHz
ENVIRONMENTAL CONDITIONS	28deg. C, 60%RH, 996hPa	PHASE	Line 2
TESTED BY	Jamison Chan		

No	Freq. [MHz]	Corr. Factor (dB)	Reading Value		Emission Level		Limit		Margin	
			[dB (uV)]		[dB (uV)]		[dB (uV)]		(dB)	
			Q.P.	AV.	Q.P.	AV.	Q.P.	AV.	Q.P.	AV.
1	0.162	0.20	47.45	-	47.65	-	65.38	55.38	-17.73	-
2	0.197	0.20	38.56	-	38.76	-	63.74	53.74	-24.98	-
3	1.402	0.10	19.56	-	19.66	-	56.00	46.00	-36.34	-
4	1.559	0.10	21.22	-	21.32	-	56.00	46.00	-34.68	-
5	10.504	0.53	30.43	-	30.96	-	60.00	50.00	-29.04	-
6	16.063	0.84	24.73	-	25.57	-	60.00	50.00	-34.43	-

- REMARKS:**
1. Q.P. and AV. are abbreviations of quasi-peak and average individually.
 2. "-": The Quasi-peak reading value also meets average limit and measurement with the average detector is unnecessary.
 3. The emission levels of other frequencies were very low against the limit.
 4. Margin value = Emission level - Limit value
 5. Correction factor = Insertion loss + Cable loss
 6. Emission Level = Correction Factor + Reading Value.

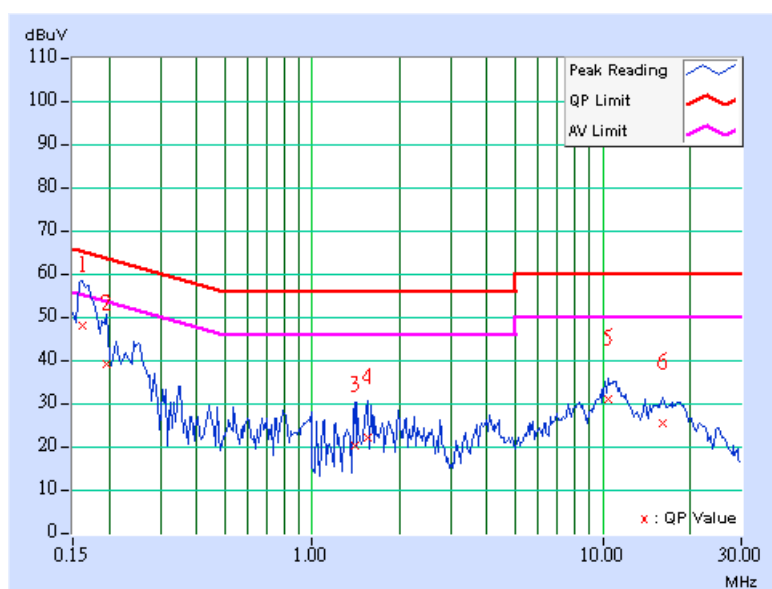

TEST MODE	A		
MODULATION TYPE	GFSK	CHANNEL	78
INPUT POWER (SYSTEM)	120Vac, 60 Hz	6dB BANDWIDTH	9 kHz
ENVIRONMENTAL CONDITIONS	28deg. C, 60%RH, 996hPa	PHASE	Line 1
TESTED BY	Jamison Chan		

No	Freq. [MHz]	Corr. Factor (dB)	Reading Value		Emission Level		Limit		Margin	
			[dB (uV)]		[dB (uV)]		[dB (uV)]		(dB)	
			Q.P.	AV.	Q.P.	AV.	Q.P.	AV.	Q.P.	AV.
1	0.173	0.20	46.81	-	47.01	-	64.79	54.79	-17.78	-
2	0.224	0.20	35.13	-	35.33	-	62.66	52.66	-27.33	-
3	1.758	0.28	21.38	-	21.66	-	56.00	46.00	-34.34	-
4	2.027	0.30	19.78	-	20.08	-	56.00	46.00	-35.92	-
5	8.379	0.72	26.43	-	27.15	-	60.00	50.00	-32.85	-
6	10.523	0.82	30.71	-	31.53	-	60.00	50.00	-28.47	-

- REMARKS:**
1. Q.P. and AV. are abbreviations of quasi-peak and average individually.
 2. "-": The Quasi-peak reading value also meets average limit and measurement with the average detector is unnecessary.
 3. The emission levels of other frequencies were very low against the limit.
 4. Margin value = Emission level - Limit value
 5. Correction factor = Insertion loss + Cable loss
 6. Emission Level = Correction Factor + Reading Value.

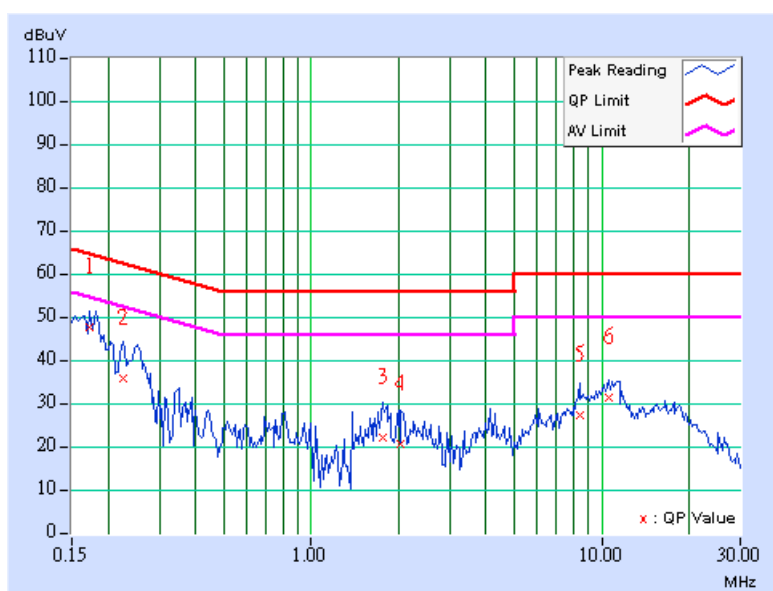

TEST MODE	A		
MODULATION TYPE	GFSK	CHANNEL	78
INPUT POWER (SYSTEM)	120Vac, 60 Hz	6dB BANDWIDTH	9 kHz
ENVIRONMENTAL CONDITIONS	28deg. C, 60%RH, 996hPa	PHASE	Line 2
TESTED BY	Jamison Chan		

No	Freq. [MHz]	Corr. Factor (dB)	Reading Value		Emission Level		Limit		Margin	
			[dB (uV)]		[dB (uV)]		[dB (uV)]		(dB)	
			Q.P.	AV.	Q.P.	AV.	Q.P.	AV.	Q.P.	AV.
1	0.168	0.20	50.63	-	50.83	-	65.05	55.05	-14.22	-
2	0.194	0.20	41.17	-	41.37	-	63.87	53.87	-22.50	-
3	1.398	0.10	24.31	-	24.41	-	56.00	46.00	-31.59	-
4	1.552	0.10	21.59	-	21.69	-	56.00	46.00	-34.31	-
5	10.505	0.53	30.55	-	31.08	-	60.00	50.00	-28.92	-
6	16.058	0.84	24.81	-	25.65	-	60.00	50.00	-34.35	-

- REMARKS:**
1. Q.P. and AV. are abbreviations of quasi-peak and average individually.
 2. "-": The Quasi-peak reading value also meets average limit and measurement with the average detector is unnecessary.
 3. The emission levels of other frequencies were very low against the limit.
 4. Margin value = Emission level - Limit value
 5. Correction factor = Insertion loss + Cable loss
 6. Emission Level = Correction Factor + Reading Value.

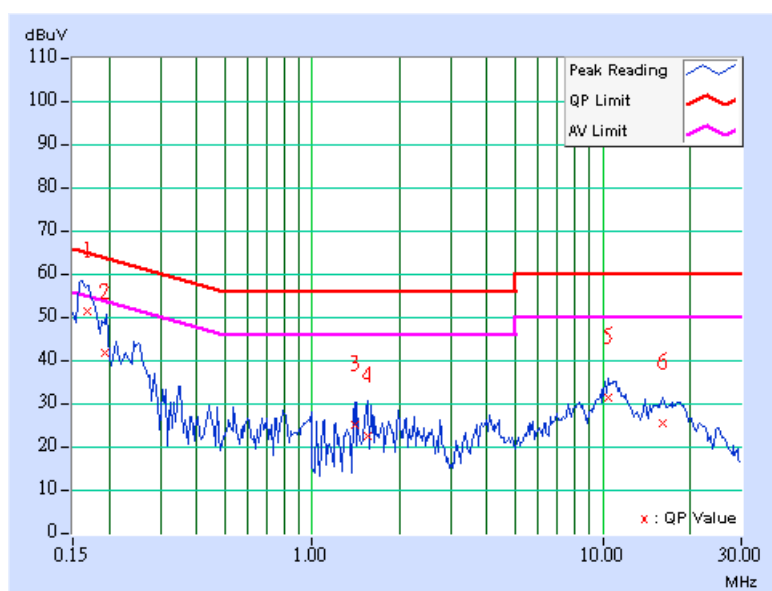

CONDUCTED WORST CASE DATA: FOR MODE B

TEST MODE	B		
MODULATION TYPE	GFSK	CHANNEL	0
INPUT POWER	120Vac, 60 Hz	6dB BANDWIDTH	9 kHz
ENVIRONMENTAL CONDITIONS	28deg. C, 60%RH, 996hPa	PHASE	Line 1
TESTED BY	Jamison Chan		

No	Freq. [MHz]	Corr. Factor (dB)	Reading Value [dB (uV)]		Emission Level [dB (uV)]		Limit [dB (uV)]		Margin (dB)	
			Q.P.	AV.	Q.P.	AV.	Q.P.	AV.	Q.P.	AV.
			1	0.271	0.20	39.10	-	39.30	-	61.08
2	0.404	0.20	39.84	-	40.04	-	57.77	47.77	-17.73	-
3	0.552	0.20	44.14	-	44.34	-	56.00	46.00	-11.66	-
4	0.693	0.20	39.85	-	40.05	-	56.00	46.00	-15.95	-
5	26.090	1.40	22.35	-	23.75	-	60.00	50.00	-36.25	-
6	28.695	1.40	22.66	-	24.06	-	60.00	50.00	-35.94	-

- REMARKS:**
1. Q.P. and AV. are abbreviations of quasi-peak and average individually.
 2. "-": The Quasi-peak reading value also meets average limit and measurement with the average detector is unnecessary.
 3. The emission levels of other frequencies were very low against the limit.
 4. Margin value = Emission level - Limit value
 5. Correction factor = Insertion loss + Cable loss
 6. Emission Level = Correction Factor + Reading Value.

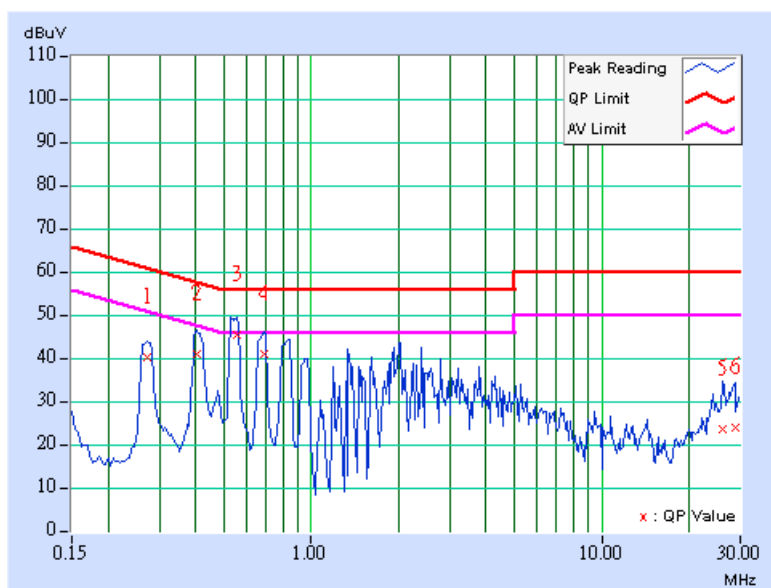

TEST MODE	B		
MODULATION TYPE	GFSK	CHANNEL	0
INPUT POWER	120Vac, 60 Hz	6dB BANDWIDTH	9 kHz
ENVIRONMENTAL CONDITIONS	28deg. C, 60%RH, 996hPa	PHASE	Line 2
TESTED BY	Jamison Chan		

No	Freq. [MHz]	Corr. Factor (dB)	Reading Value		Emission Level		Limit		Margin	
			[dB (uV)]		[dB (uV)]		[dB (uV)]		(dB)	
			Q.P.	AV.	Q.P.	AV.	Q.P.	AV.	Q.P.	AV.
1	0.263	0.20	34.08	-	34.28	-	61.33	51.33	-27.05	-
2	0.396	0.20	33.59	-	33.79	-	57.93	47.93	-24.14	-
3	0.529	0.18	39.69	-	39.87	-	56.00	46.00	-16.13	-
4	0.685	0.15	35.35	-	35.50	-	56.00	46.00	-20.50	-
5	23.945	1.16	16.33	-	17.49	-	60.00	50.00	-42.51	-
6	27.008	1.16	19.33	-	20.49	-	60.00	50.00	-39.51	-

- REMARKS:**
1. Q.P. and AV. are abbreviations of quasi-peak and average individually.
 2. "-": The Quasi-peak reading value also meets average limit and measurement with the average detector is unnecessary.
 3. The emission levels of other frequencies were very low against the limit.
 4. Margin value = Emission level - Limit value
 5. Correction factor = Insertion loss + Cable loss
 6. Emission Level = Correction Factor + Reading Value.

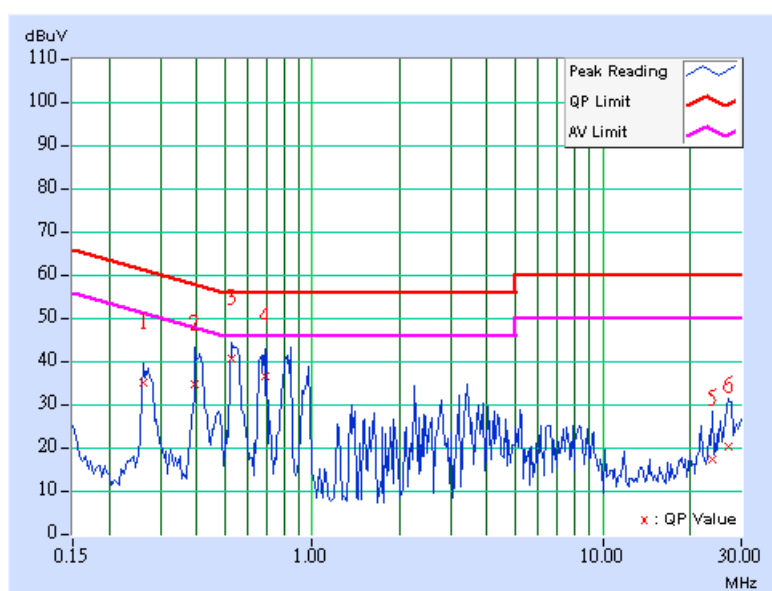

TEST MODE	B		
MODULATION TYPE	GFSK	CHANNEL	39
INPUT POWER	120Vac, 60 Hz	6dB BANDWIDTH	9 kHz
ENVIRONMENTAL CONDITIONS	28deg. C, 60%RH, 996hPa	PHASE	Line 1
TESTED BY	Jamison Chan		

No	Freq. [MHz]	Corr. Factor (dB)	Reading Value [dB (uV)]		Emission Level [dB (uV)]		Limit [dB (uV)]		Margin (dB)	
			Q.P.	AV.	Q.P.	AV.	Q.P.	AV.	Q.P.	AV.
			1	0.275	0.20	38.61	-	38.81	-	60.97
2	0.420	0.20	37.39	-	37.59	-	57.46	47.46	-19.87	-
3	0.548	0.20	44.56	-	44.76	-	56.00	46.00	-11.24	-
4	0.681	0.20	39.68	-	39.88	-	56.00	46.00	-16.12	-
5	25.496	1.40	19.34	-	20.74	-	60.00	50.00	-39.26	-
6	26.637	1.40	17.76	-	19.16	-	60.00	50.00	-40.84	-

- REMARKS:**
1. Q.P. and AV. are abbreviations of quasi-peak and average individually.
 2. "-": The Quasi-peak reading value also meets average limit and measurement with the average detector is unnecessary.
 3. The emission levels of other frequencies were very low against the limit.
 4. Margin value = Emission level - Limit value
 5. Correction factor = Insertion loss + Cable loss
 6. Emission Level = Correction Factor + Reading Value.

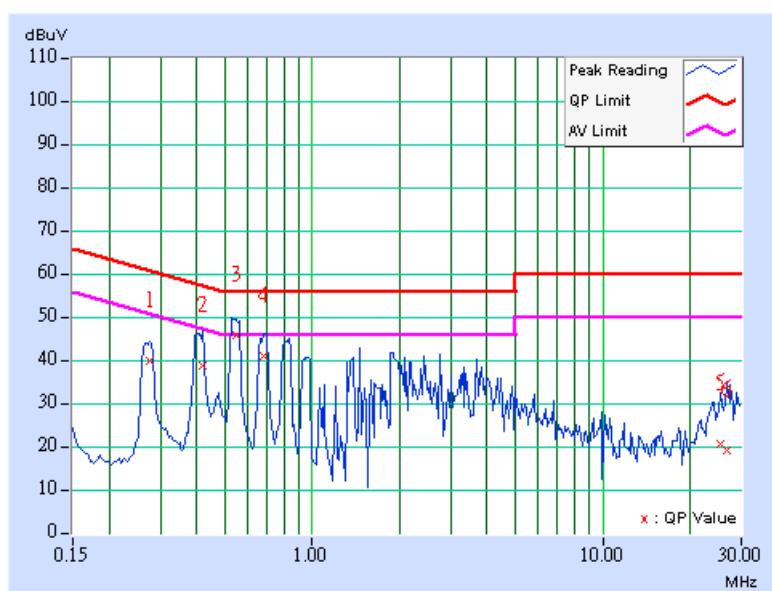

TEST MODE	B		
MODULATION TYPE	GFSK	CHANNEL	39
INPUT POWER	120Vac, 60 Hz	6dB BANDWIDTH	9 kHz
ENVIRONMENTAL CONDITIONS	28deg. C, 60%RH, 996hPa	PHASE	Line 2
TESTED BY	Jamison Chan		

No	Freq. [MHz]	Corr. Factor (dB)	Reading Value [dB (uV)]		Emission Level [dB (uV)]		Limit [dB (uV)]		Margin (dB)	
			Q.P.	AV.	Q.P.	AV.	Q.P.	AV.	Q.P.	AV.
	1	0.268	0.20	34.23	-	34.43	-	61.17	51.17	-26.74
2	0.400	0.20	34.63	-	34.83	-	57.85	47.85	-23.02	-
3	0.535	0.18	39.59	-	39.77	-	56.00	46.00	-16.23	-
4	0.836	0.13	32.28	-	32.41	-	56.00	46.00	-23.59	-
5	23.949	1.16	16.12	-	17.28	-	60.00	50.00	-42.72	-
6	27.013	1.16	19.64	-	20.80	-	60.00	50.00	-39.20	-

- REMARKS:**
1. Q.P. and AV. are abbreviations of quasi-peak and average individually.
 2. "-": The Quasi-peak reading value also meets average limit and measurement with the average detector is unnecessary.
 3. The emission levels of other frequencies were very low against the limit.
 4. Margin value = Emission level - Limit value
 5. Correction factor = Insertion loss + Cable loss
 6. Emission Level = Correction Factor + Reading Value.

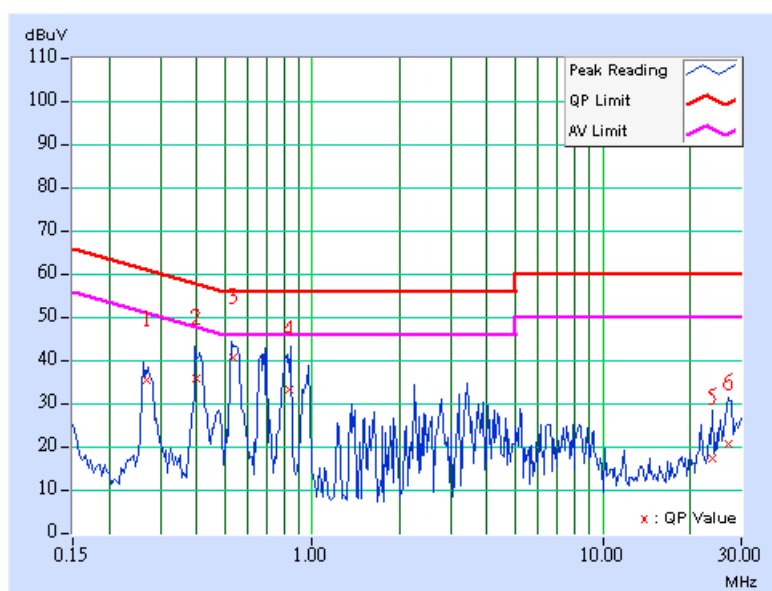

TEST MODE	B		
MODULATION TYPE	GFSK	CHANNEL	78
INPUT POWER	120Vac, 60 Hz	6dB BANDWIDTH	9 kHz
ENVIRONMENTAL CONDITIONS	28deg. C, 60%RH, 996hPa	PHASE	Line 1
TESTED BY	Jamison Chan		

No	Freq. [MHz]	Corr. Factor (dB)	Reading Value [dB (uV)]		Emission Level [dB (uV)]		Limit [dB (uV)]		Margin (dB)	
			Q.P.	AV.	Q.P.	AV.	Q.P.	AV.	Q.P.	AV.
	1	0.274	0.20	38.27	-	38.47	-	60.98	50.98	-22.51
2	0.418	0.20	38.69	-	38.89	-	57.49	47.49	-18.60	-
3	0.526	0.20	45.08	-	45.28	-	56.00	46.00	-10.72	-
4	0.681	0.20	39.88	-	40.08	-	56.00	46.00	-15.92	-
5	25.495	1.40	17.80	-	19.20	-	60.00	50.00	-40.80	-
6	26.641	1.40	18.15	-	19.55	-	60.00	50.00	-40.45	-

- REMARKS:**
1. Q.P. and AV. are abbreviations of quasi-peak and average individually.
 2. "-": The Quasi-peak reading value also meets average limit and measurement with the average detector is unnecessary.
 3. The emission levels of other frequencies were very low against the limit.
 4. Margin value = Emission level - Limit value
 5. Correction factor = Insertion loss + Cable loss
 6. Emission Level = Correction Factor + Reading Value.

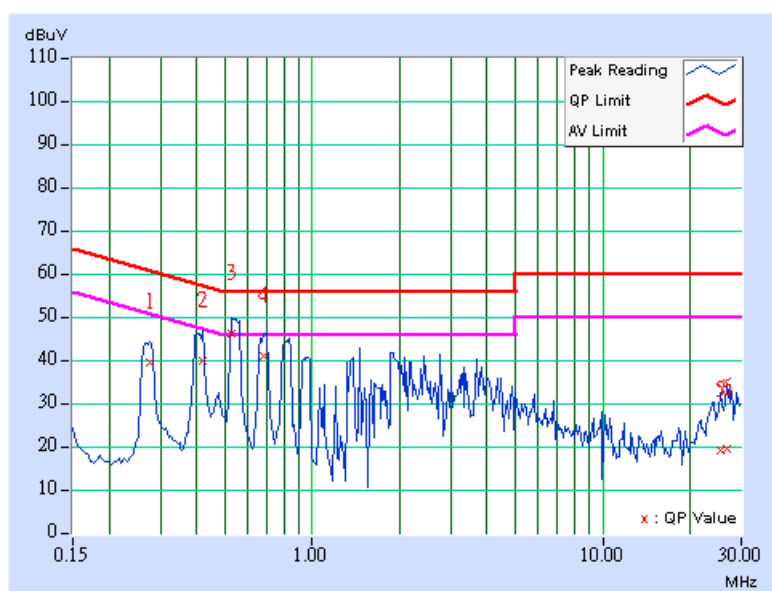

TEST MODE	B		
MODULATION TYPE	GFSK	CHANNEL	78
INPUT POWER	120Vac, 60 Hz	6dB BANDWIDTH	9 kHz
ENVIRONMENTAL CONDITIONS	28deg. C, 60%RH, 996hPa	PHASE	Line 2
TESTED BY	Jamison Chan		

No	Freq. [MHz]	Corr. Factor (dB)	Reading Value [dB (uV)]		Emission Level [dB (uV)]		Limit [dB (uV)]		Margin (dB)	
			Q.P.	AV.	Q.P.	AV.	Q.P.	AV.	Q.P.	AV.
	1	0.271	0.20	34.84	-	35.04	-	61.08	51.08	-26.04
2	0.416	0.20	34.22	-	34.42	-	57.54	47.54	-23.12	-
3	0.552	0.17	40.07	-	40.24	-	56.00	46.00	-15.76	-
4	0.677	0.15	34.97	-	35.12	-	56.00	46.00	-20.88	-
5	6.633	0.39	16.50	-	16.89	-	60.00	50.00	-43.11	-
6	29.543	1.11	18.07	-	19.18	-	60.00	50.00	-40.82	-

- REMARKS:**
1. Q.P. and AV. are abbreviations of quasi-peak and average individually.
 2. "-": The Quasi-peak reading value also meets average limit and measurement with the average detector is unnecessary.
 3. The emission levels of other frequencies were very low against the limit.
 4. Margin value = Emission level - Limit value
 5. Correction factor = Insertion loss + Cable loss
 6. Emission Level = Correction Factor + Reading Value.

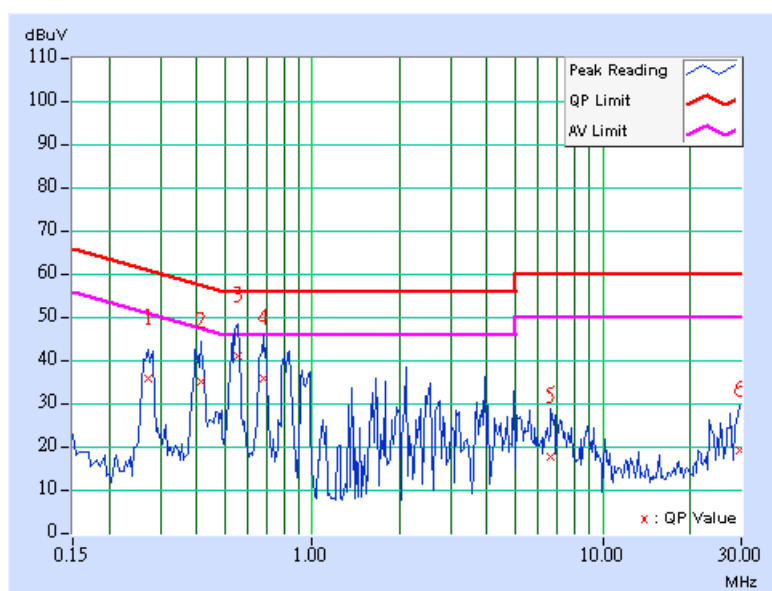

4.2 RADIATED EMISSION MEASUREMENT

4.2.1 LIMITS OF RADIATED EMISSION MEASUREMENT

Emissions radiated outside of the specified bands, shall be according to the general radiated limits in 15.209 as following:

FREQUENCIES (MHz)	FIELD STRENGTH (microvolts/meter)	MEASUREMENT DISTANCE (meters)
0.009 ~ 0.490	2400/F(kHz)	300
0.490 ~ 1.705	24000/F(kHz)	30
1.705 ~ 30.0	30	30
30 ~ 88	100	3
88 ~ 216	150	3
216 ~ 960	200	3
Above 960	500	3

NOTE:

1. The lower limit shall apply at the transition frequencies.
2. Emission level (dBuV/m) = 20 log Emission level (uV/m).
3. As shown in 15.35(b), for frequencies above 1000MHz, the field strength limits are based on average detector, however, the peak field strength of any emission shall not exceed the maximum permitted average limits, specified above by more than 20dB under any condition of modulation.

4.2.2 TEST INSTRUMENTS

DESCRIPTION & MANUFACTURER	MODEL NO.	SERIAL NO.	CALIBRATED UNTIL
HP Preamplifier	8447D	2432A03504	May 21, 2007
HP Preamplifier	8449B	3008A01924	Sep. 06, 2006
HP Preamplifier	8449B	3008A01638	Sep. 21, 2006
ROHDE & SCHWARZ TEST RECEIVER	ESI7	836697/012	Nov. 01, 2006
Schwarzbeck Antenna	VULB 9168	137	Feb. 21, 2007
Schwarzbeck Antenna	VHBA 9123	480	Mar. 30, 2007
EMCO Horn Antenna	3115	6714	Oct. 26, 2006
EMCO Horn Antenna	3115	9312-4192	Mar. 14, 2007
ADT. Turn Table	TT100	0306	NA
ADT. Tower	AT100	0306	NA
Software	ADT_Radiated_V 7.6.011	NA	NA
TIMES RF cable	LL142	CABLE-CH6-01	Dec. 19, 2006
ROHDE & SCHWARZ Spectrum Analyzer	FSP 40	100036	Mar. 16. 2007

- NOTE:**
1. The calibration interval of the above test instruments is 12 months. And the calibrations are traceable to NML/ROC and NIST/USA.
 2. The horn antenna and HP preamplifier (model: 8449B) are used only for the measurement of emission frequency above 1GHz if tested.
 3. The test was performed in ADT Chamber No. 6.
 4. The Industry Canada Reference No. IC 3789-6.

4.2.3 TEST PROCEDURES

- a. The EUT was placed on the top of a rotating table 0.8 meters above the ground at a 3 meter semi-anechoic chamber. The table was rotated 360 degrees to determine the position of the highest radiation.
- b. The EUT was set 3 meters away from the interference-receiving antenna, which was mounted on the top of a variable-height antenna tower.
- c. The antenna is a broadband antenna, and its height is varied from one meter to four meters above the ground to determine the maximum value of the field strength. Both horizontal and vertical polarizations of the antenna are set to make the measurement.
- d. For each suspected emission, the EUT was arranged to its worst case and then the antenna was tuned to heights from 1 meter to 4 meters and the rotatable table was turned from 0 degrees to 360 degrees to find the maximum reading.
- e. The test-receiver system was set to Peak Detect Function and Specified Bandwidth with Maximum Hold Mode.
- f. If the emission level of the EUT in peak mode was lower than the limit specified, then testing could be stopped and the peak values of the EUT would be reported. Otherwise the emissions would be re-tested one by one using peak, quasi-peak or average method as specified and then reported in a data sheet.

NOTE:

1. The resolution bandwidth and video bandwidth of test receiver/spectrum analyzer is 120kHz for Quasi-peak detection at frequency below 1GHz.
2. The resolution bandwidth and video bandwidth of test receiver/spectrum analyzer is 1 MHz for Peak detection (PK) at frequency above 1GHz.
3. The resolution bandwidth of test receiver/spectrum analyzer is 1 MHz and the video bandwidth is 10 Hz for Average detection (AV) at frequency above 1GHz.

4.2.4 DEVIATION FROM TEST STANDARD

No deviation

4.2.5 TEST SETUP

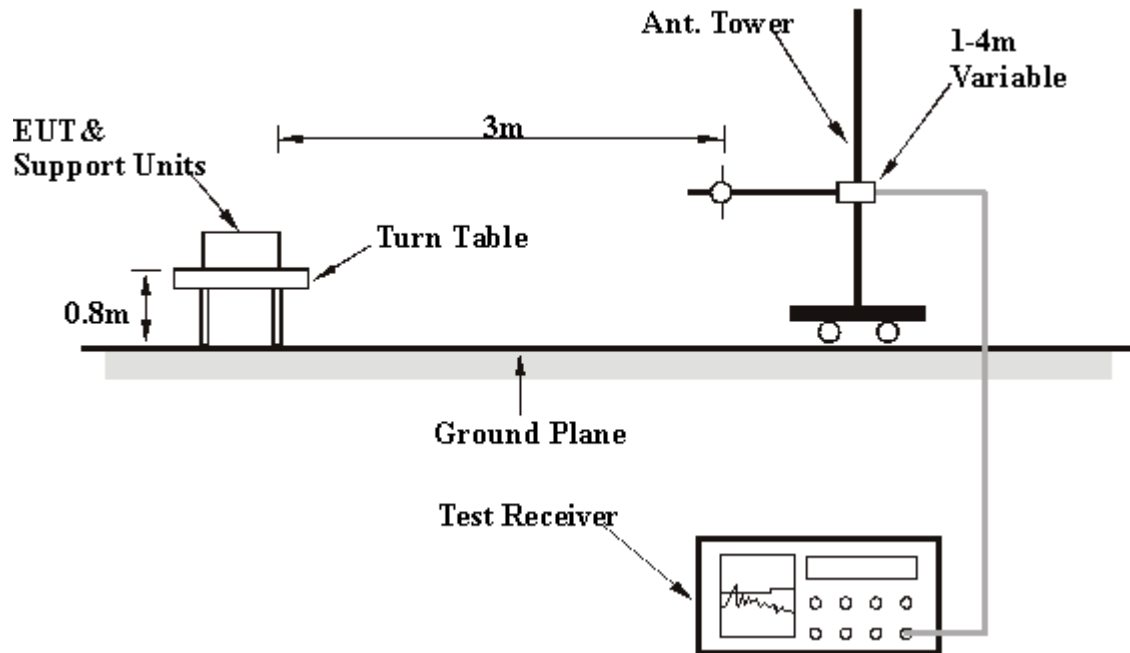

For the actual test configuration, please refer to the related item – Photographs of the Test Configuration.

4.2.6 EUT OPERATING CONDITIONS

For Mode A:

- Connected the EUT to a notebook system via a USB cable and placed on a testing table.
- The notebook system ran a test program (provided by manufacturer) to enable EUT under transmission/receiving condition continuously at specific channel frequency.
- The notebook system sent "H" messages to its screen.
- The notebook system sent "H" messages to printer and the printer prints them out
- The notebook system sent "H" messages to modem.
- Repeated c ~ e.

For Mode B & C:

Set the EUT under transmission/receiving condition continuously at specific channel frequency.

4.2.7 TEST RESULTS

RADIATED WORST CASE DATA: FOR MODE A (BELOW 1GHz)

TEST MODE	A		
MODULATION TYPE	GFSK	CHANNEL	0
INPUT POWER (SYSTEM)	120Vac, 60 Hz	FREQUENCY RANGE	Below 1000MHz
ENVIRONMENTAL CONDITIONS	26deg. C, 61% RH, 994hPa	DETECTOR FUNCTION	Quasi-Peak
TESTED BY	Jamison Chan		

ANTENNA POLARITY & TEST DISTANCE: HORIZONTAL AT 3 M

No.	Freq. (MHz)	Emission Level (dBuV/m)	Limit (dBuV/m)	Margin (dB)	Antenna Height (m)	Table Angle (Degree)	Raw Value (dBuV)	Correction Factor (dB/m)
1	127.00	32.45 QP	43.50	-11.05	2.02 H	43	20.53	11.92
2	397.00	33.83 QP	46.00	-12.17	1.86 H	172	15.11	18.73
3	444.00	30.90 QP	46.00	-15.10	1.29 H	100	11.11	19.79
4	489.00	28.43 QP	46.00	-17.57	1.94 H	70	6.98	21.45
5	734.00	35.51 QP	46.00	-10.49	1.48 H	115	8.41	27.10
6	864.00	31.97 QP	46.00	-14.03	1.71 H	25	3.21	28.76
7	940.00	30.88 QP	46.00	-15.12	2.14 H	178	0.44	30.45

ANTENNA POLARITY & TEST DISTANCE: VERTICAL AT 3 M

No.	Freq. (MHz)	Emission Level (dBuV/m)	Limit (dBuV/m)	Margin (dB)	Antenna Height (m)	Table Angle (Degree)	Raw Value (dBuV)	Correction Factor (dB/m)
1	81.00	36.46 QP	40.00	-3.54	1.04 V	94	25.48	10.98
2	310.00	34.14 QP	46.00	-11.86	1.31 V	88	17.61	16.53
3	465.00	30.91 QP	46.00	-15.09	1.24 V	139	10.38	20.53
4	730.00	36.89 QP	46.00	-9.11	1.00 V	58	9.96	26.93
5	866.00	36.05 QP	46.00	-9.95	1.00 V	55	7.24	28.80
6	932.00	33.25 QP	46.00	-12.75	1.05 V	247	2.98	30.27

- REMARKS:**
1. Emission level(dBuV/m)=Raw Value(dBuV) + Correction Factor(dB/m)
 2. Correction Factor(dB/m) = Antenna Factor (dB/m) + Cable Factor (dB)
 - 3The other emission levels were very low against the limit.
 4. Margin value = Emission level – Limit value.

RADIATED WORST CASE DATA: FOR MODE B (BELOW 1GHz)

TEST MODE	B		
MODULATION TYPE	GFSK	CHANNEL	0
INPUT POWER	120Vac, 60 Hz	FREQUENCY RANGE	Below 1000MHz
ENVIRONMENTAL CONDITIONS	26deg. C, 61% RH, 994hPa	DETECTOR FUNCTION	Quasi-Peak
TESTED BY	Jamison Chan		

ANTENNA POLARITY & TEST DISTANCE: HORIZONTAL AT 3 M

No.	Freq. (MHz)	Emission Level (dBuV/m)	Limit (dBuV/m)	Margin (dB)	Antenna Height (m)	Table Angle (Degree)	Raw Value (dBuV)	Correction Factor (dB/m)
1	55.00	27.27 QP	40.00	-12.73	1.50 H	91	13.06	14.22
2	114.00	35.00 QP	43.50	-8.50	1.18 H	91	24.54	10.46
3	244.00	28.28 QP	46.00	-17.72	1.35 H	91	15.49	12.79
4	883.00	26.88 QP	46.00	-19.12	1.87 H	52	-2.31	29.18
5	918.00	26.85 QP	46.00	-19.15	1.27 H	94	-3.11	29.96
6	951.00	28.11 QP	46.00	-17.89	1.00 H	262	-2.56	30.67

ANTENNA POLARITY & TEST DISTANCE: VERTICAL AT 3 M

No.	Freq. (MHz)	Emission Level (dBuV/m)	Limit (dBuV/m)	Margin (dB)	Antenna Height (m)	Table Angle (Degree)	Raw Value (dBuV)	Correction Factor (dB/m)
1	59.00	32.63 QP	40.00	-7.37	1.27 V	283	18.75	13.87
2	180.00	27.18 QP	43.50	-16.32	1.07 V	94	14.68	12.50
3	778.00	26.09 QP	46.00	-19.91	1.35 V	235	-1.85	27.94
4	839.00	26.95 QP	46.00	-19.05	1.01 V	130	-1.41	28.36
5	899.00	27.55 QP	46.00	-18.45	1.23 V	118	-1.97	29.52
6	938.00	28.04 QP	46.00	-17.96	1.14 V	190	-2.36	30.40
7	949.00	29.03 QP	46.00	-16.97	1.06 V	109	-1.64	30.67

- REMARKS:**
1. Emission level(dBuV/m)=Raw Value(dBuV) + Correction Factor(dB/m)
 2. Correction Factor(dB/m) = Antenna Factor (dB/m) + Cable Factor (dB)
 - 3The other emission levels were very low against the limit.
 4. Margin value = Emission level – Limit value.

RADIATED WORST CASE DATA: FOR MODE C (BELOW 1GHz)

TEST MODE	C		
MODULATION TYPE	GFSK	CHANNEL	0
INPUT POWER	DC 3.7V	FREQUENCY RANGE	Below 1000MHz
ENVIRONMENTAL CONDITIONS	26deg. C, 61% RH, 994hPa	DETECTOR FUNCTION	Quasi-Peak
TESTED BY	Jamison Chan		

ANTENNA POLARITY & TEST DISTANCE: HORIZONTAL AT 3 M

No.	Freq. (MHz)	Emission Level (dBuV/m)	Limit (dBuV/m)	Margin (dB)	Antenna Height (m)	Table Angle (Degree)	Raw Value (dBuV)	Correction Factor (dB/m)
1	716.00	24.32 QP	46.00	-21.68	2.02 H	280	-2.02	26.35
2	769.00	25.20 QP	46.00	-20.80	1.65 H	238	-2.69	27.89
3	802.00	26.61 QP	46.00	-19.39	2.14 H	58	-1.44	28.05
4	846.00	26.71 QP	46.00	-19.29	1.76 H	292	-1.72	28.43
5	914.00	27.64 QP	46.00	-18.36	2.06 H	346	-2.23	29.87
6	946.00	28.30 QP	46.00	-17.70	1.00 H	280	-2.28	30.58

ANTENNA POLARITY & TEST DISTANCE: VERTICAL AT 3 M

No.	Freq. (MHz)	Emission Level (dBuV/m)	Limit (dBuV/m)	Margin (dB)	Antenna Height (m)	Table Angle (Degree)	Raw Value (dBuV)	Correction Factor (dB/m)
1	36.00	23.83 QP	40.00	-16.17	2.09 V	94	10.35	13.48
2	732.00	25.10 QP	46.00	-20.90	1.74 V	37	-1.91	27.01
3	775.00	25.87 QP	46.00	-20.13	2.27 V	46	-2.05	27.92
4	825.00	26.50 QP	46.00	-19.50	1.06 V	358	-1.75	28.25
5	885.00	27.34 QP	46.00	-18.66	2.04 V	106	-1.89	29.22
6	938.00	28.20 QP	46.00	-17.80	1.17 V	181	-2.21	30.40

- REMARKS:**
1. Emission level(dBuV/m)=Raw Value(dBuV) + Correction Factor(dB/m)
 2. Correction Factor(dB/m) = Antenna Factor (dB/m) + Cable Factor (dB)
 - 3The other emission levels were very low against the limit.
 4. Margin value = Emission level – Limit value.

RADIATED WORST CASE DATA: FOR MODE A (1 ~ 25GHz)

TEST MODE	A		
MODULATION TYPE	GFSK	CHANNEL	0
INPUT POWER (SYSTEM)	120Vac, 60 Hz	FREQUENCY RANGE	1 ~ 25GHz
ENVIRONMENTAL CONDITIONS	26deg. C, 65% RH, 996hPa	DETECTOR FUNCTION	Peak (PK) Average (AV)
TESTED BY	Jamison Chan		

ANTENNA POLARITY & TEST DISTANCE: HORIZONTAL AT 3 M

No.	Freq. (MHz)	Emission Level (dBuV/m)	Limit (dBuV/m)	Margin (dB)	Antenna Height (m)	Table Angle (Degree)	Raw Value (dBuV)	Correction Factor (dB/m)
1	2386.00	60.50 PK	74.00	-13.50	1.26 H	59	24.29	36.21
1	2386.00	46.40 AV	54.00	-7.60	1.26 H	59	10.19	36.21
2	*2402.00	102.61 PK			1.26 H	59	66.38	36.23
2	*2402.00	72.61 AV			1.26 H	59	26.38	36.23
3	3202.00	55.43 PK	74.00	-18.57	1.30 H	27	15.75	39.68
3	3202.00	48.31 AV	54.00	-5.69	1.30 H	27	8.63	39.68
4	4804.00	63.32 PK	74.00	-10.68	1.01 H	0	18.81	44.51
4	4804.00	33.32 AV	54.00	-20.68	1.01 H	0	-11.19	44.51

ANTENNA POLARITY & TEST DISTANCE: VERTICAL AT 3 M

No.	Freq. (MHz)	Emission Level (dBuV/m)	Limit (dBuV/m)	Margin (dB)	Antenna Height (m)	Table Angle (Degree)	Raw Value (dBuV)	Correction Factor (dB/m)
1	2386.00	59.43 PK	74.00	-14.57	1.12 V	331	23.22	36.21
1	2386.00	46.01 AV	54.00	-7.99	1.12 V	331	9.80	36.21
2	*2402.00	100.29 PK			1.12 V	331	64.06	36.23
2	*2402.00	70.29 AV			1.12 V	331	34.06	36.23
3	3202.00	53.72 PK	74.00	-20.28	1.44 V	327	14.04	39.68
3	3202.00	45.57 AV	54.00	-8.43	1.44 V	327	5.89	39.68
4	4804.00	59.54 PK	74.00	-14.46	1.11 V	188	19.86	39.68
4	4804.00	29.54 AV	54.00	-24.46	1.11 V	188	-10.14	39.68

- REMARKS:**
1. Emission level (dBuV/m) = Raw Value (dBuV) + Correction Factor (dB/m).
 2. Correction Factor (dB/m) = Antenna Factor (dB/m) + Cable Factor (dB).
 3. The other emission levels were very low against the limit.
 4. Margin value = Emission level – Limit value.
 5. The DH5 packet was the worse case duty cycle for a transmit dwell time on a channel, based upon bluetooth theory the transmitter is on 0.625 * 5 per 296.25 ms per channel. Therefore, the duty cycle be equal to: $20\log(3.125/100) = -30$ dB.
 6. Average value = peak reading + $20\log(\text{duty cycle})$.

TEST MODE	A		
MODULATION TYPE	GFSK	CHANNEL	39
INPUT POWER (SYSTEM)	120Vac, 60 Hz	FREQUENCY RANGE	1 ~ 25GHz
ENVIRONMENTAL CONDITIONS	26deg. C, 65% RH, 996hPa	DETECTOR FUNCTION	Peak (PK) Average (AV)
TESTED BY	Jamison Chan		

ANTENNA POLARITY & TEST DISTANCE: HORIZONTAL AT 3 M

No.	Freq. (MHz)	Emission Level (dBuV/m)	Limit (dBuV/m)	Margin (dB)	Antenna Height (m)	Table Angle (Degree)	Raw Value (dBuV)	Correction Factor (dB/m)
1	*2441.00	101.09 PK			1.27 H	58	64.77	36.32
1	*2441.00	71.09 AV			1.27 H	58	34.77	36.32
2	3256.00	54.85 PK	74.00	-19.15	1.50 H	267	14.94	39.91
2	3256.00	46.03 AV	54.00	-7.97	1.50 H	267	6.12	39.91
3	4882.00	64.19 PK	74.00	-9.81	1.30 H	0	19.85	44.33
3	4882.00	34.19 AV	54.00	-19.81	1.30 H	0	-10.15	44.33

ANTENNA POLARITY & TEST DISTANCE: VERTICAL AT 3 M

No.	Freq. (MHz)	Emission Level (dBuV/m)	Limit (dBuV/m)	Margin (dB)	Antenna Height (m)	Table Angle (Degree)	Raw Value (dBuV)	Correction Factor (dB/m)
1	*2441.00	99.52 PK			1.05 V	332	63.20	36.32
1	*2441.00	69.52 AV			1.05 V	332	23.30	36.32
2	3256.00	54.29 PK	74.00	-19.71	1.35 V	6	14.38	39.91
2	3256.00	43.92 AV	54.00	-10.08	1.35 V	6	4.01	39.91
3	4882.00	62.50 PK	74.00	-11.50	1.09 V	204	18.16	44.33
3	4882.00	32.50 AV	54.00	-21.50	1.09 V	204	-11.84	44.33

- REMARKS:**
1. Emission level (dBuV/m) = Raw Value (dBuV) + Correction Factor (dB/m).
 2. Correction Factor (dB/m) = Antenna Factor (dB/m) + Cable Factor (dB).
 3. The other emission levels were very low against the limit.
 4. Margin value = Emission level – Limit value.
 5. The DH5 packet was the worse case duty cycle for a transmit dwell time on a channel, based upon bluetooth theory the transmitter is on 0.625 * 5 per 296.25 ms per channel. Therefore, the duty cycle be equal to: $20\log(3.125/100) = -30$ dB.
 6. Average value = peak reading + $20\log(\text{duty cycle})$.

TEST MODE	A		
MODULATION TYPE	GFSK	CHANNEL	78
INPUT POWER (SYSTEM)	120Vac, 60 Hz	FREQUENCY RANGE	1 ~ 25GHz
ENVIRONMENTAL CONDITIONS	26deg. C, 65% RH, 996hPa	DETECTOR FUNCTION	Peak (PK) Average (AV)
TESTED BY	Jamison Chan		

ANTENNA POLARITY & TEST DISTANCE: HORIZONTAL AT 3 M

No.	Freq. (MHz)	Emission Level (dBuV/m)	Limit (dBuV/m)	Margin (dB)	Antenna Height (m)	Table Angle (Degree)	Raw Value (dBuV)	Correction Factor (dB/m)
1	*2480.00	100.18 PK			1.19 H	53	63.77	36.41
1	*2480.00	70.18 AV			1.19 H	53	33.77	36.41
2	2483.90	61.98 PK	74.00	-12.02	1.19 H	53	25.57	36.41
2	2483.90	48.30 AV	54.00	-5.70	1.19 H	53	11.89	36.41
3	3308.00	53.57 PK	74.00	-20.43	1.00 H	244	13.44	40.12
3	3308.00	42.80 AV	54.00	-11.20	1.00 H	244	2.67	40.12
4	4960.00	64.15 PK	74.00	-9.85	1.38 H	3	19.72	44.43
4	4960.00	34.15 AV	54.00	-19.85	1.38 H	3	-10.28	44.43

ANTENNA POLARITY & TEST DISTANCE: VERTICAL AT 3 M

No.	Freq. (MHz)	Emission Level (dBuV/m)	Limit (dBuV/m)	Margin (dB)	Antenna Height (m)	Table Angle (Degree)	Raw Value (dBuV)	Correction Factor (dB/m)
1	*2480.00	97.60 PK			1.29 V	327	61.19	36.41
1	*2480.00	67.60 AV			1.29 V	327	31.19	36.41
2	2483.90	61.58 PK	74.00	-12.42	1.29 V	327	25.17	36.41
2	2483.90	46.42 AV	54.00	-7.58	1.29 V	327	10.01	36.41
3	3308.00	53.76 PK	74.00	-20.24	1.29 V	3	13.63	40.12
3	3308.00	41.78 AV	54.00	-12.22	1.29 V	3	1.65	40.12
4	4960.00	64.01 PK	74.00	-9.99	1.02 V	45	19.58	44.43
4	4960.00	34.01 AV	54.00	-19.99	1.02 V	45	-10.42	44.43

- REMARKS:**
1. Emission level (dBuV/m) = Raw Value (dBuV) + Correction Factor (dB/m).
 2. Correction Factor (dB/m) = Antenna Factor (dB/m) + Cable Factor (dB).
 3. The other emission levels were very low against the limit.
 4. Margin value = Emission level – Limit value.
 5. The DH5 packet was the worse case duty cycle for a transmit dwell time on a channel, based upon bluetooth theory the transmitter is on 0.625 * 5 per 296.25 ms per channel. Therefore, the duty cycle be equal to: $20\log(3.125/100) = -30$ dB.
 6. Average value = peak reading + $20\log(\text{duty cycle})$.

4.3 NUMBER OF HOPPING FREQUENCY USED

4.3.1 LIMIT OF HOPPING FREQUENCY USED

At least 15 channels frequencies, and should be equally spaced.

4.3.2 TEST INSTRUMENTS

DESCRIPTION & MANUFACTURER	MODEL NO.	SERIAL NO.	CALIBRATED UNTIL
SPECTRUM ANALYZER	FSP 40	100036	Mar. 16. 2007

NOTE: The calibration interval of the above test instruments is 12 months. And the calibrations are traceable to NML/ROC and NIST/USA.

4.3.3 TEST PROCEDURES

- a. Check the calibration of the measuring instrument (SA) using either an internal calibrator or a known signal from an external generator.
- b. Turn on the EUT and connect its antenna terminal to measurement via a low loss cable. Then set it to any one measured frequency within its operating range and make sure the instrument is operated in its linear range.
- c. Set the SA on MaxHold Mode, and then keep the EUT in hopping mode. Record all the signals from each channel until each one has been recorded.
- d. Set the SA on View mode and then plot the result on SA screen.
- e. Repeat above procedures until all frequencies measured were complete.

4.3.4 DEVIATION FROM TEST STANDARD

No deviation.

4.3.5 TEST SETUP

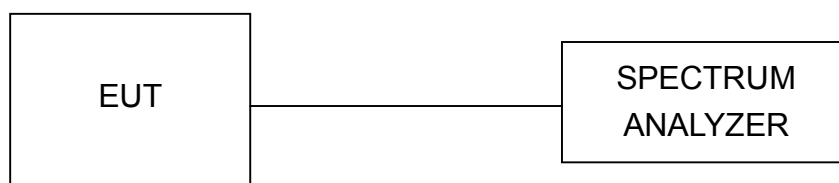

4.3.6 TEST RESULTS

There are 79 hopping frequencies in the hopping mode. Please refer to next two pages for the test result. On the plots, it shows that the hopping frequencies are equally spaced.

FOR MODE A:

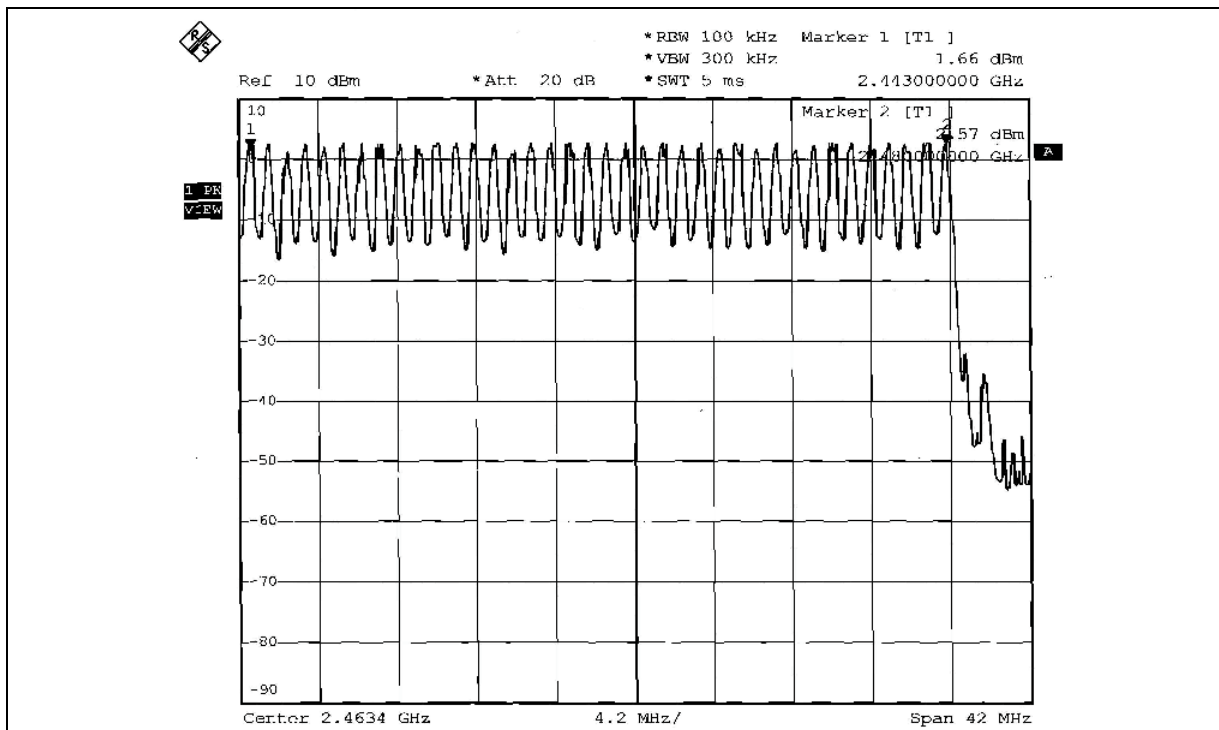
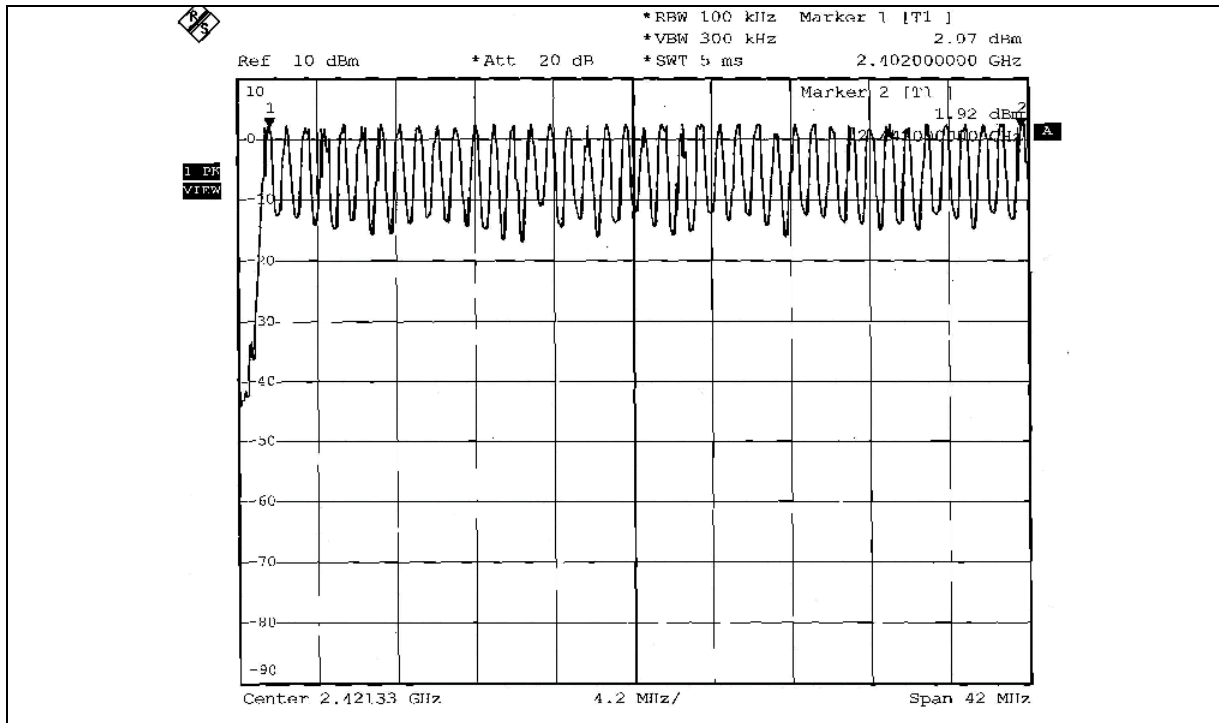



4.4 DWELL TIME ON EACH CHANNEL

4.4.1 LIMIT OF DWELL TIME USED

The average time of occupancy on any channel shall not be greater than 0.4 seconds within a period of 0.4 seconds multiplied by the number of hopping channels employed.

4.4.2 TEST INSTRUMENTS

DESCRIPTION & MANUFACTURER	MODEL NO.	SERIAL NO.	CALIBRATED UNTIL
SPECTRUM ANALYZER	FSP 40	100036	Mar. 16. 2007

NOTES: The calibration interval of the above test instruments is 12 months. And the calibrations are traceable to NML/ROC and NIST/USA.

4.4.3 TEST PROCEDURES

- a. Check the calibration of the measuring instrument (SA) using either an internal calibrator or a known signal from an external generator.
- b. Turn on the EUT and connect its antenna terminal to measurement via a low loss cable. Then set it to any one measured frequency within its operating range and make sure the instrument is operated in its linear range.
- c. Adjust the center frequency of SA on any frequency be measured and set SA to zero span mode. And then, set RBW and VBW of spectrum analyzer to proper value.
- d. Measure the time duration of one transmission on the measured frequency. And then plot the result with time difference of this time duration.
- e. Repeat above procedures until all different time-slot modes have been completed.

4.4.4 DEVIATION FROM TEST STANDARD

No deviation.

4.4.5 TEST SETUP



4.4.6 TEST RESULTS

FOR MODE A:

Mode	Number of transmission in a 31.6 (79Hopping*0.4)	Length of transmission time (msec)	Result (msec)	Limit (msec)
DH1	51 (times / 5 sec) *6.32=322.32 times	0.510	164.3832	400
DH3	25 (times / 5 sec) *6.32=158.00 times	1.774	280.2920	400
DH5	17 (times / 5 sec) *6.32=107.44 times	3.080	330.9152	400

NOTE: Test plots of the transmitting time slot are shown on next 3 pages.

DH1

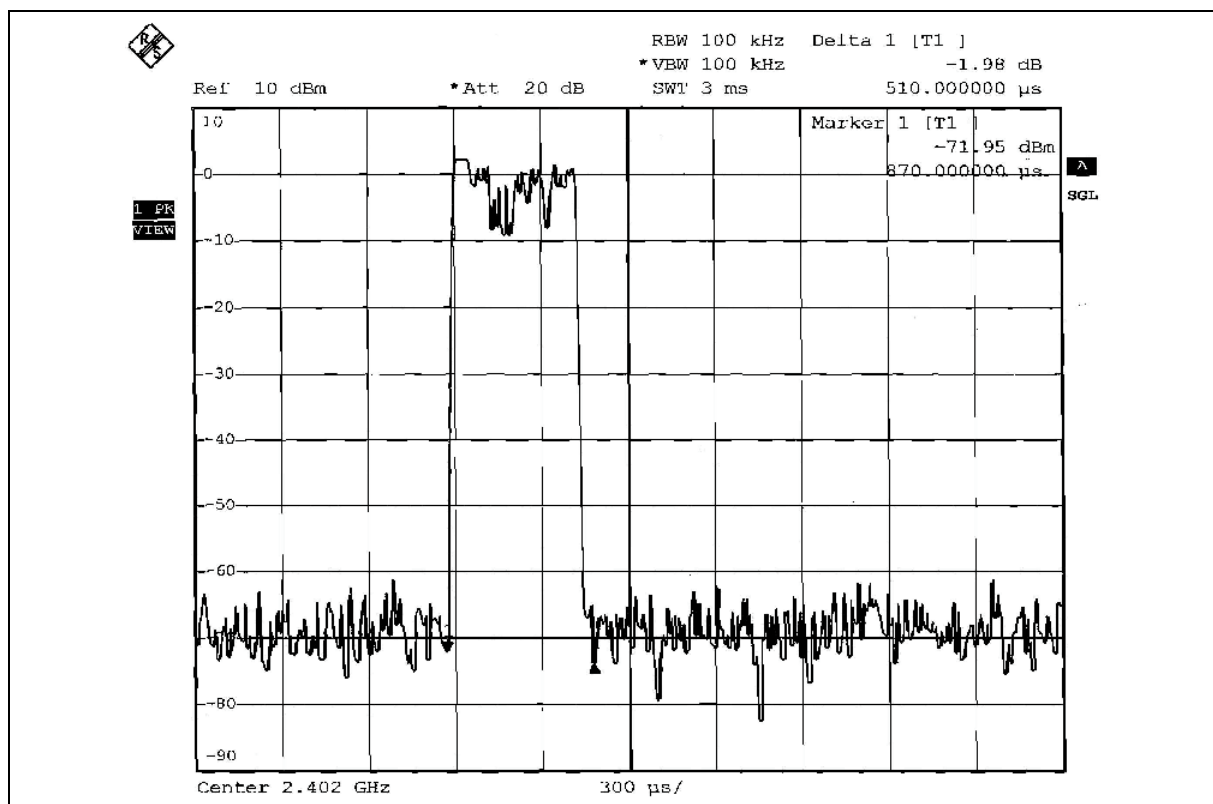
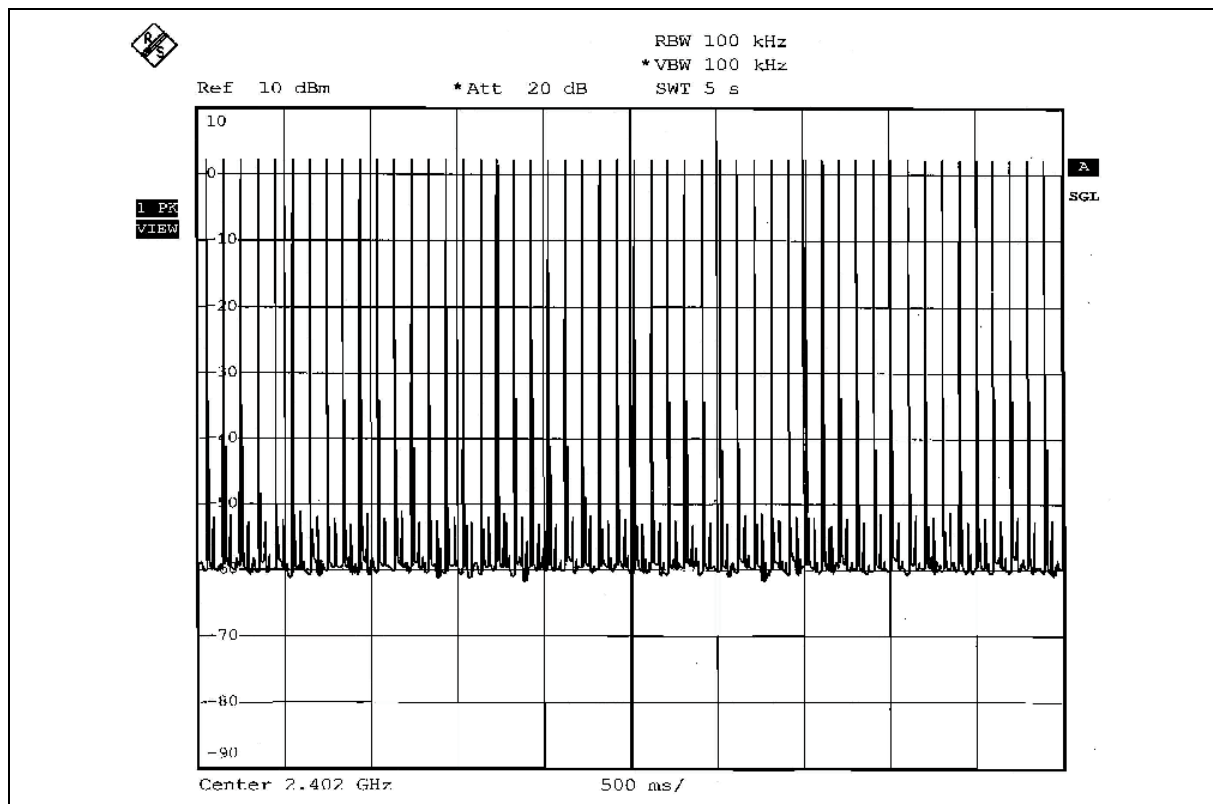

DH3

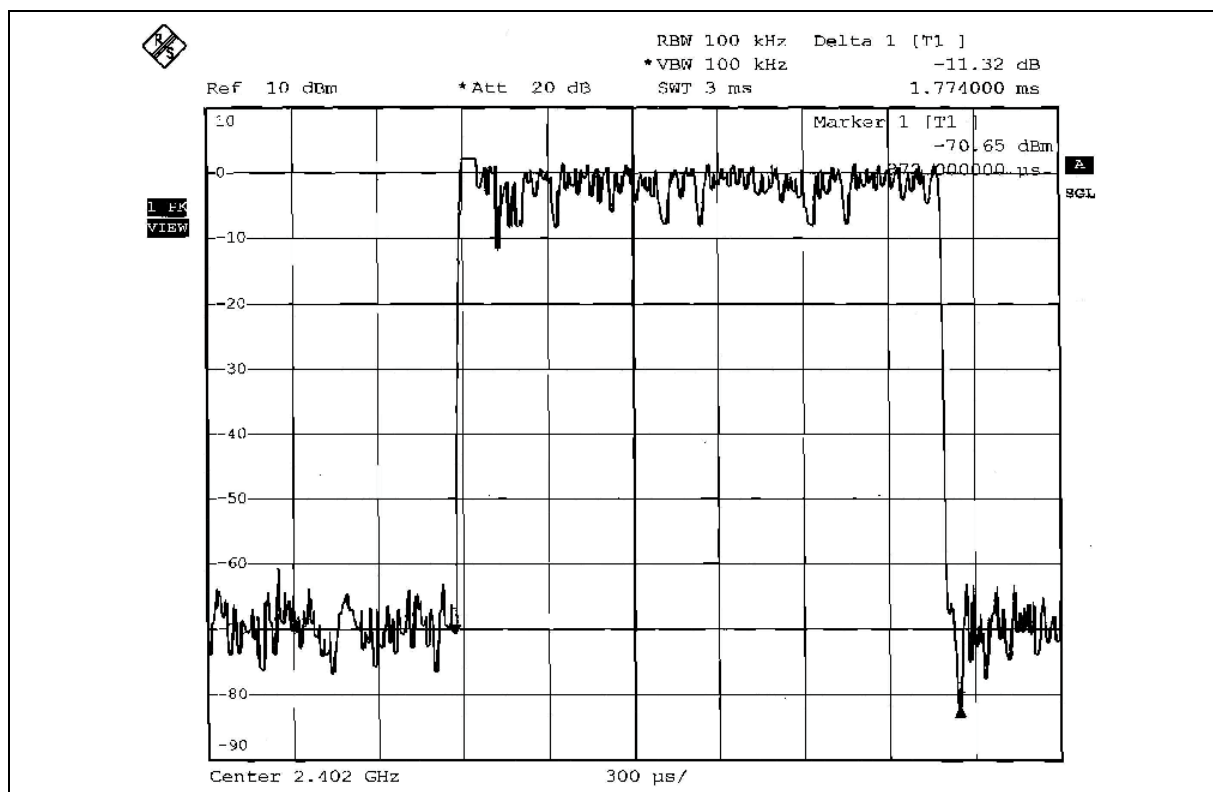
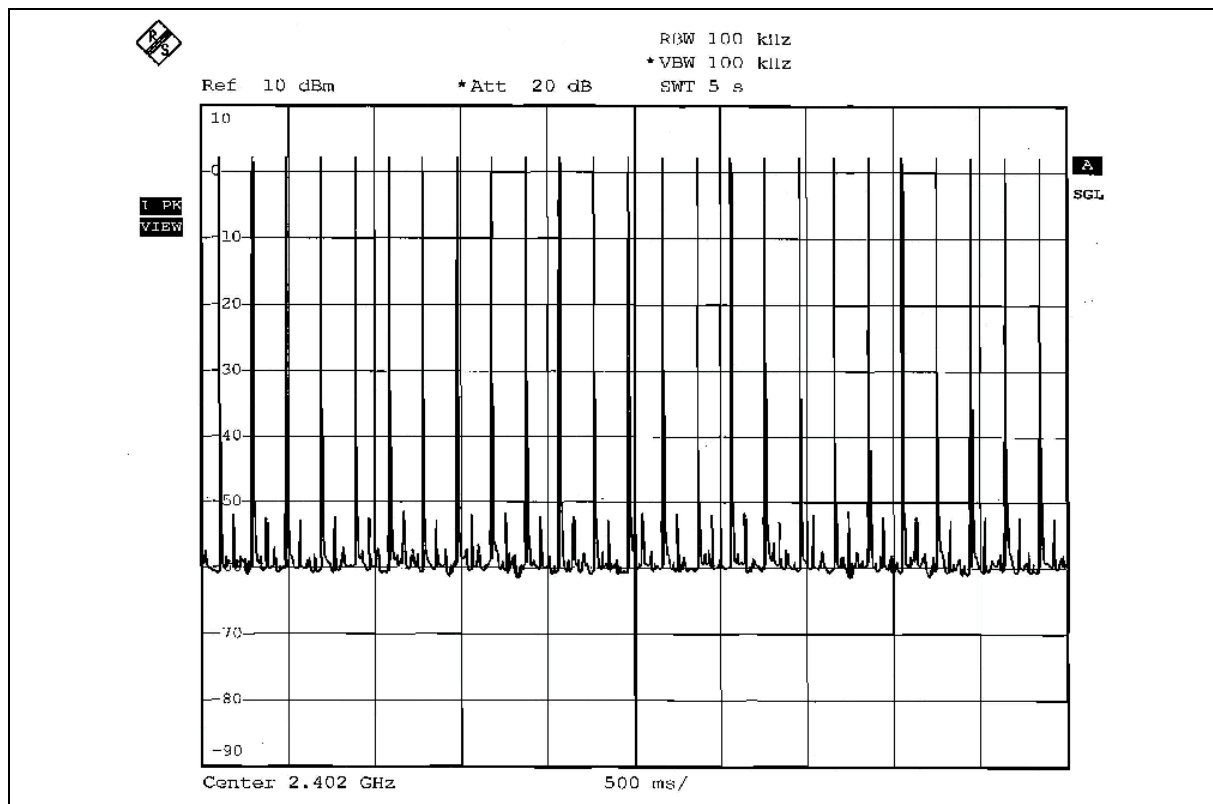

DH5

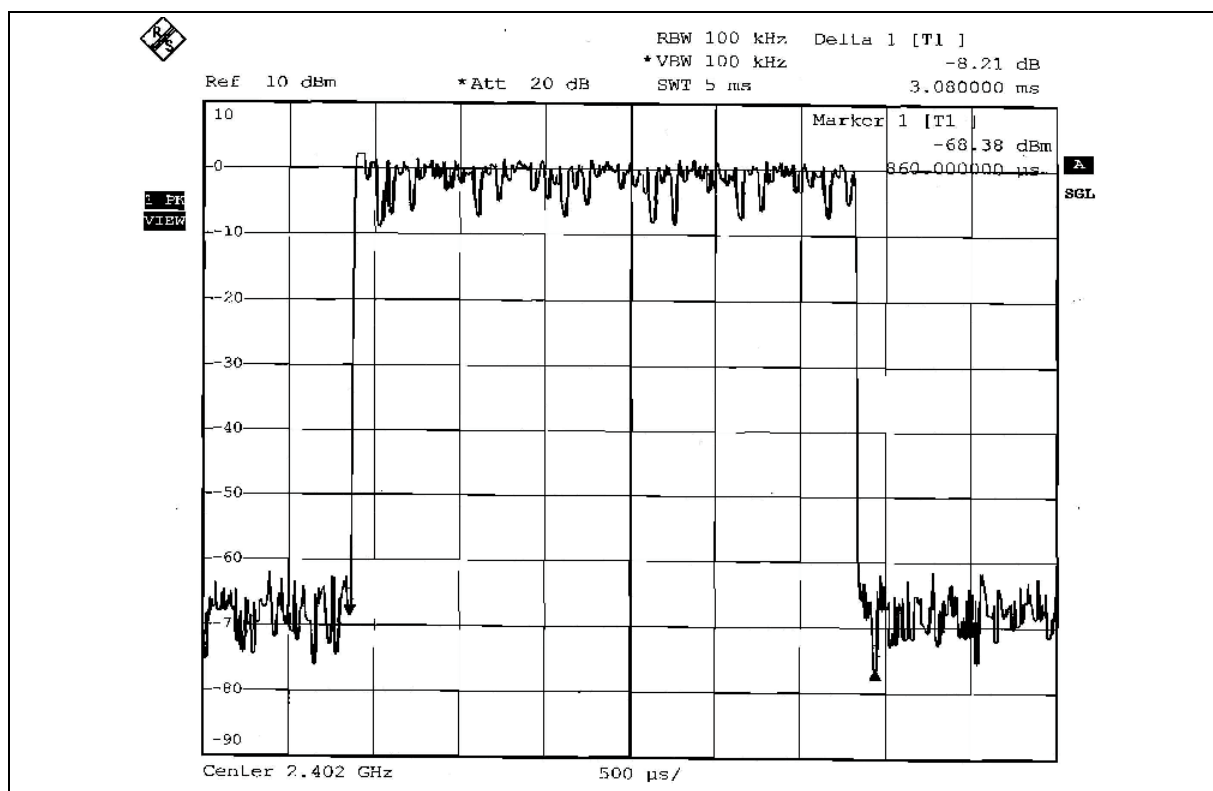
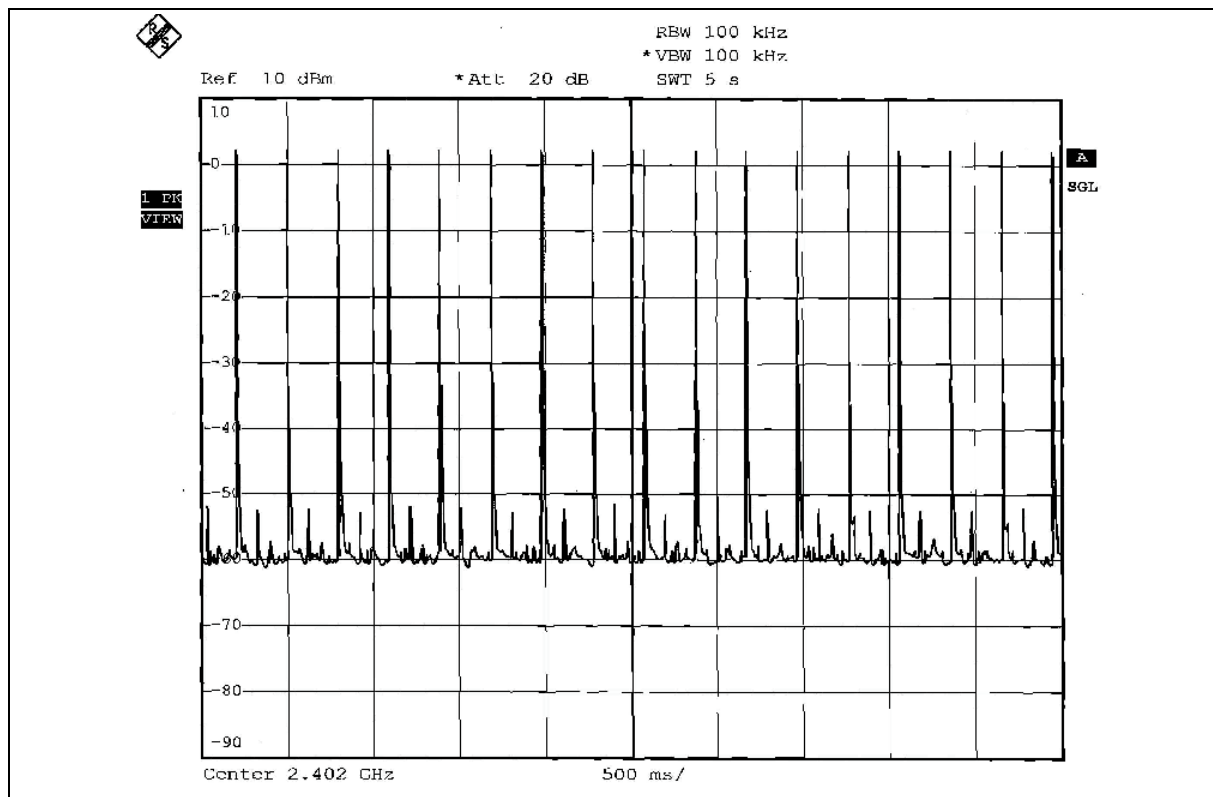



4.5 CHANNEL BANDWIDTH

4.5.1 LIMITS OF CHANNEL BANDWIDTH

For frequency hopping system operating in the 2400-2483.5MHz, If the 20dB bandwidth of hopping channel is greater than 25kHz, 20dB bandwidth of hopping channel shall be a minimum limit for the hopping channel separation.

4.5.2 TEST INSTRUMENTS

DESCRIPTION & MANUFACTURER	MODEL NO.	SERIAL NO.	CALIBRATED UNTIL
SPECTRUM ANALYZER	FSP 40	100036	Mar. 16. 2007

NOTE: The calibration interval of the above test instruments is 12 months. And the calibrations are traceable to NML/ROC and NIST/USA.

4.5.3 TEST PROCEDURE

- a. Check the calibration of the measuring instrument using either an internal calibrator or a known signal from an external generator.
- b. Turn on the EUT and connect it to measurement instrument. Then set it to any one convenient frequency within its operating range. Set a reference level on the measuring instrument equal to the highest peak value.
- c. Measure the frequency difference of two frequencies that were attenuated 20dB from the reference level. Record the frequency difference as the emission bandwidth.
- d. Repeat above procedures until all frequencies measured were complete.

4.5.4 DEVIATION FROM TEST STANDARD

No deviation.

4.5.5 TEST SETUP



4.5.6 EUT OPERATING CONDITION

The software provided by client enabled the EUT to transmit and receive data at lowest, middle and highest channel frequencies individually.

4.5.7 TEST RESULTS

TEST MODE	A		
MODULATION TYPE	GFSK	CHANNEL	0, 39, 78
INPUT POWER (SYSTEM)	120Vac, 60 Hz	ENVIRONMENTAL CONDITIONS	26deg. C, 70% RH, 996hPa
TESTED BY	Jamison Chan		

CHANNEL	CHANNEL FREQUENCY (MHz)	20dB BANDWIDTH (MHz)
0	2402	0.825
39	2441	0.834
78	2480	0.831

CH 0

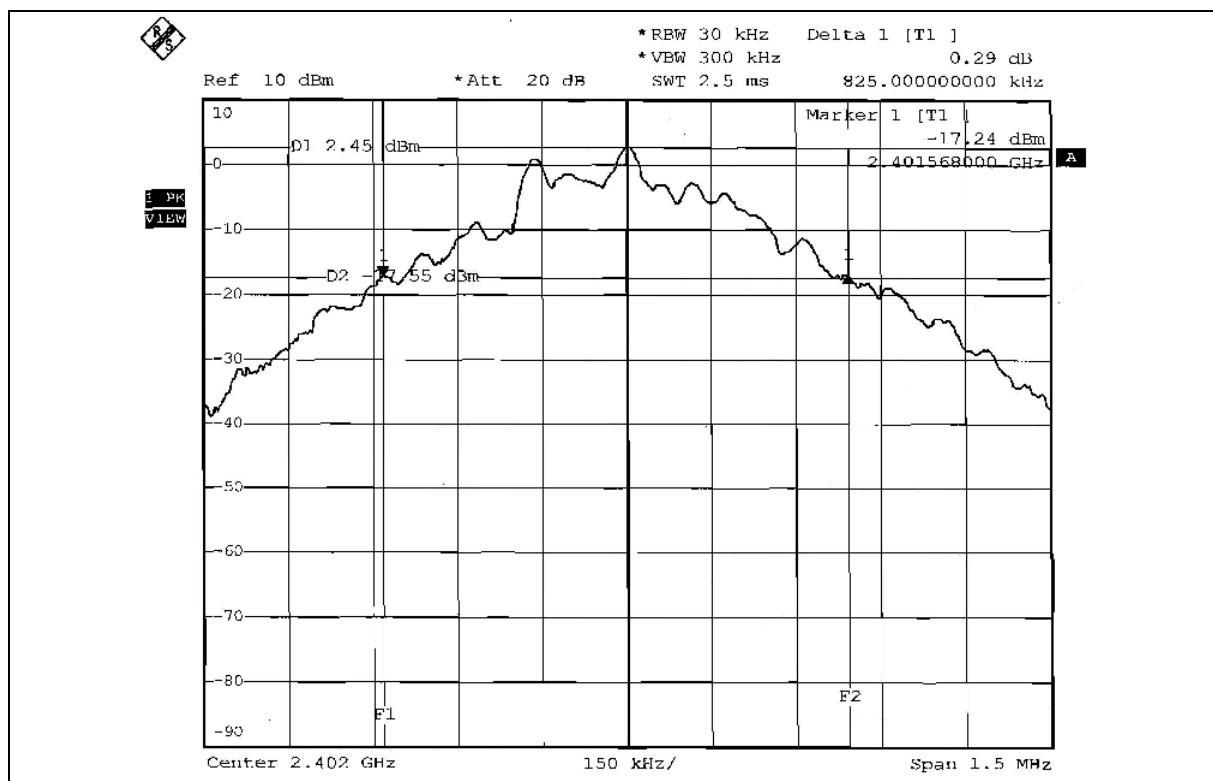

CH 39

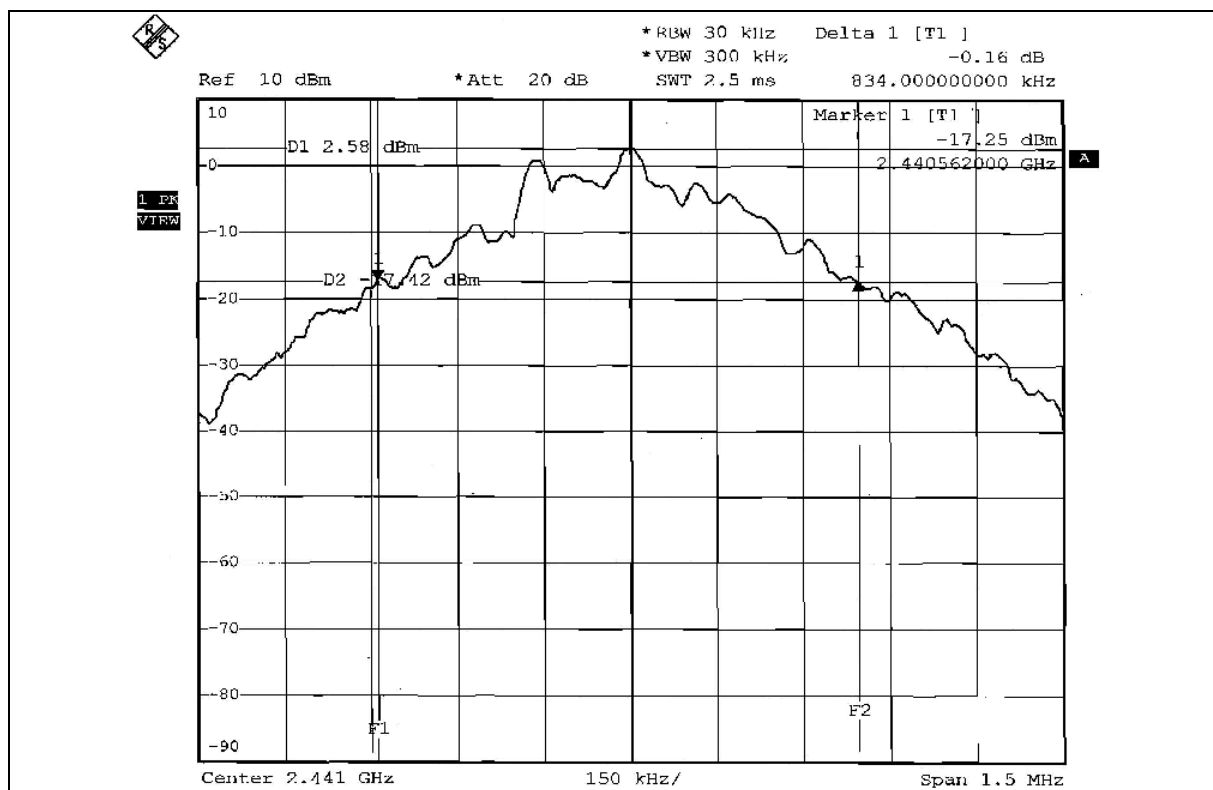

CH 78

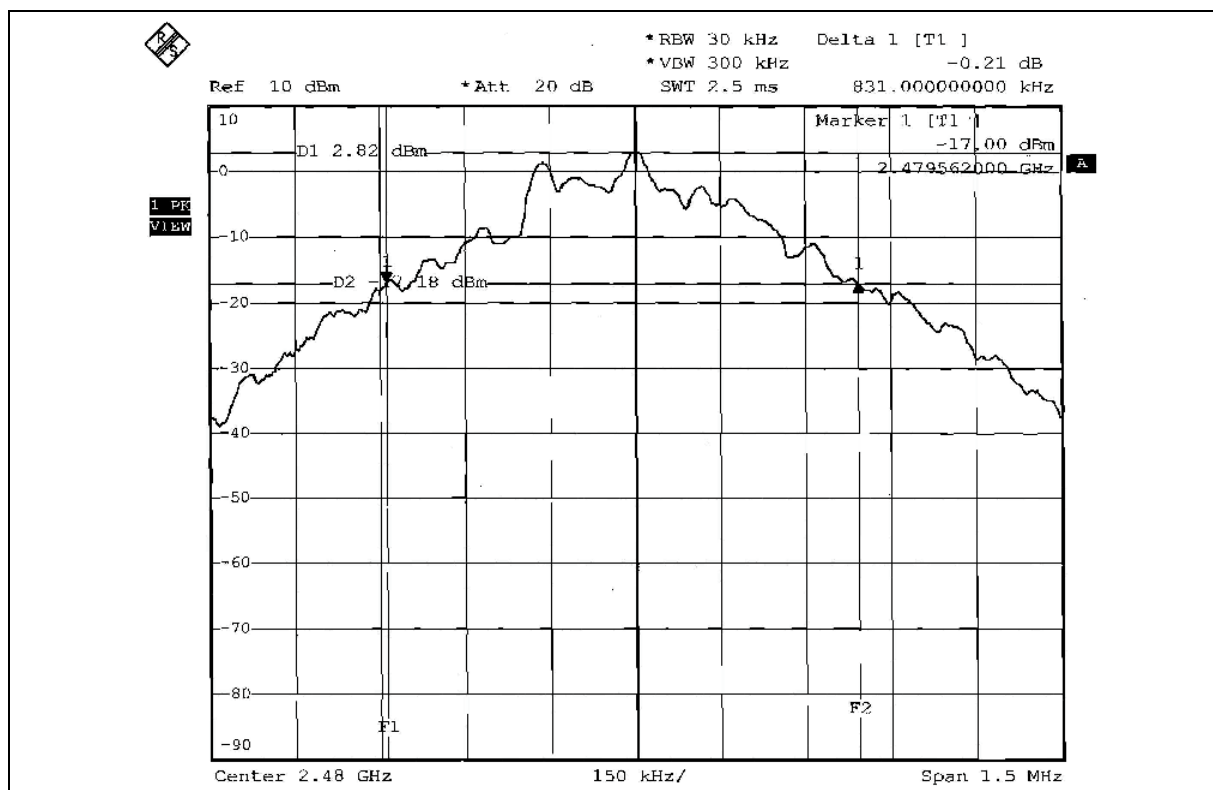

4.6 HOPPING CHANNEL SEPARATION

4.6.1 LIMIT OF HOPPING CHANNEL SEPARATION

At least 25kHz or 20dB hopping channel bandwidth (whichever is greater).

4.6.2 TEST INSTRUMENTS

DESCRIPTION & MANUFACTURER	MODEL NO.	SERIAL NO.	CALIBRATED UNTIL
SPECTRUM ANALYZER	FSP 40	100036	Mar. 16. 2007

NOTES: The calibration interval of the above test instruments is 12 months. And the calibrations are traceable to NML/ROC and NIST/USA.

4.6.3 TEST PROCEDURES

1. Check the calibration of the measuring instrument using either an internal calibrator or a known signal from an external generator.
2. Turn on the EUT and connect it to measurement instrument. Then set it to any one convenient frequency within its operating range.
3. By using the MaxHold function record the separation of two adjacent channels.
4. Measure the frequency difference of these two adjacent channels by SA MARK function. And then plot the result on SA screen.
5. Repeat above procedures until all frequencies measured were complete.

4.6.4 DEVIATION FROM TEST STANDARD

No deviation.

4.6.5 TEST SETUP



4.6.6 TEST RESULTS

TEST MODE	A		
MODULATION TYPE	GFSK	CHANNEL	0, 39, 78
INPUT POWER (SYSTEM)	120Vac, 60 Hz	ENVIRONMENTAL CONDITIONS	26deg. C, 70% RH, 996hPa
TESTED BY	Jamison Chan		

CHANNEL	FREQUENCY (MHz)	ADJACENT CHANNEL SEPARATION (MHz)	MINIMUM LIMIT (MHz)	PASS / FAIL
0	2402	1.170	0.825	PASS
39	2441	1.005	0.834	PASS
78	2480	1.170	0.831	PASS

NOTE: The minimum limit is 20dB bandwidth. Test results please refer to next two pages.

CH 0

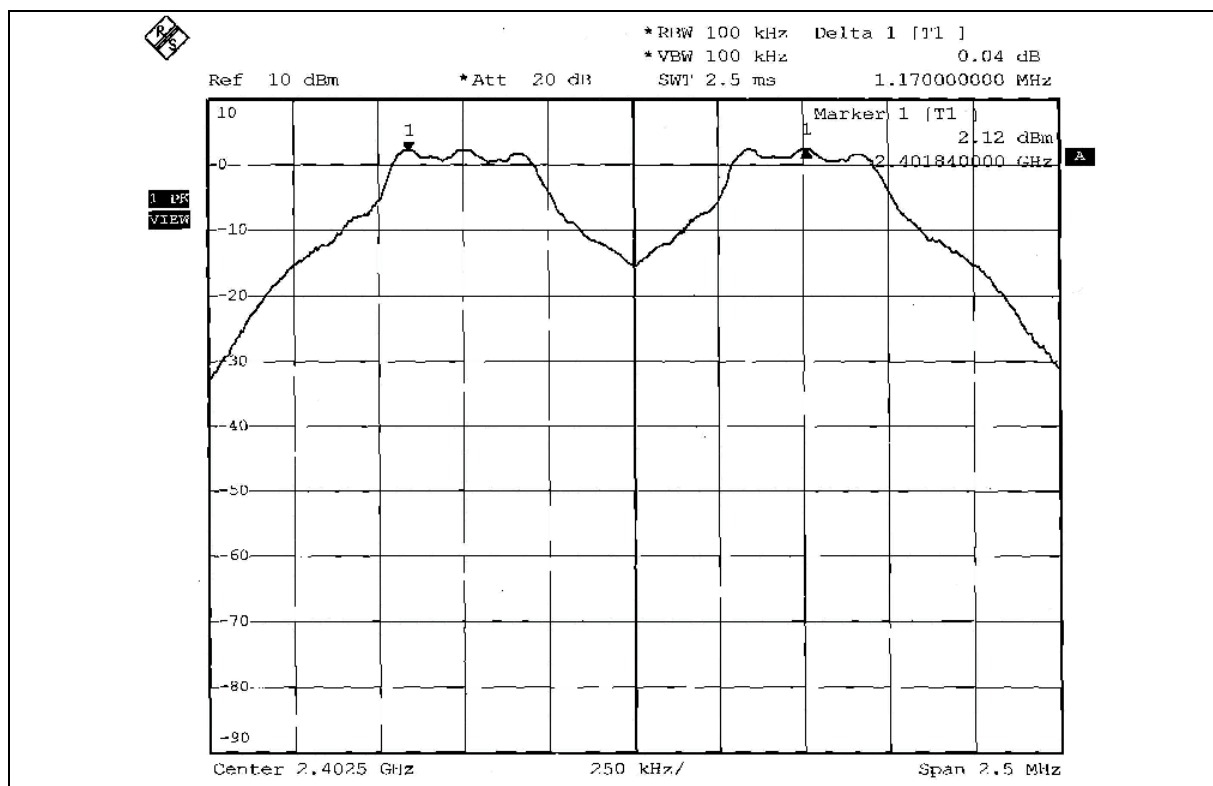

CH 39

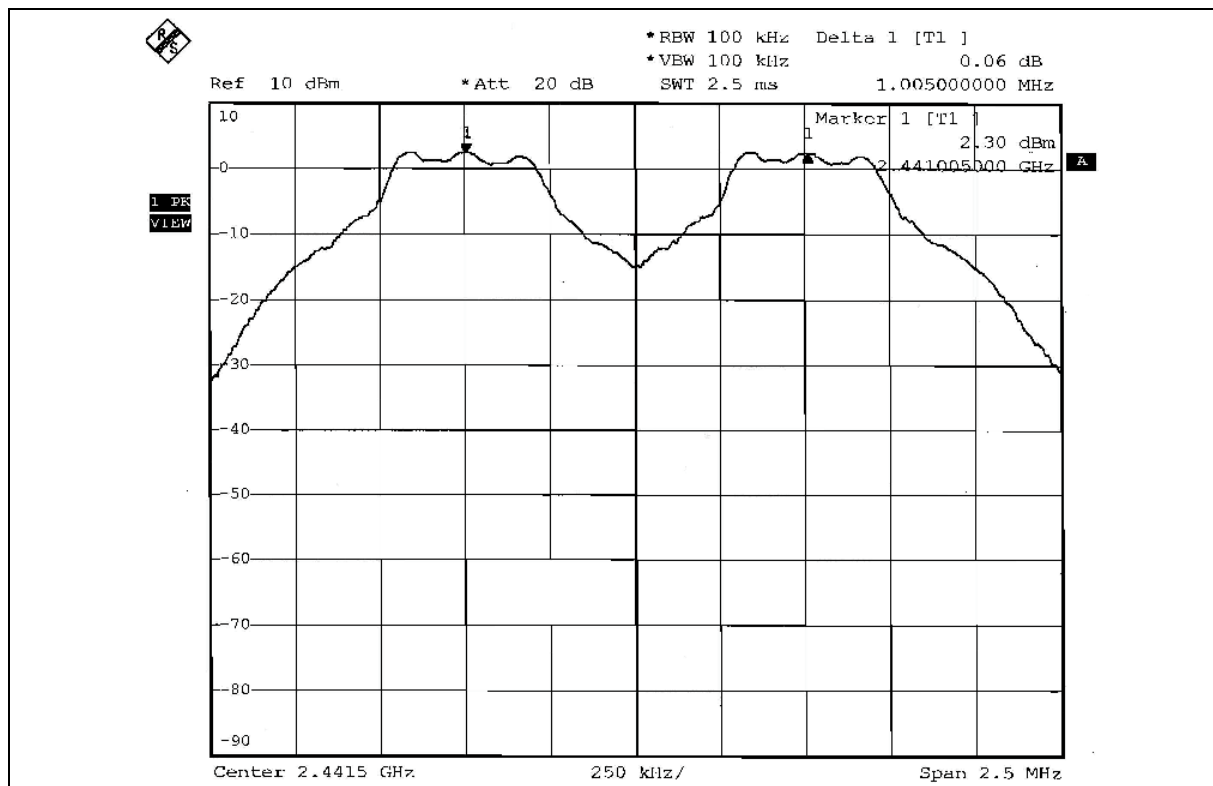

CH 78

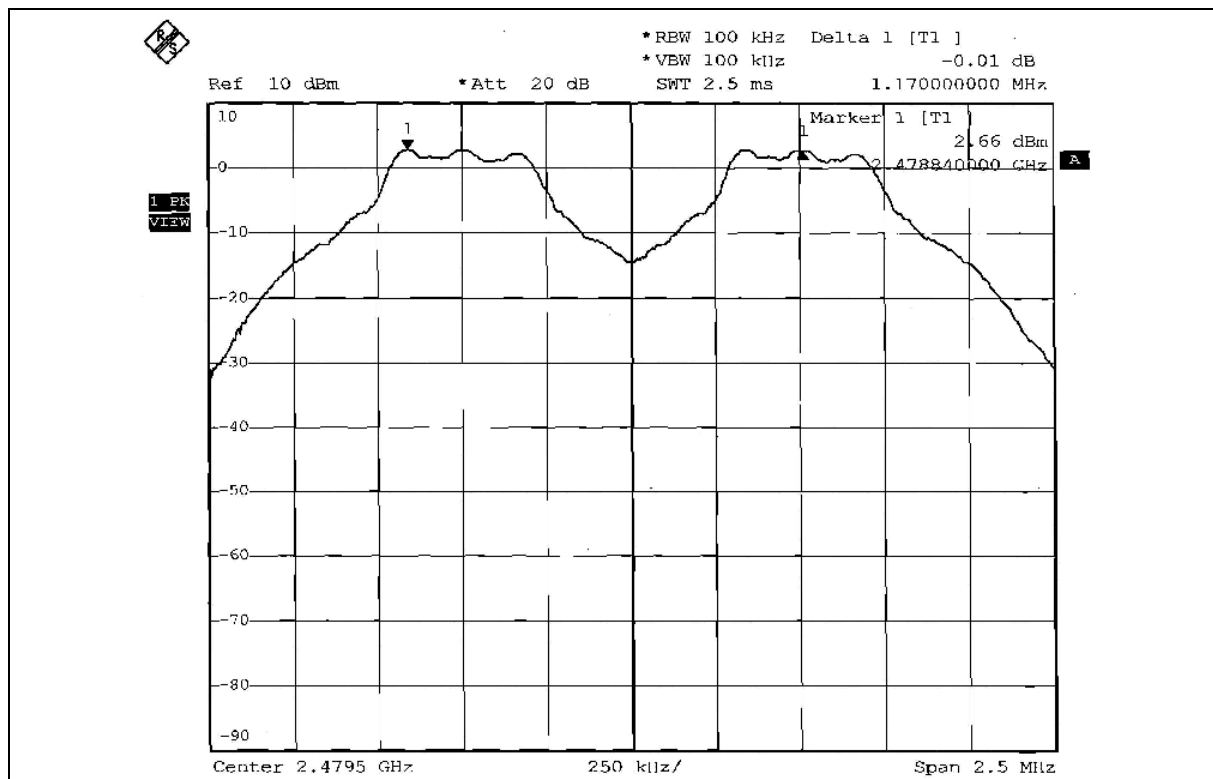



4.7 MAXIMUM PEAK OUTPUT POWER

4.7.1 LIMITS OF MAXIMUM PEAK OUTPUT POWER MEASUREMENT

The Maximum Peak Output Power Measurement is 30dBm.

4.7.2 TEST INSTRUMENTS

DESCRIPTION & MANUFACTURER	MODEL NO.	SERIAL NO.	CALIBRATED UNTIL
SPECTRUM ANALYZER	FSP 40	100036	Mar. 16. 2007

NOTE: The calibration interval of the above test instruments is 12 months and the calibrations are traceable to NML/ROC and NIST/USA.

4.7.3 TEST PROCEDURES

- a. Check the calibration of the measuring instrument using either an internal calibrator or a known signal from an external generator.
- b. Turn on the EUT and connect it to measurement instrument. Then set it to any one convenient frequency within its operating range. Set a reference level on the measuring instrument equal to the highest peak value.
- c. The center frequency of the spectrum analyzer is set to the fundamental frequency and using 3 MHz RBW and 10 MHz VBW.
- d. Measure the captured power within the band and recording the plot.
- e. Repeat above procedures until all frequencies required were complete.

4.7.4 DEVIATION FROM TEST STANDARD

No deviation

4.7.5 TEST SETUP



For the actual test configuration, please refer to the related Item – Photographs of the Test Configuration.

4.7.6 EUT OPERATING CONDITION

The software provided by client enabled the EUT to transmit and receive data at lowest, middle and highest channel frequencies individually.

4.7.7 TEST RESULTS

TEST MODE	A		
MODULATION TYPE	GFSK	CHANNEL	0, 39, 78
INPUT POWER (SYSTEM)	120Vac, 60 Hz	ENVIRONMENTAL CONDITIONS	26deg. C, 70% RH, 996hPa
TESTED BY	Jamison Chan		

CHANNEL	CHANNEL FREQUENCY (MHz)	PEAK POWER OUTPUT (mW)	PEAK POWER OUTPUT (dBm)	PEAK POWER LIMIT (dBm)	PASS/FAIL
0	2402	1.714	2.34	30	PASS
39	2441	1.762	2.46	30	PASS
78	2480	1.866	2.71	30	PASS

CH 0

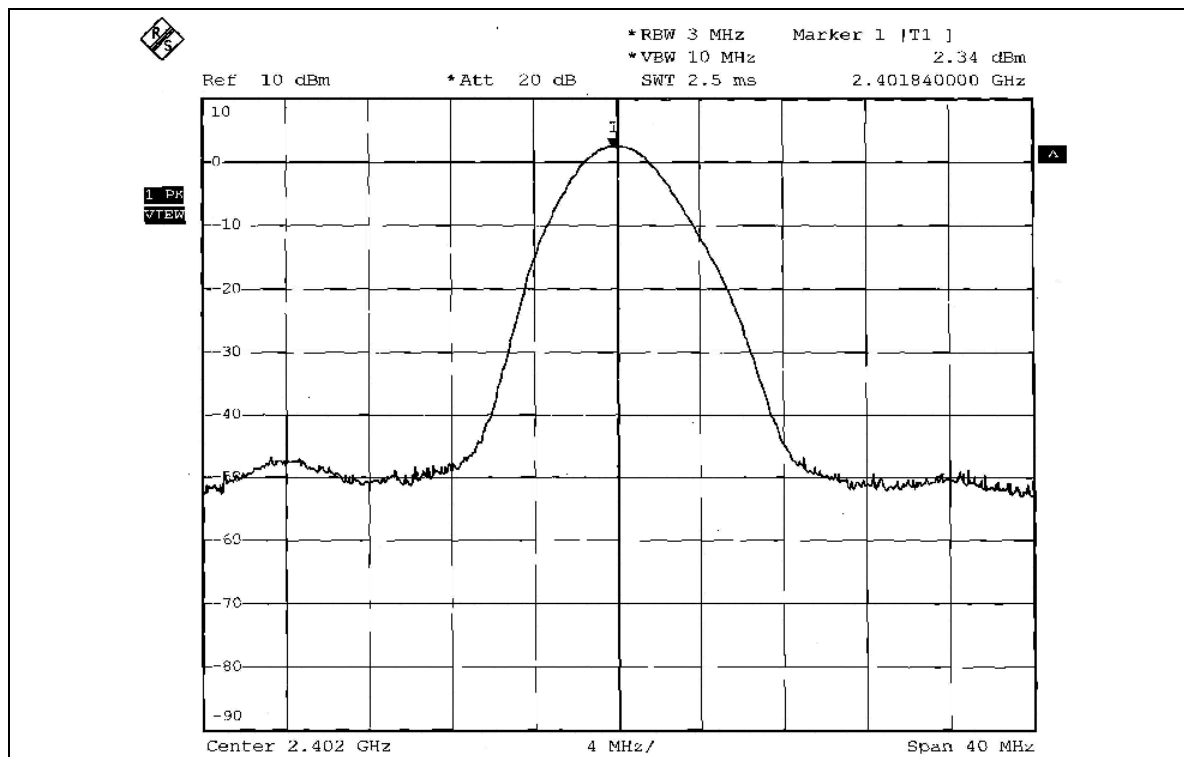

CH 39

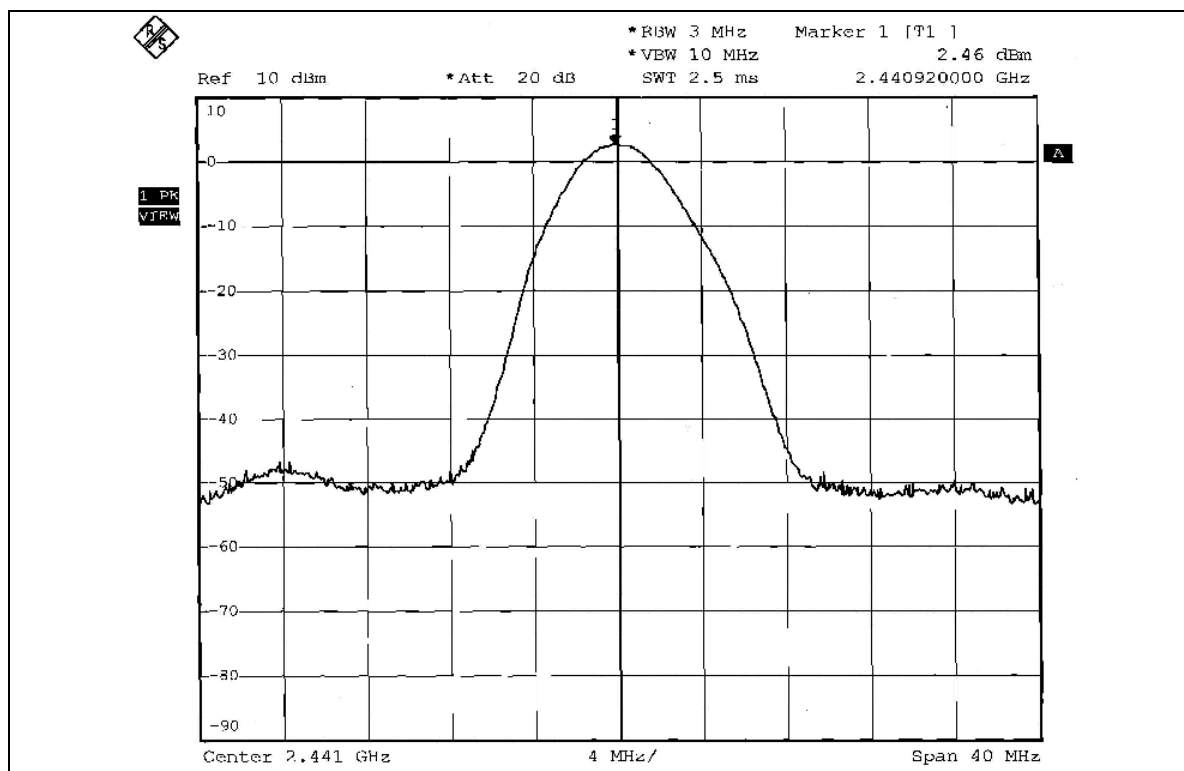

CH 78

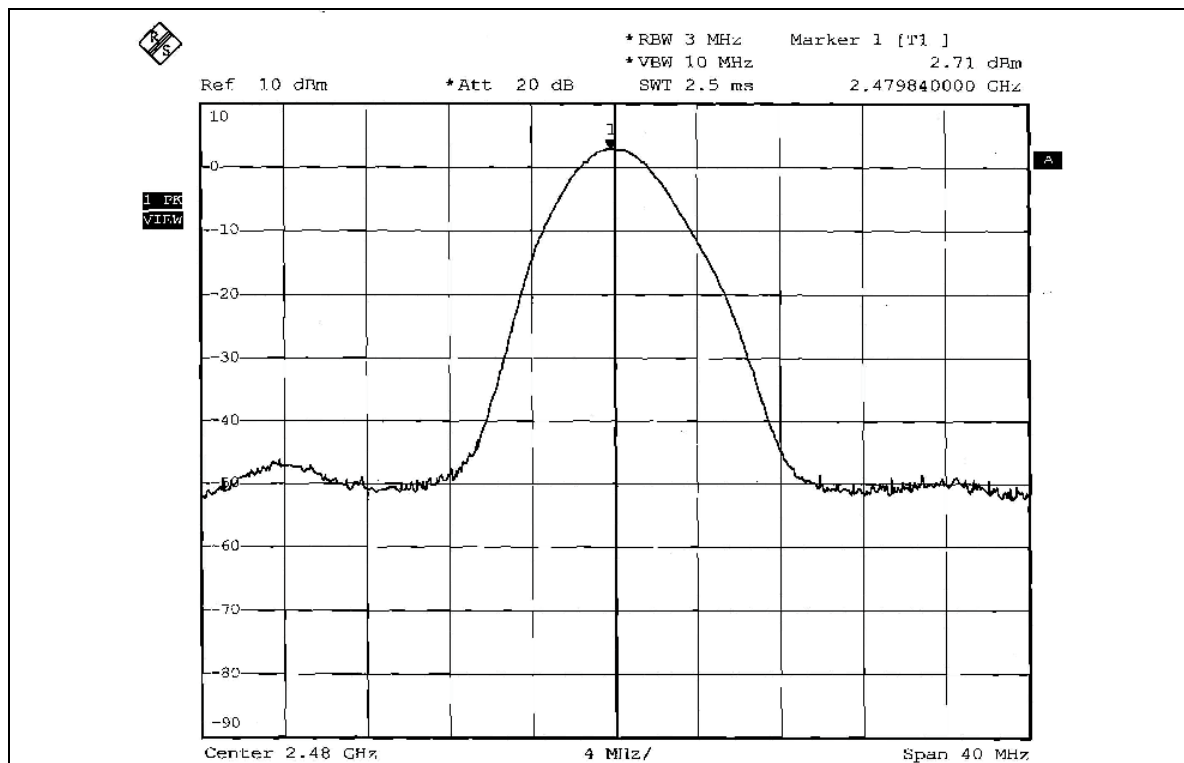

4.8 BAND EDGES MEASUREMENT

4.8.1 LIMITS OF BAND EDGES MEASUREMENT

Below –20dB of the highest emission level of operating band (in 100KHz RBW).

4.8.2 TEST INSTRUMENTS

DESCRIPTION & MANUFACTURER	MODEL NO.	SERIAL NO.	CALIBRATED UNTIL
SPECTRUM ANALYZER	FSP 40	100036	Mar. 16. 2007

NOTES: The calibration interval of the above test instruments is 12 months. And the calibrations are traceable to NML/ROC and NIST/USA.

4.8.3 TEST PROCEDURE

The transmitter output was connected to the spectrum analyzer via a low lose cable. Set both RBW and VBW of spectrum analyzer to 100 kHz with suitable frequency span including 100 MHz bandwidth from band edge. The band edges was measured and recorded.

4.8.4 DEVIATION FROM TEST STANDARD

No deviation.

4.8.5 EUT OPERATING CONDITION

The software provided by client enabled the EUT to transmit and receive data at lowest, middle and highest channel frequencies individually.

4.8.6 TEST RESULTS

The spectrum plots are attached on the following 4 images. D1 line indicates the highest level, D2 line indicates the 20dB offset below D1. It shows compliance with the requirement in part 15.247(d).

FOR MODE A:

NOTE 1:

The band edge emission plot on page 60 shows 53.64dBc between carrier maximum power and local maximum emission in restrict band (2.3864GHz). The emission of carrier strength list in the test result of channel 0 at the item 4.2.7 is 102.61dBuV/m (Peak), so the maximum field strength in restrict band is $102.61 - 53.64 = 48.97$ dBuV/m, which is under 74 dBuV/m limit.

Average value = $48.97 - 30.00 = 18.97$ dBuV/m, which is under 54dBuV/m limit.

*The DH5 packet was the worse case duty cycle for a transmit dwell time on a channel, based upon bluetooth theory the transmitter is on $0.625 * 5$ per 296.25 ms per channel. Therefore, the duty cycle be equal to: $20\log(3.125/100) = -30$ dB.

Average value = peak reading - 30.00.

NOTE 2:

The band edge emission plot on page 61 shows 49.68dBc between carrier maximum power and local maximum emission in restrict band (2.4845GHz). The emission of carrier strength list in the test result of channel 78 at the item 4.2.7 is 100.18dBuV/m (Peak), so the maximum field strength in restrict band is $100.18 - 49.68 = 50.50$ dBuV/m, which is under 74 dBuV/m limit.

Average value = $50.50 - 30.00 = 20.50$ dBuV/m, which is under 54dBuV/m limit.

*The DH5 packet was the worse case duty cycle for a transmit dwell time on a channel, based upon bluetooth theory the transmitter is on $0.625 * 5$ per 296.25 ms per channel. Therefore, the duty cycle be equal to: $20\log(3.125/100) = -30$ dB.

Average value = peak reading - 30.00.

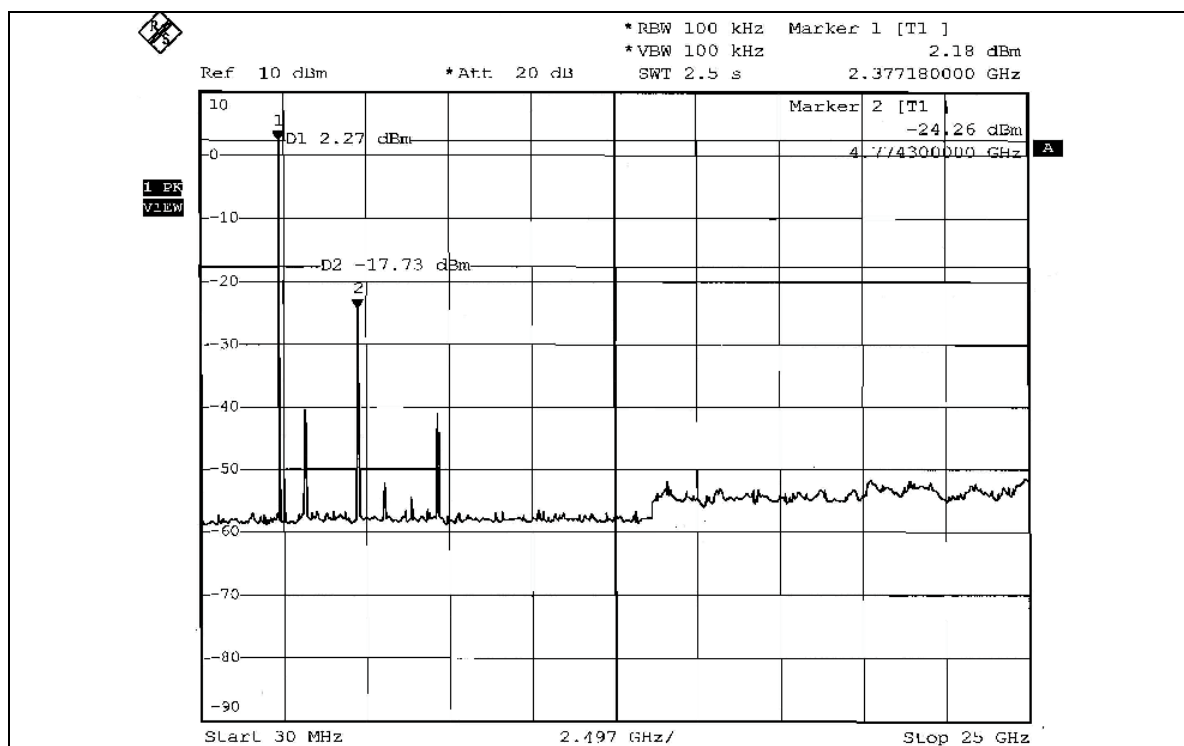
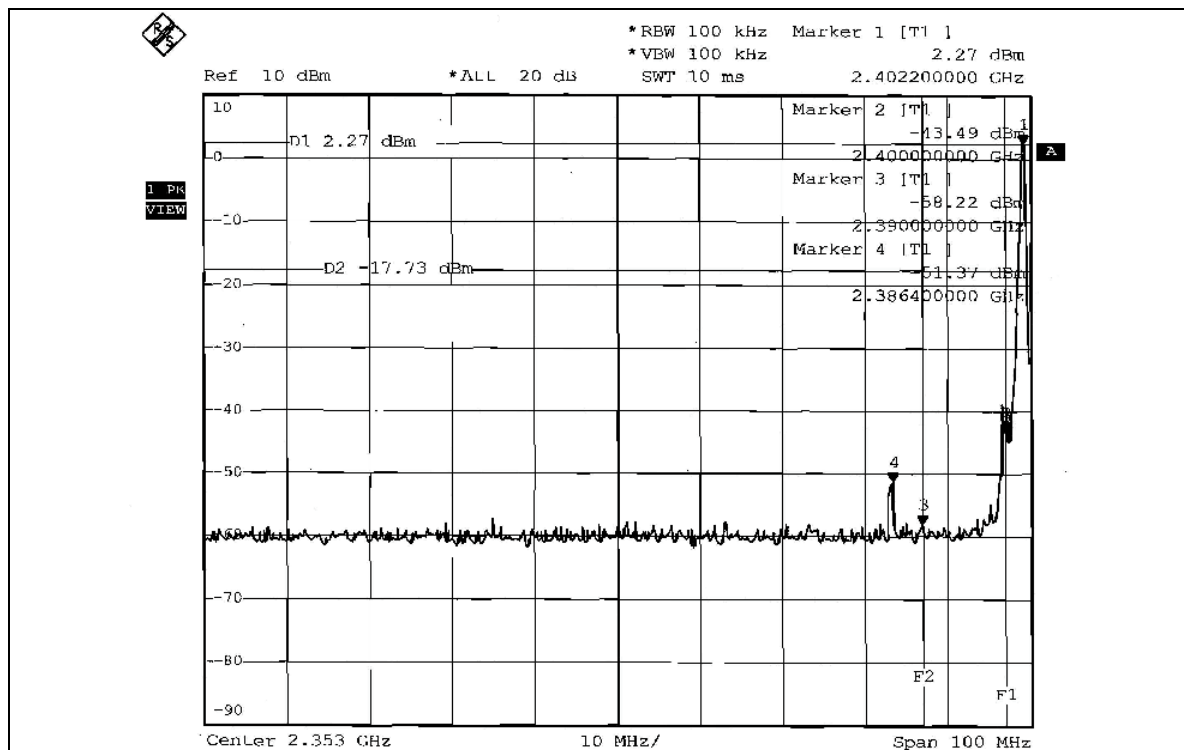

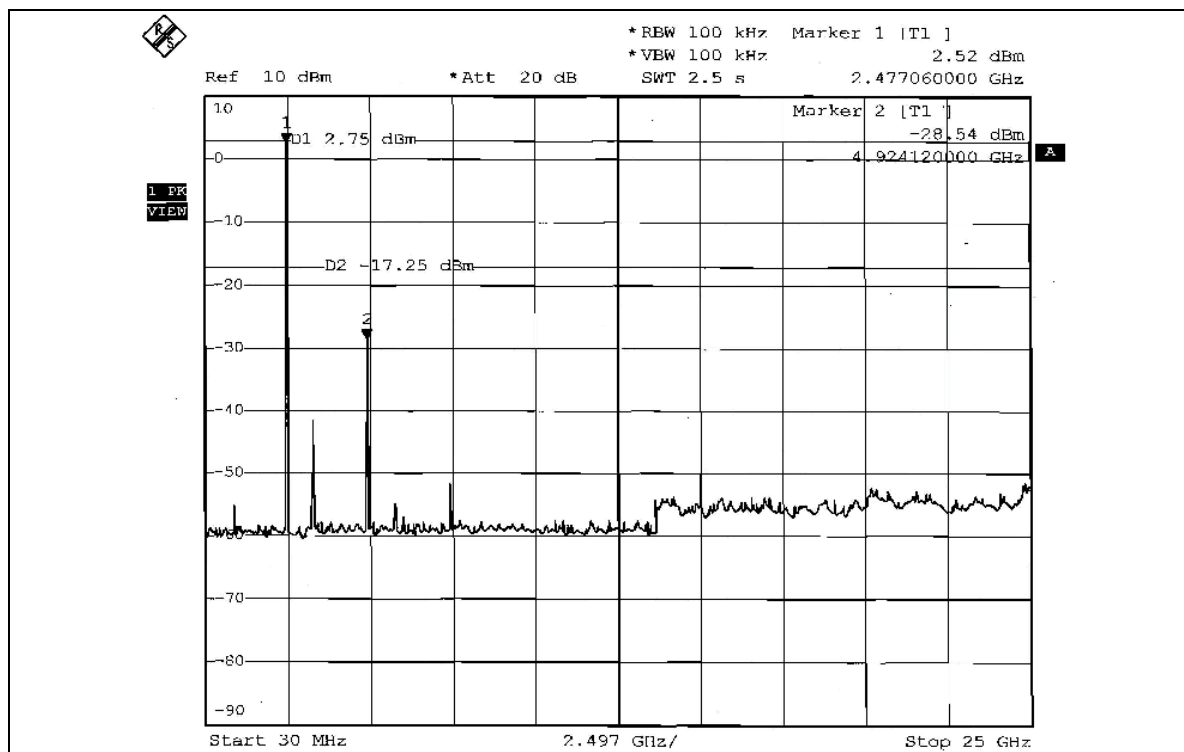
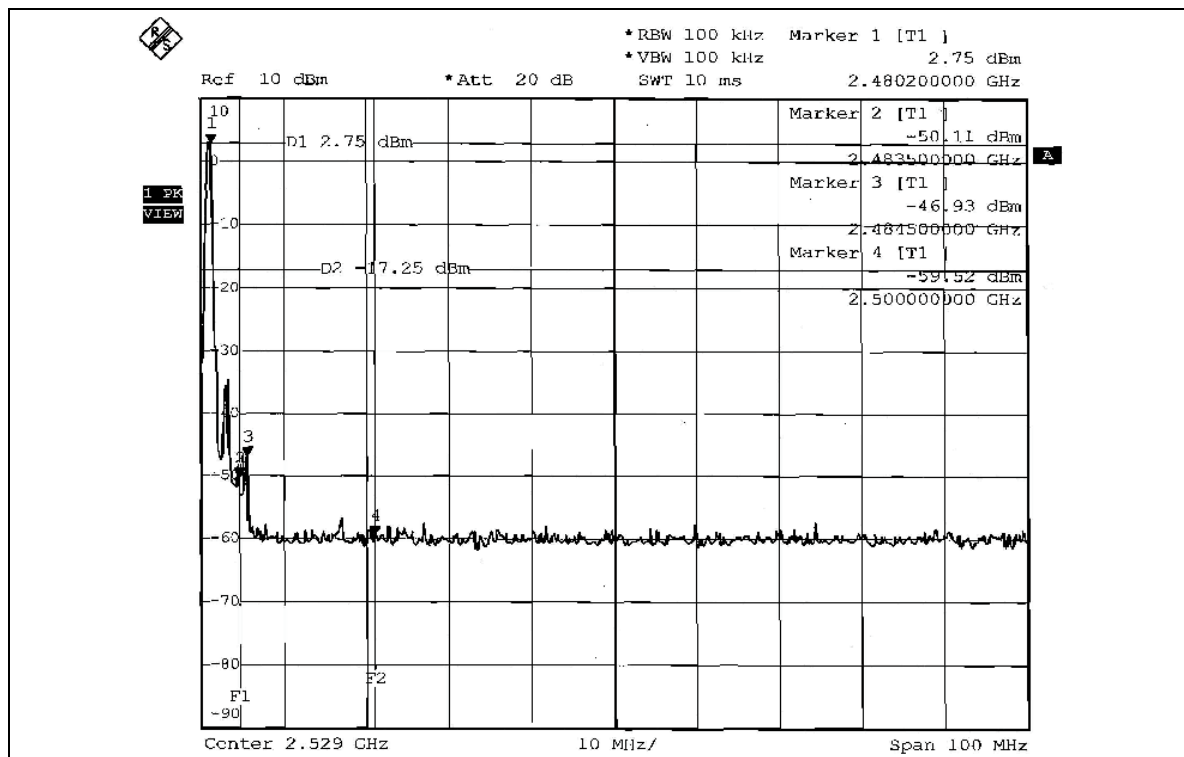

4.9 ANTENNA REQUIREMENT

4.9.1 STANDARD APPLICABLE

For intentional device, according to FCC 47 CFR Section 15.203, an intentional radiator shall be designed to ensure that no antenna other than that furnished by the responsible party shall be used with the device.

And according to FCC 47 CFR Section 15.247 (b), if transmitting antennas of directional gain greater than 6 dBi are used, the power shall be reduced by the amount in dB that the directional gain of the antenna exceeds 6 dBi.

4.9.2 ANTENNA CONNECTED CONSTRUCTION

The antenna used in this product is Inverted-F antenna without antenna connector. The maximum gain of this antenna is -1.95dBi .



5. INFORMATION ON THE TESTING LABORATORIES

We, ADT Corp., were founded in 1988 to provide our best service in EMC, Radio, Telecom and Safety consultation. Our laboratories are accredited and approved by the following approval agencies according to ISO/IEC 17025.

USA	FCC, UL, A2LA
Germany	TUV Rheinland
Japan	VCCI
Norway	NEMKO
Canada	INDUSTRY CANADA , CSA
R.O.C.	CNLA, BSMI, NCC
Netherlands	Telefication
Singapore	PSB , GOST-ASIA(MOU)
Russia	CERTIS(MOU)

Copies of accreditation certificates of our laboratories obtained from approval agencies can be downloaded from our web site:

www.adt.com.tw/index.5/phtml. If you have any comments, please feel free to contact us at the following:

Linko EMC/RF Lab:

Tel: 886-2-26052180

Fax: 886-2-26051924

Hsin Chu EMC/RF Lab:

Tel: 886-3-5935343

Fax: 886-3-5935342

Hwa Ya EMC/RF/Safety Telecom Lab:

Tel: 886-3-3183232

Fax: 886-3-3185050

Web Site: www.adt.com.tw

The address and road map of all our labs can be found in our web site also.



APPENDIX-A

MODIFICATIONS RECORDERS FOR ENGINEERING CHANGES TO THE EUT BY THE LAB

No any modifications are made to the EUT by the lab during the test.