

47 CFR FCC Part 15 Subpart C

Section 15.247

TEST REPORT

Product : Transceiver

Trade Name : N/A

Model Number : TRX17LORA

FCC ID : ELVATRRF

Prepared for

Nutek Corporation

No.167, Lane 235, Bauchiau Rd., Xindian District,
New Taipei City 23145, Taiwan

TEL. : +886 2 2918 9478

FAX. : +886 2 2917 9069

Prepared by

Interocean EMC Technology Corp.

Interocean EMC Technology Tin-Fu Laboratory

No. 5-2, Lin 1, Tin-Fu, Lin-Kou Dist., New Taipei City,
Taiwan 244, R.O.C.

TEL.: +886 2 2600 6861

FAX: +886 2 2600 6859



Remark:

The test report consists of **33** pages in total. It shall not be reproduced except in full, without the written approval of IETC. This document may be altered or revised by IETC only, and shall be noted in the revision section of the document.

The test result in this report is only subjected to the test sample.

Table of Contents

1	General Information	5
1.1	Description of Equipment Under Test	5
1.2	Details of tested peripheral equipment	6
1.3	Table for Carrier Frequencies	7
1.4	Test Facility	8
1.5	Test Equipment	9
1.6	Measurement Uncertainty	9
1.7	Summary of Measurement	10
1.8	Justification	10
2	Test Specifications	11
2.1	Test Standard	11
2.2	Test Step of EUT	11
3	RF Radiated Spurious Emission	12
3.1	Limit	12
3.2	Configuration of Measurement	12
3.3	Test Procedure	13
3.4	Test Result	13
4	RF Conducted Spurious Emission	17
4.1	Limit	17
4.2	Configuration of Measurement	17
4.3	Test Procedure	17
4.4	Test Result	17
5	Maximum Peak output power	20
5.1	Limit	20
5.2	Configuration of Measurement	20
5.3	Test Procedure	20
5.4	Test Result	20
6	6dB Bandwidth	22
6.1	Limit	22
6.2	Configuration of Measurement	22
6.3	Test Procedure	22
6.4	Test Result	22

7	Power Spectral Density	25
7.1	Limit	25
7.2	Configuration of Measurement	25
7.3	Test Procedure	25
7.4	Test Result	25
8	Photographs of Test	28
8.1	Radiated Emission Measurement	28
9	Photographs of EUT	30

Statement of Compliance

Applicant: Nutek Corporation
Manufacturer: Nutek Corporation
Product: Transceiver
Model No.: TRX17LORA
Tested Power Voltage: DC 5 V
Date of Final Test: Jul. 11, 2017
Revision of Report: Rev. 02

Configuration of Measurements and Standards Used :

FCC Rules and Regulations Part 15 Subpart C

I HEREBY CERTIFY THAT: The data shown in this report were made in accordance with the procedures given in ANSI C63.10, and the energy emitted by the device was founded to be within the limits applicable. I assume full responsibility for accuracy and completeness of these data.

- Note:** 1. The result of the testing report relate only to the item tested.
2. The testing report shall not be reproduced expect in full, without the written approval of IETC

Report Issued: 2017/08/09

Project Engineer: 
Elli Chang

Approved: 
Jerry Liu

1 General Information

1.1 Description of Equipment Under Test

Product	: Transceiver
Model Number	: TRX17LORA
Applicant	: Nutek Corporation No.167, Lane 235, Bauchiau Rd., Xindian District, New Taipei City 23145, Taiwan
Manufacturer	: Nutek Corporation No.167, Lane 235, Bauchiau Rd., Xindian District, New Taipei City 23145, Taiwan
Power Supply	: DC 5 V
Operating Frequency	: 909.6 MHz - 915.6 MHz
Channel Number	: 5 channels
Type of Modulation	: DSSS
Antenna description	: This device uses Helix Antenna. Antenna gain: 0 dBi. The antenna is integral to the device, thereby meeting the requirement of FCC 15.203.
Date of Test	: Jun. 09 ~ Jul. 11, 2017
Additional Description	: 1) The test model is “ TRX17LORA ” and included in this report. 2) For more detail specification about EUT, please refer to the user’s manual.

1.2 Details of tested peripheral equipment

N/A

1.3 Table for Carrier Frequencies

Channel	Frequency
0	909.6 MHz
1	911.1 MHz
2	912.6 MHz
3	914.1 MHz
4	915.6 MHz

1.4 Test Facility

- Site Description** : RF Test Room Chamber 3
- Name of Firm** : Interocean EMC Technology Corp.
- Company web** : <http://www.ietc.com.tw>
- Location** : No. 5-2, Lin 1, Tin-Fu, Lin-Kou Dist., New Taipei City, Taiwan 244, R.O.C.
- Site Filing** :
- Federal Communication Commissions – USA
Registration No.: 96399
Designation No.: TW1020 (Test Firm Registration #: 651092)
 - Industry Canada (IC)
OUR FILE: 46405-4437
Registration No. (OATS 1): Site# 4437A-1
Registration No. (OATS 3): Site# 4437A-3
Registration No. (Chamber 3): Site# 4437A-5
Registration No. (OATS 5): Site# 4437A-6
 - Voluntary Control Council for Interference by Information Technology Equipment (VCCI) – Japan
Member No.: 1349
Registration No. (Conducted Room): C-1094
Registration No. (Conducted Room): T-1562
Registration No. (OATS 1): R-1040; G-10274
- Site Accreditation** :
- Bureau of Standards and Metrology and Inspection (BSMI) – Taiwan, R.O.C.
Accreditation No.:
SL2-IN-E-0026 for CNS 13438 / CISPR 22
SL2-R1-E-0026 for CNS 13439 / CISPR 13
SL2-R2-E-0026 for CNS 13439 / CISPR 13
SL2-L1-E-0026 for CNS 14115 / CISPR 15
 - Taiwan Accreditation Foundation (TAF)
Accreditation No.: 1113
 - Vehicle Safety Certification Center (VSCC)
Approval No.: TW16-11
 - TÜV NORD
Certificate No: TNTW0801R

1.5 Test Equipment

Instrument	Manufacturer	Model	Serial No.	Next Cal. Date
EMI Test Receiver	R&S	ESI7	830154/002	2017/09/07
Pre-Amplifier	Burgeon	BPA-530	100216	2017/09/11
Spectrum Analyzer	R&S	FSP40	100478	2018/06/19
Biconical Antenna	Schwarzbeck	VHA 9103 & BBA 9106	VHA 9103-2418	2017/07/13
Log Antenna	Schwarzbeck	UHALP 9108-A	9108-A 0739	2017/07/13
Horn Antenna	Schwarzbeck	BBHA9120	9120D-1051	2017/10/27
Pre-Amplifier	EMCI	EMC 051845	980110	2017/10/19
RF Cable	Jye Bao	A30N30-5005	CBL51	2017/08/02
RF Cable	Jye Bao	N30N30-5006	CBL53	2017/08/02
RF Cable	HARBOUR	27478LL142	CBL65	2017/08/02
ATTENUATOR	Fairview Calibr	SA18S5W-20	20#2	2018/06/22
Measurement Software	AUDIX-e3			

Note: The above equipments are within the valid calibration period.

1.6 Measurement Uncertainty

Item	Expended Uncertainty (k=2)
Conduction 1:	
Conducted Emission (9 kHz to 30 MHz)	2.98 dB
Chamber 3:	
Radiated Emission Test (30 MHz to 1 GHz)	4.86 dB
Radiated Emission Test (above 1 GHz)	5.12 dB
RF test:	
RF conducted measurement (9 kHz to 40 GHz)	2.92 dB

1.7 Summary of Measurement

Report Clause	Test Parameter	Reference Document CFR47 Part15	Results
3	RF Radiated spurious emission	§15.205, 15.209	PASS
4	RF Conducted spurious emission	§15.247(d)	PASS
5	Maximum Peak output power	§15.247(b)	PASS
6	6dB Bandwidth	§15.247(a)(2)	PASS
7	Power spectral density	§15.247(e)	PASS
	AC Power Line Conducted Emission	§15.207	N/A

1.8 Justification

The test of radiated measurements according to FCC Part15 Section 15.33(a) had been conducted and the field strength of the frequency band were all arrive limit requirement, thus we evaluate the EUT pass the specified test.

2 Test Specifications

2.1 Test Standard

The EUT was performed according to FCC Part 15 Subpart C Section 15.247 procedure and setup followed by ANSI C63.10, 2013 requirements.

2.2 Test Step of EUT

- 2.2.1 Setup the fixture to EUT for power supplying.
- 2.2.2 Turn on the power of all equipment.
- 2.2.3 Let the EUT continuous transmission. Executed the test.

3 RF Radiated Spurious Emission

3.1 Limit

For intentional radiator, the radiated emission shall comply with FCC Part 15.209(a).

For intentional radiators, according to FCC Part 15.247 (a), operation under this provision is limited to frequency hopping and direct sequence spread spectrum, and the out band emission shall be comply with FCC Part 15.247 (c)

Frequency (MHz)	Field strength dB(μ V/m)	Measurement distance (meters)
1.705 ~ 30.0	29.5	30
30 ~ 88	40	3
88 ~ 216	43.5	3
216 ~ 960	46	3
Above 960	54	3

3.2 Configuration of Measurement

Measurement Frequency under 1 GHz

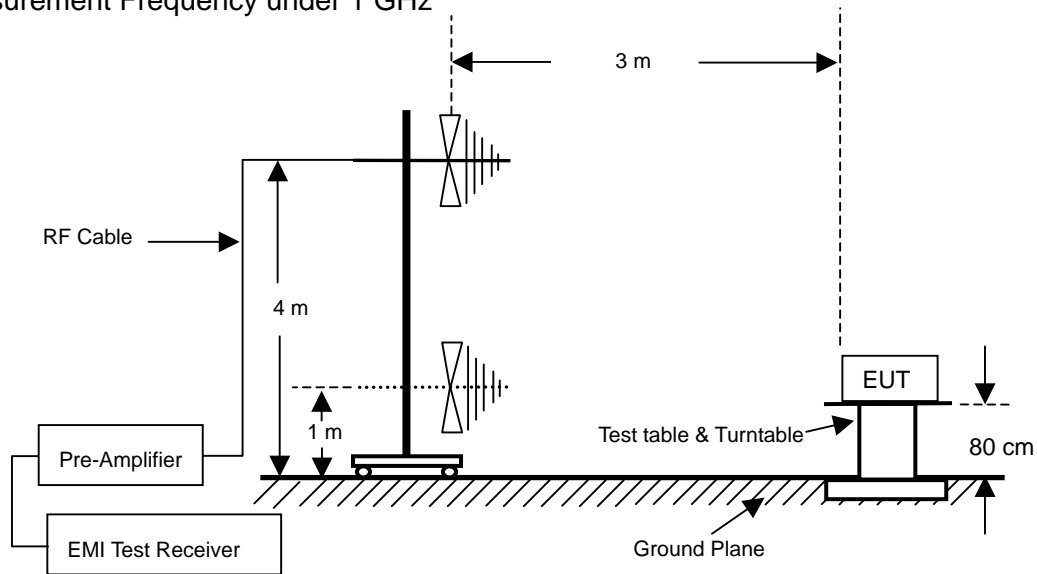

Measurement Frequency above 1 GHz

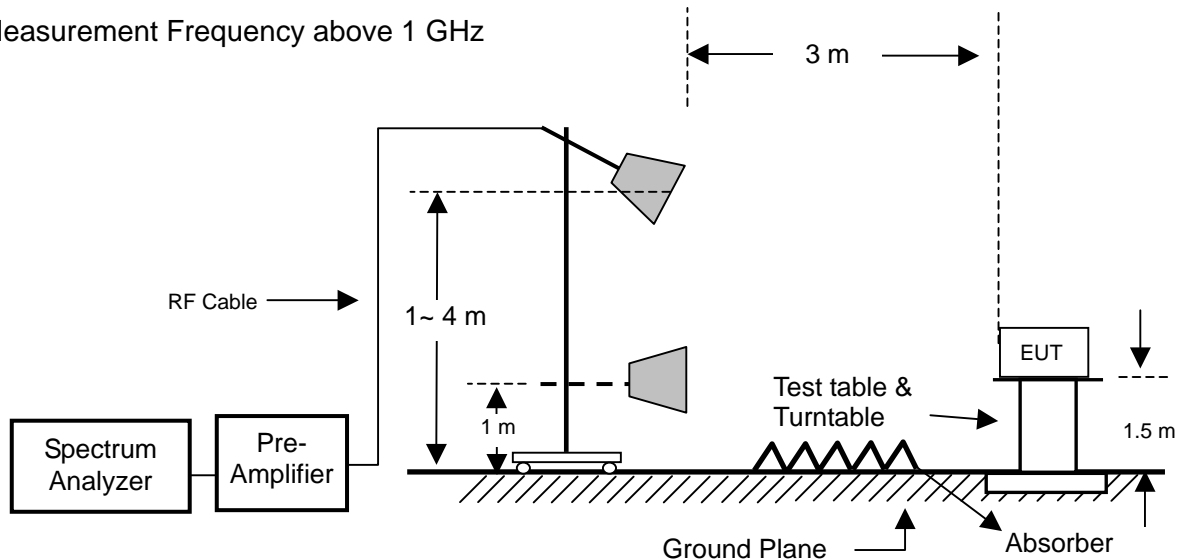

3.3 Test Procedure

The EUT was setup to ANSI C63.10, 2013; tested procedure of Jan. 2016 KDB558074 D01 for compliance to FCC 47CFR 15.247 requirements.

Radiated emission measurements were performed from 9kHz to 10GHz. Spectrum Analyzer set as below: For frequency range from 9kHz to 30MHz RBW=9kHz; 30MHz to 1GHz: RBW=100kHz or greater. For frequencies above 1GHz: set RBW=VBW=1MHz for peak detector and RBW=1MHz, VBW=10Hz for average detector.

The EUT for testing is arranged on a wooden turntable. If some peripherals apply to the EUT, the peripherals will be connected to EUT and the whole system. During the test, all cables were arranged to produce worst-case emissions. The signal is maximized through rotation. The height of antenna and polarization is changing constantly for exploring for maximum signal level. The height of antenna can be up to 4 meter and down to 1 meter.

3.4 Test Result

PASS.

The final test data is shown as following pages.

Radiated Emission Below 1 GHz

Frequency	Antenna	Reading	Preamp	Correction Factor	Corrected Level	Limits	Margin	Det
(MHz)	Polarization	(dBuV)	(dB)	(dB/m)	(dBuV/m)	(dBuV/m)	(dB)	Mode
135.68	H	36.56	31.38	15.58	20.76	43.52	-22.76	PK
203.40	H	34.34	31.21	18.62	21.75	43.52	-21.77	PK
289.74	H	33.29	31.33	21.62	23.58	46.02	-22.44	PK
331.26	H	38.13	31.32	17.63	24.44	46.02	-21.58	PK
397.64	H	36.93	31.28	19.88	25.53	46.02	-20.49	PK
463.57	H	36.69	31.31	20.92	26.30	46.02	-19.72	PK
78.90	V	42.49	31.57	7.47	18.39	40.00	-21.61	PK
167.28	V	36.08	31.28	16.42	21.22	43.52	-22.30	PK
238.91	V	37.22	31.26	19.81	25.77	46.02	-20.25	PK
341.69	V	39.28	31.31	17.84	25.81	46.02	-20.21	PK
390.30	V	36.65	31.29	19.59	24.95	46.02	-21.07	PK
492.33	V	37.07	31.32	21.08	26.83	46.02	-19.19	PK

Remark : Corrected Level = Reading + Correction Factor - Preamp
 Correction Fcator = Antenna Factor + Cable Loss
 Margin = Correction Factor - Limits
 * Mark indicated background noise level.

The frequency range from 9 kHz to 30 MHz was pre-scanned and the results was 20 dB lower than the limit line which according to FCC 15.31(o) needs not be recorded.

Radiated Emission Above 1 GHz

CH00 (909.6 MHz)

Frequency	Antenna	Reading	Preamp	Correction Factor	Corrected Level	Limits	Margin	Det
(MHz)	Polarization	(dBuV)	(dB)	(dB/m)	(dBuV/m)	(dBuV/m)	(dB)	Mode
1819.20	H	66.65	51.64	32.29	47.30	54	-6.70	PK
2728.80	H	71.89	51.75	35.29	55.43	74	-18.57	PK
2728.80	H	68.93	51.75	35.29	52.47	54	-1.53	AV
3638.40	H	66.29	51.90	37.11	51.50	54	-2.50	PK
4548.00	H	61.86	52.01	39.91	49.76	54	-4.24	PK
5457.60	H	69.18	52.19	41.70	58.69	74	-15.31	PK
5457.60	H	62.15	52.19	41.70	51.66	54	-2.34	AV
6367.20	H	58.60	52.25	44.62	50.97	54	-3.03	PK
7276.80	H	66.04	52.43	47.67	61.28	74	-12.72	PK
7276.80	H	54.91	52.43	47.67	50.15	54	-3.85	AV
8186.40	H	62.90	52.36	49.96	60.50	74	-13.50	PK
8186.40	H	51.21	52.36	49.96	48.81	54	-5.19	AV
9096.00	H	53.23	52.42	51.56	52.37	54	-1.63	PK
1819.20	V	64.23	51.64	32.29	44.88	54	-9.12	PK
2728.80	V	71.82	51.75	35.29	55.36	74	-18.64	PK
2728.80	V	68.75	51.75	35.29	52.29	54	-1.71	AV
3638.40	V	66.15	51.90	37.11	51.36	54	-2.64	PK
4548.00	V	61.41	52.01	39.91	49.31	54	-4.69	PK
5457.60	V	67.91	52.19	41.70	57.42	74	-16.58	PK
5457.60	V	58.76	52.19	41.70	48.27	54	-5.73	AV
6367.20	V	59.27	52.25	44.62	51.64	54	-2.36	PK
7276.80	V	61.48	52.43	47.67	56.72	74	-17.28	PK
7276.80	V	50.26	52.43	47.67	45.50	54	-8.50	AV
8186.40	V	54.80	52.36	49.96	52.40	54	-1.60	PK
9096.00	V	53.22	52.42	51.56	52.36	54	-1.64	PK

Remark : Corrected Level = Reading + Correction Factor – Preamp

Correction Fcator = Antenna Factor + Cable Loss

Margin = Correction Factor - Limits

* Mark indicated background noise level.

CH4 (915.6 MHz)

Frequency	Antenna	Reading	Preamp	Correction Factor	Corrected Level	Limits	Margin	Det
(MHz)	Polarization	(dBuV)	(dB)	(dB/m)	(dBuV/m)	(dBuV/m)	(dB)	Mode
1831.20	H	67.95	51.63	32.33	48.65	54	-5.35	PK
2746.80	H	71.82	51.75	35.34	55.41	74	-18.59	PK
2746.80	H	68.81	51.75	35.34	52.40	54	-1.60	AV
3662.40	H	67.18	51.90	37.17	52.45	54	-1.55	PK
4578.00	H	61.20	52.02	39.99	49.17	54	-4.83	PK
5493.60	H	70.54	52.20	41.76	60.10	74	-13.90	PK
5493.60	H	61.91	52.20	41.76	51.47	54	-2.53	AV
6409.20	H	58.78	52.26	44.81	51.33	54	-2.67	PK
7324.80	H	66.76	52.41	47.83	62.18	74	-11.82	PK
7324.80	H	55.78	52.41	47.83	51.20	54	-2.80	AV
8240.40	H	61.54	52.35	50.02	59.21	74	-14.79	PK
8240.40	H	48.97	52.35	50.02	46.64	54	-7.36	AV
9156.00	H	53.09	52.43	51.67	52.33	54	-1.67	PK
1831.20	V	64.59	51.63	32.33	45.29	54	-8.71	PK
2746.80	V	72.02	51.75	35.34	55.61	74	-18.39	PK
2746.80	V	69.03	51.75	35.34	52.62	54	-1.38	AV
3662.40	V	66.86	51.90	37.17	52.13	54	-1.87	PK
4578.00	V	62.29	52.02	39.99	50.26	54	-3.74	PK
5493.60	V	67.02	52.20	41.76	56.58	74	-17.42	PK
5493.60	V	57.47	52.20	41.76	47.03	54	-6.97	AV
6409.20	V	58.02	52.26	44.81	50.57	54	-3.43	PK
7324.80	V	61.83	52.41	47.83	57.25	74	-16.75	PK
7324.80	V	50.96	52.41	47.83	46.38	54	-7.62	AV
8240.40	V	54.58	52.35	50.02	52.25	54	-1.75	PK
9156.00	V	52.97	52.43	51.67	52.21	54	-1.79	PK

Remark : Corrected Level = Reading + Correction Factor – Preamp

Correction Fcator = Antenna Factor + Cable Loss

Margin = Correction Factor - Limits

* Mark indicated background noise level.

4 RF Conducted Spurious Emission

4.1 Limit

According to FCC Part 15.247(d) requirement :

In any 100 kHz bandwidth outside the frequency band in which the spread spectrum or digitally modulated intentional radiator is operating, the radio frequency power that is produced by the intentional radiator shall be at least 20 dB below that in the 100 kHz bandwidth within the band that contains the highest level of the desired power, based on either an RF conducted or a radiated measurement, provided the transmitter demonstrates compliance with the peak conducted power limits.

4.2 Configuration of Measurement

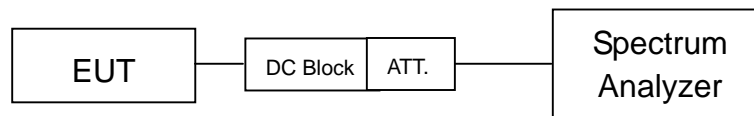

4.3 Test Procedure

The EUT was setup to ANSI C63.10, 2013; tested procedure of Jan. 2016 KDB558074 D01 for compliance to FCC 47CFR 15.247 requirements.

The measurements were performed from 9 kHz to 10 GHz RF antenna conducted per FCC 15.247 (c) was measured from the EUT antenna port using a 50ohm spectrum analyzer with the resolution bandwidth set at 100 kHz, and the video bandwidth set \geq RBW.

Harmonics and spurious noise must be at least 20dB down from the highest emission level within the authorized band as measured with a 100 kHz RBW. The table below is the results from the highest emission for each channel within the authorized band. This table was used to determine the spurious limit for each channel.

4.4 Test Result

PASS.

The final test data is shown as following pages.

Remark: The frequency range from 9 kHz to 30 MHz was pre-scanned and the results was 20 dB lower than the limit line which according to FCC 15.31(o) needs not be recorded.

Conducted Spurious Emission

909.6 MHz (30 M ~ 1 GHz)

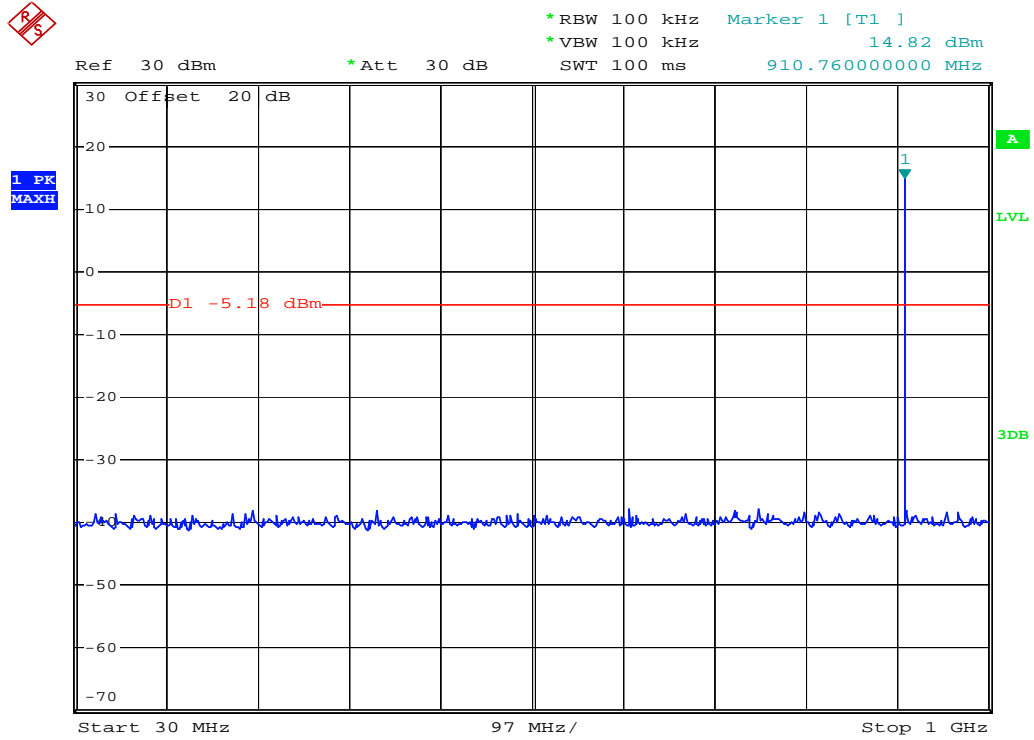

909.6 MHz (1 G ~ 10 GHz)

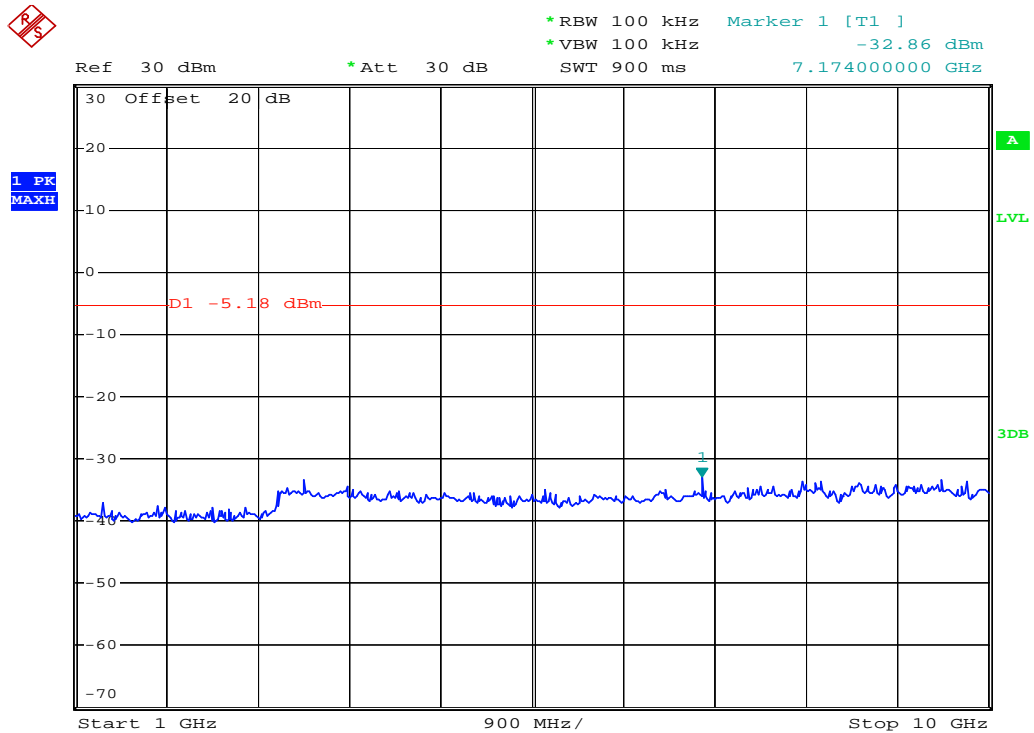

915.6 MHz (30 M ~ 1 GHz)

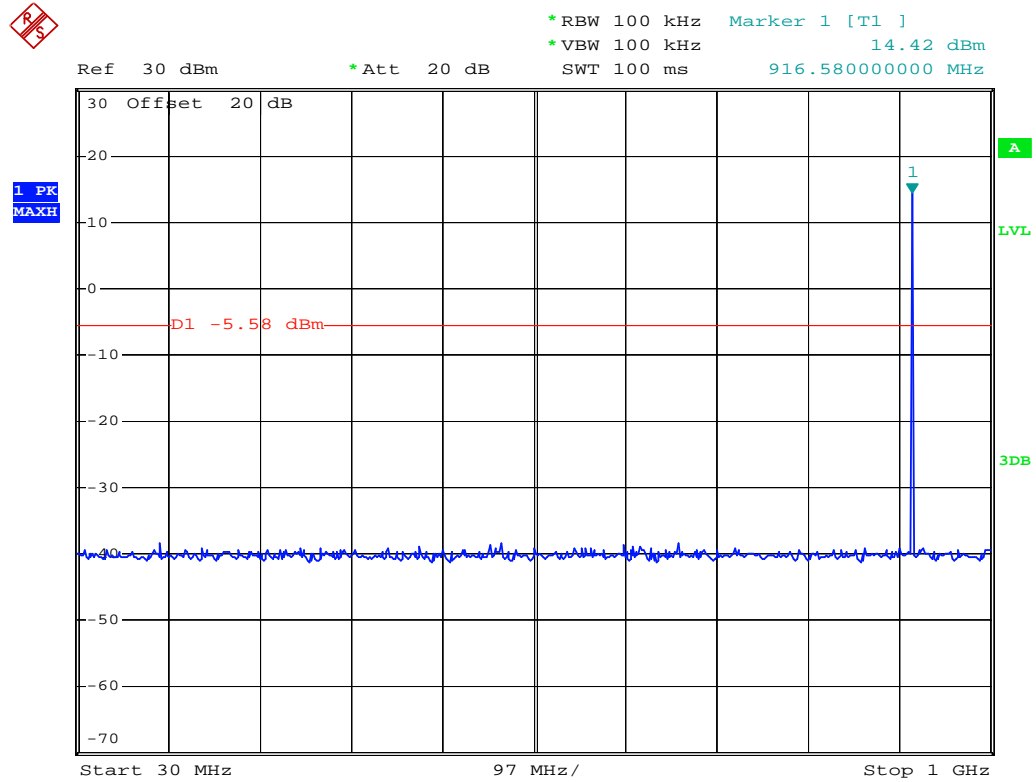

915.6 MHz (1 G ~ 10 GHz)

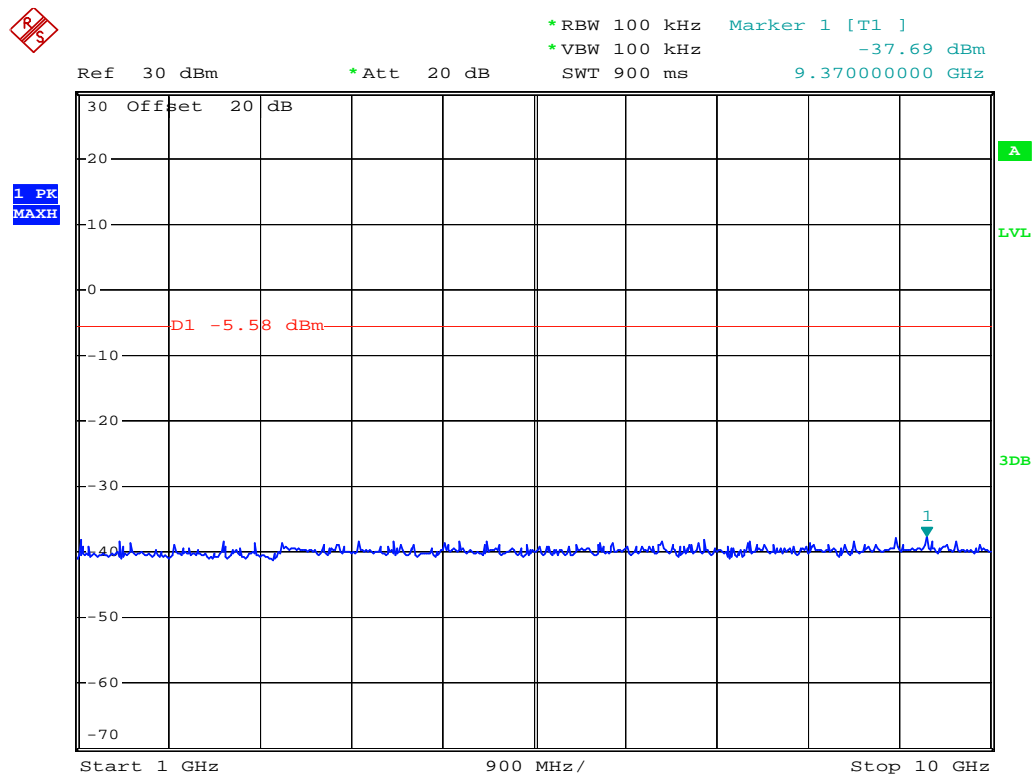

5 Maximum Peak output power

5.1 Limit

For frequency hopping systems operating in the 2400-2483.5MHz band employing at least 75 non-overlapping hopping channels, and all frequency hopping systems in the 5725-5850MHz band: 1 watt.

Frequency hopping systems operating in the 2400-2483.5 MHz band may have hopping channel carrier frequencies that are separated by 25kHz or two-thirds of the 20dB bandwidth of the hopping channel, whichever is greater, provided the systems operate with an output power no greater than 125mW.

For all other frequency hopping systems in the 2400-2483.5MHz band: 0.125 watts.

For systems using digital modulation in the 2400–2483.5 MHz bands: The maximum conducted output power shall be less than 1Watt.

5.2 Configuration of Measurement

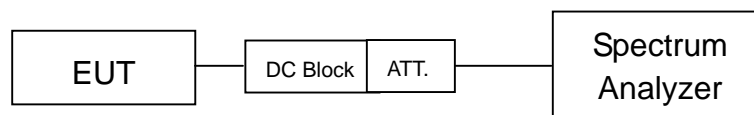

5.3 Test Procedure

The EUT was setup to ANSI C63.10, 2013; tested procedure of Jan. 2016 KDB558074 D01 for compliance to FCC 47CFR 15.247 requirements.

For FCC §15.247(b) the power output was measured on the EUT using a 50 ohm SMA cable connected to Spectrum Analyzer. Peak output power was read directly from Spectrum Analyzer.

Set :

1. $RBW \geq DTS \text{ bandwidth}$, $VBW \geq 3 \times RBW$
2. $Span \geq 3 \times RBW$
3. Detector = peak, trace mode = max hold
4. All trace to fully stabilize
5. Use peak marker function to determine the peak amplitude

5.4 Test Result

PASS.

The final test data is shown as following table.

Maximum Peak Power

Test CH		Maximum Peak Power		Limit (dBm)	Margin (dB)
CH No.	Freq. (MHz)	dBm	Watts		
0	909.6	14.80	0.03020	30	-15.20
4	915.6	14.40	0.02754	30	-15.60

909.6 MHz Maximum Peak Power

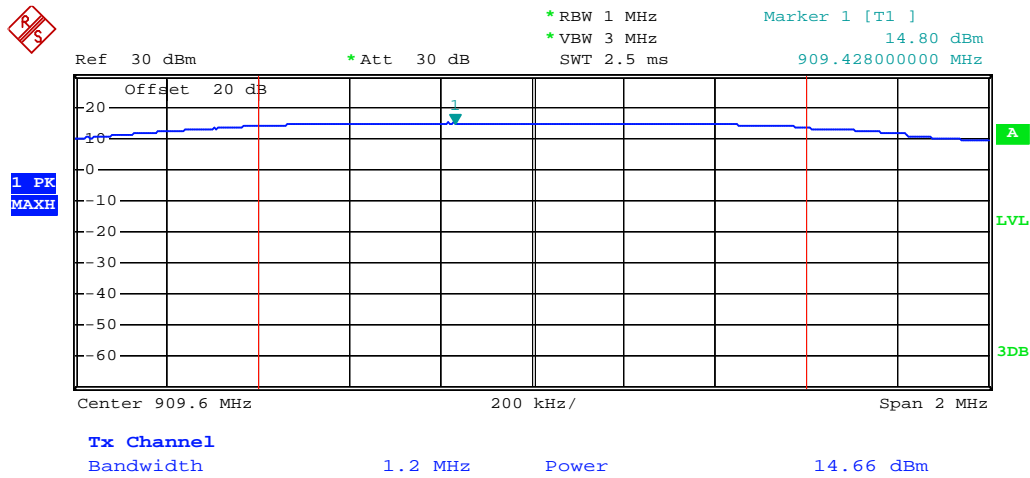

915.6 MHz Maximum Peak Power

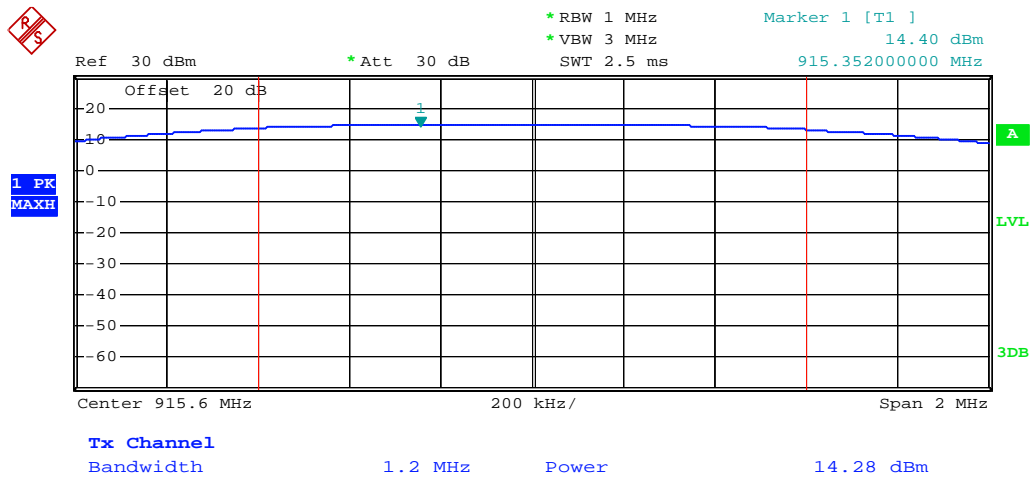

6 6dB Bandwidth

6.1 Limit

According to FCC Part 15.247 (a)(2) requirement :

Systems using digital modulation techniques may operate in the 2400–2483.5 MHz, The minimum 6dB bandwidth shall be at least 500 kHz.

6.2 Configuration of Measurement

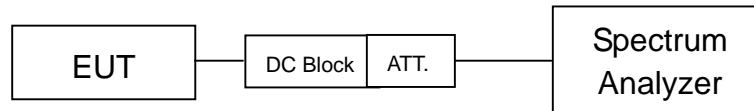

6.3 Test Procedure

The EUT was setup to ANSI C63.10, 2013; tested procedure of Jan. 2016 KDB558074 D01 for compliance to FCC 47 CFR 15.247 requirements.

The minimum 6dB bandwidth was measured using a 50 ohm spectrum analyzer.

- 1) RBW = 30kHz
- 2) VBW \geq 3 x RBW
- 3) Detector = Peak
- 4) Trace mode = Max hold
- 5) Sweep = auto couple
- 6) All trace to fully stabilize
- 7) Measure the maximum width of the emission that is constrained by the frequencies associated with the two outermost amplitude points (upper and lower frequencies) that are attenuated by 6dB relative to the maximum level measured in the fundamental emission.

6.4 Test Result

PASS.

The final test data is shown on as following pages.

6dB Bandwidth

Test CH		6dB Bandwidth (kHz)	Limit (kHz)	Result
CH No.	Freq. (MHz)			
0	909.6	608.00	>500	Pass
4	915.6	612.00	>500	Pass

909.6 MHz 6dB Bandwidth

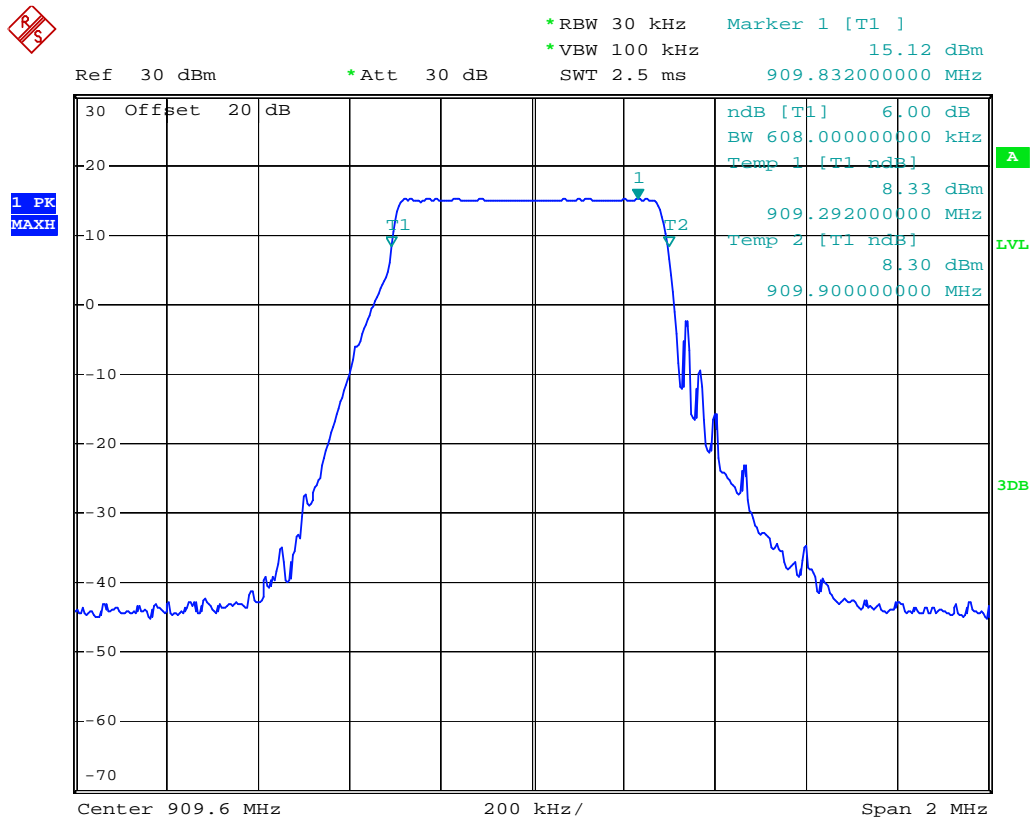

915.6 MHz 6dB Bandwidth



*RBW 30 kHz Marker 1 [T1]
*VBW 100 kHz 14.75 dBm
SWT 2.5 ms 915.392000000 MHz

Ref 30 dBm

*Att 30 dB

1 PK
MAXH

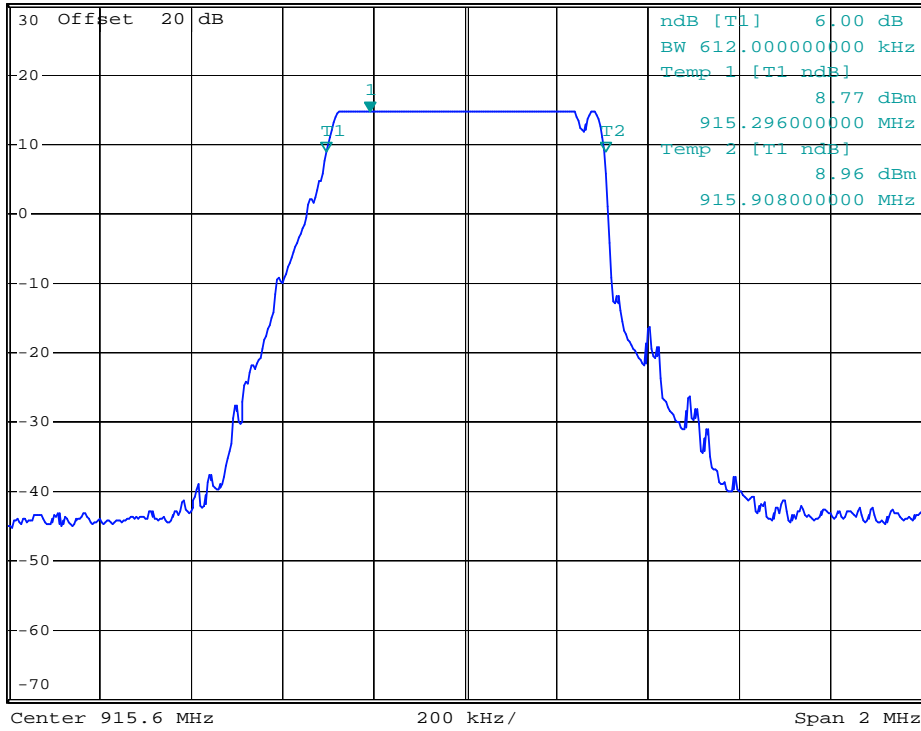

7 Power Spectral Density

7.1 Limit

According to FCC Part15.247 (e) requirement :

For digitally modulated systems, the power spectral density conducted from the intentional radiator to the antenna shall not be greater than 8 dBm in any 3 kHz band during any time interval of continuous transmission.

7.2 Configuration of Measurement

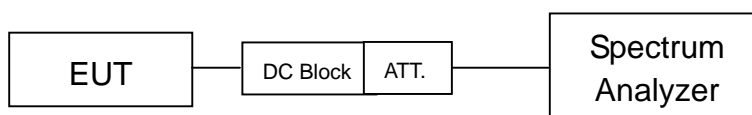

7.3 Test Procedure

The EUT was setup to ANSI C63.10, 2013; tested procedure of Jan. 2016 KDB558074 D01 for compliance to FCC 47CFR 15.247 requirements.

Set::

- 1) Analyzer center frequency to DTS channel center frequency
- 2) The span ≥ 1.5 times the DTS bandwidth
- 3) RBW: $3\text{kHz} \leq \text{RBW} \leq 100\text{kHz}$
- 4) VBW $\geq 3 \times \text{RBW}$
- 5) Detector = Peak
- 6) Trace mode = Max hold
- 7) Sweep = auto couple
- 8) All trace to fully stabilize
- 9) Use the peak marker function to determine the maximum amplitude level within the RBW
- 10) If measured value exceeds limit, reduce RBW (no less than 3kHz) and repeat.

7.4 Test Result

PASS.

The final test data is shown on as following pages.

Power Spectral Density

Test CH		PSD (dBm/3kHz)	Limit (dBm/3kHz)	Result
CH No.	Freq. (MHz)			
0	909.6	5.80	8	PASS
4	915.6	5.56	8	PASS

909.6 MHz Power Spectral Density

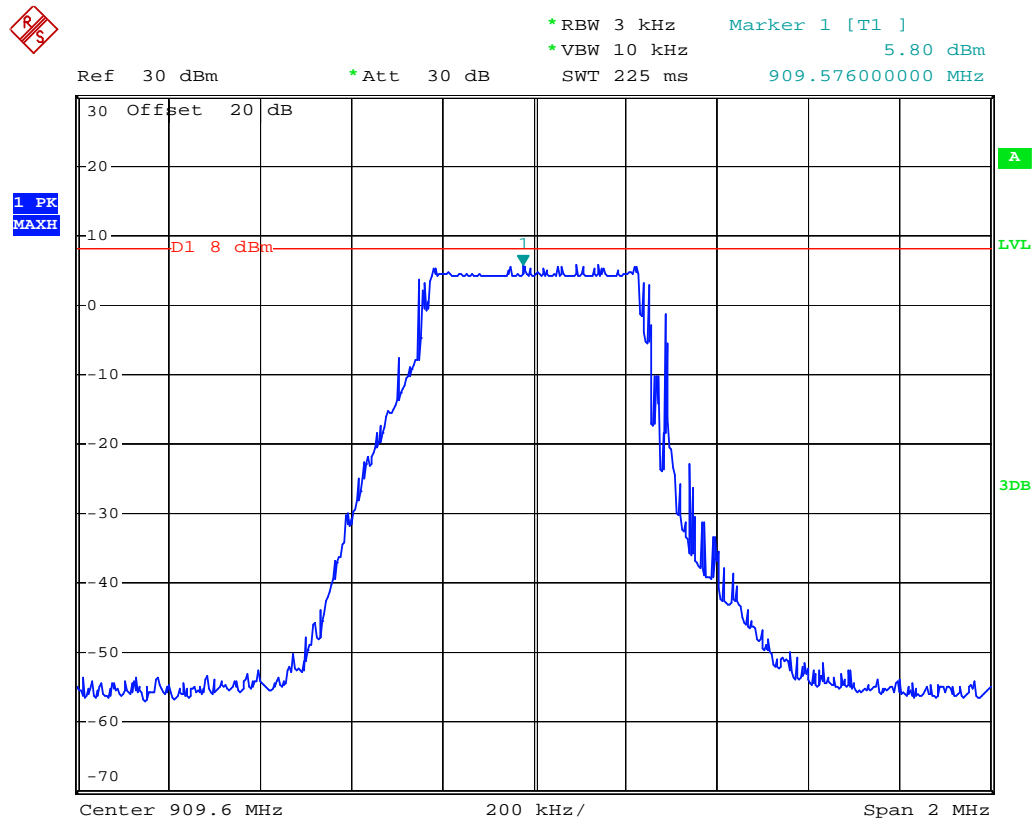

915.6 MHz Power Spectral Density

