

CFR 47 FCC Part 15.247

TEST REPORT

Product : Transceiver
Trade Name : N/A
Model Number : TRX14SS
FCC ID : ELVATRNB

Prepared for

Nutek Corporation

NO. 167, Lane 235, Bauchiau Rd., Xindian District,
New Taipei City 23145, Taiwan

TEL. : +886 2 2918 9478

FAX. : +886 2 2917 9069

Prepared by

Interocean EMC Technology Corp.

No. 5-2, Lin 1, Tin-Fu, Lin-Kou Dist., New Taipei City,
Taiwan 244, R.O.C.

TEL.: +886 2 2600 6861

FAX.: +886 2 2600 6859

Remark :

The test report consists of **44** pages in total. It shall not be reproduced except in full, without the written approval of IETC. This document may be altered or revised by IETC only, and shall be noted in the revision section of the document.
The test result in the report is only subjected to the test sample.

Table of Contents

1	General Information	5
1.1	Description of Equipment Under Test	5
1.2	Table for Carrier Frequencies	6
1.3	Hopping Sequence	6
1.4	Details of Tested Supporting System	7
1.5	Test Facility	8
1.6	Test Equipment	9
1.7	Summary of Measurement	10
1.8	Justification	11
2	Test specifications	12
2.1	Test standard	12
2.2	Test Step of EUT	12
3	20dB Bandwidth test	13
3.1	Limit	13
3.2	Configuration of Measurement	13
3.3	Test Procedure	13
3.4	Test Result	13
4	Carrier Frequency Separation test	17
4.1	Limit	17
4.2	Configuration of Measurement	17
4.3	Test Procedure	17
4.4	Test Result	17
5	Number of hopping frequencies test	21
5.1	Configuration of Measurement	21
5.2	Test Procedure	21
5.3	Test Result	21
6	Time of Occupancy (dwell time) test	23
6.1	Limit	23
6.2	Configuration of Measurement	23
6.3	Test Procedure	23
6.4	Test Result	23
7	Maximum Output Power test	25
7.1	Limit	25
7.2	Configuration of Measurement	25
7.3	Test Procedure	25
7.4	Test Result	25

8	RF Conducted spurious emission	28
8.1	Limit	28
8.2	Configuration of Measurement	28
8.3	Test Procedure	28
8.4	Test Result	28
9	RF Radiated spurious emission test	32
9.1	Limit	32
9.2	Configuration of Measurement	32
9.3	Test Procedure	33
9.4	Test Result	33
10	Photographs of Test	38
10.1	Radiated Emission Measurement	38
11	Photographs of EUT	40

Statement of Compliance

Applicant: Nutek Corporation

Manufacturer: Nutek Corporation

Product: Transceiver

Model No.: TRX14SS

Tested Power Supply: 5Vdc battery

Date of Final Test: Aug. 15, 2014

Revision of Report: Rev. 00

Configuration of Measurements and Standards Used :

FCC Rules and Regulations Part 15 Subpart C

I HEREBY CERTIFY THAT: The data shown in this report were made in accordance with the procedures given in ANSI C63.4, and the energy emitted by the device was founded to be within the limits applicable. I assume full responsibility for accuracy and completeness of these data.

Note: 1. The result of the testing report relate only to the item tested.

2. The testing report shall not be reproduced expect in full, without the written approval of IETC

Report Issued: 2014/08/08

Project Engineer: 
Elli Chang

Approved: 
Jerry Liu

1 General Information

1.1 Description of Equipment Under Test

Product	: Transceiver
Model Number	: TRX14SS
Applicant	: Nutek Corporation NO. 167, Lane 235, Bauchiau Rd., Xindian District, New Taipei City 23145, Taiwan
Manufacturer	: Nutek Corporation NO. 167, Lane 235, Bauchiau Rd., Xindian District, New Taipei City 23145, Taiwan
Power Supply	: 5Vdc battery
Operating Frequency	: 909.6MHz ~ 918MHz
Channel Number	: 25 channels
Type of Modulation	: FSK
Antenna Description	: This device uses Helix antenna. Antenna gain 0dBi. The antenna is integral to the device, thereby meeting the requirement of FCC 15.203.
Date of Test	: Jul. 07 ~ Aug. 15, 2014
Additional Description	: 1) The Model Number " TRX14SS " is representative selected in the test and included in this report. 2) For more detail specification about EUT, please refer to the user's manual.

1.2 Table for Carrier Frequencies

	FC (MHz)		FC (MHz)		FC (MHz)
CH0	909.6000	CH9	912.7500	CH18	915.9000
CH1	909.9500	CH10	913.1000	CH19	916.2500
CH2	910.3000	CH11	913.4500	CH20	916.6000
CH3	910.6500	CH12	913.8000	CH21	916.9500
CH4	911.0000	CH13	914.1500	CH22	917.3000
CH5	911.3500	CH14	914.5000	CH23	917.6500
CH6	911.7000	CH15	914.8500	CH24	918.0000
CH7	912.0500	CH16	915.2000		
CH8	912.4000	CH17	915.5500		

1.3 Hopping Sequence

12, 8, 6, 2, 0, 5, 1, 7, 3, 9, 4, 10, 15, 19, 13, 11, 16, 18, 14, 20, 22, 21, 24, 23,17

1.4 Details of Tested Supporting System

1.4.1 DC Source

DC018

Model Number : HLG-60H-48A

Serial Number : RB27017098

Manufacturer : MEAN WELL

Output : 48V DC, 1.3A

Input : 100-240VAC 0.64A 50/60Hz

EMC Compliance : CE

1.5 Test Facility

- Site Description** : ☒OATS 1 ☒RF Test Room
- Name of Firm** : Interocean EMC Technology Corp.
- Company web** : <http://www.ietc.com.tw>
- Location** : No. 5-2, Lin 1, Tin-Fu, Lin-Kou Dist., New Taipei City, Taiwan 244, R.O.C.
- Site Filing** :
- Federal Communication Commissions – USA
Registration No.: 96399 (OATS 1, 2, 3 & Chamber 3)
Designation No.: TW1020
 - Industry Canada (IC)
OUR FILE: 46405-4437
Registration No. (OATS 1): Site# 4437A-1
Registration No. (OATS 3): Site# 4437A-3
Registration No. (Chamber 3): Site# 4437A-5
Registration No. (OATS 5): Site# 4437A-6
 - Voluntary Control Council for Interference by Information Technology Equipment (VCCI) – Japan
Member No.: 1349
Registration No. (Conducted Room): C-1094
Registration No. (Conducted Room): T-1562
Registration No. (OATS 1): R-1040; G-274
Registration No. (OATS 2): R-1041
- Site Accreditation** :
- Bureau of Standards and Metrology and Inspection (BSMI) – Taiwan, R.O.C.
Accreditation No.:
SL2-IN-E-0026 for CNS13438 / CISPR 22
SL2-IN-E-0026 for CNS14757-2 / IEC 62040-2
SL2-R1-E-0026 for CNS13439 / CISPR 13
SL2-R2-E-0026 for CNS13439 / CISPR 13
SL2-A1-E-0026 for CNS13783-1 / CISPR 14-1
SL2-L1-E-0026 for CNS 14115 / CISPR 15
 - Taiwan Accreditation Foundation (TAF)
Accreditation No.: 1113
 - Vehicle Safety Certification Center (VSCC)
Approval No.: TW16-11-0
 - TÜV NORD
Certificate No: TNTW0801R-04
 - Nemko
Authorisation No: AeLA 011
Authorisation No: ELA 181

1.6 Test Equipment

Instrument	Manufacturer	Model	Serial No.	Next Cal. Date
Spectrum Analyzer	R&S	FSP40	100478	2015/06/02
Preamplifier	Agilent	8449B	3008A01434	2015/05/07
Preamplifier	Agilent	83050A	3950A00225	2014/09/08
Horn Antenna	Schwarzbeck	BBHA 9120	9120D-583	2015/05/13
Horn Antenna	Schwarzbeck	BBHA 9170	213	2015/07/24
Cable	HARBOUR	27478LL142	CBL22	2015/01/01
EMI Test Receiver	Rohde & Schwarz	ESVS10	826148/011	2014/11/04
Biconical Antenna	Schwarzbeck	BBA 9106	VHA 9103-2418	2015/01/18
Log Antenna	Schwarzbeck	UHALP 9108 A	0738	2015/01/18
Pre-Amplifier	Agilent	8447D	2944A09703	2015/04/29
RF Cable	EMCI	EMC8D-NM-NM-25000	140105	2015/02/16
RF Cable	Mini-Circuits	CBL-3FL-NMNM	CBL56	2014/08/30
RF Cable	Insulated Wire	CBL59	CBL59	2015/01/22

Note: The above equipments are within the valid calibration period.

1.7 Summary of Measurement

Report Clause	Test Parameter	Reference Document CFR47 Part15	Results
3	20dB Bandwidth test	§15.247(a)(1)	Pass
4	Carrier Frequency Separation test	§15.247(a)(1)	Pass
5	Number of hopping frequencies test	§15.247(a)(1)	Pass
6	Time of Occupancy (dwell time) test	§15.247(a)(1)	Pass
7	Maximum Peak output power test	§15.247(b)	Pass
8	RF Conducted spurious emission	§15.247(c)	Pass
9	RF Radiated spurious emission test	§15.205, 15.209	Pass
	Emission on the Band Edge test	§15.247(d)	Not Applicable
	AC Power Line Conducted Emission test	§15.207	Not Applicable

1.8 Justification

The test of radiated measurements according to FCC Part15 Section 15.33(a) had been conducted and the field strength of the frequency band were all arrive limit requirement, thus we evaluate the EUT pass the specified test.

2 Test specifications

2.1 Test standard

The EUT was performed according to FCC Part 15 Subpart C Section 15.247 procedure and setup followed by ANSI C63.4, 2003 requirements.

2.2 Test Step of EUT

- 2.2.1 Setup the fixture to EUT for power supplying.
- 2.2.2 Turn on the power of all equipment.
- 2.2.3 Let the EUT continuous transmission. Executed the test.

3 20dB Bandwidth test

3.1 Limit

For frequency hopping systems operating in the 902–928 MHz band: if the 20 dB bandwidth of the hopping channel is less than 250 kHz, the system shall use at least 50 hopping frequencies and the average time of occupancy on any frequency shall not be greater than 0.4 seconds within a 20 second period; if the 20 dB bandwidth of the hopping channel is 250 kHz or greater, the system shall use at least 25 hopping frequencies and the average time of occupancy on any frequency shall not be greater than 0.4 seconds within a 10 second period. The maximum allowed 20 dB bandwidth of the hopping channel is 500 kHz.

3.2 Configuration of Measurement

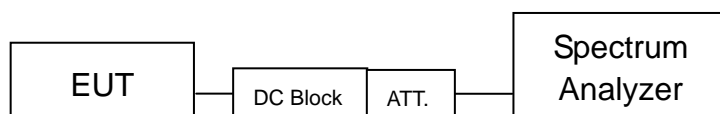

3.3 Test Procedure

The EUT was setup to ANSI C63.4, 2003; tested to FHSS test procedure of FCC Public Notice DA 00-705 for compliance to FCC 47CFR 15.247 requirements.

The 20dB bandwidth per FCC §15.247(a)(1) was measured using a 50 ohm spectrum analyzer with the resolutions bandwidth set at 10 kHz, the video bandwidth \geq RBW, and the SPAN may equal to approximately 2 to 3 time the 20dB bandwidth.

3.4 Test Result

PASS.

The final test data is shown as following pages.

20dB bandwidth

Test CH		20dB Bandwidth (kHz)	Limit (kHz)	Result
CH No.	Freq. (MHz)			
0	909.6	260.00	250 - 500	PASS
12	913.8	260.00	250 - 500	PASS
24	918.0	260.00	250 - 500	PASS

CH0 909.6MHz

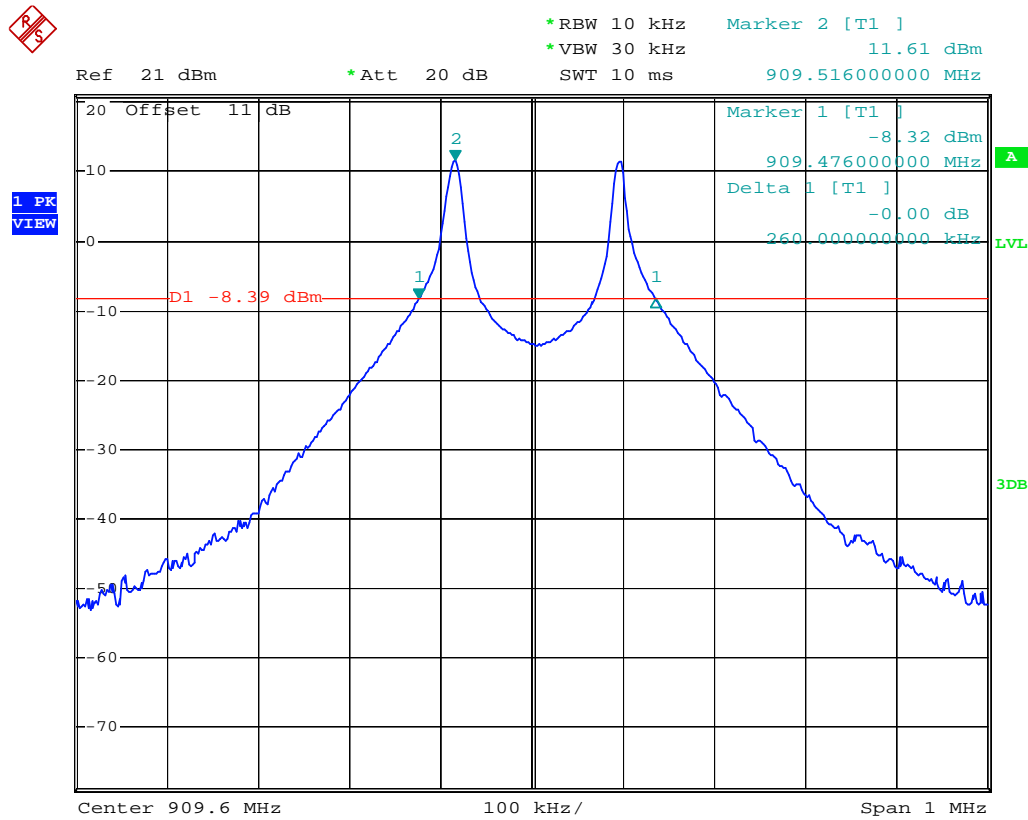

CH12 913.8MHz



Ref 21 dBm *Att 20 dB *RBW 10 kHz Marker 2 [T1] 11.59 dBm
*VBW 30 kHz 913.716000000 MHz
SWT 10 ms

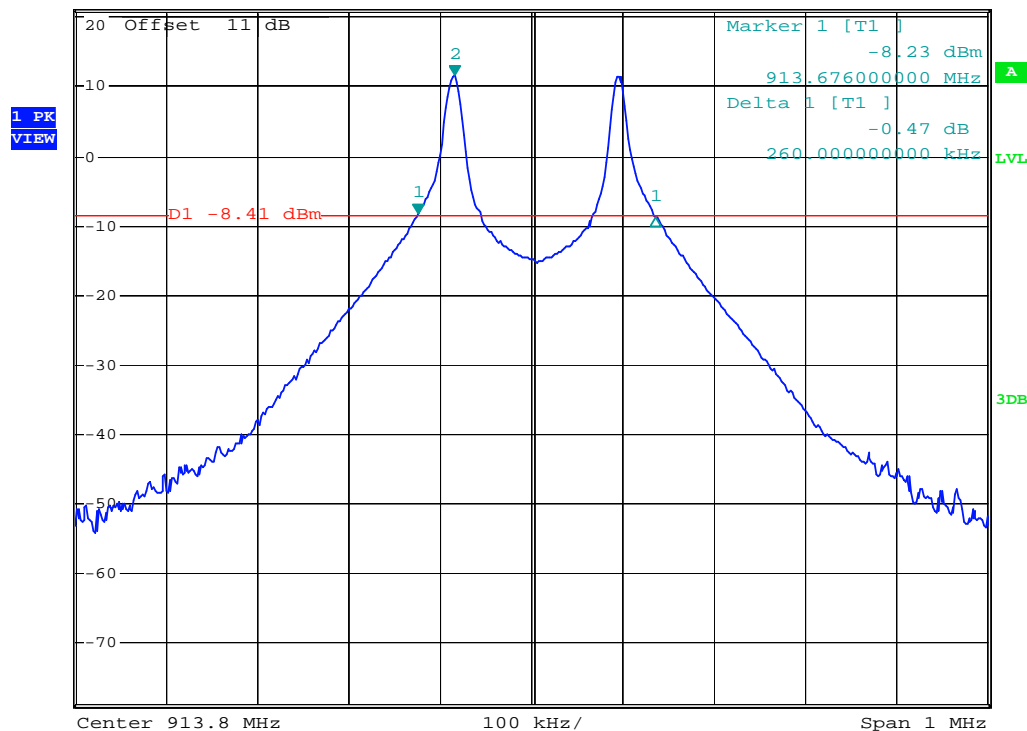

CH24 918.0MHz



Ref 21 dBm *Att 20 dB *RBW 10 kHz Marker 2 [T1] 11.54 dBm
*VBW 30 kHz 917.916000000 MHz
SWT 10 ms

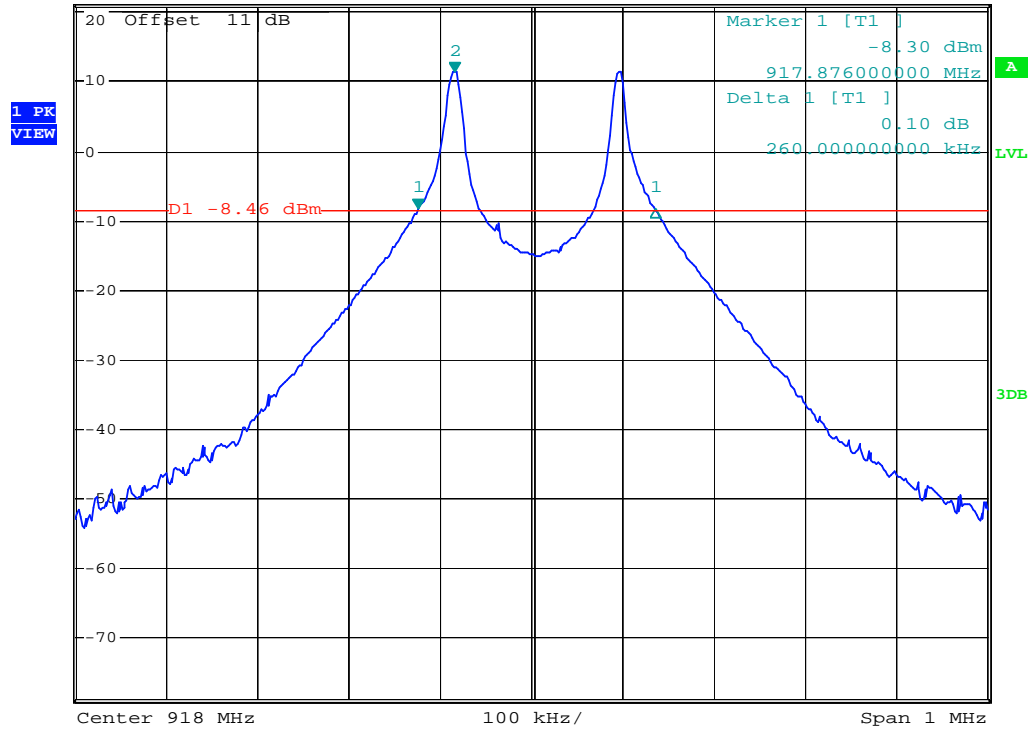

4 Carrier Frequency Separation test

4.1 Limit

Frequency hopping systems shall have hopping channel carrier frequencies separated by a minimum of 25kHz or the 20dB bandwidth of the hopping channel, whichever is greater.

4.2 Configuration of Measurement

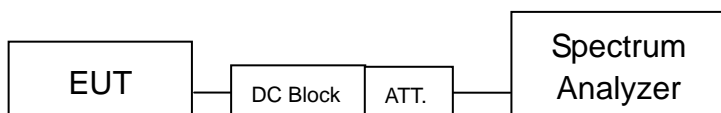

4.3 Test Procedure

The EUT was setup to ANSI C63.4, 2003; tested to FHSS test procedure of FCC Public Notice DA 00-705 for compliance to FCC 47CFR 15.247 requirements.

The carrier frequency separation per FCC Part15.247(a)(1) was measured using a 50 ohm spectrum analyzer with the resolutions bandwidth set at $\geq 1\%$ of the span, the video bandwidth \geq RBW, and the SPAN was wide enough to capture the peaks of two adjacent channels.

4.4 Test Result

PASS.

The final test data is shown as following pages.

Carrier Frequency Separation test

Modulation type	Frequency (MHz)	Separation (kHz)	Result
FSK	909.60-909.95	352.00	PASS
FSK	913.80-914.15	354.00	PASS
FSK	917.65-918.00	350.00	PASS

Channel Separation (909.6MHz)

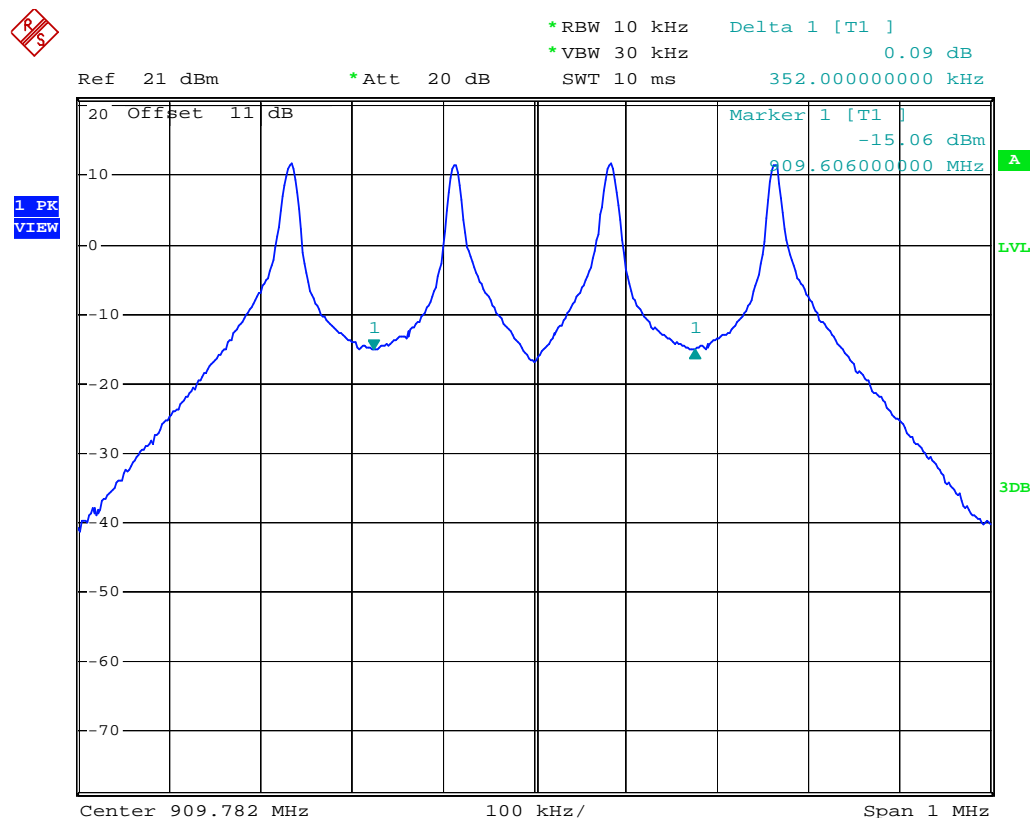

Channel Separation (913.8MHz)

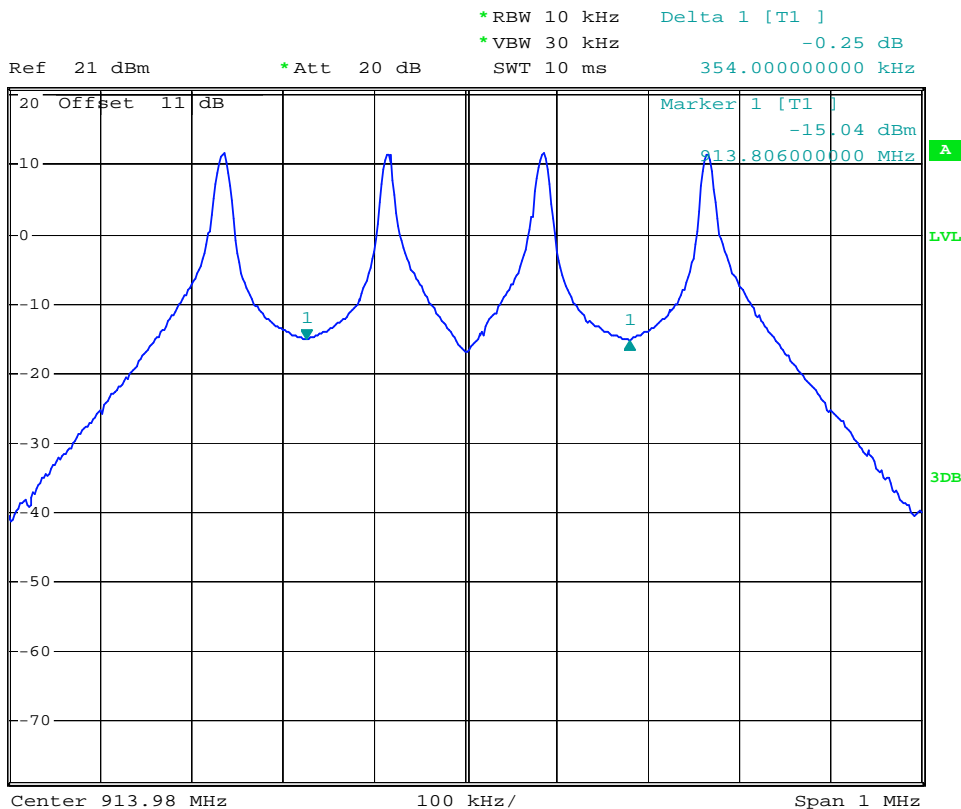

Channel Separation (918MHz)

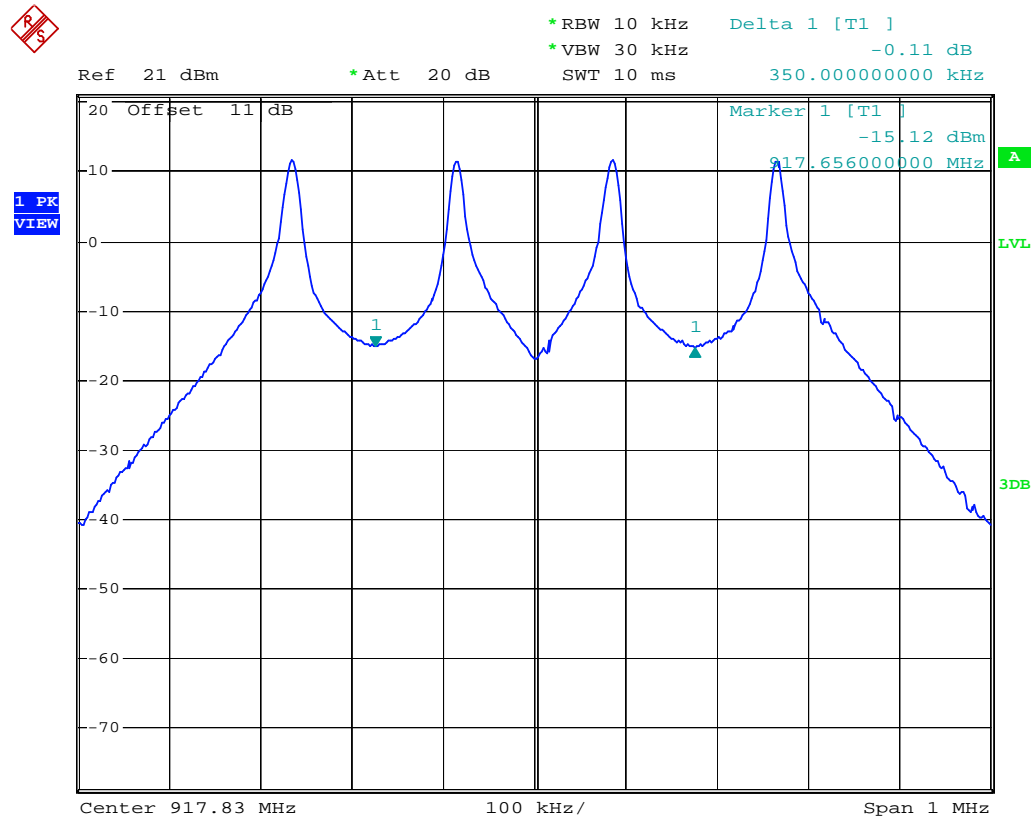

5 Number of hopping frequencies test

5.1 Configuration of Measurement

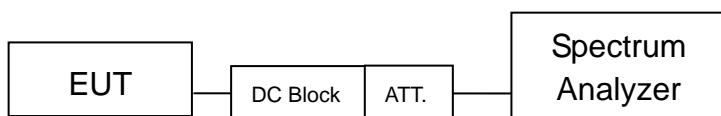

5.2 Test Procedure

The EUT was setup to ANSI C63.4, 2003; tested to FHSS test procedure of FCC Public Notice DA 00-705 for compliance to FCC 47CFR 15.247 requirements.

The number of hopping frequencies per FCC Part15.247(a)(1) was measured using a 50 ohm spectrum analyzer with the resolutions bandwidth set at $\geq 1\%$ of the span, the video bandwidth \geq RBW, and the SPAN was the frequency band of operation.

5.3 Test Result

PASS.

The final test data is shown as following pages.

Number of hopping frequencies test

Modulation	No. of Hopping CH.
FSK	25

Channel Number

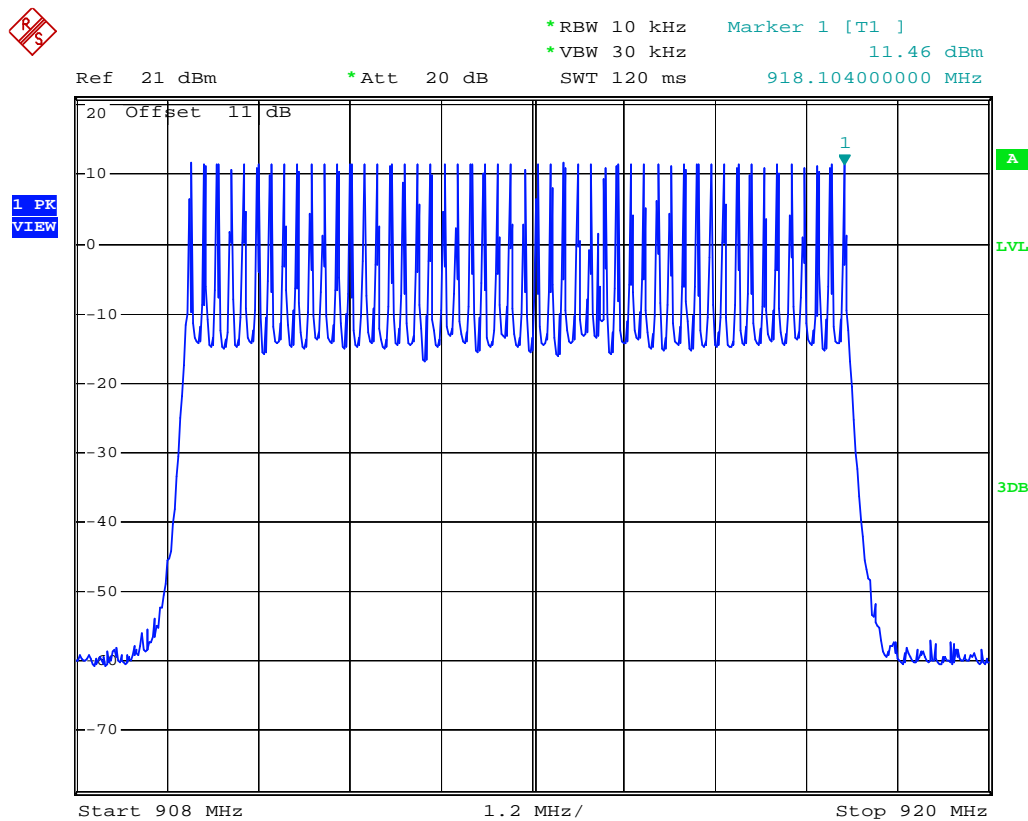

6 Time of Occupancy (dwell time) test

6.1 Limit

For frequency hopping systems operating in the 902–928 MHz band: if the 20 dB bandwidth of the hopping channel is less than 250 kHz, the system shall use at least 50 hopping frequencies and the average time of occupancy on any frequency shall not be greater than 0.4 seconds within a 20 second period; if the 20 dB bandwidth of the hopping channel is 250 kHz or greater, the system shall use at least 25 hopping frequencies and the average time of occupancy on any frequency shall not be greater than 0.4 seconds within a 10 second period. The maximum allowed 20 dB bandwidth of the hopping channel is 500 kHz.

6.2 Configuration of Measurement

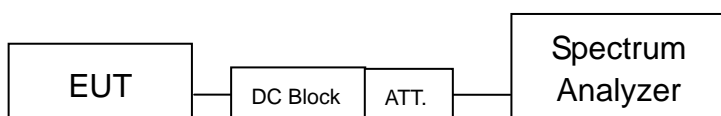

6.3 Test Procedure

The EUT was setup to ANSI C63.4, 2003; tested to FHSS test procedure of FCC Public Notice DA 00-705 for compliance to FCC 47CFR 15.247 requirements.

According to FCC Part15.247(a)(1) the time of occupancy (dwell time) was measured using a 50 ohm spectrum analyzer with the resolutions bandwidth set at 1MHz, the video bandwidth \geq RBW and the zero span function of spectrum analyzer was enable. The EUT has its hopping function enable.

6.4 Test Result

PASS.

The final test data is shown as following pages.

Time of Occupancy (dwell time) test

1 occurrences in 10 seconds x 391 ms = 391 ms which is less than 400 ms.

Dwell time-1

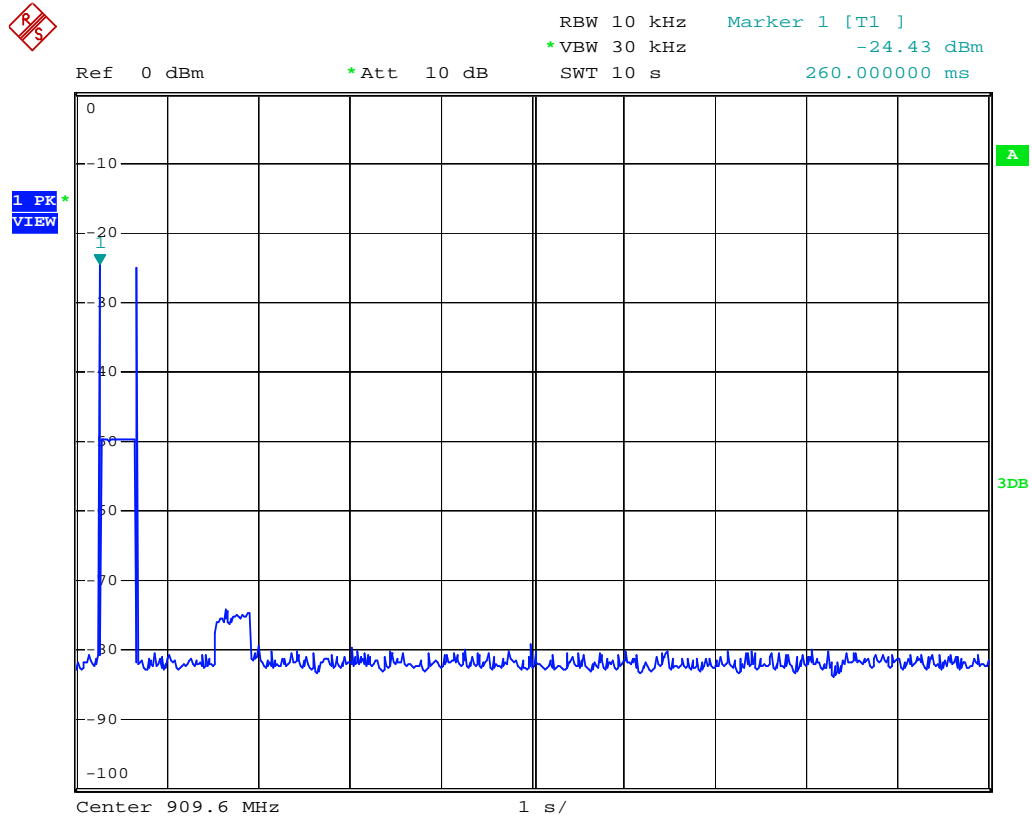

Dwell time-2

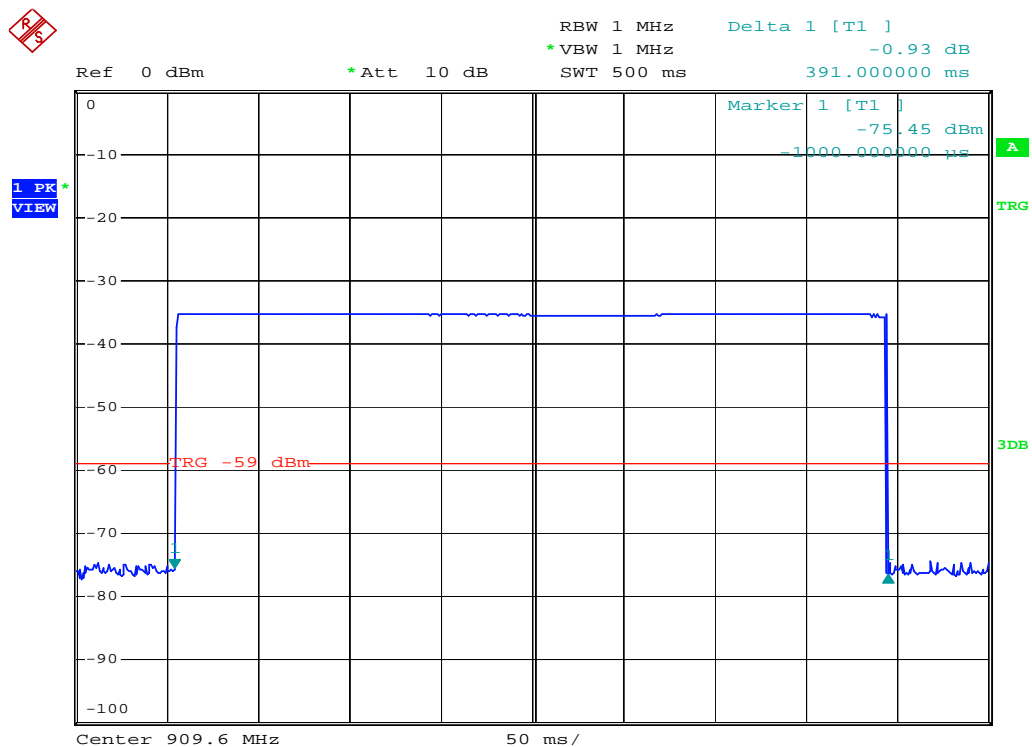

7 Maximum Output Power test

7.1 Limit

For frequency hopping systems operating in the 902–928 MHz band: 1 watt for systems employing at least 50 hopping channels; and, 0.25 watts for systems employing less than 50 hopping channels, but at least 25 hopping channels, as permitted under paragraph (a)(1)(i) of this section.

7.2 Configuration of Measurement

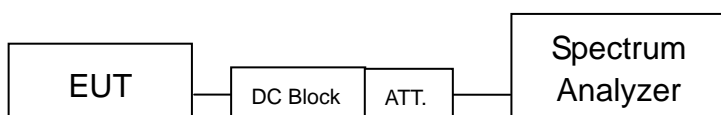

7.3 Test Procedure

The EUT was setup to ANSI C63.4, 2003; tested to FHSS test procedure of FCC Public Notice DA 00-705 for compliance to FCC 47CFR 15.247 requirements.

For FCC Part 15.247(b) the power output per was measured on the EUT using a 50 ohm SMA cable connected to peak Spectrum Analyzer. Peak output power was read directly from Spectrum Analyzer. The test was performed at 3 channels (lowest, middle and highest).

7.4 Test Result

PASS.

The final test data is shown as following pages.

Maximum output power

Channel	Frequency (MHz)	Maximum transmit power (dBm)	Watts	Limit (dBm)	Margin (dB)
0	909.6	12.64	0.01837	24	-11.36
12	913.8	12.60	0.01820	24	-11.40
24	918.0	12.57	0.01807	24	-11.43

CH0 909.6MHz

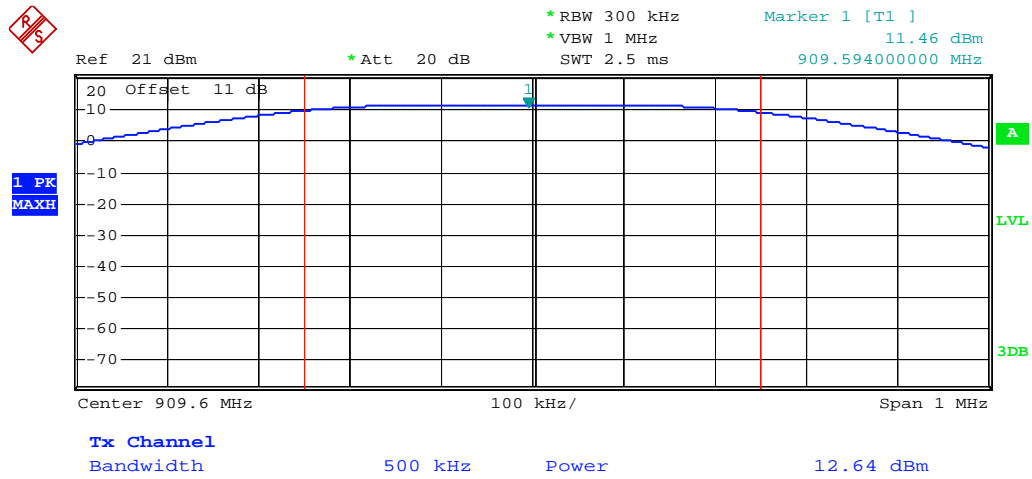

CH12 913.8MHz

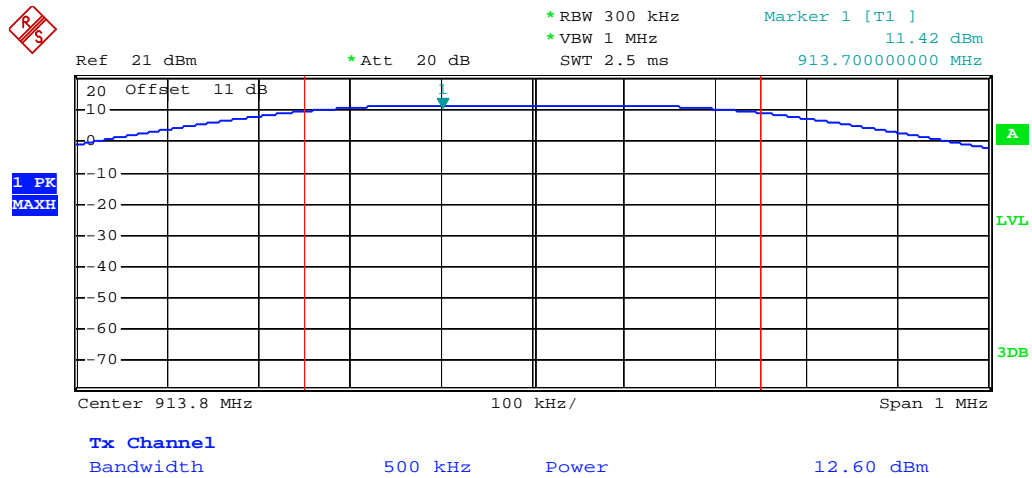

CH24 918.0 MHz

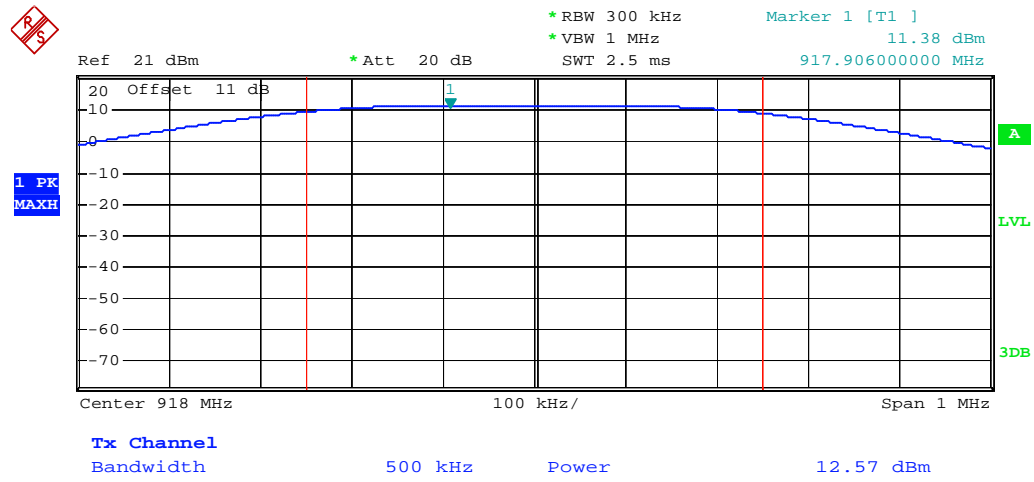

8 RF Conducted spurious emission

8.1 Limit

According to FCC Part 15.247(d) requirement :

In any 100 kHz bandwidth outside the frequency band in which the spread spectrum or digitally modulated intentional radiator is operating, the radio frequency power that is produced by the intentional radiator shall be at least 20 dB below that in the 100 kHz bandwidth within the band that contains the highest level of the desired power, based on either an RF conducted or a radiated measurement, provided the transmitter demonstrates compliance with the peak conducted power limits.

8.2 Configuration of Measurement

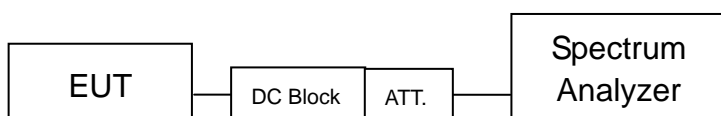

8.3 Test Procedure

The EUT was setup to ANSI C63.4, 2003; tested to FHSS test procedure of FCC Public Notice DA 00-705 for compliance to FCC 47CFR 15.247 requirements.

RF antenna conducted spurious emissions was measured from the EUT antenna port using a 50ohm spectrum analyzer with the resolution bandwidth set at 100 kHz, and the video bandwidth set at 100 kHz.

The measurements were performed from 30MHz to 10GHz.

8.4 Test Result

PASS.

The final test data is shown as following pages.

Conducted spurious emission

909.6MHz (30MHz ~ 1GHz)

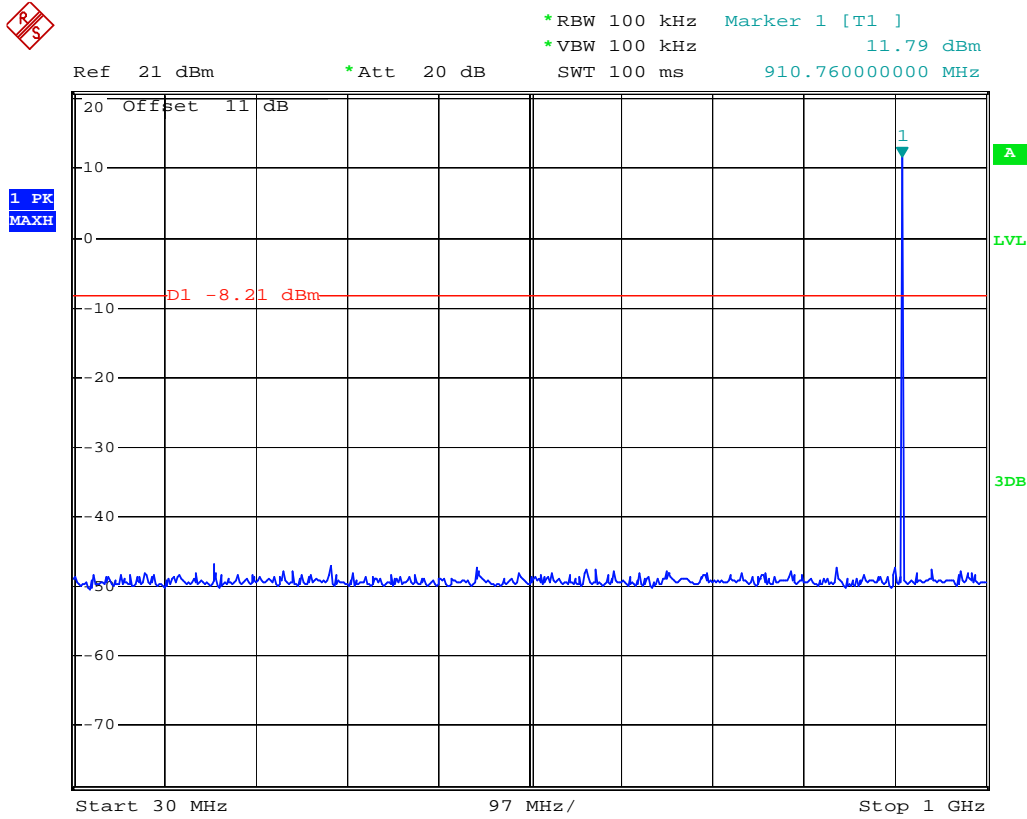

909.6MHz (1~10GHz)

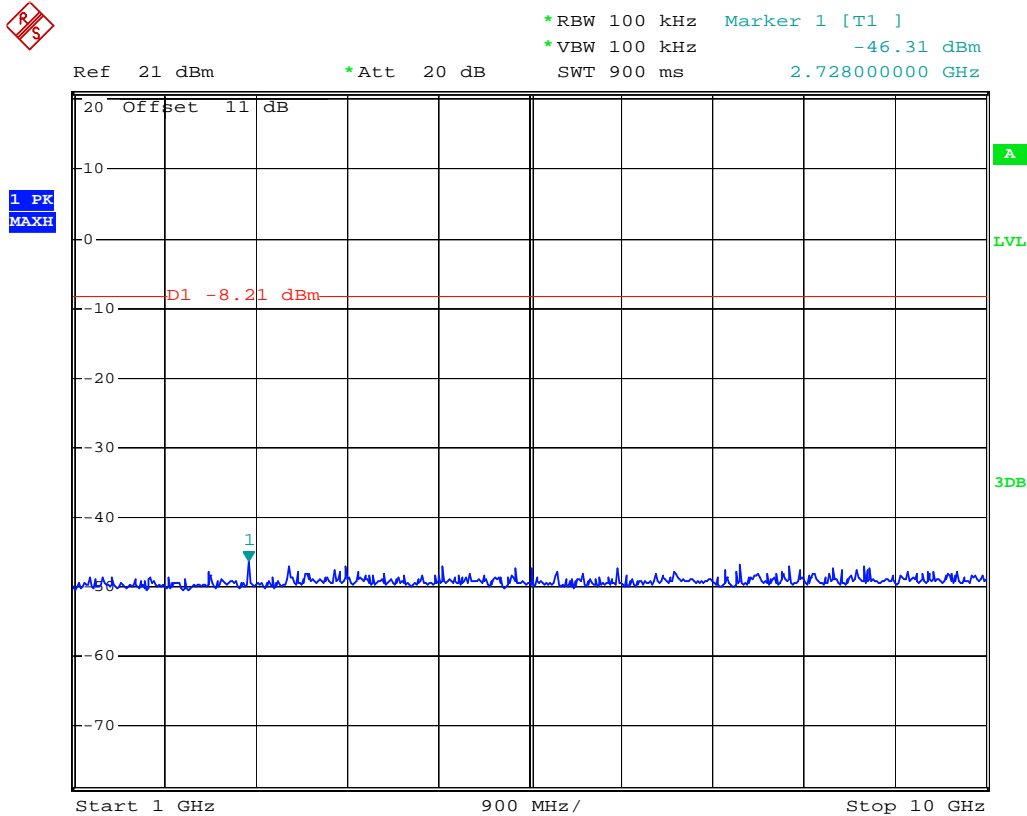

913.8MHz (30MHz ~ 1GHz)

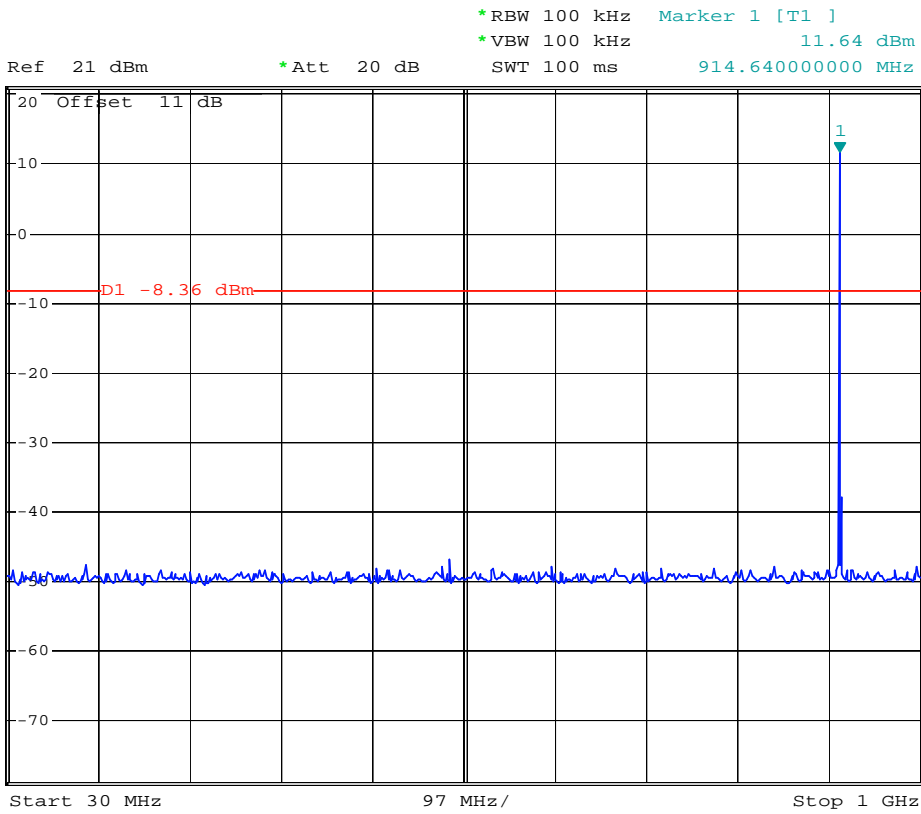

913.8MHz (1~10GHz)

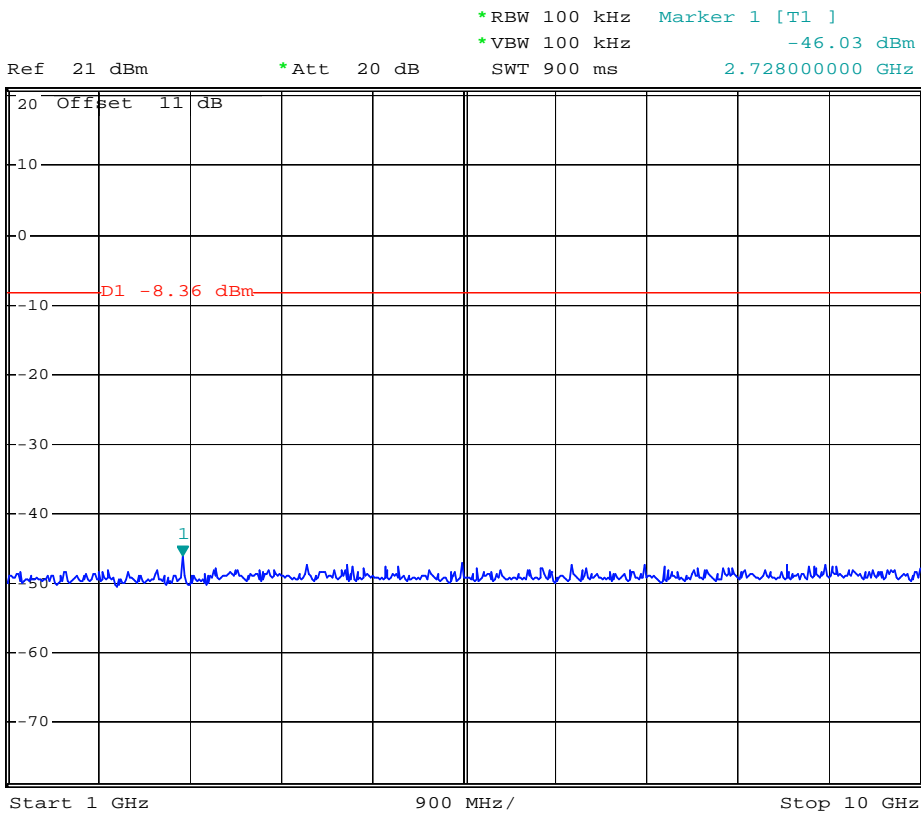

918MHz (30MHz ~ 1GHz)

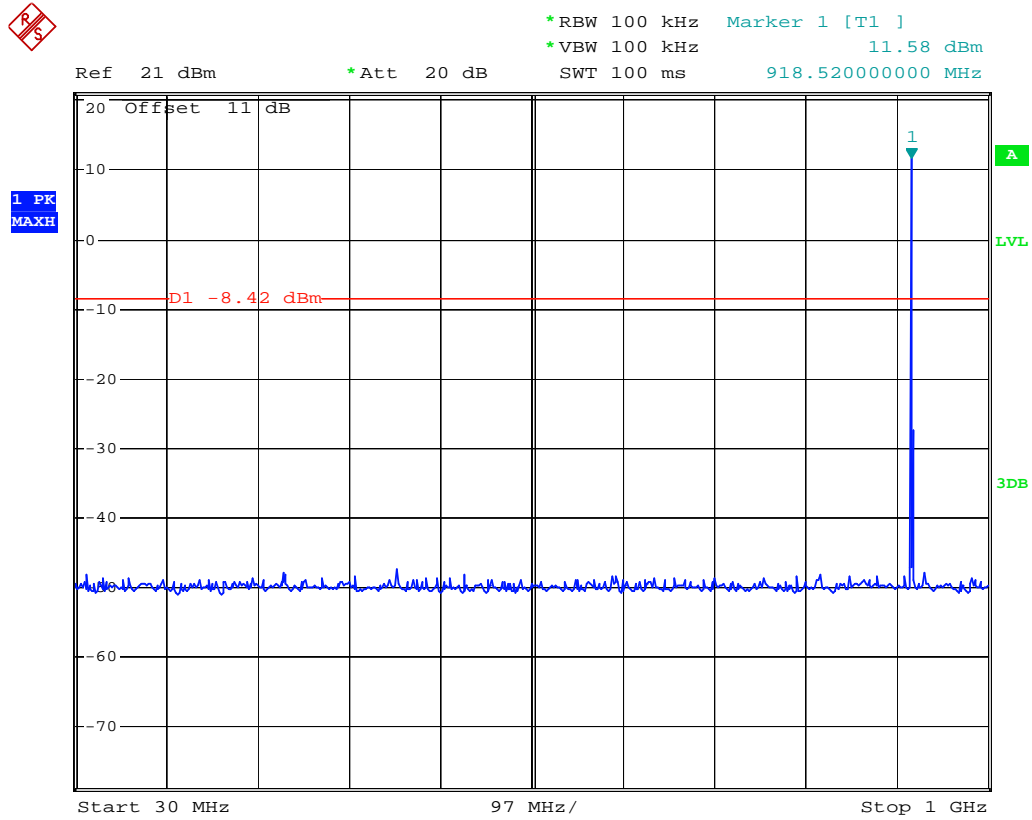

918MHz (1~10GHz)

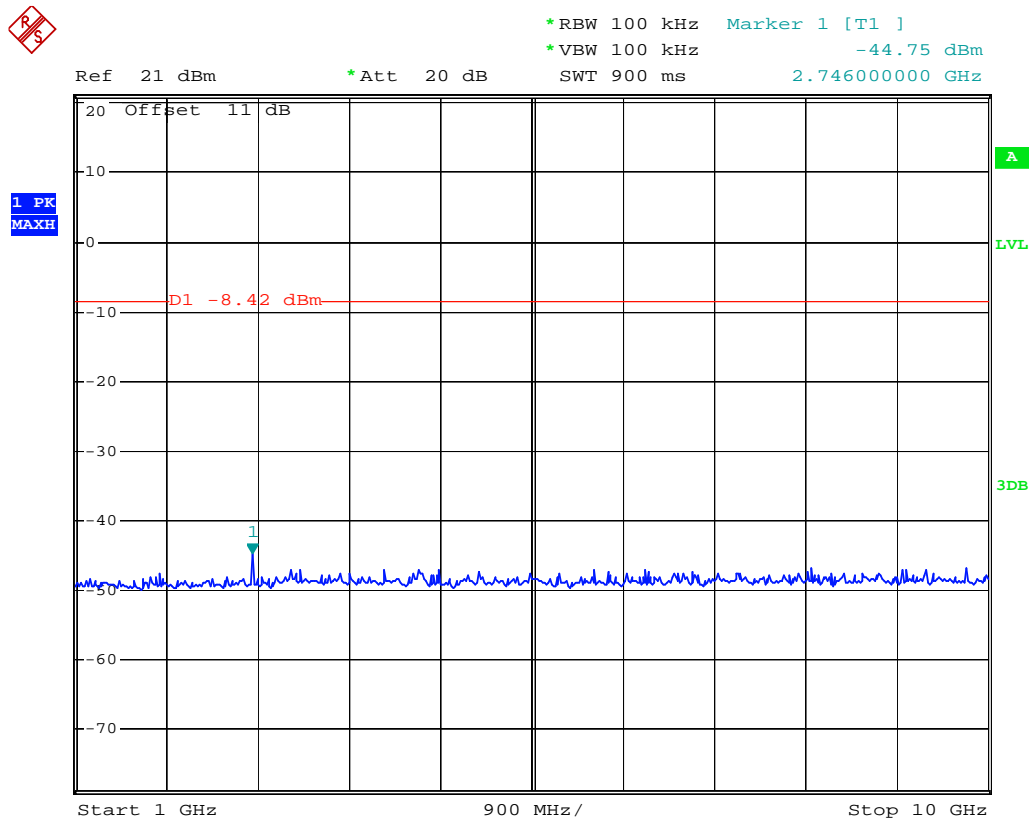

9 RF Radiated spurious emission test

9.1 Limit

For intentional radiator, the radiated emission shall comply with FCC Part 15.209(a).

For intentional radiators, according to FCC Part 15.247 (a), operation under this provision is limited to frequency hopping and direct sequence spread spectrum, and the out band emission shall be comply with FCC Part 15.247 (c)

Frequency (MHz)	Field strength dB(μ V/m)	Measurement distance (meters)
1.705~30.0	29.5	30
30 ~ 88	40	3
88~216	43.5	3
216~960	46	3
Above 960	54	3

9.2 Configuration of Measurement

Measurement Frequency under 1GHz

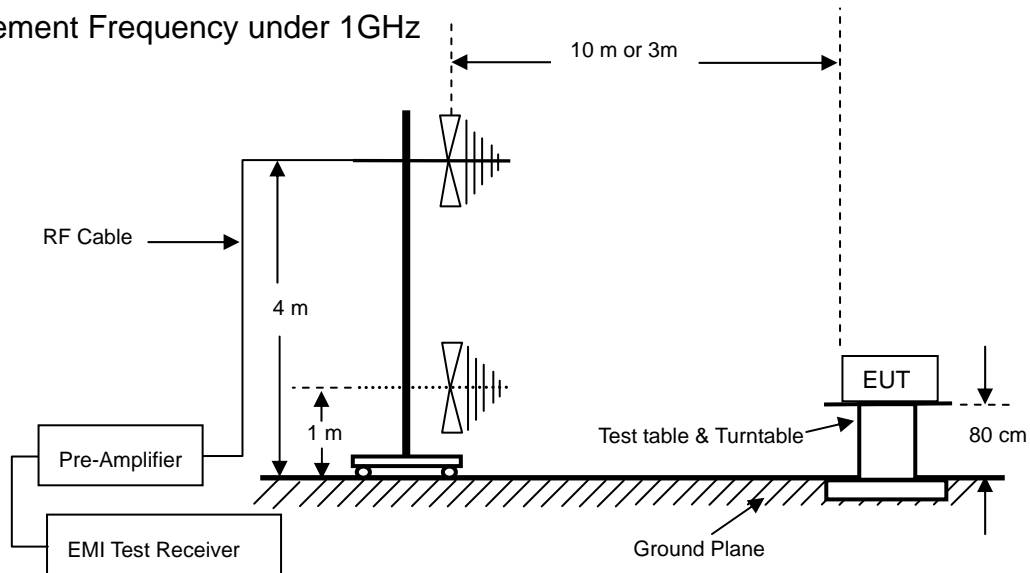

Measurement Frequency above 1GHz

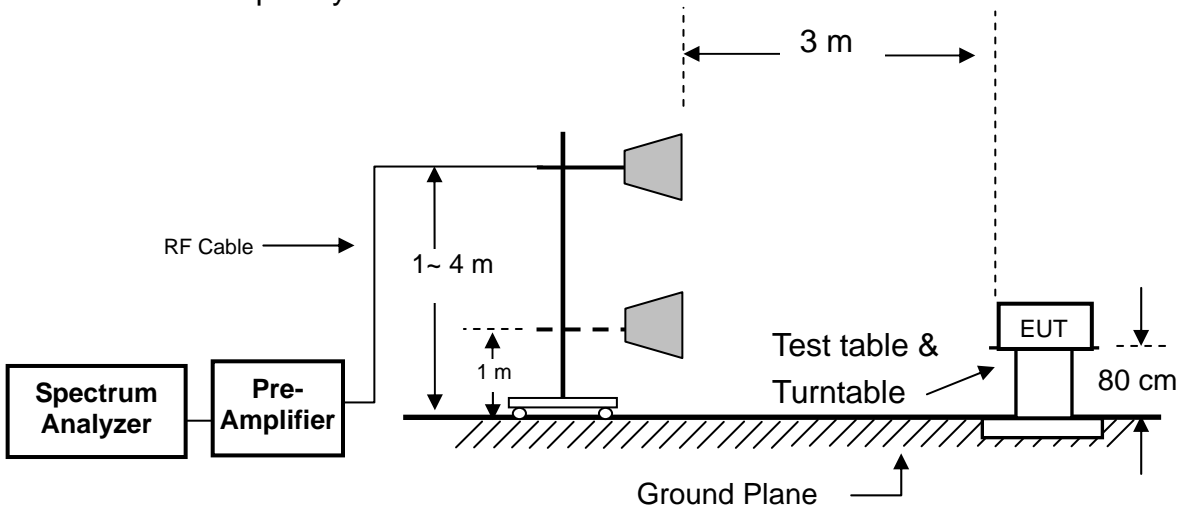

9.3 Test Procedure

The EUT was setup to ANSI C63.4, 2003; tested to FHSS test procedure of FCC Public Notice DA 00-705 for compliance to FCC 47CFR 15.247 requirements.

Radiated emission measurements were performed from 30MHz to 10GHz. Spectrum Analyzer set as below: For frequency range from 30MHz to 1GHz: RBW=100kHz or greater. For frequencies above 1GHz: set RBW=VBW=1MHz for peak detector and RBW=1MHz, VBW=10Hz for average detector.

The EUT for testing is arranged on a wooden turntable. If some peripherals apply to the EUT, the peripherals will be connected to EUT and whole system. During the test, all cables were arranged to present worst-case emissions. The signal is maximized through rotation. The height of antenna and polarization is changing constantly for exploring for maximum signal level. The height of antenna can be up to 4 meter and down to 1 meter.

9.4 Test Result

PASS.

The final test data is shown as following pages.

Radiated spurious emission

Test Environment

Ambient temperature : 26.3°C

Relative humidity : 46%

Radiated Emission below 1GHz

After verifying low, middle and high channel,

The worse case was found at Low channel X Axis.

Frequency	Antenna	Reading	Preamp	Correction Factor	Corrected Level	Limits	Margin	Det
(MHz)	Polarization	(dBuV)	(dB)	(dB/m)	(dBuV/m)	(dBuV/m)	(dB)	Mode
133.650	H	42.10	30.71	16.07	27.46	43.52	-16.06	PK
197.680	H	39.34	30.00	19.52	28.86	43.52	-14.66	PK
226.500	H	39.20	29.48	20.26	29.98	46.02	-16.04	PK
278.480	H	39.70	29.54	22.30	32.46	46.02	-13.56	PK
349.580	H	40.37	29.42	18.75	29.70	46.02	-16.32	PK
467.200	H	38.98	30.40	22.22	30.80	46.02	-15.22	PK
116.780	V	42.67	30.01	14.75	27.41	43.52	-16.11	PK
190.400	V	37.67	29.87	19.91	27.71	43.52	-15.81	PK
301.630	V	40.70	29.39	17.80	29.11	46.02	-16.91	PK
374.900	V	38.79	29.53	19.87	29.13	46.02	-16.89	PK
468.150	V	39.08	30.39	21.81	30.50	46.02	-15.52	PK
563.000	V	37.20	29.62	23.90	31.48	46.02	-14.54	PK

Remark : Corrected Level = Reading + Correction Factor – Preamp

Correction Factor = Antenna Factor + Cable Loss

The present spurious only show those points are above noise level and the frequency range test from 30MHz to 1GHz.

Radiated spurious emission

Radiated Emission above 1GHz

Channel 0 (909.6MHz)

Frequency	Antenna	Reading	Preamp	Correction Factor	Corrected Level	Limits	Margin	Det
(MHz)	Polarization	(dBUV)	(dB)	(dB/m)	(dBUV/m)	(dBUV/m)	(dB)	Mode
1819.20	H	52.36	27.71	29.50	54.15	74.00	-19.85	PK
1819.20	H	46.17	27.71	29.50	47.96	54.00	-6.04	AV
2728.80	H	39.86	27.88	32.51	44.49	54.00	-9.51	PK
3638.40	H	46.75	27.81	34.45	53.39	74.00	-20.61	PK
3638.40	H	43.09	27.81	34.45	49.73	54.00	-4.27	AV
4548.00	H	40.57	27.50	36.76	49.83	54.00	-4.17	PK
5457.60	H	36.03	27.77	38.96	47.22	54.00	-6.78	PK
6367.20	H	36.79	27.48	41.54	50.85	54.00	-3.15	PK
7276.80	H	39.21	27.26	44.81	56.76	74.00	-17.24	PK
7276.80	H	28.28	27.26	44.81	45.83	54.00	-8.17	AV
*8186.4	H	33.32	26.94	46.20	52.58	54.00	-1.42	PK
1819.20	V	50.86	27.71	29.50	52.65	74.00	-21.35	PK
1819.20	V	45.68	27.71	29.50	47.47	54.00	-6.53	AV
2728.80	V	38.68	27.88	32.51	43.31	54.00	-10.69	PK
3638.40	V	47.16	27.81	34.45	53.80	74.00	-20.20	PK
3638.40	V	42.85	27.81	34.45	49.49	54.00	-4.51	AV
4548.00	V	41.71	27.50	36.76	50.97	54.00	-3.03	PK
5457.60	V	35.08	27.77	38.96	46.27	54.00	-7.73	PK
6367.20	V	34.50	27.48	41.54	48.56	54.00	-5.44	PK
7276.80	V	34.10	27.26	44.81	51.65	74.00	-22.35	PK
7276.80	V	23.06	27.26	44.81	40.61	54.00	-13.39	AV
*8186.4	V	33.34	26.94	46.20	52.60	54.00	-1.40	PK

Remark : Corrected Level = Reading + Correction Factor – Preamp

Correction Factor = Antenna Factor + Cable Loss

* Mark indicated background noise level.

Channel 12 (913.8MHz)

Frequency	Antenna	Reading	Preamp	Correction Factor	Corrected Level	Limits	Margin	Det
(MHz)	Polarization	(dBUV)	(dB)	(dB/m)	(dBUV/m)	(dBUV/m)	(dB)	Mode
1827.60	H	48.80	27.72	29.52	50.60	74.00	-23.40	PK
1827.60	H	43.65	27.72	29.52	45.45	54.00	-8.55	AV
2741.40	H	36.97	27.88	32.54	41.63	54.00	-12.37	PK
3655.20	H	45.12	27.81	34.53	51.84	74.00	-22.16	PK
3655.20	H	40.22	27.81	34.53	46.94	54.00	-7.06	AV
4569.00	H	41.00	27.51	36.82	50.31	54.00	-3.69	PK
5482.80	H	36.97	27.78	39.00	48.19	54.00	-5.81	PK
6396.60	H	36.43	27.47	41.66	50.62	54.00	-3.38	PK
7310.40	H	39.30	27.25	44.94	56.99	74.00	-17.01	PK
7310.40	H	29.23	27.25	44.94	46.92	54.00	-7.08	AV
*8224.2	H	33.23	26.95	46.21	52.49	54.00	-1.51	PK
1827.60	V	50.85	27.72	29.52	52.65	74.00	-21.35	PK
1827.60	V	44.56	27.72	29.52	46.36	54.00	-7.64	AV
2741.40	V	38.65	27.88	32.54	43.31	54.00	-10.69	PK
3655.20	V	45.36	27.81	34.53	52.08	74.00	-21.92	PK
3655.20	V	40.50	27.81	34.53	47.22	54.00	-6.78	AV
4569.00	V	40.80	27.51	36.82	50.11	54.00	-3.89	PK
5482.80	V	34.53	27.78	39.00	45.75	54.00	-8.25	PK
6396.60	V	35.12	27.47	41.66	49.31	54.00	-4.69	PK
7310.40	V	33.86	27.25	44.94	51.55	54.00	-2.45	PK
*8224.2	V	33.35	26.95	46.21	52.61	54.00	-1.39	PK

Remark : Corrected Level = Reading + Correction Factor – Preamp

Correction Factor = Antenna Factor + Cable Loss

* Mark indicated background noise level.

Channel 24 (918MHz)

Frequency	Antenna	Reading	Preamp	Correction Factor	Corrected Level	Limits	Margin	Det
(MHz)	Polarization	(dBuV)	(dB)	(dB/m)	(dBuV/m)	(dBuV/m)	(dB)	Mode
1836.00	H	49.82	27.72	29.54	51.64	74.00	-22.36	PK
1836.00	H	46.10	27.72	29.54	47.92	54.00	-6.08	AV
2754.00	H	35.47	27.89	32.59	40.17	54.00	-13.83	PK
3672.00	H	46.68	27.81	34.62	53.49	74.00	-20.51	PK
3672.00	H	42.13	27.81	34.62	48.94	54.00	-5.06	AV
4590.00	H	40.27	27.52	36.89	49.64	54.00	-4.36	PK
5508.00	H	37.75	27.78	39.03	49.00	54.00	-5.00	PK
6426.00	H	36.69	27.47	41.77	50.99	54.00	-3.01	PK
7344.00	H	40.25	27.23	45.07	58.09	74.00	-15.91	PK
7344.00	H	29.00	27.23	45.07	46.84	54.00	-7.16	AV
*8262.0	H	33.26	26.96	46.21	52.51	54.00	-1.49	PK
1836.00	V	49.30	27.72	29.54	51.12	74.00	-22.88	PK
1836.00	V	45.23	27.72	29.54	47.05	54.00	-6.95	AV
2754.00	V	37.60	27.89	32.59	42.30	54.00	-11.70	PK
3672.00	V	45.80	27.81	34.62	52.61	74.00	-21.39	PK
3672.00	V	41.08	27.81	34.62	47.89	54.00	-6.11	AV
4590.00	V	40.67	27.52	36.89	50.04	54.00	-3.96	PK
5508.00	V	36.03	27.78	39.03	47.28	54.00	-6.72	PK
6426.00	V	34.20	27.47	41.77	48.50	54.00	-5.50	PK
7344.00	V	35.91	27.23	45.07	53.75	74.00	-20.25	PK
7344.00	V	23.05	27.23	45.07	40.89	54.00	-13.11	AV
*8262.0	V	33.03	26.96	46.21	52.28	54.00	-1.72	PK

Remark : Corrected Level = Reading + Correction Factor – Preamp

Correction Factor = Antenna Factor + Cable Loss

* Mark indicated background noise level.