

47 CFR Part 15 Subpart C

Section 15.231

TEST REPORT

Product : TRANSMITTER

Trade Name : N/A

Model Number : 4360770

FCC ID : ELVATRF

Prepared for

Nutek Corporation

No.167, Lane 235, Bauchiau Rd., Xindian District,
New Taipei City 23145, Taiwan

TEL.: +886 2 2918 9478

FAX.: +886 2 2917 9069

Prepared by

Interocean EMC Technology Corp.

Interocean EMC Technology Tin-Fu Laboratory

No. 5-2, Lin 1, Tin-Fu, Lin-Kou Dist., New Taipei City,
Taiwan 244, R.O.C.

TEL.: +886 2 2600 6861

FAX.: +886 2 2600 6859



Remark:

The test report consists of **26** pages in total. It shall not be reproduced except in full, without the written approval of IETC. This document may be altered or revised by IETC only, and shall be noted in the revision section of the document.

The test result in this report is only subjected to the test sample.

Table of Contents

1	General Information	4
1.1	Description of Equipment Under Test	4
1.2	Test Facility	5
1.3	Test Equipment	6
1.4	Measurement Uncertainty	6
1.5	Summary of Measurement	7
2	Test Specifications	8
2.1	Test Standard	8
2.2	Operation Mode	8
2.3	Test Step of EUT	8
3	Radiated Emission Test	9
3.1	Limits	9
3.2	Calculation of Average Factor	10
3.3	Configuration of Measurement	15
3.4	Test Procedure	15
3.5	Test Result	15
4	Emission Bandwidth	18
4.1	Limits	18
4.2	Test Result	18
5	Photographs of Test	20
5.1	Radiated Emission Measurement	20
6	Photographs of EUT	22

Statement of Compliance

Applicant: Nutek Corporation

Manufacturer: Nutek Corporation

Product: TRANSMITTER

Model No.: 4360770

Tested Power Voltage: DC 3V

Date of Final Test: Jul. 11, 2017

Revision of Report: Rev. 00

Configuration of Measurements and Standards Used :

FCC Rules and Regulations Part 15 Subpart C

I HEREBY CERTIFY THAT: The data shown in this report were made in accordance with the procedures given in ANSI C63.10, and the energy emitted by the device was founded to be within the limits applicable. I assume full responsibility for accuracy and completeness of these data.

Note: 1. The result of the testing report relate only to the item tested.

2. The testing report shall not be reproduced expect in full, without the written approval of IETC

Report Issued: 2017/09/20

Project Engineer: 
Elli Chang

Approved: 
Jerry Liu

1 General Information

1.1 Description of Equipment Under Test

Product : TRANSMITTER

Model Number : 4360770

Applicant : **Nutek Corporation**
No.167, Lane 235, Bauchiau Rd., Xindian District,
New Taipei City 23145, Taiwan

Manufacturer : **Nutek Corporation**
No.167, Lane 235, Bauchiau Rd., Xindian District,
New Taipei City 23145, Taiwan

Power Supply : DC 3V

Operating Frequency : 433.92 MHz

Type of Modulation : ASK

Antenna Description : This device uses PCB Printed.
The antenna is integral to the device, thereby meeting the
requirement of FCC 15.203.

Measurement Software : e3; Ver: 8.120803a7-2

Date of Test : Jun. 19 ~ Jul. 11, 2017

Additional Description : 1) The Model Number "**4360770**" is representative selected in
the test and included in this report.
2) For more detail specification about EUT, please refer to the
user's manual.

1.2 Test Facility

- Site Description** : ☒ Chamber 3
- Name of Firm** : Interocean EMC Technology Corp.
- Company web** : <http://www.ietc.com.tw>
- Location** : No. 5-2, Lin 1, Tin-Fu, Lin-Kou Dist., New Taipei City, Taiwan 244, R.O.C.
- Site Filing** :
- Federal Communication Commissions – USA
Registration No.: 96399
Designation No.: TW1020 (Test Firm Registration #: 651092)
 - Industry Canada (IC)
OUR FILE: 46405-4437
Registration No. (OATS 1): Site# 4437A-1
Registration No. (OATS 3): Site# 4437A-3
Registration No. (Chamber 3): Site# 4437A-5
Registration No. (OATS 5): Site# 4437A-6
 - Voluntary Control Council for Interference by Information Technology Equipment (VCCI) – Japan
Member No.: 1349
Registration No. (Conducted Room): C-1094
Registration No. (Conducted Room): T-1562
Registration No. (OATS 1): R-1040; G-10274
- Site Accreditation** :
- Bureau of Standards and Metrology and Inspection (BSMI) – Taiwan, R.O.C.
Accreditation No.:
SL2-IN-E-0026 for CNS 13438 / CISPR 22
SL2-R1-E-0026 for CNS 13439 / CISPR 13
SL2-R2-E-0026 for CNS 13439 / CISPR 13
SL2-L1-E-0026 for CNS 14115 / CISPR 15
 - Taiwan Accreditation Foundation (TAF)
Accreditation No.: 1113
 - Vehicle Safety Certification Center (VSCC)
Approval No.: TW16-11
 - TÜV NORD
Certificate No: TNTW0801R

1.3 Test Equipment

Instrument	Manufacturer	Model	Serial No.	Next Cal. Date
EMI Test Receiver	R&S	ESI7	830154/002	2017/09/07
Pre-Amplifier	Burgeon	BPA-530	100216	2017/09/11
Spectrum Analyzer	R&S	FSP40	100478	2018/06/19
Horn Antenna	Schwarzbeck	BBHA9120	9120D-1051	2017/10/27
Pre-Amplifier	EMCI	EMC 051845	980110	2017/10/19
RF Cable	Jye Bao	A30N30-5005	CBL51	2017/08/02
RF Cable	Jye Bao	N30N30-5006	CBL53	2017/08/02
RF Cable	HARBOUR	27478LL142	CBL65	2017/08/02
ATTENUATOR	Fairview Calibr	SA18S5W-10	10#2	2018/06/22
Biconical Antenna	Schwarzbeck	VHA 9103 & BBA 9106	VHA 9103-2418	2017/07/13
Log Antenna	Schwarzbeck	UHALP 9108-A	9108-A 0739	2017/07/13
Measurement Software	AUDIX-e3			

Note: The above equipments are within the valid calibration period.

1.4 Measurement Uncertainty

Item	Expended Uncertainty (k=2)
Conduction 1:	
Conducted Emission (9 kHz to 30 MHz)	2.98 dB
Chamber 3:	
Radiated Emission Test (30 MHz to 1 GHz)	4.86 dB
Radiated Emission Test (above 1 GHz)	5.12 dB
RF test:	
RF conducted measurement (9 kHz to 40GHz)	2.92 dB

1.5 Summary of Measurement

Report Clause	Test Parameter	Reference Document 47 CFR Part15	Results
3	Timing requirement	§15.231(a)	Pass
3	Radiated Emission	§15.231(b), 15.209	Pass
4	Emission Bandwidth	§15.231(c)	Pass

2 Test Specifications

2.1 Test Standard

The EUT was performed according to FCC Part 15 Subpart C Section 15.231 procedure and setup followed by ANSI C63.10, 2013 requirements.

2.2 Operation Mode

By preliminary testing and verifying three axis (X, Y and Z) position of EUT transmitted status, it was found that "X axis" position was the worst, then the final test was executed the worst condition and test data were recorded in this report.

The EUT was operated in continuous transmission mode during all of the tests.



X axis mode



Y axis mode



Z axis mode

2.3 Test Step of EUT

- 2.3.1 Setup the fixture to EUT for power supplying.
- 2.3.2 Turn on the power of all equipment.
- 2.3.3 Let the EUT continuous transmission.
- 2.3.4 Executed the test.

3 Radiated Emission Test

3.1 Limits

According to FCC 15.231(b) requirement:

In addition to the provisions of §15.205, the field strength of emissions from intentional radiator operated under this section shall not exceed the following:

Fundamental and Harmonics Emission Limits

Frequency (MHz)	Field Strength of Fundamental		Field Strength of Harmonics	
	(μ V/m@3m)	(dB μ V/m@3m)	(μ V/m@3m)	(dB μ V/m@3m)
433.92	10996	80.8	1099.6	60.8

General Radiated Emission Limit

Spurious Emission tested through until 10th harmonic. Radiated emissions, which fall in the restricted bands, as defined in §15.205 (a), comply with the radiated emission limits specified in §15.209 (a).

Frequency (MHz)	15.209 Limits	
	(μ V/m@3m)	(dB μ V/m@3m)
30-88	100	40
88-216	150	43.5
216-960	200	46
Above 960	500	54

Remark :

1. The table above tighter limit applies at the band edges.
2. The measurement distance in meters, which that between form closest point of EUT to instrument antenna.

3.2 Calculation of Average Factor

The output field strengths of specification in accordance with the FCC rules specify measurements with an average detector. During the test, a spectrum analyzer incorporating a peak detector was used. Therefore, a reduction factor can be applied to the resultant peak signal level and compared to the limit for measurement instrumentation incorporating an average detector.

The duty cycle is measured in 100 ms or the repetition cycle period, whichever is a shorter time frame. The duty cycle is measured by placing the spectrum analyzer to set zero span at 100kHz resolution bandwidth.

Averaging factor in dB = $20 \log$ (duty cycle)

The duration of one cycle = 108.09ms

The duty cycle is simply the on-time divided by 100ms

Duty Cycle = $(0.78\text{ms} \times 40 + 0.36 \times 38) / 100\text{ms} = 44.88\text{ms} / 100\text{ms}$

Therefore, the averaging factor is found by $20 \log 0.4488 = -6.96 \text{ dB}$

Duty Cycle

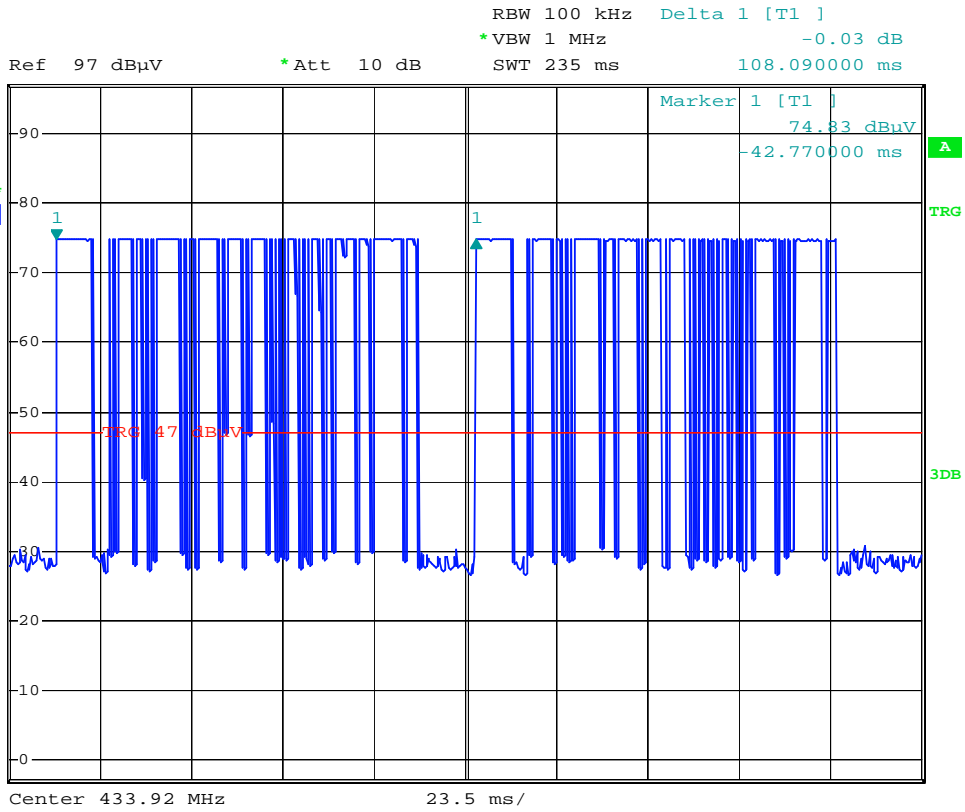

Time Slot

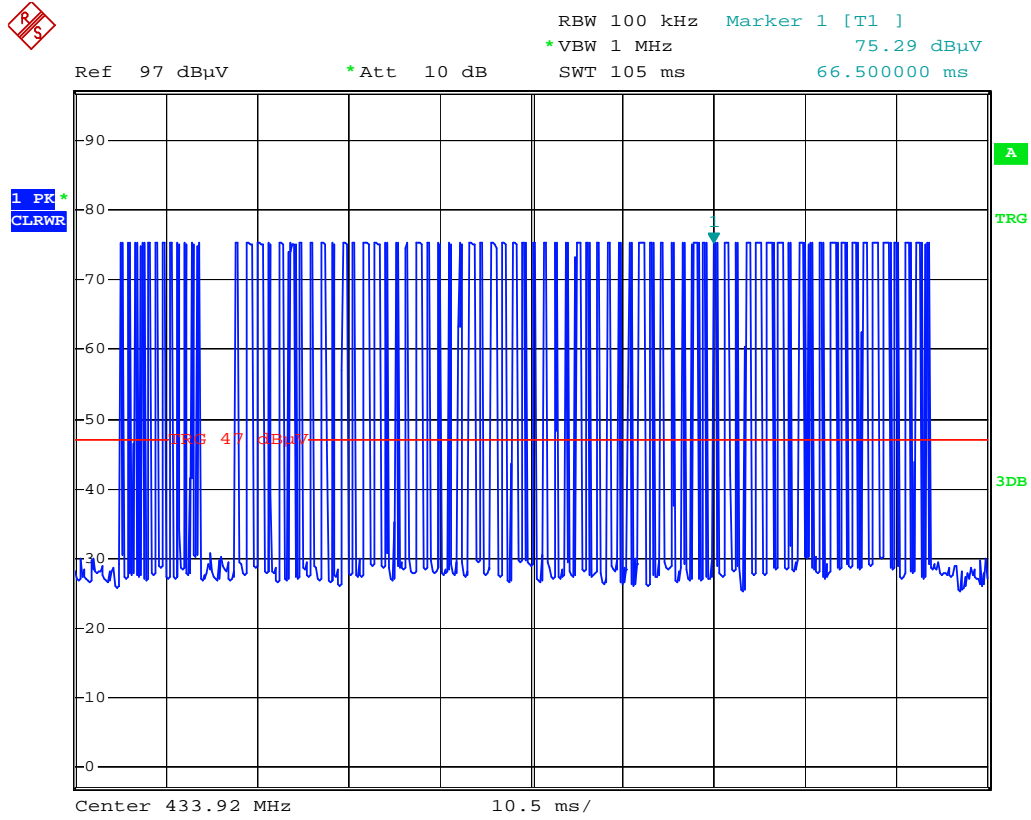

Time Slot

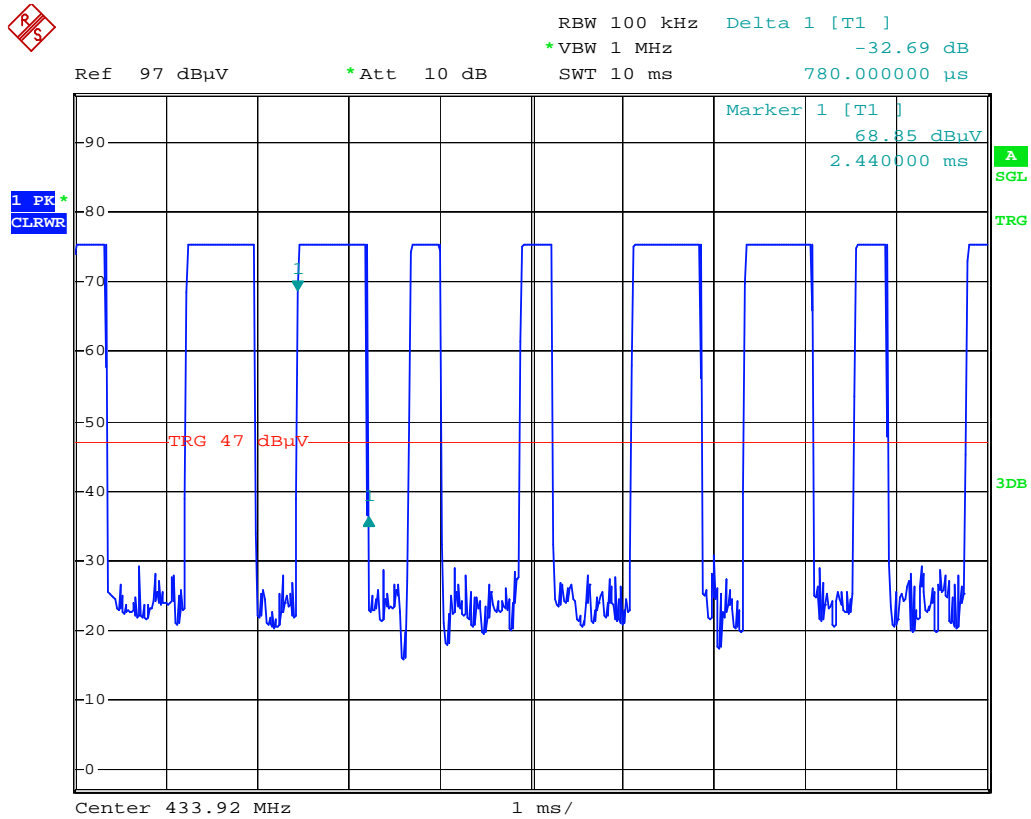

Time Slot 1

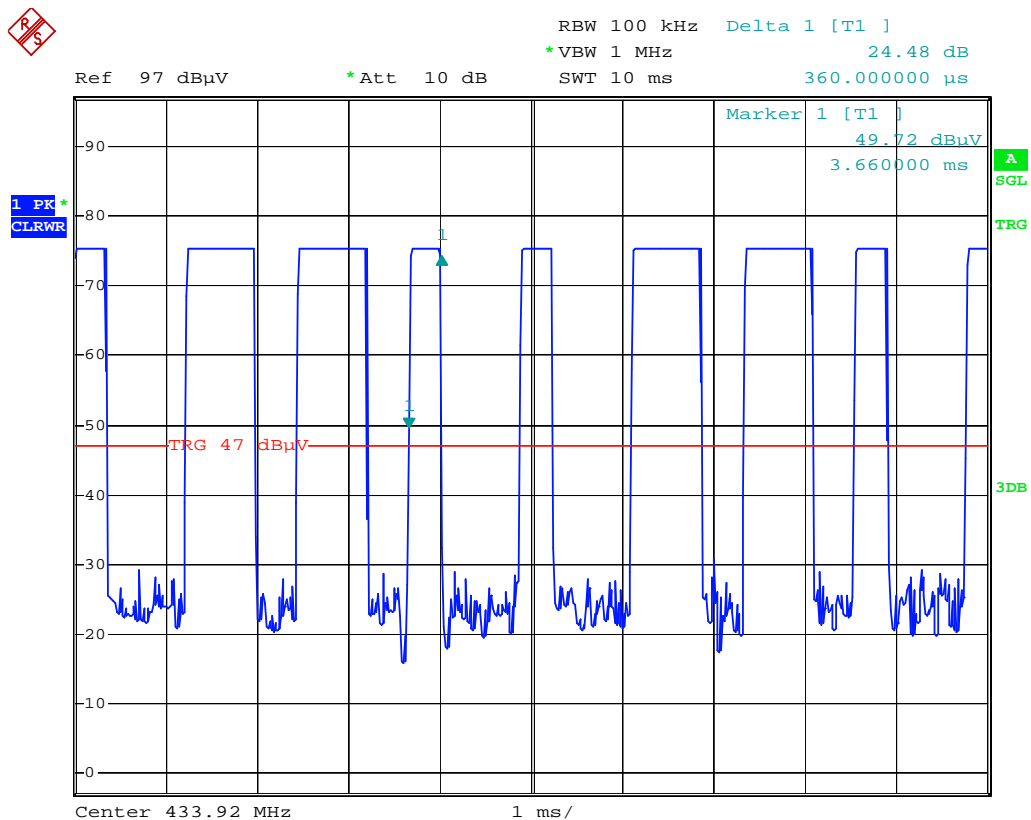

Time Slot 2

The EUT was complied with the requirement of FCC 15.231 (a)(1), which employed a switch that will automatically deactivate the transmitter within less than 5 seconds of being released.

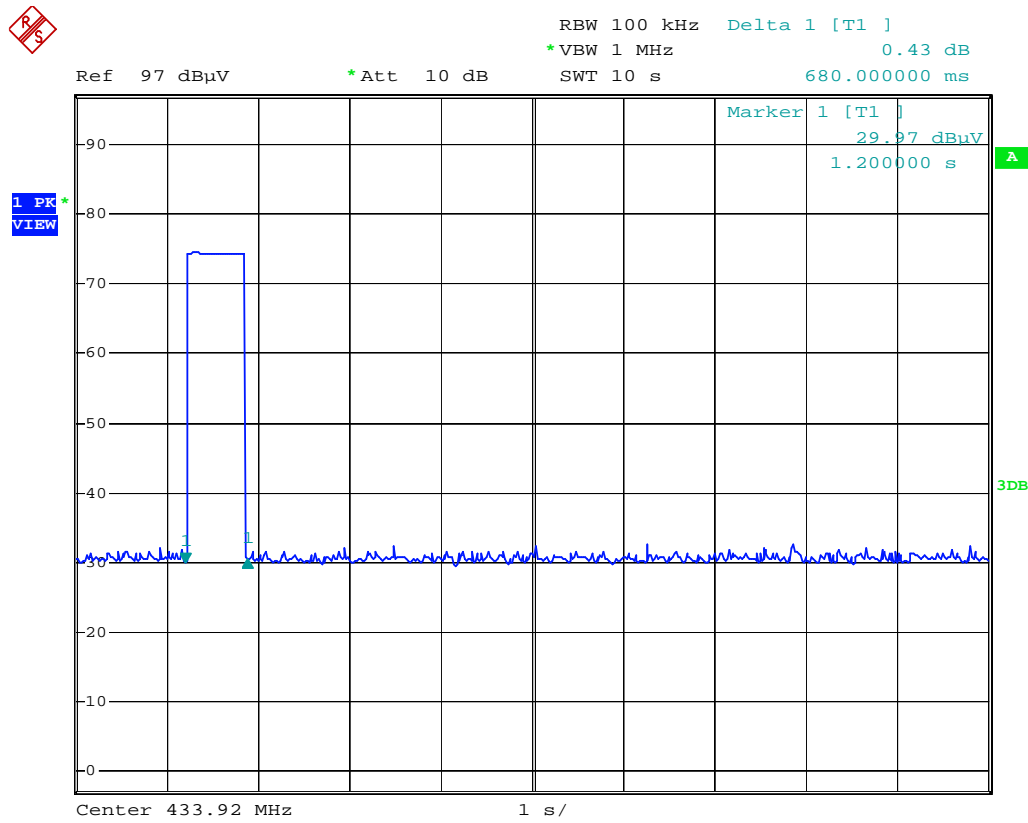

3.3 Configuration of Measurement

Measurement Frequency under 1GHz

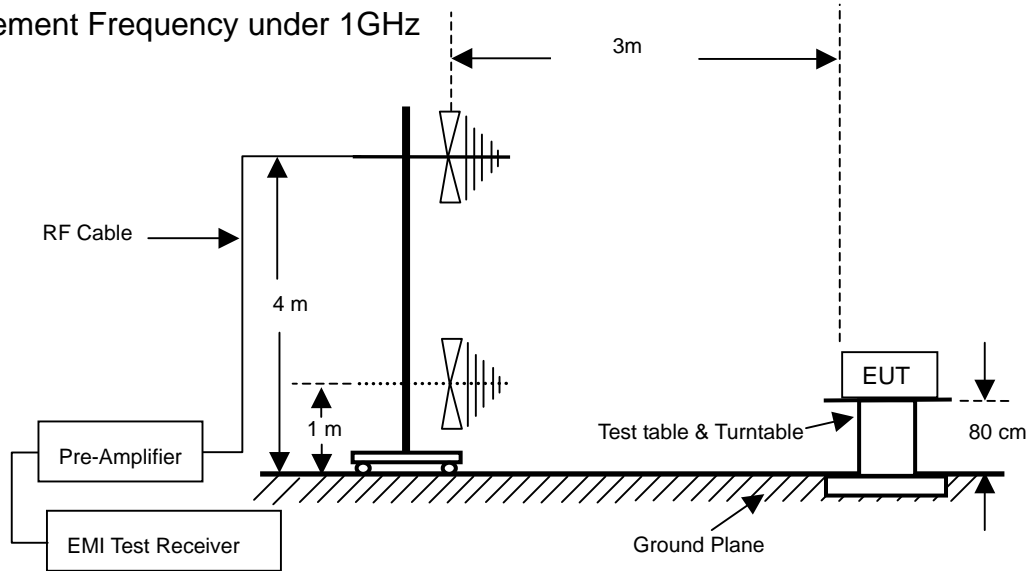

Measurement Frequency above 1GHz

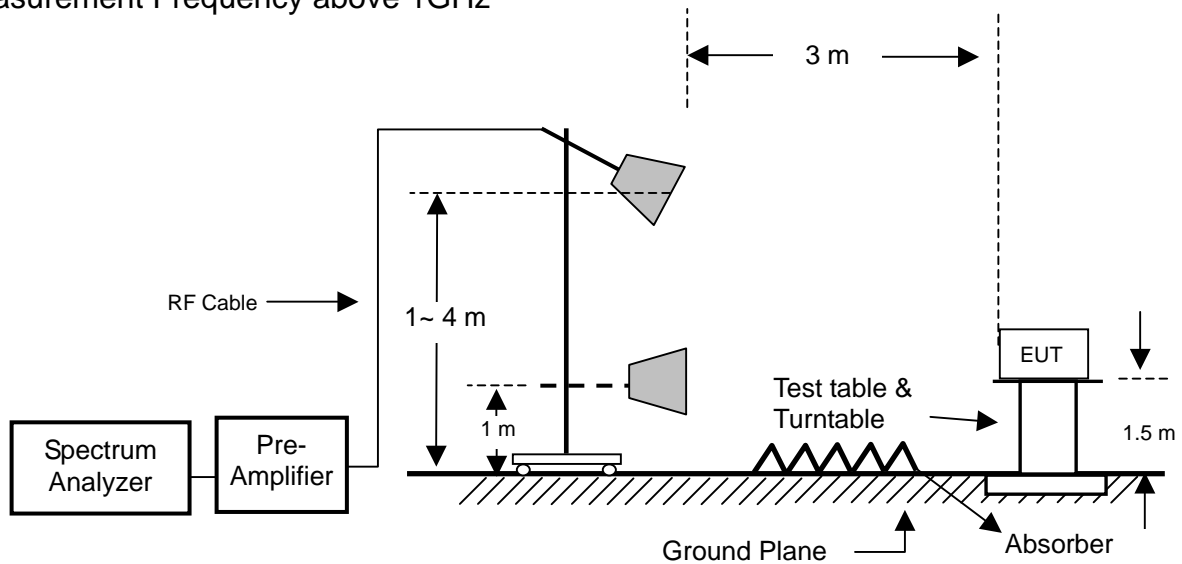

3.4 Test Procedure

Radiated emission measurements frequency range were performed from 9kHz to 5GHz. Spectrum Analyzer Resolution Bandwidth set to 9kHz for frequencies below 30MHz, set 100kHz or greater for frequencies from 30MHz to 1GHz, and set 1MHz Resolution Bandwidth for frequencies above 1GHz.

The EUT is place on non-conductive turntable for the test. If peripheral devices apply to the EUT, the peripheral devices will be connected to EUT and whole system. During the emission test, the signal is maximized through rotation and all cables were present worst-case emissions. The height of antenna and polarization is constantly changed for exploring maximum signal reading. The height of antenna can be up form reference ground to 4 meter and down to 1 meter.

3.5 Test Result

PASS.

The final test emission data is shown as following tables.

Radiated Emission Below 1GHz

Frequency	Antenna	Reading	Preamp	Correction Factor	Corrected Level	Limits	Margin	Det
(MHz)	Polarization	(dBuV)	(dB)	(dB/m)	(dBuV/m)	(dBuV/m)	(dB)	Mode
108.75	H	38.56	31.48	13.23	20.31	43.52	-23.21	PK
188.73	H	35.00	31.23	17.71	21.48	43.52	-22.04	PK
301.15	H	39.72	31.34	16.98	25.36	46.02	-20.66	PK
432.26	H	35.21	31.29	20.55	24.47	46.02	-21.55	PK
533.60	H	34.66	31.35	21.95	25.26	46.02	-20.76	PK
602.21	H	34.57	31.41	22.94	26.10	46.02	-19.92	PK
67.89	V	40.23	31.60	8.18	16.81	40.00	-23.19	PK
154.20	V	36.30	31.32	16.28	21.26	43.52	-22.26	PK
198.37	V	34.64	31.20	18.33	21.77	43.52	-21.75	PK
293.12	V	35.03	31.33	21.92	25.62	46.02	-20.40	PK
356.47	V	37.67	31.30	18.27	24.64	46.02	-21.38	PK
512.36	V	35.95	31.33	21.46	26.08	46.02	-19.94	PK

Remark : Corrected Level = Reading + Correction Factor – Preamp

Correction Factor = Antenna Factor + Cable Loss

Margin = Corrected Level – Limits

“ * ” Mark indicated Background Noise Level

The frequency range from 9 kHz to 30 MHz was pre-scanned and the results were 20 dB lower than the limit line which according to FCC 15.31(o) needs not be recorded.

Fundamental and Harmonics Emissions

Freq.	Antenna	Reading	Preamp	Correction Factor	Average Factor	Corrected Level	Limits	Margin	Det
(MHz)	Polarization	(dBuV)	(dB)	(dB/m)	(dB)	(dBuV/m)	(dBuV/m)	(dB)	Mode
433.92 (X Axis)	H	55.12	0.00	20.57	--	75.69	100.8	-25.11	PK
433.92 (X Axis)	H	55.12	0.00	20.57	-6.96	68.73	80.8	-12.07	AV
433.92 (Y Axis)	H	52.94	0.00	20.57		73.51	100.8	-27.29	PK
433.92 (Y Axis)	H	52.94	0.00	50.57	-6.96	96.55	80.8	15.75	AV
433.92 (Z Axis)	H	58.69	0.00	20.57		79.26	100.8	-21.54	PK
433.92 (Z Axis)	H	58.69	0.00	20.57	-6.96	72.30	80.8	-8.50	AV
867.84	H	43.36	31.32	26.76	--	38.80	80.8	-42.00	PK
867.84	H	43.36	31.32	26.76	-6.96	31.84	60.8	-28.96	AV
1301.76	H	57.67	51.62	30.35	--	36.40	74.0	-37.60	PK
1301.76	H	57.67	51.62	30.35	-6.96	29.44	54.0	-24.56	AV
1735.68	H	56.45	51.65	32.01	--	36.81	80.8	-43.99	PK
1735.68	H	56.45	51.65	32.01	-6.96	29.85	60.8	-30.95	AV
2169.60	H	59.85	51.63	33.46	--	41.68	80.8	-39.12	PK
2169.60	H	59.85	51.63	33.46	-6.96	34.72	60.8	-26.08	AV
2603.52	H	58.76	51.72	34.92	--	41.96	80.8	-38.84	PK
2603.52	H	58.76	51.72	34.92	-6.96	35.00	60.8	-25.80	AV
3037.44	H	57.89	51.81	36.12	--	42.20	80.8	-38.60	PK
3037.44	H	57.89	51.81	36.12	-6.96	35.24	60.8	-25.56	AV
3471.36	H	56.71	51.89	36.68	--	41.50	80.8	-39.30	PK
3471.36	H	56.71	51.89	36.68	-6.96	34.54	60.8	-26.26	AV
3905.28	H	55.81	51.90	37.84	--	41.75	74.0	-32.25	PK
3905.28	H	55.81	51.90	37.84	-6.96	34.79	54.0	-19.21	AV
4339.20	H	56.07	51.97	39.25	--	43.35	74.0	-30.65	PK
4339.20	H	56.07	51.97	39.25	-6.96	36.39	54.0	-17.61	AV
433.92 (X Axis)	V	59.80	0.00	20.57	--	80.37	100.8	-20.43	PK
433.92 (X Axis)	V	59.80	0.00	20.57	-6.96	73.41	80.8	-7.39	AV
433.92 (Y Axis)	V	57.14	0.00	20.57		77.71	100.8	-23.09	PK
433.92 (Y Axis)	V	57.14	0.00	20.57	-6.96	70.75	80.8	-10.05	AV
433.92 (Z Axis)	V	43.13	0.00	20.57		63.70	100.8	-37.10	PK
433.92 (Z Axis)	V	43.13	0.00	20.57	-6.96	56.74	80.8	-24.06	AV
867.84	V	49.00	31.32	26.76	--	44.44	80.8	-36.36	PK
867.84	V	49.00	31.32	26.76	-6.96	37.48	60.8	-23.32	AV
1301.76	V	58.67	51.62	30.35	--	37.40	74.0	-36.60	PK
1301.76	V	58.67	51.62	30.35	-6.96	30.44	54.0	-23.56	AV
1735.68	V	59.69	51.65	32.01	--	40.05	80.8	-40.75	PK
1735.68	V	59.69	51.65	32.01	-6.96	33.09	60.8	-27.71	AV
2169.60	V	62.72	51.63	33.46	--	44.55	80.8	-36.25	PK
2169.60	V	62.72	51.63	33.46	-6.96	37.59	60.8	-23.21	AV
2603.52	V	61.00	51.72	34.92	--	44.20	80.8	-36.60	PK
2603.52	V	61.00	51.72	34.92	-6.96	37.24	60.8	-23.56	AV
3037.44	V	64.52	51.81	36.12	--	48.83	80.8	-31.97	PK
3037.44	V	64.52	51.81	36.12	-6.96	41.87	60.8	-18.93	AV
3471.36	V	58.79	51.89	36.68	--	43.58	80.8	-37.22	PK
3471.36	V	58.79	51.89	36.68	-6.96	36.62	60.8	-24.18	AV
3905.28	V	56.99	51.90	37.84	--	42.93	74.0	-31.07	PK
3905.28	V	56.99	51.90	37.84	-6.96	35.97	54.0	-18.03	AV
4339.20	V	57.29	51.97	39.25	--	44.57	74.0	-29.43	PK
4339.20	V	57.29	51.97	39.25	-6.96	37.61	54.0	-16.39	AV

Remark : Corrected Level = Reading + Correction Factor – Preamp
 Correction Factor = Antenna Factor + Cable Loss
 Margin = Corrected Level – Limits
 “ * ” Mark indicated Background Noise Level

4 Emission Bandwidth

4.1 Limits

According to FCC 15.231(c) requirement:

The bandwidth of the emission shall be no wider than 0.25% of the center frequency for devices operating between 70 MHz to 900 MHz. Those devices operating above 900 MHz, the emission spurious shall be no wider than 0.5% of the center frequency. Bandwidth is determined at the points 20 dB down from the modulated carrier.

B.W (20dBc) Limit = 0.25% * f(MHz) = 0.25% * 433.92MHz = 1084.8kHz

4.2 Test Result

PASS.

The final test data is shown as following.

Channel Frequency (MHz)	Measured 20dB Bandwidth (kHz)	Limit (kHz)	Result
433.92	58.2	1084.8	PASS

