

Exhibit T: User Manual 4400

FCC ID: EJM-X400

intel®

AnyPoint® DSL Gateway 4400

User's Guide



Share
Broadband
with
all your PCs



Copyright

The Intel® Anypoint® DSL Gateway 4400 User's Guide as well as the software described in it, is furnished under license and may only be used or copied in accordance with the terms of the license. The information in this document is furnished for informational use only, is subject to change without notice, and should not be construed as a commitment by Intel Corporation. Intel Corporation assumes no responsibility or liability for any errors or inaccuracies that may appear in this document or any software that may be provided in association with this document.

Except as permitted by such license, no part of this document may be reproduced, stored in a retrieval system, or transmitted in any form or by any means without the express written consent of Intel Corporation.

Information in this document is provided in connection with Intel products. No license, express or implied, by estoppel or otherwise, to any intellectual property rights is granted by this document. Except as provided in Intel's Terms and Conditions of Sale for such products, Intel assumes no liability whatsoever, and Intel disclaims any express or implied warranty, relating to sale and/or use of Intel products including liability or warranties relating to fitness for a particular purpose, merchantability, or infringement of any patent, copyright or other intellectual property right. Intel products are not intended for use in medical, life saving, or life sustaining applications.

Intel may make changes to specifications and product descriptions at any time, without notice.

Intel, AnyPoint, and Pentium are trademarks or registered trademarks of Intel Corporation or its subsidiaries in the United States and other countries.

**Other names and brands may be claimed as the property of others.

Copyright (C) 2002, Intel Corporation. All rights reserved.

Intel Corporation, 5200 NE Elam Young Parkway, Hillsboro, OR 97214-6497

Contents

Introduction	1
Overview	2
Intel AnyPoint DSL Gateway 4400 Features	3
System Requirements	3
Service Requirements	4
A look at the Gateway Hardware	5
Items included with the Gateway	8
Finding Information	9
Running the Internet Setup Wizard	9
Configuring your DSL Settings	13
Specifying connection information	14
Specifying a connection type	16
Specifying a PPP username and password	19
Specifying an IP address	22
Specifying a name server	25
Setting up the Gateway with a Network	29
Connecting the gateway to an Ethernet hub or switch	30
Connecting the gateway to a wireless network	32
Using the Wireless Network Configuration Wizard	35
Specifying a wireless network name (SSID)	37
Correcting for wireless interference	39
Changing or disabling encryption settings	42
Specifying a wireless encryption key from text	44
Entering a key manually	46
Disabling wireless encryption	49
Configuring the gateway's firewall	51
Specifying the firewall security level	53
Specifying intrusion detection settings	55
Specifying IP addresses to be excluded from being blocked	57
Using port forwarding	59
Enabling port forwarding	61
Selecting a target computer by name	63
Selecting a target computer by IP address	65
Creating a custom rule	67

Using Advanced Configuration Options	71
Accessing advanced configuration options	72
Changing the gateway password	74
Specifying wireless security settings	76
Resetting the gateway or reloading default settings	79
Exposing a computer outside the firewall	81
Enabling remote access	83
Specifying the Host and Domain names	85
Specifying LAN and DHCP settings	87
Disabling Universal Plug and Play (UPnP)	90
Diagnostics and Troubleshooting	93
Getting network status information	94
Getting status details	100
Running Diagnostics	107
Problems and solutions	108
If all else fails	120
Reading the gateway indicator lights	120
Reading settings and device status	120
Glossary	123
Glossary	124
Regulatory Compliance Statements	131
Safety compliance statements	132
Emissions compliance statements	132
RF exposure compliance statements	133
Telecom compliance statements	133
Canadian compliance statements	135
European Union compliance statements	136
Product Ecology Statements	137

Chapter 1

Introduction

This chapter provides a basic overview of the gateway's features, list its system and service requirements, lists the items included with gateway product package, explains where to find more information, and explains how to start the Internet Setup Wizard.

- Intel AnyPoint DSL Gateway 4400 Features
- System Requirements
- Service Requirements
- A look at the Gateway Hardware
- Items included with the Gateway
- Finding Information
- Running the Internet Setup Wizard

Overview

The Intel[®] AnyPoint[®] DSL Gateway 4400 is an advanced services gateway that combines the functions of a Bridge, Router, Switch, and DSL Modem in a single box for Internet access and computer connectivity.

Using the gateway, you can share Internet access seamlessly among all the computers on your network whether you are using Ethernet or 802.11b Wireless adapters or a combination of any of these technologies.

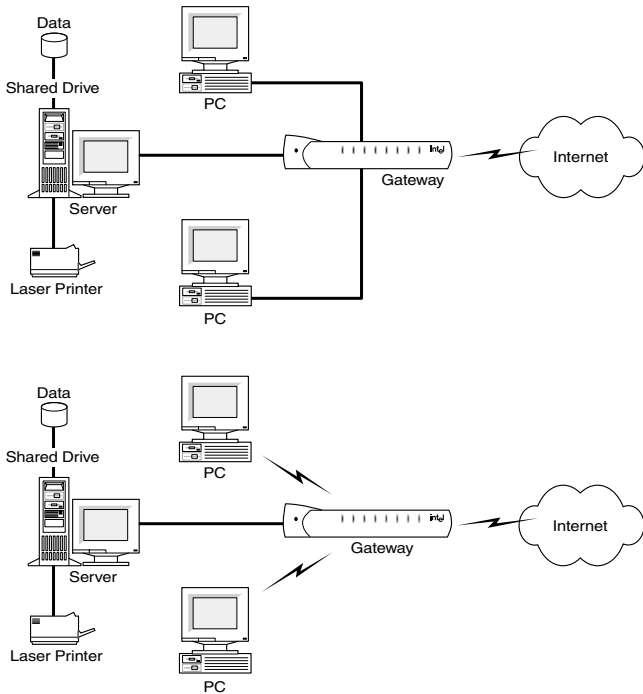

The Intel AnyPoint DSL Gateway 4400 connects directly to a DSL (Digital Subscriber Line) using the built-in DSL modem. Using the gateway and its built-in DSL modem together enables powerful Internet access on a home or small-business network.

Intel AnyPoint DSL Gateway 4400 Features

The gateway has the following features:

- Easy to install
- Automatic first time use setup wizard
- Port forwarding
- Configurable WAN MAC Address
- UPnP support
- Automatic diagnostic tests
- Readily available troubleshooting tips
- Simple Web-based user interface
- Internet sharing on your network
- Built-in firewall for network security

System Requirements

To configure the gateway, your computer must meet certain requirements. Choose the list appropriate to your computer's operating system:

- Windows***
- 166 MHz Pentium® processor, performance level or better
 - Windows* 95, 98, Me, 2000, XP, or NT*
 - 32 MB of RAM, or more
 - CD-ROM drive
 - 800 x 600 resolution monitor (SVGA) or higher
 - One of the following:
 - 10/100 Ethernet or 10 baseT Ethernet adapter
 - Wireless PC Card (802.11b/Wi-Fi)
 - Web browser (Microsoft Internet Explorer* 5.0 or later, Netscape Navigator* 4.75 or later, or equivalent)

Macintosh*

- PowerPC* or 680x0*
- Mac OS 7.6.1 or later
- 32 MB of RAM, or more
- 800 x 600 resolution monitor (SVGA) or higher
- One of the following:
 - 10/100 Ethernet or 10 baseT Ethernet adapter
 - Wireless PC Card (802.11b/Wi-Fi)
- CD-ROM drive
- Web browser (Microsoft Internet Explorer 5.0 or later; Netscape Navigator 4.75 or later, or equivalent)

Linux

- 166 MHz Pentium processor or higher
- 32MB of RAM, or more
- 800 x 600 resolution monitor (SVGA) or higher
- One of the following:
 - 10/100 Ethernet or 10 baseT Ethernet adapter
 - Wireless PC Card (802.11b/Wi-Fi)
- CD-ROM drive
- X-Windows* system
- Graphical Web browser (Netscape Navigator 4.75 or later)

Service Requirements

Before you can use the gateway, you must have the following services activated:

- Broadband account from your local telephone company or Broadband provider
- Broadband Internet access account from your local Broadband provider or Internet Service Provider (ISP)

If you do not have these services set up, then contact your local telephone company for more information.

A look at the Gateway Hardware

Front Panel The Intel Gateway's front panel has a series of eight lights (plus a power on indicator) that provide information about the gateway's operational status.



- Power** Normally this light is on. If it is not on, check that the power cable connectors are securely in place.
- System** Green blinking - The gateway is operating correctly.

Yellow blinking - The gateway is operating correctly but has detected another DHCP server connected to one of the four Ethernet connectors. Disconnect each Ethernet cable, one at a time, until the system returns to green blinking. Change the PC you've identified as a DHCP server to a DHCP client. (See the Troubleshooting chapter for instructions.)

If this LED is not blinking, the system is not operating correctly. See Chapter 5 for troubleshooting information.

- Internet Off - the DSL driver is not loaded.
- Green blinking - the gateway is trying to connect to the Internet.
- Green solid - the gateway is connected to your ISP but no traffic is being passed.
- Amber blinking - the gateway is connected to your ISP and traffic is being passed. This LED blinks at a rate that corresponds to the amount of Internet traffic (slow with little traffic and increasingly faster as Internet traffic increases).
- Security Green solid - The Firewall Settings Security Level is set to: Normal, High, or Very High.
- Red solid - The Firewall Settings Security Level is set to: Enable Troubleshooting Mode (via the Firewall Settings Advanced button).
- Yellow blinking - A user, that is not allowed access to your wireless network (via Advanced > Wireless Security), is attempting to connect to the gateway.

Wireless Off - There are no wireless devices communicating with the gateway.

Green solid - at least one wireless device is connected to the gateway.

Green blinking - traffic is being passed between at least one wireless device and the gateway.

Ethernet 1-4 Off - no PC is connected to any of the four Ethernet ports.

Green solid - A valid link has been established at 10Mbps.

Green blinking - traffic is being passed at 10Mbps.

Yellow solid - A valid link has been established at 100Mbps.

Yellow blinking - traffic is being passed at 100Mbps.

Back panel connectors

The Intel Gateway's back panel includes the cable connectors and Reset button.

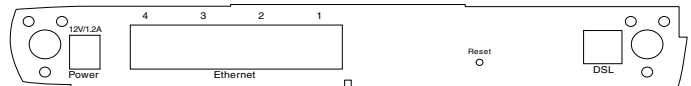

Power Accepts the cylinder end of the power cable. Plug the other end of the power cable into a standard electrical outlet. (It is recommended that you use a surge protector.) See the Power light on the front panel in the previous section.

Ethernet Accept RJ-45 Ethernet-style connectors for connecting up to four PCs to the gateway's 4-port switch.

- Reset** Use a blunt object, such as a paper clip, to press the reset switch. You can use the reset switch to either:
- Reset the gateway without losing its current setup values. Press, then immediately release the reset switch.
 - Reset the gateway to its factory-default values. Press the reset switch and hold it in the pressed state for at least 5 seconds before releasing it.
- DSL** Accepts a standard phone cable connector for attaching the gateway to your DSL (digital subscriber line) service outlet.

Items included with the Gateway

You should have the following items ready prior to installation:

- Intel AnyPoint DSL Gateway 4400
- Power Supply
- Standard phone cable
- Standard Ethernet Cable
- Intel AnyPoint DSL Gateway 4400 CD-ROM
- Intel AnyPoint DSL Gateway 4400 Installation Guide

The Gateway CD-ROM

The exact contents of the CD-ROM varies by Broadband provider. Do not assume that the CDs are interchangeable. One provider may have different default software configurations than another, and the configurations are often not compatible with each other. Only use the CD supplied to you by your provider.

All gateway CDs contain the following:

- A *readme* text file, with basic product information and any known issues that were not available at the time of the publication of this manual
- The *Intel AnyPoint DSL Gateway 4400 Installation Guide*, available as a .pdf file
- The *Intel AnyPoint DSL Gateway 4400 User's Guide*, available as a .pdf file

Finding Information

Installation Guide The *Installation Guide* offers an overview of the basic steps necessary to connect and configure your new gateway.

User's Guide The *User's Guide* contains more detailed information on connecting and configuring your new gateway. It is designed for users who have less experience with installing and configuring gateways and home networking equipment. The *User's Guide* can also be used as a helpful reference tool.

Online Help Use the online help for more information on screen descriptions. Troubleshooting information is also available for the diagnostic tests.

Running the Internet Setup Wizard

Note The following describes how to access the Internet Setup Wizard for purposes of modifying the gateway's configuration. If the gateway has not yet been configured, then follow the instructions provided in the Installation Guide.

To run the Internet Setup Wizard:

- 1 Insert the CD and wait for the Internet Setup Wizard window to appear. (If the Autorun window does not appear, run the program **autorun.exe** on the CD.)

The following screen will appear, if the gateway has not yet been configured. If the gateway has already been configured, a slightly different screen will appear.



- 2 Click the **Enter Setup** button.

The following appears.



- 3 Enter **admin** in both the User Name and Password fields, and then click **OK**.

If the gateway has not yet been configured, you will be required to enter specific information before you can access other features of the Setup Wizard. If the gateway has already been configured, you can access other features of the Internet Setup Wizard using the available menu selections. Each feature is described in this User Guide.

Chapter 2

Configuring your DSL Settings

The Installation Guide provides step-by-step instructions for setting up and configuring a single wired or wireless PC connected to the gateway.

During installation, you have the option of letting setup automatically detect your settings or setting these manually.

If you accept the default selection, allowing the gateway to automatically detect your settings, then you should only need to enter minimal information, if any at all.

If you elect to set your settings manually, then you will have to step through several screens to complete the setup.

This chapter covers all the possible settings you may have to enter in the following topics:

- Specifying connection information
- Specifying a connection type
- Specifying a PPP username and password
- Specifying an IP address
- Specifying a name server

Specifying connection information

You specify VPI/VCI connection information using the Connection Information screen.

Related topics

- See *Specifying a connection type* on page 16.
- See *Specifying a PPP username and password* on page 19.
- See *Specifying an IP address* on page 22.
- See *Specifying a name server* on page 25.

Step-by-step

To specify your VPI/VCI connection information:

- 1 Click the **Settings** menu to expand its selections.
- 2 Click **Next**.

The following appears.

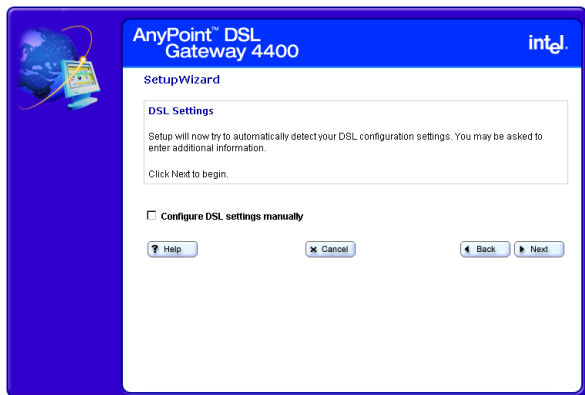

- 3 Click **Configure DSL settings manually** then click **Next**.

The following appears.

- 4 Enter the VPI information in the **VPI** field.
- 5 Enter the VCI information in the **VCI** field.
- 6 Click **Next**.

More about **VPI**

Virtual Path Identifier. This is part of the PVC. This, combined with the VCI, establishes your “channel” through the phone company equipment. Acceptable values are: 0-255.

VCI

Virtual Circuit Identifier. This number is part of the PVC. It establishes your “channel” through the telephone company equipment. Acceptable values are: 0-65,535.

Specifying a connection type

You specify a connection type using the Specify Connection Type screen.

- Related topics**
- See *Specifying connection information* on page 14.
 - See *Specifying a PPP username and password* on page 19.
 - See *Specifying an IP address* on page 22.
 - See *Specifying a name server* on page 25.

Step-by-step To specify a connection type:

- 1 Click the **Settings** menu to expand its selections.
- 2 Click **Next**.

The following appears.

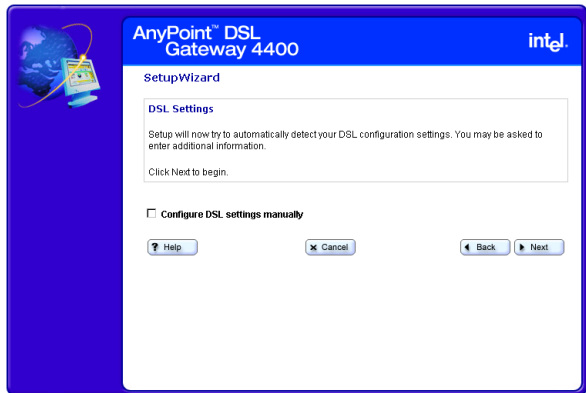

- 3 Click **Configure DSL settings manually** then click **Next** until you see the following screen.

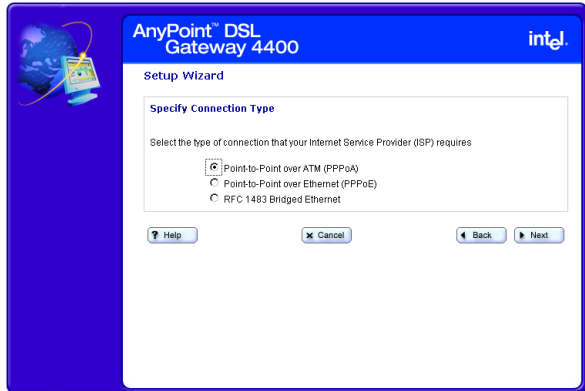

- 4 Select one of the following connection types, as required by your ISP, then click Next. (See More about for more information.)
- **Point-to-Point over ATM (PPPoA)**
 - **Point-to-Point over Ethernet (PPPoE)**
 - **RFC 1483 Bridged Ethernet option**

More about **PPPoA**

Point-to-Point over ATM Protocol is a protocol that some ISPs use to give users access to the ISP's computers and the Internet. Your ISP can tell you if you need PPPoA, or a different protocol supported by your gateway (Bridged Ethernet, or Point-to-Point Protocol over Ethernet (PPPoE)).

PPPoE

Point-to-Point over Ethernet Protocol is a protocol that some ISPs use to give users access to the ISP's computers and the Internet. Your ISP can tell you if you need PPPoE, or a different protocol supported by your

gateway (Bridged Ethernet, or Point-to-Point over ATM Protocol (PPPoA).

RFC1483

A standard that provides guidelines for Bridged Ethernet and Routed Ethernet connection protocols. Your ISP can tell you if you will use one of the RFC1483 protocols, or a different protocol supported by your gateway (PPPoA, PPPoE).

Specifying a PPP username and password

You specify a PPP username and password using the PPP Username/Password screen.

- Related topics**
- See *Specifying connection information* on page 14.
 - See *Specifying a connection type* on page 16.
 - See *Specifying an IP address* on page 22.
 - See *Specifying a name server* on page 25.

Step-by-step To specify a PPP username and password:

- 1 Click the **Settings** menu to expand its selections.
- 2 Click **Next**.

The following appears.

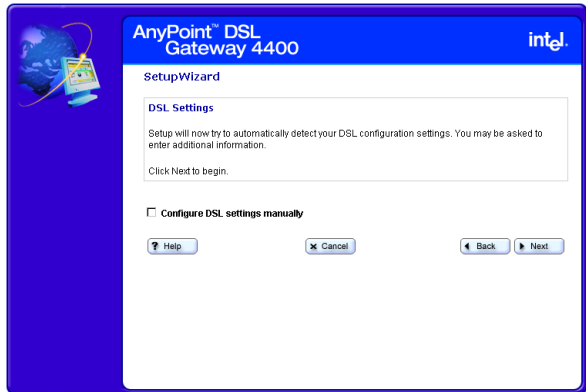

- 3 Click **Configure DSL settings manually** then click **Next** until you see the following screen.

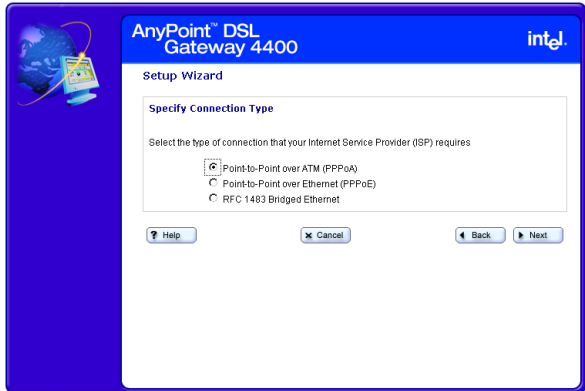

- 4 On the “Connection Type” screen, click either **Point-to-Point over ATM (PPPoA)** or **Point-to-Point over Ethernet (PPPoE)**.

- 5 Click **Next**.

The following appears.

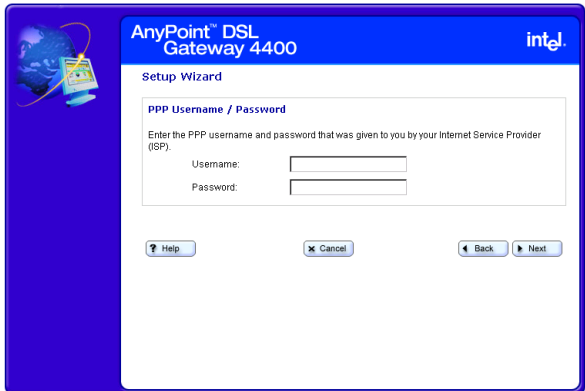

- 6 Enter a PPP username and password in the **User Name** and **Password** fields provided.

Important! Your username and password are case sensitive.

Specifying an IP address

You specify an IP address using the Specify IP Address screen.

- Related topics**
- See *Specifying connection information* on page 14.
 - See *Specifying a connection type* on page 16.
 - See *Specifying a PPP username and password* on page 19.
 - See *Specifying a name server* on page 25.

Step-by-step To specify an IP address:

- 1 Click the **Settings** menu to expand its selections.
- 2 Click **Next**.

The following appears.

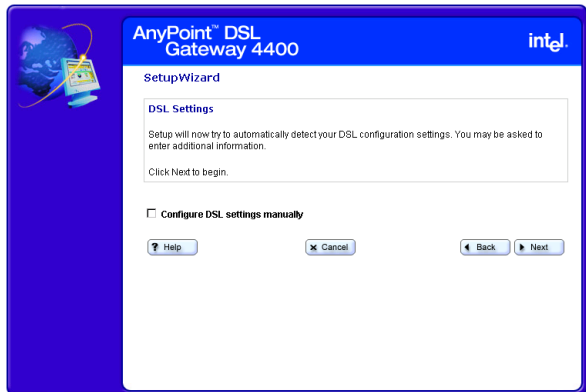

- 3 Click **Configure DSL settings manually** then click **Next** until you see the following screen.

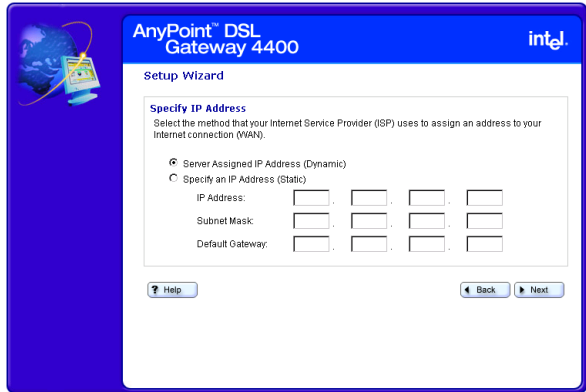

- 4 Select one of the following methods your ISP uses to assign an address to your Internet connection.
- **Server assigned IP address (dynamic)** – Select this option if your ISP assigns addresses dynamically.
 - **Specify an IP address (static)** – Select this option if your ISP assigns addresses statically. If you select this option then you must enter the IP Address, Subnet Mask, and Default Gateway information in the fields provided.

More about

Each computer or networked device on the Internet is identified by a unique IP address. Your gateway must be identified by the correct address in order for you to access the Internet.

Your ISP uses one of two methods to assign an IP address to you:

- **Dynamic** (also called server-assigned, automatic, or DHCP). If your ISP assigns IP addresses dynamically, your gateway receives an IP address from a pool of IP addresses when you connect to

your ISP. Your ISP “owns” the IP addresses in the pool.

- **Static** (also called permanent). If your ISP assigns static IP addresses, your provider selects an address from an assigned pool and assigns it to you permanently. This number is provided on the setup information page given to you by your ISP.

Specifying a name server

You specify a name server using the Specify a Name Server screen.

- Related topics**
- See *Specifying connection information* on page 14.
 - See *Specifying a connection type* on page 16.
 - See *Specifying a PPP username and password* on page 19.
 - See *Specifying an IP address* on page 22.

Step-by-step To specify a name server:

- 1 Click the **Settings** menu to expand its selections.
- 2 Click **Next**.

The following appears.

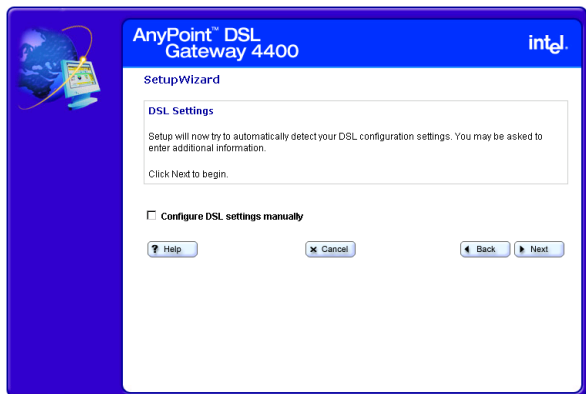

- 3 Click **Configure DSL settings manually** then click **Next** until you see the following screen.

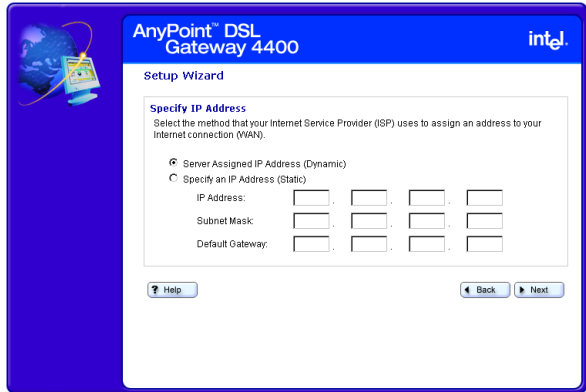

- 4 Select the **Specify an IP Address (Static)** option, enter the IP Address, Subnet Mask, and Default Gateway information in the fields provided, then click **Next**.

The following appears.

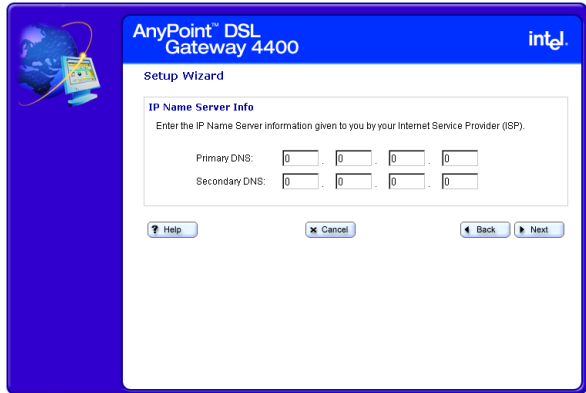

- 5 Enter the Primary DNS (and optionally, secondary) IP provided by your ISP.

More about

A name server DNS IP address is the IP address of the computer that your ISP uses to translate between numeric IP addresses and human-readable addresses.

For example, 192.168.0.254 is a numeric IP address and www.intel.com is a human-readable address.

Chapter 3

Setting up the Gateway with a Network

This chapter explains how to connect additional computers to your wired or wireless network.

Note Do not attempt to connect multiple computers to form a network until you have configured the gateway to work with a single computer, as described in the Installation Guide.

- Connecting the gateway to an Ethernet hub or switch
- Connecting the gateway to a wireless network
- Using the Wireless Network Configuration Wizard
- Configuring the gateway's firewall
- Using port forwarding

Connecting the gateway to an Ethernet hub or switch

Once you have established a connection between the gateway and a single computer with an Ethernet adapter, you can then connect additional computers to the wired network.

Note Do not attempt to connect multiple computers to form a network until you have configured the gateway to work with a single computer. Refer to your Installation Guide for instructions on configuring the gateway to do this.

Related topics

- See *Connecting the gateway to a wireless network* on page 32.
- See *Using the Wireless Network Configuration Wizard* on page 35.
- See *Configuring the gateway's firewall* on page 51.
- See *Using port forwarding* on page 59.

Step-by-step

To connect the gateway to a hub or switch:

- 1 Connect one end of the Ethernet cable (included with the gateway) to any one of the four **Ethernet** ports on the gateway.
- 2 Connect the other end to the Ethernet cable to an available port on your hub or switch.

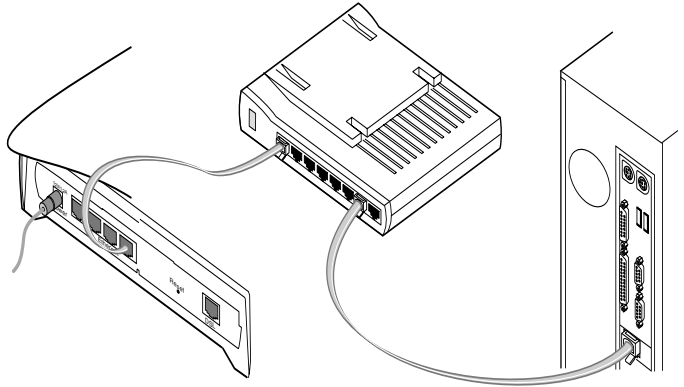

- 3 Connect the power cable to the power supply.
- 4 Connect the power cable to an electrical wall outlet.
- 5 Connect the power supply cable to the **Power** port on the gateway.

Note If you are using the gateway as a DHCP server, make sure the computers on your network are configured to be DHCP clients. Refer to Chapter 5 for information.

Connecting the gateway to a wireless network

Once you have established a connection between the gateway and a single computer with an 802.11b wireless adapter, you can then connect additional computers to the wireless network.

Note Do not attempt to connect multiple computers to form a network until you have configured the gateway to work with a single computer. Refer to your Installation Guide for instructions on configuring the gateway to do this.

Related topics

- See *Connecting the gateway to an Ethernet hub or switch* on page 30.
- See *Using the Wireless Network Configuration Wizard* on page 35.
- See *Configuring the gateway's firewall* on page 51.
- See *Using port forwarding* on page 59.

Step-by-step

To connect the gateway to a wireless network:

- refer to the Intel[®] AnyPoint[®] Wireless II Installation Guide for instructions on installing the remaining computers with wireless adapters on your network. (If you have purchased a non-Intel 802.11b wireless adapter, refer to the instructions provided with your adapter.)
- Set the Network Name (SSID) and Encryption to be the same for the gateway and each wireless adapter. To set the Network Name and Encryption for your wireless adapters, refer to the instructions provided with them.

To set the Network Name and Encryption for the gateway:

- 1 Click the **Settings** menu to expand its selections.

- 2 Click **Wireless** to view your current wireless settings. The following appears.

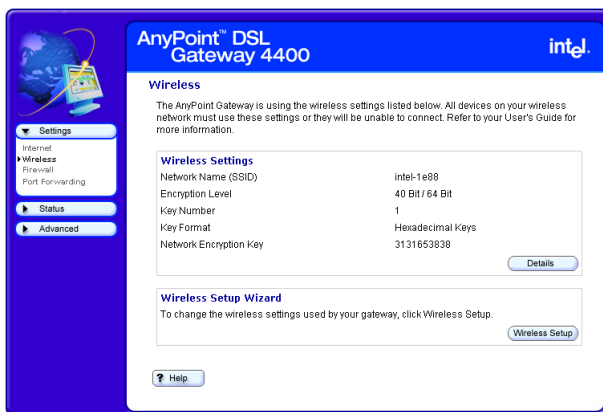

- 3 Click the **Wireless Setup** button to enter the Wireless Setup Wizard.

The following appears.

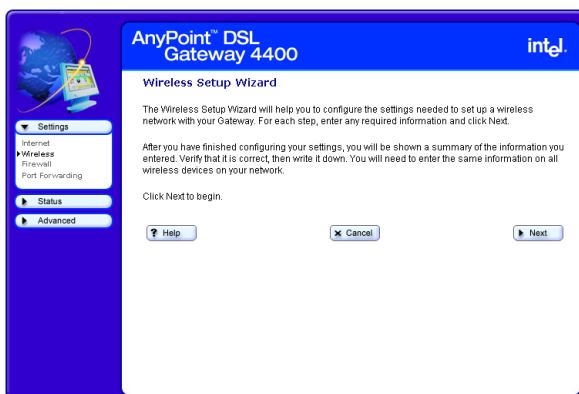

- 4 Click **Next**, then enter the Network Name.

5 Click **Next**, then select an encryption option.

Each of these steps is described in more detail on subsequent pages.

Note If you change the Network Name (SSID) or the Encryption Password and forget the values, you must reset the gateway to the factory default settings. The reset button is located on the back of the gateway and is not labeled. This button is recessed. Use a paper clip to depress the button for at least 5 seconds. You may then reconfigure the gateway with the settings given to you by your ISP, and the 802.11b wireless adapters with the default gateway settings.

Using the Wireless Network Configuration Wizard

The Wireless Network Wizard guides you through the steps necessary to configure a wireless network with your Gateway.

- Related topics**
- See *Specifying a wireless network name (SSID)* on page 37.
 - See *Correcting for wireless interference* on page 39.
 - See *Changing or disabling encryption settings* on page 42.
 - See *Specifying a wireless encryption key from text* on page 44.
 - See *Entering a key manually* on page 46.
 - See *Disabling wireless encryption* on page 49.

Step-by-step To use the Wireless Wizard:

- 1 Click the **Settings** menu to expand its selections.
- 2 Click **Wireless** to view your current wireless settings, then click the **Wireless Setup** button to enter the Wireless Setup Wizard.

The following appears.

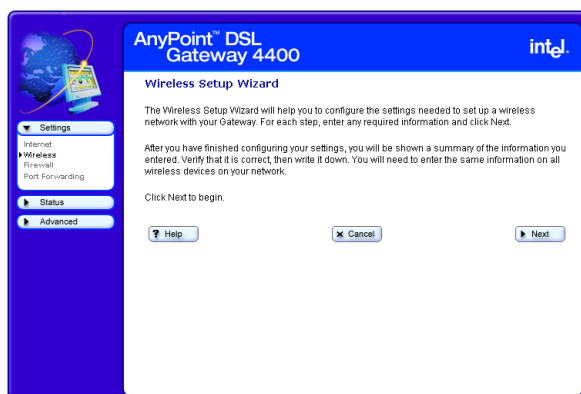

- 3 For each step, enter any required information then click **Next**.

- 4 Click **Help** on any screen for more information.
- 5 Click **Back** on any screen to move back to the previous window.
- 6 Click **Next** on any screen to move forward to the next window.
- 7 Click **Cancel** on any screen to exit the Wireless Wizard, without applying changes.

More about

To communicate with each other, all wireless devices on the same network must use the same Network Name (SSID) and Encryption Password (if encryption is enabled). In the next several screens you will enter the Network Name and specify encryption.

Specifying a wireless network name (SSID)

You specify a network name (SSID) using the Wireless Settings – Network Name screen.

- Related topics**
- See *Correcting for wireless interference* on page 39.
 - See *Changing or disabling encryption settings* on page 42.
 - See *Specifying a wireless encryption key from text* on page 44.
 - See *Entering a key manually* on page 46.
 - See *Disabling wireless encryption* on page 49.

Step-by-step To specify a network name (SSID):

- 1 Click the **Settings** menu to expand its selections.
- 2 Click **Wireless** to view your current wireless settings, then click the **Wireless Setup** button to enter the Wireless Setup Wizard.
- 3 Click **Next** until you see the “Network Name” screen. The following appears.

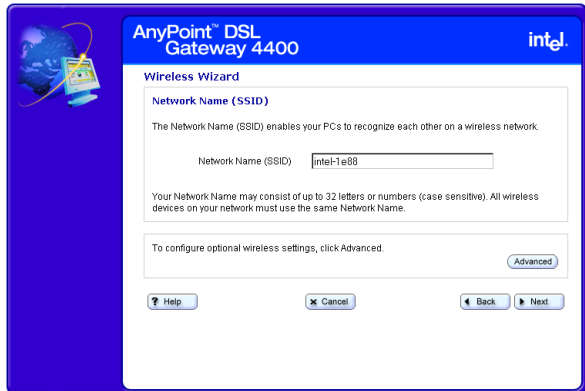

- 4 Enter a string of up to 32 letters or numbers (case sensitive) in the **Network Name (SSID)** field. (See

“Default Network Name,” below, for more information.)

5 Click **Next**.

**Default
Network Name**

The factory default value for the Network Name, unique for each gateway, is located on the bottom of the gateway and is originally displayed in the Network Name (SSID) field. You may want to change this value from the default setting to something you can easily remember.

More about

To communicate with each other, all wireless devices on the same network must use the same Network Name (SSID) and Encryption Password (if encryption is enabled). In this screen you enter the Network Name. On a subsequent screen you will specify an Encryption Password.

Note Network Name is also referred to as SSID, ESSID, BSSID, or network code.

Correcting for wireless interference

If you are experiencing wireless interference you can correct for it using the Advanced Wireless Settings, accessible from the Wireless Settings – Network Name screen.

- Related topics**
- See *Specifying a wireless network name (SSID)* on page 37.
 - See *Changing or disabling encryption settings* on page 42.
 - See *Specifying a wireless encryption key from text* on page 44.
 - See *Entering a key manually* on page 46.
 - See *Disabling wireless encryption* on page 49.

Step-by-step To correct for interference with your wireless connection:

- 1** Click the **Settings** menu to expand its selections.
- 2** Click **Wireless** to view your current wireless settings, then click the **Wireless Setup** button to enter the Wireless Setup Wizard.
- 3** Click **Next** until you see the “Network Name” screen.

4 Click Advanced.

The following appears.

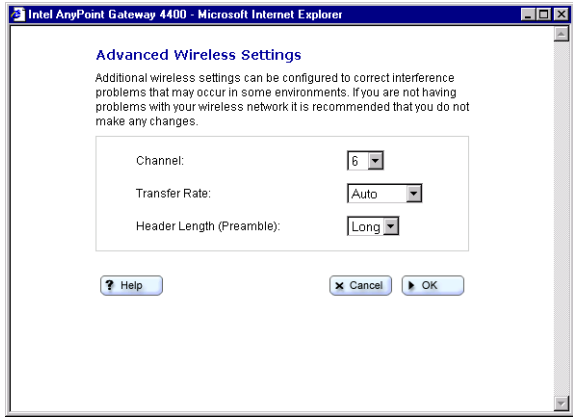

5 Select an alternate channel using the Channel list box.

6 Select an alternate transfer rate using the Transfer Rate box.

More about

Channel

In areas where many networks are using the same channel, throughput on all the networks may decline. In addition, if there is interference on the channel, signal quality is affected. If the performance of your network declines, try selecting another channel. It is recommended that you try channels 6 and 11 first as alternative channels. The default channel is 6.

Transfer Rate

By default, the transfer rate between wireless devices is automatically determined. Generally, you will not need to change this value. However, decreasing the transfer rate may enable you to transmit across greater distances.

Header Length (Preamble)

The Header length is the format for labeling the information sent between devices. The only available setting is Long. The short header length is not supported because not all wireless devices support this feature. You must set all your other wireless devices, to which the gateway is connected, to Long (typically the default setting).

Changing or disabling encryption settings

In a Wireless Local Area Network (WLAN), you can use encryption to implement security and protect your information. The default encryption setting is 40/64-bit hexadecimal. Network encryption does not provide absolute protection for your data, but it does make it more difficult for someone else to intercept that data. It is recommended that you utilize the encryption feature of this product.

Related topics

- See *Specifying a wireless network name (SSID)* on page 37.
- See *Correcting for wireless interference* on page 39.
- See *Specifying a wireless encryption key from text* on page 44.
- See *Entering a key manually* on page 46.
- See *Disabling wireless encryption* on page 49.

Step-by-step

To change or disable encryption:

- 1 Click the **Settings** menu to expand its selections.
- 2 Click **Wireless** to view your current wireless settings, then click the **Wireless Setup** button to enter the Wireless Setup Wizard.

3 Click **Next** until you see the “Encryption” screen.

(Your encryption screen may contain different information, depending on how encryption was last set. See the following encryption topics for more information.)

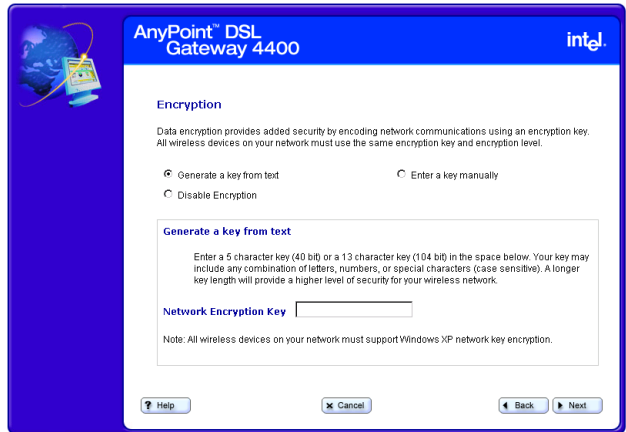
**4** Select an encryption option then enter the required information in the fields associated with that selection. See the following topics for more information.**More about**

The longer the encryption key is, the stronger the encryption. The gateway uses either a 40(64)-bit key or a 104(128)-bit key. A 104(128)-bit key has several trillion times more combinations than a 40(64)-bit key. For added security, you should change your encryption key often.

Important! The gateway and each adapter in the network must have the same encryption keys.

Specifying a wireless encryption key from text

If you have all Intel® AnyPoint® adapters, you can create an encryption key from a 5 or 13 character string. A 5 character string provides 40-bit encryption, while a 13 character string provides 104-bit encryption. The string you enter must be exactly 5 or 13 characters.

Related topics

- See *Specifying a wireless network name (SSID)* on page 37.
- See *Correcting for wireless interference* on page 39.
- See *Changing or disabling encryption settings* on page 42.
- See *Entering a key manually* on page 46.
- See *Disabling wireless encryption* on page 49.

Step-by-step

To specify a wireless encryption key from text:

- 1 Click the **Settings** menu to expand its selections.
- 2 Click **Wireless** to view your current wireless settings, then click the **Wireless Setup** button to enter the Wireless Setup Wizard.
- 3 Click **Next** until you see the “Encryption” screen.

4 Click the **Generate a key from text** option.

The following appears.



5 Enter a 5-character (40-bit) or a 13-character (104-bit) string, in any combination of letters, numbers, or special characters (case sensitive) in the **Network Encryption Key** field.

Entering a key manually

If you are *not* using Intel® AnyPoint® network adapters you can manually enter a key, either as a series of 40/64 bit or 104/128-bit hexadecimal digits (characters 0 through 9 and A through E) or as 40/64 bit or 104/128-bit ASCII characters (any character).

Related topics

- See *Specifying a wireless network name (SSID)* on page 37.
- See *Correcting for wireless interference* on page 39.
- See *Changing or disabling encryption settings* on page 42.
- See *Specifying a wireless encryption key from text* on page 44.
- See *Disabling wireless encryption* on page 49.

Step-by-step

To enter a key manually:

- 1 Click the **Settings** menu to expand its selections.
- 2 Click **Wireless** to view your current wireless settings, then click the **Wireless Setup** button to enter the Wireless Setup Wizard.
- 3 Click **Next** until you see the “Encryption” screen.

4 Click the **Enter a key manually** option.

Your screen will look similar to the following.

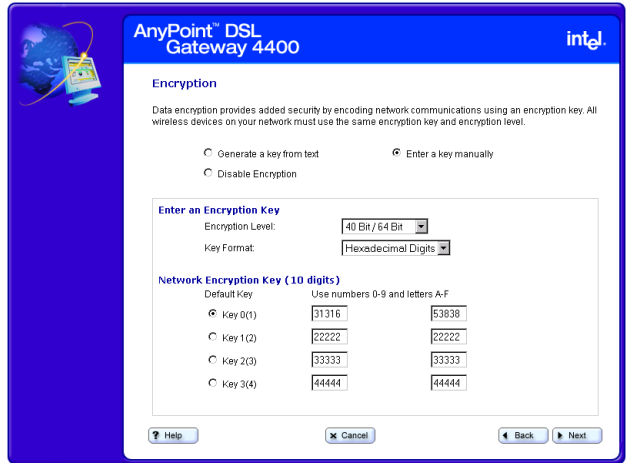
**5** Select either **Hexadecimal digits** or **ASCII Characters** from the **Key Format** list box.**6** Select either **40 Bit/64 Bit** or **104 Bit/128 Bit** from the **Encryption Level** list box.**7** Click a **Key** option, then enter a unique 10 hexadecimal digit (2 pairs of 5-digits) string in its associated field. The four Key options allow you to specify four different keys that you can select at any time.

Note You can only use one encryption key at a time. Having four sets of keys allows you to quickly change your encryption, if necessary.

More about

A 40/64-bit key can consist of 10 hexadecimal digits or 5 ASCII characters:

- Example Hex Key: 1AC78 24DE5
- Example ASCII Key: JimBo

A 104/128-bit key can consist of 26 hexadecimal digits or 13 ASCII characters.

- Example Hex Key: 10111 2EF14 1510 2453 6543
9991
- Example ASCII Key: IntelWireless

Disabling wireless encryption

You can disable encryption if you are not worried about security and want to slightly improve data transmission.

- Related topics**
- See *Specifying a wireless network name (SSID)* on page 37.
 - See *Correcting for wireless interference* on page 39.
 - See *Changing or disabling encryption settings* on page 42.
 - See *Specifying a wireless encryption key from text* on page 44.
 - See *Entering a key manually* on page 46.

Step-by-step To disable the encryption settings:

- 1 Click the **Settings** menu to expand its selections.
- 2 Click **Wireless** to view your current wireless settings, then click the **Wireless Setup** button to enter the Wireless Setup Wizard.
- 3 Click **Next** until you see the “Encryption” screen.

4 Click the **Disable Encryption** option.

The following appears.



5 Click **Next** to apply the change.

Important! Be sure to also disable encryption for each adapter in your wireless network. Refer to the documentation for you wireless adapter.

More about

In a Wireless Local Area Network (WLAN), you can use encryption to implement security and protect your information. The default encryption setting is 40/64-bit hexadecimal. Network encryption does not provide absolute protection for your data, but it does make it more difficult for someone else to intercept that data. It is recommended that you utilize the encryption feature of this product.

Configuring the gateway's firewall

The gateway includes a built-in firewall set to a Normal security level, by default. A “Normal” security level means that internal processes or modules such as the Universal Plug and Play Internet Gateway Device (UPnP IGD) have permission to dynamically auto-configure port-forward rules in their respective domains to provide ease of use. It also means that HTTP UI smart port-forwarding is enabled. As a result, Internet applications that require user configured port-forwarding rules are available.

- Related topics**
- See *Specifying the firewall security level* on page 53.
 - See *Specifying intrusion detection settings* on page 55.
 - See *Specifying IP addresses to be excluded from being blocked* on page 57.

Step-by-step To configure the gateway's firewall:

- 1 Click the **Settings** menu to expand its selections.
- 2 Click **Firewall**.

The following appears.

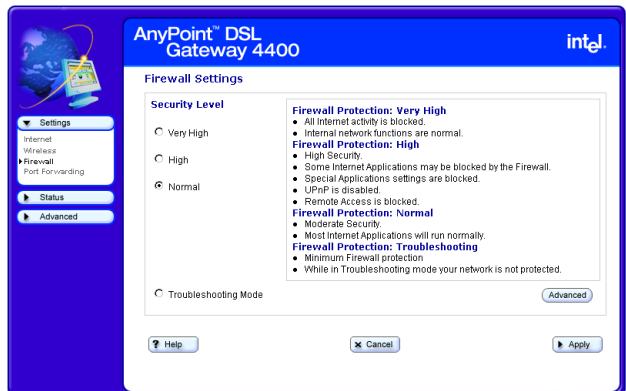

- 3 Select a security level from the main screen, specify intrusion detection settings or specify IP addresses to

be excluded from the firewall detection system from the Advanced screen. You can also allow your service provider to troubleshoot your network directly by clicking the **Troubleshooting mode** option.

More about Specific details about each of the firewall settings are described in the next several topics.

Specifying the firewall security level

You specify the firewall security level using the Firewall Settings main screen.

- Related topics**
- See *Specifying intrusion detection settings* on page 55.
 - See *Specifying IP addresses to be excluded from being blocked* on page 57.

Step-by-step To specify the firewall security level:

- 1 Click the **Settings** menu to expand its selections.
- 2 Click **Firewall**.

The following appears.

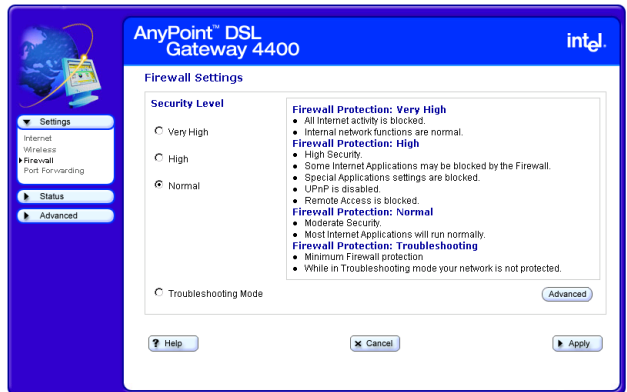

- 3 Select one of the following options (see More About for more information about the options):
 - **Very High**
 - **High**
 - **Normal** (default)
- 4 Select **Troubleshooting Mode** to allow your service provider to troubleshoot your network by accessing it directly.

- 5 [Optional] Click **Advanced** to specify intrusion detection settings and/or to exclude specific IP addresses from the firewall intrusion detection system.
- 6 Click **Apply** to save these new settings.

More about

Following describes the three levels of firewall protection available for the gateway:

- **Very High** – all incoming/outgoing traffic over the WAN interface is blocked and the home network is isolated from the Internet.
- **High** – all user configured port-forwarding rules are disabled. No user or application can remove port-forwarding rules. HTTP UI smart port-forwarding is disabled. As a result, Internet applications that require user configured port-forwarding rules will *not* be available.
This mode is appropriate for home users who just want to access the Internet from their client PCs and do not plan to run any special server software in their home network.
- **Normal** (default) – Internal processes or modules such as the Universal Plug and Play Internet Gateway Device (UPnP IGD) have permission to dynamically auto-configure port-forward rules in their respective domains to provide ease of use. HTTP UI smart port-forwarding is enabled. As a result, Internet applications that require user configured port-forwarding rules are available.

Specifying intrusion detection settings

You specify intrusion detection settings using the firewall security settings Advanced screen.

- Related topics**
- See *Specifying the firewall security level* on page 53.
 - See *Specifying IP addresses to be excluded from being blocked* on page 57.

Step-by-step To specify intrusion detection settings:

- 1 Click the **Settings** menu to expand its selections.
- 2 Click **Firewall**.
- 3 Click **Advanced**.

The following appears.



- 4 Do any of the following:
 - **Disable Intrusion Detection** (Not recommended) – Click this checkbox to disable the firewall intrusion detection system.

Important! Disabling the intrusion detection system opens your network to unsolicited Internet traffic, thus making your network susceptible to intrusion attacks, viruses, and so on.

- **Set IP Blocking Threshold** – Enter a number in this text field. See More About for more information.
- **Set Blocking Duration** – Enter a number in this text field. See More About for more information.
- **Blocking Exception List** – Click this button to access another screen in which you can specify IP addresses to be excluded from being blocked.
- **View the Security Log** – Click this button to view the Security Log.
- **Unblock All** – Click this button to exclude all IP addresses from being blocked.

5 Click **Apply** to save these new settings.

More about

Following describes the IP Blocking Threshold and Blocking Duration in more detail.

- **Set IP Blocking Threshold** – This sets the maximum number of port scans that can occur by an external IP address before that IP address is blocked. Enter a number in this text field. The default value is 3. Recommended range is 2-5.
- **Set Blocking Duration** – This sets the minimum duration during which a detected intruding IP address cannot access your network. Enter a number in this text field. The default value is 30 (minutes). Recommended blocking duration should not exceed one day.

Specifying IP addresses to be excluded from being blocked

You specify IP addresses to be excluded from being blocked by the firewall intrusion detection system using the firewall security settings Advanced screen.

- Related topics**
- See *Specifying the firewall security level* on page 53.
 - See *Specifying intrusion detection settings* on page 55.

Step-by-step To specify IP addresses to be excluded from being blocked:

- 1 Click the **Settings** menu to expand its selection.
- 2 Click **Firewall**.
- 3 From the Firewall Settings screen, click **Advanced**.
- 4 From the Intrusion Detection Settings screen, click **Blocking Exception List**.

The following appears.

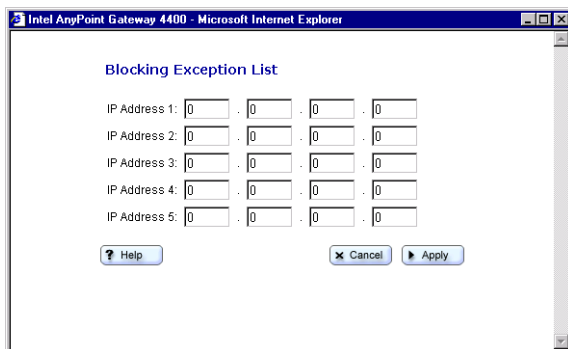

Blocking Exception List

IP Address 1: . . .

IP Address 2: . . .

IP Address 3: . . .

IP Address 4: . . .

IP Address 5: . . .

- 5 Enter each IP address to be blocked in the fields provided.
- 6 Click **Apply** to apply these settings.

Important! Allowing an external IP address complete access to your network opens your network to unsolicited Internet traffic from that IP address, thus making your network susceptible to intrusion attacks, viruses, and so on.

Using port forwarding

Port forwarding is useful if you have a web server running on a computer on your local network. It allows you to automatically direct traffic to a specific computer on your network. You may also need port forwarding to host some multi-player games, for video phone applications, and for other interactive applications.

Related topics

- See *Enabling port forwarding* on page 61.
- See *Selecting a target computer by name* on page 63.
- See *Selecting a target computer by IP address* on page 65.
- See *Creating a custom rule* on page 67.

Step-by-step

To enable port forwarding:

- 1 Click the **Settings** menu to expand its selections.
- 2 Click **Port Forwarding**.

The following appears.

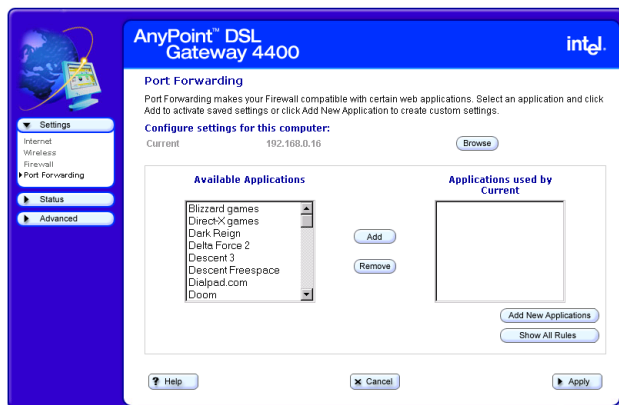

You can use this screen to:

- specify the computer on your network to which the inbound traffic is to be directed.
- specify the service (or application) the inbound traffic is intended for – for instance, POP3, FTP, HTTP, and so on.
- Create a custom rule that defines a specific port and protocol for unsolicited inbound traffic.

More about

Specific details about using port forwarding are described in the next several topics.

Enabling port forwarding

You configure your port forwarding requirement using the Port Forwarding screen.

- specify the computer on your network to which the inbound traffic is to be directed.
- specify the service (or application) the inbound traffic is intended for – for instance, POP3, FTP, HTTP, and so on.
- Create a custom rule that defines a specific port and protocol for unsolicited inbound traffic.

Related topics

- See *Selecting a target computer by name* on page 63.
- See *Selecting a target computer by IP address* on page 65.
- See *Creating a custom rule* on page 67.

Step-by-step

To enable port forwarding:

- 1 Click the **Settings** menu to expand its selections.
- 2 Click **Port Forwarding**.

The following appears.

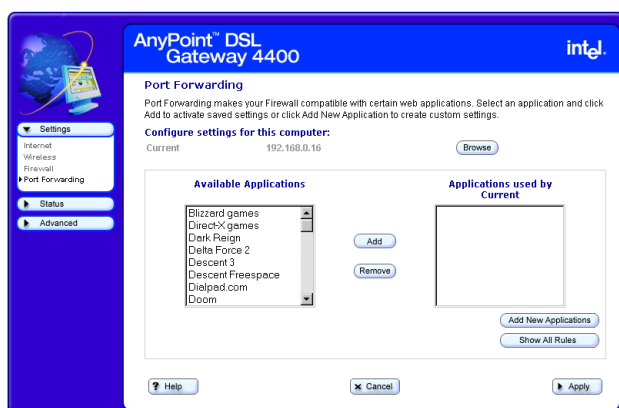

- 3 [Optional] Click **Add New Applications** to create a custom rule.
- 4 Click **Browse** to specify the computer on your network to which the inbound traffic is to be directed. (You can then select from a list of available computers or enter an IP address manually.)
- 5 Click **Add** to select a service (or application) the inbound traffic is intended for on the target computer.
- 6 [Optional] Click **Show All Rules** to see a summary of how ports are being forwarded to the computers on your network.
- 7 Click **Apply** to apply your changes.

More about

Your gateway supports up to 20 ports or ranges of ports. Port forwarding only applies to unsolicited inbound traffic. If you enter an address to access a web page on the Internet, the Web page is displayed on your browser. This is known as solicited traffic.

Note If you don't use port forwarding, then all unsolicited inbound traffic is blocked by the gateway's internal firewall.

Depending on the application or game that requires port forwarding, you may find configuration information in its documentation or on the Web.

Selecting a target computer by name

You can select a target computer by name on your network to which inbound traffic is to be directed using the Select a Computer screen, accessible from the main Port Forwarding screen.

Related topics

- See *Enabling port forwarding* on page 61.
- See *Selecting a target computer by IP address* on page 65.
- See *Creating a custom rule* on page 67.

Step-by-step

To select a target computer by name:

- 1 Click the **Settings** menu to expand its selections.
- 2 Click **Port Forwarding**.
- 3 From the Port Forwarding screen, click **Browse**.
- 4 Click **Select from available computers**.

The following appears.



- 5 Select a target computer from the list.
- 6 Click **OK**.

More about The **Select from available computers** option is selected by default (the assumption is that your network assigns IP addresses via DHCP). If you need to target a computer that is not listed, and you know its IP address, then select the **Enter an IP address manually** option and read its online Help for more information.

Selecting a target computer by IP address

You can select a target computer by IP address on your network to which inbound traffic is to be directed using the Select a Computer screen, accessible from the main Port Forwarding screen.

- Related topics**
- See *Enabling port forwarding* on page 61.
 - See *Selecting a target computer by name* on page 63.
 - See *Creating a custom rule* on page 67.

Step-by-step To select a target computer by IP address:

- 1 Click the **Settings** menu to expand its selections.
- 2 Click **Port Forwarding**.
- 3 From the Port Forwarding screen, click **Browse**.
- 4 Click **Enter an IP address manually**.

The following appears.

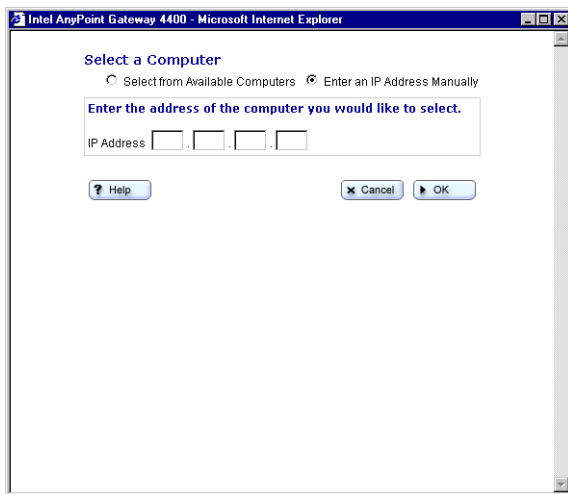

- 5 Enter the IP address of the target computer in the **IP Address** field.
- 6 Click **OK**.

More about The **Select from available computers** option is selected by default (the assumption is that your network assigns IP addresses via DHCP). Use the **Enter an IP address manually** option, instead, if you need to target a computer that is not listed, and you know its IP address.

Creating a custom rule

You can create a custom rule that defines a specific port and protocol for unsolicited inbound traffic using the Add New Application screen, accessible from the main Port Forwarding screen.

- Related topics**
- See *Enabling port forwarding* on page 61.
 - See *Selecting a target computer by name* on page 63.
 - See *Selecting a target computer by IP address* on page 65.

Step-by-step To create a custom rule:

- 1 Click the **Settings** menu to expand its selections.
- 2 Click **Port Forwarding**.

3 From the Port Forwarding screen, click **Add New Application.**

The following appears.

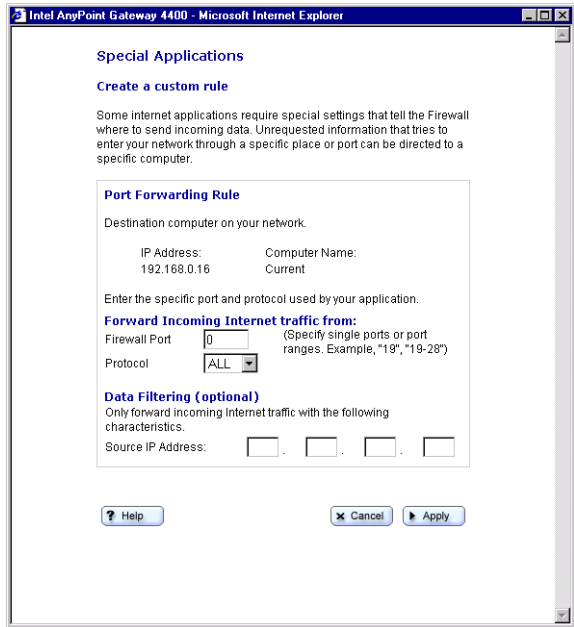

- 4** Enter a port number or range of ports in the **Firewall Port** field.
- 5** Select a transport layer protocol from the **Protocol** list box.
- 6** [Optional] For increased security purposes, enter a **Source IP Address** to restrict incoming data from a specific computer.

More about

Ports can be forwarded individually or as a range separated by a dash (for example, 23 or 24-1023).

The port numbers can be entered in the table in any order.

A range may be specified and then individual numbers within that range may be directed to a different IP address. For example, you may enter a range of 1-1024

in the Port field and an IP address of 192.168.0.251. You may then designate Ports 23, 80, and 53 to IP address 192.168.0.252. Traffic destined for Ports 23, 80, and 53 only go to IP address 192.168.0.252.

Chapter 4

Using Advanced Configuration Options

This chapter describes the gateway's advanced feature set. It provides instructions for changing advanced wireless settings, changing the gateway password, resetting the gateway or reloading default settings, enabling remote access, enabling Universal Plug and Play, and so on.

- Accessing advanced configuration options
- Changing the gateway password
- Specifying wireless security settings
- Resetting the gateway or reloading default settings
- Exposing a computer outside the firewall
- Enabling remote access
- Specifying the Host and Domain names
- Specifying LAN and DHCP settings
- Disabling Universal Plug and Play (UPnP)

Accessing advanced configuration options

You use the Advanced Features to specify such things as wireless security settings, LAN and DHCP settings, and additional features as listed below.

Related topics

- See *Changing the gateway password* on page 74.
- See *Specifying wireless security settings* on page 76.
- See *Resetting the gateway or reloading default settings* on page 79.
- See *Exposing a computer outside the firewall* on page 81.
- See *Enabling remote access* on page 83.
- See *Specifying the Host and Domain names* on page 85.
- See *Specifying LAN and DHCP settings* on page 87.
- See *Disabling Universal Plug and Play (UPnP)* on page 90.

Step-by-step

To use the advanced features:

- 1 Click the **Advanced** menu to expand its selections.

The following appears.

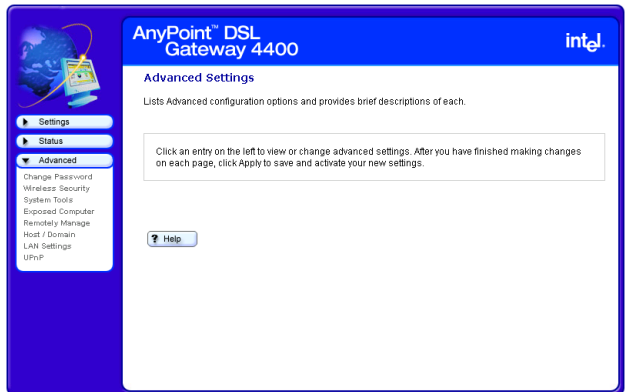

- 2 Select an Advanced menu option.
- 3 Make the change on the Advanced feature screen then click **Apply**.

More about Read the help pages associated with each Advanced Settings screen for more information.

Changing the gateway password

The gateway is password protected to prevent network users from gaining access and changing settings.

Related topics

- See *Accessing advanced configuration options* on page 72.
- See *Specifying wireless security settings* on page 76.
- See *Resetting the gateway or reloading default settings* on page 79.
- See *Exposing a computer outside the firewall* on page 81.
- See *Enabling remote access* on page 83.
- See *Specifying the Host and Domain names* on page 85.
- See *Specifying LAN and DHCP settings* on page 87.
- See *Disabling Universal Plug and Play (UPnP)* on page 90.

Step-by-step

To change the gateway password:

- 1 Click the **Advanced** menu to expand its selections.
- 2 Click **Change Password**.

The following appears.

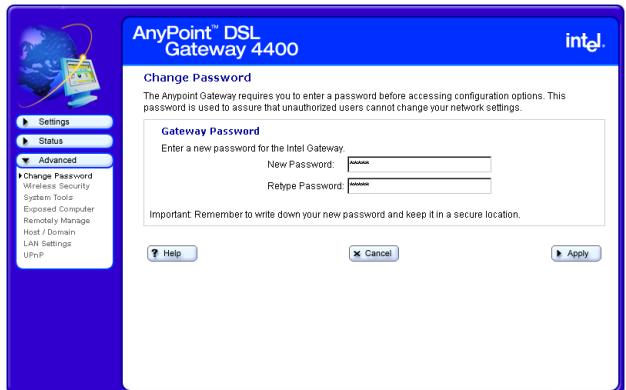

- 3 Type your new password, then retype it to verify.
- 4 Click **Apply** to save your settings.

More about Use the following rules when creating a password.

- Five characters minimum
- At least two non-alpha characters
- No more than three identical characters
- The password should not appear in a dictionary

Specifying wireless security settings

You can specify scanning access to your wireless network and create a list of users that allows or prevents access to your network.

- Related topics**
- See *Accessing advanced configuration options* on page 72.
 - See *Changing the gateway password* on page 74.
 - See *Resetting the gateway or reloading default settings* on page 79.
 - See *Exposing a computer outside the firewall* on page 81.
 - See *Enabling remote access* on page 83.
 - See *Specifying the Host and Domain names* on page 85.
 - See *Specifying LAN and DHCP settings* on page 87.
 - See *Disabling Universal Plug and Play (UPnP)* on page 90.

Step-by-step To specify wireless security settings:

- 1 Click the **Advanced** menu to expand its selections.
- 2 Click **Wireless Security**.

The following appears.

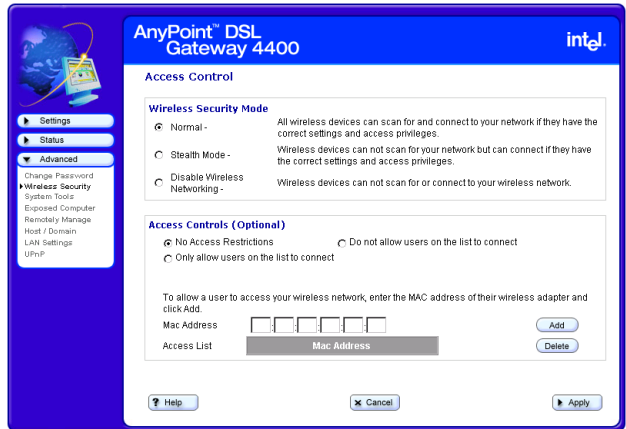

- 3 Use the Access Control fields, **Add**, and **Delete** buttons to create a list of users you wish to either provide access to or prevent access from your wireless network. (You can only create one list that you will then specify as “provide access to” or “do not allow access to” your wireless network, using one of two option buttons.)
- 4 In the same Access Control List section of the screen, select one of the following:
 - **No access restrictions** – Click this to allow unrestricted access to your wireless network.
 - **Only allow users on the list to connect** – Click this to allow only users listed on the Access Control List to connect to your wireless network.
 - **Do not allow users on the list to connect** – Click this to prevent the users listed on the Access Control List from connecting to your wireless network.

- 5 In the **Wireless Security Mode** section of the screen, select one of the following:
 - **Normal** – All wireless devices can scan for and connect to your network if they have the correct settings and access privileges.
 - **Stealth Mode** – Wireless devices cannot scan for your network but can connect if they have the correct settings and access privileges.
 - **Disabled** – Wireless devices cannot scan for or connect to your wireless network.
- 6 Click **Apply** to save your settings.

Resetting the gateway or reloading default settings

You can reset the gateway or reload the gateway default settings using the System Tools screen, accessible from the Advanced menu.

Related topics

- See *Accessing advanced configuration options* on page 72.
- See *Changing the gateway password* on page 74.
- See *Specifying wireless security settings* on page 76.
- See *Exposing a computer outside the firewall* on page 81.
- See *Enabling remote access* on page 83.
- See *Specifying the Host and Domain names* on page 85.
- See *Specifying LAN and DHCP settings* on page 87.
- See *Disabling Universal Plug and Play (UPnP)* on page 90.

Step-by-step To reset the gateway or reload its default settings:

- 1 Click the **Advanced** menu to expand its selections.
- 2 Click **System Tools**.

The following appears.

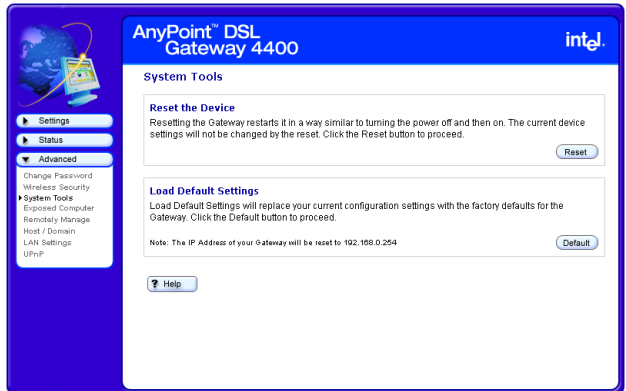

- 3 Do one of the following:
 - Click **Reset**. The gateway is restarted using your previously saved configuration.
 - Click **Default**. The gateway is restarted using the factory default configuration and IP address.

Exposing a computer outside the firewall

You can specify one computer on your network to be placed outside the gateway's built-in firewall using the Exposed Computer screen, accessible from the Advanced menu.



CAUTION Any computer you place outside the gateway's built-in firewall may be vulnerable to attacks and unauthorized access.

Related topics

- See *Accessing advanced configuration options* on page 72.
- See *Changing the gateway password* on page 74.
- See *Specifying wireless security settings* on page 76.
- See *Resetting the gateway or reloading default settings* on page 79.
- See *Enabling remote access* on page 83.
- See *Specifying the Host and Domain names* on page 85.
- See *Specifying LAN and DHCP settings* on page 87.
- See *Disabling Universal Plug and Play (UPnP)* on page 90.

Step-by-step To expose a computer on your network outside the gateway's firewall:

- 1 Click the **Advanced** menu to expand its selections.
- 2 Click **Exposed Computer**.

The following appears.

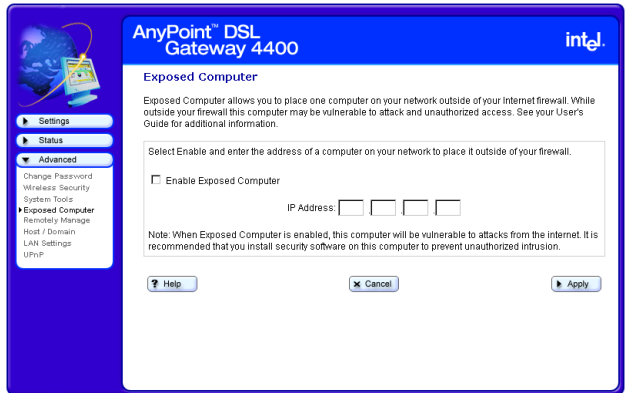

- 3 Click (select) the **Enable Exposed Computer** checkbox.
- 4 Enter the IP address of the computer to be exposed in the **IP Address** field.
- 5 Click **Apply**.

Enabling remote access

You can allow your ISP to access your gateway remotely for troubleshooting using the Remote Management screen, accessible from the Advanced menu.

Related topics

- See *Accessing advanced configuration options* on page 72.
- See *Changing the gateway password* on page 74.
- See *Specifying wireless security settings* on page 76.
- See *Resetting the gateway or reloading default settings* on page 79.
- See *Exposing a computer outside the firewall* on page 81.
- See *Specifying the Host and Domain names* on page 85.
- See *Specifying LAN and DHCP settings* on page 87.
- See *Disabling Universal Plug and Play (UPnP)* on page 90.

Step-by-step

To enable remote access:

- 1 Click the **Advanced** menu to expand its selections.
- 2 Click **Remotely Manage**.

The following appears.

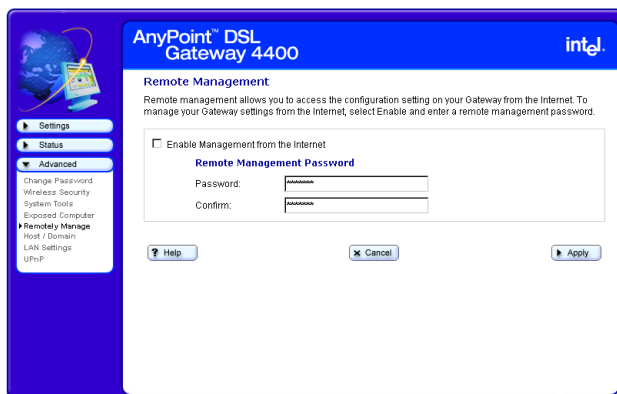

- 3 Select the **Enable Remote Management from the Internet** checkbox.
- 4 Enter the remote management password.
- 5 Click **Apply** to save your settings.

More about

Enabling remote access to your gateway can be a security risk. Use extreme caution when enabling this setting. Make sure that any request you receive to enable remote access to your gateway is from someone authorized to access or service your gateway.

Specifying the Host and Domain names

You can specify the Host Name and Domain Name that will be used by your gateway using the Host Name / Domain Name screen, accessible from the Advanced menu.

Related topics

- See *Accessing advanced configuration options* on page 72.
- See *Changing the gateway password* on page 74.
- See *Specifying wireless security settings* on page 76.
- See *Resetting the gateway or reloading default settings* on page 79.
- See *Exposing a computer outside the firewall* on page 81.
- See *Enabling remote access* on page 83.
- See *Specifying LAN and DHCP settings* on page 87.
- See *Disabling Universal Plug and Play (UPnP)* on page 90.

Step-by-step

To specify the Host Name and Domain Name:

- 1 Click the **Advanced** menu to expand its selections.
- 2 Click **Host /Domain**.

The following appears.

The screenshot shows the configuration interface for an AnyPoint DSL Gateway 4400. The interface has a blue header with the Intel logo and the text 'AnyPoint DSL Gateway 4400'. Below the header, the title 'Host Name / Domain Name' is displayed. The main content area contains the instruction 'Enter the Host Name and Domain Name that will be used by your Gateway.' followed by two input fields: 'Host Name' and 'Domain Name'. At the bottom of the form, there are three buttons: 'Help', 'Cancel', and 'Apply'. On the left side of the interface, there is a navigation menu with the following items: 'Settings', 'Status', 'Advanced' (which is expanded to show 'Change Password', 'Wireless Security', 'System Tools', 'Exposed Computer', 'Remotely Manage', 'Host / Domain', 'LAN Settings', and 'UPnP').

- 3 Enter a host name in the **Host Name** field exactly as it was given to you by your ISP.
- 4 Enter a domain name in the **Domain Name** field exactly as it was given to you by your ISP.
- 5 Click **OK**.

Specifying LAN and DHCP settings

You can specify or change the IP address of the gateway or to enable/disable the gateway's DHCP control using the LAN Settings screen, accessible from the Advanced menu.

Related topics

- See *Accessing advanced configuration options* on page 72.
- See *Changing the gateway password* on page 74.
- See *Specifying wireless security settings* on page 76.
- See *Resetting the gateway or reloading default settings* on page 79.
- See *Exposing a computer outside the firewall* on page 81.
- See *Enabling remote access* on page 83.
- See *Specifying the Host and Domain names* on page 85.
- See *Disabling Universal Plug and Play (UPnP)* on page 90.

Step-by-step

To specify or change the IP address of the gateway or to enable/disable the gateway's DHCP control:

- 1 Click the **Advanced** menu to expand its selections.
- 2 Click **LAN Settings**.

The following appears.

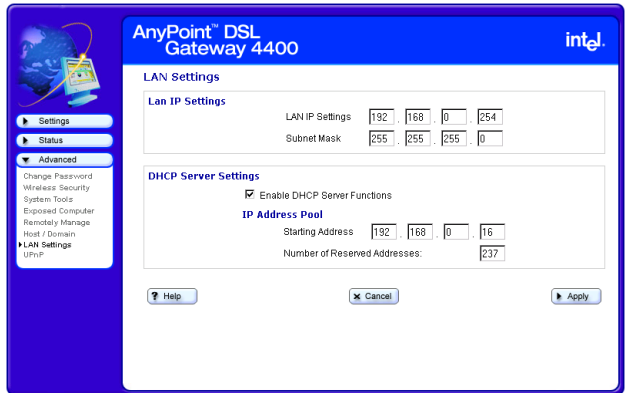

To specify or change the gateway's IP address:

- 1 Enter (or change) the LAN IP Address in the **LAN IP Settings** field.
- 2 Enter your Subnet Mask in the **Subnet Mask** field.
- 3 Click **Apply** to save your settings.

To enable or disable the gateway's DHCP control:

- 1 Select the **Enable DHCP Server Functions** checkbox if you are using the gateway to automatically assign IP addresses to the computers on your network (or deselect this checkbox to disable the gateway's DHCP control).
- 2 Enter a starting address in the **Starting Address** field.

- 3 Enter a list of reserved addresses in the **Number of Reserved Addresses** field.

Note Some computers on your network may need to be restarted if DHCP is enabled on the gateway. The DHCP Server then assigns each computer an IP address.

- 4 Click **Apply** to save your settings.

More about

Following is an explanation of IP Address, Subnet Mask, and DHCP Server.

IP Address

The IP address of the gateway that the computers on your local network use to communicate with the gateway and send traffic to an external network or to another computer on your local network.

Subnet Mask

The Subnet Mask provides additional routing information for traffic within your local network.

DHCP Server

The DHCP server assigns IP addresses to each computer on your local network. If the DHCP Server is enabled on the gateway, then IP addresses are assigned automatically. If the DHCP Server is not enabled, then each IP address for each computer on your local network is entered individually and remains static.

Disabling Universal Plug and Play (UPnP)

You can disable Universal Plug and Play (enabled, by default) using the UPnP screen, accessible from the Advanced menu. (Universal Plug and Play allows supported operating systems and application software to automatically configure a connection to the Internet.)

Related topics

- See *Accessing advanced configuration options* on page 72.
- See *Changing the gateway password* on page 74.
- See *Specifying wireless security settings* on page 76.
- See *Resetting the gateway or reloading default settings* on page 79.
- See *Exposing a computer outside the firewall* on page 81.
- See *Enabling remote access* on page 83.
- See *Specifying the Host and Domain names* on page 85.
- See *Specifying LAN and DHCP settings* on page 87.

Step-by-step To disable Universal Plug and Play (UPnP):

- 1 Click the **Advanced** menu to expand its selections.
- 2 Click **UPnP**.

The following appears.

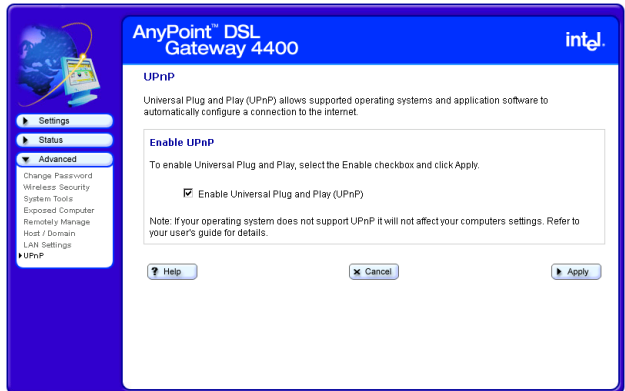

- 3 Unselect the **Enable Universal Plug and Play (UPnP)** checkbox to deselect this option.
- 4 Click **Apply** to save your settings.
The Advanced Settings screen is displayed again, showing the changes that were made.

Chapter 5

Diagnostics and Troubleshooting

This chapter explains how to diagnose and troubleshoot problems that may occur while using your gateway. It explains how to get status information or system details, how to run diagnostics, and how to troubleshoot connection problems.

- Getting network status information
- Running Diagnostics
- Problems and solutions

Getting network status information

You can view the LAN, WAN, Wireless Network, and Firewall/Security settings of your gateway using the Network Status screen, accessible from the Status menu.

- Related topics**
- See *Running Diagnostics* on page 107.
 - See *Problems and solutions* on page 108.

Step-by-step To view the network status information of your gateway:

- 1 Click the **Status** menu to expand its selections.
- 2 Click **Network Status**.

The following appears.

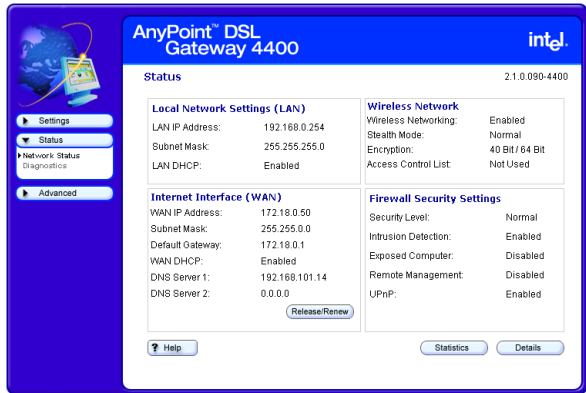

- 3 Click **Statistics** to view detailed statistics on the gateway.
- 4 Click **Details** to view the interface configurations of your gateway.

More about Following is an explanation of each setting.

Local Network Settings (LAN)

LAN IP address

Description: The IP address is the address of the gateway that the computers on your local network use to communicate with the gateway and send traffic to an external network or to another computer on your local network. To specify or change the IP address of the gateway, click **Advanced > LAN Settings**. Click its **Help** button for more information.

Default: 192.168.0.254

Subnet Mask

Description: The Subnet Mask provides additional routing information for traffic within your local network. To specify or change the subnet mask of the gateway, click **Advanced > LAN Settings**. Click its **Help** button for more information.

Default: 255.255.255.0

LAN DHCP

Description: The DHCP Server assigns IP addresses to each computer on your local network. If the DHCP Server is enabled on the gateway, then IP addresses are assigned automatically. If the DHCP Server is not enabled, then each IP address for each computer on your local network is entered individually and remains static. To enable or disable the gateway's DHCP control, click **Advanced > LAN Settings**. Click its **Help** button for more information.

Default: Enabled

Internet Interface (WAN)

WAN IP address	<p>Description: The IP address is the address of the Internet Interface. This is the address that allows external traffic (data) to reach your local network. This information is provided to you by your ISP.</p> <p>Default: Provided by ISP.</p>
Subnet Mask	<p>Description: The Subnet Mask resembles an IP address and helps route Internet traffic to your particular subnet or local network. This information is provided to you by your ISP.</p> <p>Default: Provided by ISP</p>
Default Gateway	<p>Description: The default gateway is the IP address of the device on your ISP's network used to route traffic to the Internet. The gateway sends all messages that are <i>not</i> addressed to devices on your local network to this location. This information is provided to you by your ISP.</p> <p>Default: Provided by ISP</p>
WAN DHCP	<p>Description: The WAN DHCP indicates whether or not your ISP is generating IP addresses.</p> <p>Default: Disabled</p>
DNS Servers 1 & 2	<p>Description: The DNS Servers translate a numeric IP address into a human-readable address. For example, 192.168.0.254 is a numeric IP address, and www.intel.com is a human-readable address. These two fields show the IP address of the DNS Servers at your ISP's site. This information is provided to you by your ISP.</p> <p>Default: Provided by ISP</p>
Wireless Network	

Wireless Networking

Description: Indicates whether or not Wireless Networking has been enabled. To set up wireless networking, click **Settings > Wireless**, then click the **Wireless Setup** button to access the Wireless Wizard. Click the **Help** button on any of the Wireless Wizard's screens for more information.

Default: Enabled if configured.

Stealth Mode

Description: Indicates whether or not Stealth mode has been enabled. You enable Stealth mode to prevent other wireless devices from scanning for your network (but does not prevent them from connecting if they have the correct settings and access privileges). To enable Stealth mode, click **Advanced > Wireless Security**, then select the **Stealth Mode** option. Click its **Help** button for more information.

Default: Normal.

Encryption

Description: Specifies what type of encryption has been selected. The gateway and each adapter in the network must have the same encryption keys. To specify encryption, click **Settings > Wireless**, then click the **Wireless Setup** button to access the Wireless Wizard. Click **Next** until you see the "Wireless Settings – Encryption" screen. Click the **Help** button on any of the Encryption screens for more information.

Default: Depends on selection at setup.

Access Control List	<p>Description: Indicates whether or not an Access Control List has been enabled. The Access Control List, one of the Advanced features, is used to create a list of users that are either allowed access to or prevented access from your network. To create or enable an existing Access Control List, click Advanced > Wireless Security. Click its Help button for more information.</p> <p>Default: Disabled.</p>
<hr/>	
Firewall/Security Settings	
Security Level	<p>Description: Specifies which one of the three types of selectable security levels has been selected. To specify a security level, click Settings > Firewall. Click its Help button for more information.</p> <p>Default: Normal</p>
Intrusion Detection	<p>Description: Indicates whether or not intrusion detection has been enabled. To specify intrusion detection settings, click Settings > Firewall, then click the Advanced button. Click its Help button for more information.</p> <p>Default: Enabled</p>
Exposed Computer	<p>Description: Indicates whether or not a computer on your network has been selected to be exposed outside the firewall. To expose a computer on your network outside the gateway's firewall, click Advanced > Exposed Computer. Click its Help button for more information.</p> <p>Default: Disabled</p>

Remote Management

Description: Indicates whether or not remote management of the gateway has been enabled. To enable remote access, click **Advanced > Remotely Manage**. Click its **Help** button for more information.

Default: Disabled

UPnP

Description: Indicates whether or not Universal Plug and Play (UPnP) has been enabled. To enable UPnP, click **Advanced > UPnP**. Click its **Help** button for more information.

Default: Enabled

Getting status details

You can view the interface configuration of your gateway using the Details screen, accessible from the Network Status screen.

Related topics • See *Getting network status information* on page 94.

Step-by-step To view the interface configuration of your gateway:

- 1 Click the **Status** menu to expand it selections.
- 2 Click **Network Status**.

The following appears.

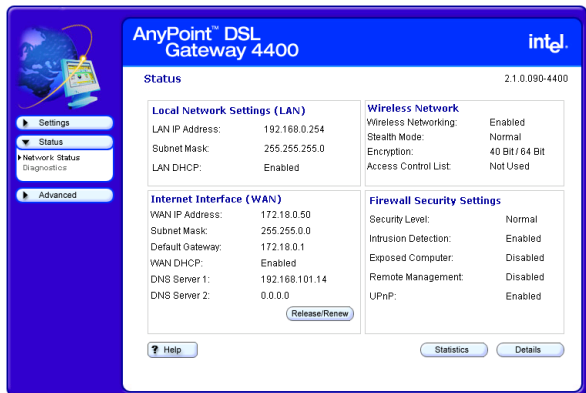

3 Click Details.

The following appears.

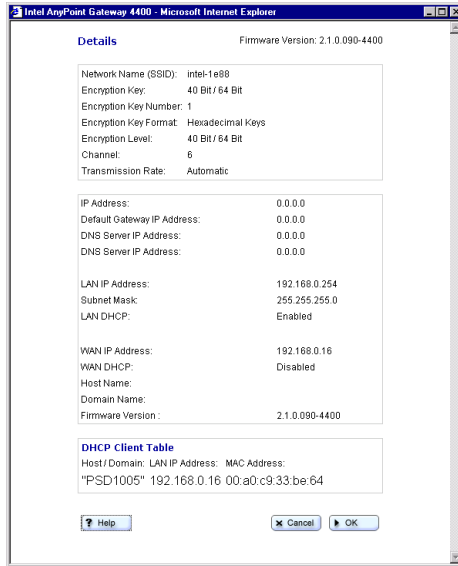

More about Following is an explanation of each setting.

Network Name (SSID)

Description: Indicates the Network Name (also known as SSID, ESSID, BSSID, or network code) currently in use. The Network Name, used in conjunction with the Encryption Key allows all wireless devices on the same network to communicate with each other. To specify a Network Name, click

Settings>Wireless, click the **Wireless Setup** button, then click **Next** until you see the "Network Name" screen. Click its Help button for more information.

Default: Intel-nnnn (where nnnn is a hexadecimal value.)

Encryption Key

Description: Indicates the Encryption Key currently in use. An Encryption Key is used to implement security and protect your information in a wireless network. The Encryption Key, used in conjunction with the Network Name allows all wireless devices on the same network to communicate with each other. To specify an Encryption Key, click

Settings>Wireless, click the **Wireless Setup** button, then click **Next** until you see the "Encryption" screen. Click its Help button for more information.

Default: 40 Bit/64 Bit

Encryption Key Number

Description: Indicates which of four possible sets of encryption keys is currently in use. To specify a Key Number, click **Settings>Wireless**, click the **Wireless Setup** button, then click **Next** until you see the "Encryption" screen. Click its Help button for more information.

Default: 1

Encryption Key Format

Description: Indicates which Encryption Key format is currently in use. The Encryption Key Format indicates how the Encryption Key is generated (from text, from Ascii, from Hexadecimal keys, and so on). To specify a Key Format, click **Settings>Wireless**, click the **Wireless Setup** button, then click **Next** until you see the "Encryption" screen. Click its Help button for more information.

Default: Hexadecimal Keys

Encryption Level

Description: Indicates which Encryption Level is currently in use. The Encryption Level indicates the bit size used to generate the key. To specify an Encryption Level, click **Settings>Wireless**, click the **Wireless Setup** button, then click **Next** until you see the "Encryption" screen. Click its Help button for more information.

Default: 40 Bit/64 Bit

Channel

Description: Indicates which Channel is currently in use. You can select a different channel if you experience interference. To select a different channel, click **Settings>Wireless**, click the **Wireless Setup** button, click **Next** until you see the "Network Name" screen, then click **Advanced**. Click its Help button for more information.

Default: 6

Transmission Rate	Description: Indicates the transmission rate currently in use. You should never need to change this value. However, it may be possible for you to extend the wireless communication distance by decreasing this value. To do so, click Settings>Wireless , click the Wireless Setup button, click Next until you see the "Network Name" screen, then click Advanced . Click its Help button for more information.
	Default: Automatic
IP Address	Description: The IP address is the address of the Internet Interface. This is the address that allows external traffic (data) to reach your local network. This information is provided to you by your ISP.
	Default: Provided by ISP
Default Gateway IP Address	Description: Indicates the IP address of the device on your ISP's network used to route traffic to the Internet. The gateway sends all messages that are not addressed to devices on your local network to this location. This information is provided to you by your ISP.
	Default: Provided by ISP
DNS Server IP address	Description: The DNS Servers translate a numeric IP address into a human-readable address. For example, 192.168.0.254 is a numeric IP address, and www.intel.com is a human-readable address. These two fields show the IP address of the DNS Servers at your ISP's site. This information is provided to you by your ISP.
	Default: Provided by ISP

LAN IP address	Description: The IP address is the address of the gateway that the computers on your local network use to communicate with the gateway and send traffic to an external network or to another computer on your local network. To specify or change the IP address of the gateway, click Advanced > LAN Settings . Click its Help button for more information. Default: 192.168.0.254.
Subnet Mask	Description: The Subnet Mask provides additional routing information for traffic within your local network. To specify or change the subnet mask of the gateway, click Advanced > LAN Settings . Click its Help button for more information. Default: 255.255.255.0.
LAN DHCP	Description: The DHCP Server assigns IP addresses to each computer on your local network. If the DHCP Server is enabled on the gateway, then IP addresses are assigned automatically. If the DHCP Server is not enabled, then each IP address for each computer on your local network is entered individually and remains static. To enable or disable the gateway's DHCP control, click Advanced > LAN Settings . Click its Help button for more information. Default: Enabled
WAN IP Address	Description: The IP address is the address of the Internet Interface. This is the address that allows external traffic (data) to reach your local network. This information is provided to you by your ISP. Default: Provided by ISP

WAN DHCP	<p>Description: The default gateway WAN DHCP is the DNS name that represents the IP address of the device on your ISP's network used to route traffic to the Internet. The gateway sends all messages that are not addressed to devices on your local network to this location. This information is provided to you by your ISP.</p> <p>Default: Client</p>
Host Name	<p>Description: The Host Name used by your gateway. To change the Host Name, click Advanced > Host/Domain. Click its Help button for more information</p> <p>Default: Blank</p>
Domain Name	<p>Description: The Domain Name used by your gateway. To change the Domain Name, click Advanced > Host/Domain. Click its Help button for more information</p> <p>Default: Blank</p>
Firmware Version	<p>Description: Lists the currently installed firmware.</p> <p>Default: Currently installed firmware</p>
DHCP Client Table	<p>Description: List the Host/Domain, LAN IP Address, and MAC Address of the PCs connected on the LAN.</p> <p>Default: N/A.</p>

Running Diagnostics

You can run diagnostics at any time on your gateway and associated network connections using the Diagnostics screen, accessible from the Status menu.

- Related topics**
- See *Getting network status information* on page 94.
 - See *Problems and solutions* on page 108.

Step-by-step To run diagnostics:

- 1 Click the **Status** menu to expand its selections.
- 2 Click **Diagnostics**.

The following appears.

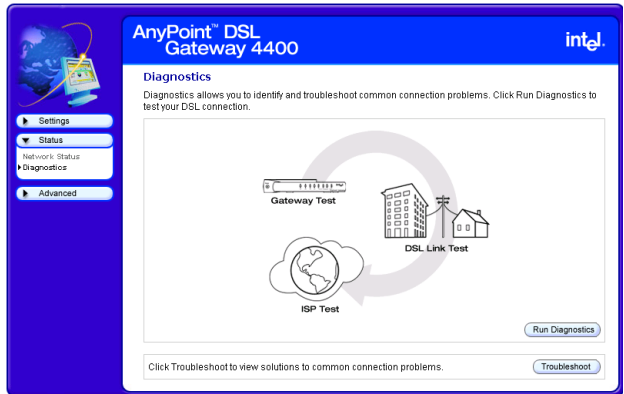

- 3 Click **Run Diagnostics** – your gateway is tested first, then the link to your DSL modem, then the link to your ISP.
- 4 [Optional] Click **Troubleshoot**, if any test fails.

Problems and solutions

Use this chapter to identify and troubleshoot connection problems.

Problem **I can't connect to the gateway**

Solution A **Wired Network**

- Verify that the gateway power is turned ON – the gateway's Power LED (far left LED – separate from the bank of eight LEDs) should be illuminated.
- Verify that the System LED (far left in the bank of eight LEDs) is blinking green, indicating the gateway is operating correctly.
- Verify that the System LED is NOT blinking yellow. The gateway's System LED will blink yellow if the gateway detects another DHCP server connected to one of the four Ethernet connectors. Disconnect each Ethernet cable, one at a time, until the system returns to blinking green. Change the PC you've identified as a DHCP server to a DHCP client.
- Check your connections – see the diagrams in the *Installation Guide*. You may need to replace the cable associated with the connection if the LED differs from the description below:
 - Verify that the Ethernet LED (one of 4 LEDs on the right) is solid or blinking, green or yellow (indicating link at 10 or 100 Mbps)
- Can you access the Gateway Internet Setup Wizard screen? – From your Web browser, enter the Internet address, <http://192.168.0.254> (this is the default value – assumes it has not been changed in the Wireless Gateway configuration software). If the welcome screen does not appear, then make sure the "IP addressing" on the network adapter to which the gateway is connected is set as follows:

This assumes that the Gateway DHCP is still on – which it is on by default, when in gateway mode.

- The adapter is set to obtain an IP address automatically

You can verify the PC adapter is set correctly by going to a MSDOS or command prompt. At the command prompt type:

```
ipconfig /all
```

(leave a space before /all)

- Verify the default Gateway address is 192.168.0.254. If the IP address is correct, but the Welcome screen still doesn't come up, then restart your PC.
- In your Web browser, specify to not use a proxy server when connecting to the Internet (refer to your browser's help pages for information).
- The adapter is set to obtain a DNS address automatically for Windows 2000
- The adapter has DNS disabled for Windows 98, Windows 98SE, or Windows ME.

Solution B Wireless Network

- Follow the above solutions for a wired network
- Verify that there is a wireless client connected – the gateway's Wireless Link LED (third from the right in the bank of eight LEDs) will blink green when it detects traffic.
- Verify that your wireless adapter is set to operate in **Infrastructure** mode and uses the same Network ID (SSID) code and encryption settings as the gateway.

Problem I can't share files and printers among the PCs on my network

Solution

- Verify that each PC on the network can connect to the gateway as described above.
- Verify that each PC can “see” every other PC on the network. For instance, on Windows 2000 you would click “My Network Places” to locate each PC by its system name (on Windows 9x, click “Network Neighborhood”).
- If you add a third-party firewall to a PC, you may be required to configure it to allow internal network communication. Refer to the firewall documentation for assistance.
- Because the operating system network browser can take up to 15 minutes to refresh using TCP/IP, make sure that all PCs have the Microsoft IPX/SPX protocol properly installed with “Frame type” set to 802.3 on the protocol’s Advanced tab.
- Also make sure that Client for Microsoft Networking and File and Print sharing are properly installed, as follows:

Note If you are using AnyPoint[®] adapters, this is all taken care of automatically.

Windows 98 or ME

- 1 Click **Start > Settings > Control Panel > Network**.
- 2 To add file and print sharing, click **File and Print Sharing** and then click **OK**.
- 3 Follow the onscreen prompts to insert your Windows CD and allow your PC to copy the needed files.
- 4 To add a client such as Client for Microsoft Networks or a network protocol, click **Add**.
- 5 Choose from among the subsequent dialogs according to what you wish to add and then click **OK**.
- 6 Follow the screen prompts to insert your Windows CD and allow your PC to copy the needed files.

Windows 2000

- 1 Click **Start > Settings > Control Panel > Network and Dial-up Connections**.
- 2 To add file and print sharing or a client or protocol, right-click the icon representing the network connection your changes should apply to.
- 3 Click **Properties**.
- 4 Click the **Install** button and select either **client**, **service** or **protocol** according to what you wish to add.
- 5 Choose from among the following dialogs then click **OK**
- 6 Follow the screen prompts to insert your CD and allow your PC to copy the needed files.

Windows XP

- 1 Click **Start > Control Panel > Network Connections**.
 - 2 To add file and print sharing or a client or protocol, right-click the icon representing the network connection your changes should apply to.
 - 3 Click **Properties**.
 - 4 Click the **Install** button and select either **client**, **service** or **protocol** according to what you wish to add.
 - 5 Choose from among the following dialogs then click **OK**
- Try again to see that each PC can “see” every other PC on the network. For instance, on Windows 2000 you would click “My Network Places” to locate each

PC by its system name (on Windows 9x, you would click “Network Neighborhood”).

- When other PCs become visible, use standard procedures to share and map drives and printers.

Problem I can’t connect to the Internet through my gateway

The assumption for the solution below is that you *were* able to connect to the Internet before you inserted the gateway into your network.

Solution

- Verify that each PC on the network can connect to the gateway.
- Verify that the gateway Internet LED (second LED from the left in the bank of eight LEDs) is either solid or blinking green. If the Internet LED is red, verify that you have a standard phone cable connected between the DSL port on the gateway and your DSL service outlet.
- Verify all your connections are securely attached.
- Unplug the power cord from the gateway. Reapply power in the following order:
 - Reapply power to the gateway. Confirm the Internet LED is solid or blinking green.
 - If the Internet LED on the gateway is off, unplug power from the gateway, attach a new cable between the gateway and your DSL service outlet. Turn power back on to the gateway and verify the Internet LED is solid green.

Problem I’ve made changes to the gateway, clicked Save and Restart, and now can’t connect to the gateway.

Solution There are several possible solutions. See the following:

- You’ve changed a setting on the Gateway, such as the Gateway IP address, disabled the DHCP server, changed mode, or wireless settings. Restart your PC

and try connecting to the gateway again. If you still cannot connect to the gateway, reset the gateway to factory defaults. Locate the reset switch (next to the antenna on the rear panel). Press the reset switch, using a paper clip, for 5 seconds.

- Verify you can connect to the gateway from a wired connection. If you changed wireless settings, you can verify the settings you've changed from a wired PC. See *Getting network status information* on page 94.
- See *I can't connect to the gateway* on page 108. Consult the solution that applies to your network (wired or wireless network).

Problem **I'm experiencing intermittent connections**

Solution You are likely experiencing interference from other wireless devices (such your microwave oven or cordless phone).

- Make sure the antenna on the gateway is extended (and on your USB adapters, if applicable).
- Increase the distance between wireless devices (for instance, don't position your gateway or adapters near your cordless phone's base).
- If you live in a multi-level dwelling, change the direction of the antenna on the Gateway to point directly towards you (when facing the rear panel). This will provide better coverage for multilevel floors.
- Switch to another channel on your cordless phone, if possible.
- Change the channel on the gateway to channel 1, 6, or 11 (these channels will not overlap each other).

Note If you change the channel on your gateway, you will need to reboot all your wireless connected PCs.

Problem **I'm having trouble connecting to my Internet game server**

Solution Consult your documentation for your game to determine the correct ports to open for your game to operate correctly behind a firewall.

Problem **I'm having trouble getting AOL working**

Solution • Configure the AOL software connection setup for a TCP/IP (direct) or LAN connection. Save your settings then try again.

You may not be able to have more than one instance of the AOL software open at the same time, for a given account. That is, if you are currently accessing the Internet on a PC using the AOL software, you may need to use another browser or another AOL account to access the Internet on another PC.

- If you still cannot connect, then verify that you can access the Internet in general via another Web browser (Netscape, Internet Explorer).
- If you are able to access the Internet, but cannot access AOL then refer to your AOL documentation for help and technical support information.

Problem **I'm having trouble getting my e-mail working**

Solution • Verify that you have entered the correct Domain Name (DNS entry) from your Install Information Worksheet. If it is correct, you should be able to browse the Internet.

• Verify that each PC connected to the gateway can access the Internet. See *I can't connect to the Internet through my gateway* on page 112

- Check the e-mail settings provided by your ISP on each PC.

Note If you can access the Internet, the problem is NOT in the gateway.

Problem I'm using a third-party adapter and I cannot access the gateway or the Internet

Solution Use the following instructions to make sure the network properties are set correctly for obtaining an IP address.

Setting or checking your IP address

Depending on your operating system, follow the appropriate set of instructions.

Windows 98 and ME

- 1 Click **Start > Settings > Control Panel > Network**.
- 2 Select the **TCP/IP** --> [the name of the Network Adapter]. For example, Intel® AnyPoint® Wireless II Adapter.
- 3 Click **Properties**.
- 4 Click the **IP Address** tab.
- 5 Make sure that the **Obtain an IP address automatically** option is selected.
- 6 On the **DNS Configuration** tab, make sure **Disable DNS** is selected.
- 7 If one or both are not selected, select them, and then restart the PC.

Windows 2000

- 1 Click **Start > Settings > Network and Dial-up Connections**.
- 2 Right-click [the name of the Network Adapter], for example, Intel AnyPoint Wireless II Adapter and select **Properties**.
- 3 In the Local Area Connection Properties dialog box, click **Internet Protocol (TCP/IP)**.
- 4 Click **Properties**.
- 5 Make sure that the **Obtain an IP address automatically** option is selected.
- 6 Make sure that the **Obtain DNS server address automatically** option is selected.
- 7 If one or both are not selected, select them and restart the PC after you make the change.

Windows XP

- 1 Click **Start > Control Panel > Network Connections**, and then click **Network Connections**.
- 2 Right-click [the name of the Network Adapter], for example, Intel AnyPoint Wireless II Adapter and select **Properties**.
- 3 In the Local Area Connection Properties dialog box, click **Internet Protocol (TCP/IP)**.
- 4 Click **Properties**.
- 5 Make sure that the **Obtain an IP address automatically** option is selected.
- 6 Make sure that the **Obtain DNS server address automatically** option is selected.
- 7 If one or both are not selected, select them and restart the PC after you make the change.

Problem **I'm using Internet Connection Sharing (ICS) and don't know how to remove it.**

Solution Internet Connection Sharing is a software method for sharing an Internet connection. The gateway provides this method now. To manually remove ICS, use the following instructions for your operating system:

Windows 98

- 1 Click **Start > Settings > Control Panel > Add/Remove Programs**.
- 2 Click the **Windows Setup** tab.
- 3 Click **Internet Tools** and then click **Details**.
- 4 Select **Internet Connection Sharing** to remove the check mark, and then click **OK**.
- 5 Click **Apply** to save your changes.

Windows removes the components and prompts you to restart your PC.

- 6 Click **Yes** to restart.

Windows ME

- 1 Click **Start > Settings > Control Panel > Add/Remove Programs**.
- 2 Click the **Windows Setup** tab, click **Communications**, and then click **Details**.
- 3 Select **Internet Connection Sharing** to remove the check mark, and then click **OK**.
- 4 Click **OK**.

Windows removes the components and prompts you to restart your PC.

- 5 Click **Yes** to restart.

Windows 2000

- 1 Click **Start > Control Panel > Network and Dial-Up Connections**.
- 2 Right-click the dial-up, VPN, or incoming connection you have shared, and then click **Properties**.
- 3 On the **Sharing** tab, remove the **Enable Internet connection sharing for this connection** check box, and click **OK**.

Windows XP

- 1 Click **Start > Control Panel > Network Connections**.
- 2 Click the connection you have shared, and then under **Network Tasks**, click **Change settings of this connection**.
- 3 On the **Advanced** tab, remove the **Allow other network users to connect through this computer's Internet connection** check box, and click **OK**.

Problem **My Internet game, that is Universal Plug and Play aware, does not work.**

Solution Enable Universal Plug and Play on the gateway.
You also may need to enable UPnP on your Windows system. See the following problem and solution.

Note Windows XP and Me editions support UPnP. Other versions of Windows will require a 3rd party product to use UPnP.

Problem **I'm trying to use UPnP. How do I enable it?**

Solution Instructions for installing UPnP on Windows XP and Windows ME follows. Other versions of Windows will require a 3rd party product to use UPnP.

Windows ME

- 1 Click **Start > Settings > Control Panel > Add/Remove Programs**.
- 2 Click the **Windows Setup** tab.
- 3 In the **Components** list, select the **Communications** check box, and then click **Details**.
- 4 Make sure the **Universal Plug and Play** check box is selected and then click **OK**.
- 5 Click **Apply** to save your changes.
Windows installs the components. You are prompted to restart your PC.
- 6 Click **Yes** to restart.

Windows XP

- 1 Click **Start > Control Panel > Add or Remove Programs**, and then in the left channel, click **Add/Remove Windows Components**.
- 2 In the **Components** list, select the **Networking Services** check box, and then click **Details**.
- 3 Select **Universal Plug and Play**, and then click **OK**.
- 4 Click **Next** and then **Finish**.

Problem **My Internet game does not work**

Solution You may need to enable a custom rule on the gateway.

If all else fails

If none of the previous problems and solutions seem to match your situation, try the following:

- Unplug the power cord from the gateway, wait at least 5 seconds, then plug the power cord back in.
- Reset the gateway.
- If you cannot get to the system tools screen to perform this reset then unplug the power cord from the gateway, wait at least 5 seconds, then plug the power cord back in.
- Restore the gateway to its original factory defaults.

Reconfigure the gateway using the gateway configuration software.

Reading the gateway indicator lights

As an initial operational check of your gateway, check the indicator lights. The indicators are described in Chapter 1 of the User's Guide.

Reading settings and device status

If you are having connection problems with your broadband modem, or the wired or wireless network,

check the Status screen. From this screen, you can see if your connections are active or not connected.

- 1 Click the **Status** menu to expand its selections.
- 2 Click **Network Status**.

The following appears.

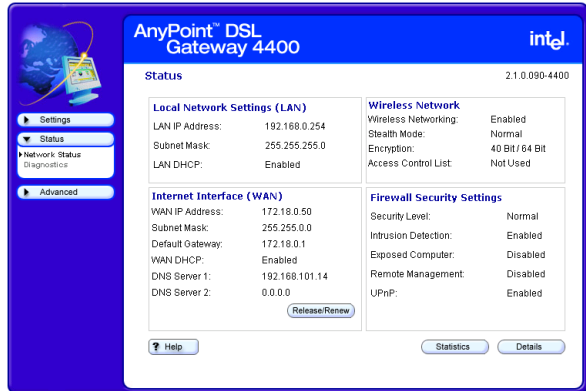

- 3 Click **Statistics** to view detailed statistics on the gateway.
- 4 Click **Details** to view the interface configurations of your gateway.

Loading default settings

You can load default settings if you want to create a new configuration or want to start from known settings.

- 1 Click the **Advanced** menu to expand its selections.
- 2 Click **System tools**.
- 3 Click **Default**.

Your gateway now has the initial factory settings, but any firmware upgrades will remain.

Note The device IP address will be reset to 192.168.0.254

Resetting the gateway

When you click Reset, you will restart your gateway using the current settings. The gateway will show the initial Wireless Gateway screen. Clicking Reset from the System Tools screen is useful if you have mounted the unit on the wall or ceiling and cannot physically access the Reset button.

- 1** Click the **Advanced** menu to expand its selections.
- 2** Click **System tools**.
- 3** Click **Reset**.

Your gateway will restart with your current settings.

Chapter 6

Glossary

This section contains a list of network and computer related terms with definitions.

Glossary

802.11b A specific networking standard created by IEEE that defines engineering design parameters for high-speed wireless data transmission. The 802.11b standard allows different manufacturers to create wireless products that are compatible with each other.

Ad Hoc Mode Peer-to-Peer
A software setting for 802.11b wireless adapters.

Adapter Also network adapter or NIC
A hardware device that allows your PC to connect to a network.

Access Point (AP) A hardware device that serves as a communications “hub” for 802.11b wireless PCs and can also provide a connection to a wired network. An AP can double the range of wireless client PCs and provide enhanced security.

ASCII characters Any printable alpha-numeric character.

DHCP Dynamic Host Configuration Protocol. A TCP/IP protocol that defines a way to automatically assign IP addresses to computers on a network. IP addresses are managed by a DHCP server on the network. When a computer starts, it requests an IP address from the server. The server leases an address for a set time. After that time, the computer makes a new request. When a Windows computer is configured to obtain an IP address automatically, it attempts to get an address from a DHCP server. Windows 2000 and Windows NT servers include DHCP server software that can provide this service. Network appliances that rely on TCP/IP often include a DHCP server.

Driver (Device Driver)	Special software programs required for any device to install properly on a PC. Devices include network adapters, printers, scanners, modems, audio cards, CD drives, monitors etc. Drivers enable the device to coordinate its activities with the PC to which it is attached.
DNS	Domain Name System. A naming service used to identify servers connected to the Internet. Every domain name is unique. DNS servers maintain a database of names and associated IP addresses, so Web users can browse to a domain name and reach the server at the associated IP address.
Encryption	A method of converting all of the information that is transmitted over a wireless network into a form that cannot be read by unauthorized persons. Encryption provides additional data security in 802.11b wireless networks.
Ethernet	Ethernet is defined by the IEEE 802.3 standard. Ethernet networks operate at speeds of 10Mbps and above using CSMA/CD (Carrier-Sense Multiple Access) to run over cables such as 10BaseT.
Ethernet address (MAC address)	Each computer on an Ethernet network has its own unique, pre-programmed Media Access Control (MAC) address. This 12-digit hexadecimal address is encoded into the circuitry of the computer's network adapter when it is manufactured. Other devices on the network use this address to identify the computer. This address is not the same as the IP address that is assigned to computers on TCP/IP networks. On these networks, the IP address is associated with the MAC address to enable network communication.
Firewall	Software on a network gateway that protects the computers on a private network from the Internet. The

firewall can also control what Internet resources local network computers can access.

Gateway A network device that provides an entrance to another network.

Hexadecimal A base-16 number system. That is, a numbering system that counts 16 base unit numbers before adding a new digit. Hexadecimal numbers use 0-9 and then the letters A-F. For example, the letter A in hexadecimal represents 10 in decimal, F is 15 in decimal, and the hexadecimal number 10 is 16 in decimal.

Hub The central connection point for network cables that connect to computers or other devices on a network. With an 8-port hub, you can connect cables to 8 computers

Infrastructure Mode A software setting for 802.11b wireless adapters allowing connectivity to a central device, either a gateway or an access point. The gateway or access point handles the communication between PCs and often manages the Internet connection. See Ad Hoc and Access Point.

IEEE The Institute of Electrical and Electronics Engineers.

ISP Internet Service Provider

An organization that provides access to the Internet. Users connect with the ISP using a conventional or broadband modem.

LAN Local Area Network

A computer network that serves users within a defined location. The benefits include the sharing of Internet access, files and equipment like printers and storage devices. LANs use Ethernet cabling, existing phone lines or radio waves to transmit data between the PCs. LANs include home and small-business networks.

Mbps Megabits per second, a measure of data transmission speed.

NAT Network Address Translation. A service that translates your local private IP addresses to a public Internet address so your privately addressed network can connect to the public Internet. NAT simplifies network setup and adds a measure of security to your network because your private network addresses are never seen on the Internet.

Peer-to-Peer See Ad Hoc.

Profiles (Network Profiles) A collection of software settings and network identification information that is unique for each network.

Protocols (Network Protocols) Define the rules for all aspects of data communication just like a written language uses rules for spelling, sentence structure, etc. Protocols describe the way data is organized, transmitted and received. The TCP/IP protocol is one of the most common.

Resources (Network resources) Software or hardware shared by the users of a network. Resources can include software applications, documents, digital pictures and music, games, numeric data, and devices such as printers, modems and disk drives.

Roaming Moving seamlessly from one access point coverage area to another with no loss in connectivity.

SSID Service Set Identifier. To communicate with each other, all wireless devices on the same network must use the same SSID. The SSID allows two or more wireless networks to function in the same vicinity without interfering with each other. The SSID can be a word or a combination of letters and numbers.

Subnet A distinct separate part of a computer network. Often, computers in one building or location form a subnet. Dividing a large network into subnets isolates network traffic, enhances network performance, and provides a mechanism for organizing the network in a logical manner. You divide a network into subnets by connecting network segments with a router. On a TCP/IP network, IP routers connect subnets together.

Subnet mask A mask used to determine the subnet for an IP address. IP addresses have two parts: a subnet address and the computer address. The subnet mask determines what part of the IP address is the subnet address. For example, if you have a subnet mask of 255.255.0.0, the first two numbers in your IP address are the subnet address. The last two numbers are your computer's address on the local network. Your computer uses the subnet mask to decide whether to send data to another computer on the local network, or to send the data to the address specified by your default gateway. If the subnet part of the address you are sending data to matches your IP address, then your computer tries to send the data on the local network. If these do not match, then the computer you are sending data to is on another subnet (probably on the Internet), so your computer sends the data to your default gateway, and the gateway forwards it on to the Internet.

Switch Similar to a hub, a switch is a central connection point for network cables that connect to computers or other network devices. However, when two devices communicate through a switch, it sends signals directly from one port to the other port, instead of transmitting to all ports, like a hub. You can connect a computer, a hub, or a switch to each port on a switch.

TCP/IP Transmission Control Protocol/Internet Protocol. The protocol that computers use to communicate over the Internet. TCP determines how a computer breaks up data

into small units, called packets, to be sent to another computer and how the receiving computer reassembles the packets into a single file. IP determines how the packets are routed across the Internet.

UPnP Universal Plug and Play (UPnP) is a standard that uses Internet and Web protocols to enable devices such as PCs, peripherals, and wireless devices to be plugged into a network and automatically know about each other.

Chapter 7

Regulatory Compliance Statements

This chapter contains the following agency notices:

- Safety compliance statements
- Emissions compliance statements
- RF exposure compliance statements
- Telecom compliance statements
- Canadian compliance statements
- European Union compliance statements
- Product Ecology Statements

Safety compliance statements

- This product complies with the safety requirements for Information Technology Equipment and is Listed by Underwriters Laboratories, Inc. to UL 60950 and CSA C22.2 No. 950 for the U.S. and Canada.
- This modem is for use only with listed compatible computers.
- CAUTION: To reduce the risk of fire, use only No. 26 AWG or larger telecommunication line cord.
- **Français ATTENTION:** Pour réduire le risque d'incendie, utiliser uniquement des conducteurs de télécommunications 26 AWG ou de section supérieure.
- NOTICE: This product does not provide primary telephone circuit protection . This primary circuit protection should be provided by the telephone company at the building connection. In the U.S. and Canada, this protection is provided by the telephone company under federal regulations. However, for the European Union and other geographies, we cannot confirm this protection has been provided.

Emissions compliance statements

- This product has been tested and found to comply with the limits for a Class B digital device pursuant to Part 15 of the FCC rules. These limits are designed to provide reasonable protection against harmful interference when the equipment is operated in a residential environment.
- This product generates, uses, and can radiate radio frequency energy and, if not installed and used in accordance with the instruction manual, may cause harmful interference to radio communications. However, there is no guarantee that interference will not occur in a particular installation. If this equipment does cause harmful interference to radio or television reception, which can be determined by turning this equipment off and on, the user is encouraged to try to correct the

interference by one or more of the following measures:

- Change the direction of the radio or TV antenna.
- To the extent possible, relocate the radio, TV, or other receiver away from the product.
- Plug the host computer into a different electrical outlet so that the computer and the radio or TV are on different electrical branch circuits.
- This device complies with Part 15 of the FCC Rules. Operation is subject to the following two conditions: (1) This device may not cause harmful interference, and (2) this device must accept any interference received, including interference that may cause undesired operation.
- CAUTION: If you make any modification to the equipment not expressly approved by Intel[®], you could void your authority to operate the equipment.

RF exposure compliance statements

Notice: Install or position the Intel AnyPoint[®] DSL Gateway Model 4400 so that the antenna is at least 8 inches (20 cm.) from the user or other persons. Failure to locate the antenna at this minimum distance may result in exceeding the FCC limits for human exposure to RF (radio frequency) energy. Also, do not operate in conjunction with any other antenna or transmitters.

Telecom compliance statements

- This equipment complies with Part 68 of the FCC Rules and the requirements adopted by ACTA. On the bottom side of this equipment is a label that contains, among other information, a product identifier in the format US: EJMDLNANXXXX. If

requested, this number must be provided to the telephone company.

- This equipment is provided with an RJ11C Universal Service Order Codes (USOC) jack for connection to the telephone network.
- A plug and jack used to connect this equipment to the premises wiring and telephone network must comply with the applicable FCC Part 68 rules and requirements adopted by the ACTA. A compliant telephone cord and modular plug is provided with this product. It is designed to be connected to a compatible modular jack that is also compliant. See installation instructions for details.
- There is no Ringer Equivalence Number on this equipment (Intel ADSL digital modem). For all ADSL digital modems, the Ringer Equivalence Number (REN) is not applicable.
- If this equipment (Intel ADSL digital modem) causes harm to the telephone network, the telephone company will notify you in advance that temporary discontinuance of service may be required. But if advance notice is not practical, the telephone company will notify the customer as soon as possible. Also, you will be advised of your right to file a complaint with the FCC if you believe it is necessary.
- The telephone company may make changes in its facilities, equipment, operations or procedures that could affect the proper functioning of the equipment. If this happens, the telephone company will provide advance notice in order for you to make necessary modifications to maintain uninterrupted service.
- If trouble is experienced with this equipment (Intel ADSL digital modem), for repair or warranty information, please contact Intel Customer Support at (916) 377-0283 (or <http://www.intel.com/support/9089.htm>). If the equipment is causing harm to the

telephone network, the telephone company may request that you disconnect the equipment until the problem is resolved.

- There are no user serviceable parts contained in this equipment.
- Connection to party line service is subject to state tariffs. Contact the state public utility commission, public service commission or corporation commission for information.
- If your home has specially wired alarm equipment connected to the telephone line, ensure the installation of this equipment (Intel ADSL digital modem) does not disable your alarm equipment. If you have questions about what will disable alarm equipment, consult your telephone company or a qualified installer.

Canadian compliance statements

- This Class B digital apparatus complies with Canadian ICES-003.
- **Français** Cet appareil numérique de la classe B est conforme à la norme NMB-003 du Canada.
- NOTICE: This equipment meets the applicable Industry Canada Terminal Equipment Technical Specifications. This is confirmed by the registration number. The abbreviation, IC, before the registration number signifies that registration was performed based on a Declaration of Conformity indicating that Industry Canada technical specifications were met. It does not imply that Industry Canada approved the equipment.
- NOTICE: There is no Ringer Equivalence Number on your Intel ADSL digital modem. For all ADSL digital modems, the Ringer Equivalence Number (REN) is not applicable. The REN assigned to other terminal devices provides an indication of the

maximum number of terminals allowed to be connected to a telephone interface. The termination on an interface may consist of any combination of devices subject only to the requirement that the sum of the Ringer Equivalence Numbers of all the devices does not exceed 5.

- This equipment complies with Canada 210. Operation is subject to the following two conditions: (1) this device may not cause interference, and (2) this device must accept any interference, including interference that may cause undesired operation of the device. To prevent radio interference to the licensed service, this device is intended to be operated indoors and away from windows to provide maximum shielding. Equipment (or its transmit antenna) that is installed outdoors is subject to licensing.

European Union compliance statements

We, Intel Corporation, declare under our sole responsibility that the product:

Intel AnyPoint DSL Gateway Model 4400

is in conformity with all applicable essential requirements necessary for CE marking, following the provisions of the European Council Directive 1999/5/EC (Radio Equipment and Telecommunications Terminal Equipment), including Council Directive 89/336/EEC (EMC) and Council Directive 73/23/EEC (Safety/Low Voltage Directive).

The product is properly CE marked demonstrating this conformity and is for distribution within all member states of the EU with the following restriction:

- France limited to 2446.5-2483.5 MHz indoor use.



The product is properly CE marked demonstrating this conformity.

Dansk Dette produkt er i overensstemmelse med det europæiske direktiv 1999/5/EC

Dutch Dit product is in navolging van de bepalingen van Europees Directief 1999/5/EC.

Suomi Tämä tuote noudattaa EU-direktiivin 1999/5/EC määräyksiä

Français Ce produit est conforme aux exigences de la Directive Européenne 1999/5/EC.

Deutsch Dieses Produkt entspricht den Bestimmungen der Europäischen Richtlinie 1999/5/EC

Icelandic Þessi vara stenst reglugerð Evrópska Efnahags Bandalagsins númer 1999/5/EC

Italiano Questo prodotto è conforme alla Direttiva Europea 1999/5/EC.

Norsk Dette produktet er i henhold til bestemmelsene i det europeiske direktivet 1999/5/EC.

Portuguese Este produto cumpre com as normas da Diretiva Européia 1999/5/EC.

Español Este producto cumple con las normas del Directivo Europeo 1999/5/EC.

Svenska Denna produkt har tillverkats i enlighet med EG-direktiv 1999/5/EC.

Product Ecology Statements

The following information is provided to address worldwide product ecology concerns and regulations.

Disposal Considerations

This product contains the following materials that may be regulated upon disposal: lead solder on the printed wiring board assemblies.

Intel encourages its customers to recycle its products and their components (e.g. batteries, circuit boards, plastic enclosures, etc.) whenever possible. In the U.S., a list of recyclers in your area can be found at: <http://www.eiae.org>. In the absence of a viable recycling option, products and their components must be disposed of in accordance with all applicable local environmental regulations.

Disassembly Instructions

This section is provided to aid in the disassembly and recycling of this Intel product. Only technically qualified persons should disassemble this product. Notice, no user serviceable parts inside.

Tools needed:

- small flathead screwdriver.
- small phillips head screwdriver.

Disassembly steps:

- 1** Remove the label located at the bottom of the unit – to access the single phillips head screw.
- 2** Remove the single phillips head screw located at the bottom of the unit.
- 3** Locate two slots on the right-side of the unit.
- 4** By inserting a small flathead screwdriver first into one of the slots then the other, slowly pry the top cover off the unit.
- 5** Lift circuit boards and components from plastic enclosure.
- 6** You can now recycle the plastic case as well as the internal circuit boards.

* Other names and brands are the property of their respective owners.

Copyright © 2002 Intel Corporation. All rights reserved.