

# User's Manual

**Part Number:** 5615 6717 5013 R00  
(June 2002)



**TRADEMARKS**

All brand and product names are trademarks or registered trademarks of their respective companies.

**NOTE**

The information in this manual is subject to change without notice.



# Regulations Information

## Class B Regulations

### USA

#### **Federal Communications Commission Radio Frequency Interference Statement**

##### **NOTE:**

This equipment has been tested and found to comply with the limits for a Class B digital device pursuant to Part 15 of the FCC Rules. These limits are designed to provide reasonable protection against harmful interference in a residential installation. This equipment generates, uses, and can radiate radio frequency energy and, if not installed and used in accordance with the instructions, may cause harmful interference to radio communications. However, there is no guarantee that interference will not occur in a particular installation. If this equipment does cause harmful interference to radio or television reception, which can be determined by turning the equipment off and on, the user is encouraged to try to correct the interference by one or more of the following measures:

- Reorient or relocate the receiving antenna.
- Increase the separation between the equipment and receiver.
- Connect the equipment into an outlet on a circuit different from that to which the receiver is connected.
- Consult the dealer or an experienced radio/TV technician for help.

Any changes or modifications not expressly approved by the manufacturer could void the user's authority to operate the equipment.

##### **Please note:**

The use of a non-shielded interface cable with this equipment is prohibited.

### Canada

#### **Canadian Department of Communications Radio Interference Regulations Class B Compliance Notice**

This digital apparatus does not exceed the Class B limits for radio noise emissions from digital apparatus set out in the Radio Interference Regulations of the Canadian Department of Communications.

Le présent appareil numérique n'émet pas de bruits radioélectriques dépassant les limites applicables aux appareils numériques de la classe B prescrites dans le Règlement sur le brouillage radioélectrique édicté par le ministère des Communications du Canada.

## About the Battery

### Caution Texts Concerning Lithium Batteries

#### DANISH

**ADVARSEL!**

Lithiumbatteri – Eksplosionsfare ved fejlagtig håndtering. Udskiftning må kun ske med batteri af samme fabrikat og type. Levér det brugte batteri tilbage til leverandøren.

#### NORWEGIAN

**ADVARSEL:**

Eksplosjonsfare ved feilaktig skifte av batteri. Benytt samme batteritype eller en tilsvarende type anbefalt av apparatfabrikanten. Brukte batterier kasseres i henhold til fabrikantens instruksjoner.

#### SWEDISH

**VARNING:**

Explosionsfara vid felaktigt batteribyte. Använd samma batterityp eller en ekvivalent typ som rekommenderas av apparattillverkaren. Kassera använt batteri enligt fabrikantens instruktion.

#### FINNISH

**VAROITUS:**

Paristo voi räjähtää, jos se on virheellisesti asennettu. Vaihda paristo ainoastaan valmistajan suosittelemaan tyyppiin. Hävitä käytetty paristo valmistajan ohjeiden mukaisesti.

#### ENGLISH

**CAUTION:**

Danger of explosion if battery is incorrectly replaced. Replace only with the same or equivalent type recommended by the equipment manufacturer. Discard used batteries according to manufacturer's instructions.

#### DEUTSCH

**VORSICHT:**

Explosionsgefahr bei unsachgemäßem Austausch der Batterie. Ersatz nur durch denselben oder einen vom Hersteller empfohlenen gleichwertigen Typ. Entsorgung gebrauchter Batterien nach Angaben des Herstellers.

#### FRENCH

**ATTENTION:**

Il y a danger d'explosion s'il y a un remplacement incorrect de la batterie. Remplacer uniquement avec une batterie du même type ou d'un type équivalent recommandé par le constructeur. Mettre au rebut les batteries usagées conformément aux instructions du fabricant.

## Attention (for USA Users)

The product that you have purchased contains a rechargeable battery. The battery is recyclable. At the end of its useful life, under various state and local laws, it may be illegal to dispose of this battery into the municipal waste stream. Check with your local solid waste officials for details in your area for recycling options or proper disposal.

## About the Modem

### Caution

1. Never install telephone wiring during a lightning storm.
2. Never install telephone jacks in wet locations unless the jack is specifically designed for wet locations.
3. Never touch uninsulated telephone wires or terminals unless the telephone line has been disconnected at the network interface.
4. Use caution when installing or modifying telephone lines.
5. Avoid using the telephone function (other than a cordless type) during an electrical storm. There may be a remote risk of electric shock from lightning.
6. Do not use the telephone function to report a gas leak in the vicinity of the leak.
7. Do not use this product near water, for example near a bath tub, wash bowl, kitchen sink or laundry tub, in a wet basement or near a swimming pool.

### Caution (for USA Users)

To reduce the risk of fire, use only No.26 AWG or larger telecommunication line cord.



# ***Table of Contents***

<b>Preface</b> .....	<b>v</b>
<b>Chapter 1 Getting Started</b> .....	<b>1-1</b>
Getting the Computer Running.....	1-2
Unpacking .....	1-2
Connecting to AC Power .....	1-2
Opening the Cover .....	1-3
Turning On and Off the Computer.....	1-4
Taking a Look at the Computer .....	1-6
Right-Side Components .....	1-6
Left-Side Components .....	1-7
Rear Components.....	1-8
Front Components.....	1-9
Top-open Components.....	1-10
Where to Go from Here .....	1-12
<b>Chapter 2 Operating Your Computer</b> .....	<b>2-1</b>
Starting and Stopping the Computer.....	2-2
Starting the Computer .....	2-2
Stopping the Computer .....	2-2
Using the Keyboard .....	2-4
Typewriter Keys.....	2-4
Cursor-Control Keys .....	2-5
Numeric Keypad .....	2-6
Euro Symbol .....	2-7
Windows Keys .....	2-7

Function Keys .....	2-8
Fn Key .....	2-8
Hot Keys .....	2-8
Using the Touchpad .....	2-10
Configuring the Touchpad .....	2-12
Using Easy Start Buttons .....	2-13
Using the Floppy Disk Drive .....	2-14
Connecting the Floppy Disk Drive .....	2-14
Inserting and Ejecting Floppy Disks .....	2-15
Using the Hard Disk Drive .....	2-16
Using the CD/DVD Drive.....	2-17
Inserting and Removing a CD.....	2-18
Using the Video Features.....	2-19
Configuring the Display Modes .....	2-19
Using the Audio Features .....	2-21
Connecting Audio Devices .....	2-22
Using the Communication Features.....	2-23
Using the Modem.....	2-23
Using the LAN.....	2-24
<b>Chapter 3 Managing Power .....</b>	<b>3-1</b>
AC Adapter .....	3-2
Battery Pack.....	3-3
Charging the Battery Pack .....	3-3
Initializing the Battery Pack.....	3-4
Checking the Battery Level.....	3-4
Replacing the Battery Pack .....	3-4
Battery Low Signals and Actions.....	3-5
Power Management .....	3-7
Hibernation.....	3-8
Power-Saving Tips.....	3-9
<b>Chapter 4 Expanding Your Computer.....</b>	<b>4-1</b>
Connecting an External Monitor.....	4-2
Connecting a TV .....	4-3



Connecting a Parallel Device.....	4-5
Connecting a USB Device .....	4-6
Connecting an IR Device.....	4-7
Connecting an IEEE 1394 Device .....	4-9
Using PC Cards .....	4-10
PC Card Type.....	4-10
CardBus Support.....	4-10
Inserting and Removing a PC Card.....	4-10
Internal Components Upgrade.....	4-12
<b>Chapter 5 Using BIOS Setup .....</b>	<b>5-1</b>
When and How to Use BIOS Setup.....	5-2
When to Use.....	5-2
Starting BIOS Setup.....	5-2
Moving Around and Making Selections .....	5-3
Main Menu .....	5-5
Advanced Menu.....	5-6
Security Menu.....	5-9
Boot Menu .....	5-10
Exit Menu .....	5-11
<b>Chapter 6 Installing Software Drivers.....</b>	<b>6-1</b>
How to Use the CD.....	6-2
Other Drivers and Utilities.....	6-4
Easy Start Button Utility .....	6-4
Wireless LAN Utility .....	6-5
<b>Chapter 7 Caring for the Computer.....</b>	<b>7-1</b>
Protecting the Computer .....	7-2
Using the Password.....	7-2
Using the Cable Lock.....	7-2
Using an Anti-Virus Strategy.....	7-3
Taking Care of the Computer .....	7-4
Location Guidelines .....	7-4
General Guidelines.....	7-4

Cleaning Guidelines .....	7-5
Battery Pack Guidelines .....	7-5
When Traveling .....	7-6
<b>Chapter 8 Troubleshooting.....</b>	<b>8-1</b>
Preliminary Checklist .....	8-2
Solving Common Problems .....	8-3
Battery Problems .....	8-4
CD Drive Problems .....	8-4
Display Problems .....	8-5
Floppy Disk Drive Problems.....	8-7
Hardware Device Problems.....	8-8
Hard Disk Drive Problems .....	8-8
Infrared Problems.....	8-9
Keyboard, Mouse, and Touchpad Problems .....	8-9
LAN Problems .....	8-10
Modem Problems .....	8-10
PC Card Problems .....	8-10
Power Management Problems (for Windows) .....	8-11
Printer Problems.....	8-12
Software Problems .....	8-12
Sound Problems .....	8-12
Startup Problems .....	8-13
Other Problems.....	8-14
Resetting the Computer .....	8-15
<b>Appendix A Specifications.....</b>	<b>A-1</b>
<b>Index .....</b>	<b>I-1</b>

# ***Preface***

This manual contains information that will help you operate the computer. It is divided into 8 chapters, an appendix, and an index.

- Chapter 1, **Getting Started**, takes you through the process of setting up the computer and identifying its external components.
- Chapter 2, **Operating Your Computer**, tells you how to use the computer's components and features.
- Chapter 3, **Managing Power**, provides information on power.
- Chapter 4, **Expanding Your Computer**, provides information on installing and using peripheral devices.
- Chapter 5, **Using BIOS Setup**, describes the SCU program that configures the computer's BIOS settings.
- Chapter 6, **Installing Software Drivers**, describes how to install the drivers and utilities supplied with the computer.
- Chapter 7, **Caring for the Computer**, gives you tips in care and maintenance.
- Chapter 8, **Troubleshooting**, gives solutions to common problems you may encounter when using the computer.
- Appendix A, **Specifications**, gives a brief specification for the computer.

## Notational Conventions

Throughout this manual, the following conventions are used to distinguish elements of text.

**| NOTE:** identifies additional information that requires special attention.

**| CAUTION:** identifies important information which, if not followed, may result in loss of data or damage to the computer.

Keyboard keys are shown in a bold typeset. For example:

Press **Enter** to complete.

When keys are joined by a plus sign (+), press the first key, and, while keeping the first key down, press the remaining keys, finally release all the keys. When necessary, keys are also shown in graphics.

A title, command, setup item, or button that you can see on the screen is shown in boldface. A value or an option that you can select for a setup item is shown in italic. For example:

Select **Power Management**, set it to *Enabled*, and then click the **OK** button.

# ***Getting Started***

Congratulations on purchasing this computer.

Your computer incorporates desktop computer capabilities into a compact notebook-sized package. It can greatly enhance your productivity either in the office or at home. And, of course, wherever you need it, the computer is ready and easy “to go.”

This chapter first tells you step by step how to get the computer up and running. You will find instructions for these procedures:

- Unpacking
- Connecting to AC power
- Opening the cover
- Turning on the computer
- Turning off the computer

Then, you will find a section briefly introducing the external components of the computer. And the last section navigates you to the information you may need after the computer is ready for use.

# Getting the Computer Running

This section guides you through the procedures for getting the computer ready for operation.

## Unpacking

After unpacking the shipping carton, you should find these standard items:

- Notebook computer
- Accessories:
  - AC adapter
  - AC power cord
  - Driver CD
  - Modem cable
  - This *User's Manual*

Inspect all the items. If any item is damaged or missing, notify your dealer immediately.

Keep the shipping carton and packing materials in case you need to ship or store the computer in the future.

## Connecting to AC Power

The computer operates either on the external AC power or internal battery power. It is suggested that you use AC power when you start up the computer for the very first time.

**CAUTION:** Use only the AC adapter included with your computer. Using other AC adapters may damage the computer.

1. Make sure the computer is turned off.
2. Plug the DC cord of the AC adapter to the power connector on the rear of the computer (❶).

3. Plug the female end of the AC power cord to the AC adapter and the male end to an electrical outlet (❷).

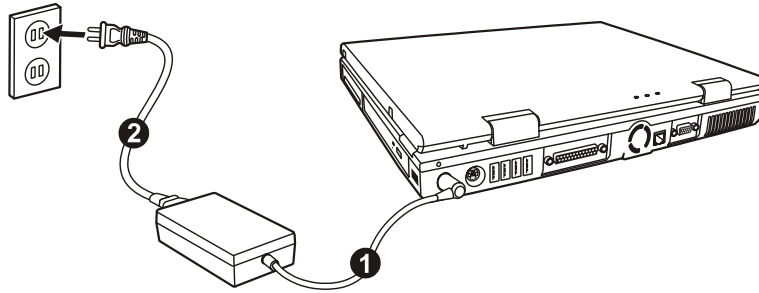

4. When the AC adapter is connected, power is being supplied from the electrical outlet to the AC adapter and onto your computer. Now, you are ready to turn on the computer.

**CAUTION:**

- When you disconnect the AC adapter, disconnect from the electrical outlet first and then from the computer. A reverse procedure may damage the AC adapter or the computer.
- When unplugging the connector, always hold the plug head. Never pull on the cord.

**NOTE:** When the AC adapter is connected, it also charges the battery pack. For information on using battery power, see Chapter 3.

## Opening the Cover

**CAUTION:** Be gentle when opening and closing the cover. Opening it vigorously or slamming it shut could damage the computer.

Open the top cover by sliding the cover latch toward the right (❶) and lifting up the cover (❷). You can tilt the cover forward or backward for optimal viewing clarity.

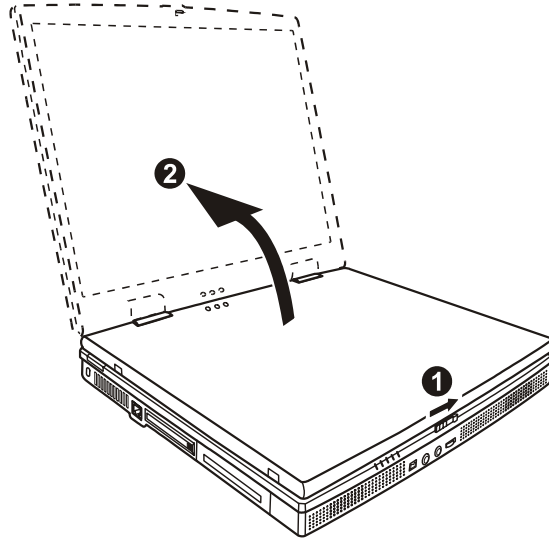

## Turning On and Off the Computer

### Turning On

1. Make sure the computer is connected to AC power.
2. Press the power button.

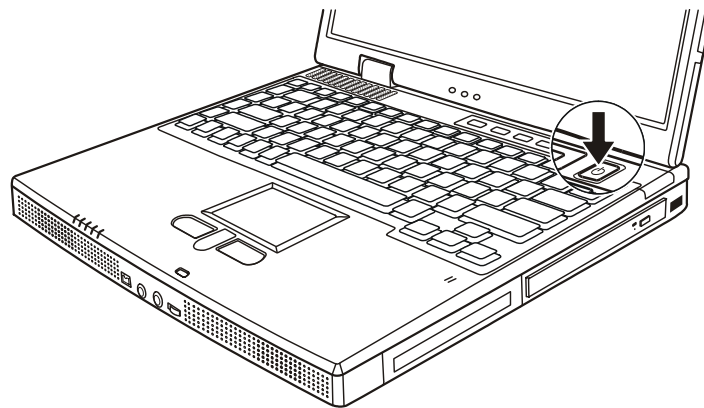



3. Each time the computer is turned on, it performs a Power-On Self Test (POST), and the operating system such as Windows should start.

## Turning Off

To turn off the computer power, use the “Shut Down” command of your operating system.

**NOTE:** There are other ways you can stop the computer so that you will be back to where you left off when you next turn on the computer. (See “Stopping the Computer” in Chapter 2 for information.)

**CAUTION:** If you have to turn the computer on again immediately after turning it off, wait for at least five seconds. Turning the computer off and on rapidly can damage it.

# Taking a Look at the Computer

This section identifies the external components of the computer and briefly describes the function of each component.

**NOTE:** Depending on the model you purchased, the appearance of your computer may not be exactly the same as those shown in this manual.

## Right-Side Components

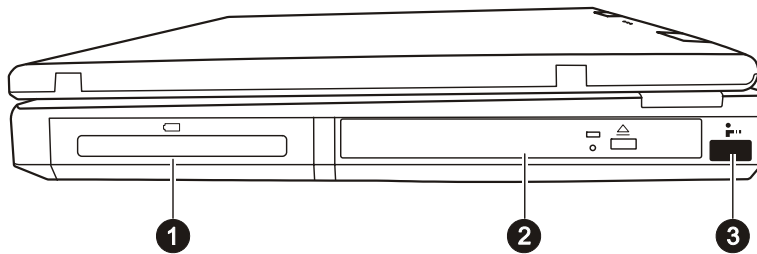

Ref	Component	Description	See Also
①	Battery Pack	Supplies power to your computer when external power is not connected.	P. 3-3
②	CD/DVD/ CD-RW/ Combo Drive	Accepts a compact disc (CD) for installing or loading software, accessing data, and playing music/video.	P. 2-17
③	IR Port	Connects an IrDA-compliant device for wireless data transfer.	P. 4-7

## Left-Side Components

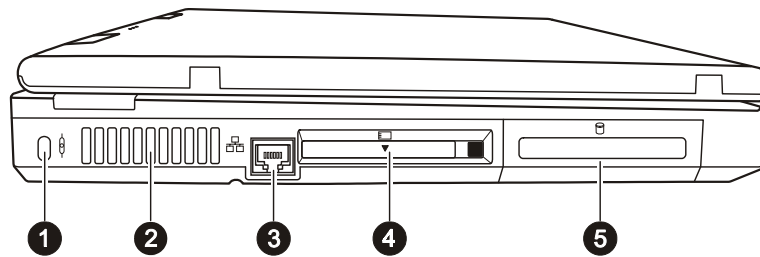

Ref	Component	Description	See Also
①	<b>Kensington Lock</b>	Locks the computer to a stationery object for security.	P. 7-2
②	<b>Ventilation Openings</b>	Do not cover or block the ventilation openings for air circulation thus preventing overheating.	
③	<b>RJ-45 Connector</b>	Connects the LAN cable.	P. 2-24
④	<b>PC Card Slot</b>	Accepts a PC Card for additional functions.	P. 4-10
⑤	<b>Hard Disk Drive</b>	Inside is the hard disk drive of your computer, often referred to as drive C.	P. 2-16



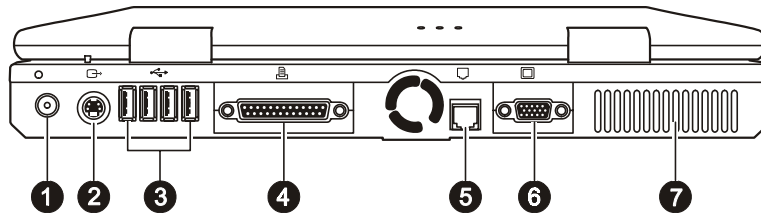

## Rear Components

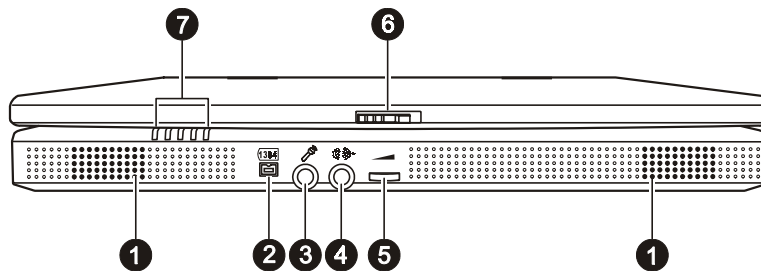

Ref	Component	Description	See Also
❶	<b>Power Connector</b>	Connects the AC adapter.	P. 1-2
❷	<b>S-Video Connector</b>	Connects an external video device, such as a TV, supporting S-video input.	P. 4-3
❸	<b>USB Ports</b>	Each of the four ports connects a USB device, such as a floppy disk drive, printer, digital camera, joystick, and more.	P. 4-6
❹	<b>Parallel Port</b>	Connects a parallel device, such as a printer.	P. 4-5
❺	<b>RJ-11 Connector</b>	Connects the telephone line.	P. 2-23
❻	<b>VGA Port</b>	Connects an external monitor.	P. 4-2
❼	<b>Ventilation Openings</b>	Do not cover or block the ventilation openings for air circulation thus preventing overheating.	

## Front Components



Ref	Component	Description	See Also
①	<b>Stereo Speaker Set</b>	Sends out sound and voice from the computer.	P. 2-21
②	<b>IEEE 1394 Port</b>	Connects a 1394 device such as a scanner, printer, DVCAM, VCR, and more.	P. 4-9
③	<b>Microphone Connector</b>	Connects an external microphone.	P. 2-21
④	<b>Audio Output Connector</b>	Connects a set of headphones, external speakers with amplifier, or an audio recording device.	P. 2-22
⑤	<b>Volume Control</b>	Adjusts the sound volume of the computer.	P. 2-21
⑥	<b>Top Cover Latch</b>	Locks the top cover.	P. 1-3
⑦	<b>Device Indicators</b>	Show the current status of the computer's devices.	
		CD/DVD/CD-RW/Combo drive in-use indicator	P. 2-18
		Hard disk drive in-use indicator	P. 2-16
		Num Lock indicator	P. 2-4
		Caps Lock indicator	P. 2-5
		Scroll Lock indicator	P. 2-5

## Top-open Components

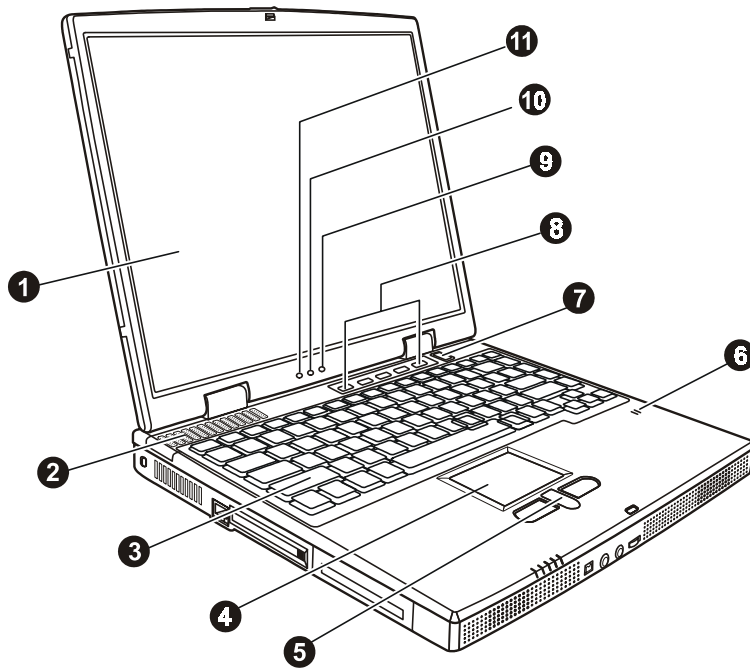

Ref	Component	Description	See Also
①	<b>LCD Screen</b>	Displays the output of the computer.	P. 2-19
②	<b>Ventilation Openings</b>	Do not cover or block the ventilation openings for air circulation thus preventing overheating.	
③	<b>Keyboard</b>	Serves as the data input device of the computer.	P. 2-4
④	<b>Touchpad</b>	Serves as the pointing device of the computer.	P. 2-10
⑤	<b>Scroll Button</b>	Allows you to move up and down in the working area on the screen.	P. 2-11
⑥	<b>Microphone</b>	Receives sound and voice for the computer.	P. 2-21
⑦	<b>Power Button</b>	Turns the computer power ON and OFF.	P. 1-4

<b>8 Easy Start Buttons</b>	Each of the five buttons provides a quick way to launch a specific program. P. 2-13
<b>9 Battery Charge Indicator</b>	<p>Glows green when the battery is fully charged. P. 3-3</p> <hr/> <p>Glows orange when the battery is being charged.</p> <hr/> <p>Blinks red when the battery is almost completely discharged.</p> <hr/> <p>Blinks orange when the battery is in an abnormal state.</p>
<b>10 Battery Power Indicator</b>	<p>Glows green when the computer is using battery power.</p> <hr/> <p>Blinks green when the computer, using battery power, is in Standby mode.</p>
<b>11 AC Power Indicator</b>	<p>Glows green when the computer is using AC power.</p> <hr/> <p>Blinks green when the computer, using AC power, is in Standby mode.</p>

## Where to Go from Here

As your computer is ready for operation, you may want to do any of the following now:

<b>For this purpose...</b>	<b>Do this...</b>
To know more about the computer...	Go on to the next chapter.
To install the operating system if your dealer has not already done so...	See the operating system manual.
To know more about the operating system...	Read the operating system manual.
To install the drivers if your dealer has not already done so...	See Chapter 6.
To set a power-on password...	See "Security Menu" in Chapter 5.
To charge the battery pack for the first time...	See "Charging the Battery Pack" in Chapter 3.



# *Operating Your Computer*

This chapter provides information about the use of the computer.

If you are new to computers, reading this chapter will help you learn the operating basics. If you are already a computer user but are new to notebook computers, you may choose to read only the parts containing information unique to your computer.

Described in this chapter are the operating basics of these components:

- Keyboard
- Touchpad
- Floppy disk drive
- Hard disk drive
- CD/DVD drive

And these features:

- Starting and stopping the computer
- Easy Start buttons
- Video features
- Audio features
- Communication features

# Starting and Stopping the Computer

There are a number of ways to start and stop the computer.

## Starting the Computer

You always start the computer using the power button.

A computer starts up with an operating system (OS) existing on the storage device such as the hard disk and floppy disk. The computer will automatically load the OS after you turn it on. This process is called booting.

**NOTE:** An operating system is the platform for all your software application programs to run on. The most widely used operating system today is Microsoft Windows.

## Stopping the Computer

When you finish a working session, you can stop the computer by turning off the power or leaving the computer in Standby or Hibernation mode:

To stop in this mode...	Do this...	To start up or resume again
Off	Follow the shutdown procedure of your operating system. This can prevent loss of unsaved data or damage to your software programs.  If the system is locked up because of hardware or software problems, press the power button to turn off the computer.	Press the power button.
Standby	Depending on your settings in Windows, you can put the computer in Standby mode by: <ul style="list-style-type: none"><li>• Closing the display cover</li><li>• Pressing <b>Fn+F12</b></li><li>• Pressing the power button</li></ul>	Press any key.

---

Hibernation	Depending on your settings in Windows, you can put the computer in Hibernation mode by:	Press the power button.
	<ul style="list-style-type: none"><li>• Closing the display cover</li><li>• Pressing <b>Fn+F12</b></li><li>• Pressing the power button</li></ul>	

---

If you choose to stop in Standby or Hibernation mode, you can return to where you left off the next time you start up the computer. (See “Power Management” in Chapter 3 for more information.)

## Using the Keyboard







Your keyboard has all the standard functions of a full-sized computer keyboard plus an **Fn** key added for specific functions.

The standard functions of the keyboard can be further divided into four major categories:

- Typewriter keys
- Cursor-control keys
- Numeric keys
- Function keys

### Typewriter Keys

Typewriter keys are similar to the keys on a typewriter. Several keys are added such as the **Ctrl**, **Alt**, **Esc**, and lock keys for special purposes. When the lock keys are pressed, their corresponding indicators light up.

Key	Description
	The Control key is normally used in combination with other keys for program-specific functions.
	The Alternate key is normally used in combination with other keys for program-specific functions.
	The Escape key is usually used for stopping a process. Examples are exiting a program and canceling a command. The function depends on the program you are using.
	The Shift key is used with alphabet letter keys to produce uppercase letters when typing. It is also used in combination with other keys for program-specific functions.
	The Backspace key moves the cursor left one space and deletes the character in that space.
	Pressing <b>Fn</b> and this key toggles the Num Lock on and off. When on (  light on), the Num Lock activates the numeric keys.



Pressing **Fn** and this key toggles Scroll Lock on and off. When on (  light on), the screen moves one line up or down when you press  $\uparrow$  or  $\downarrow$  arrow key. Scroll Lock does not work for all programs.



Pressing this key toggles the Caps Lock on and off. When on (  light on), the Caps Lock keeps the letter keys in uppercase.



The Pause key temporarily stops screen scrolling. Scroll Lock does not work for all programs.







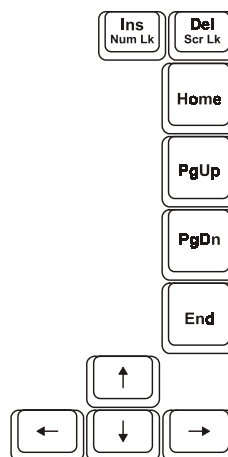





The Print Screen key prints the displayed screen. Print screen does not work for all programs.

## Cursor-Control Keys



**NOTE:** The word “cursor” refers to the indicator on the screen that lets you know exactly where on your screen anything you type will appear. It can take the form of a vertical or horizontal line, a block, or one of many other shapes.

Cursor-control keys are generally used for editing purposes. They are:

Key	Description
	Moves the cursor left one space.
	Moves the cursor right one space.
	Moves the cursor up one line.
	Moves the cursor down one line.
	Moves the page up.
	Moves the page down.
	Moves the cursor to the beginning of the line or document.
	Moves the cursor to the end of the line or document.
	Switches typing between insert and overwrite modes. Insert mode means any character typed will be inserted to the current cursor position; overwrite mode means any character typed will overwrite the text in the current cursor position.
	Deletes the character to the right of the cursor and moves the following text left one space.

## Numeric Keypad

A 15-key numeric keypad is embedded in the typewriter keys as shown below:

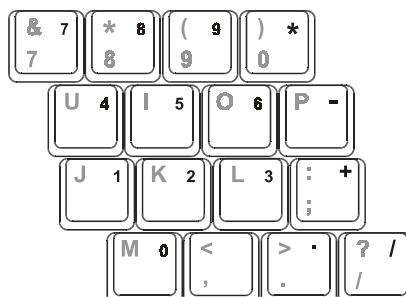

Numeric keys facilitate entering of numbers and calculations. When Num Lock is on, the numeric keys are activated; meaning you can use these keys to enter numerals.

**NOTE:**

- When the numeric keypad is activated and you need to type the English letter in the keypad area, you can either turn Num Lock off or you can press **Fn** and then the letter without turning Num Lock off.
- Some software may not be able to use the numeric keypad on the computer. If so, use the numeric keypad on an external keyboard instead.



## Euro Symbol

If your Windows supports the Euro dollar sign €, you can press the sign on the US and UK keyboards.

- To press the Euro sign on a United States-International keyboard, hold down either of the **Alt** keys and press 5 (which has an Euro sign on it).
- To press the Euro sign on a United States 101 keyboard, hold down either of the **Alt** keys and type 0128 on the numeric keypad of your keyboard.
- To press the Euro sign on an UK keyboard, hold down the **Alt Gr** key and press 4 (which has an Euro sign on it).

## Windows Keys

The keyboard has two keys that perform Windows-specific functions:

 Windows Logo key and  Application key.

The  Windows Logo key opens the Start menu and performs software-specific functions when used in combination with other keys.

The  Application key usually has the same effect as a right mouse click. (See your Windows manual for more information.)

## Function Keys

On the top row of the keys are the function keys: **F1** to **F12**. Function keys are multi-purpose keys that perform functions defined by individual programs.

Hot key functions are assigned to **F5**, **F6**, **F7**, **F10**, **F11**, and **F12** by your computer. (See “Hot Keys” later in this chapter for information.)





## Fn Key

The **Fn** key, at the lower left corner of the keyboard, is used with another key to perform the alternative function of a key. The letter “Fn” and the alternative functions are identified by the color of blue on the keytop. To perform a desired function, first press and hold **Fn**, then press the other key.

## Hot Keys

Hot keys refer to a combination of keys that can be pressed any time to activate special functions of the computer. Most hot keys operate in a cyclic way. Each time a hot key combination is pressed, it shifts the corresponding function to the other or next choice.

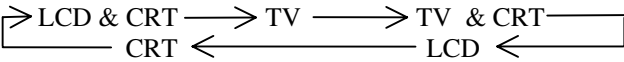
You can easily identify the hot keys with the icons imprinted on the keytop. The hot keys are described below.

Key	Description
 	Switches the display output to one of the following five when an external CRT monitor or a TV set is connected.  <b>NOTE:</b> If the display mode is set to 256 colors or lower, or in DOS mode, there will be only two modes for selecting: CRT only and LCD & CRT.
 	Decreases the LCD brightness.





Increases the LCD brightness.



Switches Battery Low beep on and off.



Switches LCD on and off.



Serves as the sleep button that you can define with Windows' **Power Management**. (See the "Power Management" in Chapter 3.)

## Using the Touchpad

**CAUTION:** Do not use a sharp object such as a pen on the touchpad. Doing so may damage the touchpad surface.

**NOTE:** For optimal performance of the touchpad, keep your fingers and the pads clean and dry. When tapping on the pad, tap lightly. Do not use excessive force.

The touchpad is a pointing device that allows you to communicate with the computer by controlling the location of the pointer on the screen and making selection with the buttons.

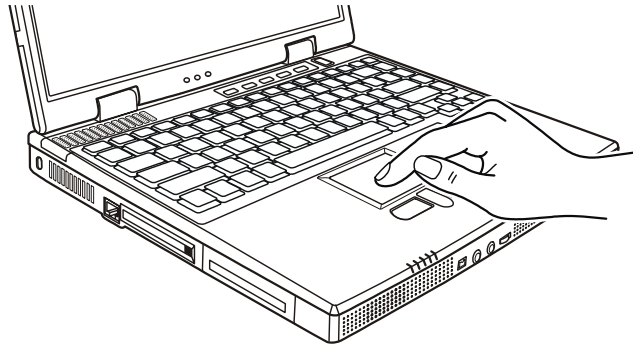

The touchpad consists of a rectangular pad and two buttons. To use the touchpad, place your forefinger or thumb on the pad. The rectangular pad acts like a miniature duplicate of your display. As you slide your fingertip across the pad, the pointer (also called cursor) on the screen moves accordingly. When your finger reaches the edge of the pad, simply relocate yourself by lifting the finger and placing it on the other side of the pad.

Here are some common terms that you should know when using the touchpad:

Term	Action
Point	Move your finger on the pad until the cursor points to the selection on the screen.
Click	Press and release the left button. -or- Tap gently anywhere on the pad.
Double-click	Press and release the left button twice in quick succession. -or- Tap twice on the pad rapidly.
Drag and drop	Press and hold the left button, then move your finger until you reach your destination (drag). Finally, release the button (drop) when you finish dragging your selection to the destination. The object will drop into the new location. -or- Gently tap twice on the pad and on the second tap, keep your finger in contact with the pad. Then, move your finger across the pad to drag the selected object to your destination. When you lift your finger from the pad, the selected object will drop into place.
Scroll	To scroll is to move up and down or left and right in the working area on the screen.  The scroll button located between the two buttons under the touchpad can be used to move vertically in a convenient way. Press the upper part of the scroll button to move up and the lower part of the scroll button to move down. -or- To move vertically, place your finger on the right edge of the pad and slide your finger up and down along the edge To move horizontally, place your finger on the bottom edge of the pad and slide your finger left and right.  This function works only after you install the touchpad driver supplied with the computer and it may not work for all applications.

**TABLE NOTE:** If you swap the left and right buttons, “tapping” on the touchpad as an alternative method of pressing the left button will no longer be valid.

## Configuring the Touchpad

You may want to configure the touchpad to suit your needs. For example, if you are a left-handed user, you can swap the two buttons so that you can use the right button as the left button and vice versa. You can also change the size of the on-screen pointer, the speed of the pointer, and so on.

To configure the touchpad, you can use the standard Microsoft or IBM PS/2 driver if you are using Windows. However, you can install the touchpad driver supplied with your computer to take advantage of more powerful features. (For information on installing the driver, see “How to Use the CD” in Chapter 6.)

## Using Easy Start Buttons

**NOTE:** The Easy Start buttons work only for Windows Me, Windows 2000 and Windows XP.

The Easy Start buttons are five user-definable buttons located above the keyboard.

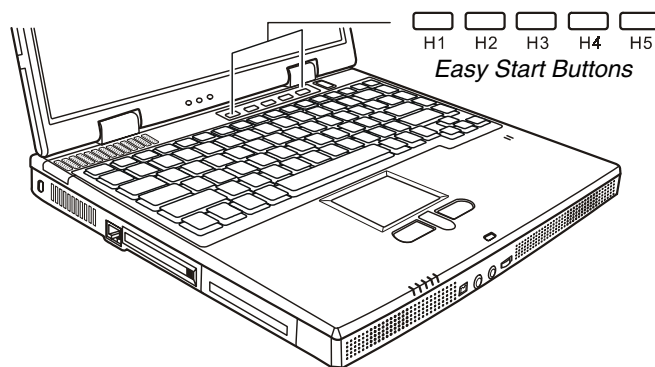

The five buttons allow you to launch your frequently used software programs with one single press of a button.

For information on defining the five buttons, see “Easy Start Button Utility” in Chapter 6.

## Using the Floppy Disk Drive

Depending on your model, an external floppy disk drive may be supplied with your computer. The floppy disk drive is referred to as drive A.

A floppy disk drive allows you to install new programs into your computer, or to store information on a removable floppy disk so you can transfer information from one computer to another.

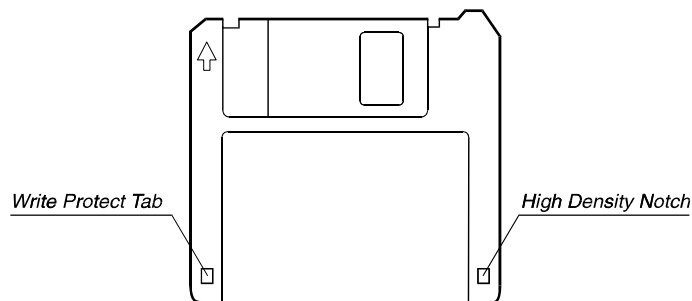

The floppy disk drive is a high-density 3.5-inch one, which can read and write to either double-density (2DD) 720-KB floppy disks or high-density (2HD) 1.44-MB floppy disks. Notice that both types of floppy disk have an arrow imprinted on the front upper left corner, and a sliding write-protect tab on the bottom left corner, as illustrated above. When opened, the write-protect tab prevents data from being written to, or erased from the floppy disk.

## Connecting the Floppy Disk Drive

To connect the floppy disk drive to the computer, connect the floppy disk drive cable into any of the USB ports of the computer. Make sure to let the USB mark face left when connecting the cable to the computer.

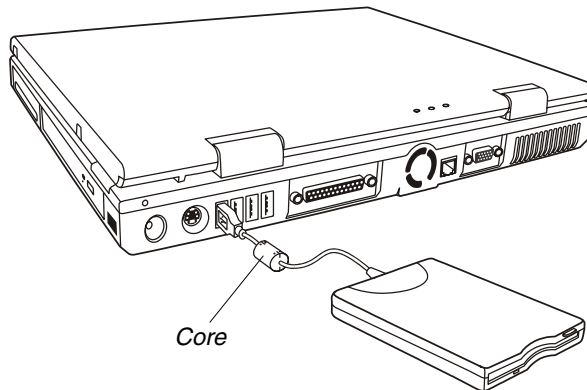

**NOTE:**

- Depending on your model, there may be a core on the floppy disk drive cable.
- Do not put the floppy disk drive upside down.
- Do not put the AC adapter on the floppy disk drive.

## Inserting and Ejecting Floppy Disks

To insert a floppy disk, hold it with the arrow facing up and towards the drive. Slide the disk into the drive until it clicks into place.

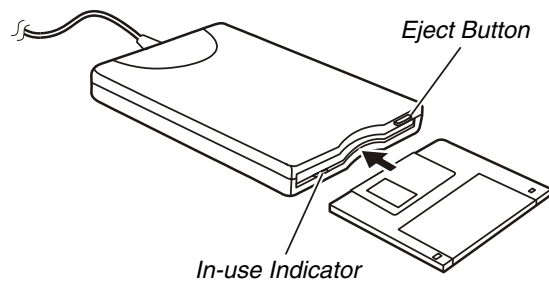

To eject a floppy disk, first ensure that the floppy disk drive is not working, and then press the eject button on the drive. When the floppy disk pops out of the drive, remove the floppy disk and store it properly.

**CAUTION:**

- Never turn off or reset the computer while the floppy disk drive is working.
- Always store your floppy disks in a safe, clean container, to protect them from the environment and magnetic fields.
- A floppy disk must be formatted before you can use it. (To know how to format a floppy disk, see your operating system manual.)

## Using the Hard Disk Drive

Your computer comes with a hard disk drive as drive C.

A hard disk drive is a storage device with non-removable, rotating, magnetic storage platters inside it. It is where your operating system and application software programs are stored.

Your hard disk drive is a 2.5-inch IDE (Integrated Drive Electronics) hard disk drive. This type of drive embodies the latest in fast, reliable mass storage by integrating all the control circuitry necessary for operation directly onto the drive itself. This allows the drive manufacturer to carefully optimize drive performance.

**CAUTION:**

- Make regular backups of your data files from your hard disk drive to floppy disks or other storage media.
- Never try to remove or install the hard disk drive while the computer is powered on. Doing so can result in loss of data, and can damage the computer and the hard disk drive's sensitive circuitry.
- Never turn off or reset the computer while the hard disk drive in-use indicator is on.



## Using the CD/DVD Drive

Your computer comes with a CD/DVD drive, usually configured as drive D.

The drive uses removable 5.25-inch silver discs, which look like standard music CDs. It is an ideal medium to use for distributing multimedia because of the huge amount of data that a disc can store.

Depending on the model, your drive is one of the following:

- **CD-ROM drive** can read CD-ROMs, audio CDs, CD-R, and CD-RW discs.
- **CD-RW drive** can not only read the above discs but also write to CD-R and CD-RW discs.
- **DVD-ROM drive** can read DVD (Digital Versatile Disc) discs in addition to the above discs.
- **Combo drive** can work both as a DVD-ROM drive and CD-RW drive.

### CAUTION:

- When inserting a CD, do not use force.
- Make sure the CD is correctly inserted into the tray, and then close the tray.
- Do not leave the CD tray open. Also, avoid touching the lens in the tray with your hand. If the lens becomes dirty, the CD-ROM may malfunction.
- Do not wipe the lens using materials with rough surface (such as paper towel). Instead, use a cotton swab to gently wipe the lens.

FDA regulations require the following statement for all laser-based devices:  
“Caution, Use of controls or adjustments or performance of procedures other than those specified herein may result in hazardous radiation exposure.”

### NOTE: For DVD-ROM drive only.

This product incorporates copyright protection technology that is protected by method claims of certain U.S. patents and other intellectual property rights owned by Macrovision Corporation and other rights owners. Use of this copyright protection technology must be authorized by Macrovision Corporation, and is intended for home and other limited viewing uses only unless otherwise authorized by Macrovision Corporation. Reverse engineering or disassembly is prohibited.

## Inserting and Removing a CD

**NOTE:** The following procedure applies to inserting or removing a DVD as well.

Follow this procedure to insert or remove a CD.

1. Turn on the computer.
2. Press the eject button and the CD tray will slide out partially. Gently pull on it until it is fully extended.
3. To insert a CD, place down the CD in the tray with its label facing up. Slightly press the center of the CD until it clicks into place.

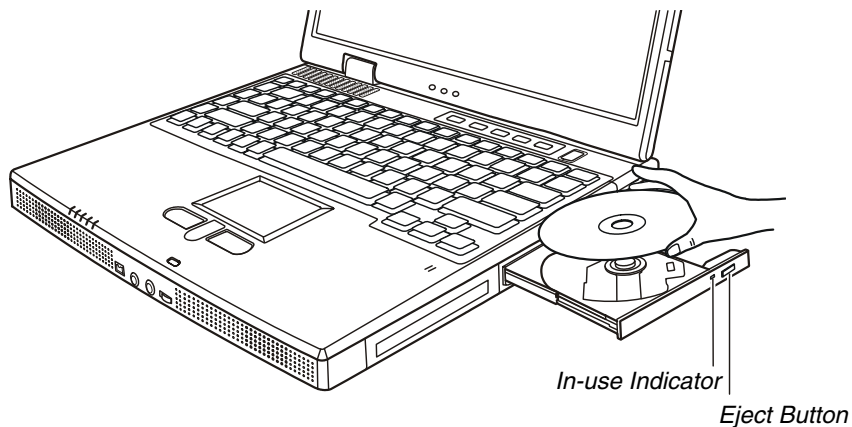

To remove a CD, hold the CD by its outer edge and lift it up from the tray.

4. Gently push the tray back into the drive.

**NOTE:** In the unlikely event that you are unable to release the CD tray by pressing the eject button, you can manually release the CD. (See “CD Drive Problems” in Chapter 8.)

## Using the Video Features

The video subsystem of your computer features:

- 14.1/15-inch TFT (Thin-Film Transistor) color LCD display with 1024x768 XGA (Extended Graphics Array) resolution.
- Simultaneous display on LCD and external monitor, which is useful when you have a presentation as you can control the screen from your computer and face the audience at the same time.
- S-video support allows the connection of a TV set, and simultaneous display on TV and external monitor.
- Power Management.

**NOTE:** The computer enters Standby or Hibernation mode when the LCD is closed. If you want to use the computer with the LCD closed, set *None* to the “When I close the lid of my portable computer” option in the Power Management Properties. Thus the computer does not enter Standby or Hibernation mode when the LCD is closed.

## Configuring the Display Modes

**NOTE:** To take advantage of the enhanced video capabilities, the video driver supplied with your computer must be installed.

Your computer has been set to a default resolution and number of colors before shipment. You can view and change display settings through your operating system. See your operating system documentation or online help for specific information.

For displaying in higher resolutions, you can connect an external CRT monitor that supports higher resolutions. (See “Connecting an External Monitor” in Chapter 4 for more information.)

The following table lists the display modes supported by your computer.

Display Mode		LCD & CRT	TV Only	TV & CRT	LCD Only	CRT Only
640x480	8-bit	√	√	√		√
	16-bit	√	√	√		√
	32-bit	√	√	√		√
800x600	8-bit	√	√	√	√	√
	16-bit	√	√	√	√	√
	32-bit	√	√	√	√	√
1024x768	8-bit	√	√	√	√	√
	16-bit	√	√	√	√	√
	32-bit	√	√	√	√	√
1280x1024	8-bit	√			√	√
	16-bit	√			√	√
	32-bit	√			√	√
1600x1200	8-bit					√
	16-bit					√
	32-bit					√

**TABLE NOTE:** 8-bits = 256 colors; 16-bits = High Color or 65,536 (64 K) colors; 24 and 32-bit = True Color 16,770,000 (16 M) colors.

## Using the Audio Features

**NOTE:**

- To take advantage of the enhanced audio capabilities, the audio driver supplied with your computer must be installed.
- If you experience interference while recording, try lowering the microphone recording volume.

The audio subsystem of your computer features:

- Digital audio and analog mixing functions required for recording and playing sound on your computer
- Sound Blaster Pro, Adlib, and Microsoft Windows Sound System support
- Built-in microphone (❶) and a set of speakers (❷)
- Volume control (❸)
- External audio connectors (❹)

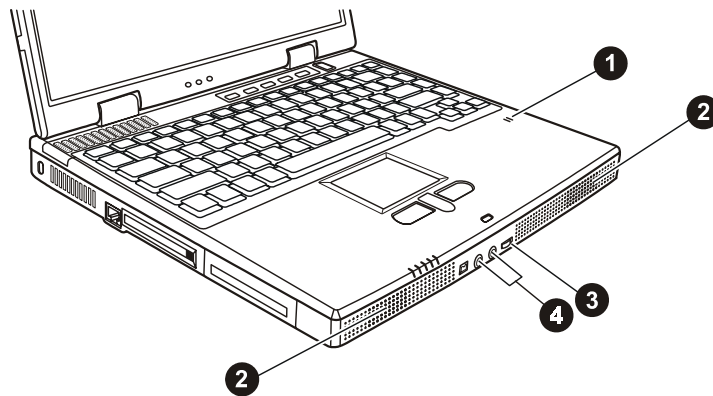

Ways of playing and recording sound vary with the operating system used. See your operating system documentation or online help for specific information.

## Connecting Audio Devices

For higher audio quality, you can send or receive sound through external audio devices.

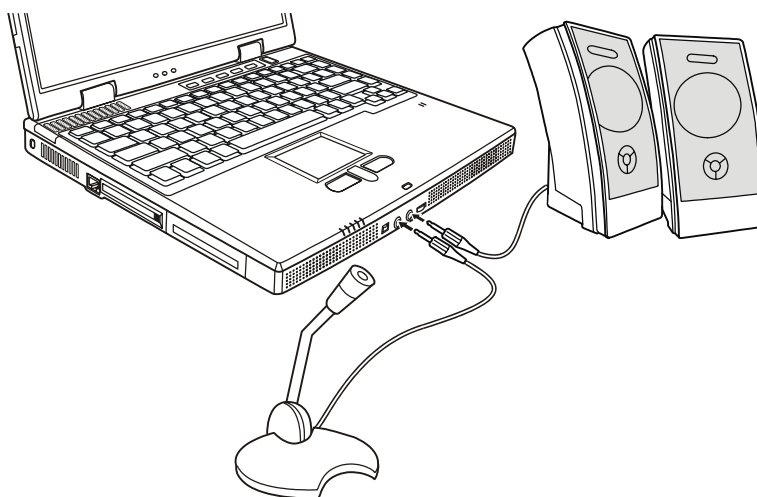

- **Microphone Connector** can be connected to an external microphone for recording voice or sound.
- **Audio Output Connector** can be connected to the line-in connector of powered speakers with built-in amplifiers, headphones, or earphone set. This connector is compliant to S/PDIF (Sony/Philips Digital Interface). You can connect audio equipment with S/PDIF to the computer.

**NOTE:** When using external speakers/headphones or microphone, you cannot use the internal one.

# Using the Communication Features

## Using the Modem

**NOTE:** To take advantage of the modem feature, the modem driver supplied with your computer must be installed.

The internal 56 K fax/data modem allows you to use the telephone line to communicate with others by fax, email, or connect to an online service or bulletin board.

To connect the telephone line to the modem, connect one end of the modem cable to RJ-11 connector on the computer and the other end to the phone line.

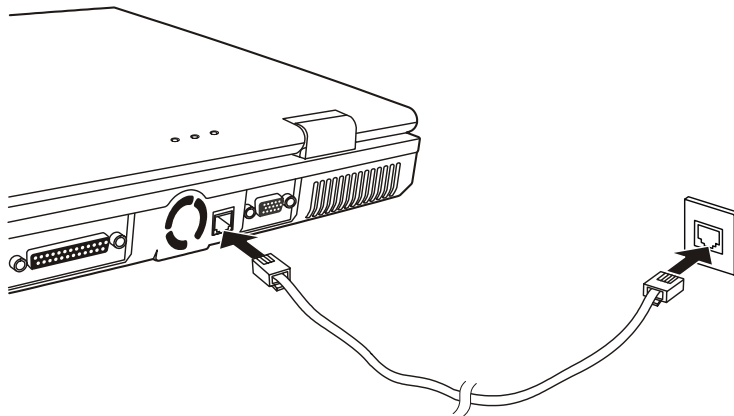

**NOTE:**

- When using communication software, you may have to disable power management.
- Set the COM port of the modem to COM3.
- Set parameters such as modem speed (baud rate) and line type (pulse dialing or tone dialing).
- Do not enter Standby when using communication software.

## Using the LAN

**NOTE:** To take advantage of the LAN feature, the LAN driver supplied with your computer must be installed.

The internal 10/100Base-T LAN (Local Area Network) module allows you to connect your computer to a network. It supports data transfer rate up to 100 Mbps.

To connect the network cable to the LAN module, connect one end of the LAN cable to the RJ-45 connector on the computer and the other end to the network hub.

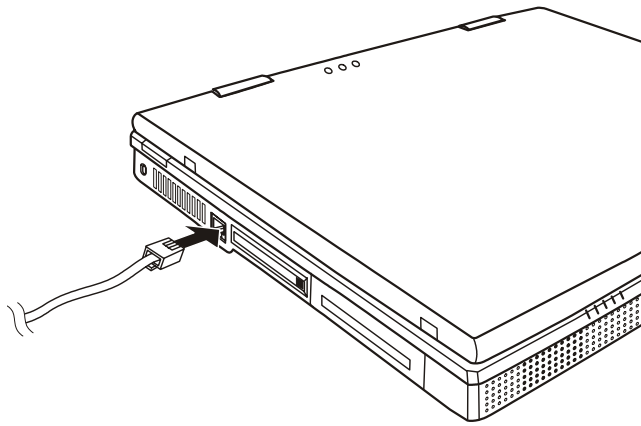



# *Managing Power*

Your computer operates either on external AC power or internal battery power.

This chapter tells you how you can effectively manage power. To maintain optimal battery performance, it is important that you use the battery in the proper way.

The topics in this chapter include:

- What is an AC adapter
- How to charge the battery pack
- When and how to initialize the battery pack
- How to check the battery level
- How to replace the battery pack
- What happens when the battery is low and what actions to take
- What is Power Management
- How to save power

## AC Adapter

**CAUTION:**

- The AC adapter is designed for use with your computer only. Connecting the AC adapter to another device can damage the adapter.
- The AC power cord supplied with your computer is for use in the country where you purchased your computer. If you plan to go overseas with the computer, consult your dealer for the appropriate power cord.
- When you disconnect the AC adapter, disconnect from the electrical outlet first and then from the computer. A reverse procedure may damage the AC adapter or computer.
- When unplugging the connector, always hold the plug head. Never pull on the cord.

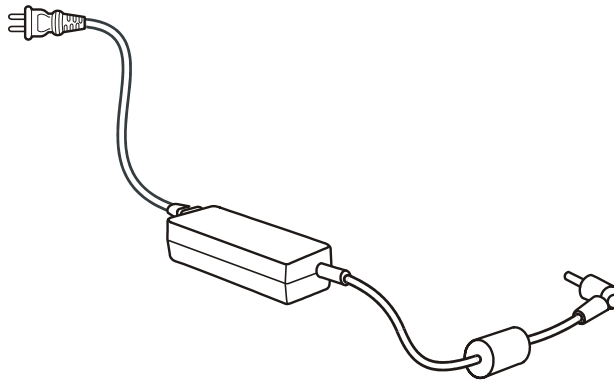

The AC adapter serves as a converter from AC (Alternating Current) to DC (Direct Current) power because your computer runs on DC power, but an electrical outlet usually provides AC power. It also charges the battery pack when connected to AC power.

The adapter operates on any voltage in the range of 100~240V AC.

# Battery Pack

The battery pack is the internal power source for the computer. It is rechargeable using the AC adapter.

The operating time of a fully charged battery pack depends on how you are using the computer. When your applications often access peripherals, you will experience a shorter operating time.

**NOTE:** Care and maintenance information for the battery is provided in Chapter 7. In addition to this chapter, be sure to read the “Battery Pack Guidelines” section in Chapter 7 as well.

## Charging the Battery Pack

**NOTE:**

- Charging will not start if the battery’s temperature is below 0°C (32°F) or above 45°C (113°F).
- The charging process will stop and the Battery Charge Indicator flashes orange when the battery’s temperature gets above 60°C (140°F). If this happens, the battery pack may be damaged. Please contact your dealer.
- During charging, do not disconnect the AC adapter before the battery has been fully charged; otherwise you will get a prematurely charged battery.

To charge the battery pack, connect the AC adapter to the computer and an electrical outlet. The Battery Charge Indicator (  ) on the computer glows orange to indicate that charging is in progress. You are advised to keep the computer power off while the battery is being charged. When the battery is fully charged, the Battery Charge Indicator glows green.

It takes approximately 3 hours to fully charge the Li-Ion battery pack when the computer is off, and 4~5.5 hours to fully charge the Li-Ion battery pack when the computer is on.

**CAUTION:** After the computer has been fully recharged, do not immediately disconnect and reconnect the AC adapter to charge it again. Doing so may damage the battery.

**NOTE:** The battery level may automatically lessen due to the self-discharge process (0.21% per day), even when the battery pack is fully charged (100%). This happens no matter if the battery pack is installed in the computer.

## Initializing the Battery Pack



You need to initialize a new battery pack before using it for the first time or when the actual operating time of a battery pack is much less than expected.

Initializing is the process of fully charging, discharging, and then charging. It can take several hours.

1. Make sure the computer power is turned off. Connect the AC adapter to fully charge the battery pack.
2. After the battery pack is fully charged, turn on the computer. When the message “Press <F2> to enter System Configuration Utility” appears, press **F2** to invoke the program.
3. Disconnect the AC adapter and leave the computer on until the battery is fully discharged. The computer will shut down automatically.
4. Connect the AC adapter to fully charge the battery pack.

## Checking the Battery Level

**NOTE:** Any battery level indication is an estimated result. The actual operating time can be different from the estimated time, depending on how you are using the computer.

You can check the approximate battery level using the battery meter function of the operating system. To read the battery level in Windows, click the icon  on the taskbar. (Click the  icon if the computer is using AC power.)

## Replacing the Battery Pack

**CAUTION:**

- There is danger of explosion if the battery is incorrectly replaced. Replace the battery only with the computer manufacturer's optional battery packs. Discard used batteries according to the dealer's instructions.
- Do not attempt to disassemble the battery pack.

If you often rely on battery power for a long period of time while traveling, you may consider the purchase of an additional battery pack from your dealer and keep it with you in a fully charged state as a backup.

To replace the battery pack, follow these steps:

1. Make sure the computer is not turned on or connected to AC power.
2. Carefully place the computer upside down.
3. Slide the release lever to the unlock (🔓) position (❶).
4. Slide and hold the release lever outward, and pull the battery pack out of its compartment (❷).

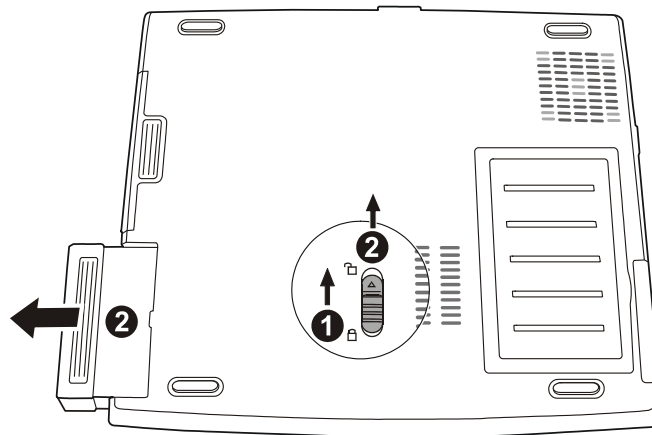

5. Insert the new battery pack into the compartment and slide the release lever to the lock (🔒) position.

## Battery Low Signals and Actions

Battery Low occurs when the battery has approximately 10% of its charge remaining. The computer gives warning beeps and the Battery Charge Indicator (🔋) blinks red to alert you to take actions.

**| NOTE:** You can set up your threshold and signals of Battery Low under Windows.

Immediately save your data upon Battery Low. The remaining operating time depends on how you are using the computer. If you are using the audio subsystem, PC card, hard or floppy disk drives, the battery might run out of charge very quickly.

Always respond to Battery Low by placing your computer on Standby or Hibernation mode, turning off the computer, or connecting the AC adapter.

If you do not take any action and after two minutes' of warning beeps, the computer will automatically hibernate and turn off.

**CAUTION:**

- If you are using a flash PC Card, do not access the card during battery low periods. This is because the access may take longer than the time it takes the battery to run out of charge, thus making your access to the card unsuccessful.
- If you fail to save your data when the battery completely runs out of charge, then you lose your data.

# Power Management

Your computer supports APM (Advanced Power Management) and ACPI (Advanced Configuration and Power Interface) for power management. The power management feature allows you to reduce the power consumption for energy saving.

With an ACPI-compliant operating system such as Windows Me, Windows 2000 and Windows XP, power supply to different computer components is controlled on an as-needed basis. This allows maximum power conservation and performance at the same time.

In general, Windows' power management works in this way:

What...	When...
Power to the hard disk is turned off	When the hard disk has been idle for a set period.
Power to the display is turned off	When the display has been idle for a set period.
The computer enters Standby mode. The hard disk and display are turned off and the entire system consumes less power.	When the entire system has been idle for a set period.
	When you press <b>Fn+F12</b> . *
	When you close the cover. *
The computer enters Hibernation mode. (See the next subsection for more information.)	When you press the power button. *
	When you press <b>Fn+F12</b> . *
	When you close the cover. *
	When you press the power button. *

\* Depends on your settings in Windows.

For detailed information on power management, see Windows' Help.

## Hibernation

Hibernation is a very useful feature. People frequently open many applications when they use computers. It takes some time to get all these applications open and running, and normally they all have to be closed before the system can be turned off.

When you use the hibernation feature, you do not have to close the applications. The computer stores the state of your computer to a file on the hard disk and then shut down. The next time you turn on your computer, you return to exactly where you left off.



## Power-Saving Tips

In addition to your computer's automatic power management, you can do your part to maximize the battery's operating time by following these suggestions.

- Do not disable Power Management.
- Decrease the LCD brightness to the lowest comfortable level.
- Disable the parallel port if no devices are connected to these ports. (See "Advanced Menu" in Chapter 5.)
- If you work with an application that uses a PC Card, exit the application when you finish using it.
- If you have a PC Card installed, remove it when not in use. Some PC Cards drain power even while they are inactive.
- Turn off the computer when you are not using it.



# *Expanding Your Computer*

You can expand the capabilities of your computer by connecting other peripheral devices. When using a device, be sure to read the instructions accompanying the device together with the relevant section in this chapter.

This chapter gives guidelines on installing and using these devices:

- External monitor
- TV
- Parallel device
- USB device
- IR device
- IEEE 1394 device
- PC Card

## Connecting an External Monitor

If you want the benefits of a larger display screen with higher resolution, you can connect an external CRT monitor to your computer.

Follow this procedure to connect an external monitor:

1. Make sure the computer is not turned on.
2. Plug the monitor's D-type signal connector to the computer's VGA port.

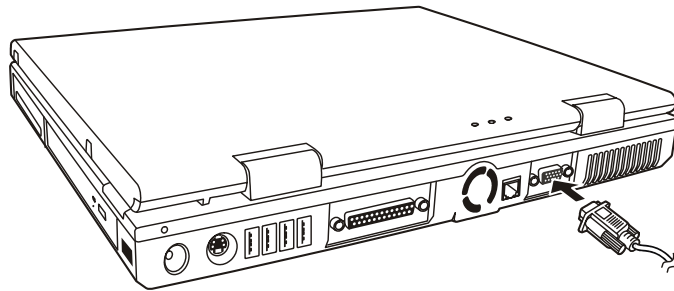

3. Plug one end of the monitor's power cord into the power socket on the monitor and the other end to an electrical outlet.
4. To use the monitor, turn on the monitor before turning on the computer.
5. The monitor should respond by default. If not, you can switch the display to the monitor or to both (simultaneous display) by pressing **Fn+F5**. In Windows, you can also change the display through the settings in **Display Properties**.
6. You can change display settings through your operating system. See your operating system documentation or online help for specific information.

**CAUTION:** Do not disconnect the external monitor while the computer is in Standby mode or Hibernation mode. If no external monitor is connected when the computer resumes, the LCD remains blank and the output is not displayed.

## Connecting a TV

For entertainment, conferences, or presentations, you can connect a TV to your computer.

Follow this procedure to connect a TV:

1. Make sure the computer is not turned on.
2. You need a video cable for connection. Plug the connector of the video cable to the computer's S-video connector. Plug the other end of the cable into the video input connector of the TV.

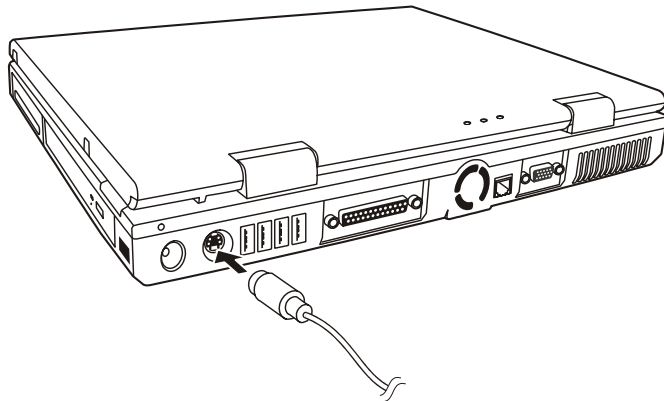

3. Turn on the computer and run the BIOS SCU program. Set the **TV System** item to *PAL* or *NTSC* according to the specifications of your location. Save and exit the SCU program. The computer will be restarted.
4. Turn on the power of the TV and switch to the video mode.
5. Switch the display to TV by pressing **Fn+F5**. In Windows, you can also change the display through the settings in **Display Properties**.

**CAUTION:**

- Do not set the display to both LCD and TV. This may cause unstable display on the LCD.
- Do not disconnect the TV while the computer is in Standby mode or Hibernation mode. If the TV is connected when the computer resumes, the LCD remains blank and the output is not displayed.

**NOTE:** Make sure that the VGA driver is installed correctly.

## Connecting a Parallel Device

Your computer has a Parallel port for connecting a parallel device such as printer. The port supports ECP (Extended Capabilities Port) and EPP (Enhanced Parallel Port) modes that turn the standard parallel port into a high-speed bi-directional peripheral port.

Follow this procedure to connect a parallel device:

1. Make sure that the **LPT Port** item is set properly in the SCU program. (See “Advanced Menu” in Chapter 5 for information.)
2. Make sure the computer is not turned on.
3. Plug the parallel device’s cable to the computer’s parallel port.

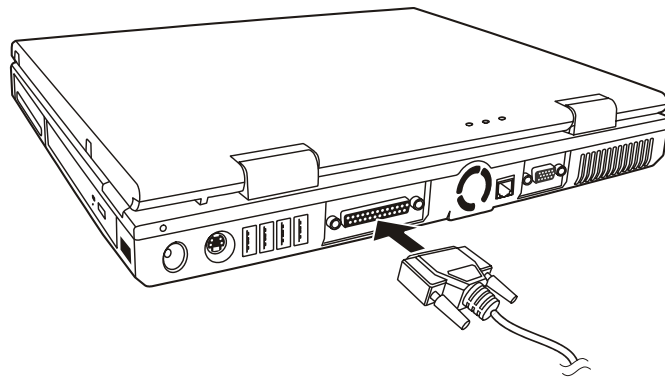

4. If the parallel device has independent power, plug its power cord into an electrical outlet.
5. If the parallel device has its own power switch, turn on the printer before turning on the computer.

## Connecting a USB Device

Your computer has four USB ports for connecting USB devices such as digital camera, scanner, printer, modem, and mouse.

USB is specified to be an industry standard extension to the PC architecture. It supports “Plug and Play” technology so you can install and remove USB devices without turning off the computer. With its multiple connection capability, up to 127 devices can be connected in a daisy-chain configuration. In addition, you can use a USB hub that converts a single USB connector into multiple ports where USB devices can be connected.

To connect a USB device, simply plug the device cable to one of the USB ports.

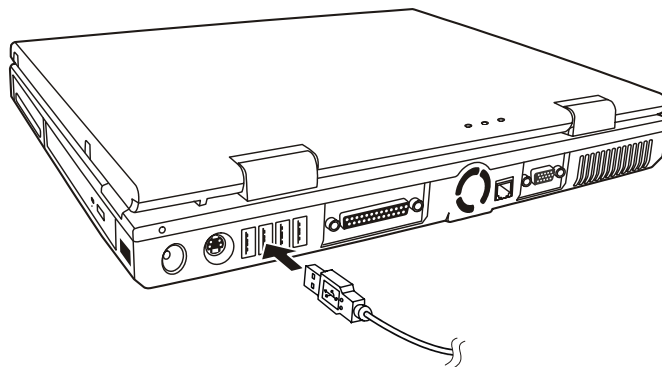



## Connecting an IR Device

Your computer has an IR (infrared) port for connecting an infrared-equipped device wirelessly such as another computer, printer, or PDA (Personal Digital Assistant).

The infrared feature supports these standards:

- IrDA 1.1 (FIR – Fast Infrared) with 4.0 Mbps transfer rate
- IrDA 1.0 with 1.152 Mbps transfer rate
- ASK (SIR – Serial Infrared) with 2.4 Kbs transfer rate

Follow this procedure to connect an IR device:

1. Under Windows, make sure that the IrDA Fast Infrared Port is set to HP HSDL-2300/3600. (See “How to Use the CD” in Chapter 6 for information.)
2. Make sure that the **COM Ports** item is set properly in the SCU program. (See “Advanced Menu” in Chapter 5 for information.)
3. Place the target device where its IR port faces the IR port of your computer within the effective range – within  $\pm 15$ -degrees angle and 1 meter (3 feet) distance.

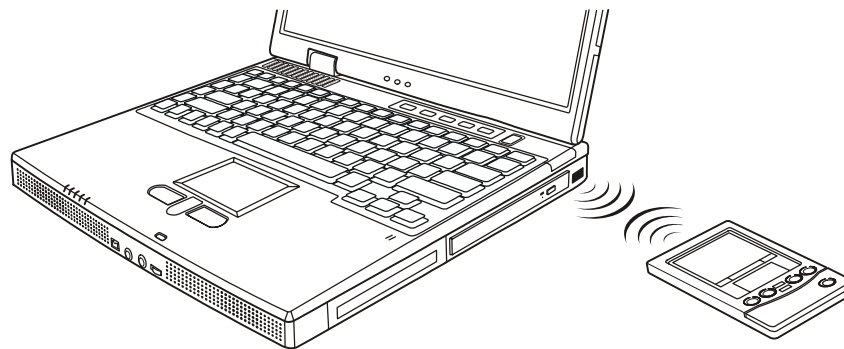

4. To take advantage of the IR communications, you need a third party software.

**NOTE:** During infrared communication, take note of the following:

- Do not move the computer and IR device.
- Do not enter Standby mode.
- Do not use a cell phone or another IR device near the computer.
- Avoid strong light such as sunlight or fluorescent light.
- Disable the screen saver.

## Connecting an IEEE 1394 Device

Your computer has an IEEE 1394 port on the front of the computer for connecting 1394 devices.

IEEE 1394 is the next-generation serial bus standard, featuring high-speed data transfer, multi-channel communication link, and “Hot Plug” connectivity. It allows connection of up to 63 devices. The applications include not only computer peripheral devices such as scanner, printer and high-quality CCD, but also consumer electronic equipments such as DVCAM and VCR.

To connect a 1394 device, simply plug the device cable to the IEEE 1394 port of the computer.

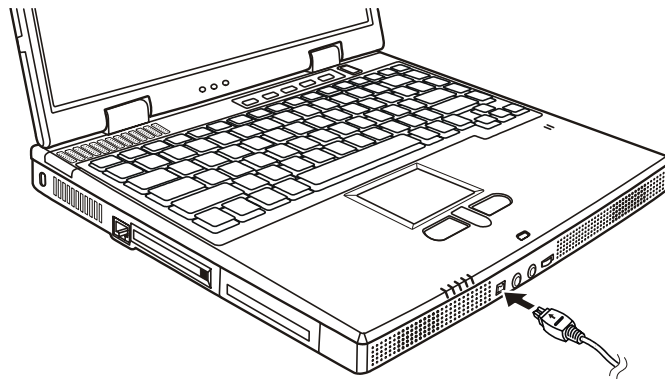

## Using PC Cards

Your computer has a PC Card slot.

PC Cards are credit card-sized peripheral products based on the standards developed by PCMCIA (Personal Computer Memory card International Association). PCMCIA is a non-profit association for promoting the interchangeability among mobile computers where ruggedness, low power, and small size are critical. Ever since its foundation, the association has been continuing their efforts to add new specifications to the PC Card standard as new needs always arise in the market.

## PC Card Type

Your computer's PC Card slot can accommodate a type II card. Typical type II cards are flash memory, SRAM, modem, LAN, and SCSI cards.

## CardBus Support

Your computer's PC Card slot supports CardBus specifications. CardBus is the 32-bit version of PC Card technology. It allows speeds of up to 133 Mbps at 33 MHz. Typical applications are SCSI host bus and high-speed network cards.

## Inserting and Removing a PC Card

**NOTE:**

- Some PC Cards require additional system resources. Before using such PC card, you may have to free other system resources for the PC Card.
- Although some PC Cards can be inserted and removed without turning off the computer, you cannot remove or install PC Cards during Standby mode.

To insert a PC Card:

1. Locate the PC card slot on the left side of the computer.

2. Slide the PC Card, with its label facing up, into the slot until the eject button pops out.

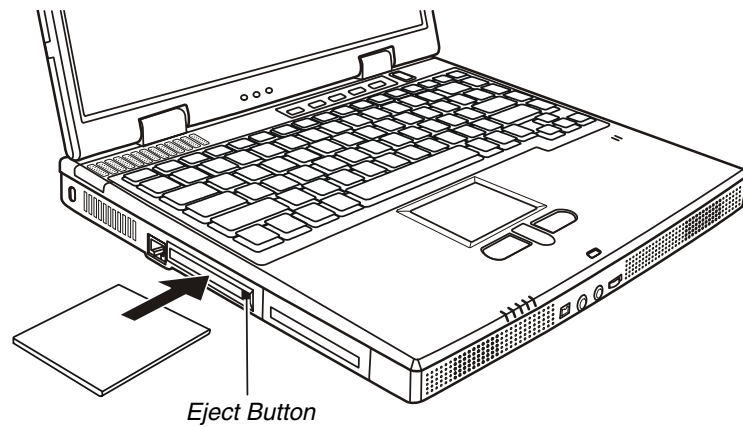

3. When a new card is seated, the computer will detect it and try to install the appropriate driver. Follow the on-screen instruction to complete the process.

To remove a PC Card:

1. Your operating system may require you to stop the PC card before you actually remove it. (In Windows, double-click the **PC Card** icon in **Control Panel** to stop the card.)
2. Push the eject button and the card will slide out slightly.
3. Pull the card out of the slot.

## Internal Components Upgrade

You can upgrade your computer by changing the CPU or adding memory. However, to avoid damage during the installation procedure, please ask your dealer for help. Do not install an internal component by yourself.

## ***Using BIOS Setup***

System Configuration Utility (SCU) is a program for configuring the BIOS (Base Input/Output System) settings of the computer.

BIOS is a layer of software, called firmware, that translates instructions from other layers of software into instructions that the computer hardware can understand. The BIOS settings are needed by your computer to identify the types of installed devices and establish special features.

This chapter tells you how to use the BIOS SCU.

# When and How to Use BIOS Setup

## When to Use

You need to run SCU when:

- You see an error message on the screen requesting you to run SCU.
- You want to restore the factory default settings.
- You want to modify some specific settings according to the hardware.
- You want to modify some specific settings to optimize system performance.

## Starting BIOS Setup

**NOTE:**

- The SCU screens shown in this chapter are for your reference only. The actual items or settings on your computer may differ.
- The SCU program may have been updated after the publication of this manual.
- The settings you select in your operating system might override similar settings in SCU.

To run SCU, press **F2** when the prompt appears on the screen during system startup. The prompt shows up on the screen for only a few seconds. You must press **F2** quickly. The SCU main menu appears as shown next.



Main    Advanced    Security    Boot    Exit

```
-----  
Devices  
-----  
Primary Master    = 1672 GB  
CD-ROM            = NONE  
  
Serial Port       = IR2, 2200, IRQ 3  
Parallel Port     = LPT1, 378, IRQ 7
```

```
-----  
System  
-----  
CPU = Pentium 4  
CPU Speed = 1700 MHz  
SYSTEM BIOS = 0.90a  
EC        BIOS = 2.03
```

```
-----  
Memory  
-----  
Base            =        640 KB  
Extended       = 125952 KB  
Video           = 32768 KB  
Total RAM       = 159744 KB  
Cache (Ext)    =           0 KB
```

Configure main conditions (date and time, hard disk type...etc)

## Moving Around and Making Selections

You must go through two or three levels to complete the setting for an item. In most cases, there are three levels: menu title, pull-down menu, and submenu.

To move around and make selections, you can use the keyboard.

### Using the keyboard

Keyboard information can be found at the bottom of the screen. A brief description of keyboard usage is listed below:

<b>Key</b>	<b>Function</b>
←, →	Selects a menu title.
↑, ↓	1) Selects an item or option. 2) Brings up/down the value.
<b>Enter</b>	1) Brings up the sub-menu when an item with the arrow ► sign is selected. 2) Opens or closes the option window when an item is selected.
<b>Tab</b>	Jumps from one item to another.
<b>Esc</b>	1) Exits SCU. 2) Returns to the previous menu if in a sub-menu. 3) Closes the options window if one is open.

## Main Menu

The Main pull-down menu contains the basic configuration settings of the system.

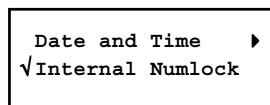

**Date and Time** sets the system date and time.

**Internal Numlock** sets if you can enter a number when Num Lock is turned off. When this item is enabled, you can press and hold **Fn**, and then press a letter key to enter a number even if Num Lock is turned off. When this item is disabled, you cannot enter a number with the above method. A check mark (✓) indicates *Enabled*; an underline ( \_ ) indicates *Disabled*. The default setting is *Enabled*.

## Advanced Menu

The Advanced pull-down menu contains the I/O configuration settings of the system.

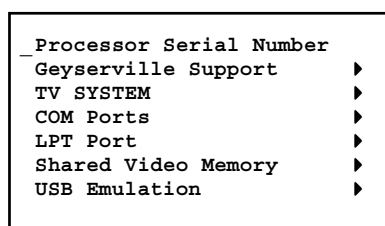

**NOTE:** Incorrect settings in this menu may cause your system to malfunction. You are advised to keep the default settings.

**Processor Serial Number** allows you to enable or disable the display of the Processor Serial Number during POST. The Processor Serial Number is an electronic number incorporated into the new Pentium III and Pentium 4 processors. A check mark (✓) indicates *Enabled*; an underline ( \_ ) indicates *Disabled*. The default setting is *Disabled*.

**NOTE:** This item is available only if the CPU of your computer supports the Processor Serial Number feature.

**Geyserville Support** configures the Geyserville feature of the CPU. Geyserville lets you customize high performance computing on your computer. When computer is using AC power, CPU will run in full speed. When computer is using battery power, CPU will lower down to conserve battery life while maintaining a high level of performance.

**NOTE:** This item is available only when the CPU supports the Geyserville feature.

**TV System** sets the TV mode when a TV is used for display output. Select *PAL* for use in UK and Europe, *NTSC* for use in other areas. The default setting is *PAL*.

**COM Ports** configures the COM ports of the computer.

**COM B I/O Settings** sets the I/O address and the interrupt request line (IRQ) settings of the COM port. The options are *Disabled*,

*IR1/3F8/IRQ 4, IR2/2F8/IRQ 3, IR3/3E8/IRQ 4 and IR4/2E8/IRQ 3.*  
The default setting is *IR2/2F8/IRQ 3*.

**Mode Setting For COM B** sets the communication compatibility mode according to the type of the IR device to be connected. The options are *ASK IR* and *FAST IR*, The default setting is *FAST IR*. This item is not valid for setting if the **COM B I/O Settings** item is set to *Disabled*.

**LPT Port** configures of the parallel port of the computer.

**Port** sets the I/O address and the interrupt request line (IRQ) settings of the parallel port. The options are *Disabled, LPT1/378/IRQ 7, LPT2/278/IRQ 5, LPT3/3BC/IRQ 7*.

**Mode** sets the operating mode for the parallel port according to the type of the parallel device to be connected. You system supports EPP (Enhanced Parallel Port) and ECP (Extended Capabilities Port) standards, which turn the standard parallel port into a high speed bi-directional peripheral port. The options are *Standard AT, Bidirectional, Enhanced Parallel* and *Extended Capabilities*. This item is not valid for setting if the **Port** item is set to *Disabled*.

**DMA Setting For ECP Mode** sets the DMA (Direct Memory Access) channel of the ECP mode. The options are *DMA 0, DMA 1* and *DMA 3*. This item is not valid for setting if the **Port** item is set to *Disabled* and the **Mode** item is not set to *Extended Capabilities*.

**Shared Video Memory** sets size of the video memory shared from the system memory. The options are *8M, 16M, 32M* and *64M*, and the default setting is *32M*.

**USB Emulation** enables or disables the system's support for the USB port in DOS mode.

**Enable USB Port** enables or disables the USB port in DOS mode. The default setting is *Enabled*.

**USB Keyboard** enables or disables the USB keyboard in DOS mode. The default setting is *Enabled*. This item is not valid for setting if the **Enable USB Port** item is disabled.

**USB FDD** enables or disables the USB floppy disk drive in DOS mode. The default setting is *Enabled*. This item is not valid for setting if the **Enable USB Port** item is disabled.

## Security Menu

The Security pull-down menu contains the security settings, which safeguard your system against unauthorized use.

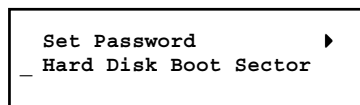

**Set Password** sets the password. When typing the password, first make sure that Num Lock is off, then type the password in the entry fields and press **Enter**. Confirm your password by typing it again and pressing **Enter**.

**NOTE:** If the **Enable Password to Power-On** item is enabled, the set password is always required to boot the computer.

**Hard Disk Boot Sector** helps prevent computer viruses by protecting the hard disk boot sector (partition table) from any change if enabled. A check mark (✓) indicates *Enabled*; an underline (\_) indicates *Disabled*. The default setting is *Disabled*.

**CAUTION:** Disable this item before installing an operating system, running Fdisk or Format program. Otherwise, the intended action will fail.

## Boot Menu

The Boot pull-down menu sets the sequence of the devices to be searched for the operating system.



**Boot Device** sets the sequence of booting. The devices include *Hard Disk C*, *CD-ROM Drive*, *Floppy Disk Drive* and *LAN Boot*. If you set the first boot device to *LAN Boot*, the system will boot from the LAN server first.

**NOTE:** If you set all booting options to the same device, then the computer will try to boot from that device only.



## Exit Menu

The Exit pull-down menu displays ways of exiting SCU. After finished with your settings, you must save and exit so that the new settings can take effect.

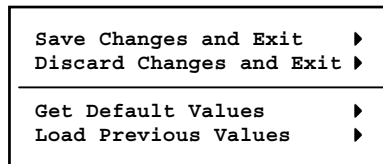

**Save Changes and Exit** saves the changes you have made and exits SCU.

**Discard Changes and Exit** exits SCU without saving the changes you have made.

**Get Default Values** loads factory default values for all the items.

**Load Previous Values** loads CMOS values before running SCU.



## ***Installing Software Drivers***

To take full advantage of the unique features of your computer, some operating systems require custom software, known as drivers, to be installed.

If you purchased the computer with Windows pre-installed, your dealer may have already installed the drivers. If not, you need to install the drivers using the CD supplied with your computer.

This chapter describes how to install the drivers.

## How to Use the CD

**NOTE:**

- The drivers may have been updated after this manual was published. For driver's upgrade, please contact your dealer.
- This CD supports Windows 2000, Windows Me and Windows XP only.











An autorun program is provided on the driver CD to help you easily install the drivers. As you insert the CD, the autorun program automatically starts. If you need to start the program manually, run the **Setup.exe** program on the CD.

The main screen appears as shown next:



**NOTE:** The icons appearing on the left side depend on the operating system you are using as well as the availability of the hardware device on your computer.

To install the intended driver, just click on the corresponding icon on the left side and the installation will start. The icons and drivers are described next:

Icon	Name	Description
	Video driver	Installs the driver that allows you to select high-resolution displays with richer colors.
	AGP driver	Installs the AGP 4X/133 driver to ensure the full function of the VGA and other drivers. <b>NOTE:</b> This function is for Windows 2000/XP only.
	Audio driver	Installs the driver that allows you to take full advantage of the audio subsystem.
	Modem driver	Installs the driver that allows you to use the modem function of the computer. <b>NOTE:</b> For Windows Me/2000, select <i>Specify the location of the driver (Advanced)</i> when the <b>Add New Hardware Wizard</b> window appears, then click <b>Next</b> . Click <b>Next</b> again and the system will automatically locate the correct driver.
	LAN driver	Installs the driver that allows you to use the network function of the computer.
	Touchpad driver	Installs the driver that allows you to take full advantage of the touchpad features.
	Easy Start Button driver	Allows you to define the Easy Start buttons. (For information on installing and using the utility, see “Other Drivers and Utilities” later in this chapter.)
	Power Management utility	Allows you to optimize the power consumption of CPU. <b>NOTE:</b> This item is available only when the CPU supports the Geyserville feature, and you do not need to install this driver when using Windows XP.
	IR Module Select guide	Shows how to set the IR module for the operating system used.
	Browse CD	Browses the contents of this CD.

## Other Drivers and Utilities

### Easy Start Button Utility

The ESB (Easy Start Button) utility allows you to define the five Easy Start buttons.

#### Using the ESB Utility

To start the utility, double-click the Easy Start Button icon  on the taskbar. The **Easy Start Button Definition** window appears as shown next.

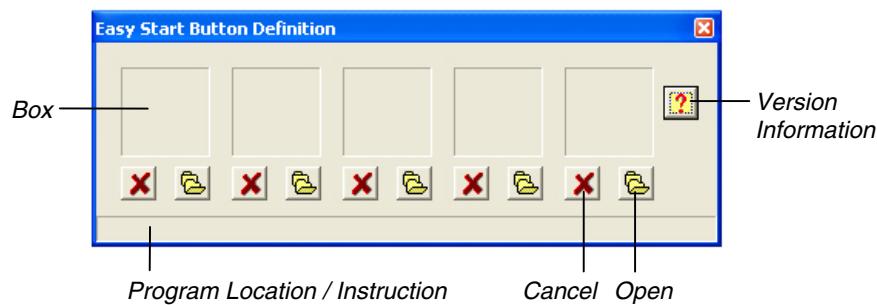

#### Defining the buttons:

The five boxes in the window represent the five user-definable buttons.

To assign a program to a button, you can drag and drop the program icon or shortcut icon from the Windows desktop to the corresponding box. Or you can click the Open  icon under the box to pop up the **Open** dialog box as shown next and select the desired program. Then, click **Open** to complete the process.

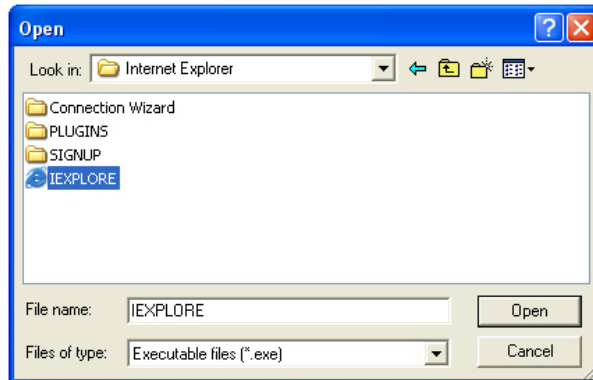

The appropriate icon will then appear in the box as shown next. To launch the program, you can simply press the corresponding Easy Start button, or, if the **Easy Start Button Definition** window is open, you can double-click the box containing the icon.



If you want to cancel the assignment of a program, click the Cancel  icon under the box.

## Wireless LAN Utility

Depending on your model, a Mini PCI card may be supplied with your computer.

Through the wireless LAN utility, the Mini PCI card allows you to wirelessly connect the Internet for the mobile data communication as an alternative for the wired network.

To use the wireless LAN utility, first make sure that the correct driver is installed.



## *Caring for the Computer*

Taking good care of your computer will ensure a trouble-free operation and reduce the risk of damage to your computer.

This chapter gives you guidelines covering these areas of maintenance:

- How to protect the computer
- What to note when using and storing the computer
- How to clean the computer
- What to note when using the battery pack
- What to note when traveling with the computer

## Protecting the Computer

To safeguard the integrity of your computer data as well as the computer itself, you can protect the computer in several ways as described in this section.

### Using the Password

The power-on password protects your computer against unauthorized use. If the password is set, the prompt requesting for the password appears on the screen whenever the computer is turned on.

The password is set via the BIOS setup program. See “Security Menu” in Chapter 5 for instructions.

### Using the Cable Lock

You can use a Kensington-type cable lock to protect your computer against theft. The cable lock is available in most computer stores.

To use the lock, loop the lock cable around a stationary object such as a table. Insert the lock to the Kensington lock hole and turn the key to secure the lock. Store the key in a safe place.

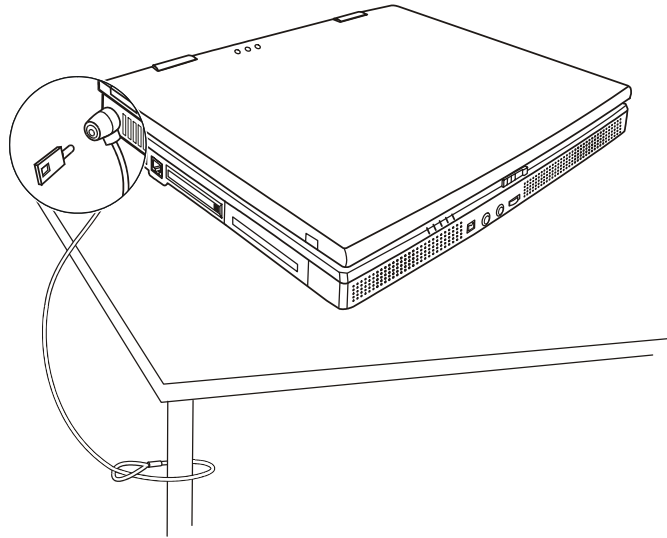

## Using an Anti-Virus Strategy

New viruses are always being developed nowadays and they are attacking computers even more easily with emails so commonly used worldwide.

The security feature of the BIOS protects the boot sector of the hard disk. To enable the function, see “Disk Menu” in Chapter 5 for instructions.

You can also install a virus-detecting program to monitor potential viruses that could damage your files.

# Taking Care of the Computer

## Location Guidelines

- Use the computer where the temperature is between 10°C (50°F) and 35°C (95°F).
- Avoid placing the computer in a location subject to high humidity, extreme temperatures, mechanical vibration, direct sunlight, or heavy dust.
- Do not cover or block any ventilation openings on the computer. For example, do not place the computer on a bed, sofa, rug, or other similar surface. Otherwise, overheating may occur that results in damage to the computer.
- Keep the computer at least 13 cm (5 inches) away from electrical appliances that can generate a strong magnetic field such as a TV, refrigerator, motor, or a large audio speaker.
- Do not move the computer abruptly from a cold to a warm place. A temperature difference of more than 10°C (18°F) will cause condensation inside the unit, which may damage the storage media.
- Do not place the computer on an unsteady surface.

## General Guidelines

- Do not place heavy objects on top of the computer when it is closed as this may damage the display.
- The screen surface is easily scratched. Do not use paper towels to clean the display. Avoid touching it with your fingers, pen, or pencil.
- To maximize the life of the backlight in the display, allow the backlight to automatically turn off as a result of power management. Avoid using a screen saver or other software that prevents the power management from working.

## Cleaning Guidelines

- Never clean the computer with its power on.
- Use a soft cloth moistened with water or a non-alkaline detergent to wipe the exterior of the computer.
- Gently wipe the display with a soft, lint-free cloth. Do not use alcohol or detergent on the display.
- Dust on the IR port can interfere with data transfer. Wipe the port with a soft, dry cloth.
- Dust or grease on the touchpad can affect its sensitivity. Clean the pad by using adhesive tape to remove the dust and grease on its surface.

## Battery Pack Guidelines

- Recharge the battery pack when it is nearly discharged. When recharging, make sure the battery pack is fully charged. Doing so may avoid harm to the battery pack.
- Operate the computer with the battery pack installed even when using external power. This ensures that the battery is fully charged.
- If you will not be using the computer for a long period of time (more than two weeks), remove the battery pack from the computer.
- If you remove the battery pack, make sure the battery terminals do not contact any conductors such as metal objects or water. Otherwise, the battery may become unusable as a result of a short circuit.
- If you need to store the battery pack, store it in a cool, dry place. Never allow the temperature to exceed 60°C (140°F).
- Do not leave the battery pack in storage for more than 6 months without recharging it.

## When Traveling

- Before traveling with your computer, make a backup of your hard disk data into floppy disks or other storage devices. As an added precaution, bring along an extra copy of your important data.
- Make sure the battery pack is fully charged.
- Make sure the computer is turned off and the top cover is securely closed.
- Do not leave objects in between the keyboard and closed display.
- Disconnect the AC adapter from the computer and take it with you. Use the AC adapter as the power source and as a battery-charger.
- Hand-carry the computer. Do not check it in as luggage.
- If you need to leave the computer in the car, put it in the trunk of the car to avoid exposing the computer to excessive heat.
- When going through airport security, it is recommended that you send the computer and floppy disks through the X-ray machine (the device you set your bags on). Avoid the magnetic detector (the device you walk through) or the magnetic wand (the hand-held device used by security personnel).
- If you plan to travel abroad with your computer, consult your dealer for the appropriate AC power cord for use in your country of destination.

# *Troubleshooting*

Computer problems can be caused by hardware, software, or both. When you encounter any problem, it might be a typical problem that can easily be solved.

This chapter tells you what actions to take when solving common computer problems. It is divided into three sections:

- Preliminary checklist
- Solving common problems
- Resetting the computer

## Preliminary Checklist

Here are helpful hints to follow before you take further actions when you encounter a problem:

- Try to isolate which part of the computer is causing the problem.
- Make sure that you turn on all peripheral devices before turning on the computer.
- If an external device has a problem, make sure that the cable connections are correct and secure.
- Make sure that the configuration information is properly set in the BIOS setup program.
- Make sure that all the device drivers are correctly installed.
- Make notes of your observations. Are there any messages on the screen? Do any indicators light? Do you hear any beeps? Detailed descriptions are useful to the service personnel when you need to consult one for assistance.

If any problem persists after you follow the instructions in this chapter, contact an authorized dealer for help.



## Solving Common Problems

For easy reference, the problems are divided into these categories.

<b>Problem Type</b>	<b>Go to</b>
Battery Problems	P. 8-4
CD Drive Problems	P. 8-4
Display Problems	P. 8-5
Floppy Disk Drive Problems	P. 8-7
Hardware Device Problems	P. 8-8
Hard Disk Drive Problems	P. 8-8
Infrared Problems	P. 8-9
Keyboard, Mouse, and Touchpad Problems	P. 8-9
LAN Problems	P. 8-10
Modem Problems	P. 8-10
PC Card Problems	P. 8-10
Power Management Problems (for Windows)	P. 8-11
Printer Problems	P. 8-12
Software Problems	P. 8-12
Sound Problems	P. 8-12
Startup Problems	P. 8-13
Other Problems	P. 8-14

## Battery Problems

**The battery does not charge (Battery Charge indicator does not light orange).**

- Make sure that the AC adapter is properly connected.
- Make sure that the battery is not too hot or cold. Allow time for the battery pack to return to room temperature.
- Make sure that the battery pack is installed correctly.
- Make sure that the battery terminals are clean.

**The operating time of a fully charged battery becomes shorter.**

- If you often partially recharge and discharge, the battery might not be charged to its full potential. Initialize the battery to solve the problem. (See “Initializing the Battery Pack” in Chapter 3 for instructions.)

**The battery operating time indicated by the battery meter does not match the actual operating time.**

- The actual operating time can be different from the estimated time, depending on how you are using the computer. If the actual operating time is much less than the estimated time, initialize the battery. (See “Initializing the Battery Pack” in Chapter 3 for instructions.)

## CD Drive Problems

**The CD drive cannot read a CD.**

- Make sure that the CD is correctly seated in the tray, with the label facing up.
- Make sure that the CD is not dirty. Clean the CD with a CD cleaning kit, available in most computer stores.
- Make sure that the CD drive driver is installed correctly.
- Make sure that the computer supports the CD or the files contained.

### **You cannot eject a CD.**

- The CD is not properly seated in the drive. Manually release the CD following the method described next:
  1. Turn off the system.
  2. Insert a small rod, such as a straightened paper clip, into the drive's manual eject hole and push firmly to release the tray.
  3. Pull the tray out until fully extended, and then remove the CD.

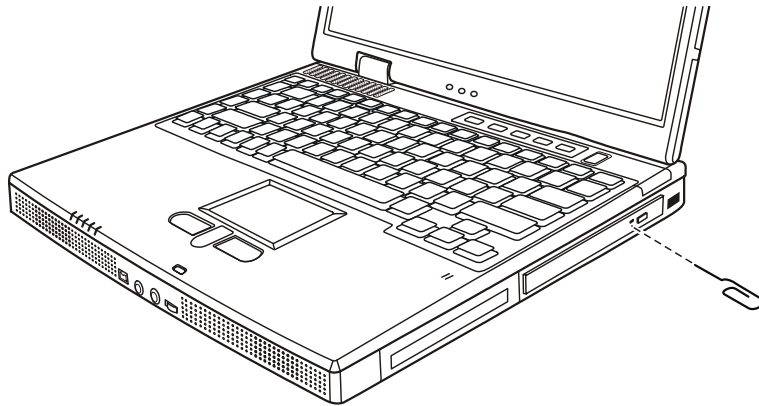

## Display Problems

### **Nothing appears on the screen.**

- During operation, the screen may automatically turn off as a result of power management. Press any key to see if the screen comes back.
- The brightness level might be too low. Increase brightness by pressing **Fn+F7**.
- The display output might be set to an external device. To switch the display back to the LCD, press **Fn+F5**, or change the display through the settings in **Display Properties**.

**The characters on the screen are dim.**

- Adjust the brightness and/or contrast.

**Bad dots appear on the display at all times.**

- A small number of missing, discolored, or bright dots on the screen are an intrinsic characteristic of TFT LCD technology. It is not regarded as a LCD defect.

**Term definition:**

*Bright dots* When the LCD screen is lighted, dots appear bright at a dark area. Red/green/blue bright dots also count.

*Dark dots* When the LCD screen is lighted, dots appear black at bright areas.

*Distance between defective dots* The minimum distance between two defective dots.

*Adjacent defective dots* Defective dots within a radius of 10 mm.

LCD Type	Defective dots		Distance between defective dots		Two adjacent defective dots		Three or more adjacent defective dots		Total
	Bright	Dark	Bright	Dark	Bright	Dark	Bright	Dark	
12.1" SVGA	N≤5	N≤5	≤15mm	≤15mm	≤2 Pairs	≤2 Pairs	Not allowed	Not allowed	N≤8
13.3" XGA	N≤5	N≤7	≤15mm	≤15mm	≤2 Pairs	≤2 Pairs	Not allowed	Not allowed	N≤9
14.1" XGA	N≤5	N≤7	≤15mm	≤15mm	≤2 Pairs	≤2 Pairs	Not allowed	Not allowed	N≤9
15" XGA	N≤8	N≤8	≤15mm	≤15mm	≤2 Pairs	≤2 Pairs	Not allowed	Not allowed	N≤10
18" XGA	N≤9	N≤15	≤5mm	≤20mm	≤3 Pairs	≤5 Pairs	Not allowed	Not allowed	N≤20

**Resolution cannot be adjusted to desired setting.**

- Make sure that the video driver is installed correctly.

**The external monitor displays nothing.**

- Make sure that the monitor is turned on.
- Make sure that the monitor's signal cable is properly connected.
- Switch the display to the monitor by pressing **Fn+F5**, or change the display through the settings in **Display Properties**.

### **The TV displays nothing.**

- Make sure that the TV is turned on and switched to the video mode.
- Make sure that the TV's signal cable is properly connected.
- Make sure that the **TV System** is set correctly in the BIOS SCU program.
- Switch the display to the TV by pressing **Fn+F5**, or change the display through the settings in **Display Properties**.

### **Simultaneous display does not work.**

- Make sure that you turn on the external monitor before turning on the computer.
- Press **Fn+F5** or change the display through the settings in **Display Properties** to toggle through the five display options.

## Floppy Disk Drive Problems

### **The disk drive does not work.**

- Make sure that the disk drive is properly connected.
- If you are using Windows 98, make sure that the disk drive driver is installed correctly.

### **The Floppy Disk Drive In-use Indicator stays on.**

- Make sure that the floppy disk is not physically damaged.
- Make sure that the floppy disk is inserted correctly.

### **The disk drive cannot write to a floppy disk.**

- Make sure that the floppy disk is formatted.
- Make sure that the floppy disk is not write-protected.
- Make sure that you are writing to the correct drive.
- Make sure that there is enough space left on the floppy disk.
- Make sure that the floppy disk is not physically damaged.

**The disk drive cannot read a floppy disk.**

- Make sure that the floppy disk is formatted.
- Make sure that you are reading the correct drive.

## Hardware Device Problems

**The computer does not recognize a newly installed device.**

- The device may not be correctly configured in the SCU program. Run the SCU program to identify the new type.
- Make sure if any device driver needs to be installed. (Refer to the documentation that came with the device.)
- Make sure if the device needs any jumper or switch settings. (Refer to the documentation that came with the device.)
- Check the cables or power cords for correct connections.
- For an external device that has its own power switch, make sure that the power is turned on.

## Hard Disk Drive Problems

**The computer cannot find the hard disk drive after it is turned on.**

- Make sure that the hard disk type is configured correctly in the SCU program.

**The hard disk drive error message appears on the screen.**

- The hard disk drive has defects. Ask your dealer for help.

**The hard disk drive operations seem slow.**

- The data files stored on the hard disk drive may be fragmented. Use a tool such as Window's **Disk Defragmenter** to defragment the files.

**The hard disk drive in-use indicator glows without blinking.**

- The data files stored on the hard disk drive may be fragmented. Use a tool such as Window's **Disk Defragmenter** to defragment the files.

## Infrared Problems

### **The IR port does not work.**

- Make sure that the IR ports of the two device face each other within a  $\pm 15$ -degrees angle and 1 meter (3 feet) distance and there are no obstructions in between.
- Make sure that the device connected is using an equivalent speed.
- Make sure that the IrDA Fast Infrared Port is set to HP HSDL-2300/3600.
- Make sure that the IR port configuration is set correctly in the SCU program.
- If you are printing to an infrared printer, make sure that the appropriate driver is installed.
- If you are using any file transfer functions, make sure that both the computer and the IR device have the appropriate software running.
- Make sure that there is no device radiating infrared rays, such as remote-controlled devices or wireless headphones, near the computer or device.
- Make sure that no direct sunlight or fluorescent lamps are near the computer or device.
- Make sure that the IR ports are clean.

## Keyboard, Mouse, and Touchpad Problems

### **The keyboard does not respond.**

- Try connecting an external keyboard. If it works, contact an authorized dealer, as the internal keyboard cable might be loose.

### **The numeric keypad is disabled.**

- Make sure that the **Num Lock** is switched on. (Check if the Num Lock Indicator  lights green or not.)

**The external keyboard does not work.**

- Make sure that the keyboard cable is properly connected.

**The touchpad does not work, or the pointer is difficult to control with the touchpad.**

- Make sure that the touchpad is clean.

## LAN Problems

**I cannot access the network.**

- Make sure that the LAN driver is correctly installed.
- Make sure that the LAN cable is properly connected to the RJ-45 connector and the network hub.
- Make sure that the network configuration is appropriate.
- Make sure that the user name or password is correct.

## Modem Problems

**The modem does not work.**

- Make sure that the modem driver is correctly installed.
- Make sure that the telephone line is properly connected.
- Make sure that the COM port in the communication software is correctly set.
- Turn off power management.

## PC Card Problems

**The PC Card does not work.**

- Make sure that the PC Card is correctly seated.



- If the card requires an IRQ (interrupt request), make sure that there is one available.

**The PC Card stops communicating properly.**

- The application may have been reset when the computer is turned off or in Standby mode. Exit and restart the application.

## Power Management Problems (for Windows)

**The computer does not enter Standby or Hibernation mode automatically.**

- If you have a connection to another computer, the computer does not enter Standby or Hibernation mode if the connection is actively in use.
- Make sure that the Standby or Hibernation time-out is enabled.

**The computer does not enter Standby or Hibernation mode immediately.**

- If the computer is performing an operation, it normally waits for the operation to finish.

**The computer does not resume from Standby or Hibernation mode.**

- The computer automatically enters Standby or Hibernation mode when the battery pack is empty. Do any one of the following:
  - Connect the AC adapter to the computer.
  - Replace the empty battery pack with a fully charged one.

**The computer does not enter Hibernation mode with the Fn+F12 hot keys.**

- Make sure that the Hibernation function is specified for the sleep button.
- If you are using Windows 98, make sure that the hibernation partition or file exists.
- You might be using a PC Card that prevents the computer from entering Hibernation mode. To enter the mode, stop the communication program and then remove the card or stop the card.

## Printer Problems

### **The printer does not work.**

- Make sure that the printer is turned on (if it comes with an independent power source) and is online (ready to use).
- Make sure that the printer's signal cable is properly connected.
- Make sure that the printer driver is correctly installed.
- Make sure that you have assigned the printer port correctly in your operating system or application program.
- Make sure that the printer port is enabled in the SCU program.

### **The printer prints garbled information.**

- Make sure that the printer driver is correctly installed.
- Make sure that the printer cable is properly connected.

## Software Problems

### **An application program does not work correctly.**

- Make sure that the software is correctly installed.
- If an error message appears on the screen, consult the software program's documentation for further information.
- If you are sure the operation has stopped, reset the computer. (See "Resetting the Computer" in this chapter.)

## Sound Problems

### **No sound is produced.**

- Make sure that the volume control is not set too low.
- Make sure that the audio driver is correctly installed.
- Make sure that the computer is not in Standby mode.

- If using an external speaker, make sure that the speaker is properly connected.

**Distorted sound is produced.**

- Make sure that the volume control is not set too high or too low. In most cases, a high setting can cause the audio electronics to distort the sound.

**The sound system does not record.**

- Adjust the playback or recording sound levels.

**The external microphone or audio device does not work.**

- Make sure that the microphone is connected to the proper connector on the computer.
- Make sure that your computer is equipped with the driver needed.
- Click the speaker symbol on the taskbar and check the Windows volume control.
- Check the volume control of your computer.

## Startup Problems

**When you turn on the computer, it does not respond and the Power Indicator does not light green.**

- If you are using an external AC power, make sure that the AC adapter is correctly and securely connected. If so, make sure that the electrical outlet works properly.
- If you are using the battery power, make sure that the battery is not discharged.

**When you turn on the computer, it stops after POST.**

- Restart your computer.

**The message “Operating system not found” appears on the screen after you turn on the computer.**

- Make sure that there is no floppy disk in the floppy disk drive. If there is, remove it and restart the system.
- If this message appears when you are booting from the hard disk, insert a bootable disk in the floppy disk drive and check the condition of the hard disk.
- Make sure that the hard disk is set correctly in the SCU program.

**The message “Invalid system disk” or “Disk error” appears on the screen after you turn on the computer.**

- If you are deliberately trying to boot from a floppy disk, replace the disk with a bootable one and press any key to continue booting.
- If you are booting from the hard disk, make sure that there is no floppy disk in the floppy disk drive. If there is, remove it and restart the system.
- If this message appears when you are booting from the hard disk, insert a bootable disk in the floppy disk drive and check the condition of the hard disk.
- Make sure that the hard disk is set correctly in the SCU program.

## Other Problems

**The date/time is incorrect.**

- Correct the date and time via the operating system or SCU program.
- After you have performed everything as described above and still have the incorrect date and time every time you turn on the computer, the RTC (Real-Time Clock) battery is at the end of its life. Call an authorized dealer to replace the RTC battery.

## Resetting the Computer

You may have to reset (reboot) your computer on some occasions when an error occurs and the program you are using hangs up.

If the system operation seems to hang up, first wait. It is possible that the system is processing data. Periodically check the hard disk drive in-use indicator, if it flashes irregularly, the program may be accessing data and preventing you from using the keyboard. If you are sure the operation has stopped and you cannot use the “restart” function of the operating system, reset the computer.

Reset the computer by any one of these methods:

- Press **Ctrl+Alt+Del**.
- If the above action does not work, turn off the system. Wait for at least five seconds and turn it on again.

**| CAUTION:** Resetting will cause any unsaved data to be lost.



# Specifications

**NOTE:** Specifications are subject to change without any prior notice.

Parts		Specifications
CPU		Mobile/Desktop Intel Pentium 4 Processor and Celeron Processor, mPGA 478 socket
Cache Memory		256/512 KB on-die (integrated with CPU)
ROM BIOS		256 KB Flash EEPROM
RAM	System	2 x 200 pin DDR-SODIMM socket for expansion, support PC1600/PC2100 DDR module, up to 1024 MB
	Video	8/16/32/64 MB (shared from system memory, 32MB by default)
Display	Panel	14.1/15-inch TFT XGA LCD, resolution up to 1024×768
	Video controller	Integrated in SiS650, Ultra AGP
	Video ports	VGA port, S-video connector
Keyboard		Standard keys, numeric keypad, 12 function keys, a special Fn (Function) key and Windows keys
Pointing device		PS/2-compatible touchpad with 2 buttons and scroll button
Storage device	Floppy disk drive (external)	3.5-inch, 1.44 MB, USB (optional)
	Hard disk drive	2.5-inch, 9.5mm high, IDE, Ultra DMA 33/66/100 supported
	CD/DVD/CD-RW/Combo drive	24X CD-ROM 8X DVD-ROM (optional) 8X8X24X CD-RW (optional) 8X8X8X24X Combo (optional)
Audio	Audio controller	ALC201, AC'97
	Audio port	Two audio ports for Mic-in / Line-out
PC Card		Type II x 1, PCMCIA 2.1 compliant, CardBus support
I/O ports		ECP/EPP parallel port, four USB ports, FIR/SIR port, IEEE 1394 port
Modem		56 Kbps V.90 MDC internal Fax Modem
LAN		Fast Ethernet, 10/100 Mbps auto-negotiation

Wireless LAN		Mini PCI (optional)
Power	AC adapter	Universal AC adapter 90W; input: 100~240V, 50/60Hz AC
	Battery	9-cell 2000mAh Li-ION battery
Dimension (WxDxH)		12.9x10.8x1.5/1.8 inch (328x274x37/46 mm)
Weight		7.5 lb (3.4 kg)
Environment	Temperature	Operating: 10°C (50°F) to 35°C (95°F) Storage: 0°C (32°F) to 60°C (140°F)
	Humidity	Operating: 10% to 90% non-condensing Storage: 5% to 90% non-condensing

**RF Exposure Information :**

In order to comply with FCC RF Exposure requirements, it is recommended when using this notebook with Wireless LAN functions, maintain a separation distance of more than 2.5 centimeters from your body or nearby persons during extended periods of operation. If the notebook is positioned less than 2.5 centimeters from the user, it is recommended that the user limit exposure time.



# Index

## A

- AC, 3-2
- AC adapter, 3-2, A-2
  - Connecting, 1-2
- AC power
  - Connecting, 1-2
- ACPI, 3-7
- Alt key, 2-4
- Anti-Virus, 7-3
- APM, 3-7
- ASK, 4-7
- Audio driver, 6-3
- Audio output connector, 1-9, 2-22
- Audio subsystem, A-1
  - Connecting external audio devices, 2-22
  - Driver installation, 6-3
  - Feature, 2-21
  - Troubleshooting, 8-13

## B

- Backspace key, 2-4
- Battery Low, 3-5
- Battery pack, 1-6, 3-3, A-2
  - Battery Low, 3-5
  - Charging, 3-3
  - Checking the battery level, 3-4
  - Initializing, 3-4
  - Replacing, 3-4
  - Taking care, 7-5
  - Troubleshooting, 8-4
- BIOS, 5-1
- BIOS SETUP, 5-1

- Booting, 2-2
- Brightness, 2-8

## C

- Cache, A-1
- Caps Lock, 2-5
  - Indicator, 1-9
- CardBus, 4-10
- CD. *See* CD drive
- CD drive, 1-6, 2-17, A-1
  - Inserting a CD, 2-18
  - In-use indicator, 1-9
  - Troubleshooting, 8-4
- CD-ROM drive. *See* CD drive
- CD-RW drive. *See* CD drive
- Charging, 3-3
- Cleaning the computer, 7-5
- Click, 2-11
- COM port
  - Mode setting, 5-7
  - Setting, 5-7
- Connecting external devices
  - IEEE 1394 device, 4-9
  - IR device, 4-7
  - Monitor, 4-2
  - Parallel device, 4-5
  - TV, 4-3
  - USB device, 4-6
- Cover
  - Opening, 1-3
- CPU, A-1
- CRT monitor. *See* Monitor
- Ctrl key, 2-4
- Cursor, 2-5

Cursor-control key, 2-5

## D

Date, 5-5, 8-14

DC, 3-2

Dimension of the computer, A-2

Display mode, 2-19

Double-click, 2-11

Drag and drop, 2-11

Drive A, 2-14

Drive C, 2-16

Drive D, 2-17

Driver installation, 6-1

DVD-ROM drive. *See* CD drive

## E

Easy Start button, 1-11, 2-13

    Defining the button, 6-4

Easy Start button driver

    Driver installation, 6-3

ECP, 4-5

EEPROM, A-1

Environmental specifications, A-2

EPP, 4-5

ESB. *See* Easy Start button

Esc key, 2-4

Euro symbol, 2-7

## F

FIR, 4-7

Floppy disk drive, 2-14, A-1

    Connecting, 2-14

    Ejecting floppy disks, 2-15

    Inserting floppy disks, 2-15

    Troubleshooting, 8-7

Fn key, 2-8

Function key, 2-8

## H

Hard disk drive, 1-7, 2-16, A-1

In-use indicator, 1-9

    Troubleshooting, 8-8

Hibernation, 2-3, 3-7, 3-8

    Troubleshooting, 8-11

Hot keys, 2-8

Humidity, A-2

## I

IEEE 1394 device

    Connecting, 4-9

IEEE 1394 port, 1-9

Indicator

    Caps Lock, 1-9

    CD/DVD/CD-RW/Combo drive, 1-9

    Hard disk drive, 1-9

    Num Lock, 1-9

    Scroll Lock, 1-9

IR device

    Connecting, 4-7

IR port, 1-6

    Troubleshooting, 8-9

IrDA. *See* IR port

## K

Kensington lock, 1-7, 7-2

Keyboard, 1-10, 2-4, A-1

    Troubleshooting, 8-9

## L

LAN, 2-24, A-1

    Connector, 1-7

    Driver installation, 6-3

    Troubleshooting, 8-10

LAN driver, 6-3

LCD, 1-10, 2-19, A-1

    Switching on and off with hot keys, 2-9

    Troubleshooting, 8-5

Line-out. *See* Audio output connector

Location of the computer, 7-4

Low battery. *See* Battery Low

## M

- Microphone, 1-10, 2-21
- Microphone connector, 1-9, 2-22
- Modem, 2-23, A-1
  - Driver installation, 6-3
  - Troubleshooting, 8-10
- Modem driver, 6-3
- Monitor
  - Connecting, 4-2
- Mouse
  - Troubleshooting, 8-9

## N

- Network. *See* LAN
- Num Lock, 2-4
  - Indicator, 1-9
- Numeric key, 2-6

## O

- Operating system, 1-5, 2-2

## P

- Parallel device
  - Connecting, 4-5
- Parallel port, 1-8, 4-5
  - Mode setting, 5-7
  - Setting, 5-7
- Pause key, 2-5
- PC Card, 4-10, A-1
  - Inserting, 4-10
  - Removing, 4-11
  - Slot, 1-7
  - Troubleshooting, 8-11
- PCMCIA, 4-10
- Point, 2-11
- Pointing device, A-1
- POST, 1-5
- Power, A-2
- Power button, 1-10, 2-2
- Power connector, 1-8

- Power Management, 3-7
  - Troubleshooting, 8-11
- Power-On Self Test. *See* POST
- Print Screen key, 2-5
- Printer
  - Troubleshooting, 8-12

## R

- RAM, A-1
- Rebooting, 8-15
- Resetting, 8-15
- Restarting, 8-15
- RJ-11, 1-8, 2-23
- RJ-45, 1-7, 2-24
- ROM BIOS, A-1

## S

- Saving power, 3-9
- Screen. *See* LCD
- Scroll, 2-11
- Scroll button, 1-10
- Scroll Lock, 2-5
  - Indicator, 1-9
- Security
  - BIOS setting, 5-9
  - Protecting the computer with lock, 7-2
  - Protecting the computer with password, 7-2
- Shift key, 2-4
- Shutting down, 1-5, 2-2
- Simultaneous display, 2-19
- SIR, 4-7
- Sleep button, 2-9
- Software
  - Troubleshooting, 8-12
- Software driver, 6-1
- Speaker, 1-9, 2-21
  - Connecting external speakers, 2-22
- Specifications, A-1
- Standby, 2-2, 3-7
  - Troubleshooting, 8-11
- Startup, 2-2
  - Troubleshooting, 8-13
- S-video connector, 1-8

## T

- Telephone line
  - Connecting, 2-23
  - Connector, 1-8
- Temperature, A-2
- TFT, 2-19
- Time, 5-5, 8-14
- Touchpad, 1-10, 2-10, A-1
  - Configuring, 2-12
  - Driver installation, 6-3
  - Troubleshooting, 8-9
- Touchpad driver, 6-3
- Traveling with the computer, 7-6
- Troubleshooting, 8-1
  - Battery problem, 8-4
  - CD drive problem, 8-4
  - Display problem, 8-5
  - Floppy disk drive problem, 8-7
  - Hard disk drive problem, 8-8
  - Hardware problem, 8-8
  - Infrared problem, 8-9
  - Keyboard problem, 8-9
  - LAN problem, 8-10
  - Modem problem, 8-10
  - Mouse problem, 8-9
  - Other problem, 8-14
  - PC Card problem, 8-11
  - Power Management problem, 8-11
  - Printer problem, 8-12
  - Software problem, 8-12
  - Sound problem, 8-13
  - Startup problem, 8-13
  - Touchpad problem, 8-9
- Turning off, 1-5, 2-2

- Turning on, 1-4
- TV
  - Connecting, 4-3
- TV BIOS, 5-6
- Typewriter key, 2-4

## U

- Upgrading the computer, 4-12
- USB device
  - Connecting, 4-6
- USB port, 1-8, 4-6

## V

- VGA port, 1-8
- Video driver, 6-3
- Video subsystem
  - Configuring, 2-19
  - Driver installation, 6-3
  - Feature, 2-19
  - Video controller, A-1
  - Video RAM, A-1
- Virus, 7-3
- Volume control, 1-9, 2-21

## W

- Weight of the computer, A-2
- Windows, 1-5
- Windows key, 2-7