



Copyright

Copyright and Trademark Information

Fujitsu Computer Systems Corporation has made every effort to ensure the accuracy and completeness of this document. However, as ongoing development efforts are continually improving the capabilities of our products, we cannot guarantee the accuracy of the contents of this document. We disclaim liability for errors, omissions, or future changes. The absence of a product or service name, slogan, or logo does not constitute a waiver of any trademark or other intellectual property rights relating to that name, slogan, or logo owned by Fujitsu Computer Systems Corporation, its parent, subsidiaries, and affiliated companies.

Fujitsu, the Fujitsu logo, and LifeBook are registered trademarks of Fujitsu Limited.

Intel and Pentium are registered trademarks and Centrino is a trademark of Intel Corporation or its subsidiaries in the United States and other countries.

IBM, IBM PC AT, and IBM PS/2 are registered trademarks of IBM Corporation in the United States, other countries, or both.

MS, MS-DOS, and Windows are either registered trademarks or trademarks of Microsoft Corporation in the United States and/or other countries.

PCMCIA is a trademark of the Personal Computer Memory Card International Association.

Memory Stick and Memory Stick Duo are trademarks of Sony, its parent, and/or its affiliates.

Adobe, Acrobat, and Acrobat Reader are either registered trademarks or trademarks of Adobe Systems, Incorporated in the United States and/or other countries.

Dolby Headphone manufactured under license from Dolby Laboratories. Dolby, Pro Logic, and the double-D symbol are trademarks of Dolby Laboratories.

Quicken is a registered trademark and/or registered service mark of Intuit, Inc. or one of its subsidiaries in the United States and other countries.

InterVideo and WinDVD are registered trademarks of InterVideo, Inc.

Realtek is a registered trademark of Realtek Semiconductor Corporation.

Norton AntiVirus is a registered trademark of Symantec Corporation in the United States and other countries.

This product incorporates copyright protection technology that is protected by method claims of certain U.S. patents and other intellectual property rights owned by Macrovision Corporation and other rights owners. Use of this copyright protection technology must be authorized by Macrovision Corporation, and is intended for home and other limited viewing uses only unless otherwise authorized by Macrovision Corporation. Reverse engineering or disassembly is prohibited.

All other trademarks mentioned herein are the property of their respective owners.

Warning



Handling the cord on this product will expose you to lead, a chemical known to the State of California to cause birth defects or other reproductive harm.

Wash hands after handling.

© Copyright 2004 Fujitsu Computer Systems Corporation. All rights reserved. No part of this publication may be copied, reproduced, translated, stored, or transmitted in any electronic form without the written consent of Fujitsu Computer Systems Corporation.

B6FH-4971-01EN-00



DECLARATION OF CONFORMITY

according to FCC Part 15

Responsible Party Name:	Fujitsu Computer Systems Corporation
Address:	1250 E. Arques Avenue Sunnyvale, CA 94085
Telephone:	(408) 746-6000
Declares that product:	Base Model Configurations: LifeBook P1510 notebook LifeBook P1510D notebook Complies with Part 15 of the FCC Rules.

This device complies with Part 15 of the FCC rules. Operations are subject to the following two conditions: (1) This device must not be allowed to cause harmful interference, (2) This device must accept any interference received, including interference that may cause undesired operation.



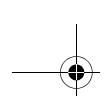

UL Notice

This unit requires an AC adapter to operate. Use only UL Listed Class 2 Adapters with an output rating of 16 VDC, with a current of 3.75A minimum.

AC Adapter output polarity:



- When using your notebook equipment, basic safety precautions should always be followed to reduce the risk of fire, electric shock and injury to persons, including the following:
 - Do not use this product near water for example, near a bathtub, washbowl, kitchen sink or laundry tub, in a wet basement or near a swimming pool.
 - Avoid using the modem during an electrical storm. There may be a remote risk of electric shock from lightning.
 - Do not use the modem to report a gas leak in the vicinity of the leak.
 - Use only the power cord and batteries indicated in this manual. Do not dispose of batteries in a fire. They may explode. Check with local codes for possible special disposal instructions.
- To reduce the risk of fire, use only No. 26 AWG or larger UL Listed or CSA Certified Telecommunication Line Cord

SAVE THESE INSTRUCTIONS

For Authorized Repair Technicians Only



- For continued protection against risk of fire, replace only with the same type and rating fuse.
- Danger of explosion if Lithium (clock) battery is incorrectly replaced. Replace only with the same or equivalent type recommended by the manufacturer. Dispose of used batteries according to the manufacturer's instruction.

System Disposal



LAMP(S) INSIDE THIS PRODUCT CONTAIN MERCURY AND MUST BE RECYCLED OR DISPOSED OF ACCORDING TO LOCAL, STATE, OR FEDERAL LAWS.

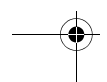
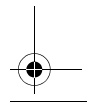
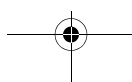
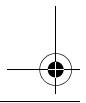
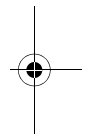
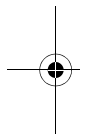

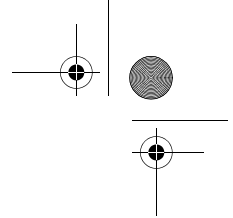

Fujitsu LifeBook® P7000 Notebook Table of Contents

1

PREFACE

Preface

About This Guide	1
Fujitsu Contact Information	1
Warranty	1

2

GETTING TO KNOW YOUR LIFEBOOK NOTEBOOK

Overview

Unpacking	5
---------------------	---

Locating the Controls/Connectors

Top and Front Components	6
Left-Side Panel Components	8
Right-Side Panel Components	9
Rear Panel Components	10
Bottom Components	11

Status Indicator Panel

Battery Charging Indicators	12
Battery Level Indicators	12
Hard Disk/CD Access Indicator	12

Keyboard

Using the Keyboard	13
Key Indicator Lights	13
Numeric Keypad	13
Windows Keys	13
Cursor Keys	14
Function Keys	14

Touchpad Pointing Device

Clicking	15
Double-Clicking	15
Dragging	16
Scrolling	16
Touchpad Control Adjustment	16

Volume Control

Controlling the Volume	17
----------------------------------	----

Flexible Bay Devices

Removing and Installing Modular Devices	18
---	----

3

GETTING STARTED WITH YOUR LIFEBOOK NOTEBOOK

Power Sources

Connecting the Power Adapters	23
---	----

Display Panel

Opening the Display Panel	24
Adjusting Display Panel Brightness	24
Closing the Display Panel	24

Starting Your LifeBook Notebook

Power On	25
Boot Sequence	25
BIOS Setup Utility	25
Booting the System	26
Registering Your LifeBook notebook	26
Installing Click Me!	26

Power Management

Suspend/Resume/Power On Button	27
Suspend Mode	27
Hibernation Feature	27
Display Timeout	28

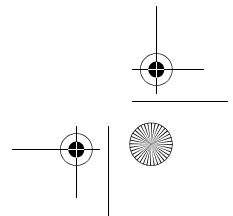
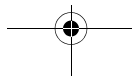
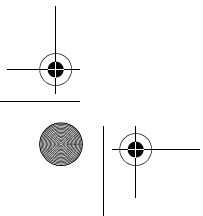
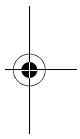
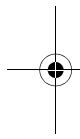

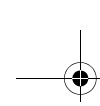

Hard Disk Timeout	28
Windows Power Management	28
Restarting the System	28
Power Off	28

4

USER-INSTALLABLE FEATURES

Lithium ion Battery

Recharging the Batteries	31
Replacing the Battery	32

External Floppy Disk Drive

Loading a Disk	33
Ejecting a Disk	33
Preparing a Disk for Use	33

Optical Drive

Media Player Software	34
Loading a DVD or CD	34
Removing Media	35
Using the Optical Drive Software	35
Using Dolby™ Headphone	35
Using the Optical Drive on Battery Power	36
Auto Insert Notification Function	36
Emergency Tray Release	36

PC Cards

Installing PC Cards	37
Removing PC Cards	37

Compact Flash Cards

Installing CF Cards	38
Removing CF Cards	39

Memory Stick/Secure Digital Slot

Installing Memory Stick/SD Cards	40
Removing A Memory Stick/SD Card	41

Memory Upgrade Module

Accessing the Memory Compartment	42
Removing a Memory Module	42
Installing a Memory Module	42
Checking the Memory Capacity	43

Device Ports

Modem (RJ-11) Telephone Port	44
Internal LAN (RJ-45) Port	44
IEEE 1394 Port	45
S-Video Out Port (TV Out)	45
Universal Serial Bus Ports	45
Headphone Jack	45
Optical Digital Audio Connector	46
Microphone Jack	46
External Monitor Port	46

5

WIRELESS LAN USER'S GUIDE

Before Using the Wireless LAN

Wireless LAN Modes Using this Device	50
Wireless Network Considerations	51
Deactivating the WLAN Device	51
Activating the WLAN Device	52

Configuration of the WLAN Device

Flow of Operations	53
Configuration Using Intel PROSet Software	53
Configuration Using Atheros Client Utility Software	54
Connection to the network	55

Troubleshooting the WLAN

Troubleshooting	60
---------------------------	----

Wireless LAN Glossary

Glossary	61
--------------------	----

IP address information

About IP Addresses	63
------------------------------	----

WLAN Specifications

Specification	63
-------------------------	----

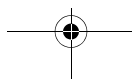
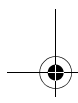
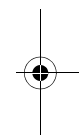
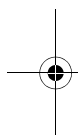

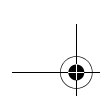

Table of Contents

6

TROUBLESHOOTING

Troubleshooting

Identifying the Problem	67
Specific Problems	67
Troubleshooting Table	68
Power On Self Test Messages	75
Emergency DVD Tray Release	76
Modem Result Codes	76

Restoring Pre-installed Software

Restoring the Factory Image	77
Automatically Downloading Driver Updates	78

7

CARING FOR YOUR LIFEBOOK NOTEBOOK

Care and Maintenance

Batteries	82
Floppy Disks and Drives	82
Media Care	83
PC Cards	83

8

SYSTEM SPECIFICATIONS

Specifications

Configuration Label	87
Microprocessor	87
Memory	87
Video	87
Audio	87
Mass Storage Device Options	87
Features	87
Device Ports	88
Keyboard	88
Power	88

Dimensions and Weight	88
Environmental Requirements	88
Popular Accessories	88
Pre-Installed Software	89
Learning About Your Application Software	89
Regulatory Information	91
Notice	91

9

GLOSSARY

Glossary	95
--------------------	----

APPENDIX A: USING THE FINGERPRINT SENSOR DEVICE

Fingerprint Sensor Device

Introducing the Optional Fingerprint Sensor Device	101
Getting Started	101
Installing OmniPass	101
User Enrollment	102
Using OmniPass	103
Configuring OmniPass	105
OmniPass Control Center	106
Troubleshooting	107

INDEX

Index	109
-----------------	-----

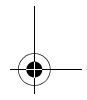
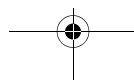
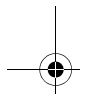
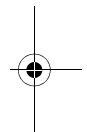
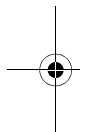

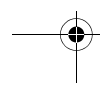
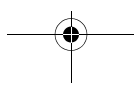
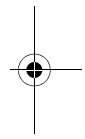
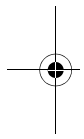
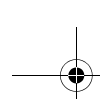

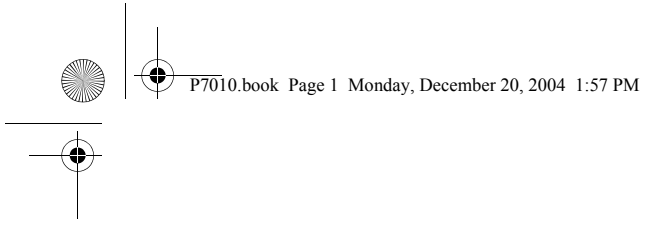

1 Preface

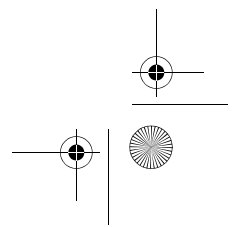
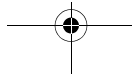
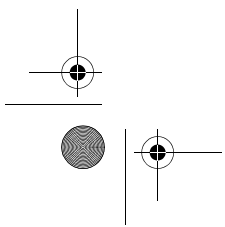
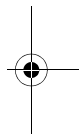
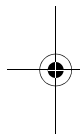

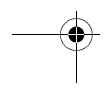
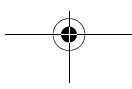
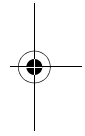
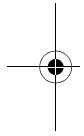
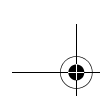

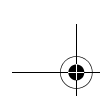

Preface

ABOUT THIS GUIDE

The LifeBook P7000/P7000D Series notebook from Fujitsu Computer Systems Corporation is a small but powerful computer. It is powered by an Intel Pentium M processor Ultra-low Voltage (ULV) or an Intel Celeron 852 GML processor, has a built-in wide-aspect Crystal View color display, and brings the functionality of desktop personal computers (PCs) to a portable environment.

This manual explains how to operate your LifeBook notebook's hardware and built-in system software.

It comes with Microsoft Windows® XP Home or Window XP Pro pre-installed.

Conventions Used in the Guide

Keyboard keys and on-screen buttons appear in brackets. Example: [Fn], [F1], [ESC], and [CTRL].

Pages with additional information about a specific topic are cross-referenced within the text.

Example: (See page xx.)

DOS commands you enter appear in Courier type. Example: Shutdown the computer?



The information icon highlights information that will enhance your understanding of the subject material.



The caution icon highlights information that is important to the safe operation of your computer, or to the integrity of your files. Please read all caution information carefully.



The warning icon highlights information that can be hazardous to either you, your LifeBook notebook, or your files. Please read all warning information carefully.

FUJITSU CONTACT INFORMATION

Service and Support

You can contact Fujitsu Service and Support in the following ways:

- Toll free: 1-800-8Fujitsu (1-800-838-5487)
- Fax: (408) 764-2724
- E-mail: 8fujitsu@us.fujitsu.com
- Web site:
http://www.computers.us.fujitsu.com/support

Before you place the call, you should have the following information ready so that the customer support representative can provide you with the fastest possible solution:

- Product name
- Product configuration number
- Product serial number
- Purchase date
- Conditions under which the problem occurred
- Any error messages that have occurred
- Type of device connected, if any

Fujitsu Online

You can go directly to the online Fujitsu Product catalog for your LifeBook notebook by clicking on the Fujitsu Weblinks -> LifeBook Accessories Web site URL link, located in the Windows Start menu.

You can also reach Fujitsu Service and Support online by clicking on the Fujitsu Weblinks -> Service and Support Web site URL link, located in the Windows Start menu.



You must have an active internet connection to use the online URL links.

WARRANTY

Your LifeBook notebook is backed by an International Limited Warranty. Check the service kit that came with your notebook for warranty terms and conditions.

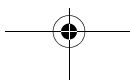

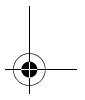
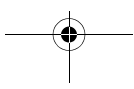
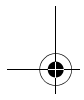
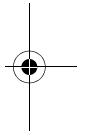
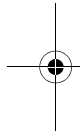
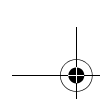

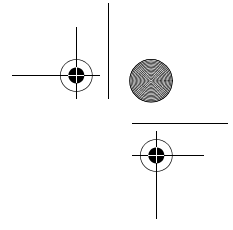
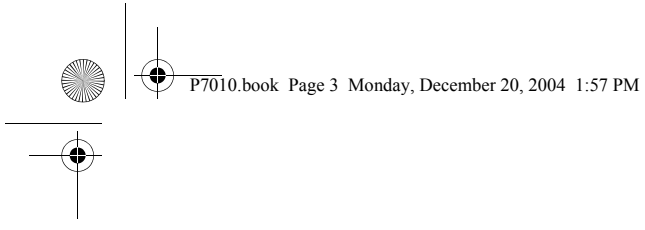

2

Getting to Know Your LifeBook Notebook

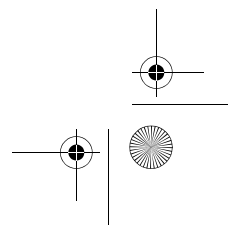
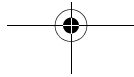
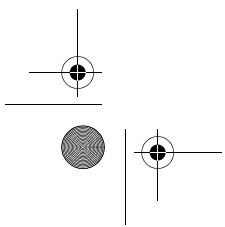
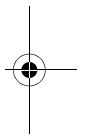
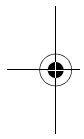

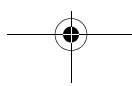
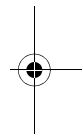
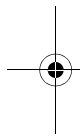
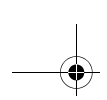

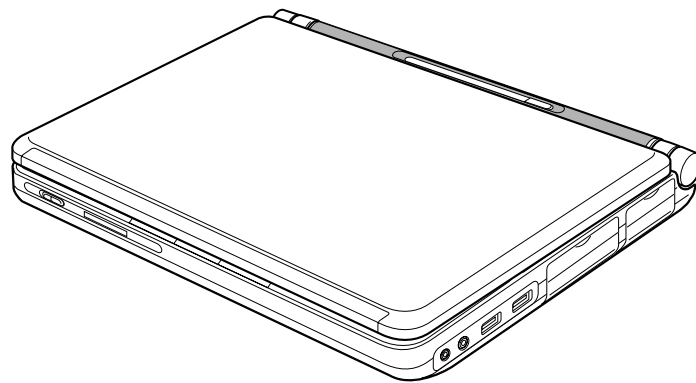

Figure 2-1 Fujitsu LifeBook P7000 notebook

Overview

This section describes the components of your Fujitsu LifeBook P7000 notebook. We strongly recommend that you read it before using your notebook – even if you are already familiar with notebook computers.

UNPACKING

When you receive your LifeBook notebook, unpack it carefully, and compare the parts you have received with the items listed below.

- LifeBook P7000/P7000D notebook (Figure 2-1)
- AC adapter with AC power cord (Figure 2-2)
- Lithium ion battery
- Weight Saver
- Phone/Modem (RJ-11) telephone cable
- Driver and Application Restore CD
- Getting Started Guide
- User's Guide (this document)
- International Limited Warranty Brochure
- Certification of Authenticity

Depending upon the configuration of your system, one or more of the following items may also be included:

- Modular DVD/CD-RW Combo Drive
- Modular Multi-Format DVD Writer
- External Floppy Disk Drive
- Modular 2nd battery
- Additional main high capacity battery
- RecordNow CD (included with Combo drive)
- RecordNow and WinDVD Creator CD (included with Multi-Format DVD Writer)

Once you have checked and confirmed that your LifeBook system is complete, read through the following pages to learn about all of your notebook's components.

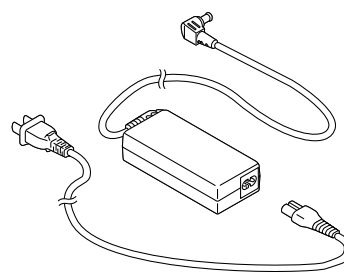
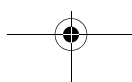
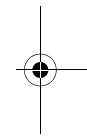
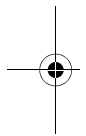

Figure 2-2 AC Adapter



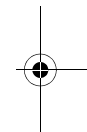
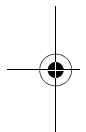
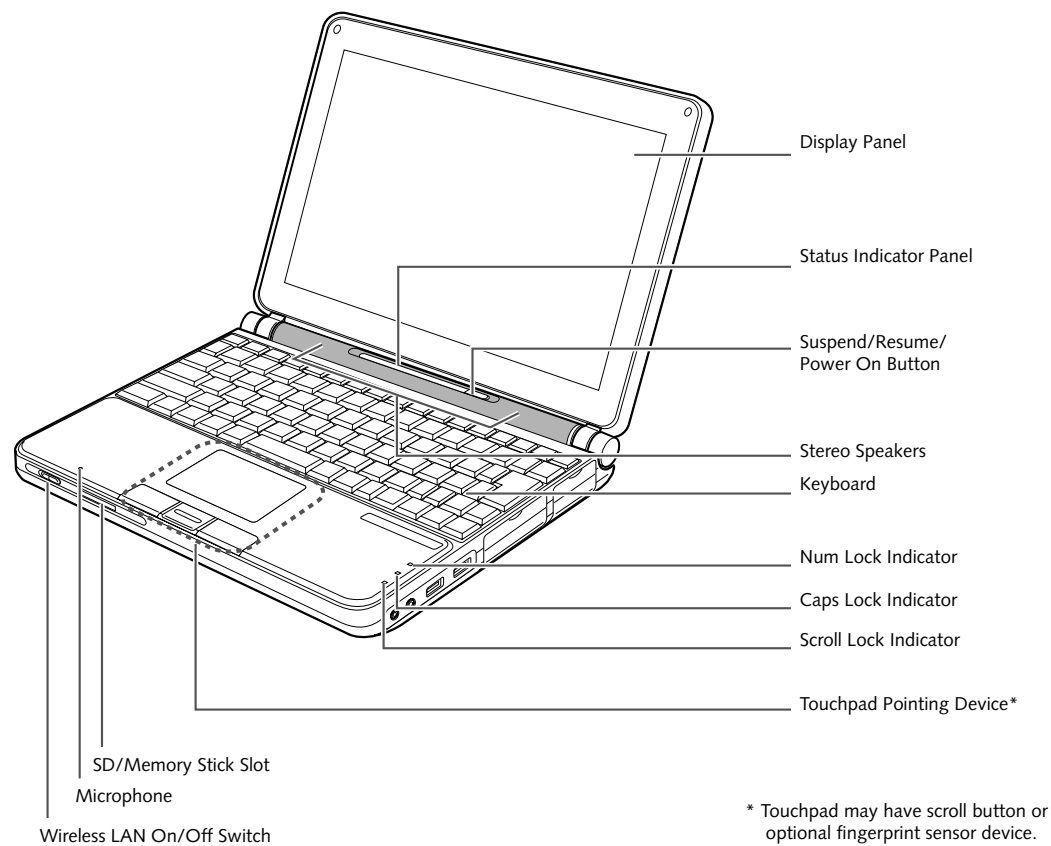
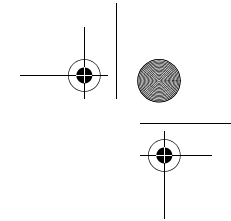

Figure 2-3 LifeBook notebook with display open

Locating the Controls and Connectors

TOP AND FRONT COMPONENTS

The following is a brief description of your LifeBook notebook's top and front components.

Wireless LAN On/Off Switch

Allows you to turn the optional Wireless LAN device on and off. Note that this switch is present on all models of the LifeBook P7000 notebook, but it is functional only on those with an optional Wireless LAN installed.

Built-in Microphone

The built-in microphone allows you to input or record mono audio.

SD/Memory Stick Slot

The Secure Digital (SD)/Memory Stick slot allows you to install a flash memory card for data storage. This architecture allows you to transfer data between a variety of different digital devices. (See *Installing Memory Stick/SD Cards* on page 40 for more information)

Touchpad Pointing Device/Scroll Button

The Touchpad pointing device is a mouse-like cursor control with three buttons (left, right, and scroll* button). (See *Touchpad Pointing Device* on page 15 for more information).

* Certain configurations of this system have an optional fingerprint sensor located in place of the scroll button. If you have a system with the optional fingerprint sensor, refer to (*See Fingerprint Sensor Device* on page 101 for more information)

Num Lock/Scroll Lock/Caps Lock Indicator

These indicators light up when the num lock, scroll lock, or caps lock buttons have been turned on. (See *Using the Keyboard* on page 13 for more information).

Keyboard

A full-size keyboard with dedicated Windows keys. (See *Keyboard* on page 13 for more information)

Stereo Speakers

The built-in dual box speakers allow for stereo sound.

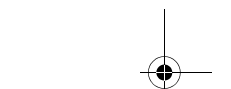
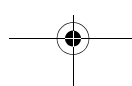

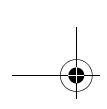

Suspend/Resume/Power On Button

The Suspend/Resume/Power On button allows you to suspend notebook activity without powering off, resume your LifeBook notebook from suspend mode, and power on your notebook when it has been shut down from Windows. (See *Suspend/Resume/Power On Button on page 27 for more information*)

Status Indicator Panel

The Status Indicator Panel displays symbols that correspond with a specific component of your LifeBook notebook. (See *Status Indicator Panel on page 12 for more information*)

Display Panel

The display panel is a color LCD panel with back lighting for the display of text and graphics.

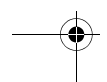
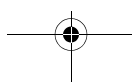
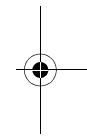
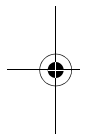

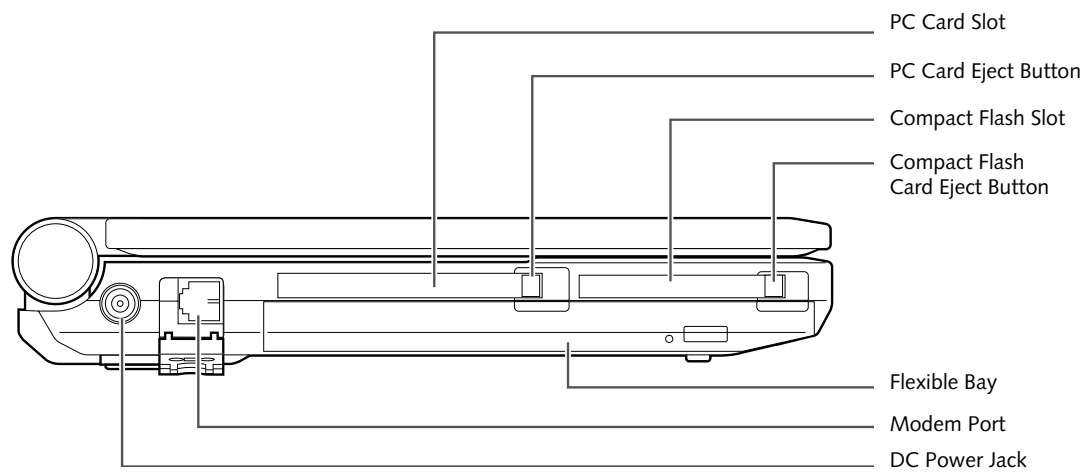

Figure 2-4 LifeBook notebook left-side panel

LEFT-SIDE PANEL COMPONENTS

The following is a brief description of your LifeBook notebook's left-side components.

PC Card Slot

The PC Card Slot allows you to install one Type II PC Card. (See *PC Cards* on page 37 for more information)

PC Card Eject Button

The PC Card eject button allows you to remove PC Cards from the PC Card slot. (See *PC Cards* on page 37 for more information)

Compact Flash Card Slot

Allows you to insert a compact flash (CF) card. (See *Compact Flash Cards* on page 38 for more information)

Compact Flash Card Eject Button

Allows you to eject a compact flash card. (See *Removing CF Cards* on page 39 for more information)

Flexible Bay

The Flexible Bay can accommodate either the standard DVD/CD-RW Drive or an optional modular bay battery. If neither device is installed, the weight saver should be installed. (See *Flexible Bay Devices* on page 18 for more information)

Modem (RJ-11) Telephone Port

The Modem (RJ-11) telephone port is for attaching a telephone line to the internal multinational 56K modem. (See *Modem (RJ-11) Telephone Port* on page 44 for more information)



The internal modem is not intended for use with Digital PBX systems. Do not connect the internal modem to a Digital PBX as it may cause serious damage to the internal modem or your entire notebook. Consult your PBX manufacturer's documentation for details. Some hotels have Digital PBX systems. Be sure to find out BEFORE you connect your modem.



The internal multinational modem is designed to the ITU-T V.90 standard. Its maximum speed of 53000bps is the highest allowed by FCC, and its actual connection rate depends on the line conditions. The maximum speed is 33600bps at upload.

For additional information about the multinational modem, refer to the Fujitsu web site at: us.fujitsu.com/computers.

DC Power Jack

The DC power jack allows you to plug in the AC adapter or the optional Auto/Airline adapter to power your notebook and charge the internal Lithium ion battery.

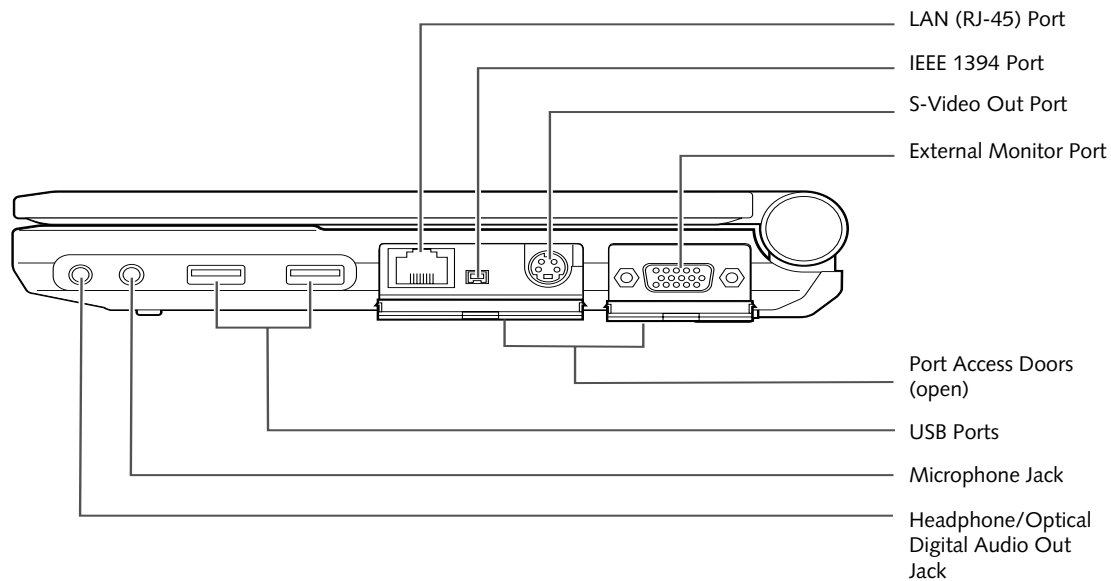
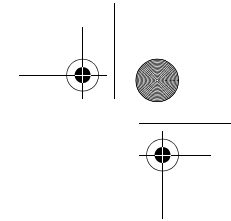

Figure 2-5 LifeBook notebook right-side panel

RIGHT-SIDE PANEL COMPONENTS

The following is a brief description of your LifeBook notebook's right-side components.

LAN (RJ-45) Port

The internal LAN (RJ-45) port is used for an internal Fast Ethernet (10/100 Base-TX) connection. (See *Internal LAN (RJ-45) Port on page 44 for more information*)

IEEE 1394 Port

The IEEE 1394 port (also known as "Firewire") is used to connect between your LifeBook and a peripheral such as a digital video camera. (See *IEEE 1394 Port on page 45 for more information*)

S-Video Out Port

The S-video out port is used to transmit a higher resolution video signal to a compatible TV or VCR. (See *S-Video Out Port (TV Out) on page 45 for more information*)

External Monitor Port

The external monitor port allows you to connect your LifeBook notebook to an external monitor. (See *External Monitor Port on page 46 for more information*)

Port Access Doors

The port access doors are designed to protect the ports when they are not in use.

USB 2.0 Ports

The USB ports allow you to connect Universal Serial Bus 2.0 devices. (See *Universal Serial Bus Ports on page 45 for more information*)

Microphone Jack

The microphone jack allows you to connect an external mono microphone. (See *Microphone Jack on page 46 for more information*)

Headphone/Optical Digital Audio Jack

The headphone/optical digital audio jack allows you to connect headphones or to download digital audio onto a MiniDisc recorder's SPDIF (Sony Philips Digital Interface) format. (See *Optical Digital Audio Connector on page 46 for more information*)

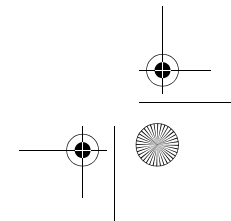
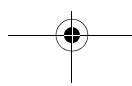
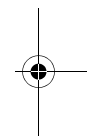
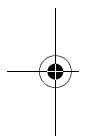

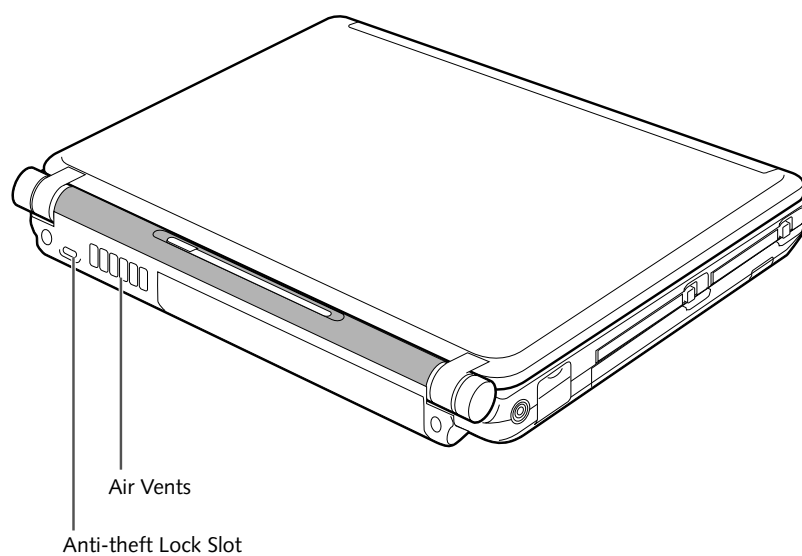

Figure 2-6 LifeBook notebook rear panel

REAR PANEL COMPONENTS

The following is a brief description of your LifeBook notebook's rear components.

Anti-theft Lock Slot

The anti-theft lock slot allows you to attach an optional physical lock down device.

Air Vents

The air vents allow for proper cooling of the system while it is operating.

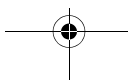

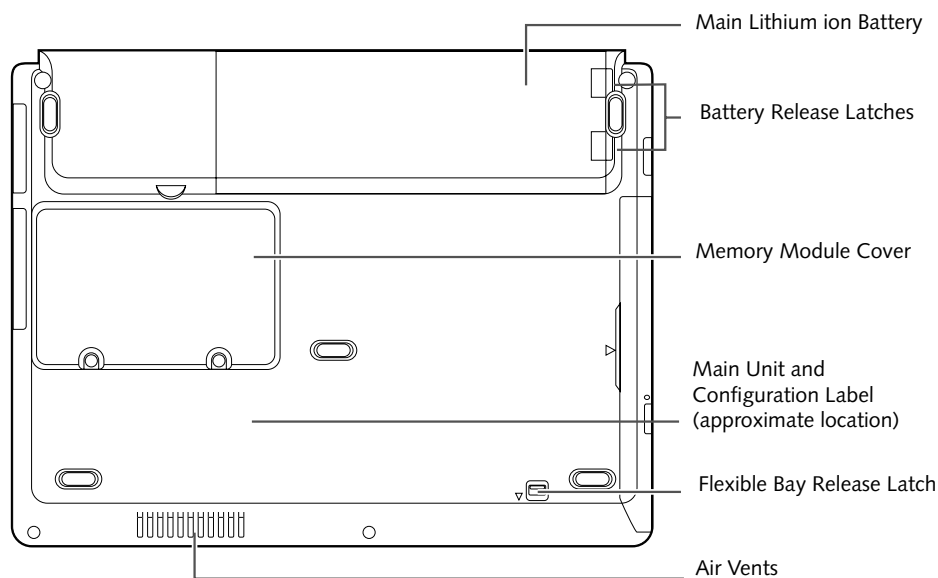
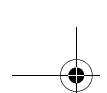

Figure 2-7 LifeBook notebook bottom panel

BOTTOM COMPONENTS

The following is a brief description of your LifeBook notebook's bottom panel components.

Lithium ion Battery

The internal Lithium ion battery can be installed in the battery bay by aligning it with the slides and pushing it into place. The battery can be removed when swapping with a charged battery, or when the computer is to be stored for a long period of time. (See *Lithium ion Battery on page 31 for more information*)

Battery Release Latches

Slide the battery releases to unlatch the battery.

Memory Module Cover

Removable cover over the memory modules. (See *Removing a Memory Module on page 42 for more information*)

Flexible Bay Release Latch

The Flexible Bay Release Latch releases the flexible bay device for removal. (See *Removing and Installing Modular Devices on page 18 for more information*)

Main Unit and Configuration Label

The configuration label shows the model number and other information about your LifeBook notebook. In addition, the configuration portion of the label has the serial number and manufacturer information that you will need to give your support representative. It identifies the exact version of various components of your notebook.

Air Vents

The air vents allow for proper cooling of the system while it is operating.



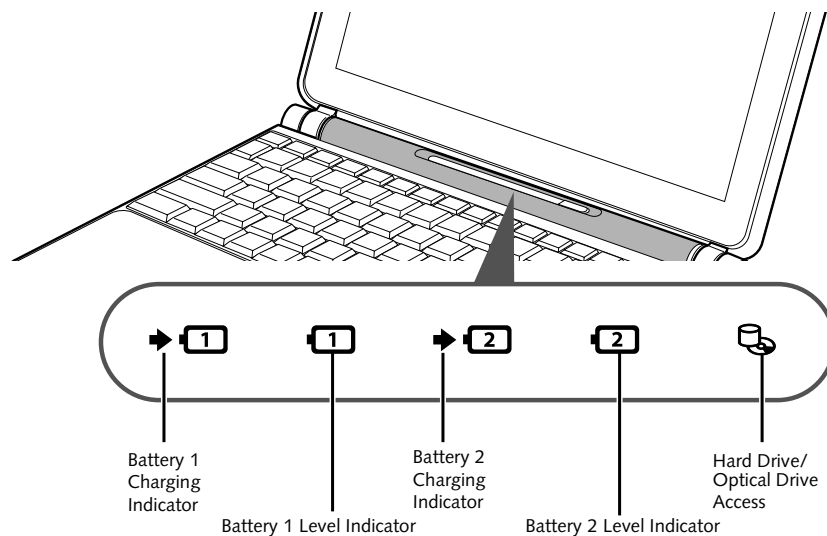
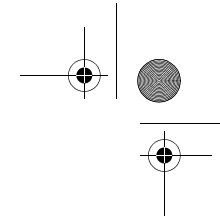

Figure 2-8 Status Indicator Panel

Status Indicator Panel

The Status Indicator displays symbols that correspond with a specific component of your LifeBook notebook. These symbols (when visible) tell you how each of those components is operating. (Figure 2-8). When you turn off the system, all indicators will go off, except when the battery is being charged.

BATTERY CHARGING INDICATORS

When the AC adapter is connected to your system, these indicators show the status of the specified battery charging (either the primary battery 1 or modular battery 2), as follows:

- **Green, solid:** The battery is either fully charged or the AC adapter is connected and there is no battery pack installed.
- **Orange, solid:** The battery pack is charging.
- **Orange, blinking:** Charging is suspended due to excessively high or low battery temperature.
- **Off:** No AC adapter is connected.

BATTERY LEVEL INDICATORS

The Battery Level indicators display the charge level of the indicated battery pack, as follows:

- **Green, solid:** Battery is between 51% and 100% charged.
- **Orange, solid:** Battery is between 13% and 50% charged.
- **Red, solid:** Battery is between 0% and 12% charged.
- **Orange, blinking:** Blinks during battery status measurement (Four seconds after the battery is installed).
- **Red, blinking:** There is a problem with the battery.
- **Off:** There is no battery installed.



- If the battery pack is installed while the power is turned off, the battery level indicator will display the charge level for five seconds after it blinks orange.
- If the AC adapter is not connected or the battery pack is not fully charged when the computer is switched to standby mode, the indicator will blink. The LED blinks at the rate of one second on/five seconds off.



- Batteries subjected to shocks, vibration or extreme temperatures can be permanently damaged.
- A shorted battery is damaged and must be replaced.



HARD DISK/CD ACCESS INDICATOR

The Hard Disk/CD access indicator lights when the hard disk or optical drive is being accessed. To prevent corruption of data, do not press the power button when the hard disk/CD access indicator is lit.



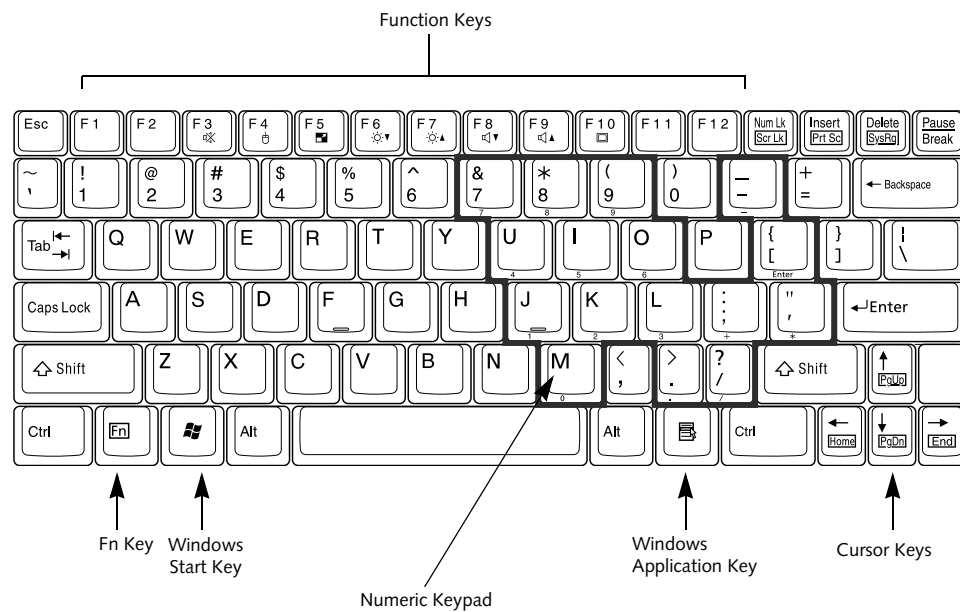

Figure 2-9 Keyboard

Keyboard

USING THE KEYBOARD

Your Fujitsu LifeBook notebook has an integral 82-key keyboard. The keys perform all the standard functions of a 101-key keyboard, including the Windows keys and other special function keys. This section describes the following keys. (Figure 2-9)

- **Numeric keypad:** Your notebook allows certain keys to serve dual purposes, both as standard characters and as numeric and mathematical keys. The ability to toggle between the standard character and numerical keys is controlled through the [NumLk] key.
- **Cursor keys:** Your keyboard contains four arrow keys for moving the cursor or insertion point to the right, left, up, or down within windows, applications and documents.
- **Function keys:** The keys labeled [F1] through [F12], are used in conjunction with the [Fn] key to produce special actions that vary depending on what program is running.
- **Windows keys:** These keys work with your Windows operating system and function the same as the onscreen Start menu button, or the right button on your pointing device.

KEY INDICATOR LIGHTS

There are three small indicator lights located on the lower right of the palm rest. (Figure 2-10). When lit, these lights indicate that the related key is locked.

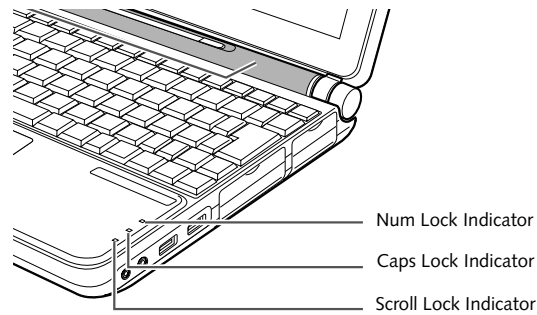

Figure 2-10 Key Indicators

NUMERIC KEYPAD

Certain keys on the keyboard perform dual functions as both standard character keys and numeric keypad keys. NumLk can be activated by pressing the [NumLk] keys. Turning off the NumLk feature is done the same way. Once this feature is activated you can enter numerals 0 through 9, perform addition (+), subtraction (-), multiplication (*), or division (/), and enter decimal points (.) using the keys designated as ten-key function keys. The keys in the numeric keypad are marked on the front edge of the key to indicate their secondary functions. (Figure 2-9)

WINDOWS KEYS

Your LifeBook notebook has two Windows keys, consisting of a Start key and an Application key. The Start key displays the Start menu. This button functions the same as your onscreen Start menu button. The

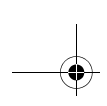

Application key functions the same as your right mouse button and displays shortcut menus for the selected item. (Please refer to your Windows documentation for additional information regarding the Windows keys.) (Figure 2-9)

CURSOR KEYS

The cursor keys are the four arrow keys on the keyboard which allow you to move the cursor up, down, left and right in applications. In programs such as Windows Explorer, it moves the "focus" (selects the next item up, down, left, or right). (Figure 2-9)

FUNCTION KEYS

Your LifeBook notebook has 12 function keys, F1 through F12. The functions assigned to these keys differ for each application. You should refer to your software documentation to find out how these keys are used. (Figure 2-9)

The [Fn] key provides extended functions for the notebook and is always used in conjunction with another key.

- [Fn+F3]: Pressing [F3] while holding [Fn] will toggle the Audio Mute on and off.
- [Fn+F4]: Pressing [F4] while holding [Fn] will toggle the Quick Point feature on and off. Note that the [Fn+F4] combination only works if Manual Setting is

selected in the BIOS. (See "Entering the BIOS Setup Utility" on page 25)

- [Fn+F5]: Pressing [F5] while holding [Fn] allows you to toggle between video compensation and no compensation. (Video compensation controls spacing on the display. When it is enabled, displays with 1024 x 768 or 800 x 600 pixel resolution will still cover the entire screen.) Note that this function is only applicable if Compensation is disabled in the BIOS. (See *BIOS Setup Utility* on page 25 for more information).
- [Fn+F6]: Pressing [F6] repeatedly while holding [Fn] will lower the brightness of your display.*
- [Fn+F7]: Pressing [F7] repeatedly while holding [Fn] will increase the brightness of the display.*
- [Fn+F8]: Pressing [F8] repeatedly while holding [Fn] will decrease the volume of your LifeBook notebook.**
- [Fn+F9]: Pressing [F9] repeatedly while holding [Fn] will increase the volume of your LifeBook notebook.**
- [Fn+F10]: Pressing [F10] while holding [Fn] allows you to change your selection of where to send your display video. Each time you press the combination of keys you will step to the next choice. The choices, in order, are: built-in display panel only, both built-in display panel and external monitor or external monitor only.

* There are eight brightness levels.

** There are 26 audio levels.

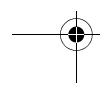
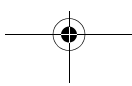
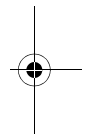
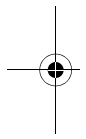

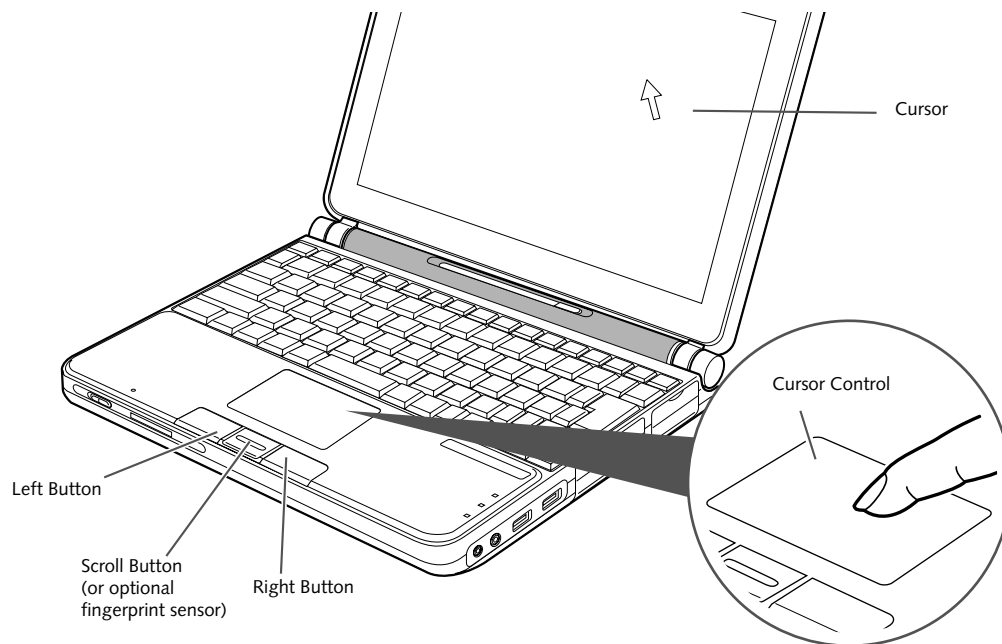

Figure 2-11 Touchpad pointing device

Touchpad Pointing Device

The Touchpad pointing device comes built into your LifeBook notebook. It is used to control the movement of the pointer to select items on your display panel. The Touchpad is composed of a cursor control, a left and right button, and a scrolling button. The cursor control works the same way a mouse does, and moves the cursor around the display. It only requires light pressure with the tip of your finger. The left and right buttons function the same as mouse buttons. The actual functionality of the buttons may vary depending on the application that is being used. The scrolling button allows you to navigate quickly through pages, without having to use the scroll bars. (Figure 2-15)



Certain configurations of the LifeBook P7000 notebook have an optional fingerprint sensor instead of a scrolling button. For information on using the optional fingerprint sensor, refer to "Fingerprint Sensor Device" on page 101.

CLICKING

Clicking means pushing and releasing a button. To left-click, move the cursor to the item you wish to select, press the left button once, and then immediately release it. To right-click, move the mouse cursor to the item you wish to select, press the right button once, and then immediately release it. You also have the option to perform the clicking operation by tapping lightly on the Touchpad once. (Figure 2-12)

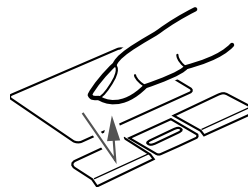

Figure 2-12 Clicking

DOUBLE-CLICKING

Double-clicking means pushing and releasing the left button twice in rapid succession. This procedure does not function with the right button. To double-click, move the cursor to the item you wish to select, press the left button twice, and then immediately release it. You also have the option to perform the double-click operation by tapping lightly on the Touchpad twice. (Figure 2-13)

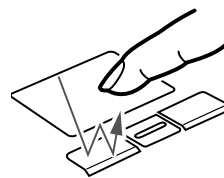

Figure 2-13 Double-clicking



- If the interval between clicks is too long, the double-click will not be executed.
- Parameters for the Touchpad can be adjusted from the Mouse Properties dialog box located in the Windows Control Panel.

DRAGGING

Dragging means pressing and holding the left button, while moving the cursor. To drag, move the cursor to the item you wish to move. Press and hold the left button while moving the item to its new location and then release it. Dragging can also be done using the Touchpad. First, tap the Touchpad twice over the item you wish to move making sure to leave your finger on the pad after the final tap. Next, move the object to its new location by moving your finger across the Touchpad, and then release your finger. (Figure 2-14)

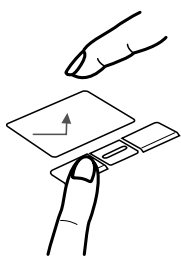

Figure 2-14 Dragging

SCROLLING

Using the Scrolling button allows you to navigate through a document quickly without using the window's scroll bars. This is particularly useful when you are navigating through on-line pages. To use the Scrolling button, press the crescent shape at the top or bottom of the button to scroll up or down a page. When you have reached the desired section of the page, release the button. (Figure 2-15)

If you have an optional fingerprint sensor in the location of the Scrolling button, you can scroll by sliding your finger up and down the fingerprint sensor. (Figure 2-16).

Note that you can also scroll by sliding your finger up and down the right side of the touchpad. This feature is disabled by default, but you can enable it by going to Start -> Control Panel -> Mouse.

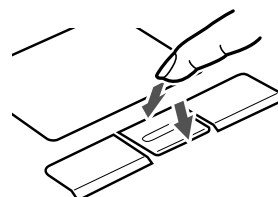

Figure 2-15 Scrolling with scrolling button

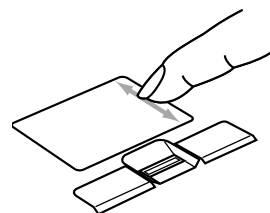
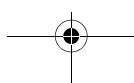
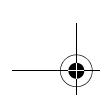

Figure 2-16 Scrolling with Touchpad

TOUCHPAD CONTROL ADJUSTMENT

If you need to change or adjust any of the touchpad control functions, you can customize them from the Mouse properties dialog box in the Control Panel. Click on Start, select Settings > Control Panel, then double-click Mouse.





Volume Control

Your Fujitsu LifeBook notebook has multiple volume controls which interact with each other.



Any software that contains audio files will also contain a volume control of its own. If you install an external audio device that has an independent volume control, the hardware volume control and the software volume control will interact with each other. It should be noted that if you set your software volume to Off, you will override external volume control settings.

CONTROLLING THE VOLUME

The volume can be controlled in several different ways:

- Volume can be set from within the Volume Control on the Taskbar.
- Volume can be controlled with the [F8] and [F9] functions keys. Pressing [F8] repeatedly while holding

[Fn] will decrease the volume of your notebook. Pressing [F9] repeatedly while holding [Fn] will increase the volume of your notebook.



There are 26 levels through which the function keys cycle.

- Volume can be controlled by many volume controls that are set within individual applications.
- Certain external audio devices you might connect to your system may have hardware volume controls.

Each source discussed above puts an upper limit on the volume level that must then be followed by the other sources.

We recommend that you experiment with the various volume controls to discover the optimal sound level.

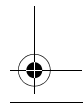
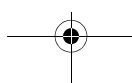
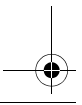
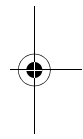
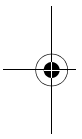

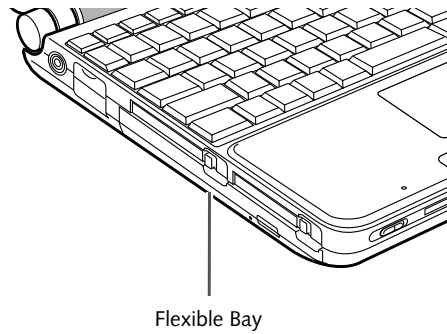
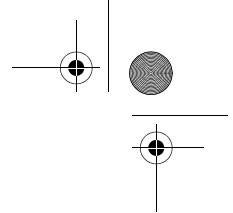

Flexible Bay

Figure 2-17 Flexible Bay

Flexible Bay Devices

Your Fujitsu LifeBook notebook contains a Flexible Bay. The Flexible Bay can accommodate a modular Multi-Format DVD Writer, a modular DVD/CD-RW combo drive, a modular Lithium ion battery, or a weight saver. (Figure 2-17)

- **Modular Multi-Format DVD Writer:** This allows you to access movies, software, and audio DVD/CDs and record to DVD±RW, CD-R/RW, and DVD-RAM discs.
- **Modular DVD/CD-RW combo drive:** This allows you to access movies, software, and audio DVD/CDs as well as to write to CDs.
- **Modular Lithium ion battery:** This is a rechargeable battery that can be used to power your LifeBook notebook when an adapter is not connected.
- **Weight Saver:** This is used to fill the bay when no device is installed.

REMOVING AND INSTALLING MODULAR DEVICES

To remove and install modular devices in the Flexible Bay, you can perform either a cold-swapping or hot-swapping of the device. Cold-swapping means swapping devices while your LifeBook notebook is powered off. Hot-swapping occurs when your system is powered on with a charged main battery or AC Adapter.



You should never leave your Flexible Bay empty when the notebook is in operation. If left empty, dust or foreign matter may accumulate inside the notebook.

Cold-swapping

To cold-swap modular devices in your Flexible Bay follow these easy steps:

1. Close any open files.
2. Shut down your LifeBook notebook.

3. Turn the system over and slide the release latch (Figure 2-18). Pull out the Flexible Bay device from the slot.

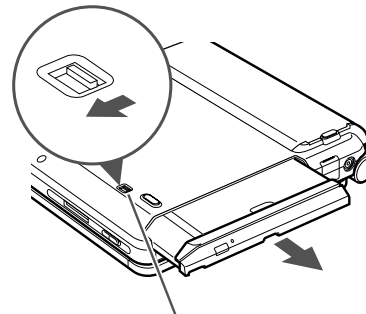

Flexible Bay Release Latch

Figure 2-18 Removing a device from the Flexible Bay



Be careful when aligning and seating devices in the bay. If the fit is incorrect, you may damage the bay or the device. If the device does not move easily in the bay, remove it, and check for dirt or foreign objects. It will require a firm push to latch the device in place.

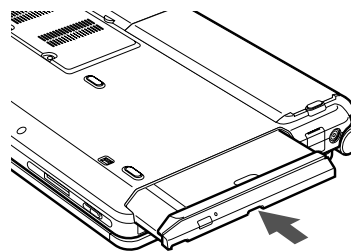
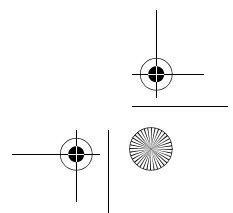
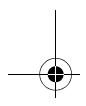
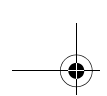

Figure 2-19 Installing a device in the Flexible Bay





5. Slide the device you are installing into your notebook until it clicks into place. (Figure 2-19)
6. It is now safe to turn your notebook back on.
7. You can now access and use the device.

Your LifeBook notebook will automatically detect the new device and activate it within your system. The drive letters associated with the device will be created and listed under My Computer and Windows Explorer.

Hot-swapping

To hot-swap Flexible Bay devices while the system is powered on, follow these steps:

1. Prior to performing the hot-swap, make sure you have a charged **main** battery installed, or an **AC Adapter** is powering the system.
2. If your system is in Suspend mode, press the Suspend/Resume button to resume operation.
3. Click the Safely Remove Hardware icon in the lower right-hand corner of the screen.
4. From the list that appears, click the device you want to remove.
5. Pull out the Flexible Bay eject lever. This will push your device out slightly, allowing you to remove the device.
6. Slide your device out until it is clear of the bay. This will require light force.



Be careful when aligning and seating devices in the bay. If the fit is incorrect, you may damage the bay or the device. If the device does not move easily in the bay, remove it, and check for dirt or foreign objects. It will require a firm push to latch the device in place.

7. Slide the device you are installing into your notebook until it clicks into place.
8. You can now access and use the device.

Your LifeBook notebook will automatically detect the new device and activate it within your system. The drive letters associated with the device will be created and listed under My Computer and Windows Explorer.

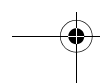
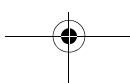
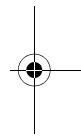
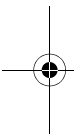

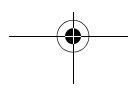
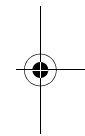
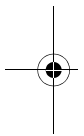
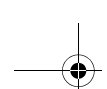

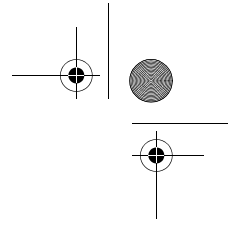
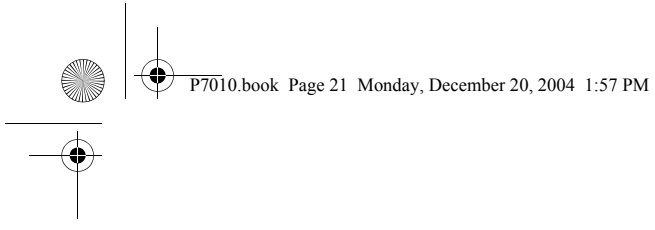

3 Getting Started

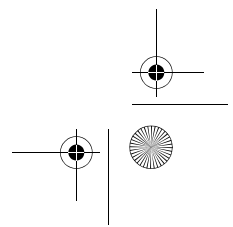
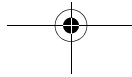
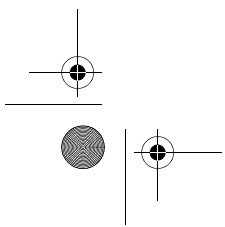
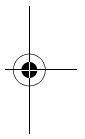
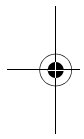

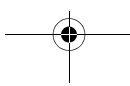
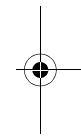
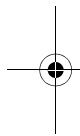
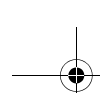

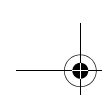

Getting Started

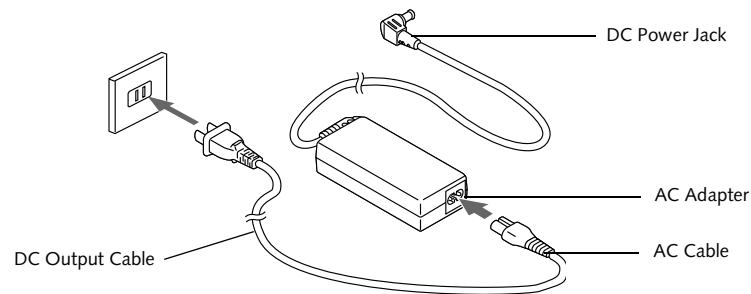

Figure 3-1 Connecting the AC Adapter

Power Sources

Your Fujitsu LifeBook notebook has four possible power sources: a primary Lithium ion battery, an optional modular Lithium ion battery, an AC adapter, or an optional Auto/Airline adapter.

CONNECTING THE POWER ADAPTERS

The AC adapter or optional Auto/Airline adapter provides power for operating your notebook and charging the batteries.

Connecting the AC Adapter

1. Plug the DC output cable into the DC power jack of your LifeBook notebook.
2. Plug the AC adapter into an AC electrical outlet. (Figure 3-1)

Connecting the Optional Auto/Airline Adapter

1. Plug the DC output cable into the DC power jack on your notebook.

2. Plug the Auto/Airline adapter into the cigarette lighter of an automobile with the ignition key in the On or Accessories position.
OR
3. Plug the Auto/Airline adapter into the DC power jack on an airplane seat.

Switching from AC Adapter Power or the Auto/Airline Adapter to Battery Power

1. Be sure that you have at least one charged battery installed.
2. Remove the AC adapter or the Auto/Airline adapter.



The Lithium ion battery is not charged upon purchase. Initially, you will need to connect either the AC adapter or the Auto/Airline adapter to use your notebook.

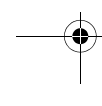
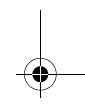
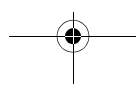
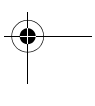
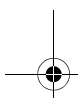
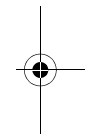
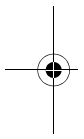

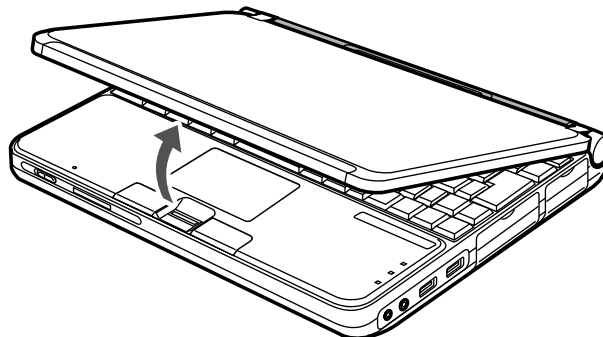
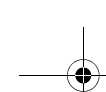

Figure 3-2 Opening the Display Panel

Display Panel

Your Fujitsu LifeBook notebook contains a display panel that is backlit for easier viewing in bright environments and maintains top resolution through the use of active-matrix technology.

OPENING THE DISPLAY PANEL

Lift the display backwards, being careful not to touch the screen, until it is at a comfortable viewing angle. (Figure 3-2)

ADJUSTING DISPLAY PANEL BRIGHTNESS

Once you have turned on your LifeBook notebook, you may want to adjust the brightness level of the screen to a more comfortable viewing level. There are two ways to adjust the brightness, by using the keyboard or the power management utility.

Using the Keyboard

Adjusting the brightness using the keyboard changes the setting only temporarily.

- [Fn+F6]: Pressing repeatedly will lower the brightness of your display.
- [Fn+F7]: Pressing repeatedly will increase the brightness of the display.

CLOSING THE DISPLAY PANEL

Holding the edge of your display panel, pull it forward until it is flush with the body of your LifeBook notebook.



Starting Your LifeBook Notebook

POWER ON

Suspend/Resume/Power On button

The Suspend/Resume/Power On button is used to turn on your LifeBook notebook from its off state. Once you have connected your AC adapter or charged the internal Lithium ion Battery, you can power on your notebook.



When you turn on your LifeBook notebook be sure you have a battery installed and charged, or that the AC or Auto/Air-line adapter is connected and has power.

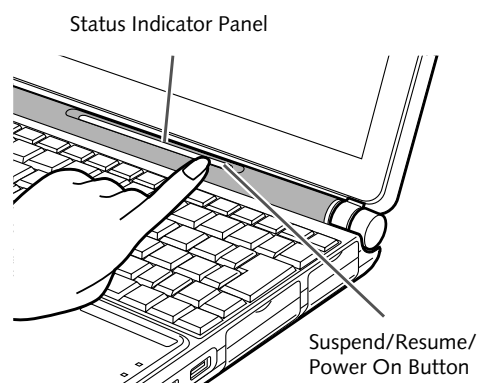

Figure 3-3 Pressing the suspend/resume/power button

Press the Suspend/Resume/Power On button that is adjacent to the status indicator panel (Figure 3-3). When you are done working you can either leave your LifeBook notebook in Suspend mode, (See *Suspend Mode on page 27 for more information*), or you can turn it off. (See *Power Off on page 28 for more information*)



Do not carry your LifeBook notebook around with the power on or subject it to shocks or vibration, as you risk damaging your notebook.

When turn on your LifeBook notebook, it will perform a Power On Self Test (POST) to check the internal parts and configuration for correct functionality. If a fault is found, your LifeBook notebook will emit an audio warning and/or an error message will be displayed. (See *Power On Self Test Messages on page 75 for more information*)

Depending on the nature of the problem, you may be able to continue by starting the operating system or by entering the BIOS setup utility and revising the settings.

After satisfactory completion of the Power On Self Test (POST), your notebook will load your operating system.

Never turn off your LifeBook notebook during the Power On Self Test (POST) or it will cause an error message to be displayed the next time you turn on your LifeBook notebook. (See *Power On Self Test Messages on page 75 for more information*)



BOOT SEQUENCE

The procedure for starting-up your notebook is termed the Bootup sequence and involves your notebook's BIOS. When your LifeBook notebook is first turned on, the main system memory is empty, and it needs to find instructions to start up your notebook. This information is in the BIOS program. Each time you power up or restart your notebook, it goes through a boot sequence which displays a Fujitsu logo until your operating system is loaded. During booting, your notebook is performing a standard boot sequence including a Power On Self Test (POST). When the boot sequence is completed without a failure and without a request for the BIOS Setup Utility, the system displays the operating system's opening screen.

The boot sequence is executed when:

- You turn on the power to your LifeBook notebook.
- You restart your notebook from the Windows Shut Down dialog box.
- The software initiates a system restart. Example: When you install a new application.
- You reset the system by pressing the three keys [CTRL+ALT+DEL].

BIOS SETUP UTILITY

The BIOS Setup Utility is a program that sets up the operating environment for your LifeBook notebook. Your BIOS is set at the factory for normal operating conditions, therefore there is no need to set or change the BIOS' environment to operate your notebook.

The BIOS Setup Utility configures:

- Device control feature parameters, such as changing I/O addresses and boot devices.
- System Data Security feature parameters, such as passwords.

Entering the BIOS Setup Utility

To enter the BIOS Setup Utility do the following:

1. Turn on or restart your LifeBook notebook.
2. Press the [F2] key once the Fujitsu logo appears on the screen. This will open the main menu of the BIOS Setup Utility with the current settings displayed.

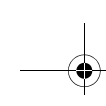

3. Press the [RIGHT ARROW] or [LEFT ARROW] key to scroll through the other setup menus to review or alter the current settings.

BIOS Guide

A guide to your notebook's BIOS is available online. Please visit our service and support Web site at <http://www.computers.us.fujitsu.com/support>. Once there, select Support, then select Notebooks under User's Guides. Select LifeBook BIOS Guides from the pull-down menu for your LifeBook series. If you are unsure of your notebook's BIOS number, refer to your packing slip.

BOOTING THE SYSTEM

We strongly recommend that you not attach any external devices and do not put a DVD/CD in your drive until you have gone through the initial power on sequence.

When you turn on your LifeBook notebook for the first time, it will display a Fujitsu logo on the screen. If you do nothing the system will load the operating system, and then the Windows Welcome will begin.

Designed to accommodate the needs of many users, in many different countries, Windows needs to be configured the first time you use them. Windows has three parts:

- **Getting Started:** You have the opportunity to enter custom information for your configuration file and setup your modem so that your LifeBook notebook will be prepared to dial out.
- **Registration:** Easy online registration for Windows with Microsoft, and for your LifeBook notebook with Fujitsu.
- **Windows License Agreement and Final Settings:** You have the opportunity to review the Windows License Agreement.



You may click Cancel at any time within this process to shut down Windows. You may restart this process at any time in the future, but you must complete it in order to use your computer.

Getting Started

Read the instructions on the screens carefully and fill in the information as directed. You will be asked for such items as the language you wish to use, the country in which you live, your first and last name, and about how you dial out from where you will be using your LifeBook notebook. For the modem settings, enter your current location information where you will be using your LifeBook notebook. If you are not connected to a phone line and plan to register at a later time, you may click the **Skip** button, and you will go directly to the condition of use page.

Once you have set up your LifeBook notebook to dial out, Windows will make a free telephone call to test the settings. If the call is unsuccessful, you will be returned to the phone settings page where you may try to fix them. If you are unable to fix the settings please contact Fujitsu Service and Support. (See *Fujitsu Contact Information on page 1 for more information*). If you would simply like to move on, and register at a later time, you may click the **Skip** button, and you will go directly to the Condition of Use page.

Windows Registration

If your connection is successful, you will go to a Registration Confirmation page. Enter the requested information, then check the box at the bottom to register your copy of Windows with Microsoft. Once you have finished, click the **Next** button to continue.

Final Settings

The first part of your final settings is the Windows End User License Agreement. Read the agreement carefully. When you finish reading you must accept or reject the terms of the agreement and then click on the **Next** button.



- If you reject the terms of the license agreement you will be asked to review the license agreement for information on returning Windows or to shut down your LifeBook notebook.
- You cannot use your LifeBook notebook until you have accepted the License Agreement. If you stop the process your notebook will return to the beginning of the Windows Welcome Process, even if you shut your notebook down and start it up again.

REGISTERING YOUR LIFEBOOK NOTEBOOK

How do I register my LifeBook notebook?

You can register your LifeBook by going to our Web site:

us.fujitsu.com/computers

You will need to be set up with an Internet Service Provider (ISP) to use the last option.

INSTALLING CLICK ME!

The first time you boot up your system, you will see an icon called Click Me! in the Start folder or in the system tray in the bottom right of the screen. When you click the Click Me! icon, your system will automatically build the icon tray in the bottom right of the screen. These icons provide links to utilities that you will frequently access.



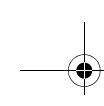

Power Management

Your Fujitsu LifeBook notebook has many options and features for conserving battery power. Some of these features are automatic and need no user intervention, such as those for the internal modem. However, others depend on the parameters you set to best suit your operating conditions, such as those for the display brightness. Internal power management for your notebook may be controlled from settings made in your operating system, pre-bundled power management application, or from settings made in BIOS setup utility.

Besides the options available for conserving battery power, there are also some things that you can do to prevent your battery from running down as quickly. For example, you can create an appropriate power saving profile, put your notebook into Suspend mode when it is not performing an operation, and you can limit the use of high power devices. As with all mobile, battery powered computers, there is a trade-off between performance and power savings.

SUSPEND/RESUME/POWER ON BUTTON

When your LifeBook notebook is active, the Suspend/Resume/Power On button can be used to manually put your notebook into Suspend mode. Push the button when your notebook is active, but not actively accessing anything, and immediately release the button. You will hear two short beeps and your system will enter Suspend mode. (See figure 2-3 on page 6 for location)

If your LifeBook notebook is suspended, pushing the Suspend/Resume/Power On button will return your notebook to active operation. You can tell whether or not your system is in Suspend mode by looking at the Power indicator. (See figure 2-3 on page 6) If the indicator is visible and not flashing, your notebook is fully operational. If the indicator is both visible and flashing, your notebook is in Suspend mode. If the indicator is not visible at all, the power is off or your notebook is in Hibernation mode.

SUSPEND MODE

Suspend or Standby mode in Windows saves the contents of your LifeBook notebook's system memory during periods of inactivity by maintaining power to critical parts. This mode will turn off the CPU, the display, the hard drive, and all of the other internal components except those necessary to maintain system memory and allow for restarting. Your notebook can be put in Suspend mode by:

- Pressing the Suspend/Resume/Power On button when your system is turned on.
- Selecting Standby from the Windows Shut Down menu.

- Timing out from lack of activity.
- Allowing the battery to reach the Dead Battery Warning condition.

You can change the actions the computer takes when the lid is closed or buttons are pressed by clicking [Start] -> Control Panel. Double-click the Power Options icon and select the Advanced tab.

Your LifeBook notebook's system memory typically stores the file(s) on which you are working, open application(s) information, and any other data required to support the operation(s) in progress. When you resume operation from Suspend mode, your notebook will return to the point where it left off. You must use the Suspend/Resume/Power On button to resume operation, and there must be an adequate power source available, or your notebook will not resume.

- If you are running your LifeBook notebook on battery power, be aware that the battery continues to discharge while your notebook is in Suspend mode, though not as fast as when fully operational.
- Disabling the Suspend/Resume/Power On button prevents it from being used to put your LifeBook notebook in Suspend or Hibernation mode. The resume function of the button cannot be disabled.
- If your LifeBook notebook is actively accessing information when you enter the Suspend or Hibernation mode, changes to open files are not lost. The files are left open and memory is kept active during Suspend mode or the memory is transferred to the internal hard drive during Hibernation mode.



The Suspend or Hibernation mode should not be used with certain PC Cards. Check your PC Card documentation for more information.



When PC Cards or external devices are in use, Hibernation mode cannot return to the exact state prior to suspension, because all of the peripheral devices will be re-initialized when the system restarts.

HIBERNATION FEATURE

The Hibernation feature saves the contents of your LifeBook notebook's system memory to the hard drive as a part of the Suspend/Resume mode. You can enable or disable this feature.

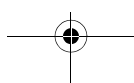
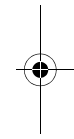
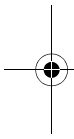

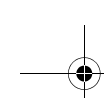

Enable or Disable the Hibernation Feature

The default settings is not enabled. To enable or disable the Hibernation feature follow these easy steps:

1. From the **Start** menu, select **Settings**, and then select **Control Panel**.
2. From the **Control Panel** select **Power Options**.
3. Select the **Hibernation** tab. Select the box to enable or disable this feature.

Using the Hibernation Feature

1. From the **Start** menu, select **Settings**, and then select **Control Panel**.
2. From the **Control Panel** select **Power Options**.
3. Select the **Advanced** tab. Select **Hibernate** from the pull down menu for Power buttons.



You can also enter Hibernate mode by clicking **Start -> Shut Down...**, then selecting **Hibernate** from the dropdown menu.

DISPLAY TIMEOUT

The Video Timeout is one of the power management parameters. This feature saves power by turning off the display if there is no keyboard or pointer activity for the user selected timeout period. Any keyboard or pointer activity will cause the display to restart automatically. This feature is independent of the Suspend/Resume button and can be enabled and disabled in Windows and BIOS setup utility.

HARD DISK TIMEOUT

The Hard Disk Timeout is another one of the power management parameters. This feature saves power by turning off the hard drive if there is no hard drive activity for the user selected timeout period. Any attempt to access the hard drive will cause it to restart automatically. This feature is independent of the Suspend/Resume button and can be enabled and disabled in Windows and BIOS setup utility.

WINDOWS POWER MANAGEMENT

Power Management

The Power Management icon located in the Windows Control Panel allows you to configure some of the power management settings. For example, you can use the Power Management to set the timeout values for turning off the display and hard disks whether you are running the notebook on battery power or one of the adapters. The settings may also be changed in the BIOS.

RESTARTING THE SYSTEM

If your system is on and you need to restart it, be sure that you use the following procedure.

1. Click the **Start** button, and then click **Shut Down**.
2. Select the **Restart** option from within the Windows Shut Down dialog box.
3. Click **OK** to restart your notebook. Your notebook will shut down and then reboot.



Turning off your LifeBook notebook without exiting Windows or turning on your notebook within 10 seconds of the notebook being shut off may cause an error when you start the next time.

POWER OFF

Before turning off the power, check that the Hard Drive, DVD, CD-ROM, CD-RW, PC Card and the Floppy Disk Drive Access indicators are all Off. (See figure 2-3 on page 6) If you turn off the power while accessing a disk or PC Card there is a risk of data loss. To ensure that your notebook shuts down without error, use the Windows shut down procedure.



Be sure to close all files, exit all applications, and shut down your operating system prior to turning off the power. If files are open when you turn the power off, you will lose any changes that have not been saved, and may cause disk errors.

Using the correct procedure to shut down from Windows allows your notebook to complete its operations and turn off power in the proper sequence to avoid errors. The proper sequence is:

1. Click the **Start** button, and then click **Shut Down**.
2. Select the **Shut Down** option from within the Windows Shut Down dialog box.
3. Click **OK** to shut down your notebook.

If you are going to store your notebook for a month or more see Care and Maintenance Section.

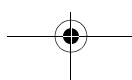

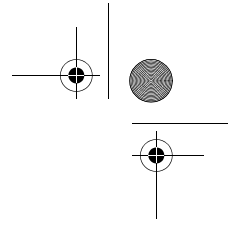
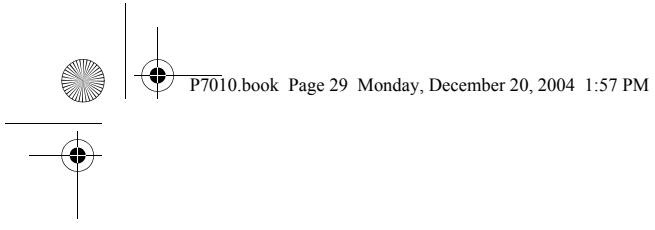

4

User-Installable Features

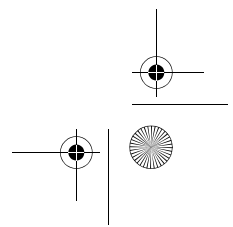
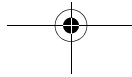
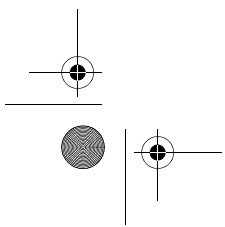
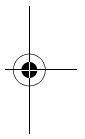
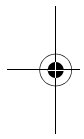

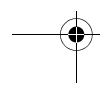
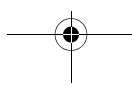
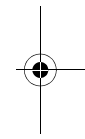
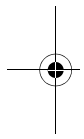
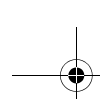

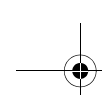

User Installable Features

Lithium ion Battery

Your LifeBook notebook has a Lithium ion battery (and possibly an optional modular battery) that provides power for operating your notebook when no external power source is available. The battery is durable and long lasting, but should not be exposed to extreme temperatures, high voltages, chemicals, or other hazards.

The Lithium ion battery operating time may become shorter if it is used under the following conditions:

- When used at temperatures that exceed a low of 5°C (41°F) or a high of 35°C (95°F). Extreme temperatures not only reduce charging efficiency, but can also cause battery deterioration. The charging indicator on the Status Indicator panel will flash red for the affected battery (battery 1 or 2) when you try to charge a battery that is outside of operating temperature range. (See *Battery Charging Indicators on page 12 for more information*)
- When using a high current device such as a modem, DVD/CD-RW drive, or the hard drive, using the AC adapter will conserve your battery life.



Do not leave a faulty battery in your LifeBook notebook. It may damage your AC adapter, optional Auto/Airline adapter, another battery or your notebook itself. It may also prevent operation of your notebook by draining all available current into the bad battery.



- Battery life will vary based on screen brightness, applications, features, power management settings, battery condition and other customer preferences. DVD, CD-RW, CD-ROM, or hard drive usage may also have a significant impact on battery life. The battery charging capacity is reduced as the battery ages. If your battery is running low quickly, you should replace it with a new one.
- Under federal, state, or local law it may be illegal to dispose of batteries by putting them in the trash. Take care of our environment by disposing of batteries properly. Check with your local government authority for information on recycling or disposing of old batteries. If you cannot find this information elsewhere, contact your support representative at 1-800-8Fujitsu (1-800-838-5487)

RECHARGING THE BATTERIES

If you want to know the condition of the primary Lithium ion battery, check the Battery Level 1 indicator located on the Status Indicator panel. The indicator changes as the battery level changes. If you want to know the condition of the secondary modular Lithium ion battery, check the Battery Level 2 indicator located on the Status Indicator panel.

The Lithium ion battery is recharged internally using the AC adapter or Auto/Airline adapter. To recharge the battery make sure the battery that needs to be charged is installed in your LifeBook notebook and connect the AC or Auto/Airline adapter.



Make sure that the Battery Charging indicator and the percentage charge is shown inside the Battery Level icon on the Status Indicator Panel. (See *Battery Charging Indicators on page 12 for more information*)

There is no memory effect on the Lithium ion battery therefore you do not need to discharge the battery completely before recharging. The charge times will be significantly longer if your notebook is in use while the battery is charging.

If you want to charge the battery more quickly, put your notebook into Suspend mode, or turn it off while the adapter is charging the battery. (See *Power Management on page 27 for more information*)



Using heavy current devices such as Modem or frequent DVD/CD-RW/CD-ROM accesses may prevent charging completely.

Low Battery State

When the battery is running low, a low battery notification message will appear. If you do not respond to the low battery message, the batteries will continue to discharge until they are too low to operate. When this happens, your notebook will go into Suspend mode. There is no guarantee that your data will be saved once the notebook reaches this point.

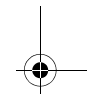
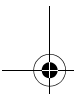
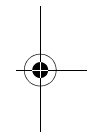
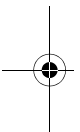



- Once the low battery notification message appears, you need to save all your active data and put your system into Suspend mode until you can provide a new power source. You should provide a charged battery, AC power adapter, or Auto/Airline adapter as soon as possible.
- When you are in Suspend mode there must always be at least one power source active. If you turn off the power or remove all power sources while your LifeBook notebook is in Suspend mode, any data that has not been saved to the hard drive will be lost.

Dead Battery Suspend mode shows on the Status indicator just like the normal Suspend mode. Once your notebook goes into Dead Battery Suspend mode you will be unable to resume operation until you provide a source of power either from an adapter, or a charged battery. Once you have provided power, you will need to press the Suspend/Resume button to resume operation.

In Dead Battery Suspend mode, your data can be maintained for some time, but if a power source is not provided promptly, the charging indicator will stop flashing and go out, meaning that you have lost the data that was not stored. Once you provide power, you can continue to use your notebook while an adapter is charging the battery.

Shorted Batteries

The Status Indicator panel battery charging icons will blink red to indicate a shorted battery or battery problem. This indicates that the battery is damaged and must be replaced so it does not damage any other parts of your LifeBook notebook.

REPLACING THE BATTERY

With the purchase of an additional battery, you can have a fully charged spare to swap with one that is not charged.

Swapping Batteries when Additional Power Source is not Available

To swap batteries in your battery bay when you don't have another power source available (such as an AC Adapter or charged modular battery), follow these easy steps: (Figure 4-1)

1. Have a charged battery ready to install.
2. Shut down your notebook.
3. Press and hold the battery release latches to open the bay. (Figure 4-1)

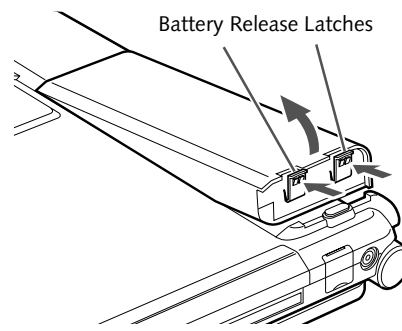

Figure 4-1 Removing the Battery

4. Remove the battery from the bay.
5. Place the new battery into the bay. (Figure 4-2)
6. Verify that the battery bay latches click into place.

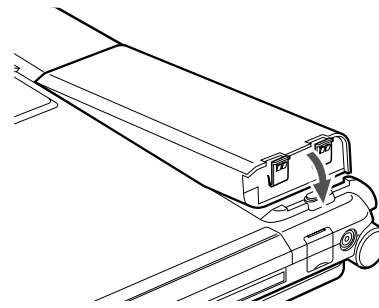

Figure 4-2 Installing a battery

Swapping Batteries when another Power Source is available

To swap batteries in your battery bay when you have an additional power source (such as an AC Adapter or charged modular battery), follow these easy steps: (Figure 4-1)

1. Plug in an AC Adapter or install a fully charged modular battery in the Flexible Bay to ensure power is supplied to the system.
2. Slide and hold the battery release latches to open the bay.
3. Remove the battery from the bay.
4. Slide the new battery into the bay.
5. Verify that the battery bay latches click into place.



If the Lithium ion battery connector is not fully seated, you may not be able to use your notebook or charge your battery.

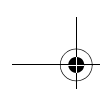

User Installable Features

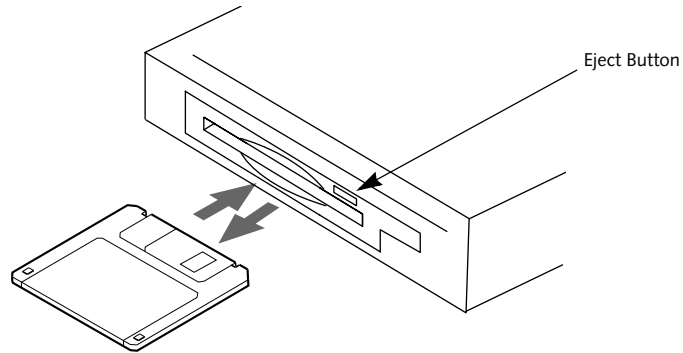

Figure 4-3 Loading/Ejecting a 3.5" Floppy Disk

External Floppy Disk Drive

Your LifeBook notebook may have an optional external floppy disk drive which can read and write information on removable 1.44MB and 720KB floppy disks.



Your LifeBook notebook is preconfigured to boot from a floppy drive. Reference the BIOS manual for further information on changing the default boot drive.

LOADING A DISK

To load a disk into your disk drive, follow these easy steps:

1. Orient the disk so that its label is facing upwards and the shutter side is pointing towards the drive. (Figure 4-3)
2. Push the disk into the drive until the Eject button pops out and you hear a click.

EJECTING A DISK

To eject a disk from the disk drive, follow these easy steps:

1. Check that the Floppy Disk Drive Access indicator is inactive.
2. Press the Eject button. This will push your disk partially out of the drive.
3. Remove the disk.



If you eject the disk while the Floppy Disk Drive Access indicator is active, there is a risk of damaging the data on the disk, the disk itself or even the disk drive.

PREPARING A DISK FOR USE

Before you can use a new disk, it needs to be prepared so your LifeBook notebook knows where to store information. This preparation is called formatting or initializing a disk. You will need to format new disks, unless they are preformatted. (Please refer to your operating system manual for step-by-step instructions on formatting a disk)

To prevent accidental erasure of the data stored on a disk, slide the "write protect" tab until a small hole is exposed. This sets the disk into a protected state where nothing can be added or removed. If you want to add or remove data on a protected disk, slide the "write protect" tab to close the small hole. (Figure 4-4)

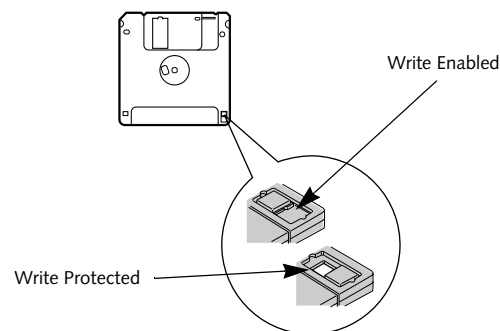

Figure 4-4 Floppy Disk Write Protect



Formatting a floppy disk that already contains data will erase all of the information on the disk.



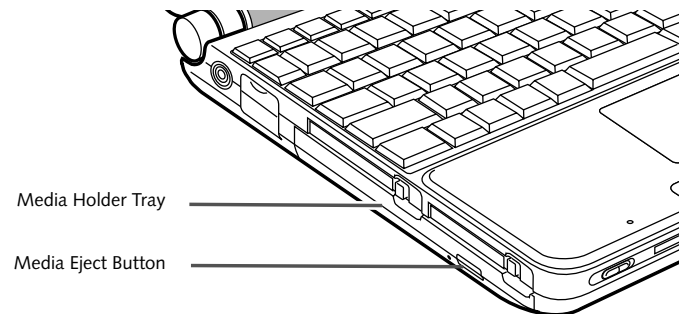
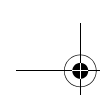

Figure 4-5 Optical Disk Drive

Optical Drive

There is a variety of media available to use with your system, depending upon the system configuration you have selected. Multi-Format DVD Writer and DVD/CD-RW Combo drives are collectively known as “optical drives”.

A CD-R or DVD-R disc can only be written to once; CD-RW or DVD-RW discs can be written to over and over. CD-R and CD-RW discs hold up to 700MB of data. DVD-R and DVD-RW discs hold up to 4.7 GB of data.

Depending upon the configuration of your LifeBook notebook, you may have one of the following drives:

- **Multi-Format DVD Writer:** The Multi-Format DVD Writer combines seven recordable formats in a single drive (DVD-R, DVD+R, DVD-RW, DVD+RW, DVD-RAM, CD-R, and CD-RW), making it the most versatile drive to date.
- **DVD/CD-RW combo:** A DVD/CD-RW combo drive allows you to access movie, software, data, or audio DVD/CDs, and to write data onto recordable CD-R and CD-RW discs.



Install your media player software before first using the optical drive. Refer to the applicable readme file on the Driver Applications CD-ROM.

MEDIA PLAYER SOFTWARE

Multi-Format DVD Writer model only: With the Multi-Format DVD Writer and media player software you can play DVD movies and music CDs on your LifeBook notebook. The media player includes controls which allow you to take full advantage of the features of a DVD movie, as well as standard features such as fast forward, fast reverse, pause, etc. With this drive you can also burn onto recordable DVD-R/RW, DVD+R/RW, or CD-R/RW discs.



The Multi-Format DVD Writer also supports burning and reading of DVD-RAM. (Windows XP supports burning and reading of DVD-RAM as a standard feature.)

DVD/CD-RW Combo model only: With the combo drive, you can play DVD movies, read audio CDs, and write data onto recordable CD-R or CD-RW discs.

LOADING A DVD OR CD

To load a disc into your optical drive, follow these steps (Figure 4-6):

1. Push and release the eject button on the front of the optical drive to open the holder tray. The tray will come out of the notebook a short distance.
2. Gently pull the tray out until a media disc can easily be placed in the tray.



There may be a protective sheet in the tray from when it was shipped; make sure it is removed before operating the drive, otherwise you may damage the drive.

3. Place the media disc into the tray, label side up. Snap the hole in the center of the disc onto the raised circle in the center of the tray.
4. Gently push the holder tray back in until you hear a click.



If you have disabled the Auto Insert Notification Function, you will have to start the drive from your desktop, since your notebook will not automatically recognize that media has been loaded.

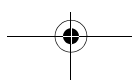

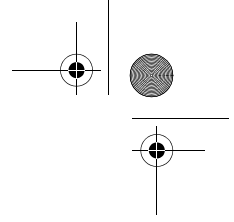

User Installable Features

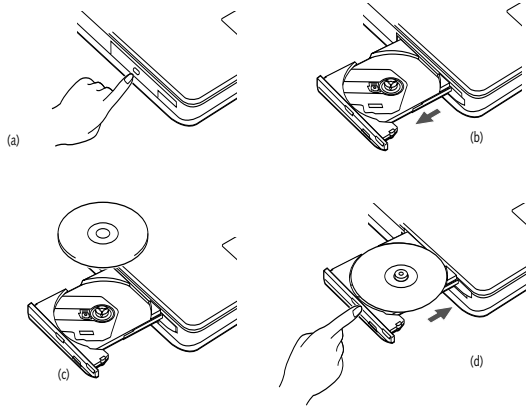

Figure 4-6 Loading/Removing Media

REMOVING MEDIA

1. Push and release the eject button on the front of the optical drive. This will stop the drive and the holder tray will come out of the notebook a short distance.
2. Gently pull the tray out until the disc can easily be removed from the tray.
3. Carefully remove the media disc from the holder tray.
4. Gently push the holder tray back in until you hear a click.

USING THE OPTICAL DRIVE SOFTWARE

Starting a DVD Movie

1. Insert the DVD movie into the optical drive of your notebook. If the CD AutoRun feature activates, skip Step 2.
2. The first time you insert a movie into the media tray, you will be prompted to select what you want the system to do when discs are inserted (i.e., start automatically or wait for a prompt). Until you make a selection, you will receive the same prompt whenever you insert a disc.

Opening the Optical Drive Control Panel

With most DVD-ROMs, you have the option of altering how the movie should play and what you wish to view. You can do this by using the optical drive control panel and the mouse.

1. Right-click on the movie screen to open a dropdown menu for options.
2. Select **View**, then **Player** for all the controls available. This will open the control panel into the bottom of the screen.

Using the Optical Drive Control Panel

The optical drive software allows you to watch the movie much like a VCR player. You have the option to pause, rewind, fast-forward and stop the movie at any point.

1. To Pause the movie, click the **II** button.

2. To Rewind the movie, click the **⏮** button to rewind to a specific portion of the movie, or the **⏪** button to return to the opening screen.
3. To Fast-forward the movie, click the **⏭** button to forward to a specific portion of the movie, or the **⏩** button to jump to the ending credits.
4. To Stop the movie, click the **■** button.

Exiting the DVD/CD-RW Application

1. Click the **X** located in the upper right corner of the title bar. This will open an optical drive dialog box.
2. Click **Yes** to stop and exit the movie, or **No** to close the optical drive dialog box and return to the movie.

USING DOLBY™ HEADPHONE

The Dolby Headphone utility lets you enjoy multi-channel sound sources, such as movies, with realistic surround sound using your *conventional* stereo headphones.

Dolby Headphone is a signal processing system that enables your stereo headphones to realistically portray the sound of a five-speaker playback system.



- Media discs which do not have the Dolby Surround 5:1 symbol will not support Dolby Headphone.
- After making changes to the Dolby Headphone feature and clicking OK, wait at least ten seconds before making another change in order to allow the system to stabilize.

To use the Dolby Headphone feature, perform the following steps:

1. Double click the InterVideo WinDVD icon on your desktop.
2. On the toolbar that appears, click the Fujitsu logo
3. Select the desired Room Filter Setting.
4. Click OK. The Dolby Headphone feature will now be enabled until you disable it selecting **Disable** in the Dolby Headphones menu (click on the Fujitsu logo to open it). Note that Dolby Headphone is not accessible if a DVD is not inserted.

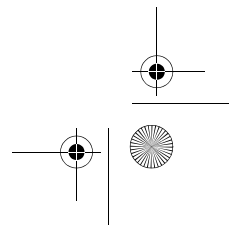
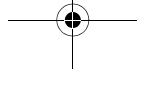
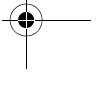
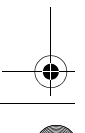
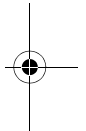
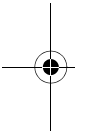

USING THE OPTICAL DRIVE ON BATTERY POWER

Since an optical drive consumes a lot of power, your overall battery life will be shorter when operating the drive continuously (such as watching a DVD movie) than during standard operation. Many movies run-times are longer than your LifeBook notebook can support on a single battery. If you are watching a DVD movie on battery power you may need to swap in an additional, charged battery or attach AC power during the movie to view it in its entirety.



- Prolonged use of the optical drive, such as when watching a DVD movie, will substantially reduce your notebook's battery life.
- An additional fully-charged battery is highly recommended if you will be watching DVD movies on battery power. If you don't have an additional battery, you may purchase one either on-line at us.fujitsu.com/computers or call 1-877-372-3473.

To Watch a Movie on Battery Power:

1. Have an additional full-charged battery or your AC adapter ready for use.
2. Start watching your DVD movie.
3. When the low battery warning occurs, immediately stop the movie and exit the DVD/CD-RW application.



If you do not stop the optical drive quickly and the LifeBook notebook attempts to auto-suspend (critical battery low state) the notebook will shut down improperly. If this occurs, you will need to install a fresh power source (either a charged battery or AC Adapter).

4. Connect an AC Adapter to your system, or install a fully charged battery in the Flexible Bay (after removing any modular devices that may be present in the bay) prior to removing the main battery.
5. Manually place your notebook into suspend mode by depressing the Suspend button then replace the discharged battery with a fully-charged battery.
6. If you removed the optical drive from the Flexible Bay in step 4, reinstall it now.
7. Resume your notebook by pressing the Suspend button again. This step is not required if you attached AC power without entering suspend mode.
8. Restart your DVD/CD-RW application and skip to the chapter of the movie you were last watching.
9. Continue watching your DVD movie.



Some shorter DVD movies may not require you to swap batteries or attach AC power to complete them. However, it is best to be prepared since actual battery life while operating the optical drive cannot be guaranteed.

AUTO INSERT NOTIFICATION FUNCTION

The Auto Insert Notification function allows your LifeBook notebook to automatically start a DVD/CD as soon as it is inserted in the optical drive and the tray is closed. Your notebook will begin playing an audio DVD/CD or will start an application if the DVD/CD includes an auto run file.

To prevent a CD from playing automatically as soon as it is inserted, refer to the related help file for your specific operating system.

EMERGENCY TRAY RELEASE

In the event that your system does not have power applied, you can still open the media tray using the end of an opened paper clip. To open the tray, insert the paper clip into the emergency tray release hole on the fact of the tray (*Figure 4-7*). The tray will pop open.

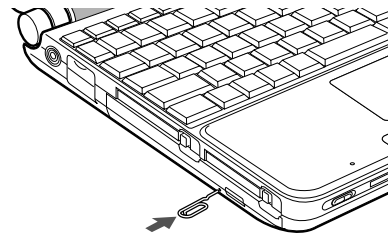
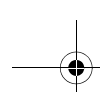

Figure 4-7 Using the Emergency Tray Release



User Installable Features

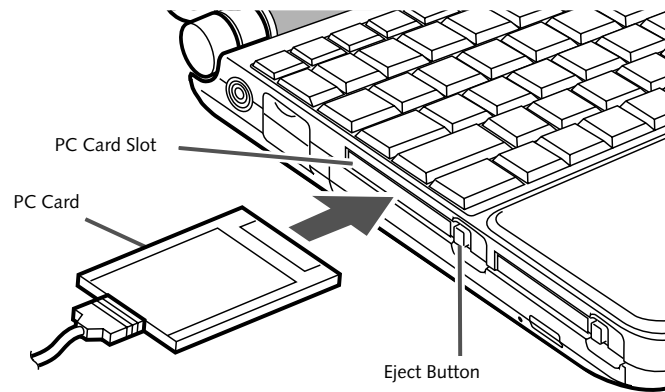

Figure 4-8 Installing/Removing PC Cards

PC Cards

Your Fujitsu LifeBook notebook supports Type I and II PC Cards, which can perform a variety of functions.

Some available PC Cards:

- Fax/data modem cards
- Local area network (LAN) cards
- IDE solid-state disk cards
- SCSI cards
- Wireless LAN cards
- Other PC Cards that conform to PCMCIA 2.1 or CardBus standards

For further information, refer to the instructions supplied with your PC Card.

INSTALLING PC CARDS

PC Cards are installed in the PC Card slot. To install a PC Card, follow these easy steps: (Figure 4-8)



- Installing or removing a PC Card during your LifeBook notebook's shutdown or bootup process may damage the card and/or your notebook.
- Do not insert a PC Card into a slot if there is water or any other substance on the card as you may permanently damage the card, your LifeBook notebook, or both.

1. See your PC Card manual for specific instructions on the installation of your card. Some PC Cards may require your notebook to be Off while installing them.
2. Make sure there is no PC Card currently in the slot. If there is, see Removing PC Cards.
3. Insert your PC Card into the slot, with the product label facing up.

4. Push the card into the slot firmly until it is seated in the opening. You will hear a click and the Eject button will pop away from your notebook.

REMOVING PC CARDS

To remove a PC Card, follow these easy steps:



Windows has a shutdown procedure for PC Cards that must be followed before removing a card. (Please review your operating system manual for the correct procedure).

1. See your PC Card manual for specific instructions on removing your card. Some PC Cards may require your notebook to be in Suspend Mode or Off while removing them.



If the dialog box states that the device cannot be removed, you must save all of your open files, close any open applications and shut down your notebook.

2. Push the Eject button in until it is flush with the notebook. This will push the PC Card slightly out of the slot allowing you to remove the card.



If the PC Card has an external connector and cable, do not pull the cable when removing the card.



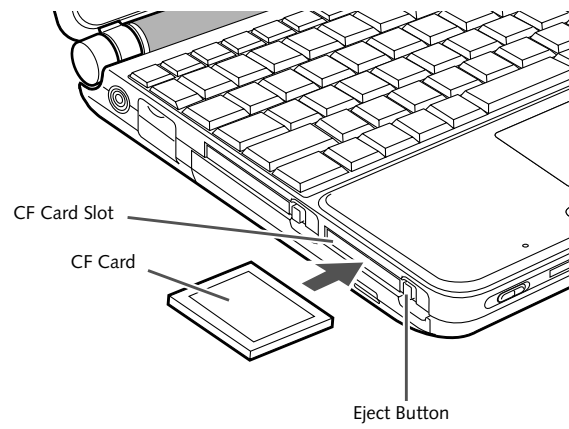
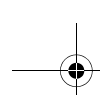

Figure 4-9 Installing/Removing CF Cards

Compact Flash Cards

Your Fujitsu LifeBook notebook supports Compact Flash (CF) cards, which can perform a variety of functions.

Some available CF Cards:

- Memory cards
- Fax/data modem cards
- Local area network (LAN) cards
- Wireless LAN (802.11b) cards

For further information, refer to the instructions supplied with your CF Card.

INSTALLING CF CARDS

CF Cards are installed in the CF Card slot. To install a CF Card, follow these steps: (Figure 4-9)

- Installing or removing a CF Card during your LifeBook notebook's shutdown or bootup process may damage the card and/or your notebook.
- Do not insert a CF Card into a slot if there is water or any other substance on the card as you may permanently damage the card, your LifeBook notebook, or both.



1. See your CF Card manual for specific instructions on the installation of your card. Some CF Cards may require your notebook to be Off while installing them.
2. When you receive your LifeBook, there will be a protective plug installed in the slot. Whenever you don't have a CF Card installed, be sure to replace the plug to prevent system contamination. To remove

the plug, press the CF Card eject button. (Figure 4-10)

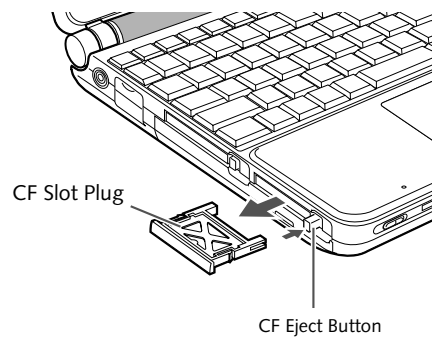

Figure 4-10 Removing CF Slot plug

3. When the CF Slot plug is ejected, remove it from the slot.
4. Insert your CF Card into the slot, with the product label facing up.

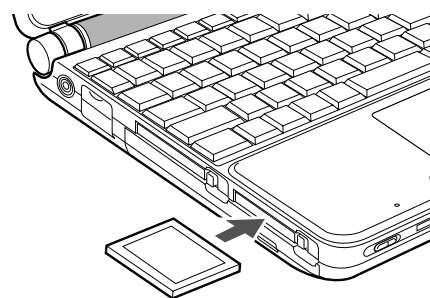
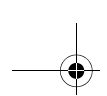

Figure 4-11 Installing a CF Card

5. Push the card into the slot firmly until it is seated in the opening. You will hear a click and the Eject button will pop away from your notebook.





REMOVING CF CARDS

To remove a CF Card, follow these easy steps:



Windows has a shutdown procedure for CF Cards that must be followed before removing a card. (Please review your operating system manual for the correct procedure).

1. See your CF Card manual for specific instructions on removing your card. Some CF Cards may require your notebook to be in Suspend Mode or Off while removing them.



If the dialog box states that the device cannot be removed, you must save all of your open files, close any open applications and shut down your notebook.

2. Push the Eject button in until it is flush with the notebook. This will push the CF Card slightly out of the slot allowing you to remove the card.

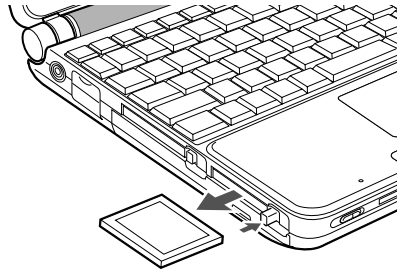
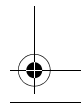
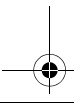
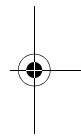
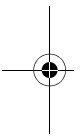

Figure 4-12 Removing a CF Card



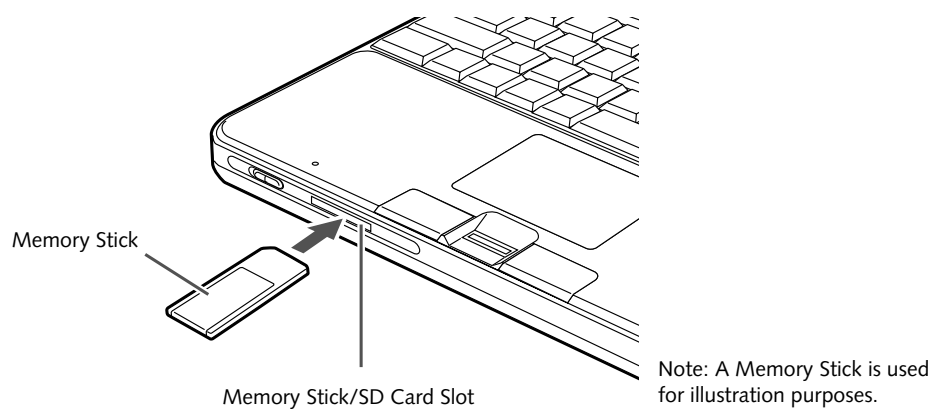
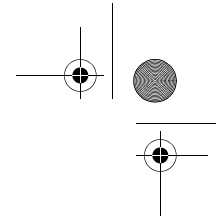

Figure 4-13. Installing a Memory Stick/SD Card

Memory Stick/ Secure Digital Slot

Your LifeBook notebook supports the following memory cards, on which you can store and transfer data to and from a variety of digital devices. These cards use flash memory architecture, which means they don't need a power source to retain data.

- SD Memory Card
- Memory Stick Media
- Memory Stick Select Media
- Memory Stick Duo Media
- Memory Stick PRO Media



- Some of the media in the above list may have more features than others.
- An adapter is required for Memory Stick Duo.
- Copyright Protection Technology cannot be used.
- MultiMedia Cards (MMC) and Secure MMC are not supported.

Memory Stick is a flash memory technology developed by Sony Electronics. Memory Stick allows you to record, transfer and share digital content, such as digital pictures, movies, music, voice, and computer data and applications.

Secure Digital (SD) Cards are very similar to Memory Sticks, but they are shorter. Like the Memory Stick, SD Cards allow portable storage among a variety of devices, such as cell phones, GPS systems, digital cameras, and PDAs. SD Cards transfer data quickly, with low battery

consumption. Like the memory stick, it uses flash memory architecture.

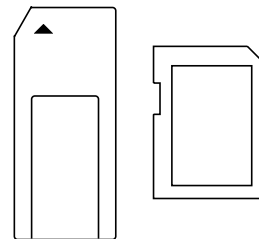

Figure 4-14. Memory Stick and Secure Digital Card

INSTALLING MEMORY STICK/SD CARDS

Memory Sticks and SD Cards are installed in the Memory Stick/SD Card slot (Figure 4-13). To install a Memory Stick or SD Card, follow these steps:



- Installing or removing a Memory Stick or SD Card during your LifeBook notebook's shutdown or bootup process may damage the card and/or your LifeBook notebook.
- Do not insert a card into a slot if there is water or any other substance on the card as you may permanently damage the card, your LifeBook notebook, or both.

1. See your Memory Stick or SD Card manual for instructions on the installation of your card. Some cards may require that your notebook is off while installing them.
2. Make sure there is no card currently in the slot. If there is, see Removing a Memory Stick/SD Card.



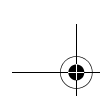

Memory Stick/SD Card

3. Insert your PC Card into the slot with the product label facing up.
4. Push the card firmly into the slot until it is seated in the connector.

REMOVING A MEMORY STICK/SD CARD

To remove a Memory Stick or SD Card, follow these easy steps:



See your Memory Stick or SD Card manual for specific instructions on the removal of your card. Some cards may require your LifeBook notebook to be in Suspend Mode or Off while removing them.

Push the Memory Stick or SD Card in until it unlatches. It will then eject from the slot for removal.

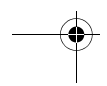
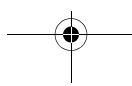
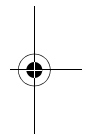
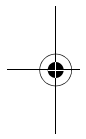

Memory Upgrade Module

Your LifeBook notebook can be upgraded to include up to 1 GB of in-slot high speed Double Data Rate (DDR) Synchronous Dynamic RAM (SDRAM). To increase your LifeBook notebook's memory capacity, you may install a larger memory upgrade module.

Your LifeBook notebook has two micro DIMM slots. If you have less than 1 GB pre-installed, and you would like to increase it, you will need to remove the installed module and replace it with the larger module or add a new module to an empty slot. The memory upgrade must be a dual-in-line (micro DIMM) SDRAM module. To ensure 100% compatibility, purchase the memory module only from the Fujitsu web store at us.fujitsu.com/computers.



The memory upgrade module can be severely damaged by electrostatic discharge (ESD). Be sure you are properly grounded when handling and installing the module.

ACCESSING THE MEMORY COMPARTMENT

To gain access to the memory compartment, follow these steps:



You must turn off power and remove any modem connection before installing the memory upgrade module.

1. Turn off power to your LifeBook notebook, and remove any power adapter (AC or auto/airline), battery pack, and modem connection.
2. Place your LifeBook notebook with the bottom facing up on a clean work surface.
3. Remove the two screws from the holes in the memory compartment cover. (Figure 4-15)

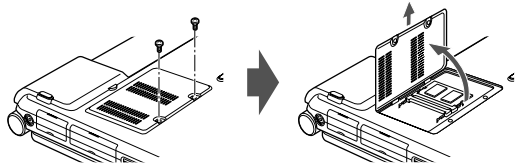

Figure 4-15. Removing screws from memory compartment cover



There is already a memory module pre-installed when you receive your system. In order to increase the memory, you must first remove the old memory chip.

REMOVING A MEMORY MODULE

1. Perform steps 1 through 3 of Accessing the Memory Compartment.
2. Pull the module clips sideways away from each side of the memory module simultaneously. (Figure 4-16)

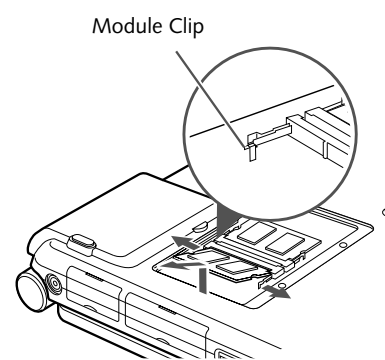

Figure 4-16. Removing a memory module

3. While holding the clips out, remove the module from the slot by lifting it up and pulling towards the back of your LifeBook notebook.
4. Store the memory upgrade module in a static guarded sleeve.
5. Install a new memory module as detailed in the procedure below.
6. Replace the memory compartment cover.

INSTALLING A MEMORY MODULE

1. Align the connector edge of the memory upgrade module, chip side up, with the connector slot in the compartment. (Figure 4-17)

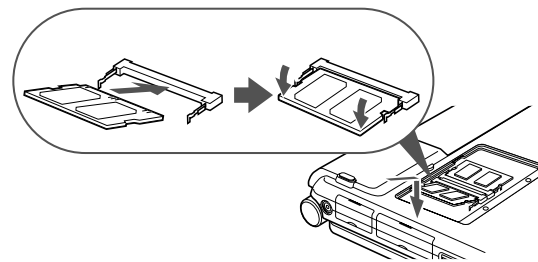
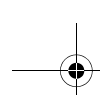

Figure 4-17. Installing a memory module

2. Insert the memory upgrade module at a 45° angle and press it firmly onto the connector.
3. Press the memory upgrade module down into the compartment until it locks underneath the retaining clip. You will hear a click when it is properly in place. (Figure 4-17)



The memory upgrade module is not something you routinely remove from your LifeBook notebook. Once it is installed, you should leave it in place unless you want to increase system memory capacity.

CHECKING THE MEMORY CAPACITY

Once you have changed the system memory capacity by replacing the installed module with a larger one, be sure to check that your notebook has recognized the change.

Check the memory capacity by clicking [Start] -> Settings -> Control Panel, then double-clicking the System icon. Select the General tab and check the amount of memory under "Computer:".

There may be a variation between the actual memory size and what is displayed. This is due to the fact that your system uses a video graphics chip which dynamically allocates system memory to accelerate graphics performance. Up to 64 MB of memory is dynamically shared on an as-needed basis using Dynamic Video Memory Technology (DVMT).



If the total memory displayed is incorrect, check that your memory upgrade module is properly installed. *(If the module is properly installed and the capacity is still not correctly recognized, see Troubleshooting on page 67.*

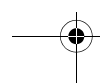

Device Ports

Your Fujitsu LifeBook notebook comes equipped with multiple ports to which you can connect external devices such as disk drives, keyboards, printers, etc.

MODEM (RJ-11) TELEPHONE PORT

The modem (RJ-11) telephone port is used for an internal modem. To connect the telephone cable follow these easy steps:

1. Align the connector with the port opening (Figure 4-18).
2. Push the connector into the port until it is seated.
3. Plug the other end of the telephone cable into a telephone outlet.

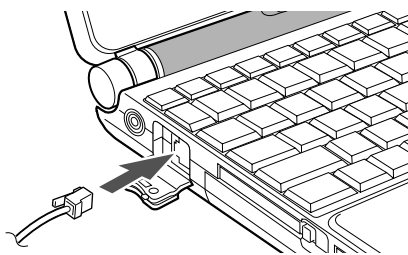

Figure 4-18 Modem Port

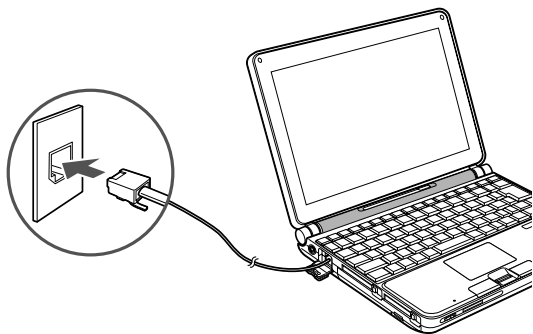

Figure 4-19 Connecting the Modem

The modem sound is deactivated by default, to activate modem sound follow these easy steps:

1. Right click on the Speaker icon in your system tray.
2. Select **Open Volume**.
3. Select **Option/Properties**.
4. Under "Show the following volume controls", click on **Phone** and click **OK**.
5. Uncheck the Mute box under Phone Balance.

The internal modem is not intended for use with Digital PBX systems. Do not connect the internal modem to a Digital PBX as it may cause serious damage to the internal modem or your entire LifeBook notebook. Consult your PBX manufacturer's documentation for details. Some hotels have Digital PBX systems. Be sure to find out **BEFORE** you connect your modem.



- The internal modem is designed to the ITU-T V.90 standard. Its maximum speed of 53000bps is the highest allowed by FCC, and its actual connection rate depends on the line conditions. The maximum speed is 33600bps at upload.
- The internal modem on all Fujitsu LifeBook notebooks are registered for use in the United States and Canada. The modem may be certified in other countries.

INTERNAL LAN (RJ-45) PORT

The internal LAN (RJ-45) port is used for an internal Fast Ethernet (10/100 Base-T/Tx) connection. If your notebook has been configured with internal LAN capability you will need to configure your notebook to work with your particular network. (Please refer to your network administrator for information on your network configuration.) To connect the LAN cable follow these easy steps:

1. Open the protective cover on the right side of the system (Figure 4-20).
2. Align the connector with the port opening.
3. Push the connector into the port until it is seated.
4. Plug the other end of the cable into a LAN outlet.

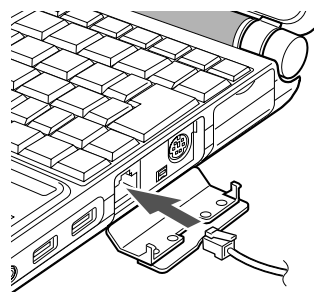
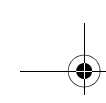

Figure 4-20 LAN Port



User Installable Features

IEEE 1394 PORT

The IEEE 1394 port (also known as “Firewire” or “iLink”) allows you to connect devices that are compliant with IEEE standard 1394. This port is effectively a very fast communications port. Some digital devices - such as digital cameras - use IEEE 1394 ports for fast transfer of digital files and data.

In order to connect an IEEE 1394 device, follow these steps:

1. Open the protective cover on the right side of the system (Figure 4-21).
2. Align the connector with the port opening.
3. Push the connector into the port until it is seated.

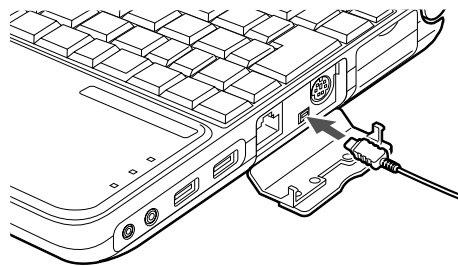

Figure 4-21 IEEE 1394 Port

S-VIDEO OUT PORT (TV OUT)

The S-Video port allows you to connect and use directly any S-Video device, such as a VCR or television. The S-Video standard provides for a higher quality picture than NTSC or PAL. In order to connect an S-Video device, follow these easy steps:

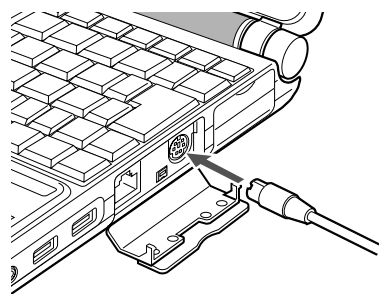

Figure 4-22 S-Video Out Port

1. Open the protective cover on the right side of the system (Figure 4-22).
2. Align the connector with the port opening.
3. Push the connector into the port until it is seated.

UNIVERSAL SERIAL BUS PORTS

The Universal Serial Bus 2.0 ports allow you to connect USB devices such as external game pads, pointing devices, keyboards and/or speakers. USB 2.0 is much faster than USB 1.1 (Its 480Mbps transfer rate is 40 times faster than that of USB 1.1). USB 2.0 ports are backward-compatible to work with USB 1.1 devices.

In order to connect a USB device follow these easy steps:

1. Align the connector with the port opening.
2. Push the connector into the port until it is seated.

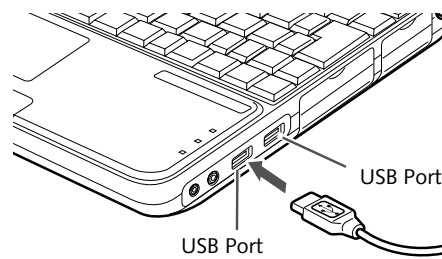

Figure 4-23 USB Ports

HEADPHONE JACK

The headphone allows you to connect headphones or powered external speakers to your notebook. Your headphones or speakers must be equipped with a 1/8” (3.5 mm) stereo mini-plug. In order to connect headphones or speakers follow these easy steps:



The headphone and optical digital audio out share the same jack.

1. Align the connector with the port opening.

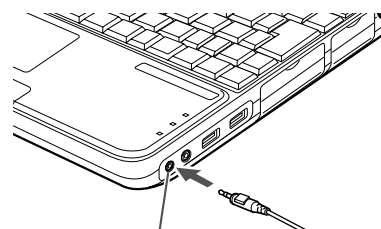

Headphone/Optical Digital Audio Out Jack

Figure 4-24 Headphone/Optical Digital Audio Out Jack

2. Push the connector into the port until it is seated.



If you plug headphones into the headphone jack, the built-in stereo speakers will be disabled.

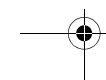
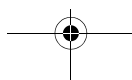

OPTICAL DIGITAL AUDIO CONNECTOR

The optical digital audio-out connector allows you to download digital audio to MiniDisc recorders. It uses SPDIF (Sony Philips Digital Interface) format. Use the following setting when using the digital audio-out connector.



- When headphones or a SPDIF cable is installed, the speakers are disabled.
- Before using the SPDIF function, make sure that WinDVD software is installed on your system.
- Certain older CDs and DVDs will not work in conjunction with the SPDIF connector.

1. Connect the MiniDisc recorder or external speaker to the Optical Digital Audio-Out Connector. (Figure 4-24)
2. Insert the disk you want to play in the DVD/CD-RW tray.
3. Click on **Start -> Programs -> InterVideo WinDVD**. (In Windows XP systems, you can go directly from **Start** to **InterVideo WinDVD**.)
4. When the WinDVD interface appears, right-click in the WinDVD window and select [Setup] from the menu.
5. Click on the **Audio** tab and select **Enable S/PDIF output**.
6. Click [Apply].



- The frequency of the digital sound output from the SPDIF output connector is fixed to 48KHz. If a sampling rate convertor is not installed in your connecting digital electronic device (e.g., MD player), recording is not possible. Please see the user manuals for the electronic devices for further details.
- The sound recorded through connecting a digital electronic device (e.g., MD player) to the SPDIF output connector cannot be used as digital output. All output data from the SPDIF output connector has copyright protection information included.
- Please be careful, as there are several types of cables for connecting a digital electronic device (e.g., MD player) to the digital audio-out connector, depending on the connector type. The connector on your computer is an Optical Mini Plug (3.5mm diameter mini plug)

MICROPHONE JACK

The microphone jack allows you to connect an external mono microphone. Your microphone must be equipped with a 1/8" (3.5 mm) mono mini-plug in order to fit into the microphone jack of your notebook. In order to connect a microphone follow these easy steps:

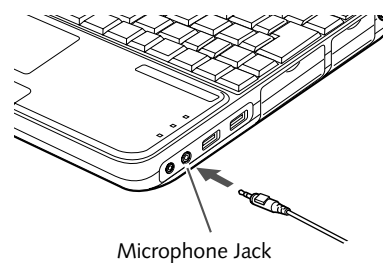

Figure 4-25 Microphone jack

1. Align the connector with the port opening (Figure 4-25).
2. Push the connector into the port until it is seated.

EXTERNAL MONITOR PORT

The external monitor port allows you to connect an external monitor. In order to connect a monitor follow these easy steps:

1. Open the protective cover on the right side of the system (Figure 4-26).
2. Align the connector with the port opening.
3. Push the connector into the port until it is seated.

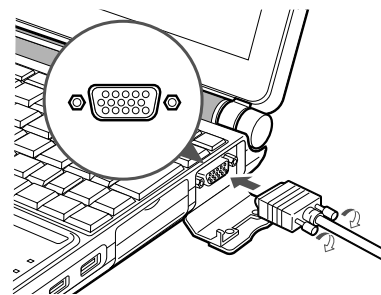
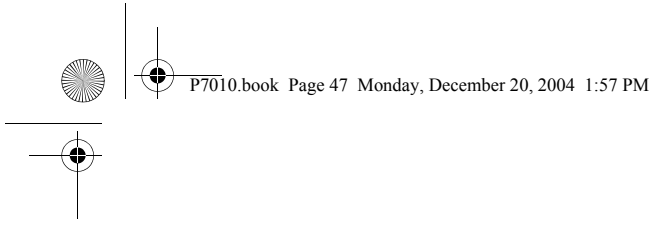

Figure 4-26 Installing the External Monitor Cable



Pressing the [Fn] + [F10] keys allows you to change your selection of where to send your display video. Each time you press the key combination, you will step to the next choice, starting with the built-in display panel only, moving to the external monitor only, finally moving to both the built-in display panel and an external monitor.



5

Using the Integrated Wireless LAN

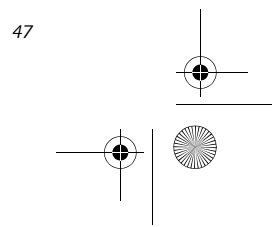
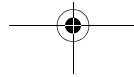
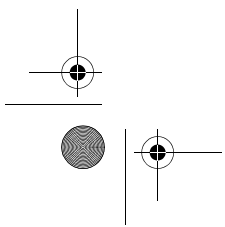
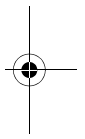
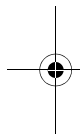

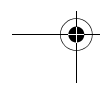
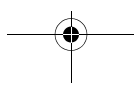
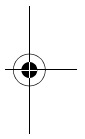
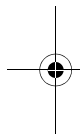
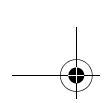

FC FCC REGULATORY INFORMATION

Please note the following regulatory information related to the wireless LAN device.

Regulatory Notes and Statements **Wireless LAN, Health and Authorization for use**

Radio frequency electromagnetic energy is emitted from Wireless LAN devices. The energy levels of these emissions, however, are far much less than the electromagnetic energy emissions from wireless devices such as mobile phones. Wireless LAN devices are safe for use by consumers because they operate within the guidelines found in radio frequency safety standards and recommendations. The use of Wireless LAN devices may be restricted in some situations or environments, such as:

- On board an airplane, or
- In an explosive environment, or
- In situations where the interference risk to other devices or services is perceived or identified as harmful.

In cases in which the policy regarding use of Wireless LAN devices in specific environments is not clear (e.g., airports, hospitals, chemical/oil/gas industrial plants, private buildings), obtain authorization to use these devices prior to operating the equipment.

Regulatory Information/Disclaimers

Installation and use of this Wireless LAN device must be in strict accordance with the instructions included in the user documentation provided with the product. Any changes or modifications made to this device that are not expressly approved by the manufacturer may void the user's authority to operate the equipment. The manufacturer is not responsible for any radio or television interference caused by unauthorized modification of this device, or the substitution or attachment of connecting cables and equipment other than those specified by the manufacturer. It is the responsibility of the user to correct any interference caused by such unauthorized modification, substitution or attachment. The manufacturer and its authorized resellers or distributors will assume no liability for any damage or violation of government regulations arising from failure to comply with these guidelines.

This device must not be co-located or operating in conjunction with any other antenna or transmitter.

For Atheros and Intel PRO Set Wireless LAN:
In accordance with 47 CFR Part 15.407(e) U-NII devices operating 5.15 - 5.25GHz frequency bands are restricted to indoor operations only.

Federal Communications Commission statement

This device complies with Part 15 of FCC Rules.

Operation is subject to the following two conditions: (1) This device may not cause interference, and, (2) This device must accept any interference, including interference that may cause undesired operation of this device.

FCC Interference Statement

This equipment has been tested and found to comply with the limits for a Class B digital device, pursuant to Part 15 of the FCC Rules. These limits are designed to provide reasonable protection against harmful interference in a residential installation. This equipment generates, uses, and can radiate radio frequency energy. If not installed and used in accordance with

the instructions, it may cause harmful interference to radio communications. However, there is no guarantee that interference will not occur in a particular installation.

If this equipment does cause harmful interference to radio or television reception, which can be determined by turning the equipment off and on, the user is encouraged to try and correct the interference by one or more of the following measures:

1. Reorient or relocate the receiving antenna.
2. Increase the distance between the equipment and the receiver.
3. Connect the equipment to an outlet on a circuit different from the one the receiver is connected to.
4. Consult the dealer or an experienced radio/TV technician for help.

FCC Radio Frequency Exposure statement

The available scientific evidence does not show that any health problems are associated with using low power wireless devices. There is no proof, however, that these low power wireless devices are absolutely safe. Low power Wireless devices emit low levels of radio frequency energy (RF) in the microwave range while being used. Whereas high level of RF can produce health effects (by heating tissue), exposure to low-level RF that does not produce heating effects causes no known adverse health effects. Many studies of low-level RF exposure have not found any biological effects. Some studies have suggested that some biological effects might occur, but such findings have not been confirmed by additional research. This wireless LAN radio device has been tested and found to comply with FCC radiation exposure limits set forth for an uncontrolled environment and meets the FCC radio frequency (RF) Exposure Guidelines in Supplement C to OET65.

The maximum SAR value measured from the devices are:

- 2.4GHz-band: 0.182 [W/kg]
- 5.25GHz-band: 1.35[W/kg]
- 5.8GHz-band: 0.794[W/kg] at Body

Export restrictions

This product or software contains encryption code which may not be exported or transferred from the US or Canada without an approved US Department of Commerce export license. This device complies with Part 15 of FCC Rules, as well as ICES 003 B / NMB 003 B. Operation is subject to the following two conditions: (1) this device may not cause harmful interference, and (2) this device must accept any interference received, including interference that may cause undesirable operation. Modifications not expressly authorized by Fujitsu Computer Systems Corporation may invalidate the user's right to operate this equipment.

Canadian Notice

To prevent radio interference to the licensed service, this device is intended to be operated indoors and away from windows to provide maximum shielding. Equipment (or its transmit antenna) that is installed outdoors is subject to licensing.

High power radars are allocated as primary users of 5250-5350 MHz and 5650 - 5850 MHz and these radars could cause interference and/or damage to LELAN (license-exempt LAN) devices operating in these bands.

Before Using the Wireless LAN

This manual describes the procedures required to properly setup and configure the integrated Wireless LAN Mini-PCI device (referred to as "WLAN device" in the rest of the manual). Before using the WLAN device, read this manual carefully to ensure it's correct operation. Keep this manual in a safe place for future reference.

Wireless LAN Devices Covered by this Document

This document is applicable to systems containing one of the following three devices. Most of the procedures are identical. Sections that differ between the devices have been noted in the text:

- Intel PRO/Wireless 2200BG Network Connections (802.11b/g): Available on LifeBook P7010 notebook model
- Intel PRO/Wireless 2915ABG Network Connections (802.11a+b/g): Available on LifeBook P7010 notebook model
- Atheros AR5002X Mini-PCI wireless network card (802.11a + b/g): Available on LifeBook P7010D notebook model

Characteristics of the WLAN Device

- The WLAN device is a Mini-PCI card attached to the main board of the mobile computer.
- The WLAN devices operate in license-free RF bands, therefore eliminating the need to procure an FCC license to operate. All three WLAN devices operate in the 2.4GHz Industrial, Scientific, and Medical (ISM) RF band. Additionally, the Intel PRO/Wireless 2915ABG and Atheros AR5002X devices operate in the lower and middle bands of the 5GHz Unlicensed National Information Infrastructure (UNII) bands.
- The Intel PRO/Wireless 2200BG WLAN device is capable of two operating modes, IEEE802.11b and

IEEE802.11g. The Intel PRO/Wireless 2915ABG and Atheros AR5002X WLAN devices are capable of three operating modes, IEEE802.11a, IEEE802.11b and IEEE802.11g.

- Encoding of data is modulated using Direct Sequence Spread Spectrum (DSSS) and Complementary Code Keying (CCK) when the WLAN device is operating in IEEE 802.11b mode and Orthogonal Frequency Division Multiplexing (OFDM) when operating in IEEE802.11a or IEEE802.11g mode.
- The WLAN device is Wi-Fi certified and operates at the maximum data transfer rate of 54 Mbps in IEEE802.11a or IEEE802.11g mode and 11 Mbps in IEEE802.11b mode.
- The maximum communication range indoors is approximately 80 feet (25 meters). However, that range will increase or decrease depending on factors such as number of walls, reflective material, or interference from external RF sources.
- The WLAN device supports the following encryption methods - WEP, CKIP, TKIP, and AES encryption.

WIRELESS LAN MODES USING THIS DEVICE

Ad Hoc Mode

(See Figure 5-1)

"Ad Hoc Mode" refers to a wireless network architecture where wireless network connectivity between multiple computers is established without a central wireless network device, typically known as Access Point(s). Connectivity is accomplished using only client devices in a peer-to-peer fashion. That is why Ad Hoc networks are also known as peer-to-peer networks. Ad Hoc networks

Figure 5-1. Ad Hoc Mode Network

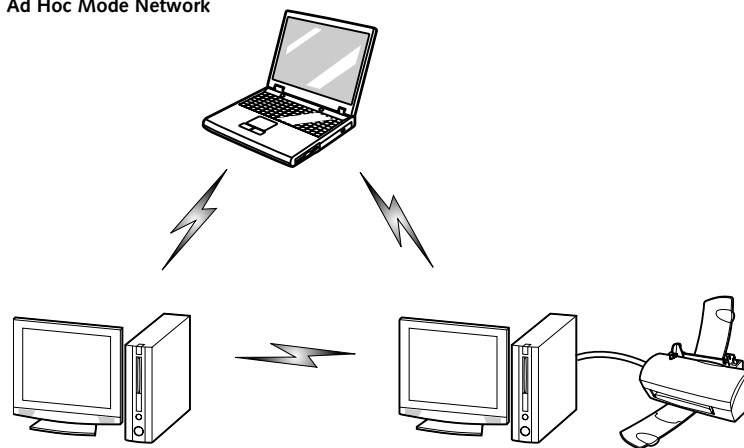

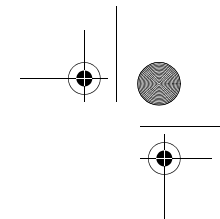

are an easy and inexpensive method for establishing network connectivity between multiple computers.

Ad Hoc mode requires that the SSID, network authentication, and encryption key settings are identically configured on all computers in the Ad Hoc network.

Access Point (Infrastructure) Mode

(See Figure 5-2)

Infrastructure mode refers to a wireless network architecture in which devices communicate with wireless or wired network devices by communicating through an Access Point. In infrastructure mode, wireless devices can communicate with each other or can communicate with a wired network. Corporate wireless networks operate in infrastructure mode because they require access to the wired LAN in order to access computers, devices, and services such as file servers, printers, and databases.

How to Handle This Device

The WLAN device comes pre-installed in your mobile computer. Under normal circumstances, it should not be necessary for you to remove or re-install it. The Operating System that your mobile computer comes with has been pre-configured to support the WLAN device.

WIRELESS NETWORK CONSIDERATIONS

- The Intel PRO/Wireless 2200BG WLAN device supports IEEE802.11b and IEEE802.11g. The Intel PRO/Wireless 2915ABG and Atheros AR5002X WLAN

devices support IEEE802.11a, IEEE802.11b and IEEE802.11g.

- The Intel PRO/Wireless 2200BG WLAN device operates in the 2.4GHz ISM band. The Intel PRO/Wireless 2915ABG and Atheros AR5002X WLAN devices operate in the 2.4GHz ISM band and the 5 GHz lower, middle, and upper UNII bands.
- The maximum range of the WLAN device indoors is typically 80 feet (25 meters). Please note that the maximum range you achieve may be shorter or longer than 80 feet, depending on factors such as access point transmit power, number and density of obstructions, or external RF interference.
- Microwave ovens will interfere with the operation of WLAN device as microwave ovens operate in the same 2.4GHz frequency range that IEEE802.11b/g devices operate in. Interference by microwaves does not occur with IEEE802.11a radio which operates in the 5 GHz RF band.
- Wireless devices that transmit in the 2.4GHz frequency range may interfere with the operation of WLAN devices in IEEE802.11b/g modes. Symptoms of interference include reduced throughput, intermittent disconnects, and large amounts of frame errors. It is HIGHLY recommended that these interfering devices be powered off to ensure the proper operation of the WLAN device.

Figure 5-2. Access Point (Infrastructure) Mode Network

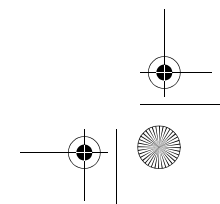
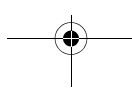
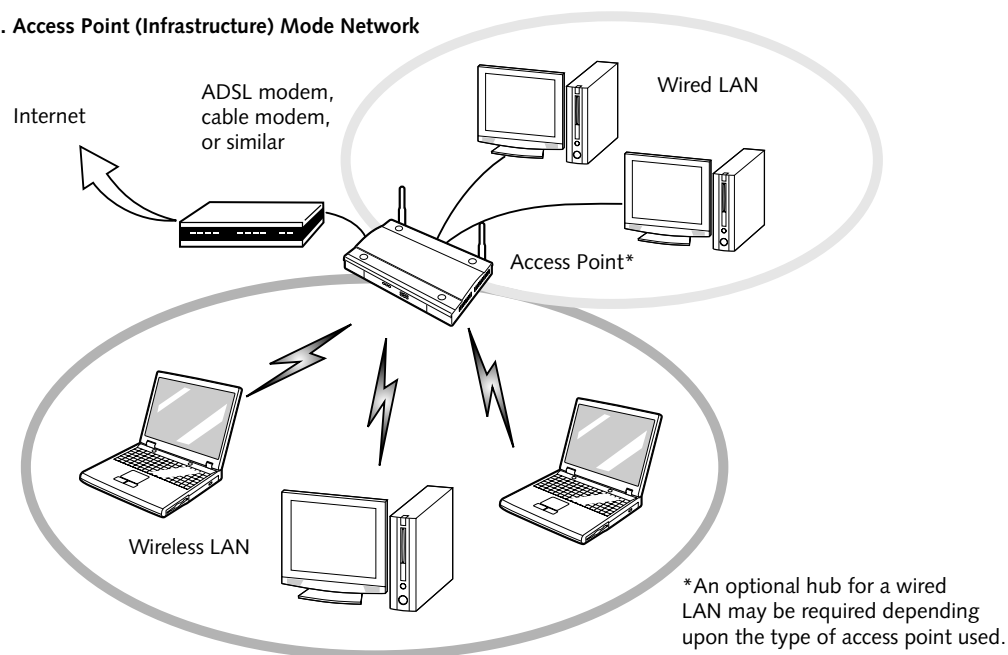

DEACTIVATING THE WLAN DEVICE

Deactivation of the WLAN device may be desired in certain circumstances (to extend battery life) or where certain environments require it (i.e. hospitals, clinics, airplanes, etc.). Fujitsu mobile computers employ two methods with which to deactivate the WLAN device:

- Using the Wireless On/Off Switch
- In Windows, using the Intel PROSet Software or Atheros Client Utility software.

Deactivation using the Wireless On/Off Switch

The WLAN device can be deactivated quickly and efficiently by toggling the Wireless On/Off Switch to the Off position. (Figure 5-3)

The Wireless On/Off switch has no effect on non-Wireless LAN models.

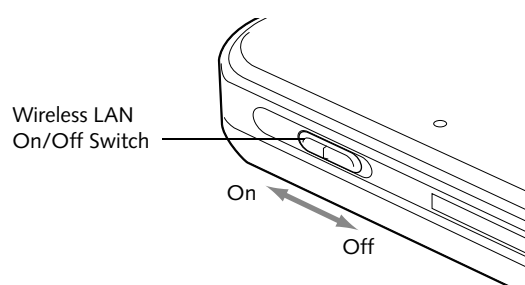

Figure 5-3. Wireless LAN On/Off Switch Location

Deactivation using the Intel PROSet Software

The WLAN device can also be deactivated in Windows using the Intel PROSet Software. The procedure to accomplish this:

1. Click [Start]-> [All Programs].
2. Select Intel ProSet Wireless, then click on Intel ProSet Wireless from the menu that appears. The Intel ProSet Wireless utility will be displayed.
3. At the bottom left corner of the window, select Wireless Off from the dropdown list.

Deactivation using Atheros Client Utility software

1. Right-click on Atheros Client Utility icon in the system tray. Select "Open Atheros Client Utility" from the menu.
2. Choose Action and click Disable Radio.

ACTIVATING THE WLAN DEVICE

Activation of the WLAN device can be accomplished using the same methods as the deactivation process

- Using the Wireless On/Off Switch
- In Windows using the Intel PROSet Software or Atheros Software

Configuration of the WLAN Device

The WLAN Device can be configured to establish wireless network connectivity using one of the following tools:

- **Intel PROSet Software** - The Intel PROSet Software allows for multiple profile setup and supports automatic profile switching. Support for most industry standard security solutions is contained in this software.
- **Atheros Client Utility** - The Atheros Client Utility software allows for multiple profile setups and supports automatic profile switching. Support for most industry standard security solutions is contained in this software.

FLOW OF OPERATIONS

1. Activate the WLAN Device (See Activating the WLAN Device on page 52 for more information).
2. Configure the Wireless Network parameters (See Configure Wireless Network Parameters on page 53 for more information).
 - Enter the network name (SSID)
 - Choose the appropriate WLAN architecture (Ad Hoc or Infrastructure)
 - Choose Authentication method: Open, Shared, WPA-Enterprise, WPA2-Enterprise, WPA-Personal, or WPA2-Personal
 - If using static WEP keys, enter static WEP key and choose key index.
3. Configure network settings (See Configure Network Parameters on page 53 for more information)
 - TCP/IP settings
 - Workgroup or Domain settings.

CONFIGURATION USING INTEL PROSET SOFTWARE

This section explains the procedure to properly configure the WLAN device using the Intel PROSet Software. Pre-defined parameters will be required for this procedure. Please consult with your network administrator for these parameters:

Network Name - Also known as the SSID

Network Key (WEP) - Required if using static WEP keys.

Authentication Type - Open, Shared, WPA, or WPA-PSK

Procedure

1. Activate the WLAN device using either the Wireless On/Off Switch or the Intel PROSet software.
2. Click the [Start] button first and then [All Programs].
3. Click the icon [Intel PROSet Wireless] to execute the Intel PROSet Wireless software.
4. Click the [Add] button. The General Settings dialog displays.
5. Enter a profile name in the Profile Name field.
6. Enter the network SSID, in the Network Name (SSID) field.
7. Click Infrastructure or Ad Hoc for the operating mode.
8. Click [Advanced].
9. The Mandatory Access Point option is only used if Infrastructure mode is selected. Use this option to connect to a specific access point. Enter the MAC address for the access point. Click OK to save the setting and return to the General Settings page.
10. Click [Next].
11. If you are using Cisco CCX, click Cisco Options to enable Cisco CKIP data encryption on the Security Settings page. Check the Cisco Compatible Extensions Options. If you have checked the Cisco's "Mixed-Cell" box in the Advanced Setting, this option must also be checked.
12. Click [OK].
13. Click Next.
14. Select Open, Shared, WPA-Enterprise, WPA2-Enterprise, WPA-Personal, or WPA2-Personal in the Network Authentication options.
15. Select either None, WEP, CKIP (if Enable Cisco Client eXtensions is enabled, use CKIP or WEP), or TKIP for the data encryption.
16. If WEP is selected, select either 64 or 128-bit for the Encryption Level.
17. Select the key index 1, 2, 3 or 4.
18. Enter the WEP key if required. If your network does not employ a 802.1x/EAP security mechanism, please skip to step 24.

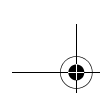

19. Click the Enable 802.1x checkbox to enable the 802.1x security option. Please contact your network administrator if configuration of this setting is required.
20. Select the appropriate Authentication Type. Please contact your network administrator if configuration of this setting is required.
21. After selecting your authentication type, enter the user name, domain, and password of the user you have created on the authentication server. The user name and password do not have to be the same as name and password of your current Windows user login.
22. Click [OK] to save the settings.
23. From the Intel ProSet Wireless page, click the new profile name shown in the Profile List. Use the up and down arrows to position the priority of the new profile in the priority list.
24. Click the Connect button to connect to the network.
25. Click [Close] if you want to close the Intel(R) PROSet for Wireless window.
5. From the General page, enter a profile name in the Profile Name field.
6. Enter the network SSID, in the SSID1 field. If you wish to create a profile that can connect to up to 3 different wireless networks, SSID's can be entered in the SSID2 and SSID3 fields as well.
7. Click the Security tab.
8. The Security tab allows for the configuration of the Security modes listed in the table below. Please select the radio button of the desired security mode. If these settings are not known to you, please consult with your network administrator for the correct settings.

Field Name	Description
WPA	Enables the use of Wi-Fi Protected Access. Choosing WPA opens the WPA EAP drop-down menu. Options include TLS and PEAP. If these settings are not known to you, please consult with your network administrator for the correct settings.
WPA-PSK	Enables WPA-Pre-Shared Key. Click on the Configure button to enter the WPA Passphrase. If these settings are not known to you, please consult with your network administrator for the correct settings.
802.1x	Enables 802.1x security. If these settings are not known to you, please consult with your network administrator for the correct settings. Choosing this option opens the 802.1x EAP type drop-down menu. Options include TLS, PEAP, and LEAP
Pre-Shared Key	Enables the use of pre-shared keys that are defined on both the access point and the station. This is where static WEP keys are entered. Click the Configure button to fill in the Define Pre-Shared Keys window.
None	No security

CONFIGURATION USING ATHEROS CLIENT UTILITY SOFTWARE

This section explains the procedure to properly configure the WLAN device using the Atheros Client Utility. Pre-defined parameters will be required for this procedure. Please consult with your network administrator for these parameters:

Network Name - Also known as the SSID

Network Key (WEP) - Required if using static WEP keys.

Authentication Type - Open, Shared, WPA, or WPA-PSK

Procedure

1. Activate the WLAN device using either the Wireless On/Off Switch or the Atheros Client Utility
2. Right-click on the "Atheros Client Utility" icon in the system tray, and select "Open Atheros Client Utility" from the menu.
3. From the Current Status page, click the Profile Management tab.
4. If this is your first time using this utility, highlight the profile [Default] and Click the [Modify] button, otherwise Click the [New] button. The General Settings dialog displays.

9. Click OK
10. Click the Advanced tab
11. The Advanced tab allows for the configuration of the options detailed in the table below.

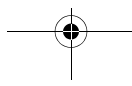



Field Name	Description
Power Save Mode	Options are Maximum, Normal, or Off
Network Type	Options are AP (Infrastructure) or Ad Hoc
802.11b Preamble	Specifies the preamble setting in 802.11b. The default setting is Short and Long (Access Point mode), which allows both short and long headers in the 802.11b frames. Set to Long Only to override allowing short frames.
Transmit Power Level	Options are 100%, 50%, 25%, 12.5% or Lowest transmit power (0mW)
Wireless Mode	Specifies 5 GHz 54 Mbps, 5 GHz 108 Mbps, 2.4 GHz 11 Mbps, or 2.4 GHz 54 Mbps operation in an access point network.
Wireless Mode when Starting Ad Hoc Network	Specifies 5GHz 54 Mbps, 5 GHz 108 Mbps, 2.4 GHz 11 Mbps, or 2.4 GHz 54 Mbps to start an Ad Hoc network if no matching network name is found after scanning all available modes.

12. Click OK
13. If the profile you just created does not activate immediately, click the Profile Management tab, highlight the desired Profile, and click Activate.
14. Click [Close] if you want to close the Atheros Client Utility.

CONNECTION TO THE NETWORK

This section explains connection to the network.

If there is an administrator of the network, contact the network administrator for data settings.

Setting the network

Perform the "Setting TCP/IP" and "Confirming the computer and work group names" operations required for network connection.

Setting TCP/IP



To change the setting of the IP address, you need to be logged in from Windows as an administrator.

1. Click the [Start] button first and then [Control Panel].

2. If the Control Panel is in Category view, switch to Classic view by clicking "Switch to Classic View" under Control Panel the left frame. (If you are already in Classic view, "Switch to Category View" will be displayed.)
3. Double-click [Network Connections]. A list of currently installed networks will be displayed.
4. Right-click [Wireless Network Connection] in the list, and then click [Properties] in the menu displayed. The [Wireless Network Connection Properties] window will be displayed.
5. Click the [General] tab if it is not already selected.
6. Click [Internet Protocol (TCP/IP)] and then click [Properties]. The [Internet Protocol (TCP/IP) Properties] window will be displayed.
7. Set the IP address as follows:
 - **For ad hoc connection:** Select [Use the following IP address:] and then enter data for [IP address] and [Subnet mask]. See page 62 for IP address setting.
 - **For access point (infrastructure) connection:** If your network uses DHCP, select [Obtain an IP address automatically] and [Obtain DNS server address automatically]. If your network uses static IP addresses, consult with your network administrator for the correct IP address settings.
8. Click the [OK] button. Processing will return to the [Wireless Network Connection Properties] window.
9. Click the [OK] button.
10. Close the [Network Connection] window.

Following this operation, confirm the names of the computer and the workgroup as follows.

Confirming the computer and work group names



To modify the computer name and/or the work group name, you need to be logged in from Windows as an administrator.

1. Click the [Start] button, then [Control Panel].
2. If the Control Panel is in Category view, switch to Classic view by clicking "Switch to Classic View" under Control Panel the left frame. (If you are already in Classic view, "Switch to Category View" will be displayed.)
3. Double-click the [System] icon. The [System Properties] window will be displayed.
4. Click the [Computer Name] tab.





5. Confirm the settings of [Full computer name:] and [Workgroup:].
 - a. The setting of [Full computer name:] denotes the name for identifying the computer. Any name can be assigned for each personal computer.



To change the name, click [Change] and then proceed in accordance with the instruction messages displayed on the screen.

Enter the desired name in less than 15 ASCII character code format. Identifiability can be enhanced by entering the model number, the user name, and other factors.

- b. [Workgroup name] is the group name of the network. Enter the desired name in less than 15 ASCII character code format.

For ad hoc connection: Assign the same network name to all personal computers existing on the network.

For access point (infrastructure) connection: Assign the name of the work group to be accessed.

6. Click the [OK] button. If a message is displayed that requests you to restart the personal computer, click [Yes] to restart the computer.

Setting the sharing function

Set the sharing function to make file and/or printer sharing with other network-connected personal computers valid.

This operation is not required unless the sharing function is to be used.

The folder and printer for which the sharing function has been set will be usable from any personal computer present on the network.



To share a file and/or the connected printer, you need to be logged in as an administrator.

Setting the Microsoft network-sharing service

1. Click the [Start] button first and then [Control Panel].
2. If the Control Panel is in Category view, switch to Classic view by clicking "Switch to Classic View" under Control Panel the left frame. (If you are already in Classic view, "Switch to Category View" will be displayed.)

3. Double-click [Network Connections]. A list of currently installed networks will be displayed.
4. Right-click [Wireless Network Connection] in the list, and then click [Properties] in the menu displayed. The [Wireless Network Connection Properties] window will be displayed.
5. If [File and Printer Sharing for Microsoft Networks] is displayed, proceed to step 6. If [File and Printer Sharing for Microsoft Networks] is not displayed, skip to step 7.
6. Make sure that the [File and Printer Sharing for Microsoft Networks] check box is checked, and then click the [OK] button. Skip to "Setting file-sharing function".
7. Click [Install]. The [Select Network Component Type] window will be displayed.
8. Click [Service], then click the [Add] button. The [Select Network Service] window will be displayed.
9. Click [File and Printer Sharing for Microsoft Networks] and then click the [OK] button. Processing will return to the [Wireless Network Connection Properties] window, and [File and Printer Sharing for Microsoft Networks] will be added to the list.
10. Click the [Close] button.

Setting the file-sharing function

The procedure for setting the file-sharing function follows, with the "work" folder in drive C: as an example.

1. Click the [Start] button first and then [My Computer].
2. Double-click [Local disk (C:)].
3. Right-click the "work" folder (or whichever folder you want to share), and then click [Sharing and Security...] in the menu displayed. The [Folder Name Properties] window will be displayed.



Setting the file-sharing function for the file which has been used to execute Network Setup Wizard is suggested on the screen. For the wireless LAN, however, since security is guaranteed by entry of the network name (SSID) and the network key, the steps to be taken to set the file-sharing function easily without using Network Setup Wizard are given below.

4. Click [Sharing] if it isn't already selected.

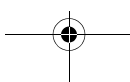

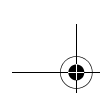

5. Click the link stating "If you understand the security risks, but want to share files without running the wizard, click here".
6. Click "Just enable file sharing" and click [OK].
7. Check the [Share this folder on the network] check box.



To specify the corresponding folder as a read-only folder, select the [Read only] checkbox under the General tab.

8. Click the [OK] button. The folder will be set as a sharable folder, and the display of the icon for the "work." folder will change.

Setting the printer-sharing function

1. Click the [Start] button first and then [Printers and FAX]. A list of connected printers will be displayed.
2. Right-click the printer for which the sharing function is to be set, and then click [Sharing] in the menu displayed. The property window corresponding to the selected printer will be displayed.



Setting the printer-sharing function when Network Setup Wizard has been executed is suggested on the screen. For the wireless LAN, however, since security is guaranteed by entry of the network name (SSID) and the network key, the steps to be taken to set the printer-sharing function without using Network Setup Wizard are laid down below.

3. Click the [Sharing] tab.
4. Click [Share this printer].
5. Enter the sharing printer name in [Share name].
6. Click the [OK] button.

Confirming connection

After you have finished the network setup operations, access the folder whose sharing has been set for other personal computers. Also, confirm the status of the radio waves in case of trouble such as a network connection failure.



In the case of access point (infrastructure) connection, enter the necessary data for the access point before confirming connection. Refer to the manual of the access point for the access point setup procedure.

Connecting your personal computer to another personal computer

1. Click [Start] first and then [My Computer]. The [My Computer] window will be displayed in the left frame.
2. Click [My Network Places] in the "Other Places" list. The window [My Network Places] will be displayed.
3. Click [View workgroup computers] under Network Tasks in the left frame.
4. Double-click the personal computer to which your personal computer is to be connected. The folder that was specified in "Setting the file-sharing function" on page 56 will be displayed.
5. Double-click the folder to be accessed.

Confirming the status of the radio

1. Right-click the Intel PRO Wireless icon in the lower right corner of the screen.
2. Click [Open Intel PROSet for Wireless]. The Intel PROSet for Wireless window opens.
3. Contained within the General tab and the Details section (accessed by pressing the [Details] button), you will find the current operating status of the radio. (When the radio is turned off or the computer is not yet connected, some of the conditions will not be displayed.)

- **Profile Name**
The current configuration profile is displayed.
- **Network Name (SSID)**
Displays the Network Name (SSID) currently used by the radio.
- **IP Address**
The IP address of the current profile.
- **Signal Quality**
Displays a message stating the current quality of the signal.
- **Signal Strength**
Displays a graphic representation of the current signal strength.

Additionally, in the lower section of the display, you will see a variety of different measurements related to the WLAN. For additional information about the items, click on the "Help?" button:

- Adapter MAC Address
- Band
- Supported Data Rates

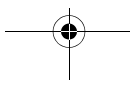

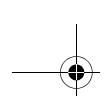

LifeBook P7000 Series Notebook - Section Five

- Radio Frequency
- Channel Number
- Network Authentication
- Data Encryption
- 802.1x Authentication Type
- 802.1x Authentication Protocol
- CCX Version
- CCX TPC
- CCX Power Levels
- Access Point MAC Address
- Mandatory Access Point

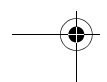
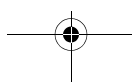
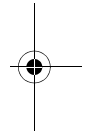
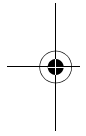

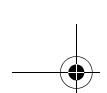

Troubleshooting

Causes and countermeasures for troubles you may encounter while using your wireless LAN are described in the following table.

Problem	Possible Cause	Possible Solution
Unavailable network connection	Incorrect network name (SSID) or network key	<p>Ad hoc connection: verify that the network names (SSID's) and network keys (WEP) of all computers to be connected have been configured correctly. SSID's and WEP key values must be identical on each machine.</p> <p>Access Point (Infrastructure) connection: set the network name (SSID) and network key to the same values as those of the access point.</p> <p>Set the Network Authentication value identically to that of the Access Point. Please consult your network administrator for this value, if necessary.</p> <p>For the method of setting network authentication, refer to the following page: "Assigning parameters" on page 53.</p>
	Weak received signal strength and/or link quality	<p>Ad hoc connection: Retry connection after shortening the distance to the destination computer or removing any obstacles for better sight.</p> <p>Access Point (Infrastructure) connection: Retry connection after shortening the distance to the access point or removing any obstacles for better sight.</p> <p>To check the wave condition, refer to the following page: "Confirming the status of the radio waves" on page 57.</p>
	The WLAN device has been deactivated or disabled	Check if the wireless switch is turned ON. Also verify "Disable Radio" is not checked in "Network setting" window. Refer to "Starting Transmission" on page 52.
	The computer to be connected is turned off	Check if the computer to be connected is turned ON.
	RF interference from Access Points or other wireless networks	The use of identical or overlapping RF channels can cause interference with the operation of the WLAN device. Change the channel of your Access Point to a channel that does not overlap with the interfering device.
	Wireless network authentication has failed	Re-check your Network Authentication, Encryption, and Security settings. Incorrectly configured security settings such as an incorrectly typed WEP key, a mis-configured LEAP username, or an incorrectly chosen authentication method will cause the LAN device to associate but not authenticate to the wireless network.
	Incorrectly configured network settings	Recheck the configuration of your network settings. For the method of checking, refer to the following page: "Connection to the Network" on page 55.
	Incorrect IP address configuration	This only applies to networks using static IP addresses. Please contact your network administrator for the correct settings.

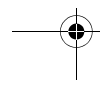
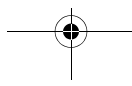
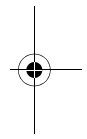
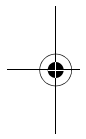

Wireless LAN Glossary

Ad Hoc Mode

Ad Hoc Mode refers to a wireless network architecture where wireless network connectivity between multiple computers is established without a central wireless network device, typically known as Access Points. Connectivity is accomplished using only client devices in a peer-to-peer fashion. For details, refer to "Ad hoc connection" on page 50.

Channel

Range of narrow-band frequencies used by the WLAN device to transmit data. IEEE802.11b/g - 11 channels, 22 MHz wide channels.

DHCP (Dynamic Host Configuration Protocol)

A protocol that provides a means to dynamically allocate IP addresses to computers on a local area network.

DNS (Domain Name System)

A data query service that provides a mechanism with which to translate host names into Internet addresses.

IEEE802.11a

Wireless LAN standard that supports a maximum data rate of 54 Mbps. 802.11a devices operate in the 5 GHz lower and middle UNII bands.

IEEE802.11b

Wireless LAN standard that supports a maximum data rate of 11 Mbps. 802.11b devices operate in the 2.4 GHz ISM band.

Access point

Wireless network device used to bridge wireless and wired network traffic.

IP address

The logical 32-bit host address defined by the Internet Protocol that uniquely identifies a computer on a network. The IP address is usually expressed in dotted decimal notation.

LAN (Local Area Network)

A LAN or Local Area Network is a computer network (or data communications network) which is confined to a limited geographical area.

MAC address (Media Access Control Address)

A MAC address (also called an Ethernet address or IEEE MAC address) is the 48-bit address (typically written as twelve hexadecimal digits, 0 through 9 and A through F, or as six hexadecimal numbers separated by periods or colons, e.g., 0080002012ef, 0:80:0:2:20:ef) which uniquely identifies a computer that has an Ethernet interface.

MTU (Maximum Transmission Unit)

The maximum size of data which can be transmitted at one time in networks including the Internet. In an environment whose maximum size of data is too large to correctly receive data, normal communications can be restored by setting the size of MTU to a smaller value.

Network key

Data that is used for encrypting data in data communication. The personal computer uses the same network key both for data encryption and decryption, therefore, it is necessary to set the same network key as the other side of communication.

Network name (SSID: Security Set Identifier)

When a wireless LAN network is configured, grouping is performed to avoid interference or data theft. This grouping is performed with "Network name (SSID)". In order to improve security, the network key is set allowing no communication unless "Network name (SSID)" coincides with the network key.

Open system authentication

Null authentication method specified in the 802.11 standard that performs no authentication checks on a wireless client before allowing it to associate.

PPPoE (Point to Point Protocol over Ethernet)

A method of allowing the authentication protocol adopted in telephone line connection (PPP) to be used over an Ethernet.

Protocol

A procedure or rule of delivering data among computers. Ordered data communication is allowed by making all conditions required for communication including the method of data transmission/reception and actions upon communication errors into procedures.



Shared key authentication

802.11 network authentication method in which the AP sends the client device a challenge text packet that the client must then encrypt with the correct WEP key and return to the AP. If the client has the wrong key or no key, authentication will fail and the client will not be allowed to associate with the AP. Shared key authentication is not considered secure, because a hacker who detects both the clear-text challenge and the same challenge encrypted with a WEP key can decipher the WEP key.

SSID (Service Set Identifier)

Service Set Identifier, a 32-character unique identifier attached to the header of packets sent over a WLAN that acts as a password when a mobile device tries to connect to the BSS. The SSID differentiates one WLAN from another, so all access points and all devices attempting to connect to a specific WLAN must use the same SSID. A device will not be permitted to join the BSS unless it can provide the unique SSID. Because the SSID is broadcast in plain text, it does not supply any security to the network.

Subnet mask

TCP/IP network is controlled by being divided into multiple smaller networks (subnets). IP address consists of the subnet address and the address of each computer. Subnet mask defines how many bits of IP address comprise the subnet address. The same value shall be set among computers communicating with each other.

TCP/IP (Transmission Control Protocol/Internet Protocol)

A standard protocol of the Internet.

Wi-Fi

Wi-Fi, or Wireless Fidelity, is a set of standards for wireless local area networks (WLAN) based on the IEEE 802.11 specifications. Certified products can use the official Wi-Fi logo, which indicates that the product is interoperable with any other product also showing that logo.

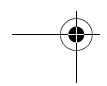
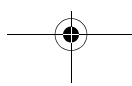
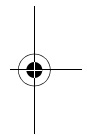
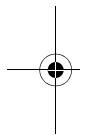

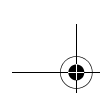

IP address information



IP addressing is much more complicated than can be briefly explained in this document. You are advised to consult with your network administrator for additional information.

If IP address is unknown, set IP address as follows:

If you have an access point (DHCP server) on the network, set the IP address as follows:

[Obtain an IP address automatically]



A DHCP server is a server that automatically assigns IP addresses to computers or other devices in the network. There is no DHCP server for the AdHoc network.

If the IP address is already assigned to the computer in the network, ask the network administrator to check the IP address to be set for the computer.

If no access point is found in the network:

An IP address is expressed with four values in the range between 1 and 255.

Set the each computer as follows: The value in parentheses is a subnet mask.

<Example>

Computer A: 192.168.100.2 (255.255.255.0)

Computer B: 192.168.100.3 (255.255.255.0)

Computer C: 192.168.100.4 (255.255.255.0)

:

:

Computer X: 192.168.100.254 (255.255.255.0)

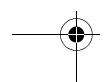
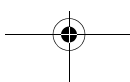
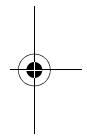
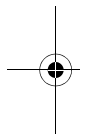

Specifications

Item	Specification
Type of network	The Atheros AR5002X and the Intel PRO/Wireless 2915ABG Network Connections WLAN devices conform to IEEE 802.11a and 802.11b/g (Wi-Fi based)*. The Intel PRO/Wireless 2200BG Network Connections WLAN device conforms to 802.11b/g (Wi-Fi based)
Transfer rate	(Automatic switching) IEEE 802.11a/g: 54 Mbps maximum data rate IEEE 802.11b: 11 Mbps maximum data rate
Active frequency	802.11b/g: 2400~2473 MHz 802.11a: 4900 ~ 5850 MHz
Number of channels	802.11a: 8 independent channels 802.11b/g: 11 channels, 3 non-overlapping channels
Security	Encryption Types - CKIP, WEP, TKIP, AES** WPA 1.0 compliant Encryption Keylengths Supported: 64 bits, 128 bits, and 152 bits (Atheros module using AES encryption only) 802.1x/EAP
Maximum recommended number of computers to be connected over wireless LAN (during ad hoc connection)	10 units or less ***

* "Wi-Fi based" indicates that the interconnectivity test of the organization which guarantees the interconnectivity of wireless LAN (Wi-Fi Alliance) has been passed.

** Encryption with network key (WEP) is performed using the above number of bits, however, users can set 40 bits/104 bits after subtracting the fixed length of 24 bits.

*** Depending on practical environments, the allowable number of computers to be connected may be decreased.

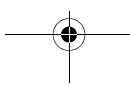
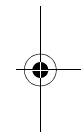
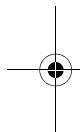

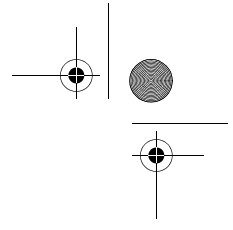
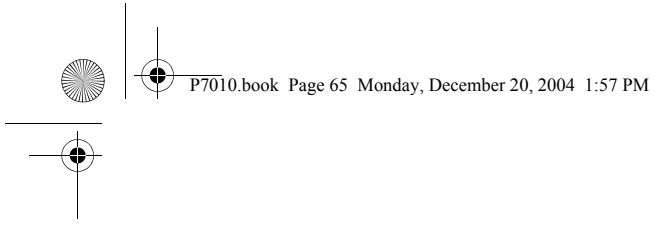

6 Troubleshooting

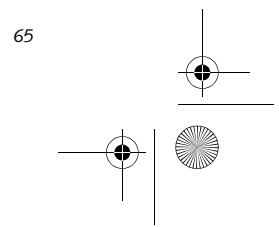
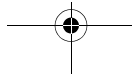
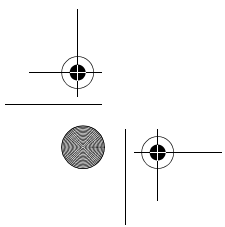
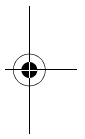
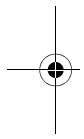

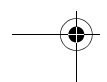
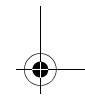
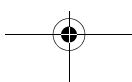
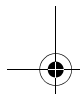
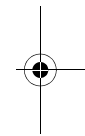
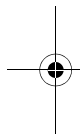
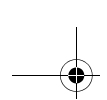

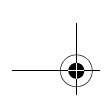

Troubleshooting

Your Fujitsu LifeBook notebook is sturdy and subject to few problems in the field. However, you may encounter simple setup or operating problems that you can solve on the spot, or problems with peripheral devices, that you can solve by replacing the device. The information in this section helps you isolate and resolve some of these straightforward problems and identify failures that require service.

IDENTIFYING THE PROBLEM

If you encounter a problem, go through the following procedure before pursuing complex troubleshooting:

1. Turn off your LifeBook notebook.
2. Make sure the AC adapter is plugged into your notebook and to an active AC power source.
3. Make sure that any card installed in the PC Card slot is seated properly. You can also remove the card from the slot, thus eliminating it as a possible cause of failure.
4. Make sure that any devices connected to the external connectors are plugged in properly. You can also disconnect such devices, thus eliminating them as possible causes of failure.
5. Turn on your notebook. Make sure it has been off at least 10 seconds before you turn it back on.
6. Go through the boot sequence.
7. If the problem has not been resolved, refer to the Troubleshooting Table, that follows, for more detailed troubleshooting information.
8. If you are still having problems after referring to the Troubleshooting Table, go to the Fujitsu Computer Systems Support website (<http://www.computers.us.fujitsu.com/support>), and search the list of Frequently Asked Questions (FAQs) contained there.



If you keep notes about what you have tried, your support representative may be able to help you more quickly by giving additional suggestions over the phone.

9. If you have tried the solutions suggested above without success, contact your support representative:

Toll free: 1-800-8Fujitsu (1-800-838-5487)

Fax: 408-764-2724

E-mail: 8fujitsu@us.fujitsu.com

Web site:

<http://www.computers.us.fujitsu.com/support>

Before you place the call, you should have the following information ready so that the customer support representative can provide you with the fastest possible solution:

- Product name
- Product configuration number
- Product serial number
- Purchase date
- Conditions under which the problem occurred
- Any error messages that have occurred
- Type of device connected, if any

See the Configuration Label on the bottom of your notebook for configuration and serial numbers. (See figure 2-7 on page 11 for location)

SPECIFIC PROBLEMS

Using the Troubleshooting Table

When you have problems with your LifeBook notebook, try to find the symptoms under the Problem column of the troubleshooting table for the feature giving you difficulty. You will find a description of common causes for that symptom under the column Possible Cause and what, if anything, you can do to correct the condition under Possible Solutions. All possible causes or solutions may not apply to your notebook.

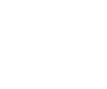
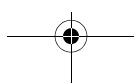
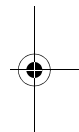
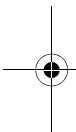

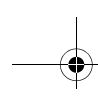

TROUBLESHOOTING TABLE

Problem	Page	Problem	Page
Audio Problems	page 68	USB Device Problems	page 70
DVD/CD-RW Drive Problems	page 68	PC Card Problems	page 70
Floppy Disk Drive Problems	page 69	Power Failures	page 71
Hard Drive Problems	page 69	Shutdown and Startup Problems	page 72
Keyboard or Mouse Problems	page 69	Video Problems	page 73
Memory Problems	page 70	Miscellaneous Problems	page 74
Modem Problems	page 70		

Problem	Possible Cause	Possible Solutions
Audio Problems		
There is no sound coming from the built-in speakers.	The software volume control is set too low.	Adjust the sound volume control settings in your software, operating system and applications.
	Headphones are plugged into your notebook.	Plugging in headphones disables the built-in speakers; remove the headphones.
	BIOS audio settings are incorrect.	Set the BIOS setup utility to the default values within the Multimedia Device Configuration menu. (See <i>BIOS Setup Utility on page 25 for more information</i>)
	Software driver is not configured correctly.	Refer to your application and operating system documentation for help.
DVD/CD-RW Drive Problems		
LifeBook notebook fails to recognize DVD/CD-RW disc	Protective sheet is still in the DVD/CD-RW drive tray.	Remove the protective sheet from the tray.
	The disc is not pushed down onto raised center of the drive.	Open DVD/CD-RW tray and re-install DVD/CD-RW disc properly.
	DVD/CD-RW drive tray is not latched shut.	Push on the front of the DVD/CD-RW drive tray until it latches.
	Incorrect DVD Player or no DVD Player software is installed.	Install DVD Player software. (See <i>"Using the Optical Drive Software" on page 35 for more information.</i>)
	Wrong drive designator was used for DVD/CD-RW drive in the application.	Verify the drive designator used by the application is the same as the one used by the operating system. When the operating system is booted from a DVD/CD, drive designations are automatically adjusted.
	Windows DVD/CD-RW auto insertion function is disabled.	Start the DVD/CD-RW drive from the desktop or application software or re-enable the Windows DVD/CD-RW auto insertion function. (See <i>Auto Insert Notification Function on page 36 for more information</i>)
	DVD/CD-RW disc is dirty or defective.	Wipe disc with non-abrasive cleaning cloth and reinsert. If it still will not work try a different disc.
The DVD/CD-RW Access indicator on the Status Indicator Panel blinks at regular intervals when no disc is in the tray or the drive is not installed.	The Windows DVD/CD-RW auto insertion function is active and is checking to see if a DVD/CD-RW disc is ready to run.	This is normal. However, you may disable this feature. (See <i>Auto Insert Notification Function on page 36 for more information</i>)



Troubleshooting

Problem	Possible Cause	Possible Solutions
Floppy Disk Drive Problems		
You cannot access your optional floppy disk.	You tried to write to a write protected floppy disk.	Eject the floppy disk and set it to write enable. (See <i>Preparing a Disk for Use on page 33 for more information</i>)
	Floppy disk is not loaded correctly.	Eject floppy disk, check orientation and re-insert. (See <i>Ejecting a Disk on page 33 for more information</i>)
	Security is set to protect access to floppy disk data.	Verify your password and security settings.
Hard Drive Problems		
You cannot access your hard drive.	The setup utility is incorrectly set for your internal (Primary Master) or optional second hard drive (Primary Slave).	Revise BIOS settings to set both Primary Master and Primary Slave correctly. (See <i>BIOS Setup Utility on page 25 for more information</i>)
	The wrong drive designator was used by an application when a bootable CD-ROM was used to start the notebook.	Verify drive designator used by application is in use by the operating system. When the operating system is booted from a CD, drive designations are automatically adjusted.
	Security is set so your operating system cannot be started without a password.	Verify your password and security settings.
Keyboard or Mouse Problems		
The built-in keyboard does not seem to work.	The notebook has gone into Suspend mode.	Push the Suspend/Resume/Power On button.
	Your application has locked out your keyboard.	Try to use your integrated pointing device to restart your system. If this fails, turn your notebook off by pressing the Power/Suspend/Resume button for several seconds. After the system has been off for at least 10 seconds, turn it back on.
The characters that appear do not match those which you typed.	NumLk is set in the BIOS.	Go to the BIOS and make sure that NumLk is disabled. (See <i>BIOS Setup Utility on page 25 for more information</i>)
You have installed an external keyboard or mouse, and it does not seem to work.	Your external device is not properly installed.	Re-install your device. (See <i>Device Ports on page 44 for more information</i>)
	Your operating system software is not setup with the correct software driver for that device.	Check your device and operating system documentation and activate the proper driver.
You have connected an external keyboard or a mouse and it seems to be locking up the system.	Your operating system software is not setup with the correct software driver for that device.	Check your device and operating system documentation and activate the proper driver.
	Your system has crashed.	Try to restart your notebook. If this fails, turn your notebook off by pressing the Power/Suspend/Resume button for several seconds. After the system has been off for at least 10 seconds, turn it back on.

LifeBook P7000 Notebook - Section Six

Problem	Possible Cause	Possible Solutions
Memory Problems		
Your Power On screen, or Info menu of the BIOS setup utility information, does not show the correct amount of installed memory.	Your memory upgrade module is not properly installed.	Remove and re-install your memory upgrade module. (See <i>Memory Upgrade Module on page 42 for more information</i>)
	You have a memory failure.	Check for Power On Self Test (POST) messages. (See <i>Power On Self Test Messages on page 75 for more information</i>)
Modem Problems		
Messages about modem operation.	Messages about modem operation are generated by whichever modem application is in use.	See your application software documentation for additional information.
USB Device Problems		
You have installed a USB device but your LifeBook notebook does not recognize the device, or the device does not seem to work properly.	The device is not properly installed.	Remove and re-install the device. (See <i>Device Ports on page 44 for more information</i>)
	The device may have been installed while an application was running, so your notebook is not aware of its installation.	Close the application and restart your notebook.
	Your software may not have the correct software driver active.	See your software documentation and activate the correct driver.
	You may have the wrong I/O address selected for your device.	See your device documentation and software documentation to determine the required I/O address. Change the settings in the BIOS setup utility. (See <i>BIOS Setup Utility on page 25 for more information</i>)
	Your device and another device are assigned the same I/O address.	Check all I/O addresses located within the BIOS setup utility and any other installed hardware or software to make sure there are no duplications.
PC Card Problems		
A card inserted in the PC Card slot does not work or is locking up the system.	The card is not properly installed.	Remove and re-install the card. (See <i>PC Cards on page 37 for more information</i>)
	The card may have been installed while an application was running, so your notebook is not aware of its installation.	Close the application and restart your notebook.
	Your software may not have the correct software driver active.	See your software documentation and activate the correct driver.
	You may have the wrong I/O address selected for your PC Card device.	See your PC Card documentation to determine the required I/O address. Change the settings in the BIOS. (See <i>BIOS Setup Utility on page 25 for more information</i>)
	Your PC Card device and another device are assigned the same I/O address.	Check all I/O addresses located within the BIOS setup utility and any other installed hardware or software to make sure there are no duplications.

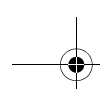
**Troubleshooting**

Problem	Possible Cause	Possible Solutions
Power Failures		
You turn on your LifeBook notebook and nothing seems to happen.	The installed primary battery is completely discharged, there is no optional second battery installed or there is no Power adapter installed.	Check the Status Indicator Panel to determine the presence and condition of the batteries. (See <i>Status Indicator Panel on page 12 for more information</i>) Install a charged battery or a Power adapter.
	The primary battery is installed but is faulty.	Use the Status Indicator panel to verify the presence and condition of the batteries. (See <i>Status Indicator Panel on page 12 for more information</i>) If a battery is indicating a short, remove that battery and operate from another power source or replace that battery.
	The battery or batteries are low.	Check the Status Indicator Panel to determine the presence and condition of the batteries. (See <i>Status Indicator Panel on page 12 for more information</i>) Use a Power adapter to operate until a battery is charged or install a charged battery.
	The adapter (AC or auto/airline) is not plugged in properly.	Verify that your adapter is connected correctly. (See <i>Power Sources on page 23 for more information</i>)
	The Power adapter (AC or auto/airline) has no power from the AC outlet, airplane seat jack, or the car's cigarette lighter.	Move the AC cord to a different outlet, check for a line switch or tripped circuit breaker for the AC outlet. If you are using an auto/airline adapter in a car make sure the ignition switch is in the On or Accessories position.
	The Power adapter (AC or auto/airline) is faulty.	Try a different Power adapter or install a charged optional second battery.
Your LifeBook notebook turns off all by itself.	The power management parameters are set for auto timeouts which are too short for your operating needs.	Press any button on the keyboard, or move the mouse to restore operation. If that fails, push the Suspend/Resume button. Check your power management settings, or close your applications and go to the Power Savings menu of the setup utility to adjust the timeout values to better suit your operation needs.
	You are operating on battery power only and have ignored a low battery alarm until the battery is at dead battery state and your system has gone into Dead Battery Suspend mode.	Install a power adapter and then push the Suspend/Resume button. (See <i>Power Sources on page 23 for more information</i>)
	You have a battery failure.	Verify the condition of the batteries using the Status Indicator panel, and replace or remove any batteries that are shorted. (See <i>Status Indicator Panel on page 12 for more information</i>)
	Your power adapter has failed or lost its power source.	Make sure the adapter is plugged in and the outlet has power.
Your LifeBook notebook will not work on battery alone.	The installed batteries are dead.	Replace the battery with a charged one or install a Power adapter.
	No batteries are installed.	Install a charged battery.

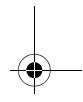
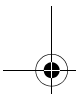
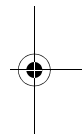
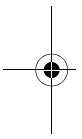

LifeBook P7000 Notebook - Section Six

Problem	Possible Cause	Possible Solutions
Your LifeBook notebook will not work on battery alone. (continued)	The batteries are improperly installed.	Verify that the batteries are properly connected by re-installing them.
	Your installed batteries are faulty.	Verify the condition of the batteries using the Status Indicator panel and replace or remove any batteries that are shorted. (See <i>Status Indicator Panel on page 12 for more information</i>)
The batteries seem to discharge too quickly.	You are running an application that uses a lot of power due to frequent hard drive or DVD/CD-RW drive access, or use of a modem or LAN PC card.	Use both the primary battery and an optional second battery and/or use a power adapter for this application when at all possible.
	The power savings features may be disabled.	Check the power management and/or setup utility settings in the Power Savings menu and adjust according to your operating needs.
	The brightness is turned all the way up.	Turn down the brightness adjustment. The higher the brightness the more power your display uses.
	The batteries are very old.	Replace the batteries.
	The batteries have been exposed to high temperatures.	Replace the batteries.
	The batteries are too hot or too cold.	Restore the notebook to normal operating temperature. The Charging icon on the Status Indicator panel will flash when the battery is outside its operating range.
Shutdown and Startup Problems		
The Suspend/Resume/Power On button does not work.	The Suspend/Resume/Power On button is disabled from the Advanced submenu of the Power menu of the setup utility.	Enable the button from the setup utility.
	You did not hold the button in long enough.	Hold the button longer. This may need to be a few seconds if your application is preventing the CPU from checking for button pushes.
	There may be a conflict with the application software.	Close all applications and try the button again.
The system powers up, and displays power on information, but fails to load the operating system.	Boot sequence settings of the setup utility are not compatible with your configuration.	Set the operating source by pressing the [F12] key while the Fujitsu logo is on screen or use the [F2] key and enter the setup utility and adjust the source settings from the Boot menu. (See <i>BIOS Setup Utility on page 25 for more information</i>)
	You have a secured system requiring a password to load your operating system.	Make sure you have the right password. Enter the setup utility and verify the Security settings and modify them as accordingly. (See <i>BIOS Setup Utility on page 25 for more information</i>)
	Internal hard drive was not detected.	Use the BIOS setup utility to try to auto detect the internal hard drive. If this does not work, contact Fujitsu Service and Support at 1-800-8FUJITSU.

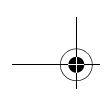
**Troubleshooting**

Problem	Possible Cause	Possible Solutions
An error message is displayed on the screen during the notebook (boot) sequence.	Power On Self Test (POST) has detected a problem.	See the Power On Self Test (POST) messages to determine the meaning and severity of the problem. Not all messages are errors; some are simply status indicators. (See <i>Power On Self Test Messages on page 75 for more information</i>)
Your notebook appears to change setup parameters when you start it.	BIOS setup changes were not saved when you made them and exited the BIOS setup utility returning it to previous settings.	Make sure you select Save Changes And Exit when exiting the BIOS setup utility.
	The BIOS CMOS hold-up battery has failed.	Contact your support representative for repairs. This is not a user serviceable part but has a normal life of 3 to 5 years.
Video Problems		
The built-in display is blank when you turn on your LifeBook notebook.	The notebook is set for an external monitor only.	Pressing [F10] while holding down the [Fn] key allows you to change your selection of where to send your display video. Each time you press the combination of keys you will step to the next choice. The choices, in order are: built-in display only, external monitor only, both built-in display and external monitor.
	The display angle and brightness settings are not adequate for your lighting conditions.	Move the display and the brightness control until you have adequate visibility.
	The power management time-outs may be set for very short intervals and you failed to notice the display come on and go off.	Press any button the keyboard, or move the mouse to restore operation. If that fails, push the Suspend/Resume button. (The display may be shut off by Standby mode, Auto Suspend or Video Timeout)
	The notebook is set for S-Video display only.	While holding down the [Fn] key, click on the [F11] key to toggle the S-Video display off.
The LifeBook notebook turned on with a series of beeps and your built-in display is blank.	Power On Self Test (POST) has detected a failure which does not allow the display to operate.	Contact your support representative.
The display goes blank by itself after you have been using it.	The notebook has gone into Video timeout, Standby mode, Suspend mode or Hibernation mode because you have not used it for a period of time.	Press any button on the keyboard, or move the mouse to restore operation. If that fails, push the Suspend/Resume button. Check your power management settings to adjust the timeout values to better suit your operation needs. (See <i>BIOS Setup Utility on page 25 for more information</i>)
	The power management time-outs may be set for very short intervals and you failed to notice the display come on and go off.	Press any button on the keyboard, or move the mouse to restore operation. If that fails, push the Suspend/Resume button. (The display may be shut off by Standby Mode, Auto Suspend or Video Timeout)
The Built-in Display does not close.	A foreign object, such as a paper clip, is stuck between the display and the keyboard.	Remove all foreign objects from the keyboard.

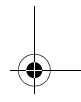
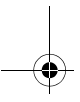
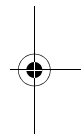
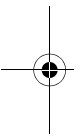

LifeBook P7000 Notebook - Section Six

Problem	Possible Cause	Possible Solutions
The Built-in Display has bright or dark spots.	If the spots are very tiny and few in number, this is normal for a large LCD display.	This is normal; do nothing.
	If the spots are numerous or large enough to interfere with your operation needs.	Display is faulty; contact your support representative.
The application display uses only a portion of your screen and is surrounded by a dark frame.	You are running an application that does not support 800 x 600/1024 x 768 pixel resolution display and display compression is enabled.	Display compression gives a clearer but smaller display for applications that do not support 800 x 600/1024 x 768 pixel resolution. You can fill the screen but have less resolution by changing your display compression setting, (See the Video Features submenu, located within the Advanced menu of the BIOS. (See <i>BIOS Setup Utility on page 25 for more information</i>)
The display is dark when on battery power.	The default is set on low brightness to conserve power.	Press [Fn] + [F7] to increase brightness and adjust Power Control under battery settings.
You have connected an external monitor and it does not display any information.	Your BIOS setup is not set to enable your external monitor.	Toggle the video destination by pressing [Fn] and [F10] together, or check your BIOS setup and enable your external monitor. (See the Video Features submenu, located within the Advanced Menu of the BIOS. (See <i>BIOS Setup Utility on page 25 for more information</i>)
	Your external monitor is not properly installed.	Reinstall your device. (See <i>External Monitor Port on page 46 for more information</i>)
	Your operating system software is not setup with the correct software driver for that device.	Check your device and operating system documentation and activate the proper driver.
You have connected an external monitor and it does not come on.	Your external monitor is not compatible with your LifeBook notebook.	See your monitor documentation and the External Monitor Support portions of the Specifications section. (See <i>Specifications on page 87 for more information</i>)
Miscellaneous Problems		
An error message is displayed on the screen during the operation of an application.	Application software often has its own set of error message displays.	See your application manual and help displays screens for more information. Not all messages are errors some may simply be status.

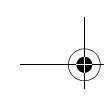
**POWER ON SELF TEST MESSAGES**

The following is an alphabetic list of error-and-status messages that the Phoenix BIOS and/or your operating system can generate and an explanation of each message. Error messages are marked with an *. If an error message is displayed that is not in this list, write it down and check your operating system documentation both on screen and in the manual. If you can find no reference to the message and its meaning is not clear, contact your support representative for assistance.

nnnn Cache SRAM Passed

Where nnnn is the amount of system cache in kilobytes successfully tested by the Power On Self Test. (This can only appear if you have an SRAM PC Card installed.)

***Diskette drive A error or Diskette drive B error**

Drive A: or B: is present but fails the BIOS Power On Self Test diskette tests. Check to see that the drive is defined with the proper diskette type in the Setup Utility, (*See BIOS Setup Utility on page 25 for more information*) and that the diskette drive is installed correctly. If the disk drive is properly defined and installed, avoid using it and contact your support representative.

***Extended RAM Failed at offset: nnnn**

Extended memory not working or not configured properly. If you have an installed memory upgrade module, verify that the module is properly installed. If it is properly installed, you may want to check your Windows Setup to be sure it is not using unavailable memory until you can contact your support representative.

nnnn Extended RAM Passed

Where nnnn is the amount of memory in kilobytes successfully tested.

***Failing Bits: nnnn The hex number nnnn**

This is a map of the bits at the memory address (in System, Extended, or Shadow memory) which failed the memory test. Each 1 (one) in the map indicates a failed bit. This is a serious fault that may cause you to lose data if you continue. Contact your support representative.

***Fixed Disk x Failure or Fixed Disk Controller Failure (where x = 1-4)**

The fixed disk is not working or not configured properly. This may mean that the hard drive type identified in your setup utility does not agree with the type detected by the Power On Self Test. Run the setup utility to check for the hard drive type settings and correct them if necessary. If the settings are OK and the message appears when you restart the system, there may be a serious fault which might cause you to lose data if you continue. Contact your support representative.

***Incorrect Drive A type – run SETUP**

Type of floppy drive A: not correctly identified in Setup. This means that the floppy disk drive type identified in

your setup utility does not agree with the type detected by the Power On Self Test. Run the setup utility to correct the inconsistency.

***Incorrect Drive B type – run SETUP**

Type of floppy drive B: not correctly identified in Setup. This means that the floppy disk drive type identified in your setup utility does not agree with the type detected by the Power On Self Test. Run the setup utility to correct the inconsistency.

***Invalid NVRAM media type**

Problem with NVRAM access. In the unlikely case that you see this message you may have some display problems. You can continue operating but should contact your support representative for more information.

***Keyboard controller error**

The keyboard controller test failed. You may have to replace your keyboard or keyboard controller but may be able to use an external keyboard until then. Contact your support representative.

***Keyboard error**

Keyboard not working. You may have to replace your keyboard or keyboard controller but may be able to use an external keyboard until then. Contact your support representative.

***Keyboard error nn**

BIOS discovered a stuck key and displays the scan code for the stuck key. You may have to replace your keyboard but may be able to use an external keyboard until then. Contact your support representative.

***Monitor type does not match CMOS – Run SETUP**

Monitor type not correctly identified in Setup. This error probably means your BIOS is corrupted, run the setup utility and set all settings to the default conditions. If you still get this error, contact your support representative.

***Operating system not found**

Operating system cannot be located on either drive A: or drive C: Enter the setup utility and see if both the fixed disk, and drive A: are properly identified and that the boot sequence is set correctly. Unless you have changed your installation greatly, the operating system should be on drive C:. If the setup utility is correctly set, your hard drive may be corrupted and your system may have to be re-installed from your back up media.

***Parity Check 1 nnnn**

Parity error found in the system bus. BIOS attempts to locate the address and display it on the screen. If it cannot locate the address, it displays ????. This is a potentially data destroying failure. Contact your support representative.

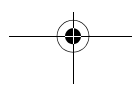
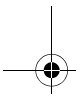
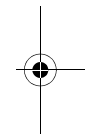
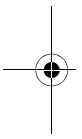

***Parity Check 2 nnnn**

Parity error found in the I/O bus. BIOS attempts to locate the address and display it on the screen. If it cannot locate the address, it displays ????. This is a potentially data-destroying failure. Contact your support representative.

***Press <F1> to resume, <F2> to SETUP**

Displayed after any recoverable error message. Press the [F1] key to continue the boot process or the [F2] key to enter Setup and change any settings.

***Previous boot incomplete – Default configuration used**

Previous Power On Self Test did not complete successfully. The Power On Self Test will load default values and offer to run Setup. If the previous failure was caused by incorrect values and they are not corrected, the next boot will likely fail also. If using the default settings does not allow you to complete a successful boot sequence, you should turn off the power and contact your support representative.

***Real time clock error**

Real-time clock fails BIOS test. May require board repair. Contact your support representative.

***Shadow RAM Failed at offset: nnnn**

Shadow RAM failed at offset nnnn of the 64k block at which the error was detected. You are risking data corruption if you continue. Contact your support representative.

nnnn Shadow RAM Passed

Where nnnn is the amount of shadow RAM in kilobytes successfully tested.

***System battery is dead – Replace and run SETUP**

The BIOS CMOS RAM memory hold up battery is dead. This is part of your BIOS and is a board mounted battery which requires a support representative to change. You can continue operating but you will have to use setup utility default values or reconfigure your setup utility every time you turn off your notebook. This battery has an expected life of 2 to 3 years.

System BIOS shadowed

System BIOS copied to shadow RAM.

***System CMOS checksum bad – run SETUP**

BIOS CMOS RAM has been corrupted or modified incorrectly, perhaps by an application program that changes data stored in BIOS memory. Run Setup and reconfigure the system.

***System RAM Failed at offset: nnnn**

System memory failed at offset nnnn of in the 64k block at which the error was detected. This means that there is a fault in your built-in memory. If you continue to operate, you risk corrupting your data. Contact your support representative for repairs.

nnnn System RAM Passed

Where nnnn is the amount of system memory in kilobytes successfully tested.

***System timer error**

The timer test failed. The main clock that operates the computer is faulty. Requires repair of system board. Contact your support representative for repairs.

UMB upper limit segment address: nnnn

Displays the address of the upper limit of Upper Memory Blocks, indicating released segments of the BIOS memory which may be reclaimed by a virtual memory manager.

Video BIOS shadowed

Video BIOS successfully copied to shadow RAM.

EMERGENCY DVD TRAY RELEASE

If for some reason the eject button fails, you can open the DVD/CD-RW tray with a paper clip or similar tool inserted into the eject hole in the far right side of the front of the tray. Straighten one side of a paper clip and push it gently into the hole. The tray will pop out a short distance.

MODEM RESULT CODES

The operating system and application software that is factory installed detects the modem characteristics and provides the necessary command strings to operate the modem. The internal modem operation is controlled by generic AT commands from the operating system and application software. The standard long form result codes may, in some cases, be displayed on your screen to keep you informed of the actions of your modem. The operating system and application software may suppress display of the result codes.

Examples of result codes are:

- OK
- NO CARRIER
- NO DIALTONE
- CONNECT 53000 (Connection complete at 53,000 bps.)
- ERROR
- FAX
- RING (This means an incoming call.)
- BUSY
- NO ANSWER

When using the internal modem with applications that are not factory installed refer to the application documentation.

Restoring Your Pre-installed Software

The Drivers and Applications Restore (DAR) DVD contains sets of device drivers and Fujitsu utilities (in specific directories) that are unique to your notebook configuration for use as documented below.



If you have access to the internet, visit the Fujitsu Support web site at <http://www.computers.us.fujitsu.com/support> to check for the most current information, drivers and hints on how to perform recovery and system updates. (See *Automatically Downloading Driver Updates* on page 78 for more information)

Re-Installing Individual Drivers and Applications

The Drivers and Applications CD can be used to selectively re-install drivers and/or applications that may have been un-installed or corrupted.



There may be certain free third-party applications pre-installed on your system that are not on the DAR CD. The latest versions of the applications can be downloaded from the third-party's website.

To re-install drivers and/or applications:

1. Boot up the system and insert the DAR CD after Windows has started. A Fujitsu Installer screen is displayed after the CD is inserted.
2. After reading the License Agreement, click [I agree].
3. A window will appear containing a list of applications, drivers, and utilities that you can install from the Drivers and Applications CD.



The components listed are color-coded in terms of their install status. Blue indicates that the component can be installed. Green indicates that the component needs to be installed separately. Grey indicates a component that is already installed; grey items can be reinstalled, but prior to installation you will receive a reminder that the component is already installed.

4. In the list, check off all the components you want to install. If you want to install all components, click [Select All]. Clicking [Select All] will select all of the blue-coded components; you must select grey and green components separately.
5. Once you have selected the components you wish to install, click [Install Selected Subsystems]; the components will be installed.

6. After the components are installed, click [OK], then click [Yes] when asked if you want to reboot the system.

RESTORING THE FACTORY IMAGE

The Restore Disc that came with your system contains two utilities:

- The **Recovery** utility allows you to restore the original contents of the C: drive.
- The **Hard Disk Data Delete** utility on this disc is used to delete all data on your hard disk and prevent it from being reused. Do not use the Hard Disk Data Delete utility unless you are absolutely certain that you want to erase your entire hard disk, including all partitions.



- The use of this disc requires that you have a device capable of reading DVDs attached to your system. If you do not have a built-in DVD player, you will need to attach an external player. For more information on available external devices, visit our Web site at: us.fujitsu.com/computers.

- This disc can only be used with the system with which it was purchased.

BOOT Priority Change

Before restoring an image, you must first verify that your system is set up to boot from the DVD drive. To verify/change the boot-up priority (rather than booting-up from the hard drive or an external floppy disk drive), perform the following steps:

1. Start your system and press the [F2] key when the Fujitsu logo appears. You will enter the BIOS Setup Utility.
2. Using the arrow keys, go to the Boot menu.
3. Arrow down to the Boot Device Priority submenu. Press [Enter].
4. If "Optical Media Drive" or "CD-ROM Drive" is not at the top of the list, arrow down to the drive in the list, and press the space bar (or the + key) to move it to the top of the list. (The system attempts to boot from the devices in the order in which they are listed.). Note that the BIOS for some systems will indicate "CD-ROM Drive", even when a DVD drive is connected.
5. If you have an *external* DVD drive connected, proceed to step 6; otherwise, proceed to step 7.
6. If you have an external DVD drive connected:
 - Select the Advanced menu in the BIOS window.
 - Scroll down to the USB Features submenu and press the Enter key to open it.



- If Legacy USB Support is disabled, press the space bar to enable it.
 - Scroll down to SCSI SubClass Support and press the space bar to enable it.
7. Press [F10], then click on [Yes] to exit the BIOS Setup Utility and return to the boot process.

After you have changed the boot priority, you can restore a backup image when you are booting up.

Procedure

1. Turn on the power to your system.
2. Ensure that you have a device that can read DVDs either installed in your system or attached externally to it.
3. Insert the Restore Disc into the drive tray.
4. Reboot your system.
5. After the system reboots, follow the instructions that appear to either restore your system image or erase all data from your hard disk.

AUTOMATICALLY DOWNLOADING DRIVER UPDATES

Your system has a convenient tool called the Fujitsu Driver Update (FDU) utility. With FDU, you can choose to automatically or manually go to the Fujitsu site to check for new updates for your system.

The FDU icon should appear in the system tray at the bottom right of your screen (roll the cursor over the icons to find the correct one). If the FDU icon does not appear in the system tray, it can be started by going to [Start] -> All Programs, and clicking on Fujitsu Driver Update; this will create the icon automatically.

To invoke the FDU menu, right-click on the FDU icon. The menu contains the following items:

- **Check for updates now**
Allows for manual driver update search. The first time it is used, you are prompted to agree to a user agreement. After clicking on the icon, the FDU automatically connects with the Fujitsu site to check for updates and downloads them. While downloading, the icon has a red bar through it, indicating that it cannot be used while the download is in process. When the update is complete, a message appears informing you of the fact.
- **Enable Automatic Update Notifications**
Automatically searches for new updates on a regular basis (approximately every 3 days).
- **Show update history**
Brings up a screen that displays a history of updates that have been made via the FDU.
- **About Fujitsu Driver Update**
Displays the FDU version number and copyright information
- **Fujitsu Driver Update Readme**
Displays the FDU readme.

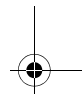
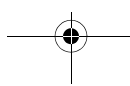
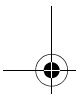
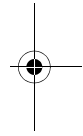
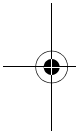

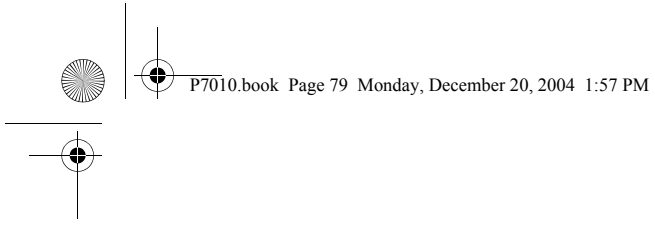

7 Care and Maintenance

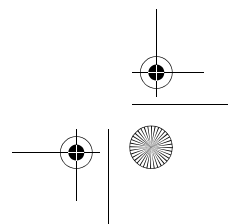
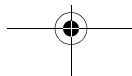
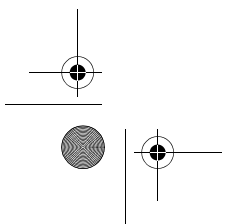
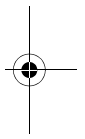
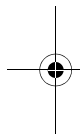

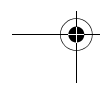
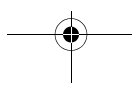
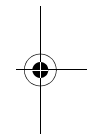
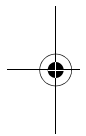
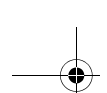

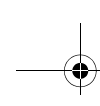

Care and Maintenance

If you use your Fujitsu LifeBook notebook carefully, you will increase its life and reliability. This section provides some tips for looking after the notebook and its devices.



Electrical equipment may be hazardous if misused. Operations of this product or similar products, must always be supervised by an adult. Do not allow children access to the interior of any electrical products and do not permit them to handle any cables.

Caring for your LifeBook notebook

- Your LifeBook notebook is a durable but sensitive electronic device. Treat it with respect and care.
- Make a habit of transporting it in a suitable carrying case.
- Do not attempt to service the computer yourself. Always follow installation instructions closely.
- Keep it away from food and beverages.
- If you accidentally spill liquid on your LifeBook notebook:
 1. Turn it off.
 2. Position it so that the liquid can run out.
 3. Let it dry out for 24 hours, or longer if needed.
 4. If your notebook will not boot after it has dried out, call your support representative.
- Do not use your Fujitsu LifeBook notebook in a wet environment (near a bathtub, swimming pool).
- Always use the AC adapter and batteries that are approved for your notebook.
- Avoid exposure to sand, dust and other environmental hazards.
- Do not expose your notebook to direct sunlight for long periods of time as temperatures above 140° F (60° C) may damage your notebook.
- Keep the covers closed on the connectors and slots when they are not in use.
- Do not put heavy or sharp objects on the computer.
- If you are carrying your LifeBook notebook in a briefcase, or any other carrying case, make sure that there are no objects in the case pressing on the lid.
- Never position your notebook such that the DVD/CD-RW drive is supporting the weight of the notebook.
- Do not drop your notebook.
- Do not touch the screen with any sharp objects.

Cleaning your LifeBook notebook

- Always disconnect the power plug. (Pull the plug, not the cord.)
- Clean your LifeBook notebook with a damp, lint-free cloth. Do not use abrasives or solvents.
- Use a soft cloth to remove dust from the screen. Never use glass cleaners.

Storing your LifeBook notebook



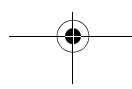
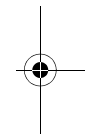
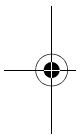

- If storing your notebook for a month or longer, turn your LifeBook notebook off, charge the battery, then remove and store all Lithium ion batteries.
- Store your notebook and batteries separately. If you store your LifeBook with a battery installed, the battery will discharge, and battery life will be reduced. In addition, a faulty battery might damage your LifeBook.
- Store your Fujitsu LifeBook in a cool, dry location. Temperatures should remain between 13°F (-10°C) and 140°F (60°C).

Traveling with your LifeBook notebook

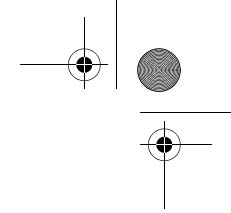
- Do not transport your notebook while it is turned on.
- Do not check your notebook as baggage. Carry it with you.
- Always bring your backup disk and Drivers and Applications CD that came with your notebook when you travel. If you experience system software problems while traveling, you may need it to correct any problems.
- Never put your notebook through a metal detector. Have your notebook hand-inspected by security personnel. You can however, put your notebook through a properly tuned X-ray machine. To avoid problems, place your notebook close to the entrance of the machine and remove it as soon as possible or have your notebook hand-inspected by security personnel. Security officials may require you to turn your notebook On. Make sure you have a charged battery on hand.
- When traveling with the hard drive removed, wrap the drive in a non-conducting materials (cloth or paper). If you have the drive checked by hand, be ready to install the drive if needed. Never put your hard drive through a metal detector. Have your hard drive hand-inspected by security personnel. You can however, put your hard drive through a properly tuned X-ray machine.
- Take the necessary plug adapters if you're traveling overseas. Check the following diagram to determine which plug adapter you'll need or ask your travel agent.





Outlet Type	Location
	United States, Canada, parts of Latin America, Mexico, Japan, Korea, the Philippines, Taiwan
	Russia and the Commonwealth of Independent States (CIS), most of Europe, parts of Latin America, the Middle East, parts of Africa, Hong Kong, India, most of South Asia
	United Kingdom, Ireland, Malaysia, Singapore, parts of Africa
	China, Australia, New Zealand

BATTERIES**Caring for your Batteries**

- Always handle batteries carefully.
- Do not short-circuit the battery terminals (that is, do not touch both terminals with a metal object). Do not carry loose batteries in a pocket or purse where they may mix with coins, keys, or other metal objects. Doing so may cause an explosion or fire.
- Do not drop, puncture, disassemble, mutilate or incinerate the battery.
- Recharge batteries only as described in this manual and only in ventilated areas.
- Do not leave batteries in hot locations for more than a day or two. Intense heat can shorten battery life.
- Do not leave a battery in storage for longer than 6 months without recharging it.

Increasing Battery Life

- Power your LifeBook notebook through the AC or optional auto/airline adapter whenever possible.
- If your notebook is running on battery power all day, connect it to the AC adapter overnight to recharge the battery.
- Keep brightness to the lowest level comfortable.
- Set the power management for maximum battery life.

- Put your notebook in Suspend mode when it is turned on and you are not actually using it.
- Limit your media drive access.
- Disable the DVD/CD-RW Combo Drive auto insert notification function.
- Always use fully charged batteries.
- Eject PCMCIA™ cards when not in use.

FLOPPY DISKS AND DRIVES**Caring for your Floppy Disks**

- Avoid using the floppy disks in damp and dusty locations.
- Never store a floppy disk near a magnet or magnetic field.
- Do not use a pencil or an eraser on a disk or disk label.
- Avoid storing the floppy disks in extremely hot or cold locations, or in locations subject to severe temperature changes. Store at temperatures between 50° F (10°C) and 125° F (52°C).
- Do not touch the exposed part of the disk behind the metal shutter.

Caring for your Floppy Disk Drive

- To clean, wipe the floppy disk drive clean with a dry soft cloth, or with a soft cloth dampened with water or a solution of neutral detergent. Never use benzene, paint thinner or other volatile material.
- Avoid storing the floppy disk drive in extremely hot or cold locations, or in locations subject to severe temperature changes. Store at temperatures between 50° F (10° C) and 125° F (52° C).
- Keep the floppy disk drive out of direct sunlight and away from heating equipment.
- Avoid storing the floppy disk drive in locations subject to shock and vibration.
- Never use the floppy disk drive with any liquid, metal, or other foreign matter inside the floppy disk drive or disk.
- Never disassemble or dismantle your floppy disk drive.

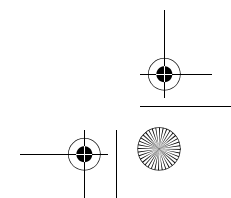
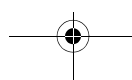

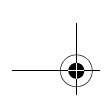

MEDIA CARE

Caring for your Media (DVD/CD-RW/CD-ROM)

Media discs are precision devices and will function reliably if given reasonable care.

- Always store your media disc in its case when it is not in use.
- Always handle discs by the edges and avoid touching the surface.
- Avoid storing any media discs in extreme temperatures.
- Do not bend media discs or set heavy objects on them.
- Do not spill liquids on media discs.
- Do not scratch media discs.
- Do not get dust on media discs.
- Never write on the label surface with a ballpoint pen or pencil. Always use a felt pen.
- If a media disc is subjected to a sudden change in temperature, cold to warm condensation may form on the surface. Wipe the moisture off with a clean, soft, lint free cloth and let it dry at room temperature. DO NOT use a hair dryer or heater to dry media discs.
- If a disc is dirty, use only a DVD/CD cleaner or wipe it with a clean, soft, lint free cloth starting from the inner edge and wiping to the outer edge.

Caring for your DVD/CD-RW Drive

Your DVD/CD-RW drive is durable but you must treat it with care. Please pay attention to the following points:

- The drive rotates the compact disc at a very high speed. Do not carry it around or subject it to shock or vibration with the power on.
- Avoid using or storing the drive where it will be exposed to extreme temperatures.
- Avoid using or storing the drive where it is damp or dusty.
- Avoid using or storing the drive near magnets or devices that generate strong magnetic fields.
- Avoid using or storing the drive where it will be subjected to shock or vibration.
- Do not disassemble or dismantle the DVD/CD-RW drive.
- Occasional use of a commercially available lens cleaner kit is recommended to maintain your drive.

PC CARDS

Caring for your PC Cards

PC Cards are durable, but you must treat them with care. The documentation supplied with your PC Card will provide specific information, but you should pay attention to the following points:

- To keep out dust and dirt, store PC Cards in their protective sleeves when they are not installed in your LifeBook notebook.
- Avoid prolonged exposure to direct sunlight or excessive heat.
- Keep the cards dry.
- Do not flex or bend the cards, and do not place heavy objects on top of them.
- Do not force cards into the slot.
- Avoid dropping cards, or subjecting them to excessive vibration.

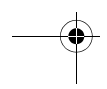
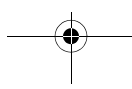
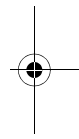
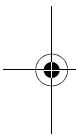

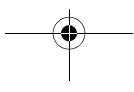
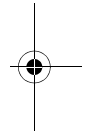
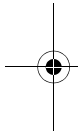

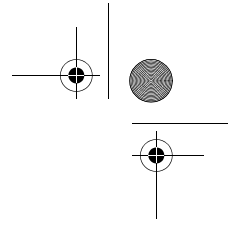
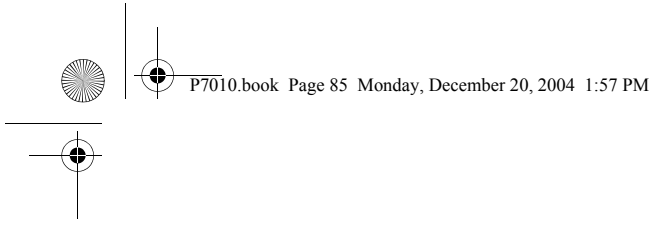

8 Specifications

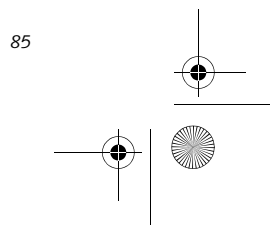
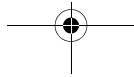
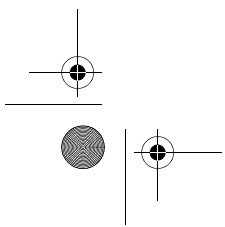
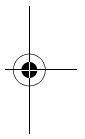
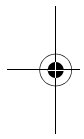

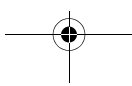
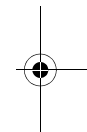
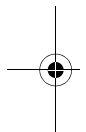

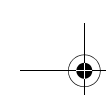

Specifications

Specifications

This section provides the hardware and environmental specifications for your Fujitsu LifeBook notebook. Specifications of particular configurations will vary.

CONFIGURATION LABEL

The configuration label located on the bottom of your LifeBook notebook (See figure 2-7 on page 11 for location) contains information regarding the options you've chosen for your notebook. Following is an example label and information on how to read your own configuration label.

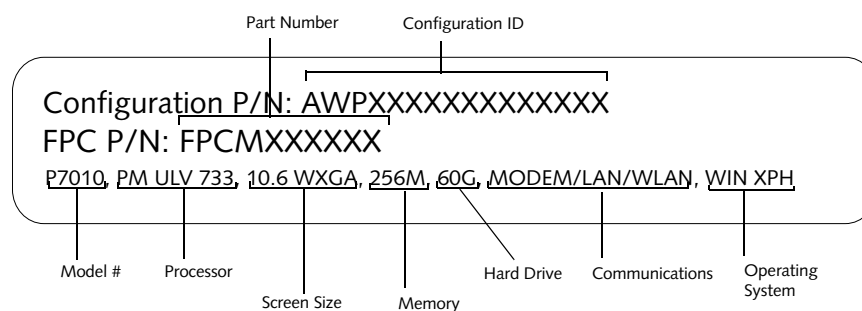

Figure 8-1 Configuration Label

MICROPROCESSOR

Intel® Pentium® M Ultra Low Voltage (ULV) or Intel® Celeron® M Ultra Low Voltage (ULV). For the processor speed of your LifeBook, check the configuration label.

- 400 MHz system bus speed
- 64 KB L1 cache memory
- 2 MB on-die L2 cache memory (Pentium) or 512 KB (Celeron)

MEMORY

System Memory

- 256 MB minimum, 1 GB maximum, micro-DIMM DDR SDRAM
- Two micro-DIMM slots
- 256 MB and 512 MB memory modules are available

BIOS Memory

1 MB Firmware Hub (FWH) Flash ROM

VIDEO

Built-in color 10.6" Wide XGA Crystal View TFT active matrix LCD display with simultaneous display capability

Video Color and Resolution

- 10.6" TFT Wide XGA
- Internal: 1280 x 768 pixel resolution, 16M colors
- External: 1600 x 1200 pixel resolution, 16M colors
Simultaneous Video = Yes (1024 x 768, 16M colors)
XGA, SVGA and VGA compatible

Video RAM

Intel® 855GME or 852GML video graphics chip with integrated 32-bit 3D/2D gfx core and Accelerated Graphics Port (AGP) support. Up to 64 MB shared video memory using Dynamic Video Memory Technology 2.0.

AUDIO

- Realtek ALC203 codec with 18-bit stereo audio
- Stereo headphone/Optical Digital (SPDIF) port

- Mono microphone jack, 100 mV_{rms} max.
- Dolby Headphone signal processing utility (in the InterVideo DVD software)
- Two built-in stereo speakers, 25 mm x 14 mm, bass reflex
- Built-in microphone on palm rest

MASS STORAGE DEVICE OPTIONS

Hard Drive

40 GB, 60 GB, or 80 GB fixed hard drive, 2.5", ATA 100

Modular DVD/CD-RW Combo Drive

8x DVD / 10x CD-RW / 24x CD-R / 24x CD-ROM

Modular Multi-Format DVD Writer

2x DVD-R, 2x DVD-RW, 2.4x DVD+R, 2.4x DVD+RW, 2x DVD-RAM, 8x DVD-ROM, 24x CD-R, 10x CD-RW, 24x CD-ROM

FEATURES

Communications

- Modem: Internal V.90 standard 56K* fax/modem (ITU V.90, 56K data, 14.4K fax)
- LAN: 10/100 Base-TX Ethernet
- Integrated Intel PRO/Wireless 2200BG Network Connections (802.11b/g*) with Antenna On/Off switch (available in LifeBook P7010 model), or,
- Integrated Intel PRO/Wireless 2915ABG Network Connections (802.11a+b/g**) with Antenna On/Off switch (available in LifeBook P7010 model), or,
- Integrated Atheros Super AG Wireless LAN (802.11a/b/g**) with Antenna On/Off switch (available in LifeBook P7010D model)
- Optional Bluetooth device for wireless personal area network communication

* Operates at 2.4 GHz; communications range may vary, depending upon environment.

** Operates at 2.4 GHz and 5.0 GHz; communications range may vary, depending upon environment.

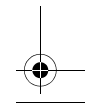
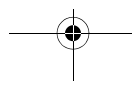
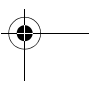
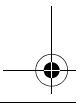
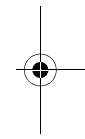
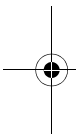

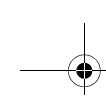

Integrated Pointing Device

Touchpad pointing device with scroll button. (Scroll button is replaced with optional fingerprint sensor in some configurations)

Theft Prevention Lock Slot

Slot for use with physical restraining security systems.

DEVICE PORTS

- PC Card slot for one Type II card: PCMCIA Standard 2.1 with CardBus support
- One connector for external monitor (see Display specifications)
- One Compact Flash Card slot
- One SD/Memory Stick slot
- Two USB 2.0 connectors for input/output devices
- One S-Video Out port
- One modular modem (RJ-11) connector
- One LAN (RJ-45) port
- One IEEE 1394 port
- One stereo headphone/Optical Digital (SPDIF) jack. (See Audio specifications)
- One mono microphone jack. (See Audio specifications)

KEYBOARD

Built-in keyboard with all functions of 101 key keyboards.

- Total number of keys: 82
- Function keys: [F1] through [F12]
- Feature extension key: [Fn]
- Two Windows keys: one Start and one application key
- Key pitch: 17.5 mm
- Key stroke: 2 mm
- Built-in Touchpad pointing device with left and right buttons and scroll button.
- Built-in palm rest

External Keyboard Support

USB-compatible

External Mouse Support

USB-compatible

POWER

Batteries

- One standard 6-cell high-capacity Lithium ion battery, rechargeable, 10.8V, 4800 mAh. (Approximate charge time: system off: 6.5 hours, system running: 17 hours)
- Optional second bay battery: 6-cell Lithium ion battery, rechargeable, 10.8V, 2300 mAh

AC Adapter

Autosensing 100-240V AC, 60W, supplying 16V DC, 3.75A, to the LifeBook notebook, Fujitsu Model FPCAC37AP, which includes an AC cable.

Power Management

Conforms to ACPI (Advanced Configuration and Power Interface)

DIMENSIONS AND WEIGHT

Overall Dimensions

Approximately 10.28"(w) x 7.83"(d) x 1.26/1.428"(h)
(261mm x 199 mm x 32/36 mm)

Weights

Approximately 3.28 lbs (1.50 kg) with standard high capacity battery and DVD/CD-RW combo drive

ENVIRONMENTAL REQUIREMENTS

Temperature

Operating: 41° to 95° F (5° to 35° C)

Non-operating: 13° to 140° F (-10° to 60° C)

Humidity

Operating: 20% to 85%, relative, non-condensing

Non-operating: 8% to 85%, relative, non-condensing

Altitude

Operating: 10,000 feet (3,048 m) maximum

POPULAR ACCESSORIES

For ordering or additional information on Fujitsu accessories please visit our Web site at: us.fujitsu.com/computers or call 1-877-372-3473.

Memory Upgrade

- 256 MB Double Data Rate (DDR) SDRAM (micro DIMM)
- 512 MB Double Data Rate (DDR) SDRAM (micro DIMM)

Power

- Additional standard High Capacity Lithium ion battery
- Modular 2nd Lithium ion Battery
- Auto/Airline Adapter
- AC Adapter
- Battery Charger

Flexible Bay Devices

- Modular DVD/CD-RW combo drive
- Modular Multi-Format DVD Writer
- Modular second Lithium ion battery

Additional Accessories

- USB Optical Mouse
- Wireless Keyboard and Mouse
- Notebook Guardian Lock
- External Floppy Disk Drive

Carrying Cases

- Diplomat
- Dual Carrying Case
- Director
- Moda Backpack



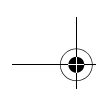

Specifications

PRE-INSTALLED SOFTWARE

Depending on your pre-installed operating system, your Fujitsu LifeBook notebook comes with pre-installed software for playing audio and video files of various formats. In addition there is file transfer software, virus protection software and Power Management software.

LEARNING ABOUT YOUR APPLICATION SOFTWARE

Tutorials

All operating systems and most application software have tutorials built into them upon installation. We highly recommend that you step through the tutorial before you use an application.

Manuals

Included with your notebook you will find manuals for your installed operating system and other pre-installed software. Any manuals that are not included, are available online through the help system of the software. We recommend that you review these manuals for general information on the use of these applications.

Adobe Acrobat Reader

The Adobe Acrobat Reader allows you to view, navigate, and print PDF files from across all of the major computing platforms.

Norton AntiVirus 2004

Your system is preinstalled with a free 90-day trial version of Symantec's Norton AntiVirus™ 2004. Norton AntiVirus is a program designed to protect your LifeBook notebook from computer viruses. It assists in the protection of the data currently residing on your hard disk from destruction or contamination. The 90-day trial version is activated upon your acceptance of software license agreement. After 90 days, it will be necessary to purchase a subscription from Symantec to download latest virus definitions.

(See your online help or manual for more information on how and when to run this program).

Fujitsu HotKey Utility

Utility for adjusting the brightness level on your LifeBook.

Quicken 2004 New User Edition

Quicken 2004 New User Edition by Intuit is a personal money management program. It has features such as portfolio management, account registries, on-line banking and bill paying features. This application is for new users who are using Quicken software for the first time. Full version upgrade information is available on line.

MS Works

Microsoft Works is a suite of software containing the basic tools to write letters and reports, track family and friends with address books, manage home finances, and create a home inventory.

Depending upon your system configuration, one of the following applications will be installed on your notebook:

Microsoft Works 7.0

Microsoft Works 7.0 is a suite of software containing the basic tools to write letters and reports, track family and friends with address books, manage home finances, and create a home inventory.

Microsoft Office SBE

Microsoft Small Business Edition (SBE) is a suite of applications designed to help run a small business while increasing productivity. Among the programs included in Microsoft SBE are Microsoft Word, Excel, and PowerPoint.

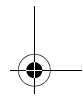
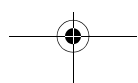
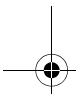
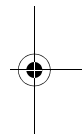
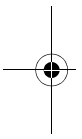

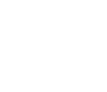
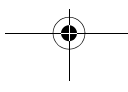
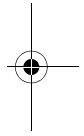
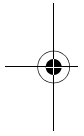
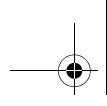

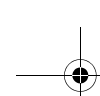

Regulatory Information

NOTICE

Changes or modifications not expressly approved by Fujitsu could void this user's authority to operate the equipment.

FCC NOTICES

Notice to Users of Radios and Television

These limits are designed to provide reasonable protection against harmful interference in a residential installation. This equipment generates, uses, and can radiate radio frequency energy and, if not installed and used in accordance with the instructions, may cause harmful interference to radio communications. However, there is no guarantee that interference will not occur in a particular installation. If this equipment does cause harmful interference to radio or television reception, which can be determined by turning the equipment off and on, the user is encouraged to try to correct the interference by one or more of the following measures:

- Reorient or relocate the receiving antenna.
- Increase the separation between the equipment and receiver.
- Connect the equipment into an outlet that is on a different circuit than the receiver.
- Consult the dealer or an experienced radio/TV technician for help.

Shielded interconnect cables must be employed with this equipment to ensure compliance with the pertinent RF emission limits governing this device.

Notice to Users of the US Telephone Network

This equipment (FMD MBH7MD33 Modem) complies with Part 68 of the FCC rules, and the requirements adopted by ACTA. On the bottom of this equipment is a label that contains, among other information, the FCC registration number and ringer equivalence number (REN) for this equipment; or a product identifier in the format US:AAAEQ##TXXXX. If requested, this information or number must be provided to the telephone company.

This equipment is designed to be connected to the telephone network or premises wiring using a standard jack type USOC RJ11C. A plug and jack used to connect this equipment to the premises wiring and telephone network must comply with the applicable FCC Part 68 rules and requirements adopted by the ACTA. A compliant telephone cord and modular plug is provided with this product. It is designed to be connected to a compatible modular jack that is also compliant.

The ringer equivalent number (REN) of this equipment is 0.0B as shown on the label. The REN is used to determine the number of devices that may be connected to a telephone line. Excessive RENs on a telephone may result in the devices not ringing in response to an incoming call. In most but not all areas, the sum of RENs should not exceed five (5.0). To be certain of the number of devices that may be connected to a line, as determined by the total RENs, contact the local telephone company.

If this equipment causes harm to the telephone network, the telephone company will notify you in advance that temporary discontinuance of service may be required. But if advance notice isn't practical, the telephone company will notify the customer as soon as possible. Also, you will be advised of your right to file a complaint with the FCC if you believe it is necessary.

The telephone company may make changes in its facilities, equipment, operations or procedures that could effect the operation of the equipment. If this happens the telephone company will provide advance notice in order for you to make necessary modifications to maintain uninterrupted service.

If trouble is experienced with this equipment, for repair or warranty information, please refer to the manual or contact Fujitsu Computer Systems Corporation, Customer Service. If the equipment is causing harm to the telephone network, the telephone company may request that you disconnect the equipment until the problem is resolved.

The equipment cannot be used on public coin service provided by the telephone company. Connection to party line service is subject to state tariffs. (Contact the state public utility commission, public service commission or corporation commission for information).

If your home has specially wired alarm equipment connected to the telephone line, ensure the installation of this computer does not disable your alarm equipment. If you have any questions about what will disable alarm equipment, consult your telephone company or a qualified installer.

The Telephone Consumer Protection Act of 1991 makes it unlawful for any person to use a computer or other electronic device to send any message via a telephone fax machine unless such message clearly contains in a margin at the top or bottom of each transmitted page or on the first page of the transmission, the date and time it is sent and an identification of the business or other entity, or other individual sending the message and the telephone number of the sending machine or such business, other entity, or individual.

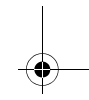
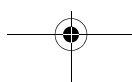
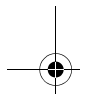
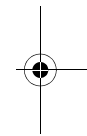
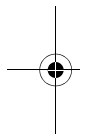

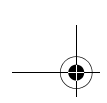

DOC (INDUSTRY CANADA) NOTICES
Notice to Users of Radios and Television

This Class B digital apparatus meets all requirements of Canadian Interference-Causing Equipment Regulations.

CET appareil numérique de la class B respecte toutes les exigences du Règlement sur le matériel brouilleur du Canada.

Notice to Users of the Canadian Telephone Network

NOTICE: This equipment (Modem FMD MBH7MD33) meets the applicable Industry Canada Terminal Equipment Technical Specifications. This is confirmed by the registration number. The abbreviation, IC, before the registration number signifies that registration was performed based on a Declaration of Conformity indicating that Industry Canada technical specifications were met. It does not imply that Industry Canada approved the equipment.

Before connecting this equipment to a telephone line the user should ensure that it is permissible to connect this equipment to the local telecommunication facilities. The user should be aware that compliance with the certification standards does not prevent service degradation in some situations.

Repairs to telecommunication equipment should be made by a Canadian authorized maintenance facility. Any repairs or alterations not expressly approved by Fujitsu or any equipment failures may give the telecommunication company cause to request the user to disconnect the equipment from the telephone line.

NOTICE: The Ringer Equivalence Number (REN) for this terminal equipment is 0.0. The REN assigned to each terminal equipment provides an indication of the maximum number of terminals allowed to be connected to a telephone interface. The termination on an interface may consist of any combination of devices subject only to the requirement that the sum of the Ringer Equivalence Numbers of all the devices does not exceed five.



For safety, users should ensure that the electrical ground of the power utility, the telephone lines and the metallic water pipes are connected together. Users should NOT attempt to make such connections themselves but should contact the appropriate electric inspection authority or electrician. This may be particularly important in rural areas.

Avis Aux Utilisateurs Du Réseau Téléphonique Canadien

AVIS: Le présent matériel (FMD MBH7MD33 Modem) est conforme aux spécifications techniques d'Industrie Canada applicables au matériel terminal. Cette conformité est confirmée par le numéro d'enregistrement. Le sigle IC, placé devant le numéro d'enregistrement, signifie que l'enregistrement s'est effectué conformément à une déclaration de conformité et indique que les spécifications techniques d'Industrie Canada ont été respectées. Il n'implique pas qu'Industrie Canada a approuvé le matériel.

Avant de connecter cet équipement à une ligne téléphonique, l'utilisateur doit vérifier s'il est permis de connecter cet équipement aux installations de télécommunications locales. L'utilisateur est averti que même la conformité aux normes de certification ne peut dans certains cas empêcher la dégradation du service.

Les réparations de l'équipement de télécommunications doivent être effectuées par un service de maintenance agréé au Canada. Toute réparation ou modification, qui n'est pas expressément approuvée par Fujitsu, ou toute défaillance de l'équipement peut entraîner la compagnie de télécommunications à exiger que l'utilisateur déconnecte l'équipement de la ligne téléphonique.

AVIS: L'indice d'équivalence de la sonnerie (IES) du présent matériel est de 0.0. L'IES assigné à chaque dispositif terminal indique le nombre maximal de terminaux qui peuvent être raccordés à une interface téléphonique. La terminaison d'une interface peut consister en une combinaison quelconque de dispositifs, à la seule condition que la somme d'indices d'équivalence de la sonnerie de tous les dispositifs n'excède pas 5.



Pour assurer la sécurité, les utilisateurs doivent vérifier que la prise de terre du service d'électricité, les lignes téléphoniques et les conduites d'eau métalliques sont connectées ensemble. Les utilisateurs NE doivent PAS tenter d'établir ces connexions eux-mêmes, mais doivent contacter les services d'inspection d'installations électriques appropriés ou un électricien. Ceci peut être particulièrement important en régions rurales.

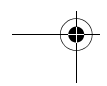
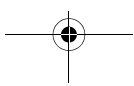

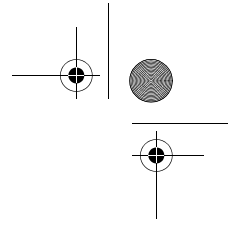
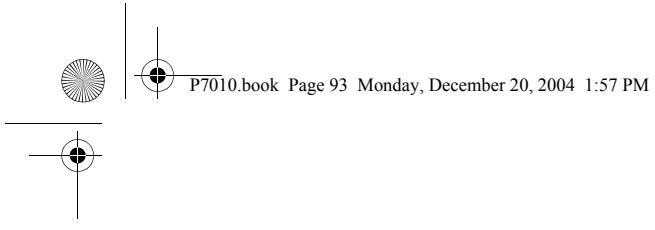

9 Glossary

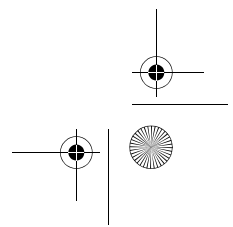
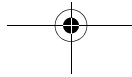
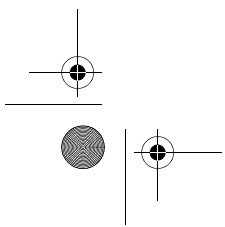
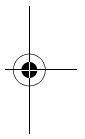
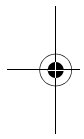

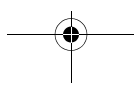
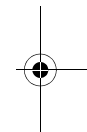
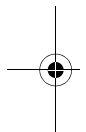

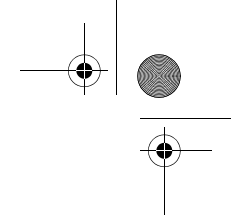

Glossary

AC Adapter

A device which converts the AC voltage from a wall outlet to the DC voltage needed to power your LifeBook notebook.

ACPI

Advanced Configuration and Power Interface. An industry specification for the efficient handling of power consumption in mobile computers. ACPI determines how a computer's BIOS, operating system, and peripherals communicate with each other about power management.

Active-Matrix Display

A type of technology for making flat-panel displays which has a transistor or similar device for every pixel on the screen.

ADSL

Asymmetric Digital Subscriber Line. Technology for transporting high bit-rate services over ordinary phone lines.

APM

Advanced Power Management.

Auto/Airline Adapter

A device which converts the DC voltage from an automobile cigarette lighter or aircraft DC power outlet to the DC voltage needed to power your LifeBook notebook.

BIOS

Basic Input-Output System. A program and set of default parameters stored in ROM which tests and operates your LifeBook notebook when you turn it on until it loads your installed operating system from disk. Information from the BIOS is transferred to the installed operating system to provide it with information on the configuration and status of the hardware.

Bit

An abbreviation for binary digit. A single piece of information which is either a one (1) or a zero (0).

bps

An abbreviation for bits per second. Used to describe data transfer rates.

Boot

To start-up a computer and load its operating system from disk, ROM or other storage media into RAM.

Bus

An electrical circuit which passes data between the CPU and the sub-assemblies inside your LifeBook notebook.

Byte

8 bits of parallel binary information.

Cache Memory

A block of memory built into the micro-processor which is much faster to access than your system RAM and used in specially structured ways to make your overall data handling time faster.

CardBus

A faster, 32-bit version of the PC Card interface which offers performance similar to the 32-bit PCI architecture.

CD-ROM

Compact disc read only memory. This is a form of digital data storage which is read optically with a laser rather than a magnetic head. A typical CD-ROM can contain about 600MB of data and is not subject to heads crashing into the surface and destroying the data when there is a failure nor to wear from reading.

CMS

Code Morphing Software. Crusoe processor software architecture that results in longer battery life. For more information on CMS, click on the Technology link on the refer to the Transmeta web site at: www.transmeta.com.

Command

An instruction which you give your operating system. Example: run a particular application or format a floppy disk.

Configuration

The combination of hardware and software that makes up your system and how it is allocated for use.

Data

The information a system stores and processes.

DC

Direct current. A voltage or current that does not fluctuate periodically with time.

Default Value

A pre programmed value to be used if you fail to set your own.

DIMM

Dual-in-line memory module.

Disk

A spinning platter of magnetic data storage media. If the platter is very stiff it is a hard drive, if it is highly flexible it is a floppy disk, if it is a floppy disk in a hard housing with a shutter it is commonly called a diskette.

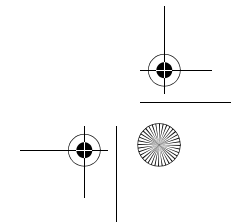
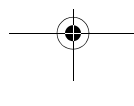
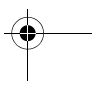
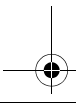
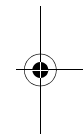
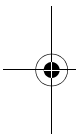

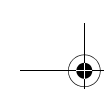
**Disk Drive**

The hardware which spins the disk and has the heads and control circuitry for reading and writing the data on the disk.

Diskette

A floppy disk in a hard housing with a shutter.

DMA

Direct Memory Access. Special circuitry for memory to memory transfers of data which do not require CPU action.

DMI

Desktop Management Interface. A standard that provides PC management applications with a common method of locally or remotely querying and configuring PC computer systems, hardware and software components, and peripherals.

DOS

Disk Operating System (MS-DOS is a Microsoft Disk Operating System).

Driver

A computer program which converts application and operating system commands to external devices into the exact form required by a specific brand and model of device in order to produce the desired results from that particular equipment.

ESD

Electro-Static Discharge. The sudden discharge of electricity from a static charge which has built-up slowly. Example: the shock you get from a doorknob on a dry day or the sparks you get from brushing hair on a dry day.

Extended Memory

All memory more than the 640KB recognized by MS-DOS as system memory.

FCC

Federal Communication Commission.

Floppy Disk

A spinning platter of magnetic data storage media which is highly flexible.

GB

Gigabyte.

Hard drive

A spinning platter of magnetic data storage media where the platter is very stiff.

Hexadecimal

A decimal notation for the value of a 4 bit binary number. (0-9, A, B, C, D, E, F) Example: 2F in hexadecimal = 00101111 in binary = 47 in decimal.

I/O

Input/Output. Data entering and leaving your LifeBook notebook in electronic form.

I/O Port

The connector and associated control circuits for data entering and leaving your LifeBook notebook in electronic form.

IDE

Intelligent Drive Electronics. A type of control interface for a hard drive which is inside the hard drive unit.

IEEE 1394

The IEEE 1394 (also known as "Firewire" or "iLink") standard allows you to connect devices that are compliant with IEEE standard 1394. This port is effectively a very fast communications port. This architecture is very good for transferring large files, such as those from digital cameras.

IRQ

Interrupt Request. An acronym for the hardware signal to the CPU that an external event has occurred which needs to be processed.

KB

Kilobyte.

LAN

Local Area Network. An interconnection of computers and peripherals within a single limited geographic location which can pass programs and data amongst themselves.

LCD

Liquid Crystal Display. A type of display which makes images by controlling the orientation of crystals in a crystalline liquid.

Lithium ion Battery

A type of rechargeable battery which has a high power-time life for its size and is not subject to the memory effect as Nickel Cadmium batteries.

MB

Megabyte.

Megahertz

1,000,000 cycles per second.

Memory

A repository for data and applications which is readily accessible to your LifeBook notebook CPU.

MHz

Megahertz.

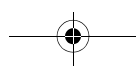

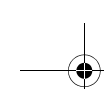

Glossary

Modem

A contraction for **MOdulator-DEModulator**. The equipment which connects a computer or other data terminal to a communication line.

Monaural

A system using one channel to process sound from all sources.

NTSC

National TV Standards Commission. The standard for TV broadcast and reception for the USA.

Operating System

A group of control programs that convert application commands, including driver programs, into the exact form required by a specific brand and model of micro-processor in order to produce the desired results from that particular equipment.

Partition

A block of space on a hard drive which is set aside and made to appear to the operating system as if it were a separate disk, and addressed by the operating system accordingly.

PCMCIA

PCMCIA is a trademark of the Personal Computer Memory Card International Association. The Personal Computer Memory Card International Association is an organization that sets standards for add-in cards for personal computers.

Peripheral Device

A piece of equipment which performs a specific function associated with but not integral to a computer. Examples: a printer, a modem, a CD-ROM.

Pitch (keyboard)

The distance between the centers of the letter keys of a keyboard.

Pixel

The smallest element of a display, a dot of color on your display screen. The more pixels per area the clearer your image will appear.

POP3

Post Office Protocol. Protocol that is used to retrieve email from a mail server.

POST

Power On Self Test. A program which is part of the BIOS which checks the configuration and operating condition of your hardware whenever power is applied to your LifeBook notebook. Status and error messages may be displayed before the operating system is loaded. If the self test detects failures that are so serious that operation can not continue, the operating system will not be loaded.

PPPoE

Point to Point Protocol over Ethernet. A protocol for Ethernet, using a Point-to-Point Protocol (PPP), which is used for connection on the phone line.

Program

An integrated set of coded commands to your computers telling your hardware what to do and how and when to do it.

PS/2

A series of personal computers which established a number of standards for connecting external devices such as keyboards and monitors.

RAM

Random Access Memory. A hardware component of your LifeBook notebook that holds binary information (both program and data) as long as it has the proper power applied to it.

RAM Module

A printed circuit card with memory and associated circuitry which allows the user to add additional memory to the computer without special tools.

Reset

The act of reloading the operating system. A reset erases all information stored in RAM.

Restart

See Reset.

Resume

To proceed after interruption. In your LifeBook notebook, this refers to returning to active operation after having been in one of the suspension states.

ROM

Read Only Memory. A form of memory in which information is stored by physically altering the material. Data stored in this way can not be changed by your LifeBook notebook and does not require power to maintain it.

SDRAM

Synchronous Dynamic Random Access Memory.

Shadow RAM

A technique of copying data or applications stored in ROM (Read Only Memory) into RAM (Random Access Memory) for access during actual operation. RAM is much faster to access than ROM, however ROM contents are not lost when power is removed. Shadowing allows permanently stored information to be rapidly accessed.

SPDIF

Sony Philips Digital Interface. Technology that allows you to download digital audio data onto a MiniDisc recorder.

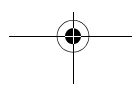
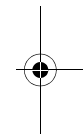
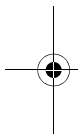

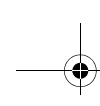

SSID

Service Set Identifier. Specifies which network you are joining. Some systems allow you to specify any SSID as an option so you can join any network.

Status Indicator

A display which reports the condition of some portion of your hardware. On your LifeBook notebook this is an LCD screen just above the keyboard.

Stereo (audio)

A system using two channels to process sound from two different sources.

Stroke (keyboard)

The amount of travel of a key when it is pressed from resting to fully depressed.

Suspend

To make inoperative for a period of time. Your LifeBook notebook uses various suspension states to reduce power consumption and prolong the charge of your battery.

SVGA

Super VGA. Standard that provides 800x600 pixel resolution and a palette of 16M colors.

S-Video

Super Video. A component video system for driving a TV or computer monitor.

System Clock

An oscillator of fixed precise frequency which synchronizes the operation of the system and is counted to provide time of day and date.

TFT

Thin Film Transistor. A technology for flat display panels which uses a thin film matrix of transistors to control each pixel of the display screen individually.

UL

Underwriters Laboratories – An independent organization that tests and certifies the electrical safety of devices.

USB

Universal Serial Bus. An external bus standard that allows for fast data transfer. A single USB port can be used to connect up to 127 peripheral devices, such as

mice, modems, and scanners. USB 1.1 has a transfer speed of a maximum of 12Mb/s. USB 2.0 is much faster, transferring at up to 480Mb/s. USB 2.0 is backward-compatible to work with USB 1.1 devices.

VGA

Video Graphics Array. A video display standard which provides resolutions of 720 x 400.

VRAM

Video Random Access Memory. A memory dedicated to video display data and control.

WEP

Wired Equivalent Privacy. WEP is a protocol for increasing privacy over wireless LANs. The protocol works by encrypting data while being transmitted over radio waves.

WFM

Wired for Management is Intel's broad-based initiative to reduce the total cost of ownership (TCO) of business computing without sacrificing power and flexibility.

Wi-Fi Compatible

Wi-Fi (**Wireless Fidelity**) identifies that the product has passed the interoperability test, supplied by the WECA (**Wireless Ethernet Compatibility Alliance**), which guarantees the interoperability of wireless IEEE 802.11 LAN products. For more information on the Wi-Fi standard, go to the WECA website at: www.wirelessethernet.com.

Write Protect

Prevent alteration of the binary state of all bits in a storage media. Example: all information on a device such as a floppy diskette; a block of space in a storage media such as a partition of a hard drive; a file or directory of floppy diskette or hard drive.

XGA

Extended graphics array. Standard that provides resolutions of 640x480 or 1024x764, supporting 64k colors.

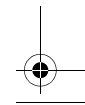
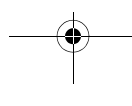
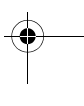
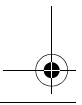
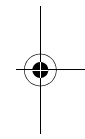
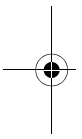

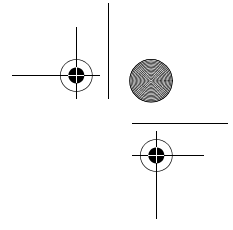
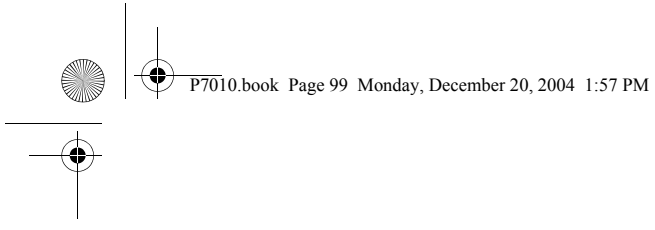

Appendix A

Using the Fingerprint Sensor*

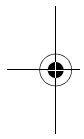

* Optional Device

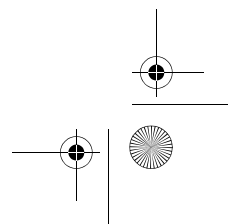
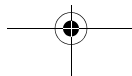
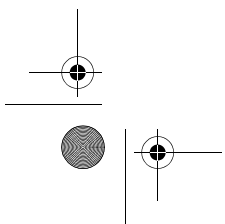
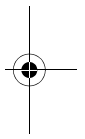

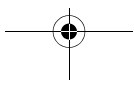
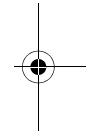
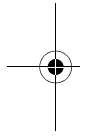

Fingerprint Sensor Device

INTRODUCING THE OPTIONAL FINGERPRINT SENSOR DEVICE

Your system may have an optional fingerprint sensor device in the location at which other models have a scroll button. (Figure 1)

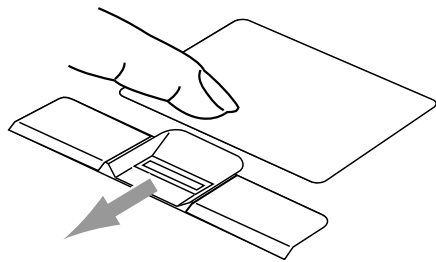

Figure A-1 Fingerprint sensor



Although the system may have a fingerprint sensor in place of a scroll button, the fingerprint sensor can be used for scrolling. Simply move your fingerprint over the sensor the same as you would use a scroll button.

With a fingerprint sensor, you can avoid having to enter a username and password every time you want to:

- Log onto Windows
- Recover from suspend mode
- Cancel a password-protected screen saver
- Log into homepages that require a username and password

After you have “enrolled” - or registered - your fingerprint, you can simply swipe your fingertip over the sensor for the system recognize you.

The fingerprint sensor uses Softex OmniPass which provides password management capabilities to Microsoft Windows operating systems. OmniPass enables you to use a “master password” for all Windows, applications, and on-line passwords.

OmniPass requires users to authenticate themselves using the fingerprint sensor before granting access to the Windows desktop. This device results in a secure authentication system for restricting access to your computer, applications, web sites, and other password-protected resources.

OmniPass presents a convenient graphical user interface, through which you can securely manage passwords, users, and multiple identities for each user.

GETTING STARTED

This section guides you through the preparation of your system for the OmniPass fingerprint recognition application. You will be led through the OmniPass installation process. You will also be led through the procedure of enrolling your first user into OmniPass.

INSTALLING OMNIPASS

If OmniPass has already been installed on your system, skip this section and go directly to “User Enrollment” on page 102. You can determine whether OmniPass has already been installed by checking to see if the following are present:

- The presence of the gold key-shaped OmniPass icon in the system tray at the bottom right of the screen.
- The presence of the Softex program group in the Programs group of the Start menu

System Requirements

The OmniPass application requires space on your hard drive; it also requires specific Operating Systems (OS's). The minimum requirements are as follows:

- Windows XP Home Edition or Windows XP Professional operating system
- At least 35 MB available hard disk space

Installing the OmniPass Application

If OmniPass is already installed on your system, go to “User Enrollment” on page 102. Otherwise continue with this section on software installation.



For installation, OmniPass requires that the user installing OmniPass have administrative privileges to the system. If your current user does not have administrative privileges, log out and then log in with an administrator user before proceeding with OmniPass installation.

To install OmniPass on your system you must:

1. Insert the installation media for the OmniPass application into the appropriate drive. If you are installing from CD-ROM or DVD-ROM, you must find and launch the OmniPass installation program (setup.exe) from the media.
2. Follow the directions provided in the OmniPass installation program. Specify a location to which you would like OmniPass installed. It is recommended that you NOT install OmniPass in the root directory (e.g. C:\).
3. Once OmniPass has completed installation you will be prompted to restart your system. Once your system has rebooted you will be able to use OmniPass. If you choose not to restart immediately after installation, OmniPass will not be available for use until the next reboot.

The installation program automatically places an icon (Softex OmniPass) in the Windows Control Panel as well as a golden key shaped icon in the taskbar.

Verifying Information about OmniPass

After you have completed installing OmniPass and restarted your system, you may wish to check the version of OmniPass on your system.

To check the version information of OmniPass:

1. From the Windows Desktop, double-click the key-shaped OmniPass icon in the taskbar (usually located in the lower right corner of the screen), or, Click the **Start** button, select **Settings**, and click **Control Panel** (if you are using Windows XP you will see the Control Panel directly in the Start menu; click it, then click **Switch to Classic View**). Double-click **Softex OmniPass** in the Control Panel, and the OmniPass Control Center will appear. If it does not appear, then the program is not properly installed, or, Click the **Start** button, select **Programs**, and from the submenu select the **Softex** program group, from that submenu click **OmniPass Control Center**.
2. Select the **About** tab at the top of the OmniPass Control Panel. The About tab window appears with version information about OmniPass.

Uninstalling OmniPass



For uninstallation, OmniPass requires that the user uninstalling OmniPass have administrative privileges to the system. If your current user does not have administrative privileges, log out and then log in with an administrator user before proceeding with OmniPass uninstallation.

To remove the OmniPass application from your system:

1. Click **Start** on the Windows taskbar. Select **Settings**, and then **Control Panel**.
2. Double-click **Add/Remove Programs**.
3. Select **OmniPass**, and then click **Change/Remove**.
4. Follow the directions to uninstall the OmniPass application.
5. Once OmniPass has finished uninstalling, reboot your system when prompted.

USER ENROLLMENT

Before you can use any OmniPass features you must first enroll a user into OmniPass.

Master Password Concept

Computer resources are often protected with passwords. Whether you are logging into your computer, accessing your email, e-banking, paying bills online, or accessing

network resources, you often have to supply credentials to gain access. This can result in dozens of sets of credentials that you have to remember.

During OmniPass user enrollment a "master password" is created for the enrolled user. This master password "replaces" all other passwords for sites you register with OmniPass.

Example: A user, John, installs OmniPass on his system (his home computer) and enrolls an OmniPass user with username "John_01" and password "freq14". He then goes to his webmail site to log onto his account. He inputs his webmail credentials as usual (username "John_02" and password "lifebook"), but instead of clicking [Submit], he directs OmniPass to **Remember Password**. Now whenever he returns to that site, OmniPass will prompt him to supply access credentials.

John enters his OmniPass user credentials ("John_01" and "freq14") in the OmniPass authentication prompt, and he is allowed into his webmail account. He can do this with as many web sites or password protected resources he likes, and he will gain access to all those sites with his OmniPass user credentials ("John_01" and "freq14"). This is assuming he is accessing those sites with the system onto which he enrolled his OmniPass user. OmniPass does not actually change the credentials of the password protected resource. If John were to go to an Internet cafe to access his webmail, he would need to enter his original webmail credentials ("John_02" and "lifebook") to gain access. If he attempts his OmniPass user credentials on a system other than where he enrolled that OmniPass user, he will not gain access.



The enrollment procedure assumes you have no hardware authentication devices or alternate storage locations that you wish to integrate with OmniPass. If you desire such functionality, consult the appropriate sections of this document.

Basic Enrollment

The Enrollment Wizard will guide you through the process of enrolling a user. Unless you specified otherwise, after OmniPass installation the Enrollment Wizard will launch on Windows login. If you do not see the Enrollment Wizard, you can bring it up by clicking **Start** on the Windows taskbar; select **Programs**; select **Softex**; click **OmniPass Enrollment Wizard**.

1. Click **Enroll** to proceed to username and password verification. By default, the OmniPass Enrollment Wizard enters the credentials of the currently logged in Windows user.
2. Enter the password you use to log in to Windows. This will become the "master password" for this OmniPass user. In most cases, the **Domain:** value

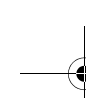

Using the Fingerprint Sensor

- will be your Windows computer name. In a corporate environment, or when accessing corporate resources, the **Domain:** may not be your Windows computer name. Click [Next] to continue.
- In this step OmniPass captures your fingerprint. Refer to “Enrolling a Fingerprint” on page 103 for additional information.
 - Next, choose how OmniPass notifies you of various events. We recommend you keep **Taskbar Tips on Beginner mode taskbar tips** and **Audio Tips** on at least **Prompt with system beeps only** until you get accustomed to how OmniPass operates. Click [Next] to proceed with user enrollment. You will then see a Congratulations screen indicating your completion of user enrollment.
 - Click [Done] to exit the OmniPass Enrollment Wizard. You will be asked if you’d like to log in to OmniPass with your newly enrolled user; click [Yes].

Enrolling a Fingerprint

Enrolling a fingerprint will increase the security of your system and streamline the authentication procedure.

You enroll fingerprints in the OmniPass Control Center. With an OmniPass user logged in, double-click the system tray OmniPass icon. Select the **User Settings** tab and click **Enrollment** under the **User Settings** area. Click **Enroll Authentication Device** and authenticate at the authentication prompt to start device enrollment.

- During initial user enrollment, you will be prompted to select the finger you wish to enroll. Fingers that have already been enrolled will be marked by a green check. The finger you select to enroll at this time will be marked by a red arrow. OmniPass will allow you re-enroll a finger. If you choose a finger that has already been enrolled and continue enrollment, OmniPass will enroll the fingerprint, overwriting the old fingerprint. Select a finger to enroll and click [Next].
- It is now time for OmniPass to capture your selected fingerprint. It may take a several capture attempts before OmniPass acquires your fingerprint. Should OmniPass fail to acquire your fingerprint, or if the capture screen times out, click [Back] to restart the fingerprint enrollment process.

Your system has a “swipe” fingerprint sensor. A swipe sensor is small and resembles a skinny elongated rectangle. To capture a fingerprint, gently swipe or pull your fingertip over the sensor (starting at the second knuckle) **towards yourself**. Swiping too fast or too slow will result in a failed capture. The **Choose Finger** screen has a [Practice] button; click it to practice capturing your fingerprint. When you are comfortable with how your fingerprint is captured, proceed to enroll a finger.

- Once OmniPass has successfully acquired the fingerprint, the **Verify Fingerprint** screen will automatically appear. To verify your enrolled fingerprint, place your fingertip on the sensor and hold it there as if you were having a fingerprint captured. Successful fingerprint verification will show a green fingerprint in the capture window and the text **Verification Successful** under the capture window.

USING OMNIPASS

You are now ready to begin using OmniPass. Used regularly, OmniPass will streamline your authentications.

Password Replacement

You will often use the password replacement function. When you go to a restricted access website (e.g., your bank, your web-based email, online auction or payment sites), you are always prompted to enter your login credentials. OmniPass can detect these prompts and you can teach OmniPass your login credentials. The next time you go to that website, you can authenticate with your fingerprint to gain access.

OmniPass Authentication Toolbar

After installing OmniPass and restarting, you will notice a dialog you have not seen before at Windows Logon. This is the OmniPass Authentication Toolbar, and it is displayed whenever the OmniPass authentication system is invoked. The OmniPass authentication system may be invoked frequently: during Windows Logon, during OmniPass Logon, when unlocking your workstation, when resuming from standby or hibernate, when unlocking a password-enabled screensaver, during password replacement for remembered site or application logins, and more. When you see this toolbar, OmniPass is prompting you to authenticate.

The **Logon Authentication** window indicates what OmniPass-restricted function you are attempting. The icons in the lower left (fingerprint and key) show what authentication methods are available to you. Selected authentication methods are highlighted while unselected methods are not. When you click the icon for an unselected authentication method, the authentication prompt associated with that method is displayed.

When prompted to authenticate, you must supply the appropriate credentials: an enrolled finger for the fingerprint capture window or your master password for the master password prompt (the key icon).

Remembering a Password

OmniPass can remember any application, GUI, or password protected resource that has a password prompt.

Using the following procedure, you can store a set of credentials into OmniPass. These credentials will then be linked to your “master password” or fingerprint.

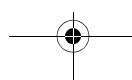

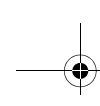

Go to a site that requires a login (username and password), but *do not log in yet*. At the site login prompt, enter your username and password in the prompted fields, but *do not enter the site* (do not hit [Enter], [Submit], [OK], or Login). Right-click the OmniPass system tray icon and select **Remember Password** from the submenu. The Windows arrow cursor will change to a golden key OmniPass cursor. Click this OmniPass cursor in the login prompt area, but do not click the [Login] or [Submit] button.

Associating a Friendly Name

After clicking the OmniPass key cursor near the login prompt, OmniPass will prompt you to enter a “friendly name” for this site. You should enter something that reminds you of the website, the company, or the service you are logging into. In its secure database, OmniPass associates this friendly name with this website.

Additional Settings for Remembering a Site

When OmniPass prompts you to enter a “friendly name” you also have the opportunity to set how OmniPass authenticates you to this site. There are three effective settings for how OmniPass handles a remembered site.

The default setting is **Automatically click the “OK” or “Submit” button for this password protected site once the user is authenticated**. With this setting, each time you navigate to this site OmniPass will prompt you for your master password or fingerprint authentication device. Once you have authenticated with OmniPass, you will automatically be logged into the site.

Less secure is the option to **Automatically enter this password protected site when it is activated. Do not prompt for authentication**. Check the upper box to get this setting, and each time you navigate to this site OmniPass will log you into the site without prompting you to authenticate.



This setting is more convenient in that whenever you go to a site remembered with this setting, you will bypass any authentication procedure and gain instant access to the site. But should you leave your system unattended with your OmniPass user logged in, anyone using your system can browse to your password protected sites and gain automatic access.

If you uncheck both boxes in **Settings for this Password Site**, OmniPass will prompt you for your master password or fingerprint authentication device. Once you have authenticated with OmniPass your credentials will be filled in to the site login prompt, but you will have to click the website [OK], [Submit], or [Login] button to gain access to the site.

Click **Finish** to complete the remember password procedure. The site location, the credentials to access the site, and the OmniPass authentication settings for the site are now stored in the OmniPass secure database. The OmniPass authentication settings (**Settings for this Password Site**) can always be changed in **Vault Management**.

Logging in to a Remembered Site

Whether or not OmniPass prompts you to authenticate when you return to a remembered site is determined by **Settings for this Password Site** and can be changed in **Vault Management**.

The following cases are applicable to using OmniPass to login to: Windows, remembered web sites, and all other password protected resources.

With Master Password

Once you return to a site you have remembered with OmniPass, you may be presented with a master password prompt. Enter your master password and you will be allowed into the site.

Logging into Windows with a Fingerprint Device

When logging into Windows with a fingerprint device, the fingerprint capture window will now appear next to the Windows Login screen. Place your enrolled fingertip on the sensor to authenticate. You will be simultaneously logged into Windows and OmniPass. The capture window will also appear if you have used **Ctrl-Alt-Del** to lock a system, and the fingerprint device can be used to log back in as stated above.



If a machine is locked and OmniPass detects a different user logging back in with a fingerprint, the first user will be logged out and the second user logged in.

In Windows XP, your login options must be set either for classic login, or for fast user switching and logon screen to be enabled to use your fingerprint to log on to Windows. To change this go to **Control Panel**, select **User Accounts** and then click **Change the way users log on or off**. If your Windows screensaver is password protected, the fingerprint capture window will now appear next to screensaver password dialog during resume. You can authenticate to your screensaver password prompt with your enrolled finger.

Password Management

OmniPass provides an interface that lets you manage your passwords. To access this GUI, double-click the OmniPass key in the system tray. Click **Vault Management**; you will be prompted to authenticate. Once you gain access to **Vault Management**, click **Manage Passwords** under **Vault Settings**. You will see the **Manage Passwords** interface, with a list of friendly names.



You can view the credentials stored for any remembered website by highlighting the desired resource under **Password Protected Dialog** and clicking **Unmask Values**. Should a password be reset, or an account expire, you can remove stored credentials from OmniPass. Highlight the desired resource under **Password Protected Dialog** and click **Delete Page**. You will be prompted to confirm the password deletion.

The two check boxes in **Manage Passwords** govern whether OmniPass prompts you to authenticate or directly logs you into the remembered site.

OmniPass will overwrite an old set of credentials for a website if you attempt to use **Remember Password** on an already remembered site.

The exception to the above rule is the resetting of your Windows password. If your password is reset in Windows, then the next time you login to Windows, OmniPass will detect the password change and prompt you to "Update" or "Reconfirm" your password with OmniPass. Enter your new Windows password in the prompt(s) and click **OK** and your OmniPass "master password" will still be your Windows password.

OmniPass User Identities

Identities allow OmniPass users to have multiple accounts to the same site (e.g., *bob@biblomail.com* and *boballen@biblomail.com*). If OmniPass did not provide you identities, you would be limited to remembering one account per site.

To create and manage identities, double-click the OmniPass key in the system tray. Click **Vault Management**; OmniPass will prompt you to authenticate. Once you gain access to **Vault Management**, click **Manage Identities** under **Vault Settings**. You can only manage the identities of the currently logged in OmniPass user.

To add a new identity, click **New Identity** or double-click **Click here to add a new identity**. Name the new identity and click [OK], then click [Apply]. You can now switch to the new identity and start remembering passwords.

To delete an identity, highlight the identity you want to delete and click [Delete Identity], then click [Apply].



When you delete an identity, all of its associated remembered sites and password protected dialogs are lost.

To set the default identity, highlight the identity you want as default and click [Set as Default]; click [Apply] to ensure the settings are saved. If you log in to OmniPass with a fingerprint device, you will automatically be logged in to the default identity for that OmniPass user. You can choose the identity with which you are logging in if you login using "master password".

Choosing User Identity during Login

To choose your identity during login, type your username in the **User Name:** field. Press [Tab] and see that the **Domain:** field self-populates. Click the **Password:** field to bring the cursor to it, and you will see the pull-down menu in the **Identity:** field. Select the identity you wish to login as and then click **OK** to login.

Switch User Identity

To switch identities at any time, right-click the OmniPass system tray icon and click **Switch User Identity** from the submenu. The **Switch Identity** dialog will appear. Select the desired identity and then click **OK**.

Identities and Password Management

On the **Manage Passwords** interface of the **Vault Management** tab of the OmniPass Control Center, there is a pull-down selection box labeled, **Identity**. This field lets you choose which identity you are managing passwords for. When you select an identity here, only those password protected dialogs that are associated with that identity are shown. You can perform all the functions explained in "Password Management" on page 104.

CONFIGURING OMNIPASS

This section gives an overview of both the Export/Import function and the OmniPass Control Center.

Exporting and Importing Users

Using the OmniPass Control Center, you can export and import users in and out of OmniPass. The export process backs up all remembered sites, credentials, and any enrolled fingerprints for an OmniPass user. All OmniPass data for a user is backed up to a single encrypted database file. During the import process, the Windows login of the exported user is required. If the proper credentials cannot be supplied, the user profile will not be imported.



- You should periodically export your user profile and store it in a safe place. If anything happens to your system, you can import your OmniPass profile to a new system and have all your remembered settings and fingerprints instantly.
- You don't forget the Windows login credentials when exporting. When you examine the importation, you are prompted for authentication. The credentials that will allow a user profile to be imported are the Windows login credentials of the exported user. They are the credentials that had to be submitted when the user profile was exported. You will need User Name, Password, and Domain.

Exporting an OmniPass User Profile

To export a user, open the OmniPass Control Center, and click **Import/Export User** under **Manage Users**.

Click **Exports an OmniPass user profile**. OmniPass will prompt you to authenticate. Upon successfully authentication, you must name the OmniPass user profile and decide where to save it. An .opi file is generated, and you should store a copy of it in a safe place.

This .opi file contains all your user specific OmniPass data, and it is both encrypted and password protected. This user profile does NOT contain any of your encrypted data files.

Importing an OmniPass User Profile



You cannot import a user into OmniPass if there already is a user with the same name enrolled in OmniPass.

To import an OmniPass user open the OmniPass Control Center, and click **Import/Export User** under **Manage Users**. Click **Imports a new user into OmniPass** and then select **OmniPass Import/Export File (*.opi)** and click **Next**. OmniPass will then prompt you to browse for the file you had previously exported (.opi file). When you select the .opi file for importation, OmniPass will prompt you for authentication. The credentials that will allow a user profile to be imported are the Windows login credentials of the exported user. They are the credentials that had to be submitted when the user profile was exported. You will need **User Name**, **Password**, and **Domain**. If you don't remember the value for **Domain**, in a PC or SOHO environment **Domain** should be your computer name.

OmniPass will notify you if the user was successfully imported.

Things to Know Regarding Import/Export

- Assume you export a local Windows User profile from OmniPass. You want to import that profile to another machine that has OmniPass. Before you can import the profile, a Windows user with the same login credentials must be created on the machine importing the profile.

Example: I have a Windows user with the username "Tom" and the password "Sunshine" on my system. I have enrolled Tom into OmniPass and remembered passwords. I want to take all my passwords to new system. I export Tom's OmniPass user profile. I go to my new system and using the Control Panel I create a user with the username "Tom" and the password "Sunshine". I can now successfully import the OmniPass user data to the new system.

- If you export an OmniPass-only user, you can import that user to any computer running OmniPass, provided that a user with that name is not already enrolled in OmniPass.
- If you attempt to import a user profile who has the same name as a user already enrolled in OmniPass, the OmniPass import function will fail.

OMNIPASS CONTROL CENTER

This section will serve to explain functions within the OmniPass Control Center that weren't explained earlier.

You can access the OmniPass Control Center any of three ways:

- Double-click the golden OmniPass key shaped icon in the Windows taskbar (typically in the lower-right corner of the desktop)
- Click the **Start** button; select the **Programs** group; select the **Softex** program group; and click the **OmniPass Control Center** selection.
- Open the **Windows Control Panel** (accessible via **Start** button --> **Settings** --> **Control Panel**) and double-click the **Softex OmniPass** icon.

User Management

The User Management tab has two major interfaces: **Add/Remove User** and **Import/Export User**. **Import/Export User** functionality is documented in "Exporting and Importing Users" on page 105. **Add/Remove User** functionality is straightforward.

If you click **Adds a new user to OmniPass** you will start the OmniPass Enrollment Wizard. The Enrollment Wizard is documented in "User Enrollment" on page 102.

If you click **Removes a user from OmniPass**, OmniPass will prompt you to authenticate. Authenticate with the credentials (or enrolled fingerprint) of the user you wish to remove. OmniPass will prompt you to confirm user removal. Click **OK** to complete user removal.



Removing a user will automatically destroy all OmniPass data associated with that user. All identities and credentials associated with the user will be lost.

If you are sure about removing the user, we recommend you export the user profile.

User Settings

The User Settings tab has four interfaces: **Audio Settings**, **Taskbar Tips**, and **Enrollment**. User settings allow users to customize OmniPass to suit their individual preferences. Under **User Settings (Audio Settings and Taskbar Tips)** you can set how OmniPass notifies the user of OmniPass events (e.g., successful login, access denied,

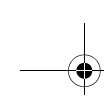

etc.). The details of each setting under the **Audio Settings** and **Taskbar Tips** interfaces are self-explanatory.

The **Enrollment** interface allows you to enroll fingerprints. For the procedure to enroll and authentication device refer to *Chapter 2.3*. To enroll additional fingerprints, click **Enroll Authentication Device**, and authenticate with OmniPass. Select the fingerprint recognition device in the **Select Authentication Device** screen (it should already be marked by a green check if you have a finger enrolled) and click **Next**.

System Settings

The OmniPass **Startup Options** interface can be found in the System Settings tab. With these options you can specify how your OmniPass Logon is tied to your Windows Logon.

The first option, **Automatically log on to OmniPass as the current user**, will do just as it says; during Windows login, you will be logged on to OmniPass using your Windows login credentials. If the user logging into Windows was never enrolled into OmniPass, upon login no one will be logged on to OmniPass. This setting is appropriate for an office setting or any setting where users must enter a username and password to log into a computer. This is the default setting.

With the second option, **Manually log on to OmniPass at startup**, OmniPass will prompt you to login once you have logged on to Windows.

With the third option, **Do not log on to OmniPass at startup**, OmniPass will not prompt for a user to be logged on.

You can manually log on to OmniPass by right-clicking the OmniPass taskbar icon and clicking **Log in User** from the right-click menu.

TROUBLESHOOTING

You cannot use OmniPass to create Windows users. You must first create the Windows user, and you will need administrative privileges to do that. Once the Windows user is created, you can add that user to OmniPass using the same username and password

Cannot add Windows users to OmniPass

If you experience difficulties adding a Windows user to OmniPass, you may need to adjust your local security settings. You can do this by going to **Start, Control Panel, Administrative Tools, and Local Security Settings**. Expand **Local Policies**, expand **Security Options**, and double-click **Network Access: Sharing and Security Model for Local Accounts**. The correct setting should be *Classic - Local Users Authenticate as Themselves*.

Cannot add a User with a Blank Password to OmniPass

If you experience difficulties adding a user with a blank password to OmniPass, you may need to adjust your local security settings. First attempt the procedure explained in the *Cannot add Windows user to OmniPass* section. If the difficulties persist, then try the following procedure.

Click **Start, Control Panel, Administrative Tools, and Local Security Settings**. Expand **Local Policies**, expand **Security Options**, and double-click **Accounts: Limit local account use of blank passwords to console login only**. This setting should be set to **Disabled**.

Dialog appears after OmniPass authentication during Windows Logon

After installing OmniPass on your system, you can choose to logon to Windows using OmniPass. You authenticate with OmniPass (via master password, or an enrolled security device) and OmniPass logs you into Windows. You may, during this OmniPass authentication, see a **Login Error** dialog box.

This dialog box occurs when OmniPass was unable to log you into Windows with the credentials supplied (username and password). This could happen for any of the following reasons:

- Your Windows password has changed
- Your Windows account has been disabled

If you are having difficulties due to the first reason, you will need to update OmniPass with your changed Windows account password. Click **Update Password** and you will be prompted with a dialog to reconfirm your password.

Enter the new password to your Windows user account and click **OK**. If the error persists, then it is unlikely the problem is due to your Windows user account password changing.

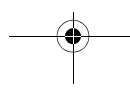
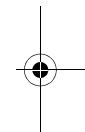
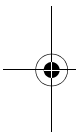

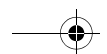
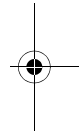
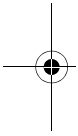
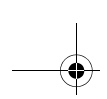

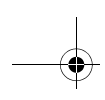

Index

A

- AC
 - adapter 23, 97
 - plug adapters 81
- Anti-theft lock slot 10
- Auto Insert Notification 36
- Auto/Airline Adapter 23, 97
- Automatically Downloading Driver Updates 78

B

- Battery 31
 - alarm 31
 - battery bay release button 11
 - care 82
 - charging indicator 12
 - conserving power 27
 - increasing life 82
 - level indicators 12
 - lithium ion battery 31, 98
 - low 31
 - recharging 31
 - replacing 32
 - shorted 32
 - suspend mode 31
 - swapping 32
- BIOS 97
 - guide 26
 - setup utility 25
- Boot 97
 - sequence 25
- Built-in Microphone 6

C

- Cache Memory 97
- Click Me! 26
- Cold-swap 18
- Compact Flash
 - card slot 8
 - eject button 8
- Configuration Label 11
- Contact Information 1
- Cursor control 15
- Cursor Keys 14

D

- DC
 - output cable 23
 - power jack 8, 23
- Device Ports 44
- DIMM 42
- Disk care 82
- Display Panel 7, 24
 - adjusting 24
 - brightness 24
 - closing 24
 - opening 24
- Display Timeout 28
- Dolby Headphone 35
- Drivers and Application Restore CD 77
- DVD/CD-RW drive
 - control panel 35
 - loading 34
 - removing 35
 - software 35
 - tray release 76
 - using 36
- DVD-RAM 34

E

- Error Messages 75
- Extended Memory 98
- External Floppy Disk Drive 33
- External Monitor Port 9, 46

F

- FDU 78
- Fingerprint Sensor Device 103
 - enrolling a fingerprint 105
 - getting started 103
 - installing OmniPass 103
 - logging into a remembered site 106
 - OmniPass authentication toolbar 105
 - password replacement 105
 - remembering a password 105
 - uninstalling OmniPass 104
 - user enrollment 104
 - using OmniPass 105
- Firewire 9, 45

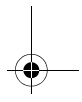
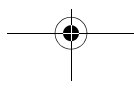
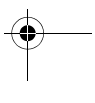
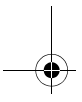
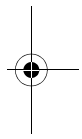
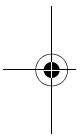

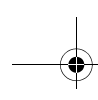

F

Flexible bay 8, 18
 cold-swapping 18
 hot-swapping 19
 installing 18
 release latch 11
 removing 18

Floppy Disk
 ejecting 33
 formatting 33
 initializing 33
 loading 33
 preparing 33
 write protect 33

Floppy Disk Drive
 care 82

Fujitsu Driver Update utility 78

Fujitsu HotKey Utility 89

Fujitsu LifeBook
 care and maintenance 81
 traveling 81

Function Key
 F10 14
 F3 14
 F4 14
 F5 14
 F6 14
 F7 14
 F8 14
 F9 14
 Fn 14

H

Hard Disk Timeout 28

Hard Disk/CD Access Indicator 12

Headphone Jack 9, 45

Hibernation Feature 27
 disable/enable 28

Hot-swapping 19

I

IEEE 1394 port 9, 45

Indicators
 Caps Lock 6
 Num Lock 6
 Scroll Lock 6

Integrated Wireless LAN 47

Internal LAN port 44

K

Keyboard6, 13
 cursor keys13
 function keys13
 key indicator lights13
 numeric keypad13
 Windows keys13
 windows keys13

L

LAN (RJ-45) port9

Lithium ion Battery11

M

Memory
 capacity43
 installing42
 removing43

Memory Module Cover11

Memory Stick/SD Card6
 installing40
 removing41
 slot6, 40

Memory Upgrade Module42

Microphone6

Microphone Jack9, 46

Modem8
 port44
 result codes76

Modular Devices18
 installing18
 removing18

N

Numeric Keypad13

O

Optical Digital
 audio connector46
 audio-out jack9

Optical Drive34
 care83
 DVD/CD-RW combo34
 emergency tray release36
 software34



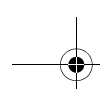

Index

P

PC Card
 care 83
 eject button 8
 installing 37, 38
 removing 37, 39
 slot 8

Port Access Doors 9

POST 75, 99
 error messages 75

Power
 AC adapter 23
 auto/airline adapter 23
 management 27
 off 28
 sources 23

Power Management 27, 28

Power On 25

Power On Self Test 75

Pre-Installed Software 89
 Adobe Acrobat Reader 89
 Earthlink 5.0 89
 manuals 89
 Netscape 89
 Norton AntiVirus 2004 89
 Quicken New User Edition 89
 tutorials 89

Pre-installed Software
 restoring 77

PS/2 99

R

Registration 26

Regulatory Information 91

Re-Installing Individual Drivers and Applications 77

Restarting 28

Restoring software 77

Restoring the Factory Image 77

RJ-11 8, 44

RJ-45 9, 44

S

SD Card
 installing 40
 removing 41

SDRAM 42

Secure Digital Card

removing 41

Serial Port 99

Specifications 87
 audio 87
 device ports 88
 dimensions and weight 88
 environmental requirements 88
 features 87
 keyboard 88
 mass storage device options 87
 memory 87
 microprocessor 87
 MS Works 89
 popular accessories 88
 power 88
 video 87

Status Indicator Panel 7, 12

Stereo Speakers 6

Suspend 27, 100

Suspend/Resume/Power On Button 7, 27

S-Video Out Port 9, 45

Swapping batteries 32

System Specifications 87

T

Touchpad 15
 buttons 15
 clicking 15
 controls 16
 double-clicking 15
 dragging 16
 pointing device 6
 scroll button 6
 scrolling 16

Troubleshooting 67
 battery 71
 built-in speakers 68
 CD-ROM 68
 display panel 73
 DVD/CD-RW drive 68
 hard disk drive 69
 identifying the problem 67
 keyboard 69
 memory 70
 modem 70
 mouse 69
 PC card 70
 power 71, 72
 USB 70

Troubleshooting Table 68

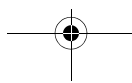

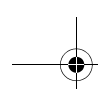

U

Universal Serial Bus Ports 9, 45

V

Volume Control 17

W

Warranty 1

Windows keys 13

 application key 13

 start keys 13

Wireless LAN

 access point (infrastructure) mode 51

 activating the WLAN device 52

 ad hoc mode 50

 before using the wireless LAN 50

 configuration 53

 deactivating the WLAN device 51

 devices covered by this document 50

 IP address information 63

 modes 50

 on/off switch 6

 specifications 64

 troubleshooting 60

 using Atheros Client Utility software 55

 using Intel PROSet software 54

 using Wireless Zero Configuration Tool 53

 wireless LAN glossary 61

 wireless network considerations 51

