



Modular Approval
Test Report
And Application for Grant of Equipment Authorization

TEST REPORT PERTAINING TO:

Equipment Under Test	Model Number(s)
Intel® Centrino® Ultimate-N 6200	622ANHMW

CONFIGURATION
IEEE 802.11a / 802.11b / 802.11g / 802.11n with a set of Shanghai Universe Communication Electron Co.,Ltd. Antennas

MEASUREMENTS PERFORMED IN ACCORDANCE WITH THE FOLLOWING STANDARD (S)

Regulatory Standard(s)
47 CFR Part 15, Subpart C Section 15.247
Test Method: ANSI C63.4: 2003 American National Standard for Methods of Measurement of Radio-Noise Emissions from Low-Voltage Electrical and Electronic Equipment in the Range of 9 kHz to 40 GHz



Certificate Number: 1111.01

PREPARED FOR:

Intel Corporation
2111 NE 25th Avenue
Hillsboro, Oregon 97124
Contact(s): Mr. Steve Hackett

PREPARED BY:

Aegis Labs, Inc.
8 Rancho Circle
Lake Forest, CA 92630
Agent(s): Mr. Rick Candelas
Mr. Johnny Candelas



Test Report #: INTEL-090601F

Test Report Revision: NONE

	REPORT BODY	APPENDICES		TOTAL PAGES
		A	B	
PAGES	24	182	1	207

The contents of this report shall not be reproduced except in full, without the written approval of Aegis Labs, Inc.
The Intel logo is used for identification purposes only and is a registered trademark of Intel Corporation



TABLE OF CONTENTS

SECTION	TITLE	PAGE
	COVER SHEET.....	01
	TABLE OF CONTENTS.....	02
1.0	REGULATORY COMPLIANCE GUIDELINES.....	03
1.1	Guidelines For Testing To Emissions Standards.....	03
2.0	SUMMARY OF REGULATORY LIMITS.....	04
3.0	ADMINISTRATIVE DATA AND TEST DESCRIPTION.....	18
4.0	DESCRIPTION OF EUT CONFIGURATION.....	19
4.1	EUT Description	19
4.2	EUT Configuration.....	20
4.3	List of EUT Sub-Assemblies and Host Equipment.....	20
4.4	I/O Cabling Diagram and Description	21
4.5	EMC Test Hardware and Software Measurement Equipment.....	22
5.0	CONDITIONS DURING EMISSIONS MEASUREMENTS.....	23
5.1	General.....	23
5.2	Conducted Emissions Test Setup.....	23
5.3	Radiated Emissions Test Setup.....	24

APPENDICES

A	Test Data
B	Modifications And Recommendations



1.0 REGULATORY COMPLIANCE GUIDELINES

Aegis Labs, Inc. operates as both a Nevada and California Corporation with no organizational or financial relationship with any company, institution, or private individual. Testing and engineering functions provided by Aegis Labs were furnished by RF technicians and engineers with accredited qualifications and training credentials to carry out their duties.

The object of this report was to publish verifiable test results of an EUT subjected to the tests outlined in the standard listed on the cover page of this report.

1.1 Guidelines For Testing To Emissions Standards

This standard for EMC emission requirements apply to electrical equipment for Information Technology Equipment (ITE). Compliance to these standards and in combination with the other standards listed in this test report can be used to demonstrate presumption of compliance with the protection requirements of the appropriate agency standard.

The purpose of this standard is to specify minimum requirements for emissions regarding electromagnetic compatibility (EMC) and protect the radio frequency spectrum 9 kHz. – 400 GHz. from unwanted interference generated from electrical/digital systems that intentionally or unintentionally generated RF energy. The emissions standards, normative documents and/or publications were used to conduct all tests performed on the equipment herein referred to as “Equipment Under Test”.



2.0 SUMMARY OF TEST RESULTS

802.11a Mode (5745-5825 MHz) Chain A

EMISSIONS STANDARD

FCC Part 15 Section	Description	Results	Comments
15.247(a)(2)	The minimum 6dB bandwidth shall be at least 500 kHz.	PASSED	5745 MHz = 16.25 MHz 5785 MHz = 16.25 MHz 5825 MHz = 16.00 MHz
15.247(b)(3)	The maximum conducted output power is the highest total transmit power occurring in any mode	PASSED	5745 MHz = 16.74 dBm = 47.25 mW 5785 MHz = 16.94 dBm = 49.47 mW 5825 MHz = 16.64 dBm = 46.17 mW
15.247(b)(5)	The intentional radiator shall be operated in a manner that ensures that the public is not exposed to radio frequency energy levels in excess of the FCC guidelines per Section 1.1307(b)(1).	PASSED	Refer to MPE Calculations
15.247(d)	In any 100 kHz bandwidth outside the frequency band in which the spread spectrum intentional radiator is operating, the radio frequency power that is produced by the intentional radiator shall be at least 20 dB below that in the 100 kHz bandwidth within the band that contains the highest level of the desired power.	PASSED	See Data Sheets (Appendix A)
15.247(d)	Radiated emissions, which fall in the restricted bands, as defined in Sec. 15.205(a), must also comply with the radiated emission limits specified in Sec. 15.209(a). All others must be < -20dBc.	PASSED	See Data Sheets (Appendix A)
15.247(e)	The power spectral density conducted from the intentional radiator to the antenna shall not be greater than 8 dBm in any 3 kHz band during any time interval of continuous transmission.	PASSED	5745 MHz = -8.77 dB 5785 MHz = -8.63 dB 5825 MHz = -9.49 dB
15.207	AC Conducted Emissions	PASSED	See Data Sheets (Appendix A)
15.209	Radiated Emissions (30-1000 MHz)	PASSED	



2.0 Summary of Test Results (Continued)

802.11a Mode (5745-5825 MHz) Chain B

EMISSIONS STANDARD

FCC Part 15 Section	Description	Results	Comments
15.247(a)(2)	The minimum 6dB bandwidth shall be at least 500 kHz.	PASSED	5745 MHz = 16.25 MHz 5785 MHz = 16.17 MHz 5825 MHz = 16.58 MHz
15.247(b)(3)	The maximum conducted output power is the highest total transmit power occurring in any mode	PASSED	5745 MHz = 16.64 dBm = 46.17 mW 5785 MHz = 16.84 dBm = 48.35 mW 5825 MHz = 16.94 dBm = 49.47 mW
15.247(b)(5)	The intentional radiator shall be operated in a manner that ensures that the public is not exposed to radio frequency energy levels in excess of the FCC guidelines per Section 1.1307(b)(1).	PASSED	Refer to MPE Calculations
15.247(d)	In any 100 kHz bandwidth outside the frequency band in which the spread spectrum intentional radiator is operating, the radio frequency power that is produced by the intentional radiator shall be at least 20 dB below that in the 100 kHz bandwidth within the band that contains the highest level of the desired power.	PASSED	See Data Sheets (Appendix A)
15.247(d)	Radiated emissions, which fall in the restricted bands, as defined in Sec. 15.205(a), must also comply with the radiated emission limits specified in Sec. 15.209(a). All others must be < -20dBc.	PASSED	See Data Sheets (Appendix A)
15.247(e)	The peak power spectral density conducted from the intentional radiator to the antenna shall not be greater than 8 dBm in any 3 kHz band during any time interval of continuous transmission.	PASSED	5745 MHz = -9.58 dB 5785 MHz = -10.40 dB 5825 MHz = -9.52 dB
15.207	AC Conducted Emissions	PASSED	See Data Sheets (Appendix A)
15.209	Radiated Emissions (30-1000 MHz)	PASSED	



2.0 Summary of Test Results (Continued)

802.11b Mode (2400-2483.5 MHz) Chain A

EMISSIONS STANDARD

FCC Part 15 Section	Description	Results	Comments
15.247(a)(2)	The minimum 6dB bandwidth shall be at least 500 kHz.	PASSED	2412 MHz = 10.33 MHz 2437 MHz = 10.33 MHz 2462 MHz = 10.33 MHz
15.247(b)(3)	The maximum conducted output power is the highest total transmit power occurring in any mode	PASSED	2412 MHz = 16.60 dBm = 45.71 mW 2437 MHz = 16.80 dBm = 44.67 mW 2462 MHz = 16.70 dBm = 46.77 mW
15.247(b)(5)	The intentional radiator shall be operated in a manner that ensures that the public is not exposed to radio frequency energy levels in excess of the FCC guidelines per Section 1.1307(b)(1).	PASSED	Refer to MPE Calculations
15.247(d)	In any 100 kHz bandwidth outside the frequency band in which the spread spectrum intentional radiator is operating, the radio frequency power that is produced by the intentional radiator shall be at least 20 dB below that in the 100 kHz bandwidth within the band that contains the highest level of the desired power.	PASSED	See Data Sheets (Appendix A)
15.247(d)	Radiated emissions, which fall in the restricted bands, as defined in Sec. 15.205(a), must also comply with the radiated emission limits specified in Sec. 15.209(a). All others must be < -20dBc.	PASSED	See Data Sheets (Appendix A)
15.247(e)	The peak power spectral density conducted from the intentional radiator to the antenna shall not be greater than 8 dBm in any 3 kHz band during any time interval of continuous transmission.	PASSED	2412 MHz = -5.12 dB 2437 MHz = -11.60 dB 2462 MHz = -11.90 dB
15.207	AC Conducted Emissions	PASSED	See Data Sheets (Appendix A)
15.209	Radiated Emissions (30-1000 MHz)	PASSED	



2.0 Summary of Test Results (Continued)

802.11b Mode (2400-2483.5 MHz) Chain B

EMISSIONS STANDARD

FCC Part 15 Section	Description	Results	Comments
15.247(a)(2)	The minimum 6dB bandwidth shall be at least 500 kHz.	PASSED	2412 MHz = 10.33 MHz 2437 MHz = 10.33 MHz 2462 MHz = 10.33 MHz
15.247(b)(3)	The maximum conducted output power is the highest total transmit power occurring in any mode	PASSED	2412 MHz = 16.80 dBm = 47.86 mW 2437 MHz = 16.60 dBm = 45.71 mW 2462 MHz = 16.80 dBm = 47.86 mW
15.247(b)(5)	The intentional radiator shall be operated in a manner that ensures that the public is not exposed to radio frequency energy levels in excess of the FCC guidelines per Section 1.1307(b)(1).	PASSED	Refer to MPE Calculations
15.247(d)	In any 100 kHz bandwidth outside the frequency band in which the spread spectrum intentional radiator is operating, the radio frequency power that is produced by the intentional radiator shall be at least 20 dB below that in the 100 kHz bandwidth within the band that contains the highest level of the desired power.	PASSED	See Data Sheets (Appendix A)
15.247(d)	Radiated emissions, which fall in the restricted bands, as defined in Sec. 15.205(a), must also comply with the radiated emission limits specified in Sec. 15.209(a). All others must be < -20dBc.	PASSED	See Data Sheets (Appendix A)
15.247(e)	The peak power spectral density conducted from the intentional radiator to the antenna shall not be greater than 8 dBm in any 3 kHz band during any time interval of continuous transmission.	PASSED	2412 MHz = -14.32 dB 2437 MHz = -11.65 dB 2462 MHz = -10.93 dB
15.207	AC Conducted Emissions	PASSED	See Data Sheets (Appendix A)
15.209	Radiated Emissions (30-1000 MHz)	PASSED	



2.0 Summary of Test Results (Continued)

802.11g Mode (2400-2483.5 MHz) Chain A

EMISSIONS STANDARD

FCC Part 15 Section	Description	Results	Comments
15.247(a)(2)	The minimum 6dB bandwidth shall be at least 500 kHz.	PASSED	2412 MHz = 13.42 MHz 2437 MHz = 10.67 MHz 2462 MHz = 14.17 MHz
15.247(b)(3)	The maximum conducted output power is the highest total transmit power occurring in any mode	PASSED	2412 MHz = 15.54 dBm = 35.84 mW 2437 MHz = 16.74 dBm = 47.25 mW 2462 MHz = 15.64 dBm = 36.67 mW
15.247(b)(5)	The intentional radiator shall be operated in a manner that ensures that the public is not exposed to radio frequency energy levels in excess of the FCC guidelines per Section 1.1307(b)(1).	PASSED	Refer to MPE Calculations
15.247(d)	In any 100 kHz bandwidth outside the frequency band in which the spread spectrum intentional radiator is operating, the radio frequency power that is produced by the intentional radiator shall be at least 20 dB below that in the 100 kHz bandwidth within the band that contains the highest level of the desired power.	PASSED	See Data Sheets (Appendix A)
15.247(d)	Radiated emissions, which fall in the restricted bands, as defined in Sec. 15.205(a), must also comply with the radiated emission limits specified in Sec. 15.209(a). All others must be < -20dBc.	PASSED	See Data Sheets (Appendix A)
15.247(e)	The peak power spectral density conducted from the intentional radiator to the antenna shall not be greater than 8 dBm in any 3 kHz band during any time interval of continuous transmission.	PASSED	2412 MHz = -10.26 dB 2437 MHz = -9.35 dB 2462 MHz = -9.54 dB
15.207	AC Conducted Emissions	PASSED	See Data Sheets (Appendix A)
15.209	Radiated Emissions (30-1000 MHz)	PASSED	



2.0 Summary of Test Results (Continued)

802.11g Mode (2400-2483.5 MHz) Chain B

EMISSIONS STANDARD			
FCC Part 15 Section	Description	Results	Comments
15.247(a)(2)	The minimum 6dB bandwidth shall be at least 500 kHz.	PASSED	2412 MHz = 13.50 MHz 2437 MHz = 14.42 MHz 2462 MHz = 10.33 MHz
15.247(b)(3)	The maximum conducted output power is the highest total transmit power occurring in any mode	PASSED	2412 MHz = 15.84 dBm = 38.40 mW 2437 MHz = 16.64 dBm = 46.17 mW 2462 MHz = 15.84 dBm = 38.40 mW
15.247(b)(5)	The intentional radiator shall be operated in a manner that ensures that the public is not exposed to radio frequency energy levels in excess of the FCC guidelines per Section 1.1307(b)(1).	PASSED	Refer to MPE Calculations
15.247(d)	In any 100 kHz bandwidth outside the frequency band in which the spread spectrum intentional radiator is operating, the radio frequency power that is produced by the intentional radiator shall be at least 20 dB below that in the 100 kHz bandwidth within the band that contains the highest level of the desired power.	PASSED	See Data Sheets (Appendix A)
15.247(d)	Radiated emissions, which fall in the restricted bands, as defined in Sec. 15.205(a), must also comply with the radiated emission limits specified in Sec. 15.209(a). All others must be < -20dBc.	PASSED	See Data Sheets (Appendix A)
15.247(e)	The peak power spectral density conducted from the intentional radiator to the antenna shall not be greater than 8 dBm in any 3 kHz band during any time interval of continuous transmission.	PASSED	2412 MHz = -11.04 dB 2437 MHz = -11.10 dB 2462 MHz = -10.37 dB
15.207	AC Conducted Emissions	PASSED	See Data Sheets (Appendix A)
15.209	Radiated Emissions (30-1000 MHz)	PASSED	



2.0 Summary of Test Results (Continued)

802.11n Mode 20MHz Wide (2400-2483.5 MHz) Chain A

EMISSIONS STANDARD			
FCC Part 15 Section	Description	Results	Comments
15.247(a)(2)	The minimum 6dB bandwidth shall be at least 500 kHz.	PASSED	2412 MHz = 12.92 MHz 2437 MHz = 10.25 MHz 2462 MHz = 13.67 MHz
15.247(b)(3)	The maximum conducted output power is the highest total transmit power occurring in any mode	PASSED	2412 MHz = 14.94 dBm = 31.22 mW 2437 MHz = 16.74 dBm = 47.25 mW 2462 MHz = 14.64 dBm = 29.13 mW
15.247(b)(5)	The intentional radiator shall be operated in a manner that ensures that the public is not exposed to radio frequency energy levels in excess of the FCC guidelines per Section 1.1307(b)(1).	PASSED	Refer to MPE Calculations
15.247(d)	In any 100 kHz bandwidth outside the frequency band in which the spread spectrum intentional radiator is operating, the radio frequency power that is produced by the intentional radiator shall be at least 20 dB below that in the 100 kHz bandwidth within the band that contains the highest level of the desired power.	PASSED	See Data Sheets (Appendix A)
15.247(d)	Radiated emissions, which fall in the restricted bands, as defined in Sec. 15.205(a), must also comply with the radiated emission limits specified in Sec. 15.209(a). All others must be < -20dBc.	PASSED	See Data Sheets (Appendix A)
15.247(e)	The peak power spectral density conducted from the intentional radiator to the antenna shall not be greater than 8 dBm in any 3 kHz band during any time interval of continuous transmission.	PASSED	2412 MHz = -11.48 dB 2437 MHz = -9.65 dB 2462 MHz = -12.01 dB
15.207	AC Conducted Emissions	PASSED	See Data Sheets (Appendix A)
15.209	Radiated Emissions (30-1000 MHz)	PASSED	



2.0 Summary of Test Results (Continued)

802.11n Mode 20MHz Wide (2400-2483.5 MHz) Chain B

EMISSIONS STANDARD			
FCC Part 15 Section	Description	Results	Comments
15.247(a)(2)	The minimum 6dB bandwidth shall be at least 500 kHz.	PASSED	2412 MHz = 10.75 MHz 2437 MHz = 11.92 MHz 2462 MHz = 10.50 MHz
15.247(b)(3)	The maximum conducted output power is the highest total transmit power occurring in any mode	PASSED	2412 MHz = 14.74 dBm = 29.81 mW 2437 MHz = 16.64 dBm = 46.17 mW 2462 MHz = 14.54 dBm = 28.47 mW
15.247(b)(5)	The intentional radiator shall be operated in a manner that ensures that the public is not exposed to radio frequency energy levels in excess of the FCC guidelines per Section 1.1307(b)(1).	PASSED	Refer to MPE Calculations
15.247(d)	In any 100 kHz bandwidth outside the frequency band in which the spread spectrum intentional radiator is operating, the radio frequency power that is produced by the intentional radiator shall be at least 20 dB below that in the 100 kHz bandwidth within the band that contains the highest level of the desired power.	PASSED	See Data Sheets (Appendix A)
15.247(d)	Radiated emissions, which fall in the restricted bands, as defined in Sec. 15.205(a), must also comply with the radiated emission limits specified in Sec. 15.209(a). All others must be < -20dBc.	PASSED	See Data Sheets (Appendix A)
15.247(e)	The peak power spectral density conducted from the intentional radiator to the antenna shall not be greater than 8 dBm in any 3 kHz band during any time interval of continuous transmission.	PASSED	2412 MHz = -11.63 dB 2437 MHz = -10.50 dB 2462 MHz = -12.55 dB
15.207	AC Conducted Emissions	PASSED	See Data Sheets (Appendix A)
15.209	Radiated Emissions (30-1000 MHz)	PASSED	



2.0 Summary of Test Results (Continued)

802.11n Mode 40MHz Wide (2400-2483.5 MHz) Chain A

EMISSIONS STANDARD			
FCC Part 15 Section	Description	Results	Comments
15.247(a)(2)	The minimum 6dB bandwidth shall be at least 500 kHz.	PASSED	2422 MHz = 32.50 MHz 2437 MHz = 26.83 MHz 2452 MHz = 27.00 MHz
15.247(b)(3)	The maximum conducted output power is the highest total transmit power occurring in any mode	PASSED	2422 MHz = 12.44 dBm = 17.55 mW 2437 MHz = 16.54 dBm = 45.12 mW 2452 MHz = 12.54 dBm = 17.96 mW
15.247(b)(5)	The intentional radiator shall be operated in a manner that ensures that the public is not exposed to radio frequency energy levels in excess of the FCC guidelines per Section 1.1307(b)(1).	PASSED	Refer to MPE Calculations
15.247(d)	In any 100 kHz bandwidth outside the frequency band in which the spread spectrum intentional radiator is operating, the radio frequency power that is produced by the intentional radiator shall be at least 20 dB below that in the 100 kHz bandwidth within the band that contains the highest level of the desired power.	PASSED	See Data Sheets (Appendix A)
15.247(d)	Radiated emissions, which fall in the restricted bands, as defined in Sec. 15.205(a), must also comply with the radiated emission limits specified in Sec. 15.209(a). All others must be < -20dBc.	PASSED	See Data Sheets (Appendix A)
15.247(e)	The peak power spectral density conducted from the intentional radiator to the antenna shall not be greater than 8 dBm in any 3 kHz band during any time interval of continuous transmission.	PASSED	2422 MHz = -18.34 dB 2437 MHz = -14.67 dB 2452 MHz = -18.49 dB
15.207	AC Conducted Emissions	PASSED	See Data Sheets (Appendix A)
15.209	Radiated Emissions (30-1000 MHz)	PASSED	



2.0 Summary of Test Results (Continued)

802.11n Mode 40MHz Wide (2400-2483.5 MHz) Chain B

EMISSIONS STANDARD			
FCC Part 15 Section	Description	Results	Comments
15.247(a)(2)	The minimum 6dB bandwidth shall be at least 500 kHz.	PASSED	2422 MHz = 27.00 MHz 2437 MHz = 26.33 MHz 2452 MHz = 26.33 MHz
15.247(b)(3)	The maximum conducted output power is the highest total transmit power occurring in any mode	PASSED	2422 MHz = 12.44 dBm = 17.55 mW 2437 MHz = 16.44 dBm = 44.09 mW 2452 MHz = 12.44 dBm = 17.55 mW
15.247(b)(5)	The intentional radiator shall be operated in a manner that ensures that the public is not exposed to radio frequency energy levels in excess of the FCC guidelines per Section 1.1307(b)(1).	PASSED	Refer to MPE Calculations
15.247(d)	In any 100 kHz bandwidth outside the frequency band in which the spread spectrum intentional radiator is operating, the radio frequency power that is produced by the intentional radiator shall be at least 20 dB below that in the 100 kHz bandwidth within the band that contains the highest level of the desired power.	PASSED	See Data Sheets (Appendix A)
15.247(d)	Radiated emissions, which fall in the restricted bands, as defined in Sec. 15.205(a), must also comply with the radiated emission limits specified in Sec. 15.209(a). All others must be < -20dBc.	PASSED	See Data Sheets (Appendix A)
15.247(e)	The peak power spectral density conducted from the intentional radiator to the antenna shall not be greater than 8 dBm in any 3 kHz band during any time interval of continuous transmission.	PASSED	2422 MHz = -19.06 dB 2437 MHz = -16.37 dB 2452 MHz = -17.67 dB
15.207	AC Conducted Emissions	PASSED	See Data Sheets (Appendix A)
15.209	Radiated Emissions (30-1000 MHz)	PASSED	



2.0 Summary of Test Results (Continued)

802.11n Mode 20MHz Wide (5745-5825 MHz) Chain A

EMISSIONS STANDARD			
FCC Part 15 Section	Description	Results	Comments
15.247(a)(2)	The minimum 6dB bandwidth shall be at least 500 kHz.	PASSED	5745 MHz = 16.75 MHz 5785 MHz = 17.75 MHz 5825 MHz = 17.50 MHz
15.247(b)(3)	The maximum conducted output power is the highest total transmit power occurring in any mode	PASSED	5745 MHz = 16.64 dBm = 46.17 mW 5785 MHz = 16.54 dBm = 45.12 mW 5825 MHz = 16.64 dBm = 46.17 mW
15.247(b)(5)	The intentional radiator shall be operated in a manner that ensures that the public is not exposed to radio frequency energy levels in excess of the FCC guidelines per Section 1.1307(b)(1).	PASSED	Refer to MPE Calculations
15.247(d)	In any 100 kHz bandwidth outside the frequency band in which the spread spectrum intentional radiator is operating, the radio frequency power that is produced by the intentional radiator shall be at least 20 dB below that in the 100 kHz bandwidth within the band that contains the highest level of the desired power.	PASSED	See Data Sheets (Appendix A)
15.247(d)	Radiated emissions, which fall in the restricted bands, as defined in Sec. 15.205(a), must also comply with the radiated emission limits specified in Sec. 15.209(a). All others must be < -20dBc.	PASSED	See Data Sheets (Appendix A)
15.247(e)	The peak power spectral density conducted from the intentional radiator to the antenna shall not be greater than 8 dBm in any 3 kHz band during any time interval of continuous transmission.	PASSED	5745 MHz = -10.83 dB 5785 MHz = -11.34 dB 5825 MHz = -11.56 dB
15.207	AC Conducted Emissions	PASSED	See Data Sheets (Appendix A)
15.209	Radiated Emissions (30-1000 MHz)	PASSED	



2.0 Summary of Test Results (Continued)

802.11n Mode 20MHz Wide (5745-5825 MHz) Chain B

EMISSIONS STANDARD			
FCC Part 15 Section	Description	Results	Comments
15.247(a)(2)	The minimum 6dB bandwidth shall be at least 500 kHz.	PASSED	5745 MHz = 17.58 MHz 5785 MHz = 16.91 MHz 5825 MHz = 17.25 MHz
15.247(b)(3)	The maximum conducted output power is the highest total transmit power occurring in any mode	PASSED	5745 MHz = 16.84 dBm = 48.35 mW 5785 MHz = 16.64 dBm = 46.17 mW 5825 MHz = 16.74 dBm = 47.25 mW
15.247(b)(5)	The intentional radiator shall be operated in a manner that ensures that the public is not exposed to radio frequency energy levels in excess of the FCC guidelines per Section 1.1307(b)(1).	PASSED	Refer to MPE Calculations
15.247(d)	In any 100 kHz bandwidth outside the frequency band in which the spread spectrum intentional radiator is operating, the radio frequency power that is produced by the intentional radiator shall be at least 20 dB below that in the 100 kHz bandwidth within the band that contains the highest level of the desired power.	PASSED	See Data Sheets (Appendix A)
15.247(d)	Radiated emissions, which fall in the restricted bands, as defined in Sec. 15.205(a), must also comply with the radiated emission limits specified in Sec. 15.209(a). All others must be < -20dBc.	PASSED	See Data Sheets (Appendix A)
15.247(e)	The peak power spectral density conducted from the intentional radiator to the antenna shall not be greater than 8 dBm in any 3 kHz band during any time interval of continuous transmission.	PASSED	5745 MHz = -11.07 dB 5785 MHz = -11.04 dB 5825 MHz = -11.06 dB
15.207	AC Conducted Emissions	PASSED	See Data Sheets (Appendix A)
15.209	Radiated Emissions (30-1000 MHz)	PASSED	



2.0 Summary of Test Results (Continued)

802.11n Mode 40MHz Wide (5745-5825 MHz) Chain A

EMISSIONS STANDARD			
FCC Part 15 Section	Description	Results	Comments
15.247(a)(2)	The minimum 6dB bandwidth shall be at least 500 kHz.	PASSED	5755 MHz = 28.17 MHz 5795 MHz = 26.33 MHz
15.247(b)(3)	The maximum conducted output power is the highest total transmit power occurring in any mode	PASSED	5755 MHz = 16.89 dBm = 48.84 mW 5795 MHz = 16.79 dBm = 47.73 mW
15.247(b)(5)	The intentional radiator shall be operated in a manner that ensures that the public is not exposed to radio frequency energy levels in excess of the FCC guidelines per Section 1.1307(b)(1).	PASSED	Refer to MPE Calculations
15.247(d)	In any 100 kHz bandwidth outside the frequency band in which the spread spectrum intentional radiator is operating, the radio frequency power that is produced by the intentional radiator shall be at least 20 dB below that in the 100 kHz bandwidth within the band that contains the highest level of the desired power.	PASSED	See Data Sheets (Appendix A)
15.247(d)	Radiated emissions, which fall in the restricted bands, as defined in Sec. 15.205(a), must also comply with the radiated emission limits specified in Sec. 15.209(a). All others must be < -20dBc.	PASSED	See Data Sheets (Appendix A)
15.247(e)	The peak power spectral density conducted from the intentional radiator to the antenna shall not be greater than 8 dBm in any 3 kHz band during any time interval of continuous transmission.	PASSED	5755 MHz = -14.86 dB 5795 MHz = -14.75 dB
15.207	AC Conducted Emissions	PASSED	See Data Sheets (Appendix A)
15.209	Radiated Emissions (30-1000 MHz)	PASSED	



2.0 Summary of Test Results (Continued)

802.11n Mode 40MHz Wide (5745-5825 MHz) Chain B

EMISSIONS STANDARD

FCC Part 15 Section	Description	Results	Comments
15.247(a)(2)	The minimum 6dB bandwidth shall be at least 500 kHz.	PASSED	5755 MHz = 25.83 MHz 5795 MHz = 26.83 MHz
15.247(b)(3)	The maximum conducted output power is the highest total transmit power occurring in any mode	PASSED	5755 MHz = 16.79 dBm = 47.73 mW 5795 MHz = 16.79 dBm = 47.73 mW
15.247(b)(5)	The intentional radiator shall be operated in a manner that ensures that the public is not exposed to radio frequency energy levels in excess of the FCC guidelines per Section 1.1307(b)(1).	PASSED	Refer to MPE Calculations
15.247(d)	In any 100 kHz bandwidth outside the frequency band in which the spread spectrum intentional radiator is operating, the radio frequency power that is produced by the intentional radiator shall be at least 20 dB below that in the 100 kHz bandwidth within the band that contains the highest level of the desired power.	PASSED	See Data Sheets (Appendix A)
15.247(d)	Radiated emissions, which fall in the restricted bands, as defined in Sec. 15.205(a), must also comply with the radiated emission limits specified in Sec. 15.209(a). All others must be < -20dBc.	PASSED	See Data Sheets (Appendix A)
15.247(e)	The peak power spectral density conducted from the intentional radiator to the antenna shall not be greater than 8 dBm in any 3 kHz band during any time interval of continuous transmission.	PASSED	5755 MHz = -14.76 dB 5795 MHz = -14.04 dB
15.207	AC Conducted Emissions	PASSED	See Data Sheets
15.209	Radiated Emissions (30-1000 MHz)	PASSED	(Appendix A)

ANALYSIS AND CONCLUSIONS

Based upon the measurement results we find that this equipment is within the limits of the global standards listed on the cover page of this test report. All results are based on a test of one sample. If any significant changes are made to the unit, the changes shall be evaluated and a retest may be required.

Approval Signatories

Report Completed By:

Johnny Candelas 9/10/2009
Senior Test Engineer
Aegis Labs, Inc.

Report Approved By:

Rick Candelas 9/10/2009
Quality Assurance
Aegis Labs, Inc.



3.0 ADMINISTRATIVE DATA AND TEST DESCRIPTION

DEVICE TESTED:	ITE Type: Intel® Centrino® Ultimate-N 6200 Model Number(s): 622ANHMW Serial Number: 0015005A3C7C FCC ID: PD9622ANH
DATE EUT RECEIVED:	June 18 th , 2009
TEST DATE(S):	July 21 st – Sept 4 th , 2009
ORIGIN OF TEST SAMPLE(S):	Production
EQUIPMENT CLASS:	EUT tested as CLASS B device
RESPONSIBLE PARTY:	Intel Corporation 2111 NE 25 th Avenue Hillsboro, Oregon 97124
CLIENT CONTACT:	Mr. Steve Hackett
MANUFACTURER:	Intel Corporation
TEST LOCATION:	Aegis Labs, Inc. 32231 Trabuco Creek Road Trabuco Canyon, CA 92678 Open Area Test Site #1 & #2
ACCREDITATION CERTIFICATE(S):	A2LA Certificate Number: 1111.01, Valid through February 10, 2010
PURPOSE OF TEST:	To demonstrate compliance with the standards as described in Sections 1.0 & 2.0 of this report.
UNCERTAINTY BUDGET:	Proficiency Testing and Uncertainty Calculations for all tests indicated in this report have been conducted in accordance with ISO 17025: 2005 requirements Section 5.4.6, and 5.9. Uncertainty Budgets and Proficiency Test results available upon request.
STATEMENT OF CALIBRATION:	All accredited equipment calibrations were performed by Liberty Labs, Inc. and World Cal. with typical calibration uncertainty estimates derived from ISO Guide to the determination of uncertainties with a Coverage Factor of k=2 for 95% level of confidence.

4.0 DESCRIPTION OF EUT CONFIGURATION

4.1 EUT Description

Equipment Under Test (EUT)	
Trade Name:	Intel® Centrino® Ultimate-N 6200
Model Number:	622ANHMW
Frequency Range:	802.11a = 5745 – 5825 MHz 802.11b/g = 2412 – 2462MHz 802.11n = 2412 – 2462MHz & 5745 – 5825 MHz
Type of Transmission:	Direct Sequence Spread Spectrum
Transfer Rate:	1/5.5/11 Mbps for 802.11b mode 6/36/54 Mbps for 802.11g and 802.11a modes Up to 450 Mbps for 802.11n mode
Number of Channels:	802.11a mode (5725-5850 MHz) = 5 802.11b mode (2400-2483.5 MHz) = 11 802.11g mode (2400-2483.5 MHz) = 11 802.11n mode (5725-5850 MHz) = 5 802.11n mode (2400-2483.5 MHz) = 11
Modulation Type:	DBPSK, DQPSK, CCK, OFDM
Antenna Type:	<u>Shanghai Universe Communication Electron Co., Ltd Antennas:</u> PIFA
Antenna Gain (See Note 2):	4.97dBi @ 5 GHz / 3.24dBi @ 2.4 GHz
Transmit Output Power:	Please see Appendix A (Data Sheets) for actual output power.
Power Supply:	3.3VDC from external source
Number of External Test Ports Exercised:	2 Antenna Ports (Chain A & B)

The Intel® Centrino® Ultimate-N 6200 is an embedded IEEE 802.11a/b/g/n wireless network adapter that operates in the 2.4 GHz and 5.0 GHz spectrum. The adapter is capable of delivering up to 450 Mbps Tx/Rx.

NOTE 1: For a more detailed description, please refer to the manufacture’s specifications or User’s Manual.

NOTE 2: The EUT was tested with a set of Shanghai Universe Communication Electron Co., Ltd Antennas. (Refer to the antenna information exhibits).

4.2 EUT Configuration

The EUT was tested installed in the Mini PCI-E slot of an extender board which is then connected to the host computer. The EUT was then connected to a set of antennas via its Chain A & B antenna ports. Data for a set of Shanghai Universe Communication Electron Co., Ltd Antennas can be found in Appendix A (Data Sheets)

The low, middle, and high channels were tested in 802.11a, b, g, & n modes. Also, the EUT was tested once transmitting from each chain individually (Chain A & B) and then tested with all chains transmitting simultaneously (Chain AB). The EUT was placed in continuous transmit mode by a program provided by the manufacturer (*CRTU Version 5.15.36.0*).

4.3 List of EUT, Sub-Assemblies and Host Equipment

Equipment Under Test			
Manufacturer	Equipment Name	Model or Part Number	Serial Number
Intel Corporation	Intel® Centrino® Ultimate-N 6200	622ANHMW	0015005A3C7C

EUT Sub Assemblies			
Manufacturer	Equipment Name	Model or Part Number	Serial Number
Shanghai Universe Communication Electron Co.,Ltd	Chain A Antenna	SUC ANT S11	N/A
	Chain B Antenna	SUC ANT S11	N/A

HOST EQUIPMENT LIST			
Manufacturer	Equipment Name	Model or Part Number	Serial Number
Generic	Host Laptop	ENG001	None
Protek	DC Power Source	3006B	AC2018
Logitech	Keyboard	Y-BF37	MCT25200581
Logitech	Mouse	M-BJ58	LNA22802012

NOTE: All the power cords of the above support equipment are standard and non-shielded.

4.4 I/O Cabling Diagram and Description

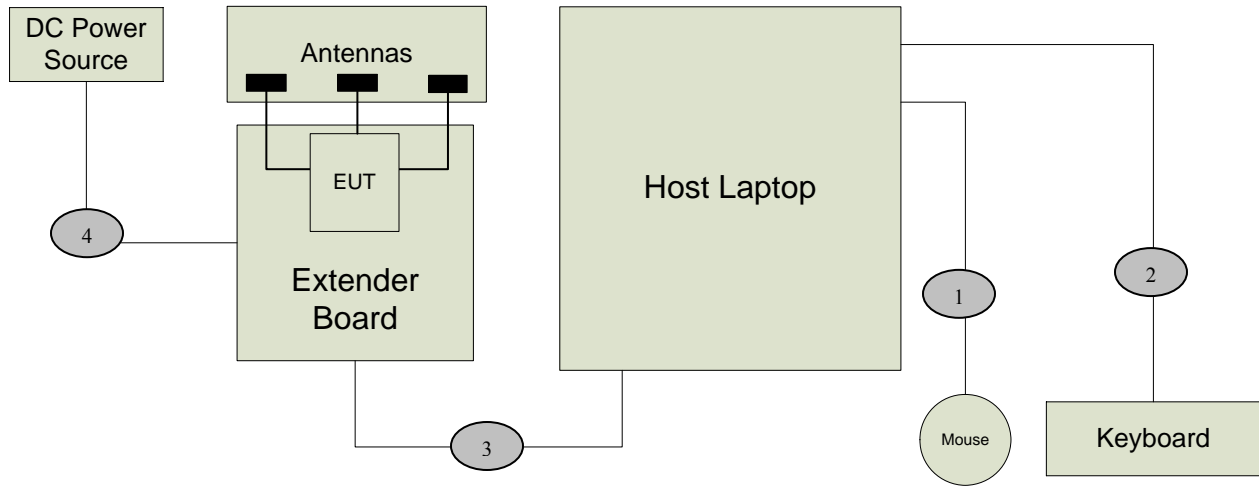

Signal Line Cable Description

Cable	Length	Construction	Source Connector	Destination Connector	Bundled Length	Ferrite Attached	Note
1	1.5m	Round, Braid & Foil Shielded	Host Computer: USB Port	Keyboard: Hardwired	N/A	N/A	N/A
2	1.5m	Round, Braid & Foil Shielded	Host Computer: USB Port	Mouse: Hardwired	N/A	N/A	N/A
3	0.5m	Flat, Braid & Foil Shielded	Extender Board: Mini PCIe slot	Host Laptop: Mini PCIe slot	N/A	N/A	N/A
4	0.5m	Round Un-shielded	Extender Board: Power Input	DC Power Source: Power Output	N/A	N/A	N/A



4.5 EMC Test Hardware and Software Measurement Equipment

TEST EQUIPMENT LIST - Emissions					
Equipment Name	Manufacturer	Model Number	Serial Number	Calibration Due Date	Maintenance Calibration Cycle
Spectrum Analyzer	Agilent	8565EC	3946A00245	07/24/10	1 Year
PSA Spectrum Analyzer	Agilent	E4440A	MY46186811	07/02/11	2 Years
Antenna – Horn	ETS	3117	00057423	12/23/09	1 Year
Preamp	Miteq	JS42-01001800-25-10P	815980	12/23/09	1 Year
30 Foot Coax	Semflex	S130SFBS10360	0619	07/26/10	1 Year
2.4 GHz Notch Filter	Micro-Tronics	BRM50702-02	003	NCR	NCR
5.725-5.850 GHz Notch Filter	Microwave Circuits	N0257881	3173-01	NCR	NCR
Antenna - 18-26.5 GHz Pre-amplified Horn	Aegis Labs, Inc.	H042	SLK-35-3W	02/08/10	1 Year
Antenna - 26.5-40 GHz Pre-amplified Horn	Aegis Labs, Inc.	H028	GM1260-10	02/08/10	1 Year
EMI Receiver - RF Section	Hewlett Packard	8546A	3325A00137	04/26/10	1 Year
EMI Receiver - RF Filter Section	Hewlett Packard	85460A	3330A00138	04/26/10	1 Year
10 dB Attenuator	Pasternack	PE7014-10	N/A	09/05/09	1 Year
LISN (EUT)	Fisher Custom Communications	FCC-LISN-50-25-2	9931	06/03/10	1 Year
LISN (Access)	EMCO	3825/2	9108-1848	06/03/10	1 Year
Antenna - Biconical	EMCO	3110	9108-1421	06/05/10	1 Year
Antenna - Log Periodic	EMCO	3148	4947	06/12/10	1 Year
Power Meter	Anritsu	ML2487A	6K00001785	05/29/10	1 Year
Wide Bandwidth Sensor	Anritsu	MA2491A	31193	05/29/10	1 Year
12dB Attenuator	Narda	4779-12	203	06/09/10	1 Year
Temperature/Humidity Monitor	Dickson	TH550	7255185	04/13/10	1 Year

NCR – No Calibration Required.

5.0 CONDITIONS DURING EMISSIONS MEASUREMENTS

5.1 General

All measurements were made according to the procedures defined in or referred to by the standard listed on the cover page of this report. The measurements were made in the operating mode producing the largest emissions consistent with normal operation and connected to the minimum configuration of auxiliary devices.

5.2 Conducted Emissions Test Setup

The following was the test configuration.

EUT signal cables that hung closer than 40 cm to the horizontal metal ground plane were folded back and forth forming a bundle 30 cm to 40 cm long. The power cord of the EUT was also bundled in the center and plugged into one of the artificial mains network (AMN). All peripheral equipment was powered from a second AMN via a multiple outlet strip placed at a distance of 10cm from each other. The AMN and ISN were positioned 80cm from the EUT. Signal cables that were not connected to an AE were terminated using the correct termination. If applicable, the current probe was placed at 0.1 m from the ISN.

Peak, quasi-peak and/or average detectors were used for testing performed between 150 kHz and 30 MHz. A swept frequency scan was performed for both Line 1 and Line 2. The six highest readings were compared against the limit and recorded in the data sheet along with a snapshot image of the sweep scan. The graphical scans in Appendix A only reflect peak readings while the tabulated data sheets reflect peak, average, and/or quasi-peak measurements.

Climatic Conditions:

The EUT was tested within its intended operating and climatic conditions.

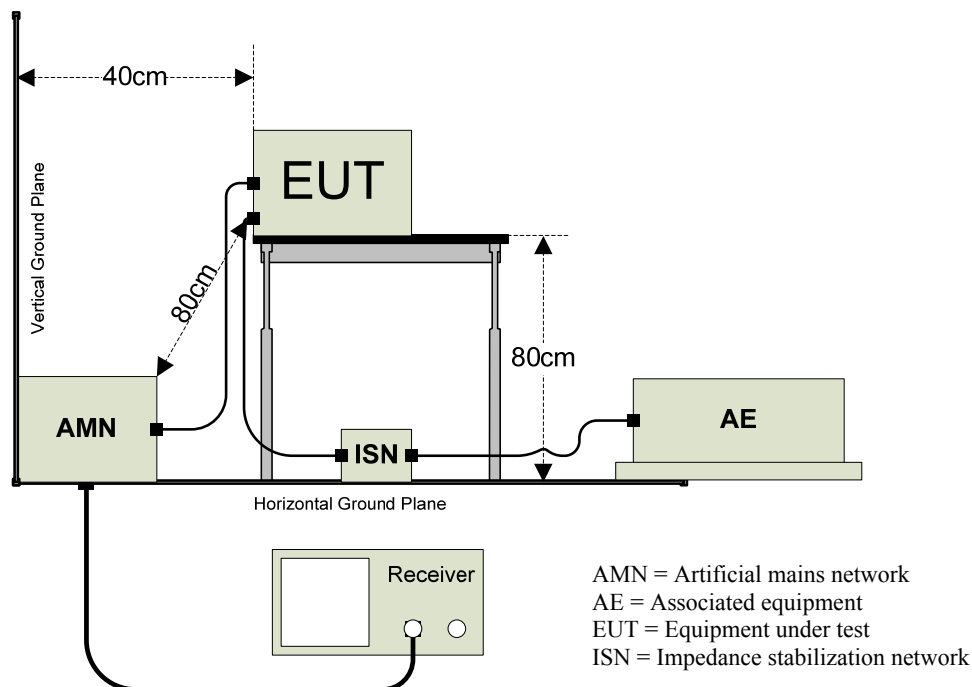

5.3 Radiated Emissions Test Setup

The Open Area Test Site (OATS) was used for radiated emission testing. The receiving (Rx) antenna(s) was placed 10m from the nearest side of the EUT facing the Rx antenna. The EUT (if floor-standing) was placed directly on the flush-mounted 360 degree rotating turntable. The EUT (if table-top) was placed directly on an 80cm high non-metallic table, and the table was placed on the rotating turntable. During the initial EMI scan, all the suspect frequencies, i.e.; harmonics, broadband signals were checked with the Rx broadband antennas in both vertical and horizontal polarities. The biconical Rx, log periodic Rx, and horn Rx antennas were used from 30MHz – 299.99MHz, 300MHz – 1000MHz, and 1GHz – 18GHz respectively.

Upon completion of all harmonic and broadband measurements, the balance of any remaining frequencies was checked between 30MHz – 18GHz. Any signals appearing within 20 dB of the classification limit was measured. Each signal was maximized by first rotating the turntable at least 360 degrees and recording the azimuth in the data sheet. Lastly, the Rx antenna was raised and/or lowered to maximize the signal elevation. If the measured signal was obtained using the peak detector and that signal appeared within 3 dB of the regulatory limit line, then the same signal was re-measured using the quasi-peak detector on the EMI receiver. Both meter readings if necessary were recorded on the data sheet.

Climatic Conditions:

The EUT was tested within its intended operating and climatic conditions.

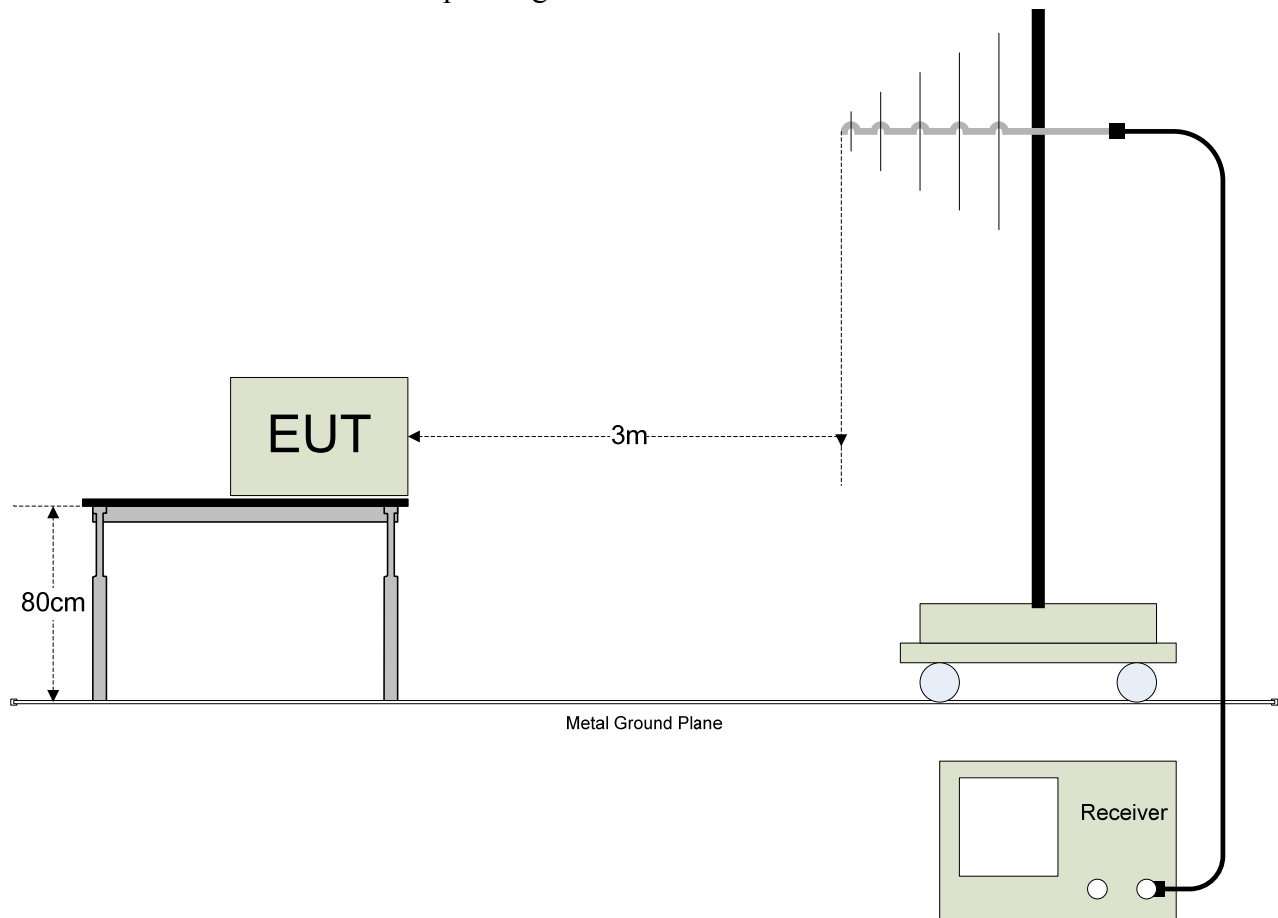



APPENDIX A

TEST DATA

**AC POWER PORT - CONDUCTED EMISSIONS TEST RESULTS**

CLIENT:	Intel Corporation	DATE:	07/24/09
EUT:	Intel® Centrino® Ultimate-N 6200	PROJECT NUMBER:	INTEL-090601
MODEL NUMBER:	622ANHMW	TEST ENGINEER:	JC
SERIAL NUMBER:	0015005A3C7C	SITE #:	1
CONFIGURATION:	Tested installed in an extender board connected to the host laptop's mini PCI slot	TEMPERATURE:	22 deg. C
		HUMIDITY:	49%
		TIME:	2:00 PM

Description:	Conducted Power RF Emissions (150 kHz – 30 MHz)
Results:	PASSED LINE 1 and LINE 2 Limits
Note:	Conducted Emissions Measurements were performed on the EUT with the power supply set at the following voltage and frequency. <ul style="list-style-type: none">• 120VAC / 60 Hz

Conducted Limits		
Frequency (MHz)	Quasi-Peak Limit (dBuV)	Average Limit (dBuV)
0.15-0.5	66 to 56*	56 to 46*
0.5-5	56	46
5-30	60	50

*Decreases with the logarithm of the frequency.



AC Power Port – Conducted Emissions Test Results (Continued)

Continuously Transmitting @ 120VAC/60Hz (INTEL-090601-10)

FCC CLASS B CONDUCTED EMISSIONS – LINE 1

Freq. (MHz)	Meter Reading (dBuV)	Detector (PK/QP/AV)	Average Limit (dBuV)	Average Delta(dB)	Quasi-Peak Limit (dBuV)	Quasi-Peak Delta(dB)
0.4500	47.42	PK	47.43	-0.01	57.43	-10.01
0.4500	28.39	AV	47.43	-19.04	57.43	-29.04
0.5900	45.85	PK	46.00	-0.15	56.00	-10.15
0.5900	25.01	AV	46.00	-20.99	56.00	-30.99
1.0700	45.11	PK	46.00	-0.89	56.00	-10.89
1.0700	23.59	AV	46.00	-22.41	56.00	-32.41
7.5800	45.18	PK	50.00	-4.82	60.00	-14.82
11.5900	46.92	PK	50.00	-3.08	60.00	-13.08
15.6800	52.02	PK	50.00	2.02	60.00	-7.98
15.6800	34.53	AV	50.00	-15.47	60.00	-25.47

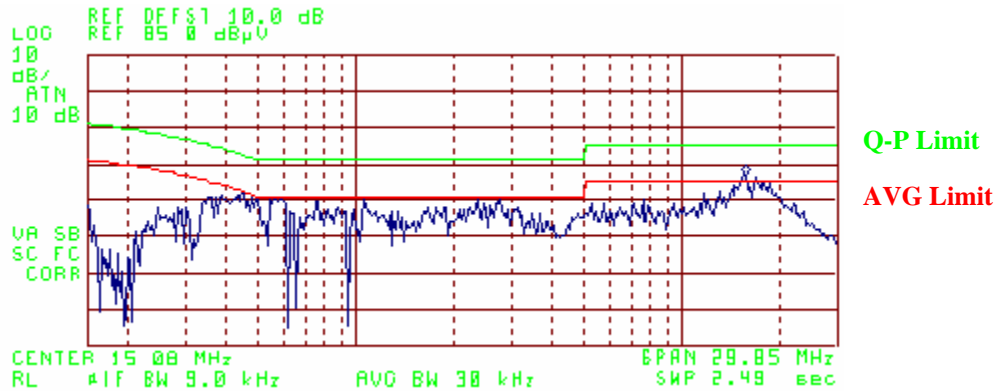

AC Power Port – Conducted Emissions Test Results (Continued)

Continuously Transmitting @ 120VAC/60Hz (INTEL-090601-10)

FCC CLASS B CONDUCTED EMISSIONS - LINE 2

Freq. (MHz)	Meter Reading (dBuV)	Detector (PK/QP/AV)	Average Limit (dBuV)	Average Delta(dB)	Quasi-Peak Limit (dBuV)	Quasi-Peak Delta(dB)
0.4300	46.69	PK	48.00	-1.31	58.00	-11.31
0.4300	25.39	AV	48.00	-22.61	58.00	-32.61
0.4700	46.90	PK	46.85	0.05	56.85	-9.95
0.4700	26.54	AV	46.85	-20.31	56.85	-30.31
0.5000	48.09	PK	46.00	2.09	56.00	-7.91
0.5000	24.08	AV	46.00	-21.92	56.00	-31.92
2.6300	48.19	PK	46.00	2.19	56.00	-7.81
2.6300	31.72	AV	46.00	-14.28	56.00	-24.28
8.6900	48.09	PK	50.00	-1.91	60.00	-11.91
8.6900	26.84	AV	50.00	-23.16	60.00	-33.16
16.1400	50.88	PK	50.00	0.88	60.00	-9.12
16.1400	33.76	AV	50.00	-16.24	60.00	-26.24

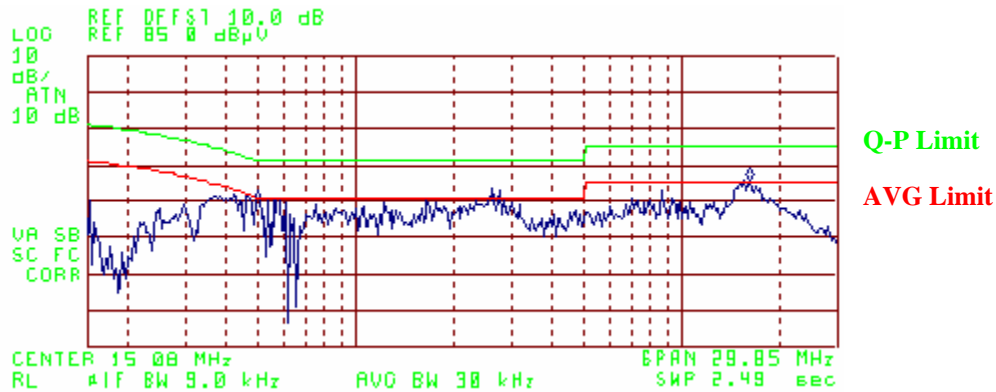

**RADIATED EMISSIONS TEST RESULTS**

CLIENT:	Intel Corporation	DATE:	07/24/09
EUT:	Intel® Centrino® Ultimate-N 6200	PROJECT NUMBER:	INTEL-090601
MODEL NUMBER:	622ANHMW	TEST ENGINEER:	JC
SERIAL NUMBER:	0015005A3C7C	SITE #:	1
CONFIGURATION:	Tested installed in an extender board connected to the host laptop's mini PCI slot	TEMPERATURE:	19 deg. C
		HUMIDITY:	57%
		TIME:	9:00 AM

Description:	Radiated RF Emissions (30 MHz – 1000 MHz)
Results:	PASSED Horizontal and Vertical Antenna Polarizations Class B Limits
Note:	Radiated Emissions Measurements were performed on the EUT with the power supply set at the following voltage and frequency. <ul style="list-style-type: none"> • 120VAC / 60 Hz.

Radiated Emissions Sample Calculations

$$\text{Corrected Meter Reading} = \text{Meter Reading} + F + C - D$$

Where, F = Antenna Factor

C = Cable Factor

G = Amplifier Gain

D = Distance Factor (if applicable)

Therefore, the equation for determining the Corrected Meter Reading Limit (CML) is:

$$\text{CML} = \text{Specification Limit} - F - C + D$$



Radiated Emissions Test Results (Continued)

Continuously Transmitting @ 120VAC/60Hz (INTEL-090601-11)

Horizontal Open Field Maximized Data											
<i>Freq. (MHz)</i>	<i>Meter Reading (dBuV)</i>	<i>Antenna Height (cm)</i>	<i>Azimuth (degrees)</i>	<i>Quasi pk or AVG (dBuV)</i>		<i>Cable Factor (dB)</i>	<i>Cable Factor (dB)</i>	<i>Antenna Factor (dB)</i>	<i>Corrected Reading (dBuV/m)</i>	<i>Limits (dBuV/m)</i>	<i>Diff (dB) +=FAIL</i>
48.02	8.58	400	45			2.65	10.32	10.46	32.01	40.00	-7.99
120.00	14.23	400	90	11.03	Q	2.39	11.20	10.46	35.08	43.50	-8.42
250.01	10.96	350	90			2.91	17.40	10.46	41.73	46.00	-4.27
305.09	11.32	300	270			3.07	14.49	10.46	39.33	46.00	-6.67
375.00	10.53	250	45			3.35	15.10	10.46	39.44	46.00	-6.57
386.00	11.63	225	45			3.39	15.54	10.46	41.02	46.00	-4.98

Vertical Open Field Maximized Data											
<i>Freq. (MHz)</i>	<i>Meter Reading (dBuV)</i>	<i>Antenna Height (cm)</i>	<i>Azimuth (degrees)</i>	<i>Quasi pk or AVG (dBuV)</i>		<i>Cable Factor (dB)</i>	<i>Cable Factor (dB)</i>	<i>Antenna Factor (dB)</i>	<i>Corrected Reading (dBuV/m)</i>	<i>Limits (dBuV/m)</i>	<i>Diff (dB) +=FAIL</i>
48.01	11.12	100	45			2.65	10.52	10.46	34.75	40.00	-5.25
119.98	18.40	100	90	14.65	Q	2.39	10.80	10.46	38.30	43.50	-5.20
250.03	8.51	100	45			2.91	18.30	10.46	40.18	46.00	-5.82
306.35	13.06	100	45			3.07	14.78	10.46	41.37	46.00	-4.63
358.01	7.94	100	0			3.27	15.44	10.46	37.11	46.00	-8.89
375.05	8.85	100	90			3.35	15.30	10.46	37.96	46.00	-8.04
386.01	15.71	100	180	13.62	Q	3.39	15.61	10.46	43.08	46.00	-2.92

**RADIATED EMISSIONS TEST RESULTS**

CLIENT:	Intel Corporation	DATE:	08/17/09
EUT:	Intel® Centrino® Ultimate-N 6200	PROJECT NUMBER:	INTEL-090601
MODEL NUMBER:	622ANHMW	TEST ENGINEER:	JC
SERIAL NUMBER:	0015005A3C7C	SITE #:	2
CONFIGURATION:	Tested installed in an extender board connected to the host laptop's mini PCI slot in 802.11a (5745-5825 MHz) mode.	TEMPERATURE:	24° C
		HUMIDITY:	46% RH
		TIME:	9:30 AM

Description:	Radiated RF Emissions (1 GHz – 18 GHz)
Results:	PASSED Horizontal and Vertical Antenna Polarizations Class B Limits
Note:	Radiated Emissions Measurements were performed on the EUT with power supply set at the following voltage and frequency. <ul style="list-style-type: none"> • 120VAC / 60 Hz.

Unwanted Spurious Emissions Limits			
Frequency (MHz)	Field Strength (uV/m)	Field Strength (dBuV/m) (Emissions in the restricted bands)	Field Strength (dBm/MHz) (Emissions outside the restricted bands)
Above 960	500	54.00 (Average) 74.00 (Peak)	< -20 dBc

Radiated Emissions Sample Calculations

$$\text{Corrected Meter Reading} = \text{Meter Reading} + F + C - D$$

Where, F = Antenna Factor

C = Cable Factor

G = Amplifier Gain

D = Distance Factor (if applicable)

Therefore, the equation for determining the Corrected Meter Reading Limit (CML) is:

$$\text{CML} = \text{Specification Limit} - F - C + D$$

Radiated Emissions Test Results (Continued)

*Fundamental Measurements in 802.11a mode (5745-5825 MHz)
Channels 149, 157, & 165
Continuous TX at Chain A Antenna port with Shanghai Universe Antennas
Aegis Labs, Inc. File #: INTEL-090601-02*

RADIATED EMISSIONS - Horizontal Antenna Polarization											
Freq. (MHz)	Meter Reading (dBuV)	Antenna Height (cm)	Azimuth (degrees)	Quasi pk or AVG (dBuV)		Cable Factor (dB)	Ant. Factor (dB)	Corrected Reading (dBuV/m)	Limits (dBuV/m)	Diff (dB) +=FAIL	Comments
5745.00	60.89	100	45			3.98	34.89	99.77			Ch. 149
5745.00				53.62	A	3.98	34.89	92.50			
5785.00	58.63	100	45			4.00	34.94	97.57			Ch. 157
5785.00				51.68	A	4.00	34.94	90.62			
5825.00	55.22	100	45			4.01	34.99	94.22			Ch. 165
5825.00				48.52	A	4.01	34.99	87.52			

RADIATED EMISSIONS - Vertical Antenna Polarization											
Freq. (MHz)	Meter Reading (dBuV)	Antenna Height (cm)	Azimuth (degrees)	Quasi pk or AVG (dBuV)		Cable Factor (dB)	Ant. Factor (dB)	Corrected Reading (dBuV/m)	Limits (dBuV/m)	Diff (dB) +=FAIL	Comments
5745.00	63.88	100	315			3.98	35.05	102.91			Ch. 149
5745.00				54.42	A	3.98	35.05	93.45			
5785.00	62.75	100	315			4.00	35.09	101.83			Ch. 157
5785.00				53.69	A	4.00	35.09	92.77			
5825.00	61.24	100	315			4.01	35.13	100.38			Ch. 165
5825.00				51.50	A	4.01	35.13	90.64			

NOTE: Fundamental signals measured to calculate the band edge field strengths using the “Marker Delta Method”.

Radiated Emissions Test Results (Continued)

*Band Edge Field Strength Measurements in 802.11a mode (5745-5825 MHz)
Channels 149 & 165
Continuous TX at Chain A Antenna port with Shanghai Universe Antennas
Aegis Labs, Inc. File #: INTEL-090601-02*

RADIATED EMISSIONS - Horizontal Antenna Polarization										
<i>Freq. (MHz)</i>	<i>Meter Reading (dBuV)</i>	<i>Antenna Height (cm)</i>	<i>Azimuth (degrees)</i>	<i>Quasi pk or AVG (dBuV)</i>	<i>Cable Factor (dB)</i>	<i>Ant. Factor (dB)</i>	<i>Corrected Reading (dBuV/m)</i>	<i>Limits (dBuV/m)</i>	<i>Diff (dB) +=FAIL</i>	<i>Comments</i>
5725.00	30.24	100	45		3.98	34.87	69.09	79.77	-10.68	Ch. 149
5850.00	26.50	100	45		4.02	35.02	65.54	74.22	-8.68	Ch. 165

RADIATED EMISSIONS - Vertical Antenna Polarization										
<i>Freq. (MHz)</i>	<i>Meter Reading (dBuV)</i>	<i>Antenna Height (cm)</i>	<i>Azimuth (degrees)</i>	<i>Quasi pk or AVG (dBuV)</i>	<i>Cable Factor (dB)</i>	<i>Ant. Factor (dB)</i>	<i>Corrected Reading (dBuV/m)</i>	<i>Limits (dBuV/m)</i>	<i>Diff (dB) +=FAIL</i>	<i>Comments</i>
5725.00	32.91	100	315		3.98	35.03	71.91	82.91	-11.00	Ch. 149
5850.00	30.74	100	315		4.02	35.15	69.91	80.38	-10.47	Ch. 165

NOTE: The “Band Edge Field Strength” was calculated using the “Fundamental” and “Conducted Band Edge” measurements per the “Marker-Delta Method” with the following formula:

$$BE = Fm - \Delta m$$

Where

BE = Band Edge Field Strength

Fm = Measured Fundamental (Peak or Average)

Δm = Measured Conducted Band Edge Delta (Peak or Average)



Radiated Emissions Test Results (Continued)

*Fundamental Measurements in 802.11a mode (5745-5825 MHz)
Channels 149, 157, & 165
Continuous TX at Chain B Antenna port with Shanghai Universe Antennas
Aegis Labs, Inc. File #: INTEL-090601-04*

RADIATED EMISSIONS - Horizontal Antenna Polarization											
Freq. (MHz)	Meter Reading (dBuV)	Antenna Height (cm)	Azimuth (degrees)	Quasi pk or AVG (dBuV)		Cable Factor (dB)	Ant. Factor (dB)	Corrected Reading (dBuV/m)	Limits (dBuV/m)	Diff (dB) +=FAIL	Comments
5745.00	63.83	100	315			3.98	34.89	102.71			Ch. 149
5745.00				53.83	A	3.98	34.89	92.71			
5785.00	63.00	100	315			4.00	34.94	101.94			Ch. 157
5785.00				53.17	A	4.00	34.94	92.11			
5825.00	60.17	100	315			4.01	34.99	99.17			Ch. 165
5825.00				51.00	A	4.01	34.99	90.00			

RADIATED EMISSIONS - Vertical Antenna Polarization											
Freq. (MHz)	Meter Reading (dBuV)	Antenna Height (cm)	Azimuth (degrees)	Quasi pk or AVG (dBuV)		Cable Factor (dB)	Ant. Factor (dB)	Corrected Reading (dBuV/m)	Limits (dBuV/m)	Diff (dB) +=FAIL	Comments
5745.00	64.17	100	315			3.98	35.05	103.20			Ch. 149
5745.00				54.50	A	3.98	35.05	93.53			
5785.00	62.83	100	315			4.00	35.09	101.91			Ch. 157
5785.00				53.83	A	4.00	35.09	92.91			
5825.00	61.33	100	315			4.01	35.13	100.47			Ch. 165
5825.00				51.67	A	4.01	35.13	90.81			

NOTE: Fundamental signals measured to calculate the band edge field strengths using the “Marker Delta Method”.



Radiated Emissions Test Results (Continued)

*Band Edge Field Strength Measurements in 802.11a mode (5745-5825 MHz)
Channels 149 & 165
Continuous TX at Chain B Antenna port with Shanghai Universe Antennas
Aegis Labs, Inc. File #: INTEL-090601-04*

RADIATED EMISSIONS - Horizontal Antenna Polarization										
<i>Freq. (MHz)</i>	<i>Meter Reading (dBuV)</i>	<i>Antenna Height (cm)</i>	<i>Azimuth (degrees)</i>	<i>Quasi pk or AVG (dBuV)</i>	<i>Cable Factor (dB)</i>	<i>Ant. Factor (dB)</i>	<i>Corrected Reading (dBuV/m)</i>	<i>Limits (dBuV/m)</i>	<i>Diff (dB) +=FAIL</i>	<i>Comments</i>
5725.00	35.00	100	315		3.98	34.87	73.85	82.71	-8.86	Ch. 149
5850.00	32.17	100	315		4.02	35.02	71.21	79.17	-7.96	Ch. 165

RADIATED EMISSIONS - Vertical Antenna Polarization										
<i>Freq. (MHz)</i>	<i>Meter Reading (dBuV)</i>	<i>Antenna Height (cm)</i>	<i>Azimuth (degrees)</i>	<i>Quasi pk or AVG (dBuV)</i>	<i>Cable Factor (dB)</i>	<i>Ant. Factor (dB)</i>	<i>Corrected Reading (dBuV/m)</i>	<i>Limits (dBuV/m)</i>	<i>Diff (dB) +=FAIL</i>	<i>Comments</i>
5725.00	36.33	100	315		3.98	35.03	75.33	83.20	-7.87	Ch. 149
5850.00	31.83	100	315		4.02	35.15	71.00	80.47	-9.47	Ch. 165

NOTE: The “Band Edge Field Strength” was calculated using the “Fundamental” and “Conducted Band Edge” measurements per the “Marker-Delta Method” with the following formula:

$$BE = F_m - \Delta m$$

Where

BE = Band Edge Field Strength

F_m = Measured Fundamental (Peak or Average)

Δ_m = Measured Conducted Band Edge Delta (Peak or Average)



Radiated Emissions Test Results (Continued)

*Spurious Emissions Measurements in 802.11a mode (5745-5825 MHz)
Channels 149, 157, & 165
Continuous TX at Chain A & B Antenna ports with Shanghai Universe Antennas
Aegis Labs, Inc. File #: INTEL-090601-06*

RADIATED EMISSIONS - Horizontal Antenna Polarization

Freq. (MHz)	Meter Reading (dBuV)	Antenna Height (cm)	Azimuth (degrees)	Quasi pk or AVG (dBuV)		Preamp Factor (dB)	Cable Factor (dB)	Ant. Factor (dB)	Corrected Reading (dBuV)	Limits (dBuV)	Diff (dB) +/-FAIL	Channel/ Chain Tested
7713.32	52.33	100	270			45.55	4.67	35.83	47.28	74.00	-26.72	Ch. 157/
7713.32		100	270	44.84	A	45.55	4.67	35.83	39.79	54.00	-14.21	A
11569.98	51.00	100	0			45.34	5.93	38.36	49.94	74.00	-24.06	
11569.98		100	0	38.13	A	45.34	5.93	38.36	37.07	54.00	-16.93	
3856.66	51.83	100	315			47.58	3.22	33.23	40.70	74.00	-33.30	Ch. 157/
7713.32	52.67	100	315			45.55	4.67	35.83	47.62	74.00	-26.38	B
7713.32		100	315	40.99	A	45.55	4.67	35.83	35.94	54.00	-18.06	
3830.00	52.00	100	315			47.56	3.23	33.20	40.87	74.00	-33.13	Ch. 149/
7660.00	52.00	100	315			45.57	4.65	35.80	46.87	74.00	-27.13	A
7660.00		100	315	40.90	A	45.57	4.65	35.80	35.77	54.00	-18.23	
3883.33	51.83	100	270			47.60	3.22	33.26	40.71	74.00	-33.29	Ch.165/
7666.66	52.67	100	315			45.57	4.65	35.80	47.55	74.00	-26.45	A
7666.66		100	315	40.81	A	45.57	4.65	35.80	35.69	54.00	-18.31	

RADIATED EMISSIONS - Vertical Antenna Polarization

Freq. (MHz)	Meter Reading (dBuV)	Antenna Height (cm)	Azimuth (degrees)	Quasi pk or AVG (dBuV)		Preamp Factor (dB)	Cable Factor (dB)	Ant. Factor (dB)	Corrected Reading (dBuV)	Limits (dBuV)	Diff (dB) +/-FAIL	Channel/ Chain Tested
3856.66	52.83	100	0			47.58	3.22	33.17	41.64	74.00	-32.36	Ch. 157/
7713.32	52.00	100	315			45.55	4.67	35.79	46.90	74.00	-27.10	A
7713.32		100	315	43.98	A	45.55	4.67	35.79	38.88	54.00	-15.12	
11569.98	50.83	100	0			45.34	5.93	38.36	49.77	74.00	-24.23	
11569.98		100	0	40.13	A	45.34	5.93	38.36	39.07	54.00	-14.93	
3856.66	53.83	100	0			47.58	3.22	33.17	42.64	74.00	-31.36	Ch. 157/
7713.32	53.50	100	0			45.55	4.67	35.79	48.40	74.00	-25.60	B
7713.32		100	0	44.17	A	45.55	4.67	35.79	39.07	54.00	-14.93	
3830.00	52.83	100	0			47.56	3.23	33.13	41.63	74.00	-32.37	Ch. 149/
7660.00	53.33	100	0			45.57	4.65	35.76	48.17	74.00	-25.83	A
7660.00		100	0	43.91	A	45.57	4.65	35.76	38.75	54.00	-15.25	
3883.33	52.50	100	0			47.60	3.22	33.21	41.33	74.00	-32.67	Ch.165/
7666.66	54.17	100	0			45.57	4.65	35.77	49.02	74.00	-24.98	A
7666.66		100	0	45.79	A	45.57	4.65	35.77	40.64	54.00	-13.36	

**RADIATED EMISSIONS TEST RESULTS**

CLIENT:	Intel Corporation	DATE:	08/17/09
EUT:	Intel® Centrino® Ultimate-N 6200	PROJECT NUMBER:	INTEL-090601
MODEL NUMBER:	622ANHMW	TEST ENGINEER:	JC
SERIAL NUMBER:	0015005A3C7C	SITE #:	2
CONFIGURATION:	Tested installed in an extender board connected to the host laptop's mini PCI slot in 802.11b (2400-2483.5 MHz) mode.	TEMPERATURE:	24° C
		HUMIDITY:	46% RH
		TIME:	9:30 AM

Description:	Radiated RF Emissions (1 GHz – 18 GHz)
Results:	PASSED Horizontal and Vertical Antenna Polarizations Class B Limits
Note:	Radiated Emissions Measurements were performed on the EUT with power supply set at the following voltage and frequency. <ul style="list-style-type: none"> • 120VAC / 60 Hz.

Unwanted Spurious Emissions Limits			
Frequency (MHz)	Field Strength (uV/m)	Field Strength (dBuV/m) (Emissions in the restricted bands)	Field Strength (dBm/MHz) (Emissions outside the restricted bands)
Above 960	500	54.00 (Average) 74.00 (Peak)	< -20 dBc

Radiated Emissions Sample Calculations

$$\text{Corrected Meter Reading} = \text{Meter Reading} + F + C - D$$

Where, F = Antenna Factor

C = Cable Factor

G = Amplifier Gain

D = Distance Factor (if applicable)

Therefore, the equation for determining the Corrected Meter Reading Limit (CML) is:

$$\text{CML} = \text{Specification Limit} - F - C + D$$



Radiated Emissions Test Results (Continued)

*Fundamental Measurements in 802.11b mode (2400-2483.5 MHz)
Channels 1, 6, & 11
Continuous TX at Chain A Antenna port with Shanghai Universe Antennas
Aegis Labs, Inc. File #: INTEL-090601-02*

RADIATED EMISSIONS - Horizontal Antenna Polarization											
Freq. (MHz)	Meter Reading (dBuV)	Antenna Height (cm)	Azimuth (degrees)	Quasi pk or AVG (dBuV)		Cable Factor (dB)	Ant. Factor (dB)	Corrected Reading (dBuV/m)	Limits (dBuV/m)	Diff (dB) +=FAIL	Comments
2412.00	68.32	100	225			2.53	32.18	103.02			Ch. 1
2412.00				66.12	A	2.53	32.18	100.82			
2437.00	66.68	100	225			2.54	32.21	101.43			Ch. 6
2437.00				64.94	A	2.54	32.21	99.69			
2462.00	66.24	100	225			2.55	32.25	101.04			Ch. 11
2462.00				64.69	A	2.55	32.25	99.49			

RADIATED EMISSIONS - Vertical Antenna Polarization											
Freq. (MHz)	Meter Reading (dBuV)	Antenna Height (cm)	Azimuth (degrees)	Quasi pk or AVG (dBuV)		Cable Factor (dB)	Ant. Factor (dB)	Corrected Reading (dBuV/m)	Limits (dBuV/m)	Diff (dB) +=FAIL	Comments
2412.00	68.42	100	0			2.53	31.89	102.84			Ch. 1
2412.00				65.68	A	2.53	31.89	100.10			
2437.00	69.38	100	0			2.54	31.92	103.84			Ch. 6
2437.00				66.45	A	2.54	31.92	100.91			
2462.00	68.12	100	0			2.55	31.95	102.63			Ch. 11
2462.00				65.27	A	2.55	31.95	99.78			

NOTE: Fundamental signals measured to calculate the band edge field strengths using the “Marker Delta Method”.



Radiated Emissions Test Results (Continued)

*Band Edge Field Strength Measurements in 802.11b mode (2400-2483.5 MHz)
Channels 1 & 11
Continuous TX at Chain A Antenna port with Shanghai Universe Antennas
Aegis Labs, Inc. File #: INTEL-090601-02*

RADIATED EMISSIONS - Horizontal Antenna Polarization										
Freq. (MHz)	Meter Reading (dBuV)	Antenna Height (cm)	Azimuth (degrees)	Quasi pk or AVG (dBuV)	Cable Factor (dB)	Ant. Factor (dB)	Corrected Reading (dBuV/m)	Limits (dBuV/m)	Diff (dB) +=FAIL	Comments
2390.00							46.36	74.00	-27.64	Ch. 1
2390.00							42.69	74.00	-31.31	
2390.00					A		39.48	54.00	-14.52	
2390.00					A		40.49	54.00	-13.51	
2397.00	35.46	100	225		2.52	32.16	70.13	83.02	-12.89	
2483.50							44.37	74.00	-29.63	Ch. 11
2483.50							41.87	74.00	-32.13	
2483.50					A		37.32	54.00	-16.68	
2483.50					A		40.32	54.00	-13.68	

RADIATED EMISSIONS - Vertical Antenna Polarization										
Freq. (MHz)	Meter Reading (dBuV)	Antenna Height (cm)	Azimuth (degrees)	Quasi pk or AVG (dBuV)	Cable Factor (dB)	Ant. Factor (dB)	Corrected Reading (dBuV/m)	Limits (dBuV/m)	Diff (dB) +=FAIL	Comments
2390.00							46.18	74.00	-27.82	Ch. 1
2390.00							42.51	74.00	-31.49	
2390.00					A		38.76	54.00	-15.24	
2390.00					A		39.77	54.00	-14.23	
2397.00	37.67	100	0		2.52	31.88	72.07	82.84	-10.77	
2483.50							45.96	74.00	-28.04	Ch. 11
2483.50							43.46	74.00	-30.54	
2483.50					A		37.61	54.00	-16.39	
2483.50					A		40.61	54.00	-13.39	

NOTE: The “Band Edge Field Strength” was calculated using the “Fundamental” and “Conducted Band Edge” measurements per the “Marker-Delta Method” with the following formula:

$$BE = Fm - \Delta m$$

Where

BE = Band Edge Field Strength

Fm = Measured Fundamental (Peak or Average)

Δm = Measured Conducted Band Edge Delta (Peak or Average)

Band-Edge Plots (Continued)

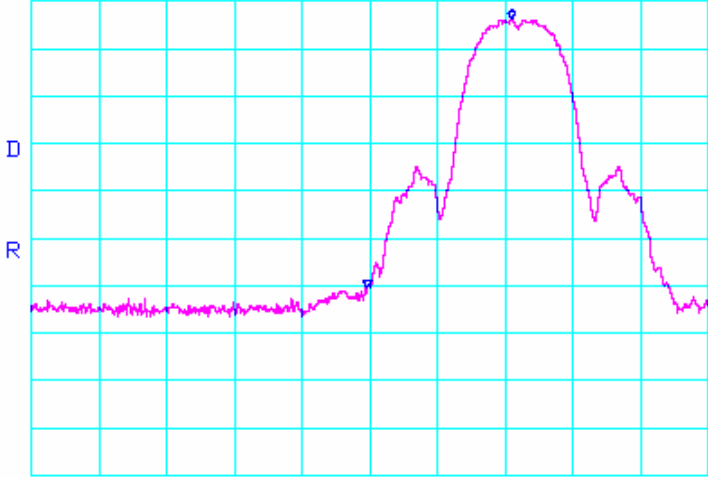
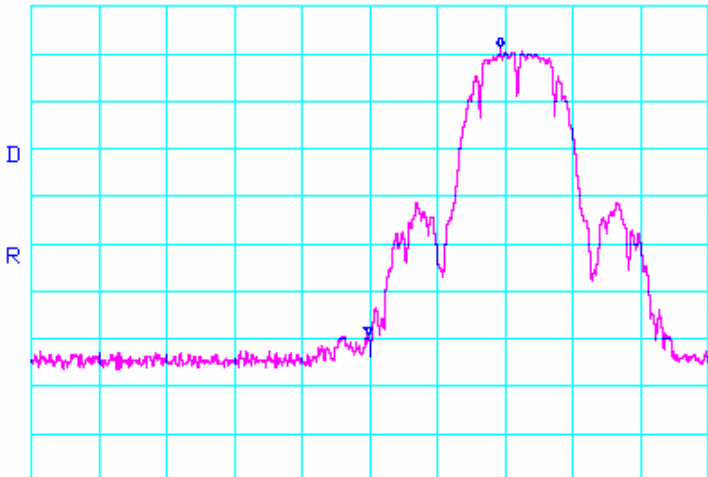
<i>Plot File Name</i>	<i>Description (RBW/VBW)</i>	<i>Test Eng.</i>
INTEL-090601-01a	Cond BE, Ch. 1, PK (1MHz/1MHz)	JC
<p>*ATTEN 10dB ΔMKR 56.66dB RL 12.0dBm 10dB/ 21.3MHz</p>  <p>CENTER 2.3900GHz SPAN 100.0MHz *RBW 1.0MHz *VBW 1.0MHz SWP 50.0ms</p>		
<i>Plot File Name</i>	<i>Description (RBW/VBW)</i>	<i>Test Eng.</i>
INTEL-090601-01b	Cond BE, Ch. 1, PK (100kHz/100kHz)	JC
<p>*ATTEN 10dB ΔMKR 60.33dB RL 12.0dBm 10dB/ 19.5MHz</p>  <p>CENTER 2.3900GHz SPAN 100.0MHz *RBW 100kHz *VBW 100kHz SWP 55.0ms</p>		



Band-Edge Plots (Continued)

Plot File Name	Description (RBW/VBW)	Test Eng.
INTEL-090601-01c	Cond BE, Ch. 1, AV (1MHz/10Hz)	JC
<p>*ATTEN 10dB ΔMKR 61.34dB RL 12.0dBm 10dB/ 19.8MHz</p> <p>CENTER 2.3900GHz SPAN 100.0MHz *RBW 1.0MHz *VBW 10Hz SWP 37.0sec</p>		
Plot File Name	Description (RBW/VBW)	Test Eng.
INTEL-090601-01d	Cond BE, Ch. 11, PK (1MHz/1MHz)	JC
<p>*ATTEN 10dB ΔMKR 56.67dB RL 12.0dBm 10dB/ -22.5MHz</p> <p>CENTER 2.4835GHz SPAN 100.0MHz *RBW 1.0MHz *VBW 1.0MHz SWP 50.0ms</p>		



Band-Edge Plots (Continued)

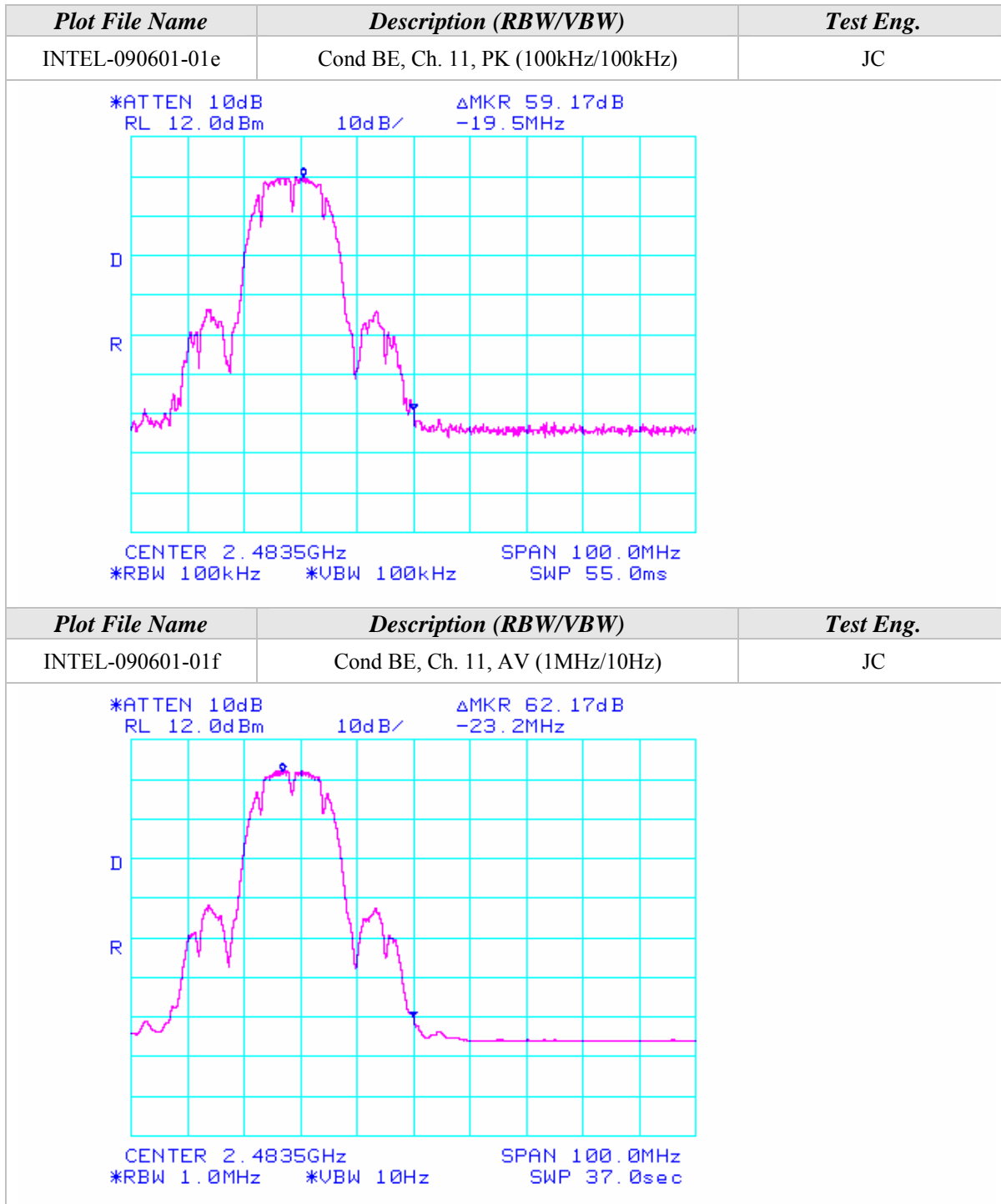



Radiated Emissions Test Results (Continued)

*Fundamental Measurements in 802.11b mode (2400-2483.5 MHz)
Channels 1, 6, & 11
Continuous TX at Chain B Antenna port with Shanghai Universe Antennas
Aegis Labs, Inc. File #: INTEL-090601-04*

RADIATED EMISSIONS - Horizontal Antenna Polarization											
<i>Freq. (MHz)</i>	<i>Meter Reading (dBuV)</i>	<i>Antenna Height (cm)</i>	<i>Azimuth (degrees)</i>	<i>Quasi pk or AVG (dBuV)</i>		<i>Cable Factor (dB)</i>	<i>Ant. Factor (dB)</i>	<i>Corrected Reading (dBuV)</i>	<i>Limits (dBuV)</i>	<i>Diff (dB) +=FAIL</i>	<i>Comments</i>
2412.00	69.29	100	315			2.53	32.18	103.99			Ch. 1
2412.00				66.73	A	2.53	32.18	101.43			
2437.00	68.76	100	315			2.54	32.21	103.51			Ch. 6
2437.00				66.24	A	2.54	32.21	100.99			
2462.00	67.68	100	315			2.55	32.25	102.48			Ch. 11
2462.00				65.49	A	2.55	32.25	100.29			

RADIATED EMISSIONS - Vertical Antenna Polarization											
<i>Freq. (MHz)</i>	<i>Meter Reading (dBuV)</i>	<i>Antenna Height (cm)</i>	<i>Azimuth (degrees)</i>	<i>Quasi pk or AVG (dBuV)</i>		<i>Cable Factor (dB)</i>	<i>Ant. Factor (dB)</i>	<i>Corrected Reading (dBuV)</i>	<i>Limits (dBuV)</i>	<i>Diff (dB) +=FAIL</i>	<i>Comments</i>
2412.00	69.28	100	180			2.53	31.89	103.70			Ch. 1
2412.00				65.96	A	2.53	31.89	100.38			
2437.00	70.39	100	180			2.54	31.92	104.85			Ch. 6
2437.00				66.43	A	2.54	31.92	100.89			
2462.00	68.45	100	180			2.55	31.95	102.96			Ch. 11
2462.00				65.18	A	2.55	31.95	99.69			

NOTE: Fundamental signals measured to calculate the band edge field strengths using the “Marker Delta Method”.



Radiated Emissions Test Results (Continued)

*Band Edge Field Strength Measurements in 802.11b mode (2400-2483.5 MHz)
Channels 1 & 11
Continuous TX at Chain B Antenna port with Shanghai Universe Antennas
Aegis Labs, Inc. File #: INTEL-090601-04*

RADIATED EMISSIONS - Horizontal Antenna Polarization										
Freq. (MHz)	Meter Reading (dBuV)	Antenna Height (cm)	Azimuth (degrees)	Quasi pk or AVG (dBuV)	Cable Factor (dB)	Ant. Factor (dB)	Corrected Reading (dBuV)	Limits (dBuV)	Diff (dB) +=FAIL	Comments
2390.00							47.33	74.00	-26.67	Ch. 1
2390.00							44.99	74.00	-29.01	
2390.00					A		40.09	54.00	-13.91	
2390.00					A		42.43	54.00	-11.57	
2397.00	36.83	100	315		2.52	32.16	71.50	83.99	-12.49	
2483.50							45.64	74.00	-28.36	Ch. 11
2483.50							42.82	74.00	-31.18	
2483.50					A		36.46	54.00	-17.54	
2483.50					A		40.63	54.00	-13.37	

RADIATED EMISSIONS - Vertical Antenna Polarization										
Freq. (MHz)	Meter Reading (dBuV)	Antenna Height (cm)	Azimuth (degrees)	Quasi pk or AVG (dBuV)	Cable Factor (dB)	Ant. Factor (dB)	Corrected Reading (dBuV)	Limits (dBuV)	Diff (dB) +=FAIL	Comments
2390.00							47.04	74.00	-26.96	Ch. 1
2390.00							44.70	74.00	-29.30	
2390.00					A		39.04	54.00	-14.96	
2390.00					A		41.38	54.00	-12.62	
2397.00	38.76	100	180		2.52	31.88	73.16	83.70	-10.54	
2483.50							46.12	74.00	-27.88	Ch. 11
2483.50							43.30	74.00	-30.70	
2483.50					A		35.86	54.00	-18.14	
2483.50					A		40.03	54.00	-13.97	

NOTE: The “Band Edge Field Strength” was calculated using the “Fundamental” and “Conducted Band Edge” measurements per the “Marker-Delta Method” with the following formula:

$$BE = Fm - \Delta m$$

Where

BE = Band Edge Field Strength

Fm = Measured Fundamental (Peak or Average)

Δm = Measured Conducted Band Edge Delta (Peak or Average)



Band-Edge Plots (Continued)

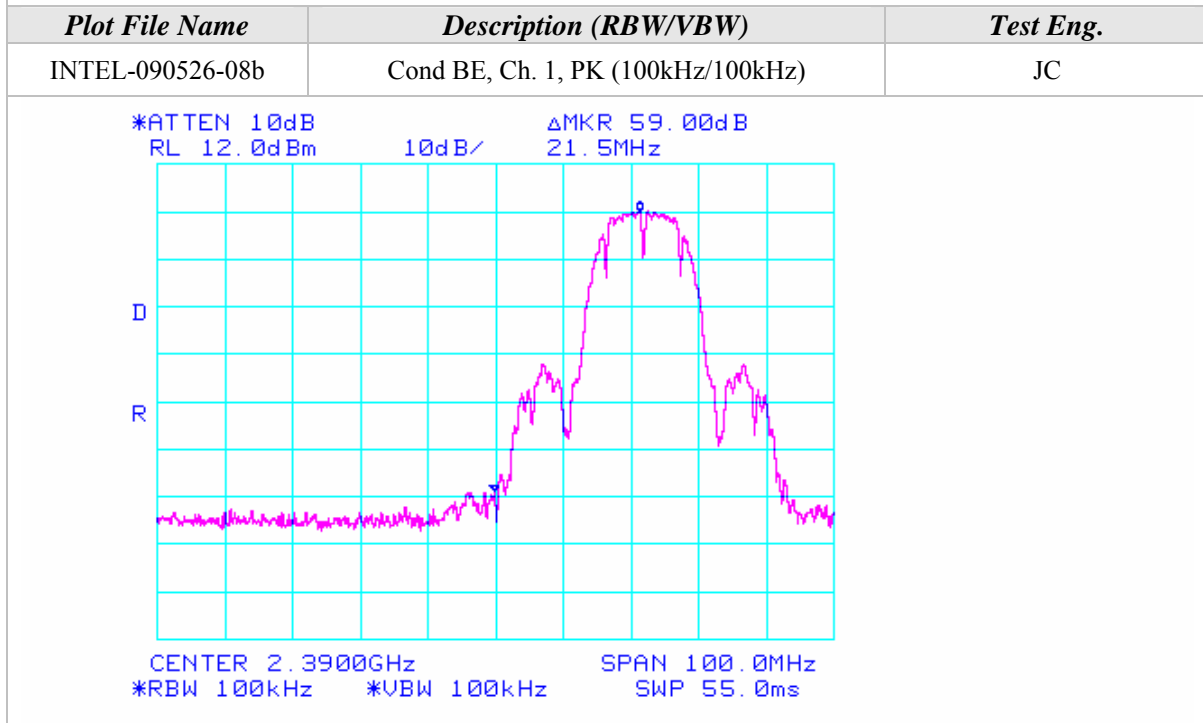
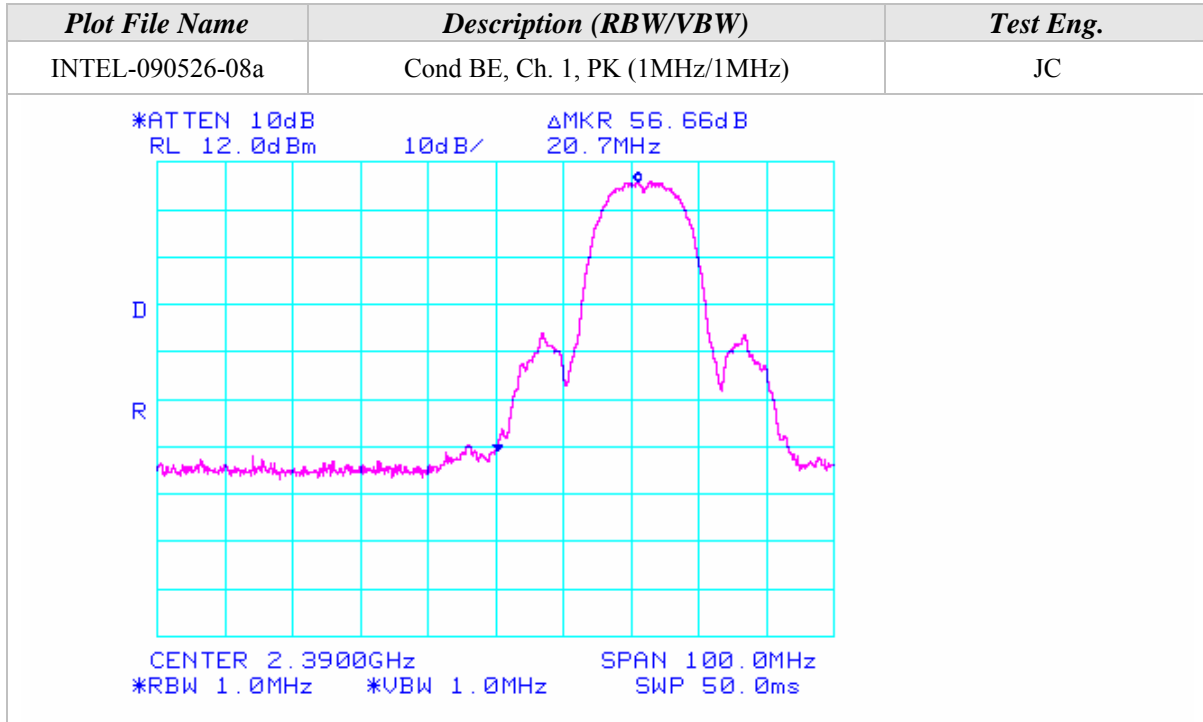



Band-Edge Plots (Continued)

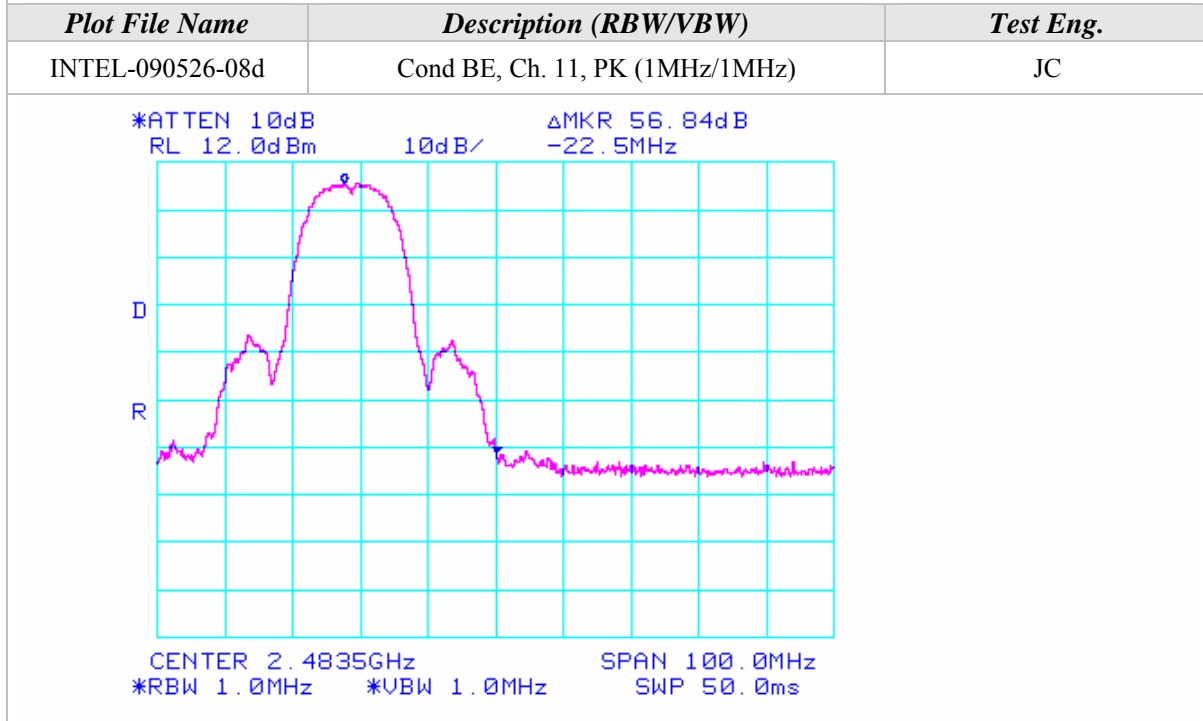
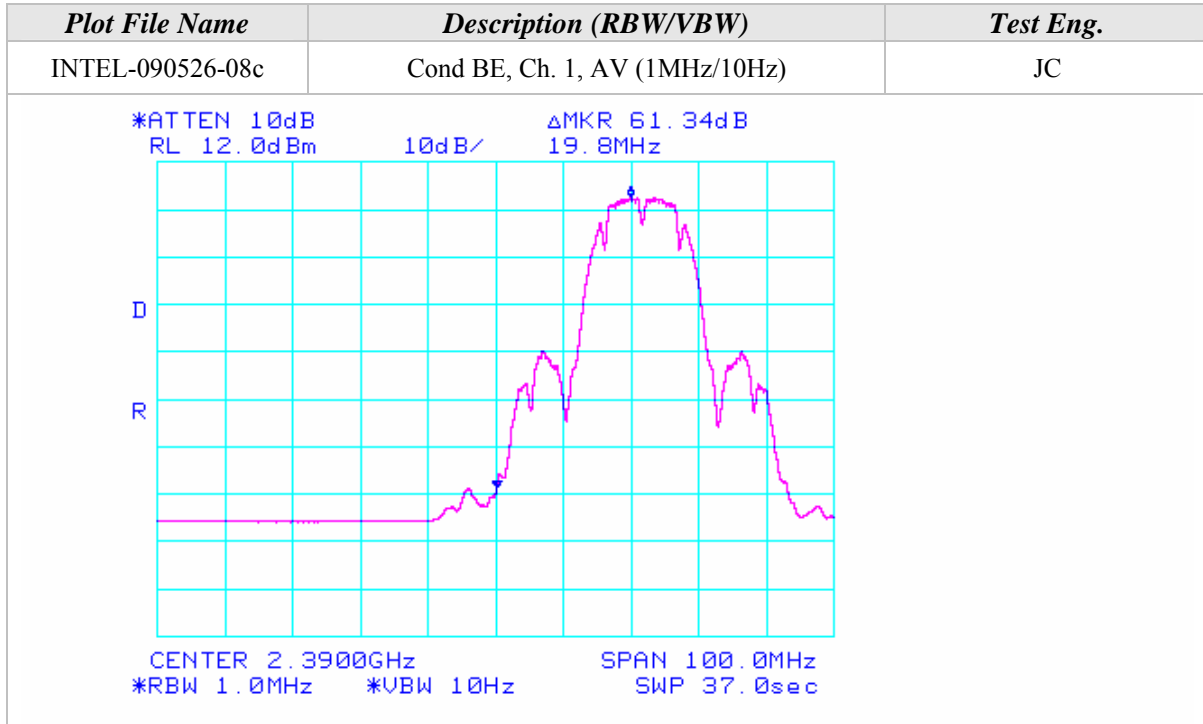

Band-Edge Plots (Continued)

<i>Plot File Name</i>	<i>Description (RBW/VBW)</i>	<i>Test Eng.</i>
INTEL-090526-08e	Cond BE, Ch. 11, PK (100kHz/100kHz)	JC

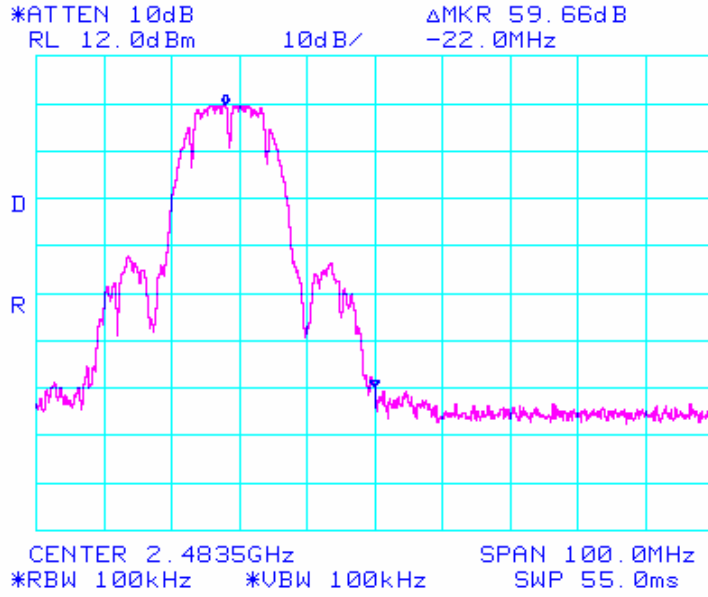

<i>Plot File Name</i>	<i>Description (RBW/VBW)</i>	<i>Test Eng.</i>
INTEL-090526-08f	Cond BE, Ch. 11, AV (1MHz/10Hz)	JC

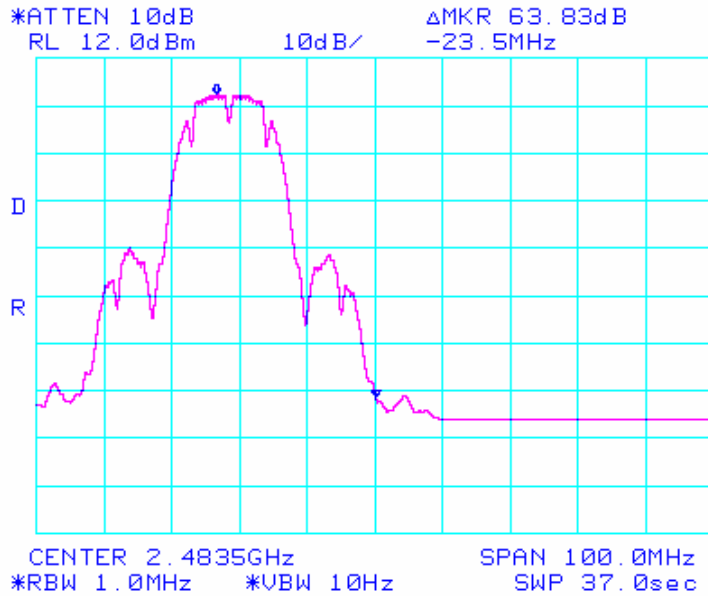



Radiated Emissions Test Results (Continued)

*Spurious Emissions Measurements in 802.11b mode (2400-2483.5 MHz)
Channels 1, 6, & 11
Continuous TX at Chain A & B Antenna ports with Shanghai Universe Antennas
Aegis Labs, Inc. File #: INTEL-090601-06*

RADIATED EMISSIONS - Horizontal Antenna Polarization												
Freq. (MHz)	Meter Reading (dBuV)	Antenna Height (cm)	Azimuth (degrees)	Quasi pk or AVG (dBuV)		Preamplifier Factor (dB)	Cable Factor (dB)	Ant. Factor (dB)	Corrected Reading (dBuV)	Limits (dBuV)	Diff (dB) +=FAIL	Channel/Chain Tested
4873.98	54.50	100	90			47.50	3.64	34.13	44.76	74.00	-29.24	Ch. 6/
4873.98		100	90	45.79	A	47.50	3.64	34.13	36.05	54.00	-17.95	A
4873.98	55.67	100	45			47.50	3.64	34.13	45.93	74.00	-28.07	Ch. 6/
4873.98		100	45	48.94	A	47.50	3.64	34.13	39.20	54.00	-14.80	B
3216.00	53.83	100	315			47.60	2.91	32.74	41.89	74.00	-32.11	Ch. 1/
4824.00	56.83	100	315			47.51	3.59	34.14	47.04	74.00	-26.96	B
4824.00		100	315	50.71	A	47.51	3.59	34.14	40.92	54.00	-13.08	
4923.99	54.83	100	45			47.49	3.67	34.12	45.13	74.00	-28.87	Ch. 11/
4923.99		100	45	45.63	A	47.49	3.67	34.12	35.93	54.00	-18.07	B

RADIATED EMISSIONS - Vertical Antenna Polarization												
Freq. (MHz)	Meter Reading (dBuV)	Antenna Height (cm)	Azimuth (degrees)	Quasi pk or AVG (dBuV)		Preamplifier Factor (dB)	Cable Factor (dB)	Ant. Factor (dB)	Corrected Reading (dBuV)	Limits (dBuV)	Diff (dB) +=FAIL	Channel/Chain Tested
4873.98	56.67	100	315			47.50	3.64	34.30	47.11	74.00	-26.89	Ch. 6/
4873.98				46.40	A	47.50	3.64	34.30	36.84	54.00	-17.16	A
6498.64	52.50	100	270			46.93	4.22	35.50	45.29	74.00	-28.71	
4873.98	58.50	100	45			47.50	3.64	34.30	48.94	74.00	-25.06	Ch. 6/
4873.98		100	45	53.44	A	47.50	3.64	34.30	43.88	54.00	-10.12	B
6498.64	52.50	100	90			46.93	4.22	35.50	45.29	74.00	-28.71	
4824.00	57.00	100	270			47.51	3.59	34.30	47.38	74.00	-26.62	Ch. 1/
4824.00		100	270	52.42	A	47.51	3.59	34.30	42.80	54.00	-11.20	B
6432.00	52.33	100	0			46.99	4.20	35.47	45.02	74.00	-28.98	
4923.92	55.00	100	270			47.49	3.67	34.30	45.49	74.00	-28.51	Ch. 11/
4923.92		100	270	48.09	A	47.49	3.67	34.30	38.58	54.00	-15.42	B
6565.16	51.50	100	90			46.83	4.25	35.51	44.43	74.00	-29.57	

**RADIATED EMISSIONS TEST RESULTS**

CLIENT:	Intel Corporation	DATE:	08/17/09
EUT:	Intel® Centrino® Ultimate-N 6200	PROJECT NUMBER:	INTEL-090601
MODEL NUMBER:	622ANHMW	TEST ENGINEER:	JC
SERIAL NUMBER:	0015005A3C7C	SITE #:	2
CONFIGURATION:	Tested installed in an extender board connected to the host laptop's mini PCI slot in 802.11g (2400-2483.5 MHz) mode.	TEMPERATURE:	24° C
		HUMIDITY:	46% RH
		TIME:	9:30 AM

Description:	Radiated RF Emissions (1 GHz – 18 GHz)
Results:	PASSED Horizontal and Vertical Antenna Polarizations Class B Limits
Note:	Radiated Emissions Measurements were performed on the EUT with power supply set at the following voltage and frequency. <ul style="list-style-type: none"> • 120VAC / 60 Hz.

Unwanted Spurious Emissions Limits			
Frequency (MHz)	Field Strength (uV/m)	Field Strength (dBuV/m) (Emissions in the restricted bands)	Field Strength (dBm/MHz) (Emissions outside the restricted bands)
Above 960	500	54.00 (Average) 74.00 (Peak)	< -20 dBc

Radiated Emissions Sample Calculations

$$\text{Corrected Meter Reading} = \text{Meter Reading} + F + C - D$$

Where, F = Antenna Factor

C = Cable Factor

G = Amplifier Gain

D = Distance Factor (if applicable)

Therefore, the equation for determining the Corrected Meter Reading Limit (CML) is:

$$\text{CML} = \text{Specification Limit} - F - C + D$$



Radiated Emissions Test Results (Continued)

*Fundamental Measurements in 802.11g mode (2400-2483.5 MHz)
Channels 1, 6, & 11
Continuous TX at Chain A Antenna port with Shanghai Universe Antennas
Aegis Labs, Inc. File #: INTEL-090601-02*

RADIATED EMISSIONS - Horizontal Antenna Polarization											
Freq. (MHz)	Meter Reading (dBuV)	Antenna Height (cm)	Azimuth (degrees)	Quasi pk or AVG (dBuV)		Cable Factor (dB)	Ant. Factor (dB)	Corrected Reading (dBuV)	Limits (dBuV)	Diff (dB) +=FAIL	Comments
2412.00	70.74	100	225			2.53	32.18	105.44			Ch. 1
2412.00				63.96	A	2.53	32.18	98.66			
2437.00	72.26	100	225			2.54	32.21	107.01			Ch. 6
2437.00				66.25	A	2.54	32.21	101.00			
2462.00	71.72	100	225			2.55	32.25	106.52			Ch. 11
2462.00				65.17	A	2.55	32.25	99.97			

RADIATED EMISSIONS - Vertical Antenna Polarization											
Freq. (MHz)	Meter Reading (dBuV)	Antenna Height (cm)	Azimuth (degrees)	Quasi pk or AVG (dBuV)		Cable Factor (dB)	Ant. Factor (dB)	Corrected Reading (dBuV)	Limits (dBuV)	Diff (dB) +=FAIL	Comments
2412.00	69.71	100	0			2.53	31.89	104.13			Ch. 1
2412.00				61.46	A	2.53	31.89	95.88			
2437.00	72.42	100	0			2.54	31.92	106.88			Ch. 6
2437.00				64.80	A	2.54	31.92	99.26			
2462.00	70.84	100	0			2.55	31.95	105.35			Ch. 11
2462.00				62.09	A	2.55	31.95	96.60			

NOTE: Fundamental signals measured to calculate the band edge field strengths using the "Marker Delta Method".



Radiated Emissions Test Results (Continued)

*Band Edge Field Strength Measurements in 802.11g mode (2400-2483.5 MHz)
Channels 1 & 11
Continuous TX at Chain A Antenna port with Shanghai Universe Antennas
Aegis Labs, Inc. File #: INTEL-090601-02*

RADIATED EMISSIONS - Horizontal Antenna Polarization										
Freq. (MHz)	Meter Reading (dBuV)	Antenna Height (cm)	Azimuth (degrees)	Quasi pk or AVG (dBuV)	Cable Factor (dB)	Ant. Factor (dB)	Corrected Reading (dBuV)	Limits (dBuV)	Diff (dB) +=FAIL	Comments
2390.00							62.11	74.00	-11.89	Ch. 1
2390.00						55.44	74.00	-18.56		
2390.00				A		47.66	54.00	-6.34		
2390.00				A		48.66	54.00	-5.34		
2400.00	41.85	100	225		2.52	32.16	76.53	85.44	-8.91	
2483.50							62.69	74.00	-11.31	Ch. 11
2483.50						56.02	74.00	-17.98		
2483.50				A		47.30	54.00	-6.70		
2483.50				A		49.47	54.00	-4.53		

RADIATED EMISSIONS - Vertical Antenna Polarization										
Freq. (MHz)	Meter Reading (dBuV)	Antenna Height (cm)	Azimuth (degrees)	Quasi pk or AVG (dBuV)	Cable Factor (dB)	Ant. Factor (dB)	Corrected Reading (dBuV)	Limits (dBuV)	Diff (dB) +=FAIL	Comments
2390.00							60.80	74.00	-13.20	Ch. 1
2390.00						54.13	74.00	-19.87		
2390.00				A		44.88	54.00	-9.12		
2390.00				A		45.88	54.00	-8.12		
2400.00	42.50	100	0		2.52	31.88	76.90	84.13	-7.23	
2483.50							61.52	74.00	-12.48	Ch. 11
2483.50						54.85	74.00	-19.15		
2483.50				A		43.93	54.00	-10.07		
2483.50				A		46.10	54.00	-7.90		

NOTE: The “Band Edge Field Strength” was calculated using the “Fundamental” and “Conducted Band Edge” measurements per the “Marker-Delta Method” with the following formula:

$$BE = Fm - \Delta m$$

Where

BE = Band Edge Field Strength

Fm = Measured Fundamental (Peak or Average)

Δm = Measured Conducted Band Edge Delta (Peak or Average)



Band-Edge Plots (Continued)

<i>Plot File Name</i>	<i>Description (RBW/VBW)</i>	<i>Test Eng.</i>
INTEL-090601-02a	Cond BE, Ch. 1, PK (1MHz/1MHz)	JC
<p>*ATTEN 10dB ΔMKR 43.33dB RL 12.0dBm 10dB/ 25.2MHz</p> <p>CENTER 2.3900GHz SPAN 100.0MHz *RBW 1.0MHz *VBW 1.0MHz SWP 50.0ms</p>		
<i>Plot File Name</i>	<i>Description (RBW/VBW)</i>	<i>Test Eng.</i>
INTEL-090601-02b	Cond BE, Ch. 1, PK (100kHz/100kHz)	JC
<p>*ATTEN 10dB ΔMKR 50.00dB RL 12.0dBm 10dB/ 16.8MHz</p> <p>CENTER 2.3900GHz SPAN 100.0MHz *RBW 100kHz *VBW 100kHz SWP 55.0ms</p>		

Band-Edge Plots (Continued)

<i>Plot File Name</i>	<i>Description (RBW/VBW)</i>	<i>Test Eng.</i>
INTEL-090601-02c	Cond BE, Ch. 1, AV (1MHz/10Hz)	JC
<p>*ATTEN 10dB ΔMKR 51.00dB RL 12.0dBm 10dB/ 24.7MHz</p> <p>CENTER 2.3900GHz SPAN 100.0MHz *RBW 1.0MHz *VBW 10Hz SWP 37.0sec</p>		
<i>Plot File Name</i>	<i>Description (RBW/VBW)</i>	<i>Test Eng.</i>
INTEL-090601-02d	Cond BE, Ch. 11, PK (1MHz/1MHz)	JC
<p>*ATTEN 10dB ΔMKR 43.83dB RL 12.0dBm 10dB/ -25.8MHz</p> <p>CENTER 2.4835GHz SPAN 100.0MHz *RBW 1.0MHz *VBW 1.0MHz SWP 50.0ms</p>		

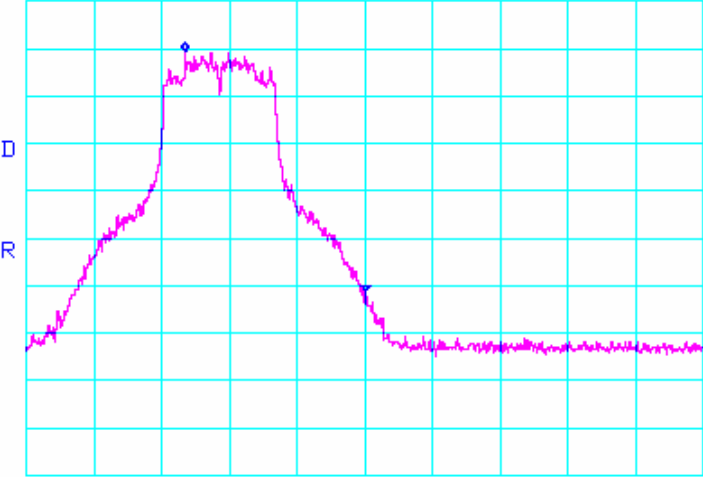
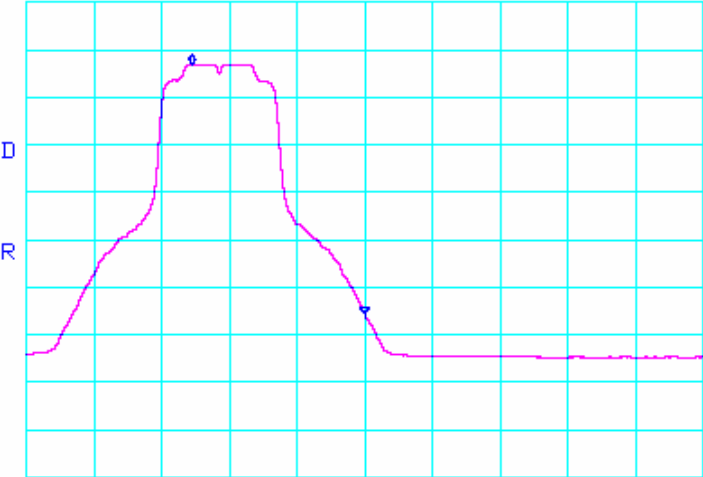

Band-Edge Plots (Continued)

Plot File Name	Description (RBW/VBW)	Test Eng.
INTEL-090601-02e	Cond BE, Ch. 11, PK (100kHz/100kHz)	JC
<p data-bbox="337 401 954 451">*ATTEN 10dB ΔMKR 50.50dB RL 12.0dBm 10dB/ -26.7MHz</p>  <p data-bbox="337 934 1036 987">CENTER 2.4835GHz SPAN 100.0MHz *RBW 100kHz *VBW 100kHz SWP 55.0ms</p>		
Plot File Name	Description (RBW/VBW)	Test Eng.
INTEL-090601-02f	Cond BE, Ch. 11, AV (1MHz/10Hz)	JC
<p data-bbox="337 1119 954 1169">*ATTEN 10dB ΔMKR 52.67dB RL 12.0dBm 10dB/ -25.5MHz</p>  <p data-bbox="337 1652 1036 1705">CENTER 2.4835GHz SPAN 100.0MHz *RBW 1.0MHz *VBW 10Hz SWP 37.0sec</p>		



Radiated Emissions Test Results (Continued)

*Fundamental Measurements in 802.11g mode (2400-2483.5 MHz)
Channels 1, 6, & 11
Continuous TX at Chain B Antenna port with Shanghai Universe Antennas
Aegis Labs, Inc. File #: INTEL-090601-04*

RADIATED EMISSIONS - Horizontal Antenna Polarization											
Freq. (MHz)	Meter Reading (dBuV)	Antenna Height (cm)	Azimuth (degrees)	Quasi pk or AVG (dBuV)		Cable Factor (dB)	Ant. Factor (dB)	Corrected Reading (dBuV)	Limits (dBuV)	Diff (dB) +=FAIL	Comments
2412.00	71.05	100	315			2.53	32.18	105.75			Ch. 1
2412.00				64.95	A	2.53	32.18	99.65			
2437.00	73.31	100	315			2.54	32.21	108.06			Ch. 6
2437.00				67.02	A	2.54	32.21	101.77			
2462.00	70.44	100	315			2.55	32.25	105.24			Ch. 11
2462.00				64.56	A	2.55	32.25	99.36			

RADIATED EMISSIONS - Vertical Antenna Polarization											
Freq. (MHz)	Meter Reading (dBuV)	Antenna Height (cm)	Azimuth (degrees)	Quasi pk or AVG (dBuV)		Cable Factor (dB)	Ant. Factor (dB)	Corrected Reading (dBuV)	Limits (dBuV)	Diff (dB) +=FAIL	Comments
2412.00	69.72	100	180			2.53	31.89	104.14			Ch. 1
2412.00				61.27	A	2.53	31.89	95.69			
2437.00	72.86	100	180			2.54	31.92	107.32			Ch. 6
2437.00				64.89	A	2.54	31.92	99.35			
2462.00	69.25	100	180			2.55	31.95	103.76			Ch. 11
2462.00				61.15	A	2.55	31.95	95.66			

NOTE: Fundamental signals measured to calculate the band edge field strengths using the “Marker Delta Method”.



Radiated Emissions Test Results (Continued)

*Band Edge Field Strength Measurements in 802.11g mode (2400-2483.5 MHz)
Channels 1 & 11
Continuous TX at Chain B Antenna port with Shanghai Universe Antennas
Aegis Labs, Inc. File #: INTEL-090601-04*

RADIATED EMISSIONS - Horizontal Antenna Polarization										
Freq. (MHz)	Meter Reading (dBuV)	Antenna Height (cm)	Azimuth (degrees)	Quasi pk or AVG (dBuV)	Cable Factor (dB)	Ant. Factor (dB)	Corrected Reading (dBuV)	Limits (dBuV)	Diff (dB) +=FAIL	Comments
2390.00							60.92	74.00	-13.08	Ch. 1
2390.00						53.75	74.00	-20.25		
2390.00				A		46.65	54.00	-7.35		
2390.00				A		47.65	54.00	-6.35		
2400.00	46.42	100	315		2.52	32.16	81.10	85.75	-4.65	
2483.50							60.41	74.00	-13.59	Ch. 11
2483.50							52.41	74.00	-21.59	
2483.50				A			46.20	54.00	-7.80	
2483.50				A			46.53	54.00	-7.47	

RADIATED EMISSIONS - Vertical Antenna Polarization										
Freq. (MHz)	Meter Reading (dBuV)	Antenna Height (cm)	Azimuth (degrees)	Quasi pk or AVG (dBuV)	Cable Factor (dB)	Ant. Factor (dB)	Corrected Reading (dBuV)	Limits (dBuV)	Diff (dB) +=FAIL	Comments
2390.00							59.31	74.00	-14.69	Ch. 1
2390.00							52.14	74.00	-21.86	
2390.00				A			42.69	54.00	-11.31	
2390.00				A			43.69	54.00	-10.31	
2400.00	43.21	100	180		2.52	31.88	77.61	84.14	-6.53	
2483.50							58.93	74.00	-15.07	Ch. 11
2483.50							50.93	74.00	-23.07	
2483.50				A			42.50	54.00	-11.50	
2483.50				A			42.83	54.00	-11.17	

NOTE: The “Band Edge Field Strength” was calculated using the “Fundamental” and “Conducted Band Edge” measurements per the “Marker-Delta Method” with the following formula:

$$BE = Fm - \Delta m$$

Where

BE = Band Edge Field Strength

Fm = Measured Fundamental (Peak or Average)

Δm = Measured Conducted Band Edge Delta (Peak or Average)

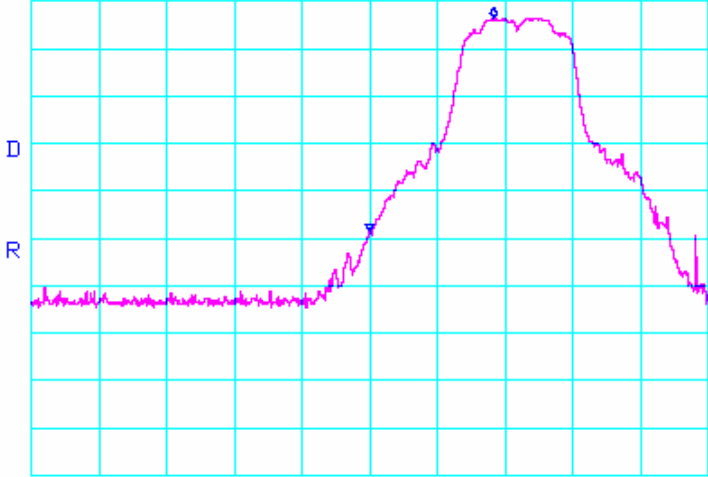
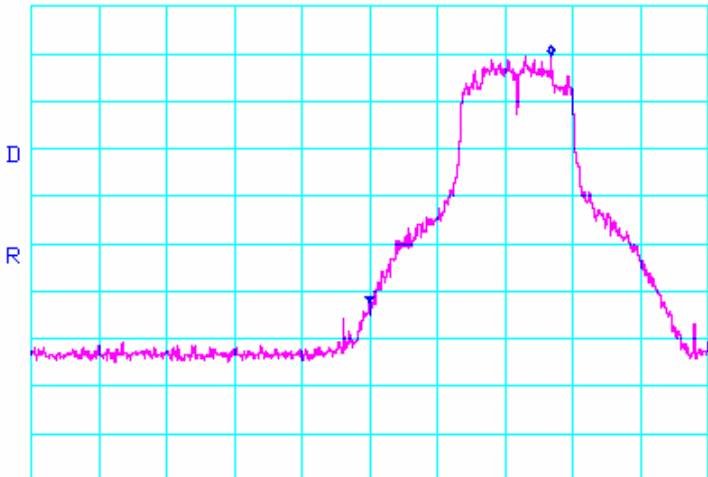

Band-Edge Plots (Continued)

<i>Plot File Name</i>	<i>Description (RBW/VBW)</i>	<i>Test Eng.</i>
INTEL-090526-09a	Cond BE, Ch. 1, PK (1MHz/1MHz)	JC
<p>*ATTEN 10dB ΔMKR 44.83dB RL 12.0dBm 10dB/ 18.3MHz</p>  <p>CENTER 2.3900GHz SPAN 100.0MHz *RBW 1.0MHz *VBW 1.0MHz SWP 50.0ms</p>		
<i>Plot File Name</i>	<i>Description (RBW/VBW)</i>	<i>Test Eng.</i>
INTEL-090526-09b	Cond BE, Ch. 1, PK (100kHz/100kHz)	JC
<p>*ATTEN 10dB ΔMKR 52.00dB RL 12.0dBm 10dB/ 26.8MHz</p>  <p>CENTER 2.3900GHz SPAN 100.0MHz *RBW 100kHz *VBW 100kHz SWP 55.0ms</p>		

Band-Edge Plots (Continued)

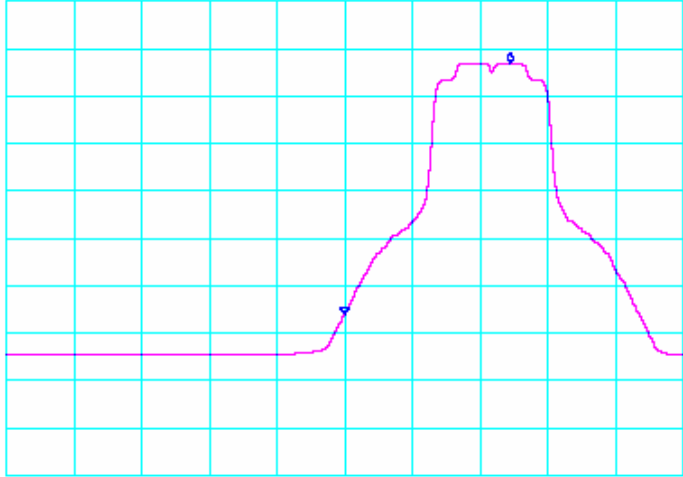
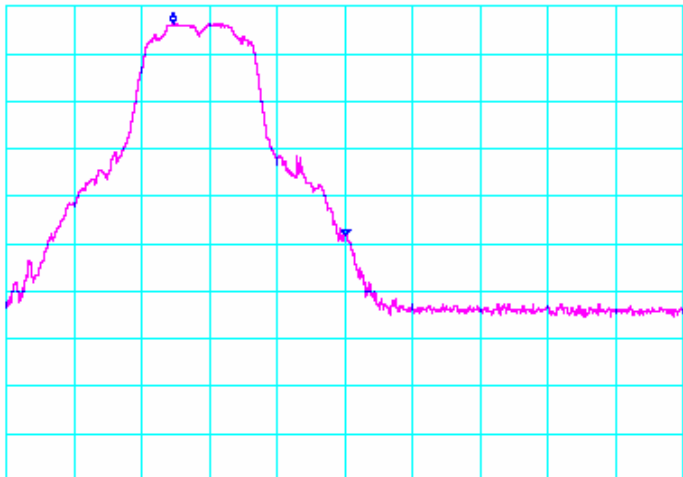
Plot File Name	Description (RBW/VBW)	Test Eng.
INTEL-090526-09c	Cond BE, Ch. 1, AV (1MHz/10Hz)	JC
<p>*ATTEN 10dB ΔMKR 53.00dB RL 12.0dBm 10dB/ 24.5MHz</p>  <p>CENTER 2.3900GHz SPAN 100.0MHz *RBW 1.0MHz *VBW 10Hz SWP 37.0sec</p>		
Plot File Name	Description (RBW/VBW)	Test Eng.
INTEL-090526-09d	Cond BE, Ch. 11, PK (1MHz/1MHz)	JC
<p>*ATTEN 10dB ΔMKR 44.83dB RL 12.0dBm 10dB/ -25.5MHz</p>  <p>CENTER 2.4835GHz SPAN 100.0MHz *RBW 1.0MHz *VBW 1.0MHz SWP 50.0ms</p>		

Band-Edge Plots (Continued)

<i>Plot File Name</i>	<i>Description (RBW/VBW)</i>	<i>Test Eng.</i>
INTEL-090526-09e	Cond BE, Ch. 11, PK (100kHz/100kHz)	JC
<p>*ATTEN 10dB ΔMKR 52.83dB RL 12.0dBm 10dB/ -16.7MHz</p> <p>CENTER 2.4835GHz SPAN 100.0MHz *RBW 100kHz *VBW 100kHz SWP 55.0ms</p>		
<i>Plot File Name</i>	<i>Description (RBW/VBW)</i>	<i>Test Eng.</i>
INTEL-090526-09f	Cond BE, Ch. 11, AV (1MHz/10Hz)	JC
<p>*ATTEN 10dB ΔMKR 53.16dB RL 12.0dBm 10dB/ -25.5MHz</p> <p>CENTER 2.4835GHz SPAN 100.0MHz *RBW 1.0MHz *VBW 10Hz SWP 37.0sec</p>		



Radiated Emissions Test Results (Continued)

*Spurious Emissions Measurements in 802.11g mode (2400-2483.5 MHz)
Channels 1, 6, & 11
Continuous TX at Chain A & B Antenna ports with Shanghai Universe Antennas
Aegis Labs, Inc. File #: INTEL-090601-06*

RADIATED EMISSIONS - Horizontal Antenna Polarization												
Freq. (MHz)	Meter Reading (dBuV)	Antenna Height (cm)	Azimuth (degrees)	Quasi pk or AVG (dBuV)		Preamp Factor (dB)	Cable Factor (dB)	Ant. Factor (dB)	Corrected Reading (dBuV)	Limits (dBuV)	Diff (dB) +=FAIL	Channel/Chain Tested
3249.33	51.83	315	315			47.61	2.94	32.75	39.91	74.00	-34.09	Ch. 6/
9748.00	51.17	100	315			45.52	5.31	36.75	47.71	74.00	-26.29	A
3249.33	52.33	100	0			47.61	2.94	32.75	40.41	74.00	-33.59	Ch. 6/B
3216.00	52.00	100	315			47.60	2.91	32.74	40.06	74.00	-33.94	Ch. 1/A
3282.66	53.33	100	315			47.62	2.97	32.76	41.43	74.00	-32.57	Ch. 11/
4924.00	52.00	100	315			47.49	3.67	34.30	42.49	74.00	-31.51	A
4924.00		100	315	40.13	A	47.49	3.67	34.30	30.62	54.00	-23.38	

RADIATED EMISSIONS - Vertical Antenna Polarization												
Freq. (MHz)	Meter Reading (dBuV)	Antenna Height (cm)	Azimuth (degrees)	Quasi pk or AVG (dBuV)		Preamp Factor (dB)	Cable Factor (dB)	Ant. Factor (dB)	Corrected Reading (dBuV)	Limits (dBuV)	Diff (dB) +=FAIL	Channel/Chain Tested
3249.33	52.83	315	0			47.61	2.94	32.75	40.91	74.00	-33.09	Ch. 6/
9748.00	52.33	100	315			45.52	5.31	36.75	48.87	74.00	-25.13	A
3249.33	53.67	100	0			47.61	2.94	32.75	41.75	74.00	-32.25	Ch. 6/B
3216.00	52.50	100	315			47.60	2.91	32.74	40.56	74.00	-33.44	Ch. 1/A
3282.66	53.67	100	315			47.62	2.97	32.76	41.77	74.00	-32.23	Ch. 11/A



RADIATED EMISSIONS TEST RESULTS

CLIENT:	Intel Corporation	DATE:	08/17/09
EUT:	Intel® Centrino® Ultimate-N 6200	PROJECT NUMBER:	INTEL-090601
MODEL NUMBER:	622ANHMW	TEST ENGINEER:	JC
SERIAL NUMBER:	0015005A3C7C	SITE #:	2
CONFIGURATION:	Tested installed in an extender board connected to the host laptop's mini PCI slot in 802.11n (2400-2483.5 MHz) mode 20MHz Wide.	TEMPERATURE:	24° C
		HUMIDITY:	46% RH
		TIME:	9:30 AM

Description:	Radiated RF Emissions (1 GHz – 18 GHz)
Results:	PASSED Horizontal and Vertical Antenna Polarizations Class B Limits
Note:	Radiated Emissions Measurements were performed on the EUT with power supply set at the following voltage and frequency. <ul style="list-style-type: none"> • 120VAC / 60 Hz.

Unwanted Spurious Emissions Limits			
Frequency (MHz)	Field Strength (uV/m)	Field Strength (dBuV/m) (Emissions in the restricted bands)	Field Strength (dBm/MHz) (Emissions outside the restricted bands)
Above 960	500	54.00 (Average) 74.00 (Peak)	< -20 dBc

Radiated Emissions Sample Calculations

$$\text{Corrected Meter Reading} = \text{Meter Reading} + F + C - D$$

- Where, F = Antenna Factor
 C = Cable Factor
 G = Amplifier Gain
 D = Distance Factor (if applicable)

Therefore, the equation for determining the Corrected Meter Reading Limit (CML) is:

$$\text{CML} = \text{Specification Limit} - F - C + D$$



Radiated Emissions Test Results (Continued)

*Fundamental Measurements in 802.11n mode 20MHz Wide (2400-2483.5 MHz)
Channels 1, 6, & 11
Continuous TX at Chain A Antenna port with Shanghai Universe Antennas
Aegis Labs, Inc. File #: INTEL-090601-02*

RADIATED EMISSIONS - Horizontal Antenna Polarization											
Freq. (MHz)	Meter Reading (dBuV)	Antenna Height (cm)	Azimuth (degrees)	Quasi pk or AVG (dBuV)		Cable Factor (dB)	Ant. Factor (dB)	Corrected Reading (dBuV)	Limits (dBuV)	Diff (dB) +=FAIL	Comments
2412.00	70.40	100	225			2.53	32.18	105.10			Ch. 1
2412.00				63.61	A	2.53	32.18	98.31			
2437.00	71.78	100	225			2.54	32.21	106.53			Ch. 6
2437.00				65.02	A	2.54	32.21	99.77			
2462.00	70.61	100	180			2.55	32.25	105.41			Ch. 11
2462.00				63.97	A	2.55	32.25	98.77			

RADIATED EMISSIONS - Vertical Antenna Polarization											
Freq. (MHz)	Meter Reading (dBuV)	Antenna Height (cm)	Azimuth (degrees)	Quasi pk or AVG (dBuV)		Cable Factor (dB)	Ant. Factor (dB)	Corrected Reading (dBuV)	Limits (dBuV)	Diff (dB) +=FAIL	Comments
2412.00	70.63	100	0			2.53	31.89	105.05			Ch. 1
2412.00				62.37	A	2.53	31.89	96.79			
2437.00	71.59	100	0			2.54	31.92	106.05			Ch. 6
2437.00				63.48	A	2.54	31.92	97.94			
2462.00	70.37	100	0			2.55	31.95	104.88			Ch. 11
2462.00				62.39	A	2.55	31.95	96.90			

NOTE: Fundamental signals measured to calculate the band edge field strengths using the “Marker Delta Method”.



Radiated Emissions Test Results (Continued)

*Band Edge Field Strength Measurements in 802.11n mode 20MHz Wide (2400-2483.5 MHz)
Channels 1 & 11
Continuous TX at Chain A Antenna port with Shanghai Universe Antennas
Aegis Labs, Inc. File #: INTEL-090601-02*

RADIATED EMISSIONS - Horizontal Antenna Polarization										
Freq. (MHz)	Meter Reading (dBuV)	Antenna Height (cm)	Azimuth (degrees)	Quasi pk or AVG (dBuV)	Cable Factor (dB)	Ant. Factor (dB)	Corrected Reading (dBuV)	Limits (dBuV)	Diff (dB) +=FAIL	Comments
2390.00							67.60	74.00	-6.40	Ch. 1
2390.00							57.60	74.00	-16.40	
2390.00					A		49.81	54.00	-4.19	
2390.00					A		50.81	54.00	-3.19	
2400.00	40.78	100	225		2.52	32.16	75.46	85.10	-9.64	
2483.50							63.24	74.00	-10.76	Ch. 11
2483.50							55.74	74.00	-18.26	
2483.50					A		48.93	54.00	-5.07	
2483.50					A		49.10	54.00	-4.90	

RADIATED EMISSIONS - Vertical Antenna Polarization										
Freq. (MHz)	Meter Reading (dBuV)	Antenna Height (cm)	Azimuth (degrees)	Quasi pk or AVG (dBuV)	Cable Factor (dB)	Ant. Factor (dB)	Corrected Reading (dBuV)	Limits (dBuV)	Diff (dB) +=FAIL	Comments
2390.00							67.55	74.00	-6.45	Ch. 1
2390.00							57.55	74.00	-16.45	
2390.00					A		48.29	54.00	-5.71	
2390.00					A		49.29	54.00	-4.71	
2400.00	41.33	100	0		2.52	31.88	75.73	85.05	-9.32	
2483.50							62.71	74.00	-11.29	Ch. 11
2483.50							55.21	74.00	-18.79	
2483.50					A		47.06	54.00	-6.94	
2483.50					A		47.23	54.00	-6.77	

NOTE: The “Band Edge Field Strength” was calculated using the “Fundamental” and “Conducted Band Edge” measurements per the “Marker-Delta Method” with the following formula:

$$BE = Fm - \Delta m$$

Where

BE = Band Edge Field Strength

Fm = Measured Fundamental (Peak or Average)

Δm = Measured Conducted Band Edge Delta (Peak or Average)



Band-Edge Plots (Continued)

<i>Plot File Name</i>	<i>Description (RBW/VBW)</i>	<i>Test Eng.</i>
INTEL-090601-03a	Cond BE, Ch. 1, PK (1MHz/1MHz)	JC

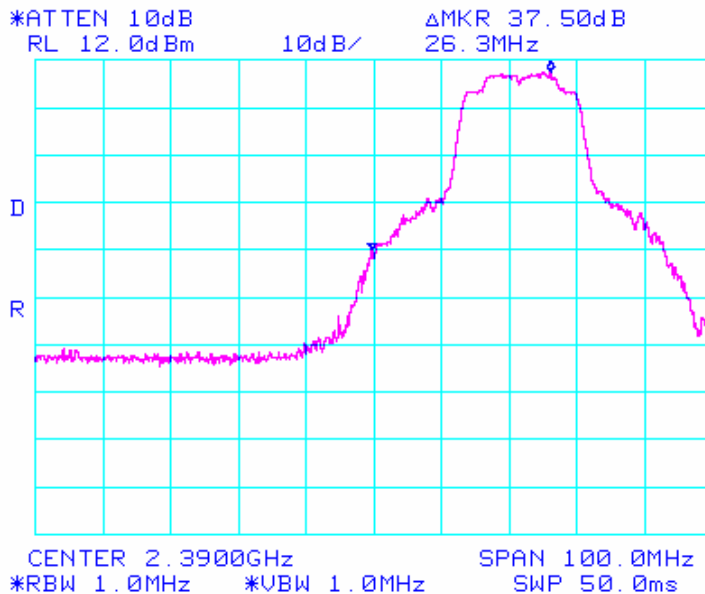

<i>Plot File Name</i>	<i>Description (RBW/VBW)</i>	<i>Test Eng.</i>
INTEL-090601-03b	Cond BE, Ch. 1, PK (100kHz/100kHz)	JC

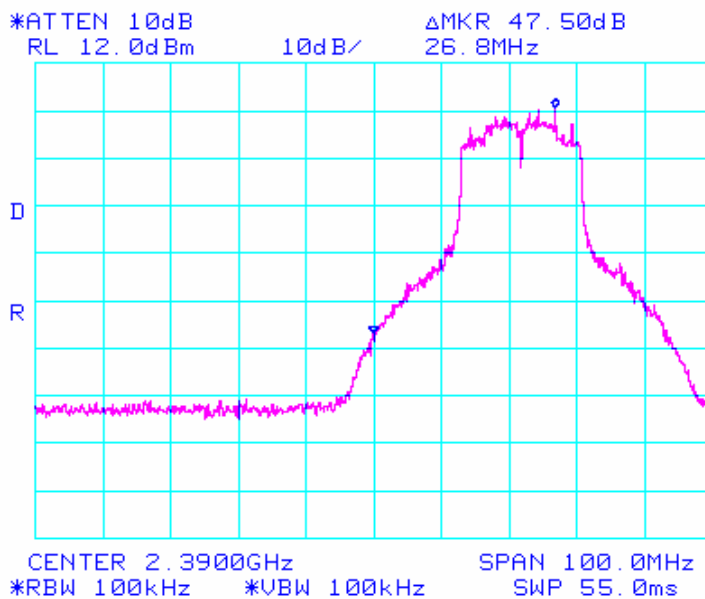

Band-Edge Plots (Continued)

<i>Plot File Name</i>	<i>Description (RBW/VBW)</i>	<i>Test Eng.</i>
INTEL-090601-03c	Cond BE, Ch. 1, AV (1MHz/10Hz)	JC
<p>*ATTEN 10dB ΔMKR 48.50dB RL 12.0dBm 10dB/ 18.5MHz</p> <p>CENTER 2.3900GHz SPAN 100.0MHz *RBW 1.0MHz *VBW 10Hz SWP 37.0sec</p>		
<i>Plot File Name</i>	<i>Description (RBW/VBW)</i>	<i>Test Eng.</i>
INTEL-090601-03d	Cond BE, Ch. 11, PK (1MHz/1MHz)	JC
<p>*ATTEN 10dB ΔMKR 42.17dB RL 12.0dBm 10dB/ -18.5MHz</p> <p>CENTER 2.4835GHz SPAN 100.0MHz *RBW 1.0MHz *VBW 1.0MHz SWP 50.0ms</p>		

Band-Edge Plots (Continued)

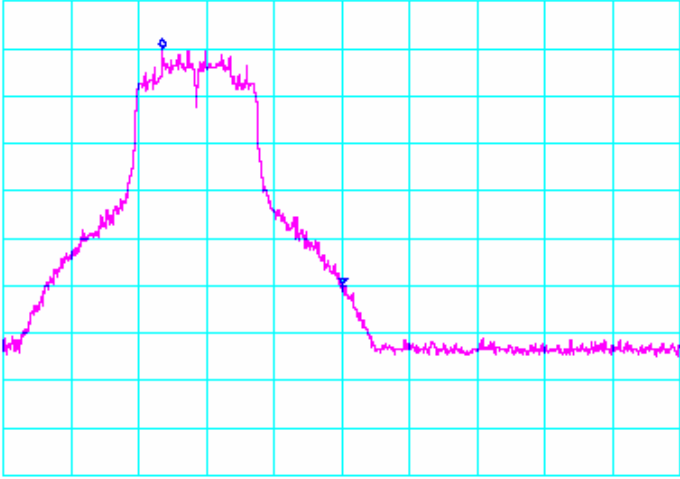
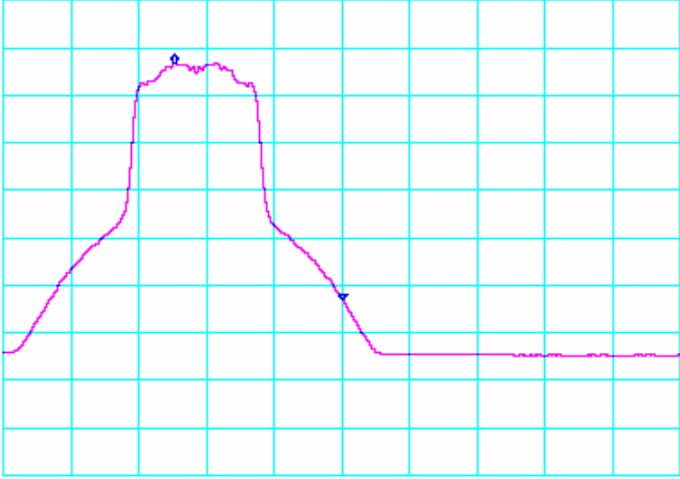
Plot File Name	Description (RBW/VBW)	Test Eng.
INTEL-090601-03e	Cond BE, Ch. 11, PK (100kHz/100kHz)	JC
<p data-bbox="334 401 951 451">*ATTEN 10dB ΔMKR 49.67dB RL 12.0dBm 10dB/ -26.7MHz</p>  <p data-bbox="334 934 1019 989">CENTER 2.4835GHz SPAN 100.0MHz *RBW 100kHz *VBW 100kHz SWP 55.0ms</p>		
Plot File Name	Description (RBW/VBW)	Test Eng.
INTEL-090601-03f	Cond BE, Ch. 11, AV (1MHz/10Hz)	JC
<p data-bbox="334 1121 951 1171">*ATTEN 10dB ΔMKR 49.84dB RL 12.0dBm 10dB/ -24.8MHz</p>  <p data-bbox="334 1654 1019 1709">CENTER 2.4835GHz SPAN 100.0MHz *RBW 1.0MHz *VBW 10Hz SWP 37.0sec</p>		



Radiated Emissions Test Results (Continued)

*Fundamental Measurements in 802.11n mode 20MHz Wide (2400-2483.5 MHz)
Channels 1, 6, & 11
Continuous TX at Chain B Antenna port with Shanghai Universe Antennas
Aegis Labs, Inc. File #: INTEL-090601-04*

RADIATED EMISSIONS - Horizontal Antenna Polarization											
Freq. (MHz)	Meter Reading (dBuV)	Antenna Height (cm)	Azimuth (degrees)	Quasi pk or AVG (dBuV)		Cable Factor (dB)	Ant. Factor (dB)	Corrected Reading (dBuV)	Limits (dBuV)	Diff (dB) +=FAIL	Comments
2412.00	70.26	100	315			2.53	32.18	104.96			Ch. 1
2412.00				64.11	A	2.53	32.18	98.81			
2437.00	72.54	100	315			2.54	32.21	107.29			Ch. 6
2437.00				66.20	A	2.54	32.21	100.95			
2462.00	69.81	100	315			2.55	32.25	104.61			Ch. 11
2462.00				63.45	A	2.55	32.25	98.25			

RADIATED EMISSIONS - Vertical Antenna Polarization											
Freq. (MHz)	Meter Reading (dBuV)	Antenna Height (cm)	Azimuth (degrees)	Quasi pk or AVG (dBuV)		Cable Factor (dB)	Ant. Factor (dB)	Corrected Reading (dBuV)	Limits (dBuV)	Diff (dB) +=FAIL	Comments
2412.00	69.63	100	180			2.53	31.89	104.05			Ch. 1
2412.00				60.77	A	2.53	31.89	95.19			
2437.00	70.42	100	180			2.54	31.92	104.88			Ch. 6
2437.00				61.06	A	2.54	31.92	95.52			
2462.00	69.59	100	180			2.55	31.95	104.10			Ch. 11
2462.00				60.45	A	2.55	31.95	94.96			

NOTE: Fundamental signals measured to calculate the band edge field strengths using the “Marker Delta Method”.



Radiated Emissions Test Results (Continued)

*Band Edge Field Strength Measurements in 802.11n mode 20MHz Wide (2400-2483.5 MHz)
Channels 1 & 11
Continuous TX at Chain B Antenna port with Shanghai Universe Antennas
Aegis Labs, Inc. File #: INTEL-090601-04*

RADIATED EMISSIONS - Horizontal Antenna Polarization										
Freq. (MHz)	Meter Reading (dBuV)	Antenna Height (cm)	Azimuth (degrees)	Quasi pk or AVG (dBuV)	Cable Factor (dB)	Ant. Factor (dB)	Corrected Reading (dBuV)	Limits (dBuV)	Diff (dB) +=FAIL	Comments
2390.00							66.96	74.00	-7.04	Ch. 1
2390.00							56.80	74.00	-17.20	
2390.00					A		50.14	54.00	-3.86	
2390.00					A		50.65	54.00	-3.35	
2400.00	43.61	100	315		2.52	32.16	78.29	84.96	-6.67	
2483.50							62.78	74.00	-11.22	Ch. 11
2483.50							56.45	74.00	-17.55	
2483.50					A		49.09	54.00	-4.91	
2483.50					A		50.09	54.00	-3.91	

RADIATED EMISSIONS - Vertical Antenna Polarization										
Freq. (MHz)	Meter Reading (dBuV)	Antenna Height (cm)	Azimuth (degrees)	Quasi pk or AVG (dBuV)	Cable Factor (dB)	Ant. Factor (dB)	Corrected Reading (dBuV)	Limits (dBuV)	Diff (dB) +=FAIL	Comments
2390.00							66.05	74.00	-7.95	Ch. 1
2390.00							55.89	74.00	-18.11	
2390.00					A		46.52	54.00	-7.48	
2390.00					A		47.03	54.00	-6.97	
2400.00	41.33	100	180		2.52	31.88	75.73	84.05	-8.32	
2483.50							62.27	74.00	-11.73	Ch. 11
2483.50							55.94	74.00	-18.06	
2483.50					A		45.80	54.00	-8.20	
2483.50					A		46.80	54.00	-7.20	

NOTE: The “Band Edge Field Strength” was calculated using the “Fundamental” and “Conducted Band Edge” measurements per the “Marker-Delta Method” with the following formula:

$$BE = Fm - \Delta m$$

Where

BE = Band Edge Field Strength

Fm = Measured Fundamental (Peak or Average)

Δm = Measured Conducted Band Edge Delta (Peak or Average)

Band-Edge Plots (Continued)

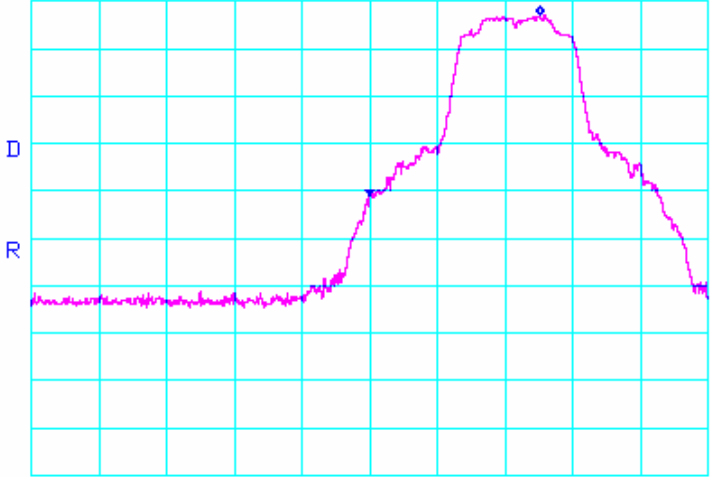
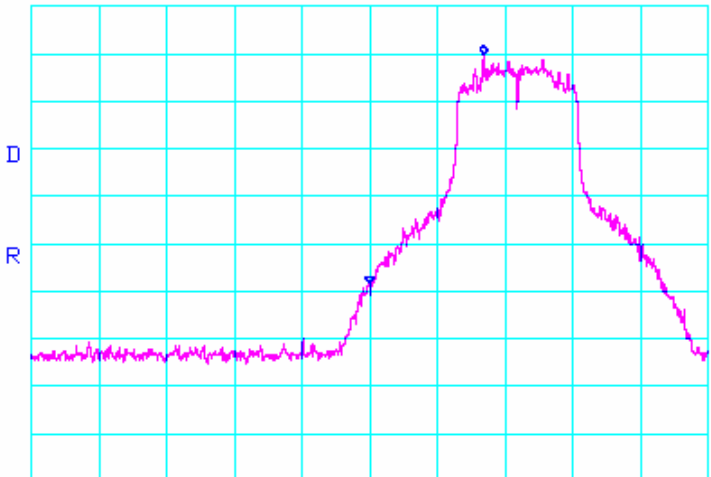
<i>Plot File Name</i>	<i>Description (RBW/VBW)</i>	<i>Test Eng.</i>
INTEL-090526-10a	Cond BE, Ch. 1, PK (1MHz/1MHz)	JC
<p>*ATTEN 10dB ΔMKR 38.00dB RL 12.0dBm 10dB/ 25.2MHz</p>  <p>CENTER 2.3900GHz SPAN 100.0MHz *RBW 1.0MHz *VBW 1.0MHz SWP 50.0ms</p>		
<i>Plot File Name</i>	<i>Description (RBW/VBW)</i>	<i>Test Eng.</i>
INTEL-090526-10b	Cond BE, Ch. 1, PK (100kHz/100kHz)	JC
<p>*ATTEN 10dB ΔMKR 48.16dB RL 12.0dBm 10dB/ 16.8MHz</p>  <p>CENTER 2.3900GHz SPAN 100.0MHz *RBW 100kHz *VBW 100kHz SWP 55.0ms</p>		

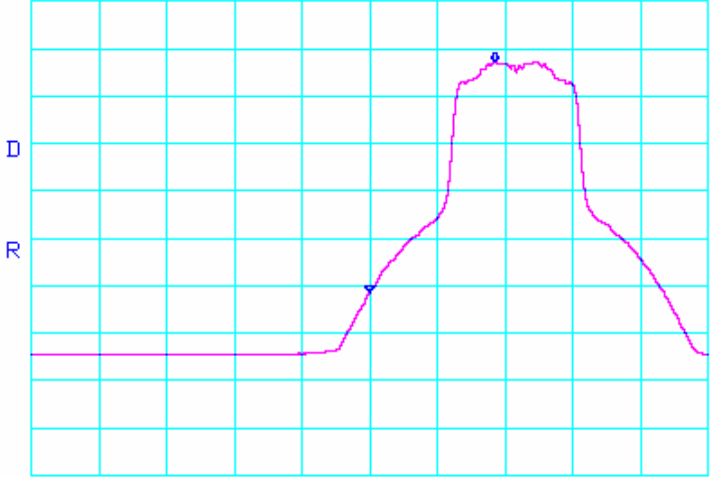
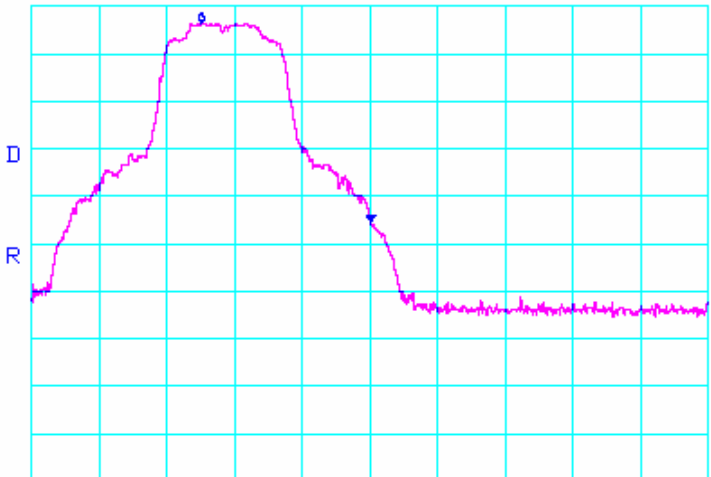

Band-Edge Plots (Continued)

<i>Plot File Name</i>	<i>Description (RBW/VBW)</i>	<i>Test Eng.</i>
INTEL-090526-10c	Cond BE, Ch. 1, AV (1MHz/10Hz)	JC
<p>*ATTEN 10dB RL 12.0dBm 10dB/ ΔMKR 48.67dB 18.5MHz</p>  <p>CENTER 2.3900GHz SPAN 100.0MHz *RBW 1.0MHz *VBW 10Hz SWP 37.0sec</p>		
<i>Plot File Name</i>	<i>Description (RBW/VBW)</i>	<i>Test Eng.</i>
INTEL-090526-10d	Cond BE, Ch. 11, PK (1MHz/1MHz)	JC
<p>*ATTEN 10dB RL 12.0dBm 10dB/ ΔMKR 41.83dB -25.0MHz</p>  <p>CENTER 2.4835GHz SPAN 100.0MHz *RBW 1.0MHz *VBW 1.0MHz SWP 50.0ms</p>		

Band-Edge Plots (Continued)

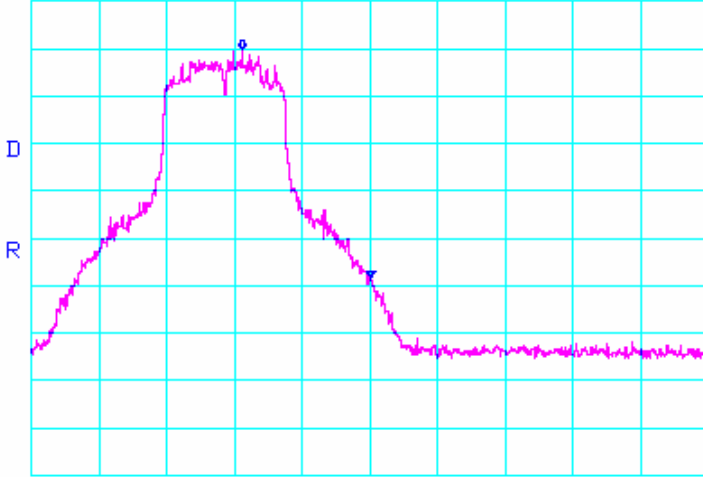
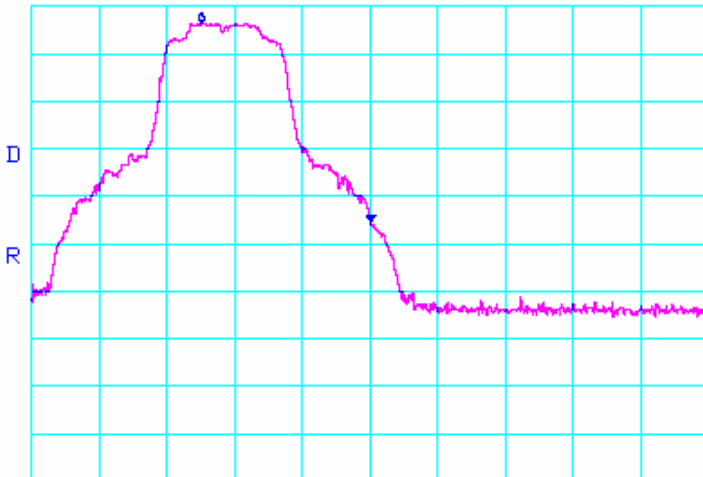
<i>Plot File Name</i>	<i>Description (RBW/VBW)</i>	<i>Test Eng.</i>
INTEL-090526-10e	Cond BE, Ch. 11, PK (100kHz/100kHz)	JC
<p>*ATTEN 10dB ΔMKR 48.16dB RL 12.0dBm 10dB/ -19.0MHz</p>  <p>CENTER 2.4835GHz SPAN 100.0MHz *RBW 100kHz *VBW 100kHz SWP 55.0ms</p>		
<i>Plot File Name</i>	<i>Description (RBW/VBW)</i>	<i>Test Eng.</i>
INTEL-090526-10f	Cond BE, Ch. 11, AV (1MHz/10Hz)	JC
<p>*ATTEN 10dB ΔMKR 41.83dB RL 12.0dBm 10dB/ -25.0MHz</p>  <p>CENTER 2.4835GHz SPAN 100.0MHz *RBW 1.0MHz *VBW 1.0MHz SWP 50.0ms</p>		



Radiated Emissions Test Results (Continued)

*Spurious Emissions Measurements in 802.11n mode 20MHz Wide (2400-2483.5 MHz)
Channels 1, 6, & 11
Continuous TX at Chain A & B Antenna ports with Shanghai Universe Antennas
Aegis Labs, Inc. File #: INTEL-090601-07*

RADIATED EMISSIONS - Horizontal Antenna Polarization												
Freq. (MHz)	Meter Reading (dBuV)	Antenna Height (cm)	Azimuth (degrees)	Quasi pk or AVG (dBuV)		Preamp Factor (dB)	Cable Factor (dB)	Ant. Factor (dB)	Corrected Reading (dBuV)	Limits (dBuV)	Diff (dB) +=FAIL	Channel/Chain Tested
3249.32	52.50	100	0			47.61	2.94	32.75	40.58	74.00	-33.42	Ch. 6/A
3249.32	53.17	100	0			47.61	2.94	32.75	41.25	74.00	-32.75	Ch. 6/B
3216.00	51.50	100	0			47.60	2.91	32.74	39.56	74.00	-34.44	Ch. 1/
4873.98	51.83	100	0			47.50	3.64	34.13	42.09	74.00	-31.91	B
4873.98		100	0	40.23	A	47.50	3.64	34.13	30.49	54.00	-23.51	
3282.66	52.50	100				47.62	2.97	32.76	40.60	74.00	-33.40	Ch. 11/
4923.99	51.17	100	315			47.49	3.67	34.12	41.47	74.00	-32.53	B
4923.99		100	315	39.82	A	47.49	3.67	34.12	30.12	54.00	-23.88	

RADIATED EMISSIONS - Vertical Antenna Polarization												
Freq. (MHz)	Meter Reading (dBuV)	Antenna Height (cm)	Azimuth (degrees)	Quasi pk or AVG (dBuV)		Preamp Factor (dB)	Cable Factor (dB)	Ant. Factor (dB)	Corrected Reading (dBuV)	Limits (dBuV)	Diff (dB) +=FAIL	Channel/Chain Tested
3249.32	53.67	100	0			47.61	2.94	32.55	41.55	74.00	-32.45	Ch. 6/
4873.98	54.00	100	0			47.50	3.64	34.30	44.44	74.00	-29.56	A
4873.98		100	0	41.44	A	47.50	3.64	34.30	31.88	54.00	-22.12	
6498.64	51.17	100	90			46.93	4.22	35.50	43.96	74.00	-30.04	
3249.32	53.83	100	0			47.61	2.94	32.55	41.71	74.00	-32.29	Ch. 6/
6498.64	51.67	100	90			46.93	4.22	35.50	44.46	74.00	-29.54	B
3216.00	52.67	100	0			47.60	2.91	32.54	40.53	74.00	-33.47	Ch. 1/A
3282.66	54.00	100	45			47.62	2.97	32.56	41.90	74.00	-32.10	Ch. 11/
4923.99	52.50	100	0			47.49	3.67	34.30	42.99	74.00	-31.01	A
4923.99		100	0	40.81	A	47.49	3.67	34.30	31.30	54.00	-22.70	



Radiated Emissions Test Results (Continued)

*Spurious Emissions Measurements in 802.11n mode 20MHz Wide (2400-2483.5 MHz)
Channels 1, 6, & 11
Continuous TX at Dual Chain AB Antenna ports with Shanghai Universe Antennas
Aegis Labs, Inc. File #: INTEL-090601-07*

RADIATED EMISSIONS - Horizontal Antenna Polarization												
Freq. (MHz)	Meter Reading (dBuV)	Antenna Height (cm)	Azimuth (degrees)	Quasi pk or AVG (dBuV)		Preamp Factor (dB)	Cable Factor (dB)	Ant. Factor (dB)	Corrected Reading (dBuV)	Limits (dBuV)	Diff (dB) +=FAIL	Channel/Chain Tested
3216.00	52.67	100	315			47.60	2.91	32.74	40.73	74.00	-33.27	Ch. 1
6432.00	55.67	100	45			46.99	4.20	35.63	48.52	74.00	-25.48	
3249.33	51.67	100	315			47.61	2.94	32.75	39.75	74.00	-34.25	Ch. 6
6498.66	55.67	100	45			46.93	4.22	35.70	48.66	74.00	-25.34	
3282.66	53.50	100	315			47.62	2.97	32.76	41.60	74.00	-32.40	Ch. 11
4924.00	52.17	100	315			47.49	3.67	34.12	42.47	74.00	-31.53	
4924.00		100	315	43.58	A	47.49	3.67	34.12	33.88	54.00	-20.12	
6565.33	56.00	100	270			46.83	4.25	35.71	49.13	74.00	-24.87	

RADIATED EMISSIONS - Vertical Antenna Polarization												
Freq. (MHz)	Meter Reading (dBuV)	Antenna Height (cm)	Azimuth (degrees)	Quasi pk or AVG (dBuV)		Preamp Factor (dB)	Cable Factor (dB)	Ant. Factor (dB)	Corrected Reading (dBuV)	Limits (dBuV)	Diff (dB) +=FAIL	Channel/Chain Tested
3216.00	52.17	100	0			47.60	2.91	32.54	40.03	74.00	-33.97	Ch. 1
6432.00	57.83	100	45			46.99	4.20	35.47	50.52	74.00	-23.48	
3249.32	53.00	100	0			47.61	2.94	32.55	40.88	74.00	-33.12	Ch. 6
4873.98	52.17	100	90			47.50	3.64	34.30	42.61	74.00	-31.39	
4873.98		100	90	40.62	A	47.50	3.64	34.30	31.06	54.00	-22.94	
6498.85	58.67	100	90			46.93	4.22	35.50	51.46	74.00	-22.54	
9747.89	52.17	100	0			45.52	5.31	36.75	48.71	74.00	-25.29	
3282.66	53.00	100	45			47.62	2.97	32.56	40.90	74.00	-33.10	Ch. 11
4924.00	52.33	100	90			47.49	3.67	34.30	42.82	74.00	-31.18	
4924.00		100	90	40.13	A	47.49	3.67	34.30	30.62	54.00	-23.38	
6565.33	59.83	100	90			46.83	4.25	35.51	52.76	74.00	-21.24	



RADIATED EMISSIONS TEST RESULTS

CLIENT:	Intel Corporation	DATE:	08/17/09
EUT:	Intel® Centrino® Ultimate-N 6200	PROJECT NUMBER:	INTEL-090601
MODEL NUMBER:	622ANHMW	TEST ENGINEER:	JC
SERIAL NUMBER:	0015005A3C7C	SITE #:	2
CONFIGURATION:	Tested installed in an extender board connected to the host laptop's mini PCI slot in 802.11n (2400-2483.5 MHz) mode 40MHz Wide.	TEMPERATURE:	24° C
		HUMIDITY:	46% RH
		TIME:	9:30 AM

Description:	Radiated RF Emissions (1 GHz – 18 GHz)
Results:	PASSED Horizontal and Vertical Antenna Polarizations Class B Limits
Note:	Radiated Emissions Measurements were performed on the EUT with power supply set at the following voltage and frequency. <ul style="list-style-type: none"> • 120VAC / 60 Hz.

Unwanted Spurious Emissions Limits			
Frequency (MHz)	Field Strength (uV/m)	Field Strength (dBuV/m) (Emissions in the restricted bands)	Field Strength (dBm/MHz) (Emissions outside the restricted bands)
Above 960	500	54.00 (Average) 74.00 (Peak)	< -20 dBc

Radiated Emissions Sample Calculations

$$\text{Corrected Meter Reading} = \text{Meter Reading} + F + C - D$$

Where, F = Antenna Factor

C = Cable Factor

G = Amplifier Gain

D = Distance Factor (if applicable)

Therefore, the equation for determining the Corrected Meter Reading Limit (CML) is:

$$\text{CML} = \text{Specification Limit} - F - C + D$$



Radiated Emissions Test Results (Continued)

*Fundamental Measurements in 802.11n mode 40MHz Wide (2400-2483.5 MHz)
 Channels 3, 4, 6, 8, & 9
 Continuous TX at Chain A Antenna port with Shanghai Universe Antennas
 Aegis Labs, Inc. File #: INTEL-090601-02*

RADIATED EMISSIONS - Horizontal Antenna Polarization											
<i>Freq. (MHz)</i>	<i>Meter Reading (dBuV)</i>	<i>Antenna Height (cm)</i>	<i>Azimuth (degrees)</i>	<i>Quasi pk or AVG (dBuV)</i>		<i>Cable Factor (dB)</i>	<i>Ant. Factor (dB)</i>	<i>Corrected Reading (dBuV)</i>	<i>Limits (dBuV)</i>	<i>Diff (dB) +=FAIL</i>	<i>Comments</i>
2422.00	63.35	100	225			2.53	32.19	98.07			Ch. 3
2422.00				53.41	A	2.53	32.19	88.13			
2427.00	65.34	100	225			2.53	32.20	100.07			Ch. 4
2427.00				54.62	A	2.53	32.20	89.35			
2437.00	66.85	100	225			2.54	32.21	101.60			Ch. 6
2437.00				56.93	A	2.54	32.21	91.68			
2447.00	64.46	100	225			2.54	32.23	99.23			Ch. 8
2447.00				55.84	A	2.54	32.23	90.61			
2452.00	62.75	100	225			2.55	32.23	97.53			Ch. 9
2452.00				52.65	A	2.55	32.23	87.43			

RADIATED EMISSIONS - Vertical Antenna Polarization											
<i>Freq. (MHz)</i>	<i>Meter Reading (dBuV)</i>	<i>Antenna Height (cm)</i>	<i>Azimuth (degrees)</i>	<i>Quasi pk or AVG (dBuV)</i>		<i>Cable Factor (dB)</i>	<i>Ant. Factor (dB)</i>	<i>Corrected Reading (dBuV)</i>	<i>Limits (dBuV)</i>	<i>Diff (dB) +=FAIL</i>	<i>Comments</i>
2422.00	62.89	100	0			2.53	31.91	97.33			Ch. 3
2422.00				52.87	A	2.53	31.91	87.31			
2427.00	64.25	100	0			2.53	31.91	98.70			Ch. 4
2427.00				54.56	A	2.53	31.91	89.01			
2437.00	67.00	100	0			2.54	31.92	101.46			Ch. 6
2437.00				57.81	A	2.54	31.92	92.27			
2447.00	65.03	100	0			2.54	31.94	99.51			Ch. 8
2447.00				54.92	A	2.54	31.94	89.40			
2452.00	62.11	100	0			2.55	31.94	96.60			Ch. 9
2452.00				52.26	A	2.55	31.94	86.75			

NOTE: Fundamental signals measured to calculate the band edge field strengths using the “Marker Delta Method”.



Radiated Emissions Test Results (Continued)

*Band Edge Field Strength Measurements in 802.11n mode 40MHz Wide (2400-2483.5 MHz)
Channels 3, 4, 8, & 9
Continuous TX at Chain A Antenna port with Shanghai Universe Antennas
Aegis Labs, Inc. File #: INTEL-090601-02*

RADIATED EMISSIONS - Horizontal Antenna Polarization										
<i>Freq. (MHz)</i>	<i>Meter Reading (dBuV)</i>	<i>Antenna Height (cm)</i>	<i>Azimuth (degrees)</i>	<i>Quasi pk or AVG (dBuV)</i>	<i>Cable Factor (dB)</i>	<i>Ant. Factor (dB)</i>	<i>Corrected Reading (dBuV)</i>	<i>Limits (dBuV)</i>	<i>Diff (dB) +=FAIL</i>	<i>Comments</i>
2390.00							65.24	74.00	-8.76	Ch. 3
2390.00							60.57	74.00	-13.43	
2390.00				A			48.46	54.00	-5.54	
2390.00				A			50.63	54.00	-3.37	
2400.00	32.96	100	225		2.52	32.16	67.64	78.07	-10.43	
2390.00							66.07	74.00	-7.93	Ch. 4
2390.00							61.57	74.00	-12.43	
2390.00				A			49.68	54.00	-4.32	
2390.00				A			50.85	54.00	-3.15	
2400.00	35.52	100	225		2.52	32.16	70.20	80.07	-9.87	
2483.50							63.23	74.00	-10.77	Ch. 8
2483.50							58.56	74.00	-15.44	
2483.50				A			49.44	54.00	-4.56	
2483.50				A			49.94	54.00	-4.06	
2483.50							61.86	74.00	-12.14	Ch. 9
2483.50							61.03	74.00	-12.97	
2483.50				A			47.43	54.00	-6.57	
2483.50				A			50.93	54.00	-3.07	



Radiated Emissions Test Results (Continued)

RADIATED EMISSIONS - Vertical Antenna Polarization										
Freq. (MHz)	Meter Reading (dBuV)	Antenna Height (cm)	Azimuth (degrees)	Quasi pk or AVG (dBuV)	Cable Factor (dB)	Ant. Factor (dB)	Corrected Reading (dBuV)	Limits (dBuV)	Diff (dB) +=FAIL	Comments
2390.00							64.50	74.00	-9.50	Ch. 3
2390.00							59.83	74.00	-14.17	
2390.00				A			47.64	54.00	-6.36	
2390.00				A			49.81	54.00	-4.19	
2400.00	33.67	100	0		2.52	31.88	68.07	77.33	-9.26	
2390.00							64.70	74.00	-9.30	Ch. 4
2390.00							60.20	74.00	-13.80	
2390.00				A			49.34	54.00	-4.66	
2390.00				A			50.51	54.00	-3.49	
2400.00	31.00	100	0		2.52	31.88	65.40	72.27	-6.87	
2483.50							63.51	74.00	-10.49	Ch. 8
2483.50							58.84	74.00	-15.16	
2483.50				A			48.23	54.00	-5.77	
2483.50				A			48.73	54.00	-5.27	
2483.50							60.93	74.00	-13.07	Ch. 9
2483.50							60.10	74.00	-13.90	
2483.50				A			46.75	54.00	-7.25	
2483.50				A			50.25	54.00	-3.75	

NOTE: The “Band Edge Field Strength” was calculated using the “Fundamental” and “Conducted Band Edge” measurements per the “Marker-Delta Method” with the following formula:

$$BE = Fm - \Delta m$$

Where

BE = Band Edge Field Strength

Fm = Measured Fundamental (Peak or Average)

Δm = Measured Conducted Band Edge Delta (Peak or Average)



Band-Edge Plots (Continued)

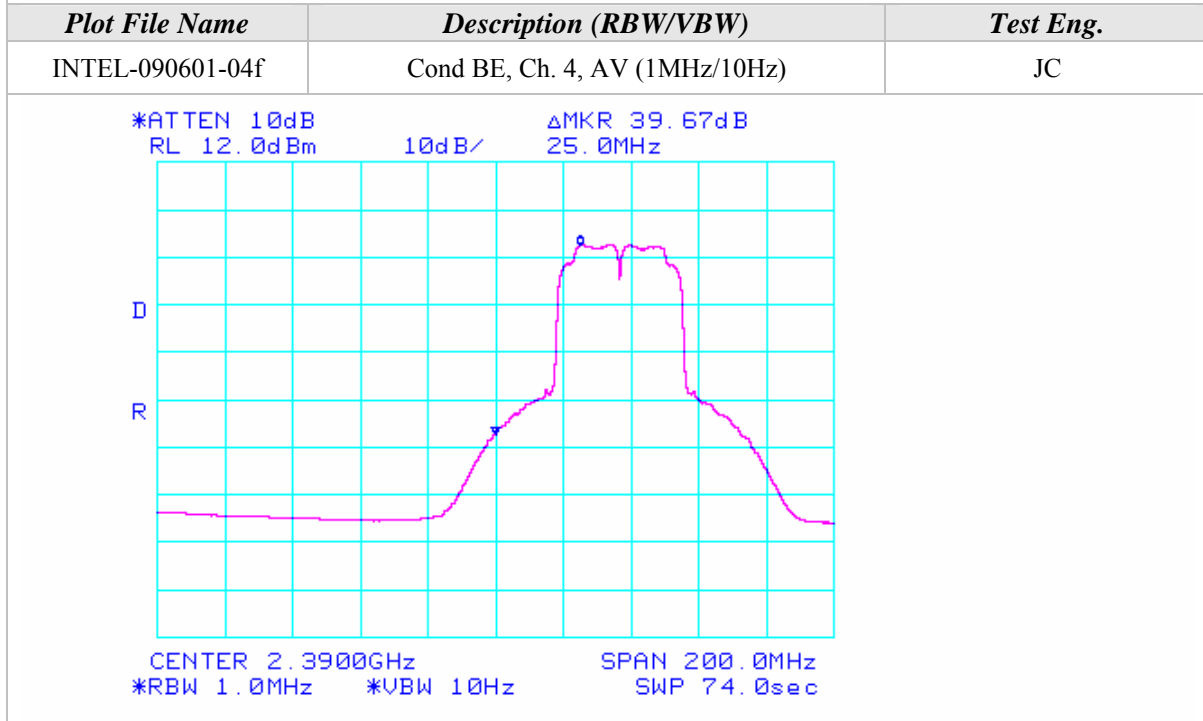
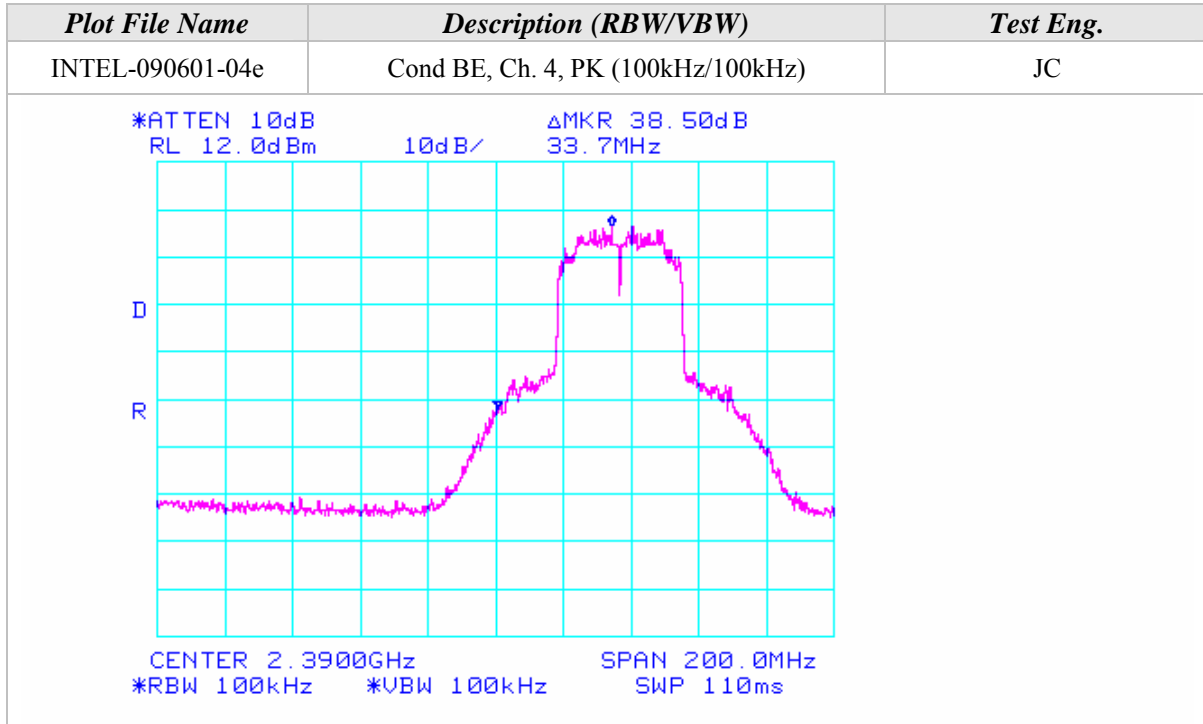

Band-Edge Plots (Continued)

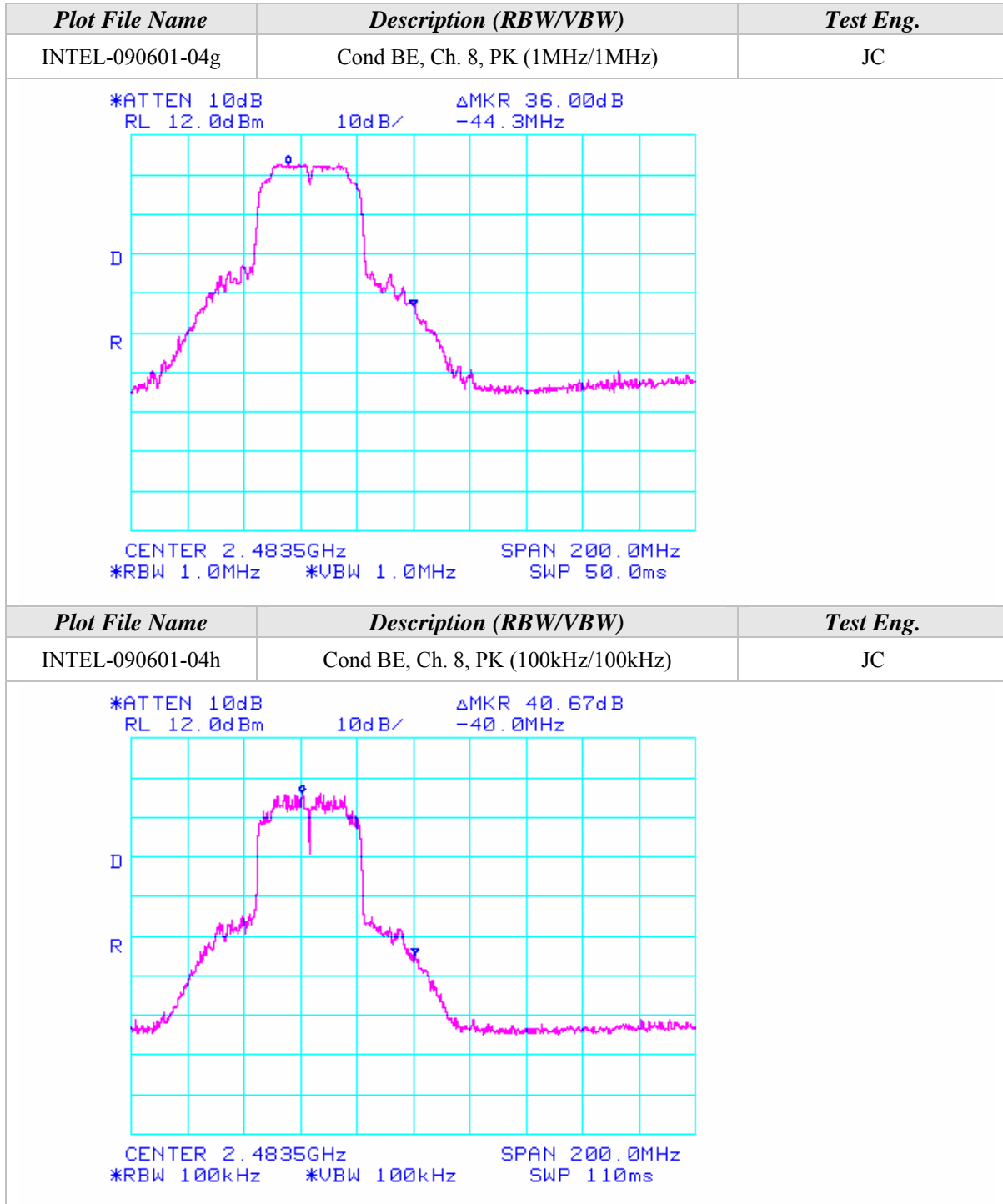

Band-Edge Plots (Continued)

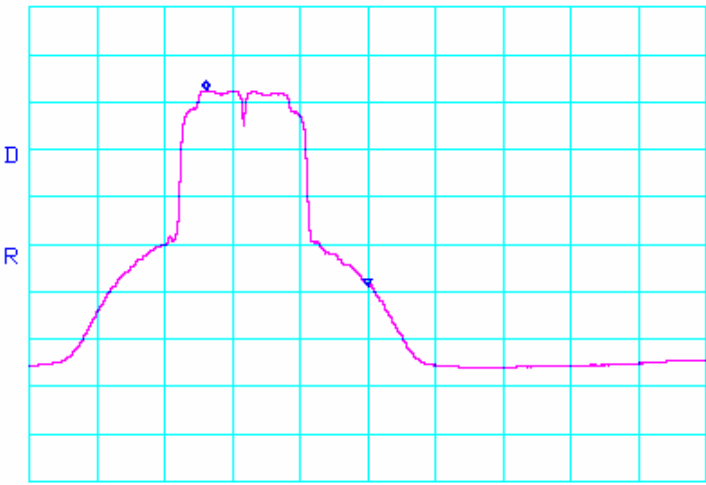
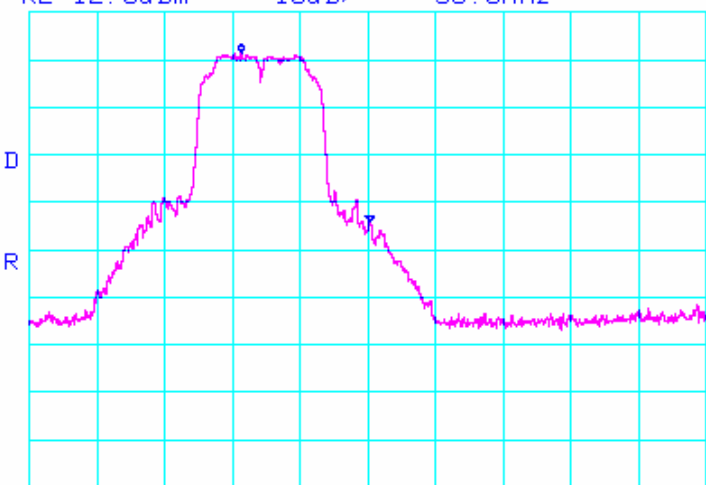
<i>Plot File Name</i>	<i>Description (RBW/VBW)</i>	<i>Test Eng.</i>
INTEL-090601-04i	Cond BE, Ch. 8, AV (1MHz/10Hz)	JC
<div style="display: flex; justify-content: space-between;"> <div data-bbox="334 394 524 445"> <p>*ATTEN 10dB RL 12.0dBm</p> </div> <div data-bbox="602 415 699 445"> <p>10dB/</p> </div> <div data-bbox="742 394 953 445"> <p>ΔMKR 41.17dB -47.7MHz</p> </div> </div>  <div style="display: flex; justify-content: space-between; margin-top: 10px;"> <div data-bbox="334 930 721 982"> <p>CENTER 2.4835GHz *RBW 1.0MHz *VBW 10Hz</p> </div> <div data-bbox="802 930 1019 982"> <p>SPAN 200.0MHz SWP 74.0sec</p> </div> </div>		
<i>Plot File Name</i>	<i>Description (RBW/VBW)</i>	<i>Test Eng.</i>
INTEL-090601-04j	Cond BE, Ch. 9, PK (1MHz/1MHz)	JC
<div style="display: flex; justify-content: space-between;"> <div data-bbox="334 1108 524 1159"> <p>*ATTEN 10dB RL 12.0dBm</p> </div> <div data-bbox="602 1129 699 1159"> <p>10dB/</p> </div> <div data-bbox="742 1108 953 1159"> <p>ΔMKR 35.67dB -38.0MHz</p> </div> </div>  <div style="display: flex; justify-content: space-between; margin-top: 10px;"> <div data-bbox="334 1644 753 1696"> <p>CENTER 2.4835GHz *RBW 1.0MHz *VBW 1.0MHz</p> </div> <div data-bbox="802 1644 1019 1696"> <p>SPAN 200.0MHz SWP 50.0ms</p> </div> </div>		



Band-Edge Plots (Continued)

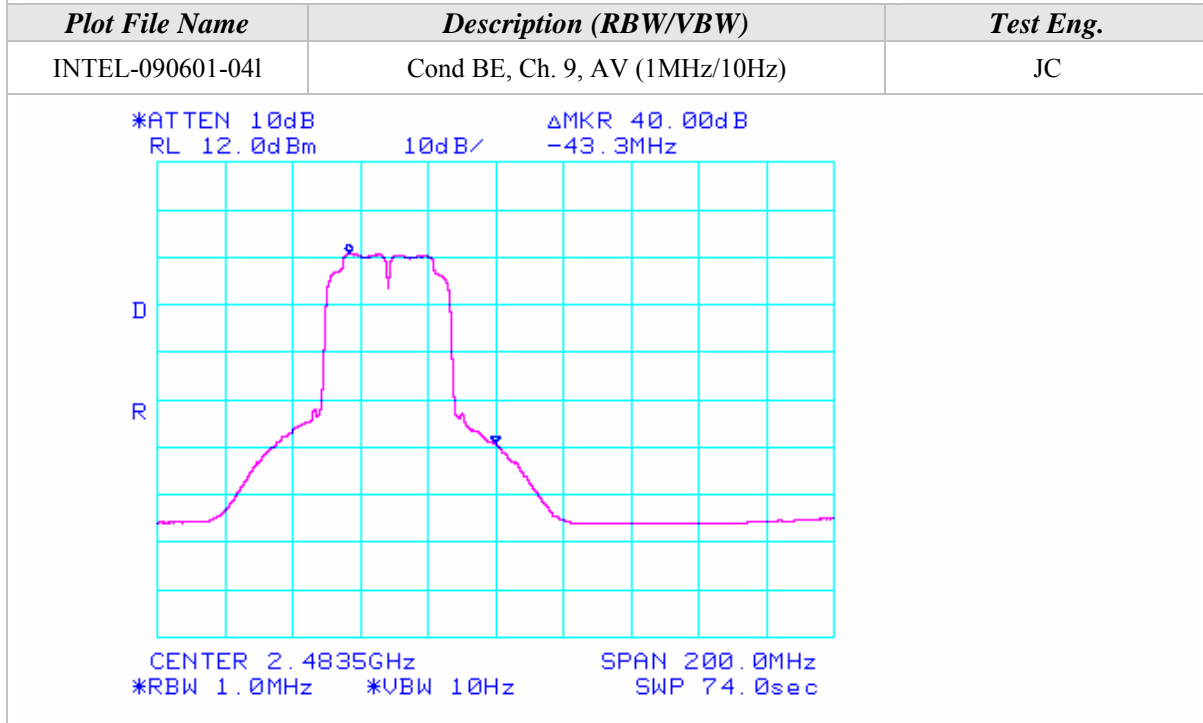
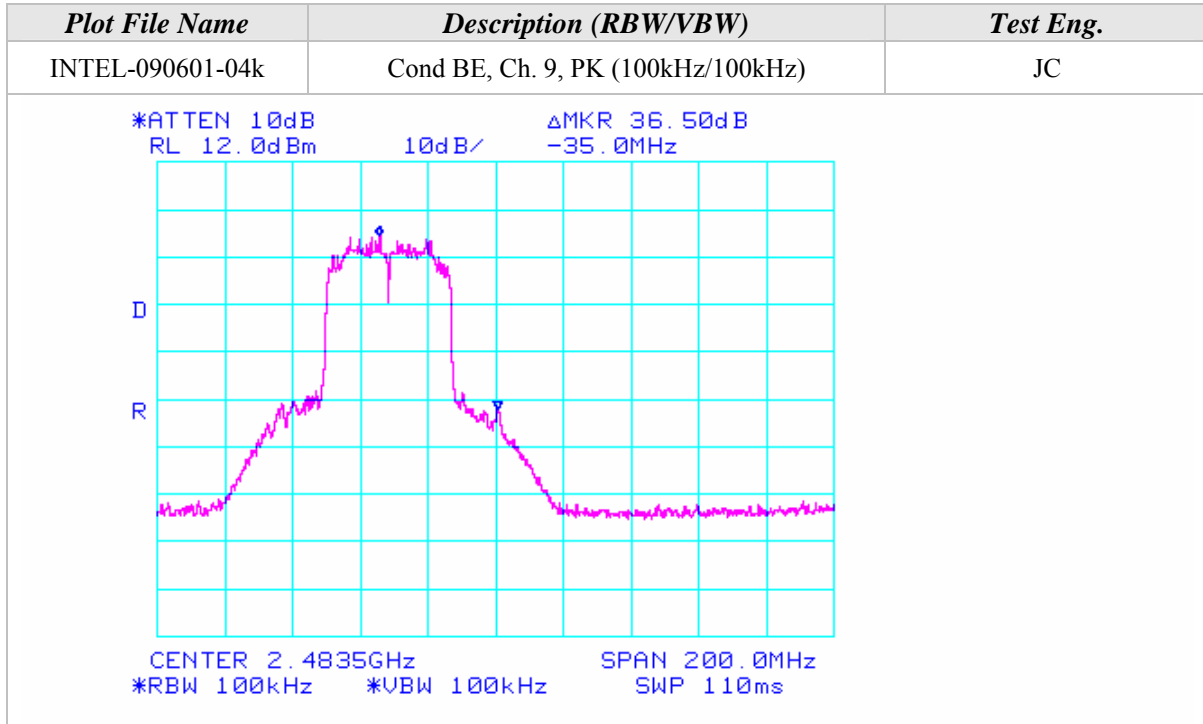



Radiated Emissions Test Results (Continued)

*Fundamental Measurements in 802.11n mode 40MHz Wide (2400-2483.5 MHz)
Channels 3, 4, 6, 8, & 9
Continuous TX at Chain B Antenna port with Shanghai Universe Antennas
Aegis Labs, Inc. File #: INTEL-090601-04*

RADIATED EMISSIONS - Horizontal Antenna Polarization											
<i>Freq. (MHz)</i>	<i>Meter Reading (dBuV)</i>	<i>Antenna Height (cm)</i>	<i>Azimuth (degrees)</i>	<i>Quasi pk or AVG (dBuV)</i>		<i>Cable Factor (dB)</i>	<i>Ant. Factor (dB)</i>	<i>Corrected Reading (dBuV)</i>	<i>Limits (dBuV)</i>	<i>Diff (dB) +=FAIL</i>	<i>Comments</i>
2422.00	62.76	100	315			2.53	32.19	97.48			Ch. 3
2422.00				52.19	A	2.53	32.19	86.91			
2427.00	64.53	100	315			2.53	32.20	99.26			Ch. 4
2427.00				55.37	A	2.53	32.20	90.10			
2437.00	67.34	100	315			2.54	32.21	102.09			Ch. 6
2437.00				56.83	A	2.54	32.21	91.58			
2447.00	64.91	100	315			2.54	32.23	99.68			Ch. 8
2447.00				56.74	A	2.54	32.23	91.51			
2452.00	63.23	100	315			2.55	32.23	98.01			Ch. 9
2452.00				54.69	A	2.55	32.23	89.47			

RADIATED EMISSIONS - Vertical Antenna Polarization											
<i>Freq. (MHz)</i>	<i>Meter Reading (dBuV)</i>	<i>Antenna Height (cm)</i>	<i>Azimuth (degrees)</i>	<i>Quasi pk or AVG (dBuV)</i>		<i>Cable Factor (dB)</i>	<i>Ant. Factor (dB)</i>	<i>Corrected Reading (dBuV)</i>	<i>Limits (dBuV)</i>	<i>Diff (dB) +=FAIL</i>	<i>Comments</i>
2422.00	61.76	100	180			2.53	31.91	96.20			Ch. 3
2422.00				51.46	A	2.53	31.91	85.90			
2427.00	63.95	100	180			2.53	31.91	98.40			Ch. 4
2427.00				53.76	A	2.53	31.91	88.21			
2437.00	67.08	100	180			2.54	31.92	101.54			Ch. 6
2437.00				56.81	A	2.54	31.92	91.27			
2447.00	64.87	100	180			2.54	31.94	99.35			Ch. 8
2447.00				54.69	A	2.54	31.94	89.17			
2452.00	62.36	100	180			2.55	31.94	96.85			Ch. 9
2452.00				52.42	A	2.55	31.94	86.91			

NOTE: Fundamental signals measured to calculate the band edge field strengths using the “Marker Delta Method”.



Radiated Emissions Test Results (Continued)

*Band Edge Field Strength Measurements in 802.11n mode 40MHz Wide (2400-2483.5 MHz)
Channels 3, 4, 8, & 9
Continuous TX at Chain B Antenna port with Shanghai Universe Antennas
Aegis Labs, Inc. File #: INTEL-090601-04*

RADIATED EMISSIONS - Horizontal Antenna Polarization										
<i>Freq. (MHz)</i>	<i>Meter Reading (dBuV)</i>	<i>Antenna Height (cm)</i>	<i>Azimuth (degrees)</i>	<i>Quasi pk or AVG (dBuV)</i>	<i>Cable Factor (dB)</i>	<i>Ant. Factor (dB)</i>	<i>Corrected Reading (dBuV)</i>	<i>Limits (dBuV)</i>	<i>Diff (dB) +=FAIL</i>	<i>Comments</i>
2390.00							64.65	74.00	-9.35	Ch. 3
2390.00							61.14	74.00	-12.86	
2390.00					A		47.75	54.00	-6.25	
2390.00					A		50.57	54.00	-3.43	
2400.00	31.96	100	315		2.52	32.16	66.64	77.48	-10.84	
2390.00							63.76	74.00	-10.24	Ch. 4
2390.00							59.93	74.00	-14.07	
2390.00					A		50.10	54.00	-3.90	
2390.00					A		50.77	54.00	-3.23	
2400.00	33.46	100	315		2.52	32.16	68.14	71.58	-3.44	
2483.50							63.34	74.00	-10.66	Ch. 8
2483.50							58.68	74.00	-15.32	
2483.50					A		49.84	54.00	-4.16	
2483.50					A		50.51	54.00	-3.49	
2483.50							62.85	74.00	-11.15	Ch. 9
2483.50							57.84	74.00	-16.16	
2483.50					A		49.64	54.00	-4.36	
2483.50					A		49.30	54.00	-4.70	



Radiated Emissions Test Results (Continued)

RADIATED EMISSIONS - Vertical Antenna Polarization										
Freq. (MHz)	Meter Reading (dBuV)	Antenna Height (cm)	Azimuth (degrees)	Quasi pk or AVG (dBuV)	Cable Factor (dB)	Ant. Factor (dB)	Corrected Reading (dBuV)	Limits (dBuV)	Diff (dB) +=FAIL	Comments
2390.00							63.37	74.00	-10.63	Ch. 3
2390.00							59.86	74.00	-14.14	
2390.00				A			46.74	54.00	-7.26	
2390.00				A			49.56	54.00	-4.44	
2400.00	34.83	100	180		2.52	31.88	69.23	76.20	-6.97	
2390.00							62.90	74.00	-11.10	Ch. 4
2390.00							59.07	74.00	-14.93	
2390.00				A			48.21	54.00	-5.79	
2390.00				A			48.88	54.00	-5.12	
2400.00	31.67	100	180		2.52	31.88	66.07	71.27	-5.20	
2483.50							63.01	74.00	-10.99	Ch. 8
2483.50							58.35	74.00	-15.65	
2483.50				A			47.50	54.00	-6.50	
2483.50				A			48.17	54.00	-5.83	
2483.50							61.69	74.00	-12.31	Ch. 9
2483.50							56.68	74.00	-17.32	
2483.50				A			47.08	54.00	-6.92	
2483.50				A			46.74	54.00	-7.26	

NOTE: The “Band Edge Field Strength” was calculated using the “Fundamental” and “Conducted Band Edge” measurements per the “Marker-Delta Method” with the following formula:

$$BE = Fm - \Delta m$$

Where

BE = Band Edge Field Strength

Fm = Measured Fundamental (Peak or Average)

Δm = Measured Conducted Band Edge Delta (Peak or Average)

Band-Edge Plots (Continued)

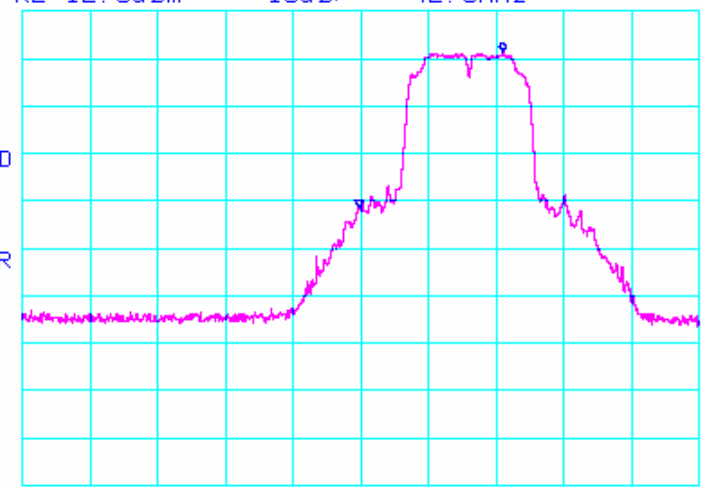
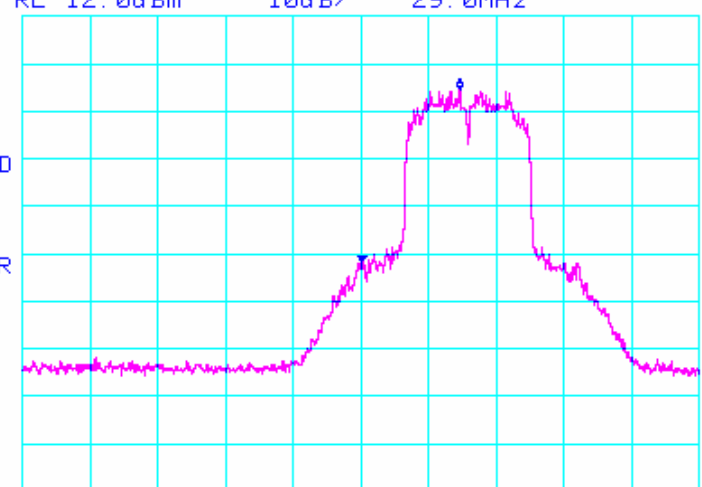
<i>Plot File Name</i>	<i>Description (RBW/VBW)</i>	<i>Test Eng.</i>
INTEL-090526-11a	Cond BE, Ch. 3, PK (1MHz/1MHz)	JC
<p>*ATTEN 10dB ΔMKR 32.83dB RL 12.0dBm 10dB/ 42.3MHz</p>  <p>CENTER 2.3900GHz SPAN 200.0MHz *RBW 1.0MHz *VBW 1.0MHz SWP 50.0ms</p>		
<i>Plot File Name</i>	<i>Description (RBW/VBW)</i>	<i>Test Eng.</i>
INTEL-090526-11b	Cond BE, Ch. 3, PK (100kHz/100kHz)	JC
<p>*ATTEN 10dB ΔMKR 36.34dB RL 12.0dBm 10dB/ 29.0MHz</p>  <p>CENTER 2.3900GHz SPAN 200.0MHz *RBW 100kHz *VBW 100kHz SWP 110ms</p>		

Band-Edge Plots (Continued)

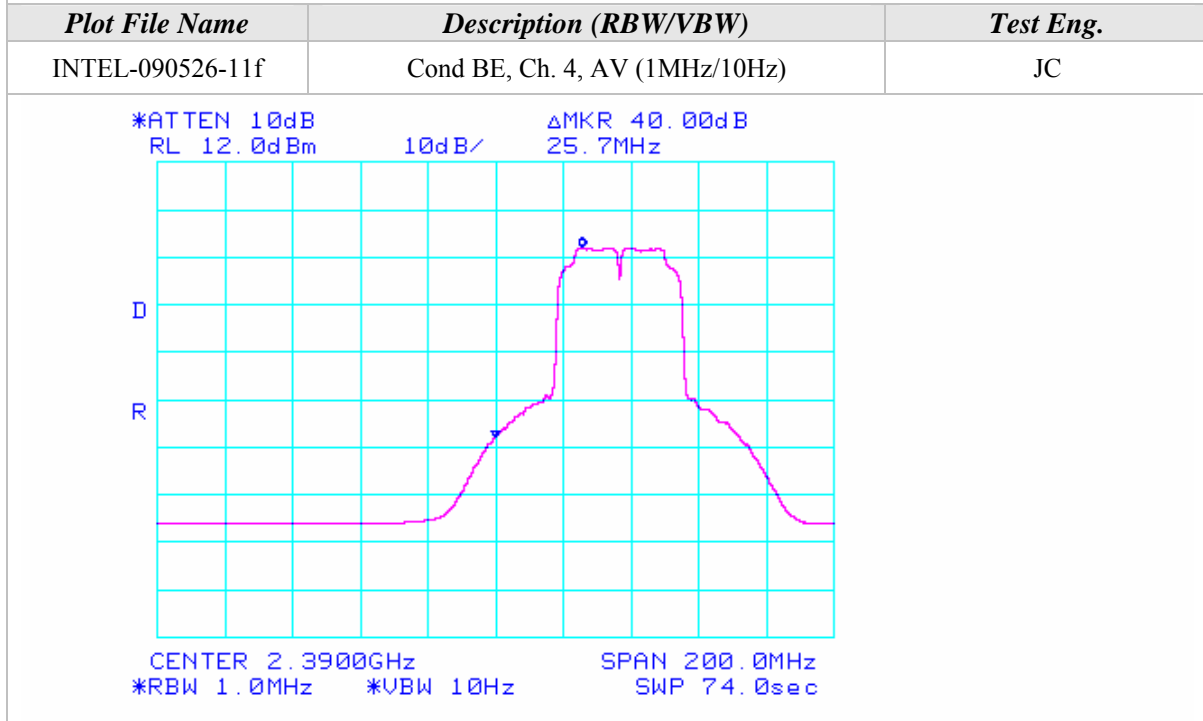
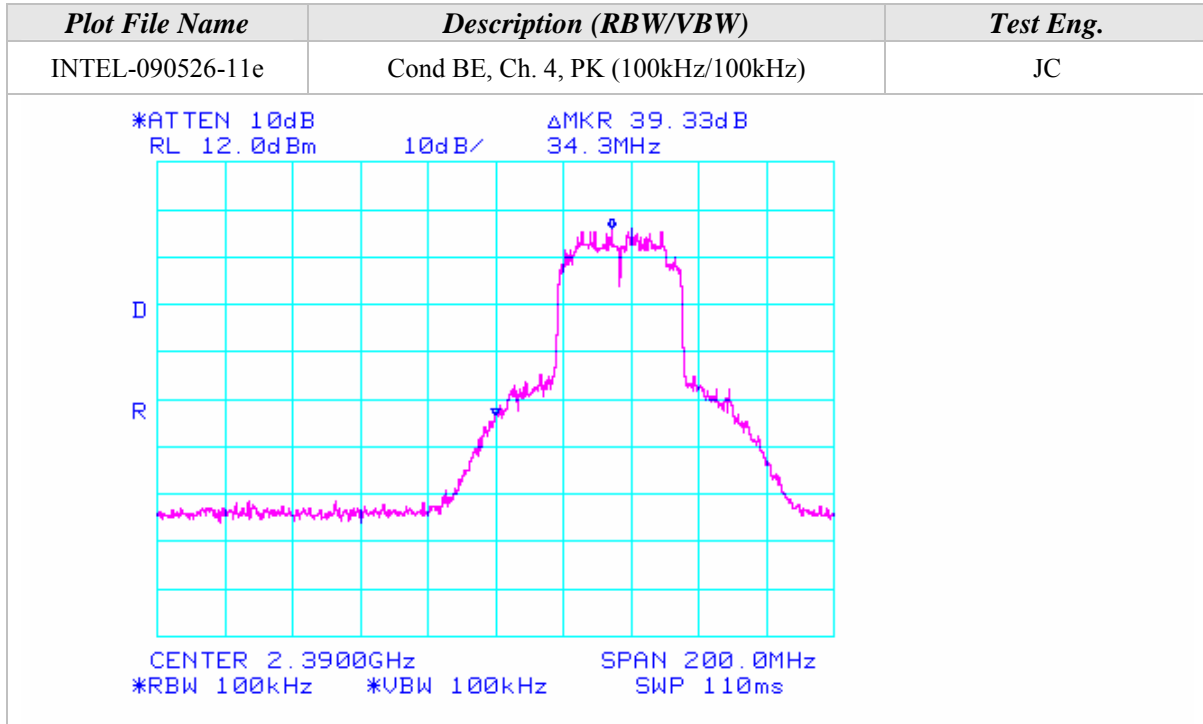



Band-Edge Plots (Continued)

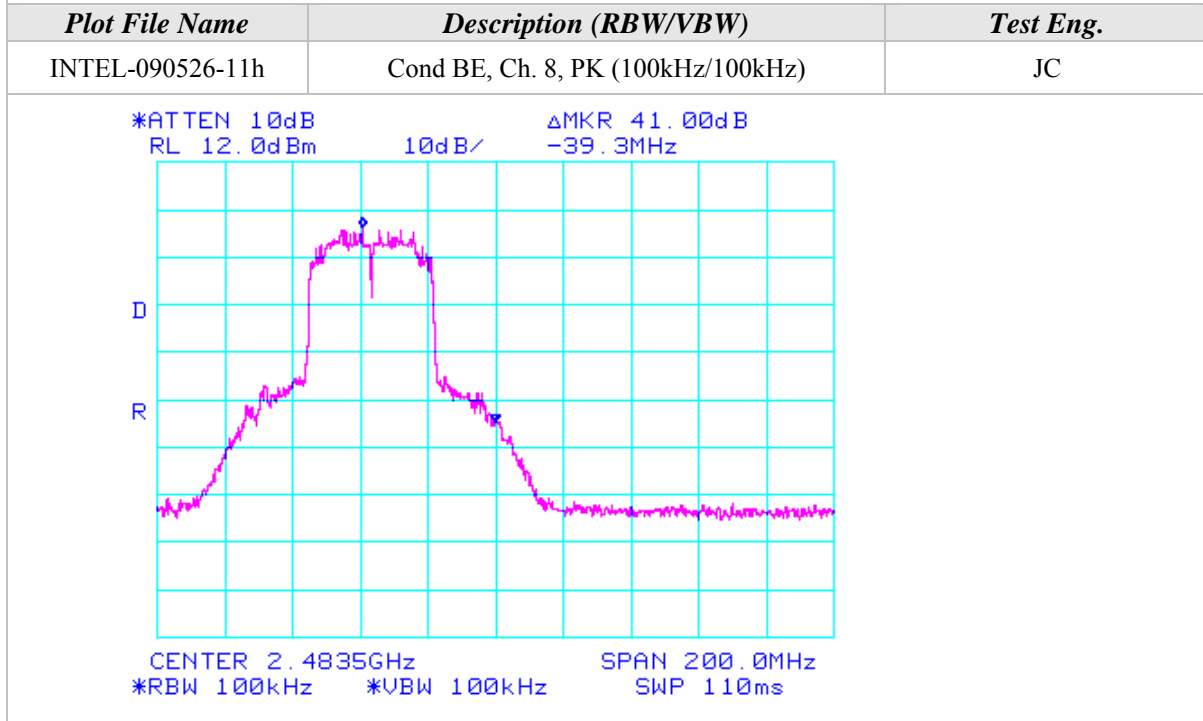
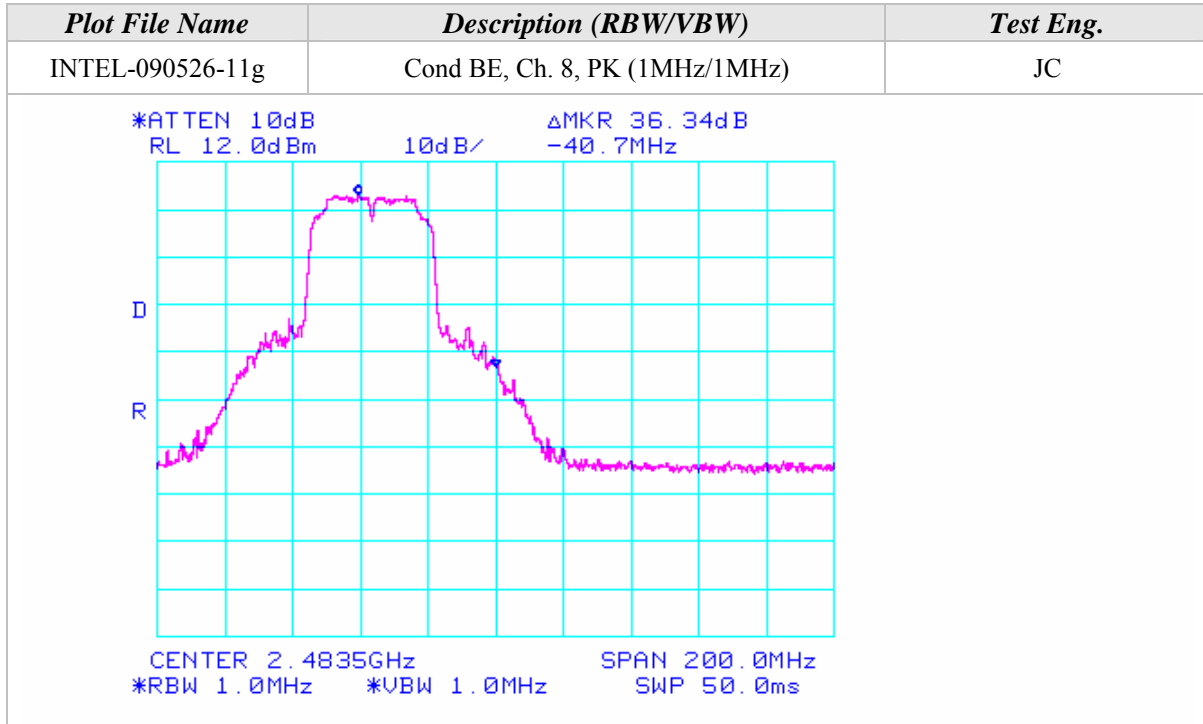

Band-Edge Plots (Continued)

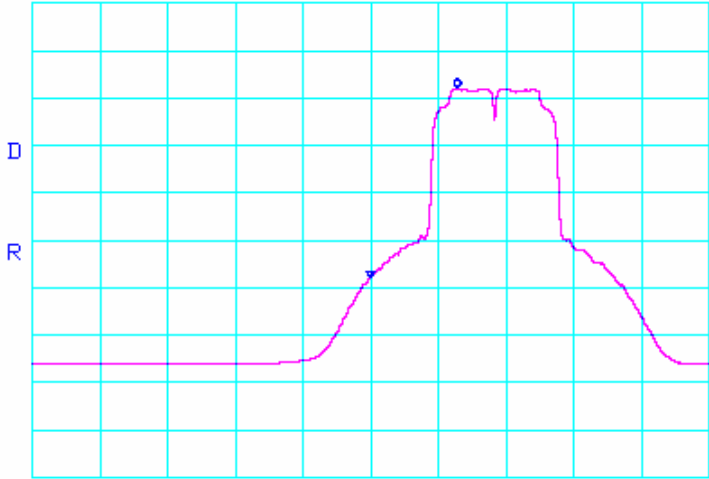
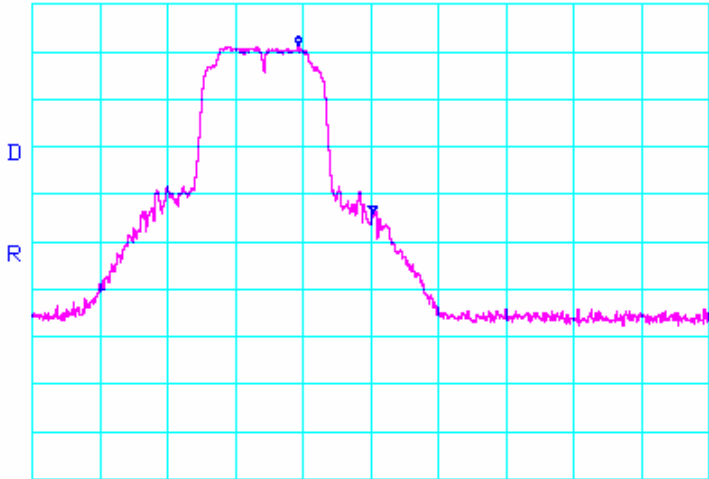
<i>Plot File Name</i>	<i>Description (RBW/VBW)</i>	<i>Test Eng.</i>
INTEL-090526-11i	Cond BE, Ch. 8, AV (1MHz/10Hz)	JC
<p>*ATTEN 10dB ΔMKR 40.00dB RL 12.0dBm 10dB/ 25.7MHz</p>  <p>CENTER 2.3900GHz SPAN 200.0MHz *RBW 1.0MHz *VBW 10Hz SWP 74.0sec</p>		
<i>Plot File Name</i>	<i>Description (RBW/VBW)</i>	<i>Test Eng.</i>
INTEL-090526-11j	Cond BE, Ch. 9, PK (1MHz/1MHz)	JC
<p>*ATTEN 10dB ΔMKR 35.16dB RL 12.0dBm 10dB/ -22.0MHz</p>  <p>CENTER 2.4835GHz SPAN 200.0MHz *RBW 1.0MHz *VBW 1.0MHz SWP 50.0ms</p>		

Band-Edge Plots (Continued)

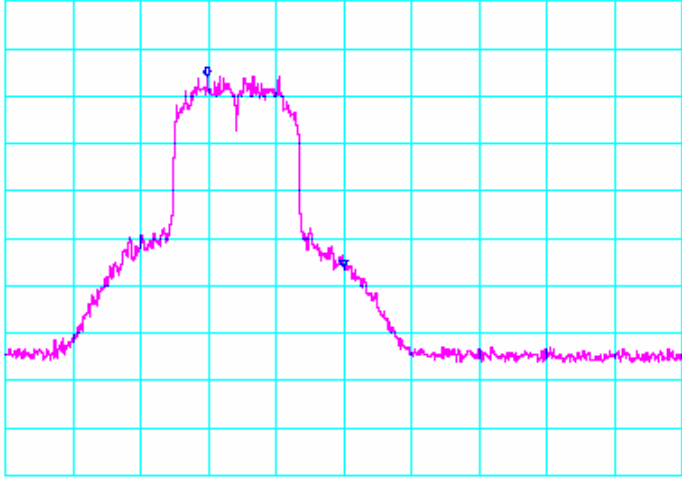
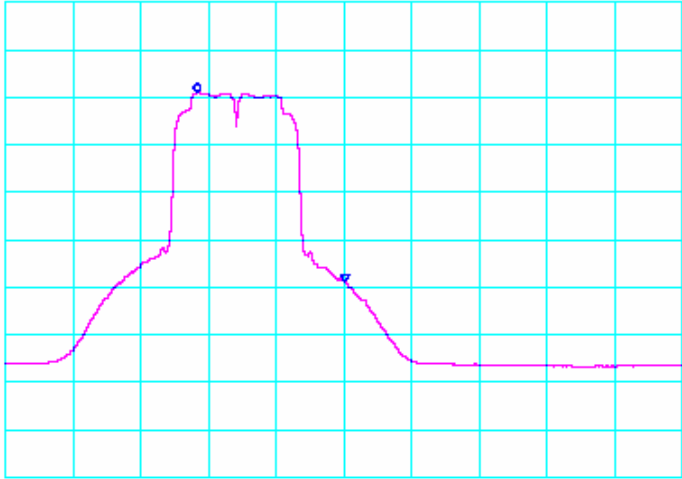
<i>Plot File Name</i>	<i>Description (RBW/VBW)</i>	<i>Test Eng.</i>
INTEL-090526-11k	Cond BE, Ch. 9, PK (100kHz/100kHz)	JC
<div data-bbox="332 399 1036 982" style="border: 1px solid black; padding: 5px;"> <p data-bbox="332 399 1036 451">*ATTEN 10dB ΔMKR 40.17dB RL 12.0dBm 10dB/ -40.3MHz</p>  <p data-bbox="332 934 1036 982">CENTER 2.4835GHz SPAN 200.0MHz *RBW 100kHz *VBW 100kHz SWP 110ms</p> </div>		
<i>Plot File Name</i>	<i>Description (RBW/VBW)</i>	<i>Test Eng.</i>
INTEL-090526-11l	Cond BE, Ch. 9, AV (1MHz/10Hz)	JC
<div data-bbox="332 1117 1036 1701" style="border: 1px solid black; padding: 5px;"> <p data-bbox="332 1117 1036 1169">*ATTEN 10dB ΔMKR 39.83dB RL 12.0dBm 10dB/ -43.7MHz</p>  <p data-bbox="332 1652 1036 1701">CENTER 2.4835GHz SPAN 200.0MHz *RBW 1.0MHz *VBW 10Hz SWP 74.0sec</p> </div>		



Radiated Emissions Test Results (Continued)

*Spurious Emissions Measurements in 802.11n mode 40MHz Wide (2400-2483.5 MHz)
Channels 3, 6, & 9
Continuous TX at Chain A & B Antenna ports with Shanghai Universe Antennas
Aegis Labs, Inc. File #: INTEL-090601-07*

RADIATED EMISSIONS - Horizontal Antenna Polarization												
Freq. (MHz)	Meter Reading (dBuV)	Antenna Height (cm)	Azimuth (degrees)	Quasi pk or AVG (dBuV)		Preamp Factor (dB)	Cable Factor (dB)	Ant. Factor (dB)	Corrected Reading (dBuV)	Limits (dBuV)	Diff (dB) +=FAIL	Channel/Chain Tested
3249.32	52.67	100	315			47.61	2.94	32.75	40.75	74.00	-33.25	Ch. 6/A
3249.32	51.67	100	315			47.61	2.94	32.75	39.75	74.00	-34.25	Ch. 6/B
3229.32	51.50	100	315			47.60	2.92	32.75	39.57	74.00	-34.43	Ch. 3/
4843.98	52.83	100	315			47.51	3.61	34.13	43.06	74.00	-30.94	A
4843.98		100	315	40.42	A	47.51	3.61	34.13	30.65	54.00	-23.35	
3269.32	52.17	100	315			47.62	2.96	32.75	40.26	74.00	-33.74	Ch. 9/
4903.98	51.50	100	0			47.49	3.66	34.12	41.79	74.00	-32.21	A
4903.98		100	0	39.50	A	47.49	3.66	34.12	29.79	54.00	-24.21	

RADIATED EMISSIONS - Vertical Antenna Polarization												
Freq. (MHz)	Meter Reading (dBuV)	Antenna Height (cm)	Azimuth (degrees)	Quasi pk or AVG (dBuV)		Preamp Factor (dB)	Cable Factor (dB)	Ant. Factor (dB)	Corrected Reading (dBuV)	Limits (dBuV)	Diff (dB) +=FAIL	Channel/Chain Tested
3249.32	54.17	100	0			47.61	2.94	32.55	42.05	74.00	-31.95	Ch. 6/
6498.64	51.33	100	90			46.93	4.22	35.50	44.12	74.00	-29.88	A
3249.32	53.83	100	45			47.61	2.94	32.55	41.71	74.00	-32.29	Ch. 6/
4873.98	54.50	100	90			47.50	3.64	34.30	44.94	74.00	-29.06	B
4873.98		100	90	41.61	A	47.50	3.64	34.30	32.05	54.00	-21.95	
6498.64	51.50	100	90			46.93	4.22	35.50	44.29	74.00	-29.71	
3229.32	54.00	100	45			47.60	2.92	32.55	41.87	74.00	-32.13	Ch. 3/
6458.64	52.67	100	90			46.96	4.21	35.48	45.40	74.00	-28.60	B
3269.32	54.00	100	45			47.62	2.96	32.55	41.89	54.00	-12.11	Ch. 9/B



Radiated Emissions Test Results (Continued)

*Spurious Emissions Measurements in 802.11n mode 40MHz Wide (2400-2483.5 MHz)
Channels 3, 6, & 9
Continuous TX at Dual Chain AB Antenna ports with Shanghai Universe Antennas
Aegis Labs, Inc. File #: INTEL-090601-07*

RADIATED EMISSIONS - Horizontal Antenna Polarization												
Freq. (MHz)	Meter Reading (dBuV)	Antenna Height (cm)	Azimuth (degrees)	Quasi pk or AVG (dBuV)		Preamplifier Factor (dB)	Cable Factor (dB)	Ant. Factor (dB)	Corrected Reading (dBuV)	Limits (dBuV)	Diff (dB) +=FAIL	Channel/Chain Tested
3229.33	52.17	100	315			47.60	2.92	32.75	40.24	74.00	-33.76	Ch. 3
6458.66	55.83	100	45			46.96	4.21	35.66	48.73	74.00	-25.27	
3249.32	50.83	100	315			47.61	2.94	32.75	38.91	74.00	-35.09	Ch. 6
6498.64	55.67	100	45			46.93	4.22	35.70	48.66	74.00	-25.34	
3269.32	52.50	100	315			47.62	2.96	32.75	40.59	74.00	-33.41	Ch. 9
6538.64	55.50	100	45			46.87	4.24	35.71	48.58	74.00	-25.42	

RADIATED EMISSIONS - Vertical Antenna Polarization												
Freq. (MHz)	Meter Reading (dBuV)	Antenna Height (cm)	Azimuth (degrees)	Quasi pk or AVG (dBuV)		Preamplifier Factor (dB)	Cable Factor (dB)	Ant. Factor (dB)	Corrected Reading (dBuV)	Limits (dBuV)	Diff (dB) +=FAIL	Channel/Chain Tested
3229.32	52.50	100	315			47.60	2.92	32.55	40.37	74.00	-33.63	Ch. 1
6458.64	59.50	100				46.96	4.21	35.48	52.23	74.00	-21.77	
3249.32	52.17	100	0			47.61	2.94	32.55	40.05	74.00	-33.95	Ch. 6
4873.98	51.67	100	90			47.50	3.64	34.30	42.11	74.00	-31.89	
4873.98		100	90	40.32	A	47.50	3.64	34.30	30.76	54.00	-23.24	
6498.85	58.50	100	90			46.93	4.22	35.50	51.29	74.00	-22.71	
3269.32	52.33	100	45			47.62	2.96	32.55	40.22	74.00	-33.78	Ch. 11
4904.00	51.83	100	90			47.49	3.66	34.30	42.30	74.00	-31.70	
4904.00		100	90	40.62	A	47.49	3.66	34.30	31.09	54.00	-22.91	
6538.66	59.67	100	90			46.87	4.24	35.51	52.55	74.00	-21.45	

**RADIATED EMISSIONS TEST RESULTS**

CLIENT:	Intel Corporation	DATE:	08/17/09
EUT:	Intel® Centrino® Ultimate-N 6200	PROJECT NUMBER:	INTEL-090601
MODEL NUMBER:	622ANHMW	TEST ENGINEER:	JC
SERIAL NUMBER:	0015005A3C7C	SITE #:	2
CONFIGURATION:	Tested installed in an extender board connected to the host laptop's mini PCI slot in 802.11n (5745-5825 MHz) mode 20MHz Wide.	TEMPERATURE:	24° C
		HUMIDITY:	46% RH
		TIME:	9:30 AM

Description:	Radiated RF Emissions (1 GHz – 18 GHz)
Results:	PASSED Horizontal and Vertical Antenna Polarizations Class B Limits
Note:	Radiated Emissions Measurements were performed on the EUT with power supply set at the following voltage and frequency. <ul style="list-style-type: none"> • 120VAC / 60 Hz.

Unwanted Spurious Emissions Limits			
Frequency (MHz)	Field Strength (uV/m)	Field Strength (dBuV/m) (Emissions in the restricted bands)	Field Strength (dBm/MHz) (Emissions outside the restricted bands)
Above 960	500	54.00 (Average) 74.00 (Peak)	< -20 dBc

Radiated Emissions Sample Calculations

$$\text{Corrected Meter Reading} = \text{Meter Reading} + F + C - D$$

Where, F = Antenna Factor

C = Cable Factor

G = Amplifier Gain

D = Distance Factor (if applicable)

Therefore, the equation for determining the Corrected Meter Reading Limit (CML) is:

$$\text{CML} = \text{Specification Limit} - F - C + D$$



Radiated Emissions Test Results (Continued)

*Fundamental Measurements in 802.11n mode 20MHz Wide (5745-5825 MHz)
Channels 149, 157, & 165
Continuous TX at Chain A Antenna port with Shanghai Universe Antennas
Aegis Labs, Inc. File #: INTEL-090601-02*

RADIATED EMISSIONS - Horizontal Antenna Polarization											
<i>Freq. (MHz)</i>	<i>Meter Reading (dBuV)</i>	<i>Antenna Height (cm)</i>	<i>Azimuth (degrees)</i>	<i>Quasi pk or AVG (dBuV)</i>		<i>Cable Factor (dB)</i>	<i>Ant. Factor (dB)</i>	<i>Corrected Reading (dBuV)</i>	<i>Limits (dBuV)</i>	<i>Diff (dB) +=FAIL</i>	<i>Comments</i>
5745.00	61.75	100	45			3.98	34.89	100.63			Ch. 149
5745.00				53.15	A	3.98	34.89	92.03			
5785.00	62.34	100	45			4.00	34.94	101.28			Ch. 157
5785.00				53.68	A	4.00	34.94	92.62			
5825.00	61.36	100	45			4.01	34.99	100.36			Ch. 165
5825.00				54.33	A	4.01	34.99	93.33			

RADIATED EMISSIONS - Vertical Antenna Polarization											
<i>Freq. (MHz)</i>	<i>Meter Reading (dBuV)</i>	<i>Antenna Height (cm)</i>	<i>Azimuth (degrees)</i>	<i>Quasi pk or AVG (dBuV)</i>		<i>Cable Factor (dB)</i>	<i>Ant. Factor (dB)</i>	<i>Corrected Reading (dBuV)</i>	<i>Limits (dBuV)</i>	<i>Diff (dB) +=FAIL</i>	<i>Comments</i>
5745.00	63.39	100	315			3.98	35.05	102.42			Ch. 149
5745.00				52.51	A	3.98	35.05	91.54			
5785.00	62.23	100	315			4.00	35.09	101.31			Ch. 157
5785.00				51.28	A	4.00	35.09	90.36			
5825.00	60.99	100	315			4.01	35.13	100.13			Ch. 165
5825.00				50.73	A	4.01	35.13	89.87			

NOTE: Fundamental signals measured to calculate the band edge field strengths using the “Marker Delta Method”.



Radiated Emissions Test Results (Continued)

*Band Edge Field Strength Measurements in 802.11n mode 20MHz Wide (5745-5825 MHz)
Channels 149 & 165
Continuous TX at Chain A Antenna port with Shanghai Universe Antennas
Aegis Labs, Inc. File #: INTEL-090601-02*

RADIATED EMISSIONS - Horizontal Antenna Polarization										
<i>Freq. (MHz)</i>	<i>Meter Reading (dBuV)</i>	<i>Antenna Height (cm)</i>	<i>Azimuth (degrees)</i>	<i>Quasi pk or AVG (dBuV)</i>	<i>Cable Factor (dB)</i>	<i>Ant. Factor (dB)</i>	<i>Corrected Reading (dBuV)</i>	<i>Limits (dBuV)</i>	<i>Diff (dB) +=FAIL</i>	<i>Comments</i>
5725.00	31.59	100	45		3.98	34.87	70.44	80.63	-10.19	Ch. 149
5850.00	28.94	100	45		4.02	35.02	67.98	80.36	-12.38	Ch. 165

RADIATED EMISSIONS - Vertical Antenna Polarization										
<i>Freq. (MHz)</i>	<i>Meter Reading (dBuV)</i>	<i>Antenna Height (cm)</i>	<i>Azimuth (degrees)</i>	<i>Quasi pk or AVG (dBuV)</i>	<i>Cable Factor (dB)</i>	<i>Ant. Factor (dB)</i>	<i>Corrected Reading (dBuV)</i>	<i>Limits (dBuV)</i>	<i>Diff (dB) +=FAIL</i>	<i>Comments</i>
5725.00	32.03	100	315		3.98	35.03	71.03	82.42	-11.39	Ch. 149
5850.00	29.48	100	315		4.02	35.15	68.65	80.13	-11.48	Ch. 165

NOTE: The “Band Edge Field Strength” was calculated using the “Fundamental” and “Conducted Band Edge” measurements per the “Marker-Delta Method” with the following formula:

$$BE = Fm - \Delta m$$

Where

BE = Band Edge Field Strength

Fm = Measured Fundamental (Peak or Average)

Δm = Measured Conducted Band Edge Delta (Peak or Average)



Radiated Emissions Test Results (Continued)

*Fundamental Measurements in 802.11n mode 20MHz Wide (5745-5825 MHz)
Channels 149, 157, & 165
Continuous TX at Chain B Antenna port with Shanghai Universe Antennas
Aegis Labs, Inc. File #: INTEL-090601-04*

RADIATED EMISSIONS - Horizontal Antenna Polarization											
<i>Freq. (MHz)</i>	<i>Meter Reading (dBuV)</i>	<i>Antenna Height (cm)</i>	<i>Azimuth (degrees)</i>	<i>Quasi pk or AVG (dBuV)</i>		<i>Cable Factor (dB)</i>	<i>Ant. Factor (dB)</i>	<i>Corrected Reading (dBuV)</i>	<i>Limits (dBuV)</i>	<i>Diff (dB) +=FAIL</i>	<i>Comments</i>
5745.00	63.67	100	315			3.98	34.89	102.55			Ch. 149
5745.00				53.83	A	3.98	34.89	92.71			
5785.00	62.83	100	315			4.00	34.94	101.77			Ch. 157
5785.00				53.00	A	4.00	34.94	91.94			
5825.00	62.17	100	315			4.01	34.99	101.17			Ch. 165
5825.00				52.50	A	4.01	34.99	91.50			

RADIATED EMISSIONS - Vertical Antenna Polarization											
<i>Freq. (MHz)</i>	<i>Meter Reading (dBuV)</i>	<i>Antenna Height (cm)</i>	<i>Azimuth (degrees)</i>	<i>Quasi pk or AVG (dBuV)</i>		<i>Cable Factor (dB)</i>	<i>Ant. Factor (dB)</i>	<i>Corrected Reading (dBuV)</i>	<i>Limits (dBuV)</i>	<i>Diff (dB) +=FAIL</i>	<i>Comments</i>
5745.00	63.67	100	315			3.98	35.05	102.70			Ch. 149
5745.00				52.83	A	3.98	35.05	91.86			
5785.00	62.50	100	315			4.00	35.09	101.58			Ch. 157
5785.00				51.67	A	4.00	35.09	90.75			
5825.00	60.83	100	315			4.01	35.13	99.97			Ch. 165
5825.00				50.83	A	4.01	35.13	89.97			

NOTE: Fundamental signals measured to calculate the band edge field strengths using the “Marker Delta Method”.



Radiated Emissions Test Results (Continued)

*Band Edge Field Strength Measurements in 802.11n mode 20MHz Wide (5745-5825 MHz)
Channels 149 & 165
Continuous TX at Chain B Antenna port with Shanghai Universe Antennas
Aegis Labs, Inc. File #: INTEL-090601-04*

RADIATED EMISSIONS - Horizontal Antenna Polarization

<i>Freq. (MHz)</i>	<i>Meter Reading (dBuV)</i>	<i>Antenna Height (cm)</i>	<i>Azimuth (degrees)</i>	<i>Quasi pk or AVG (dBuV)</i>	<i>Cable Factor (dB)</i>	<i>Ant. Factor (dB)</i>	<i>Corrected Reading (dBuV)</i>	<i>Limits (dBuV)</i>	<i>Diff (dB) +=FAIL</i>	<i>Comments</i>
5725.00	35.00	100	45		3.98	34.87	73.85	82.55	-8.70	Ch. 149
5850.00	31.83	100	45		4.02	35.02	70.87	81.17	-10.30	Ch. 165

RADIATED EMISSIONS - Vertical Antenna Polarization

<i>Freq. (MHz)</i>	<i>Meter Reading (dBuV)</i>	<i>Antenna Height (cm)</i>	<i>Azimuth (degrees)</i>	<i>Quasi pk or AVG (dBuV)</i>	<i>Cable Factor (dB)</i>	<i>Ant. Factor (dB)</i>	<i>Corrected Reading (dBuV)</i>	<i>Limits (dBuV)</i>	<i>Diff (dB) +=FAIL</i>	<i>Comments</i>
5725.00	36.50	100	315		3.98	35.03	75.50	82.70	-7.20	Ch. 149
5850.00	31.67	100	315		4.02	35.15	70.84	79.97	-9.13	Ch. 165

NOTE: The “Band Edge Field Strength” was calculated using the “Fundamental” and “Conducted Band Edge” measurements per the “Marker-Delta Method” with the following formula:

$$BE = F_m - \Delta m$$

Where

BE = Band Edge Field Strength

F_m = Measured Fundamental (Peak or Average)

Δ_m = Measured Conducted Band Edge Delta (Peak or Average)



Radiated Emissions Test Results (Continued)

*Spurious Emissions Measurements in 802.11n mode 20MHz Wide (5745-5825 MHz)
Channels 149, 157, & 165
Continuous TX at Chain A & B Antenna ports with Shanghai Universe Antennas
Aegis Labs, Inc. File #: INTEL-090601-07*

RADIATED EMISSIONS - Horizontal Antenna Polarization

Freq. (MHz)	Meter Reading (dBuV)	Antenna Height (cm)	Azimuth (degrees)	Quasi pk or AVG (dBuV)		Preamp Factor (dB)	Cable Factor (dB)	Ant. Factor (dB)	Corrected Reading (dBuV)	Limits (dBuV)	Diff (dB) +/-FAIL	Channel/Chain Tested
3856.66	52.67	100	0			47.58	3.22	33.23	41.54	74.00	-32.46	Ch. 157/
3856.66		100	0	40.71	A	47.58	3.22	33.23	29.58	54.00	-24.42	A
7713.32	53.17	100	0			45.55	4.67	35.83	48.12	74.00	-25.88	
7713.32		100	0	44.11	A	45.55	4.67	35.83	39.06	54.00	-14.94	
3856.66	53.50	100	0			47.58	3.22	33.23	42.37	74.00	-31.63	Ch. 157/
3856.66		100	0	42.80	A	47.58	3.22	33.23	31.67	54.00	-22.33	B
7713.32	53.00	100	0			45.55	4.67	35.83	47.95	74.00	-26.05	
7713.32		100	0	44.36	A	45.55	4.67	35.83	39.31	54.00	-14.69	
3830.00	53.00	100	0			47.56	3.23	33.20	41.87	74.00	-32.13	Ch. 149/
3830.00		100	0	42.42	A	47.56	3.23	33.20	31.29	54.00	-22.71	B
7660.00	53.83	100	0			45.57	4.65	35.80	48.70	74.00	-25.30	
7660.00		100	0	45.99	A	45.57	4.65	35.80	40.86	54.00	-13.14	
3883.33	53.67	100	0			47.60	3.22	33.26	42.55	74.00	-31.45	Ch.165/
3883.33		100	0	43.02	A	47.60	3.22	33.26	31.90	54.00	-22.10	B
7766.66	52.00	100	0			45.52	4.68	35.86	47.02	74.00	-26.98	
7766.66		100	0	42.73	A	45.52	4.68	35.86	37.75	54.00	-16.25	

RADIATED EMISSIONS - Vertical Antenna Polarization

Freq. (MHz)	Meter Reading (dBuV)	Antenna Height (cm)	Azimuth (degrees)	Quasi pk or AVG (dBuV)		Preamp Factor (dB)	Cable Factor (dB)	Ant. Factor (dB)	Corrected Reading (dBuV)	Limits (dBuV)	Diff (dB) +/-FAIL	Channel/Chain Tested
3856.66	54.00	100	0			47.58	3.22	33.17	42.81	74.00	-31.19	Ch. 157/
3856.66		100	0	42.65	A	47.58	3.22	33.17	31.46	54.00	-22.54	A
7713.32	52.67	100	315			45.55	4.67	35.79	47.57	74.00	-26.43	
7713.32		100	315	42.87	A	45.55	4.67	35.79	37.77	54.00	-16.23	
11569.98	52.50	100	0			45.34	5.93	38.36	51.44	74.00	-22.56	
11569.98		100	0	40.02	A	45.34	5.93	38.36	38.96	54.00	-15.04	
3856.66	53.17	100	0			47.58	3.22	33.17	41.98	74.00	-32.02	Ch. 157/
3856.66		100	0	44.30	A	47.58	3.22	33.17	33.11	54.00	-20.89	B
7713.32	53.33	100	0			45.55	4.67	35.79	48.23	74.00	-25.77	
7713.32		100	0	44.54	A	45.55	4.67	35.79	39.44	54.00	-14.56	
3830.00	54.17	100	0			47.56	3.23	33.13	42.97	74.00	-31.03	Ch. 149/
3830.00		100	0	42.80	A	47.56	3.23	33.13	31.60	54.00	-22.40	B
7660.00	53.67	100	0			45.57	4.65	35.76	48.51	74.00	-25.49	
7660.00		100	0	45.07	A	45.57	4.65	35.76	39.91	54.00	-14.09	
3883.33	53.67	100	0			47.60	3.22	33.21	42.50	74.00	-31.50	Ch.165/
3883.33		100	0	44.78	A	47.60	3.22	33.21	33.61	54.00	-20.39	B
7766.66	52.67	100	0			45.52	4.68	35.81	47.63	74.00	-26.37	
7766.66		100	0	42.87	A	45.52	4.68	35.81	37.83	54.00	-16.17	

**RADIATED EMISSIONS TEST RESULTS**

CLIENT:	Intel Corporation	DATE:	08/17/09
EUT:	Intel® Centrino® Ultimate-N 6200	PROJECT NUMBER:	INTEL-090601
MODEL NUMBER:	622ANHMW	TEST ENGINEER:	JC
SERIAL NUMBER:	0015005A3C7C	SITE #:	2
CONFIGURATION:	Tested installed in an extender board connected to the host laptop's mini PCI slot in 802.11n (5745-5825 MHz) mode 40MHz Wide.	TEMPERATURE:	24° C
		HUMIDITY:	46% RH
		TIME:	9:30 AM

Description:	Radiated RF Emissions (1 GHz – 18 GHz)
Results:	PASSED Horizontal and Vertical Antenna Polarizations Class B Limits
Note:	Radiated Emissions Measurements were performed on the EUT with power supply set at the following voltage and frequency. <ul style="list-style-type: none"> • 120VAC / 60 Hz.

Unwanted Spurious Emissions Limits			
Frequency (MHz)	Field Strength (uV/m)	Field Strength (dBuV/m) (Emissions in the restricted bands)	Field Strength (dBm/MHz) (Emissions outside the restricted bands)
Above 960	500	54.00 (Average) 74.00 (Peak)	< -20 dBc

Radiated Emissions Sample Calculations

$$\text{Corrected Meter Reading} = \text{Meter Reading} + F + C - D$$

Where, F = Antenna Factor

C = Cable Factor

G = Amplifier Gain

D = Distance Factor (if applicable)

Therefore, the equation for determining the Corrected Meter Reading Limit (CML) is:

$$\text{CML} = \text{Specification Limit} - F - C + D$$



Radiated Emissions Test Results (Continued)

*Fundamental Measurements in 802.11n mode 40MHz Wide (5745-5825 MHz)
Channels 151 & 159
Continuous TX at Chain A Antenna port with Shanghai Universe Antennas
Aegis Labs, Inc. File #: INTEL-090601-02*

RADIATED EMISSIONS - Horizontal Antenna Polarization											
<i>Freq. (MHz)</i>	<i>Meter Reading (dBuV)</i>	<i>Antenna Height (cm)</i>	<i>Azimuth (degrees)</i>	<i>Quasi pk or AVG (dBuV)</i>		<i>Cable Factor (dB)</i>	<i>Ant. Factor (dB)</i>	<i>Corrected Reading (dBuV)</i>	<i>Limits (dBuV)</i>	<i>Diff (dB) +=FAIL</i>	<i>Comments</i>
5755.00	59.46	100	45			3.99	34.91	98.35			Ch. 151
5755.00				51.04	A	3.99	34.91	89.93			
5795.00	60.37	100	0			4.00	34.95	99.33			Ch. 159
5795.00				51.39	A	4.00	34.95	90.35			

RADIATED EMISSIONS - Vertical Antenna Polarization											
<i>Freq. (MHz)</i>	<i>Meter Reading (dBuV)</i>	<i>Antenna Height (cm)</i>	<i>Azimuth (degrees)</i>	<i>Quasi pk or AVG (dBuV)</i>		<i>Cable Factor (dB)</i>	<i>Ant. Factor (dB)</i>	<i>Corrected Reading (dBuV)</i>	<i>Limits (dBuV)</i>	<i>Diff (dB) +=FAIL</i>	<i>Comments</i>
5755.00	61.26	100	315			3.99	35.06	100.30			Ch. 151
5755.00				51.74	A	3.99	35.06	90.78			
5795.00	59.39	100	315			4.00	35.10	98.49			Ch. 159
5795.00				50.11	A	4.00	35.10	89.21			

NOTE: Fundamental signals measured to calculate the band edge field strengths using the “Marker Delta Method”.



Radiated Emissions Test Results (Continued)

*Band Edge Field Strength Measurements in 802.11n mode 40MHz Wide (5745-5825 MHz)
Channels 151 & 159
Continuous TX at Chain A Antenna port with Shanghai Universe Antennas
Aegis Labs, Inc. File #: INTEL-090601-02*

RADIATED EMISSIONS - Horizontal Antenna Polarization										
<i>Freq. (MHz)</i>	<i>Meter Reading (dBuV)</i>	<i>Antenna Height (cm)</i>	<i>Azimuth (degrees)</i>	<i>Quasi pk or AVG (dBuV)</i>	<i>Cable Factor (dB)</i>	<i>Ant. Factor (dB)</i>	<i>Corrected Reading (dBuV)</i>	<i>Limits (dBuV)</i>	<i>Diff (dB) +=FAIL</i>	<i>Comments</i>
5725.00	29.68	100	45		3.98	34.87	68.53	78.35	-9.83	Ch. 151
5850.00	29.51	100	0		4.02	35.02	68.55	79.33	-10.77	Ch. 159

RADIATED EMISSIONS - Vertical Antenna Polarization										
<i>Freq. (MHz)</i>	<i>Meter Reading (dBuV)</i>	<i>Antenna Height (cm)</i>	<i>Azimuth (degrees)</i>	<i>Quasi pk or AVG (dBuV)</i>	<i>Cable Factor (dB)</i>	<i>Ant. Factor (dB)</i>	<i>Corrected Reading (dBuV)</i>	<i>Limits (dBuV)</i>	<i>Diff (dB) +=FAIL</i>	<i>Comments</i>
5725.00	30.67	100	315		3.98	35.03	69.67	80.30	-10.63	Ch. 151
5850.00	31.16	100	315		4.02	35.15	70.33	78.49	-8.15	Ch. 159

NOTE: The “Band Edge Field Strength” was calculated using the “Fundamental” and “Conducted Band Edge” measurements per the “Marker-Delta Method” with the following formula:

$$BE = Fm - \Delta m$$

Where

BE = Band Edge Field Strength

Fm = Measured Fundamental (Peak or Average)

Δm = Measured Conducted Band Edge Delta (Peak or Average)



Radiated Emissions Test Results (Continued)

*Fundamental Measurements in 802.11n mode 40MHz Wide (5745-5825 MHz)
Channels 151 & 159
Continuous TX at Chain B Antenna port with Shanghai Universe Antennas
Aegis Labs, Inc. File #: INTEL-090601-04*

RADIATED EMISSIONS - Horizontal Antenna Polarization											
<i>Freq. (MHz)</i>	<i>Meter Reading (dBuV)</i>	<i>Antenna Height (cm)</i>	<i>Azimuth (degrees)</i>	<i>Quasi pk or AVG (dBuV)</i>		<i>Cable Factor (dB)</i>	<i>Ant. Factor (dB)</i>	<i>Corrected Reading (dBuV)</i>	<i>Limits (dBuV)</i>	<i>Diff (dB) +=FAIL</i>	<i>Comments</i>
5755.00	60.17	100	315			3.99	34.91	99.06			Ch. 151
5755.00				51.00	A	3.99	34.91	89.89			
5795.00	59.50	100	315			4.00	34.95	98.46			Ch. 159
5795.00				50.17	A	4.00	34.95	89.13			

RADIATED EMISSIONS - Vertical Antenna Polarization											
<i>Freq. (MHz)</i>	<i>Meter Reading (dBuV)</i>	<i>Antenna Height (cm)</i>	<i>Azimuth (degrees)</i>	<i>Quasi pk or AVG (dBuV)</i>		<i>Cable Factor (dB)</i>	<i>Ant. Factor (dB)</i>	<i>Corrected Reading (dBuV)</i>	<i>Limits (dBuV)</i>	<i>Diff (dB) +=FAIL</i>	<i>Comments</i>
5755.00	62.50	100	90			3.99	35.06	101.54			Ch. 151
5755.00				52.17	A	3.99	35.06	91.21			
5795.00	59.17	100	90			4.00	35.10	98.27			Ch. 159
5795.00				49.50	A	4.00	35.10	88.60			

NOTE: Fundamental signals measured to calculate the band edge field strengths using the “Marker Delta Method”.



Radiated Emissions Test Results (Continued)

*Band Edge Field Strength Measurements in 802.11n mode 40MHz Wide (5745-5825 MHz)
Channels 151 & 159
Continuous TX at Chain B Antenna port with Shanghai Universe Antennas
Aegis Labs, Inc. File #: INTEL-090601-04*

RADIATED EMISSIONS - Horizontal Antenna Polarization										
<i>Freq. (MHz)</i>	<i>Meter Reading (dBuV)</i>	<i>Antenna Height (cm)</i>	<i>Azimuth (degrees)</i>	<i>Quasi pk or AVG (dBuV)</i>	<i>Cable Factor (dB)</i>	<i>Ant. Factor (dB)</i>	<i>Corrected Reading (dBuV)</i>	<i>Limits (dBuV)</i>	<i>Diff (dB) +=FAIL</i>	<i>Comments</i>
5725.00	34.17	100	315		3.98	34.87	73.02	79.06	-6.05	Ch. 151
5850.00	30.50	100	315		4.02	35.02	69.54	78.46	-8.91	Ch. 159

RADIATED EMISSIONS - Vertical Antenna Polarization										
<i>Freq. (MHz)</i>	<i>Meter Reading (dBuV)</i>	<i>Antenna Height (cm)</i>	<i>Azimuth (degrees)</i>	<i>Quasi pk or AVG (dBuV)</i>	<i>Cable Factor (dB)</i>	<i>Ant. Factor (dB)</i>	<i>Corrected Reading (dBuV)</i>	<i>Limits (dBuV)</i>	<i>Diff (dB) +=FAIL</i>	<i>Comments</i>
5725.00	36.50	100	90		3.98	35.03	75.50	81.54	-6.04	Ch. 151
5850.00	33.83	100	90		4.02	35.15	73.00	78.27	-5.26	Ch. 159

NOTE: The “Band Edge Field Strength” was calculated using the “Fundamental” and “Conducted Band Edge” measurements per the “Marker-Delta Method” with the following formula:

$$BE = Fm - \Delta m$$

Where

BE = Band Edge Field Strength

Fm = Measured Fundamental (Peak or Average)

Δm = Measured Conducted Band Edge Delta (Peak or Average)



Radiated Emissions Test Results (Continued)

*Spurious Emissions Measurements in 802.11n mode 40MHz Wide (5745-5825 MHz)
Channels 151 & 159
Continuous TX at Dual Chain AB Antenna ports with Shanghai Universe Antennas
Aegis Labs, Inc. File #: INTEL-090601-07*

RADIATED EMISSIONS - Horizontal Antenna Polarization

Freq. (MHz)	Meter Reading (dBuV)	Antenna Height (cm)	Azimuth (degrees)	Quasi pk or AVG (dBuV)		Preamp Factor (dB)	Cable Factor (dB)	Ant. Factor (dB)	Corrected Reading (dBuV)	Limits (dBuV)	Diff (dB) +=FAIL	Channel/Chain Tested
3836.66	54.17	100	315			47.57	3.23	33.20	43.04	74.00	-30.96	Ch. 151
3836.66		100	315	42.18	A	47.57	3.23	33.20	31.05	54.00	-22.95	
7673.33	53.00	100	0			45.57	4.66	35.80	47.89	74.00	-26.11	
7673.33		100	0	44.17	A	45.57	4.66	35.80	39.06	54.00	-14.94	
11510.00	52.83	100	45			45.32	5.91	38.31	51.73	74.00	-22.27	
11510.00		100	45	43.09	A	45.32	5.91	38.31	41.99	54.00	-12.01	
3863.33	53.33	100	315			47.58	3.22	33.24	42.20	74.00	-31.80	Ch.159
3863.33		100	315	41.17	A	47.58	3.22	33.24	30.04	54.00	-23.96	
7726.66	51.83	100	315			45.54	4.67	35.84	46.79	74.00	-27.21	
7726.66		100	315	40.23	A	45.54	4.67	35.84	35.19	54.00	-18.81	
11590.00	56.50	100	45			45.34	5.93	38.37	55.46	74.00	-18.54	
11590.00		100	45	46.40	A	45.34	5.93	38.37	45.36	54.00	-8.64	

RADIATED EMISSIONS - Vertical Antenna Polarization

Freq. (MHz)	Meter Reading (dBuV)	Antenna Height (cm)	Azimuth (degrees)	Quasi pk or AVG (dBuV)		Preamp Factor (dB)	Cable Factor (dB)	Ant. Factor (dB)	Corrected Reading (dBuV)	Limits (dBuV)	Diff (dB) +=FAIL	Channel/Chain Tested
3836.66	53.17	100	0			47.57	3.23	33.14	41.97	74.00	-32.03	Ch. 151
3836.66		100	0	41.44	A	47.57	3.23	33.14	30.24	54.00	-23.76	
7673.33	56.33	100	0			45.57	4.66	35.77	51.19	74.00	-22.81	
7673.33		100	0	51.94	A	45.57	4.66	35.77	46.80	54.00	-7.20	
11510.00	52.67	100	0			45.32	5.91	38.31	51.57	74.00	-22.43	
11510.00		100	0	42.42	A	45.32	5.91	38.31	41.32	54.00	-12.68	
3863.33	53.00	100	0			47.58	3.22	33.18	41.82	74.00	-32.18	Ch.159
3863.33		100	0	41.69	A	47.58	3.22	33.18	30.51	54.00	-23.49	
7726.66	55.50	100	0			45.54	4.67	35.79	50.42	74.00	-23.58	
7726.66		100	0	49.17	A	45.54	4.67	35.79	44.09	54.00	-9.91	
11590.00	54.50	100	0			45.34	5.93	38.37	53.46	74.00	-20.54	
11590.00		100	0	45.84	A	45.34	5.93	38.37	44.80	54.00	-9.20	

**MAXIMUM CONDUCTED OUTPUT POWER**

CLIENT:	Intel Corporation	DATE:	07/30/09
EUT:	Intel® Centrino® Ultimate-N 6200	PROJECT NUMBER:	INTEL-090601
MODEL NUMBER:	622ANHMW	TEST ENGINEER:	JC
SERIAL NUMBER:	0015005A3C7C	SITE #:	2
CONFIGURATION:	Tested installed in an extender board connected to the host laptop's mini PCI slot	TEMPERATURE:	22 deg. C
		HUMIDITY:	54% RH
		TIME:	8:00 AM

Description:	The maximum conducted output power is the highest total transmit power occurring in any mode
Results:	Passed (See Data Sheet)
Note:	Conducted Emissions Measurements were performed on the EUT with power supply set at the following voltage and frequency. <ul style="list-style-type: none">• 120VAC / 60 Hz.



Maximum Conducted Output Power (Continued)

Mode	Channel	Frequency (MHz)	Chain	Data Rate (Mbps)	Average Power* (dBm)	Average Power* (mW)	Output Power** (dBm)	Output Power** (mW)
802.11a	149	5745	A	6	16.53	45.02	16.74	47.25
802.11a	157	5785	A	6	16.72	47.03	16.94	49.47
802.11a	165	5825	A	6	16.33	42.99	16.64	46.17
802.11a	149	5745	B	6	16.46	44.30	16.64	46.17
802.11a	157	5785	B	6	16.56	45.33	16.84	48.35
802.11a	165	5825	B	6	16.62	45.96	16.94	49.47
802.11b	1	2412	A	1	16.47	44.36	16.60	45.71
802.11b	6	2437	A	1	16.34	43.05	16.50	44.67
802.11b	11	2462	A	1	16.51	44.77	16.70	46.77
802.11b	1	2412	B	1	16.60	45.71	16.80	47.86
802.11b	6	2437	B	1	16.43	43.95	16.60	45.71
802.11b	11	2462	B	1	16.64	46.13	16.80	47.86
802.11g	1	2412	A	6	15.36	34.38	15.54	35.84
802.11g	6	2437	A	6	16.53	45.02	16.74	47.25
802.11g	11	2462	A	6	15.45	35.10	15.64	36.67
802.11g	1	2412	B	6	15.62	36.51	15.84	38.40
802.11g	6	2437	B	6	16.41	43.79	16.64	46.17
802.11g	11	2462	B	6	15.65	36.76	15.84	38.40
802.11n	1	2412	A	HT0	14.70	29.54	14.94	31.22
802.11n	6	2437	A	HT0	16.49	44.60	16.74	47.25
802.11n	11	2462	A	HT0	14.40	27.57	14.64	29.13
802.11n	1	2412	B	HT0	14.53	28.40	14.74	29.81
802.11n	6	2437	B	HT0	16.40	43.69	16.64	46.17
802.11n	11	2462	B	HT0	14.27	26.75	14.54	28.47
802.11n	149	5745	A	HT0	16.55	45.22	16.64	46.17
802.11n	157	5785	A	HT0	16.38	43.49	16.54	45.12
802.11n	165	5825	A	HT0	16.45	44.19	16.64	46.17
802.11n	149	5745	B	HT0	16.60	45.75	16.84	48.35
802.11n	157	5785	B	HT0	16.38	43.49	16.64	46.17
802.11n	165	5825	B	HT0	16.45	44.19	16.74	47.25

*NOTE: The Average power is measured conducted, using power meter with average power sensor.

**NOTE: The output power is measured conducted, using spectrum analyzer.



Peak Transmit Power (Continued)

Mode	Channel	Frequency (MHz)	Chain	Data Rate (Mbps)	Average Power* (dBm)	Average Power* (mW)	Output Power** (dBm)	Output Power** (mW)
802.11n (40MHz)	3(F)	2422	A	HT0	12.15	16.42	12.44	17.55
802.11n (40MHz)	4(F)	2427	A	HT0	13.72	23.57	13.94	24.80
802.11n (40MHz)	6(F)	2437	A	HT0	16.35	43.19	16.54	45.12
802.11n (40MHz)	8(F)	2447	A	HT0	13.67	23.30	13.84	24.23
802.11n (40MHz)	9(F)	2452	A	HT0	12.17	16.50	12.54	17.96
802.11n (40MHz)	3(F)	2422	B	HT0	12.14	16.38	12.44	17.55
802.11n (40MHz)	4(F)	2427	B	HT0	13.68	23.35	13.84	24.23
802.11n (40MHz)	6(F)	2437	B	HT0	16.19	41.63	16.44	44.09
802.11n (40MHz)	8(F)	2447	B	HT0	13.60	22.93	13.84	24.23
802.11n (40MHz)	9(F)	2452	B	HT0	12.26	16.84	12.44	17.55
802.11n (40MHz)	151(F)	5755	A	HT0	16.54	45.06	16.89	48.84
802.11n (40MHz)	159(F)	5795	A	HT0	16.40	43.63	16.79	47.73
802.11n (40MHz)	151(F)	5755	B	HT0	16.58	45.48	16.79	47.73
802.11n (40MHz)	159(F)	5795	B	HT0	16.62	45.90	16.79	47.73

Dual Chain AB Aggregate Power

Mode	Channel	Frequency (MHz)	Chain	Data Rate (Mbps)	Average Power* (dBm)	Average Power* (mW)	Output Power** (dBm)	Output Power** (mW)
802.11n (20MHz)	1	2412	AB	HT8	14.29	26.88	14.50	28.21
802.11n (20MHz)	6	2437	AB	HT8	16.60	45.75	16.76	47.37
802.11n (20MHz)	11	2462	AB	HT8	14.27	26.70	14.46	27.92
802.11n (40MHz)	3(F)	2422	AB	HT8	12.21	16.63	12.46	17.60
802.11n (40MHz)	6(F)	2437	AB	HT8	16.61	45.82	16.80	47.91
802.11n (40MHz)	9(F)	2452	AB	HT8	12.25	16.79	12.50	17.80
802.11n (20MHz)	149	5745	AB	HT8	16.72	47.04	16.90	49.03
802.11n (20MHz)	157	5785	AB	HT8	16.59	45.65	16.76	47.37
802.11n (20MHz)	165	5825	AB	HT8	16.69	46.71	16.80	47.91
802.11n (40MHz)	151(F)	5755	AB	HT8	16.66	46.34	16.80	47.85
802.11n (40MHz)	159(F)	5795	AB	HT8	16.57	45.43	16.80	47.84

*NOTE: The Average power is measured conducted, using power meter with average power sensor.

**NOTE: The output power is measured conducted, using spectrum analyzer.

(F) = Fat Channel

**6dB EMISSIONS BANDWIDTH**

CLIENT:	Intel Corporation	DATE:	08/10/09
EUT:	Intel WiFi Link 6300	PROJECT NUMBER:	INTEL-090601
MODEL NUMBER:	622ANHMW	TEST ENGINEER:	JC
SERIAL NUMBER:	0015005A3C7C	SITE #:	2
CONFIGURATION:	Tested installed in an extender board connected to the host laptop's mini PCI slot	TEMPERATURE:	25 deg. C
		HUMIDITY:	45% RH
		TIME:	10:00 AM

Description:	The minimum 6dB bandwidth shall be at least 500 kHz.
Results:	See Data Sheet
Note:	Conducted Emissions Measurements were performed on the EUT with power supply set at the following voltage and frequency. <ul style="list-style-type: none">• 120VAC / 60 Hz.

6dB Emissions Bandwidth (Continued)

802.11a Mode

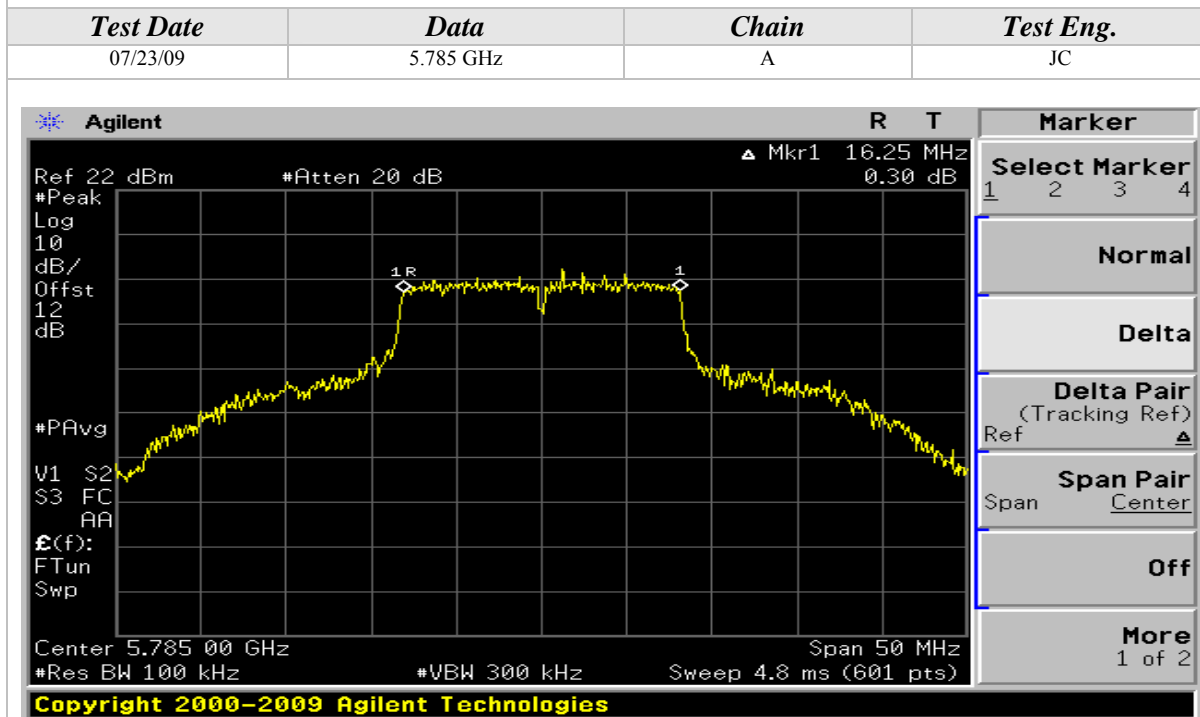
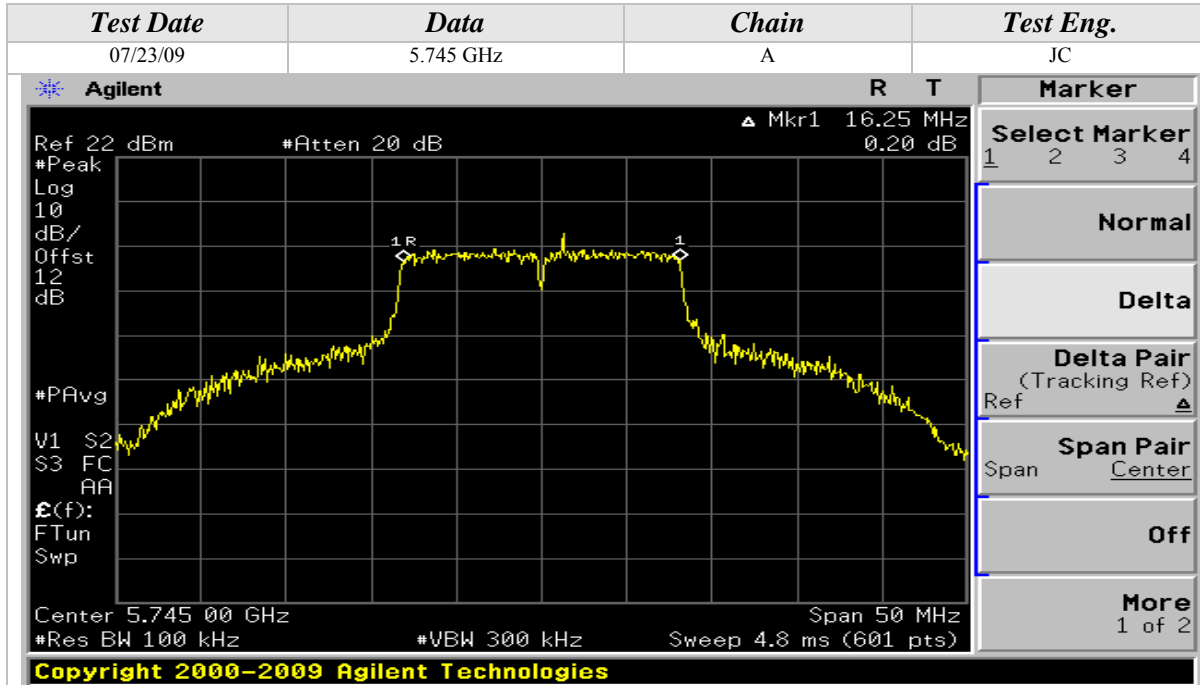

6dB Emissions Bandwidth (Continued)

802.11a Mode

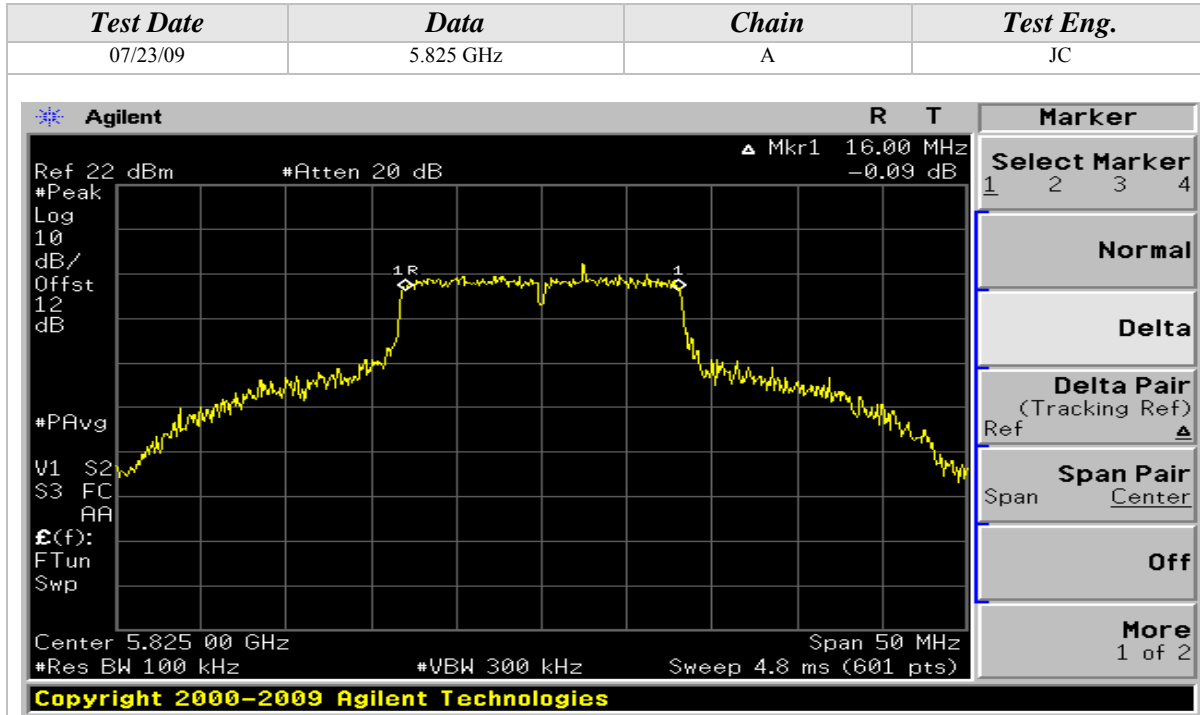

802.11b Mode

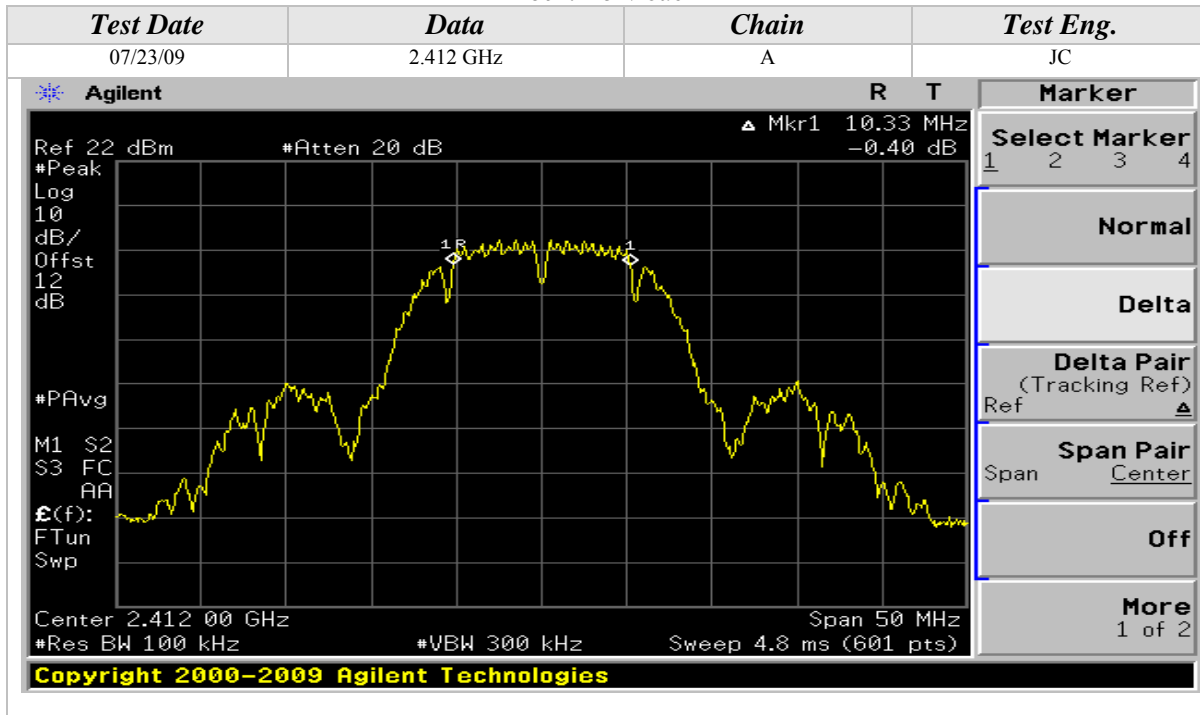

6dB Emissions Bandwidth (Continued)

802.11b Mode

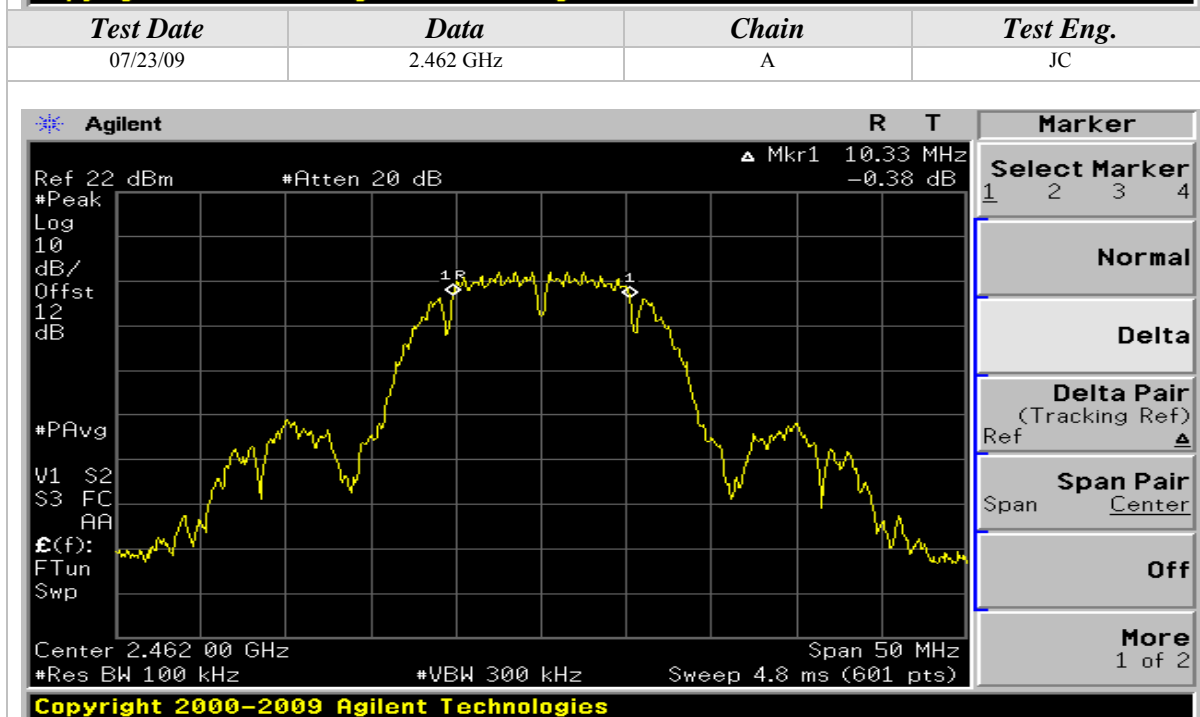
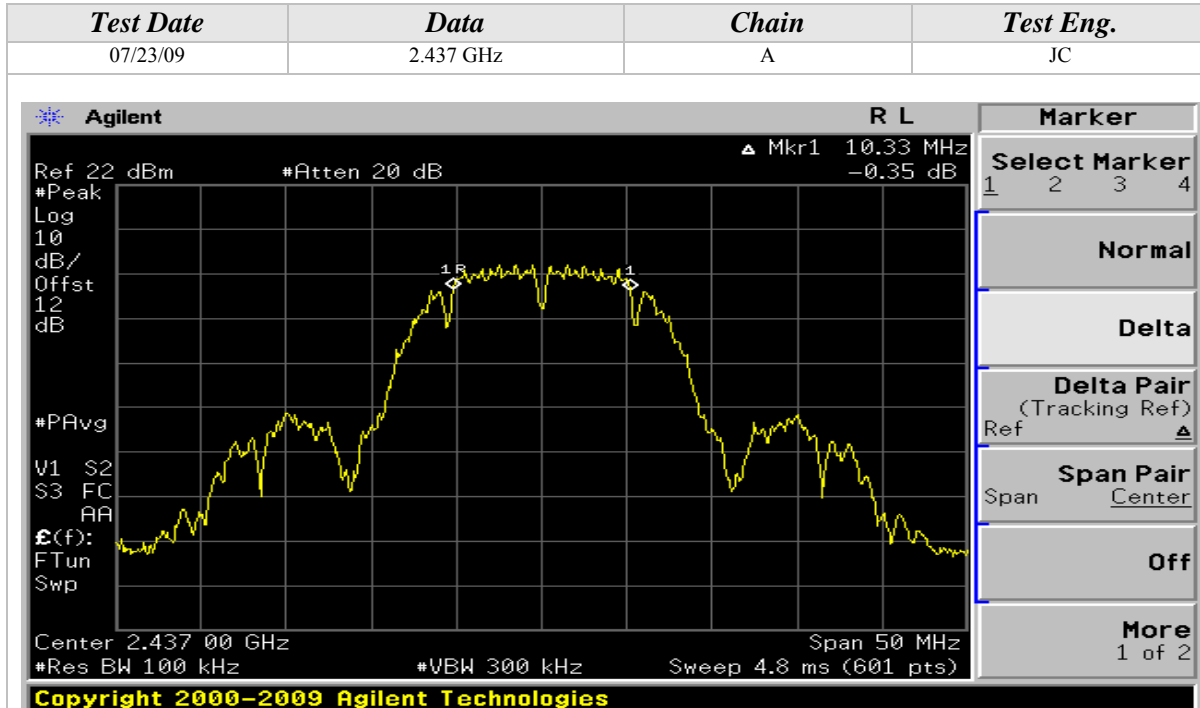

6dB Emissions Bandwidth (Continued)

802.11g Mode

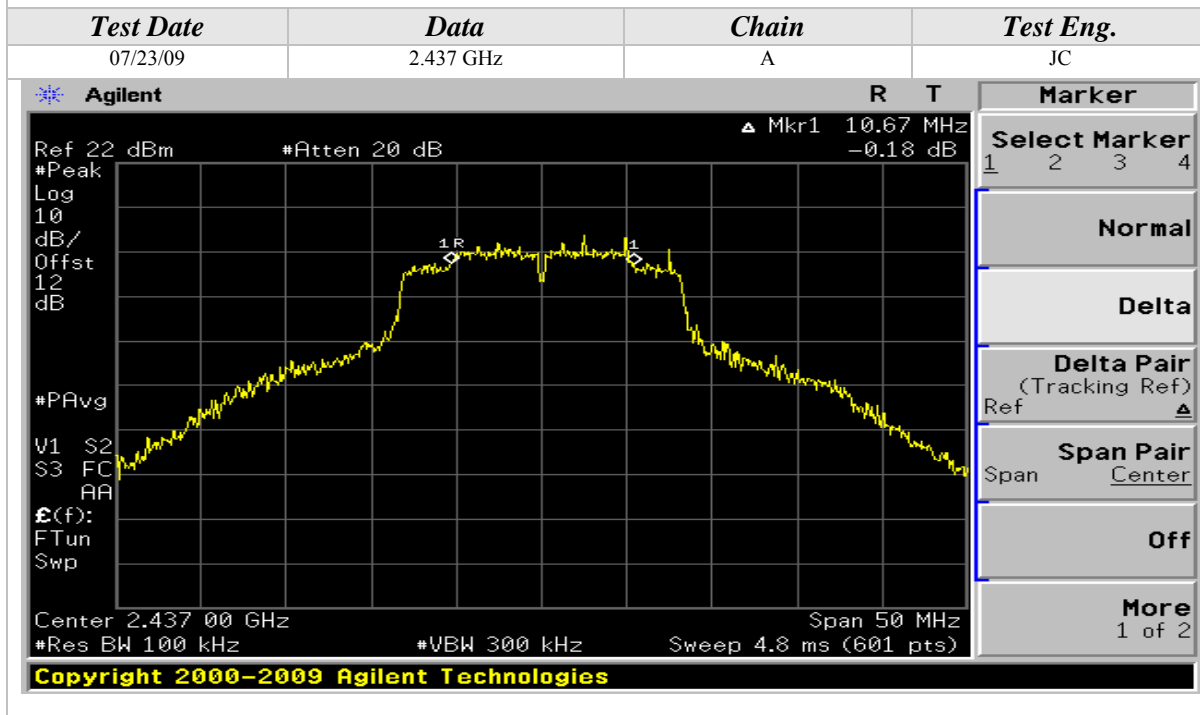
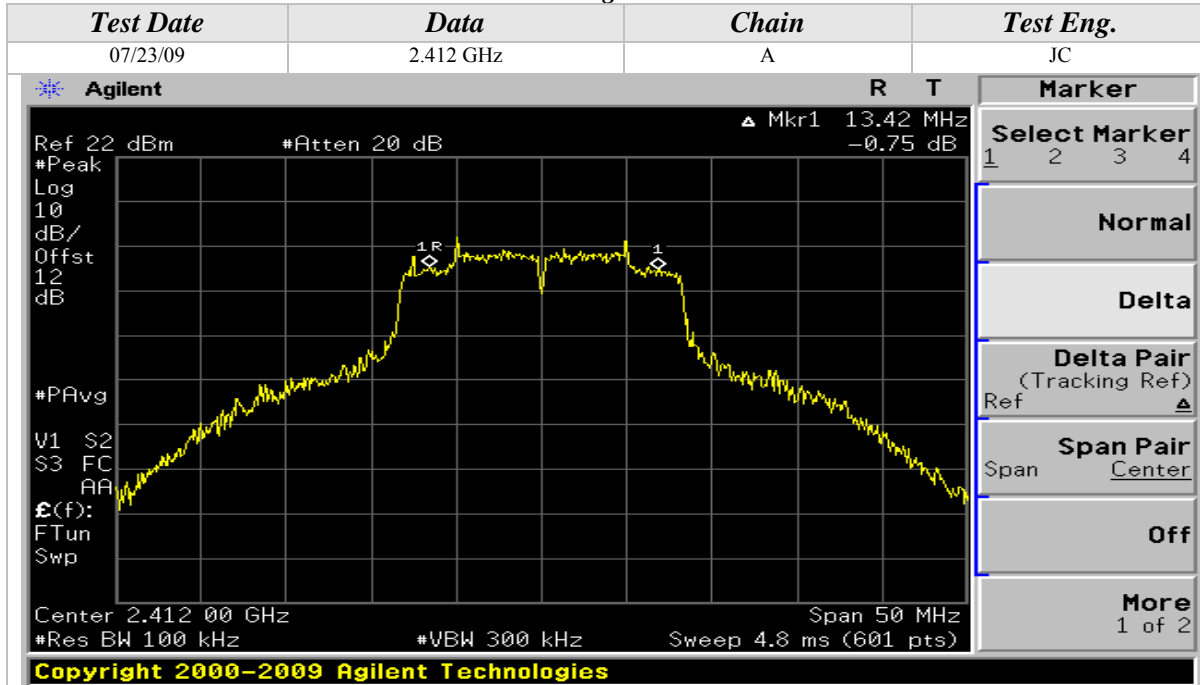

6dB Emissions Bandwidth (Continued)

802.11g Mode

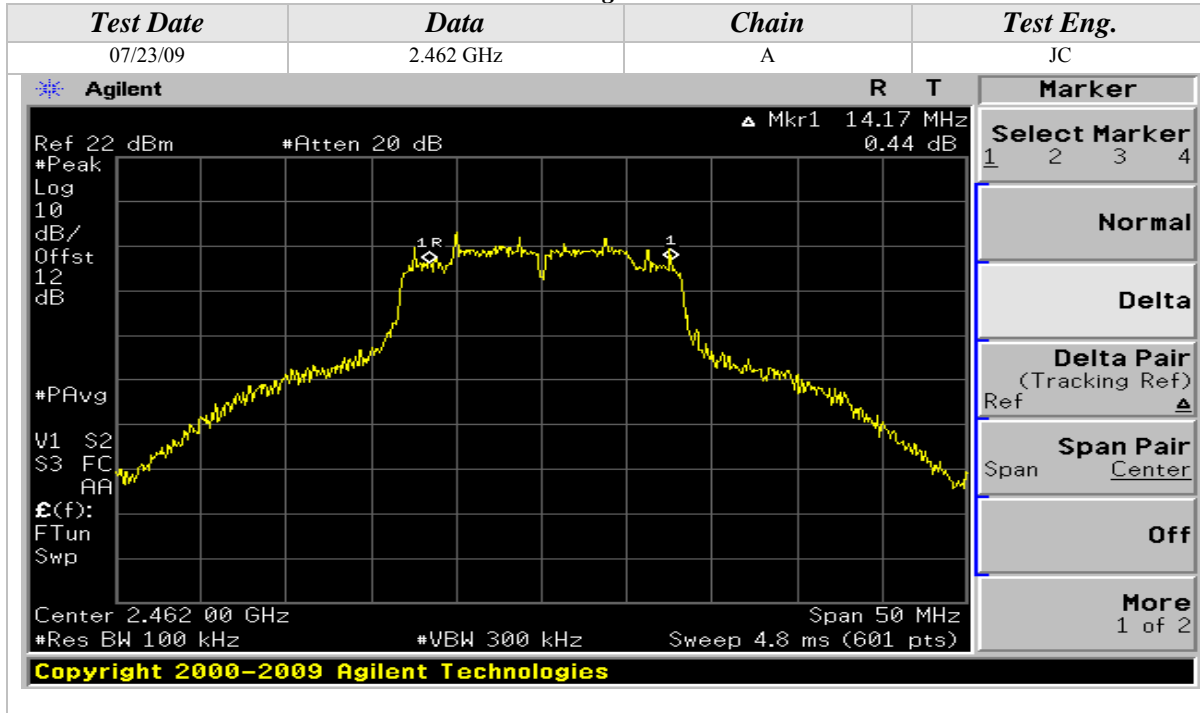

802.11n Mode, 2.4GHz, 20MHz Wide

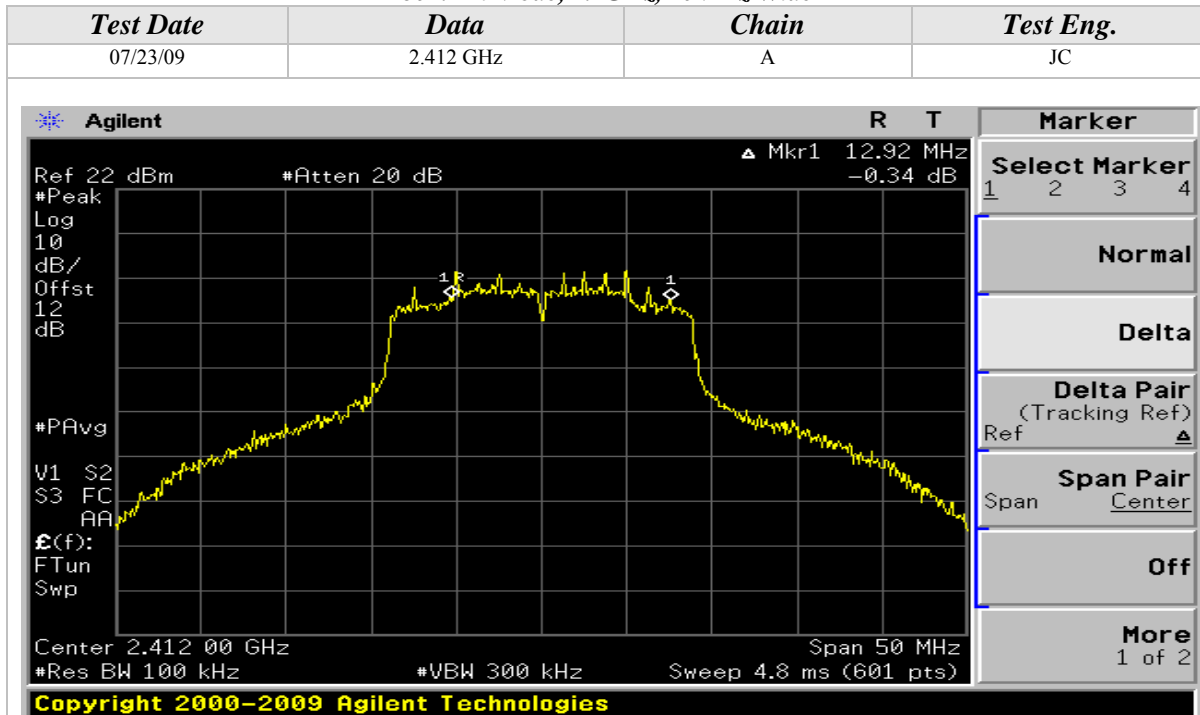

6dB Emissions Bandwidth (Continued)

802.11n Mode, 2.4GHz, 20MHz Wide

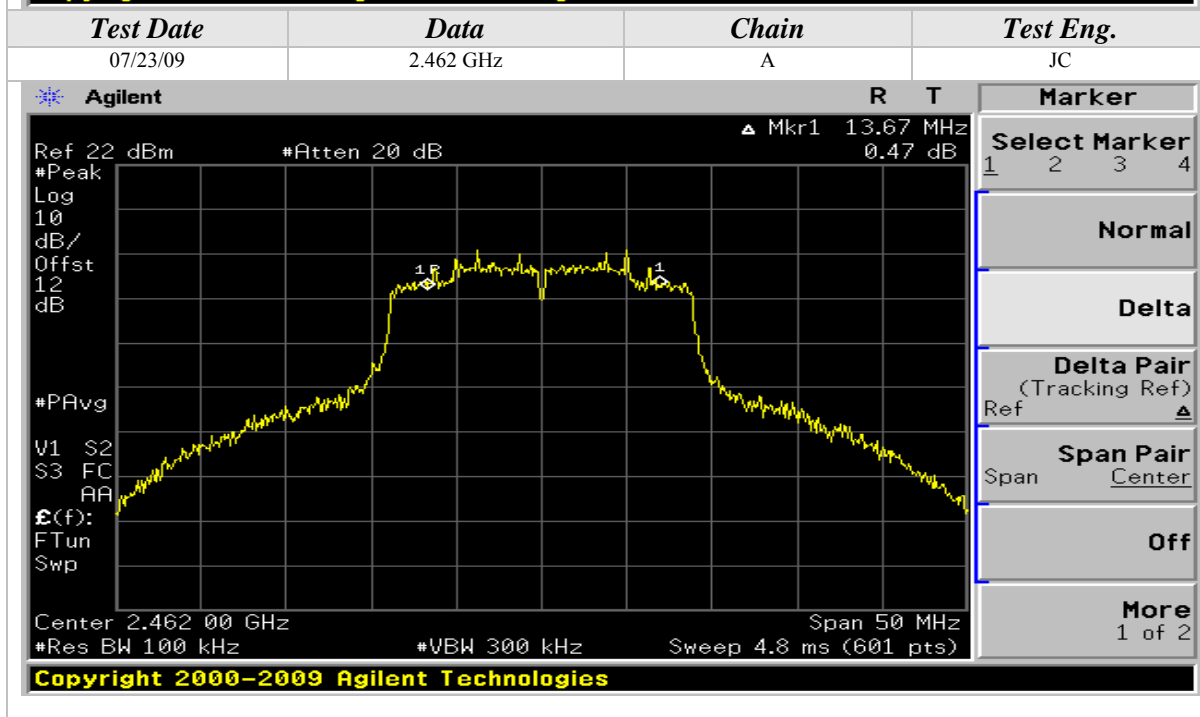
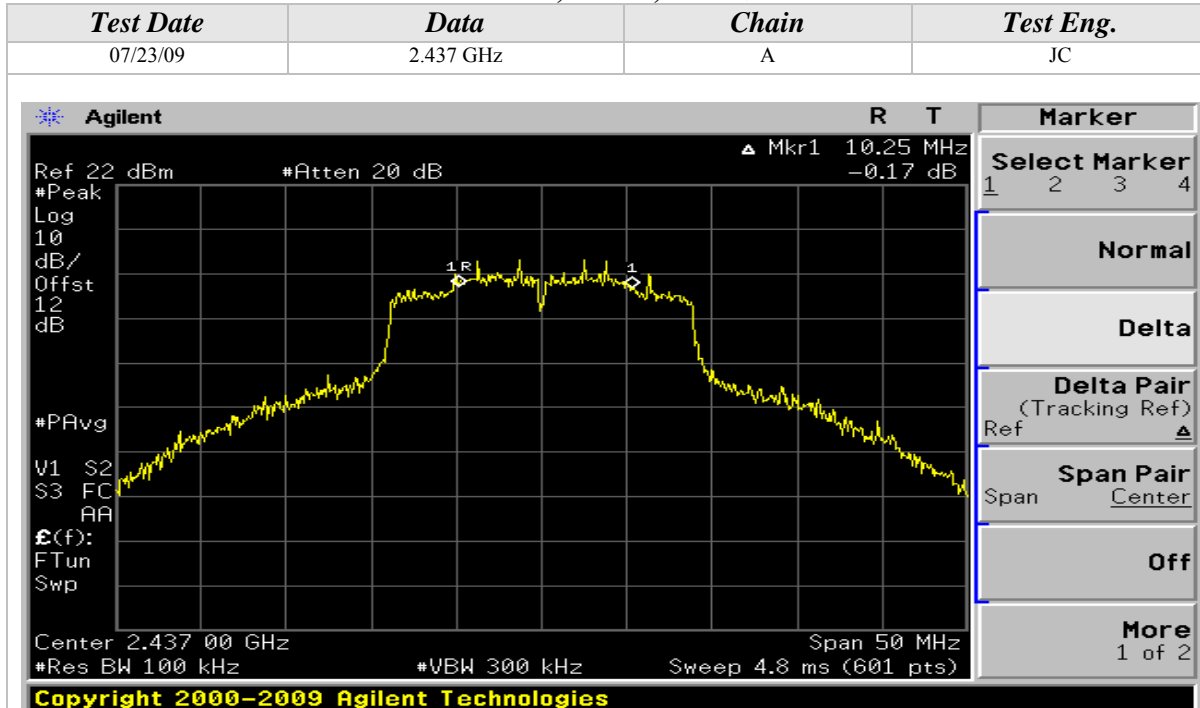

6dB Emissions Bandwidth (Continued)

802.11n Mode, 2.4GHz, 40MHz Wide

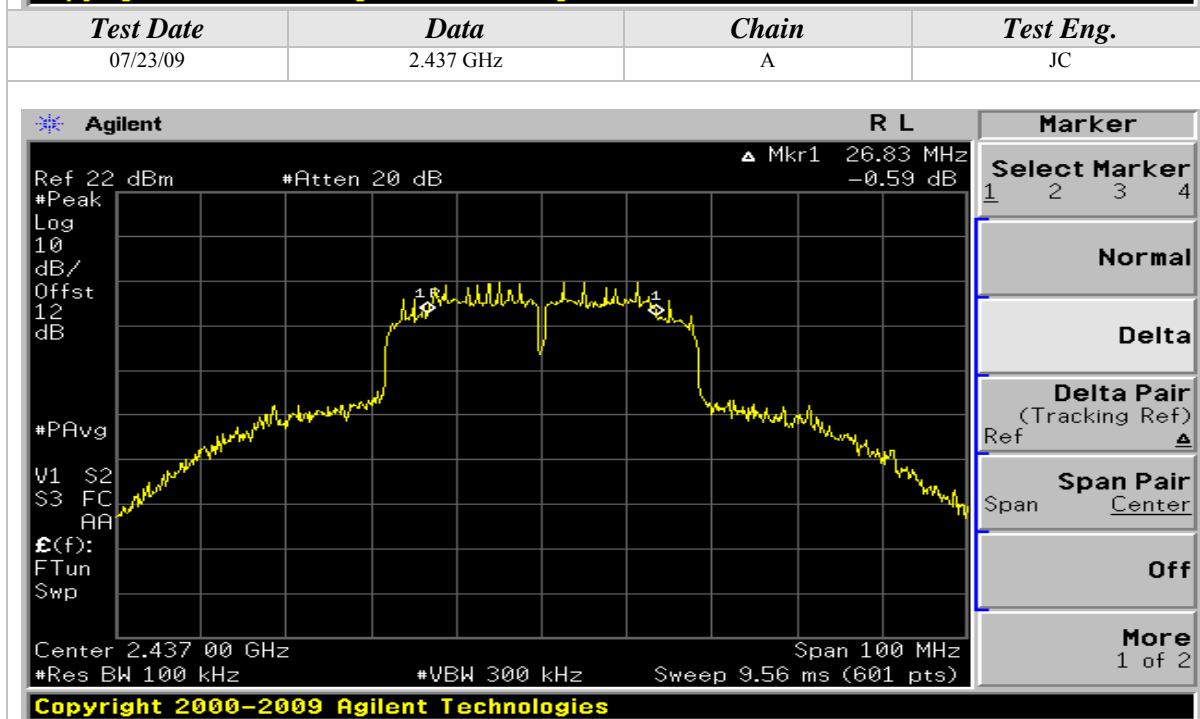

6dB Emissions Bandwidth (Continued)

802.11n Mode, 2.4GHz, 40MHz Wide

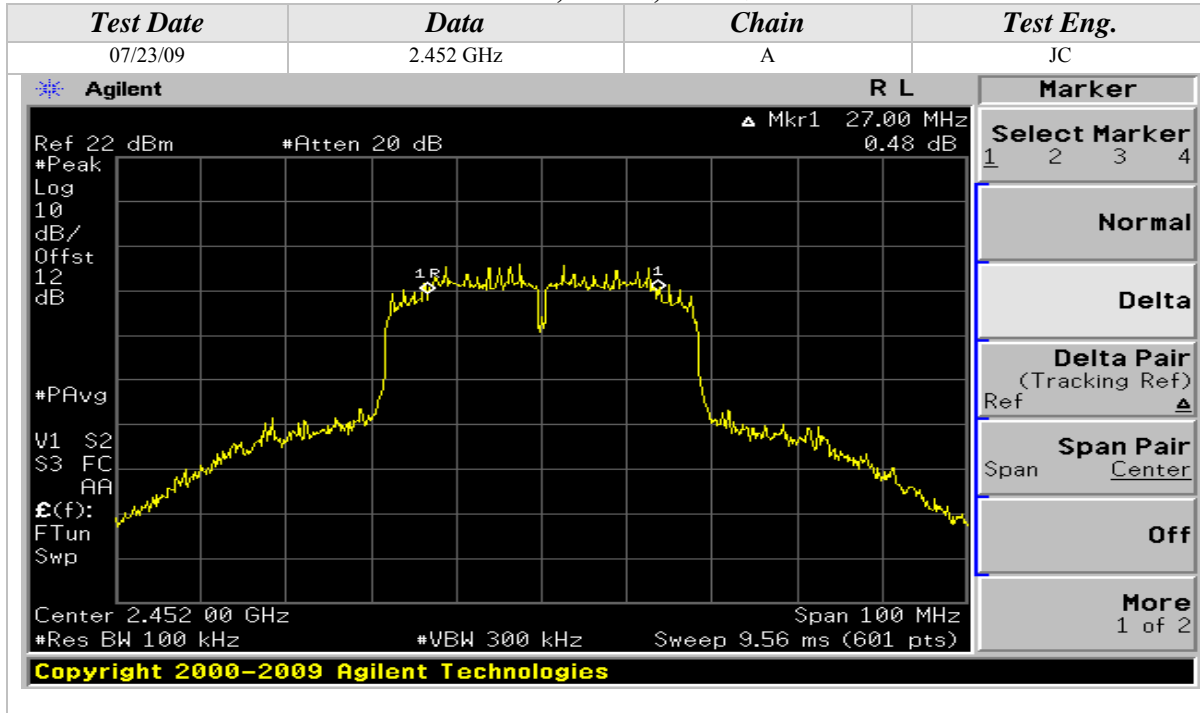

802.11n Mode, 5GHz, 20MHz Wide

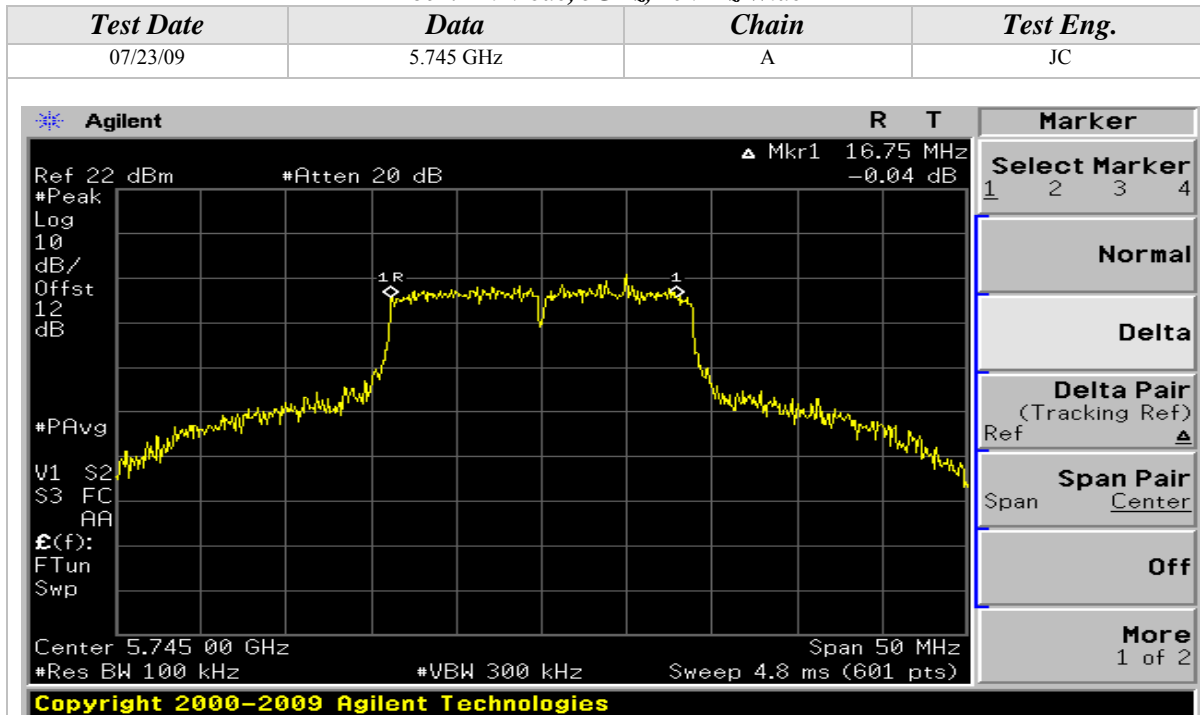

6dB Emissions Bandwidth (Continued)

802.11n Mode, 5GHz, 20MHz Wide

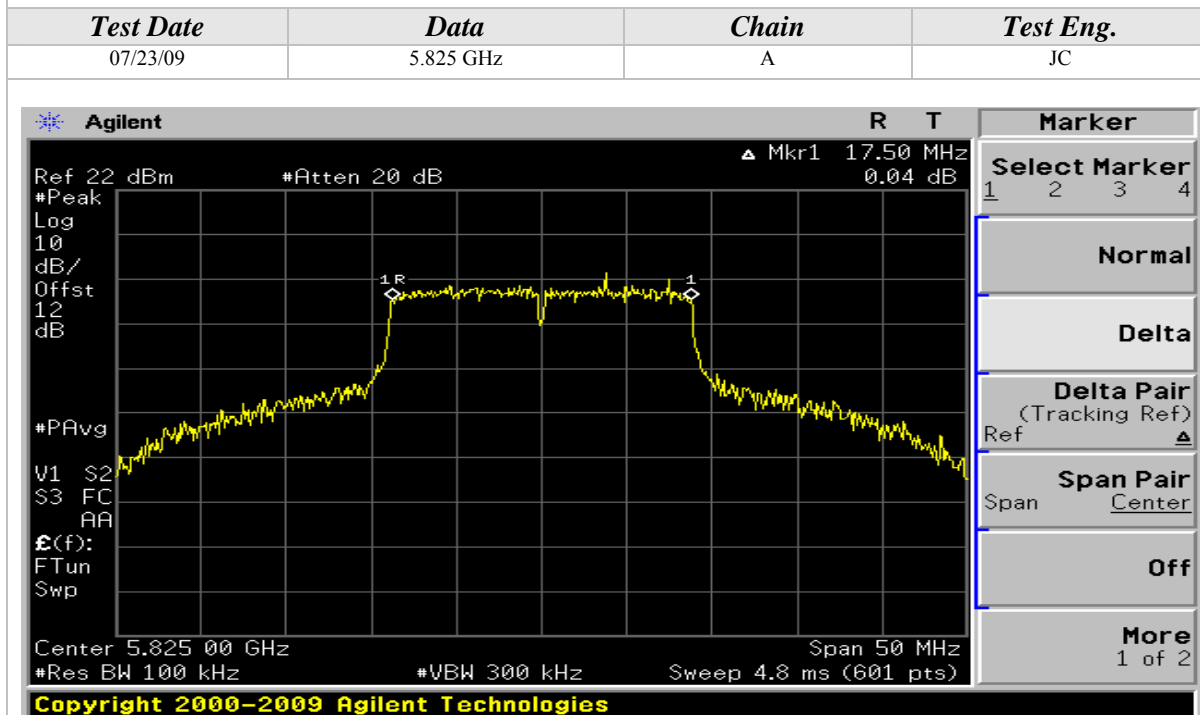
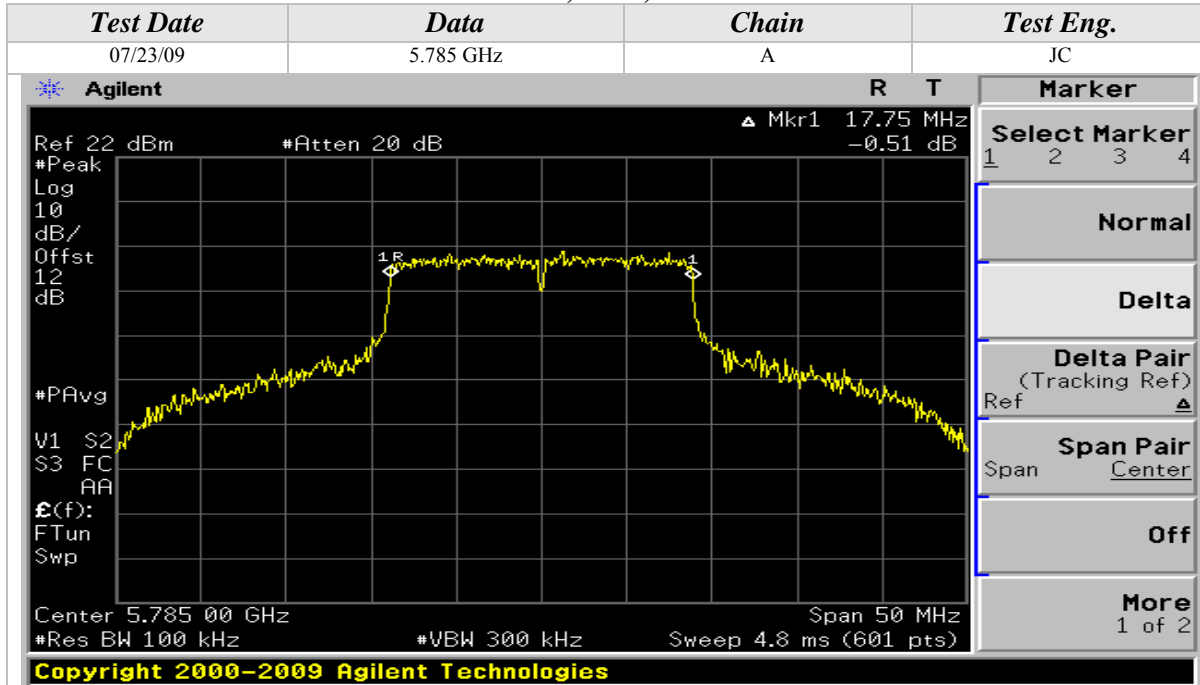

6dB Emissions Bandwidth (Continued)

802.11n Mode, 5GHz, 40MHz Wide

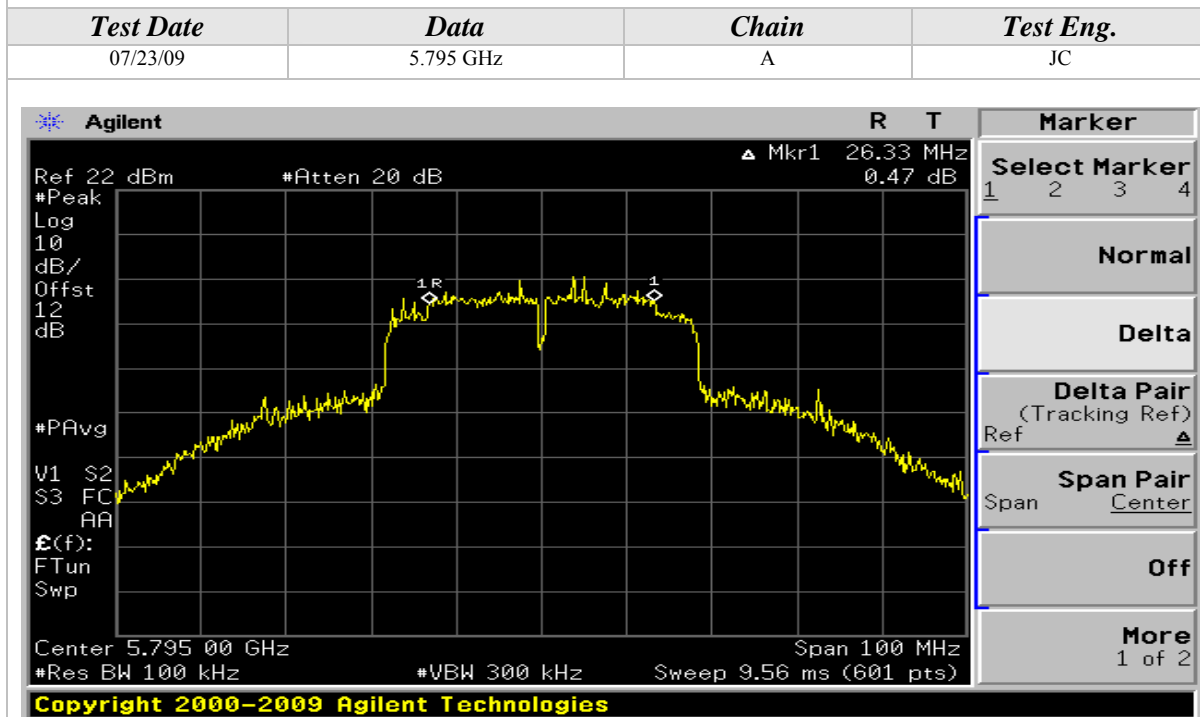
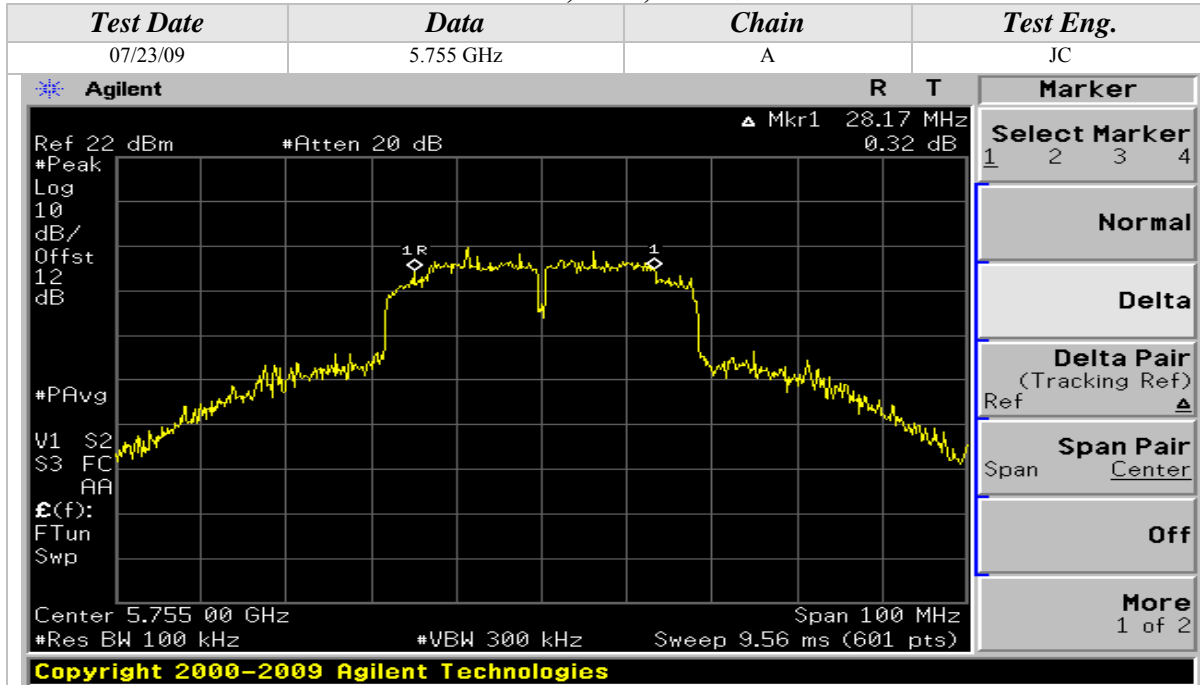

6dB Emissions Bandwidth (Continued)

802.11a Mode

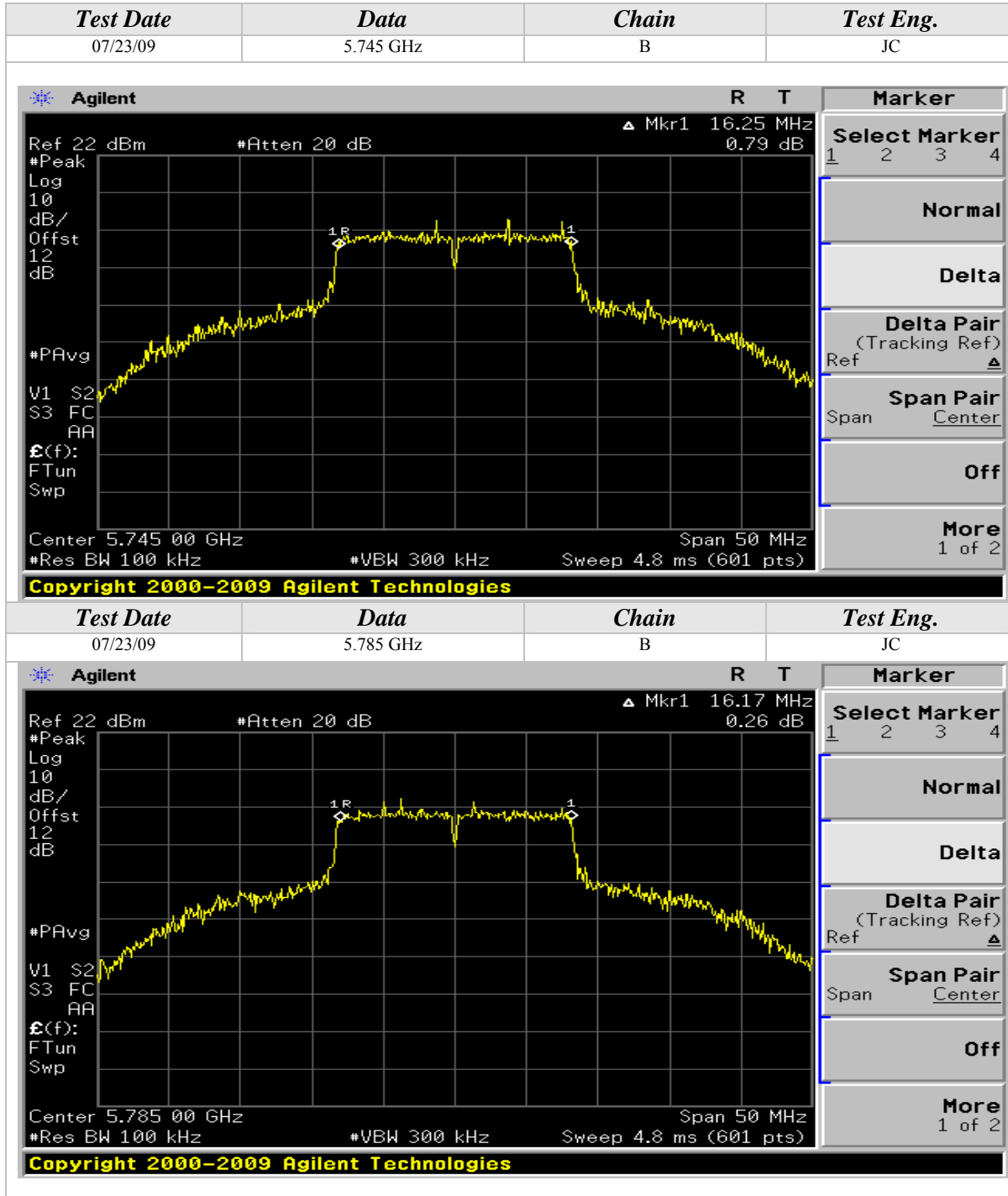

6dB Emissions Bandwidth (Continued)

802.11a Mode



802.11b Mode

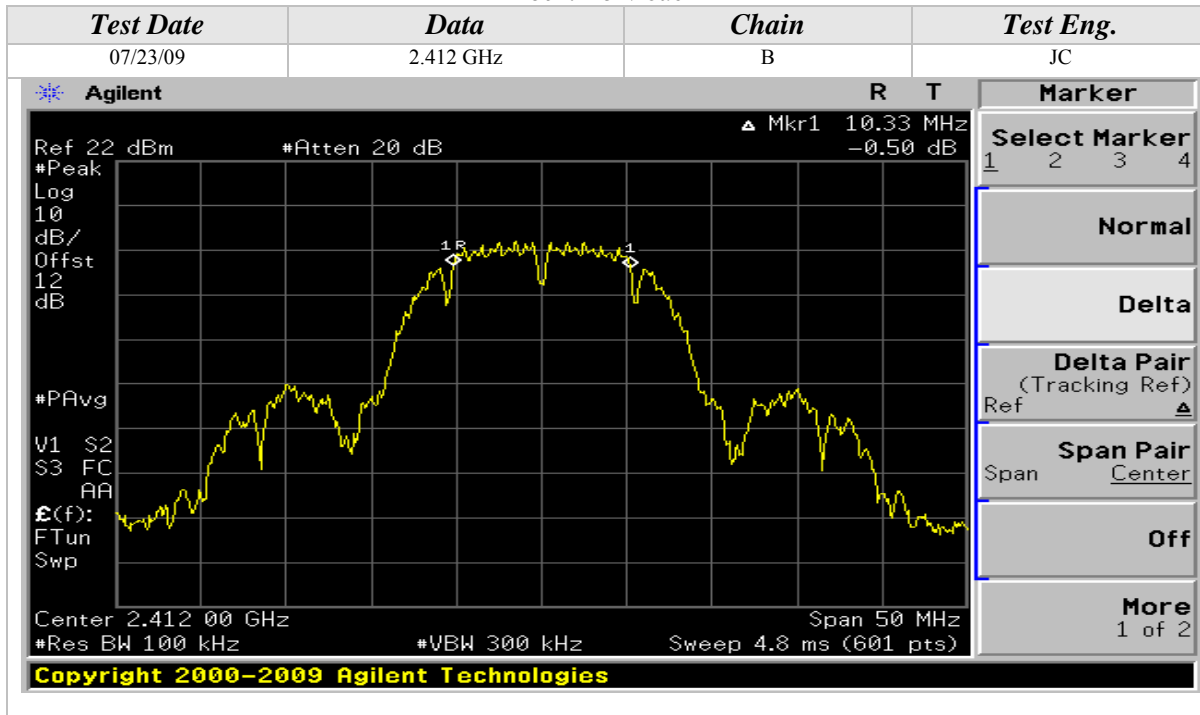

6dB Emissions Bandwidth (Continued)

802.11b Mode

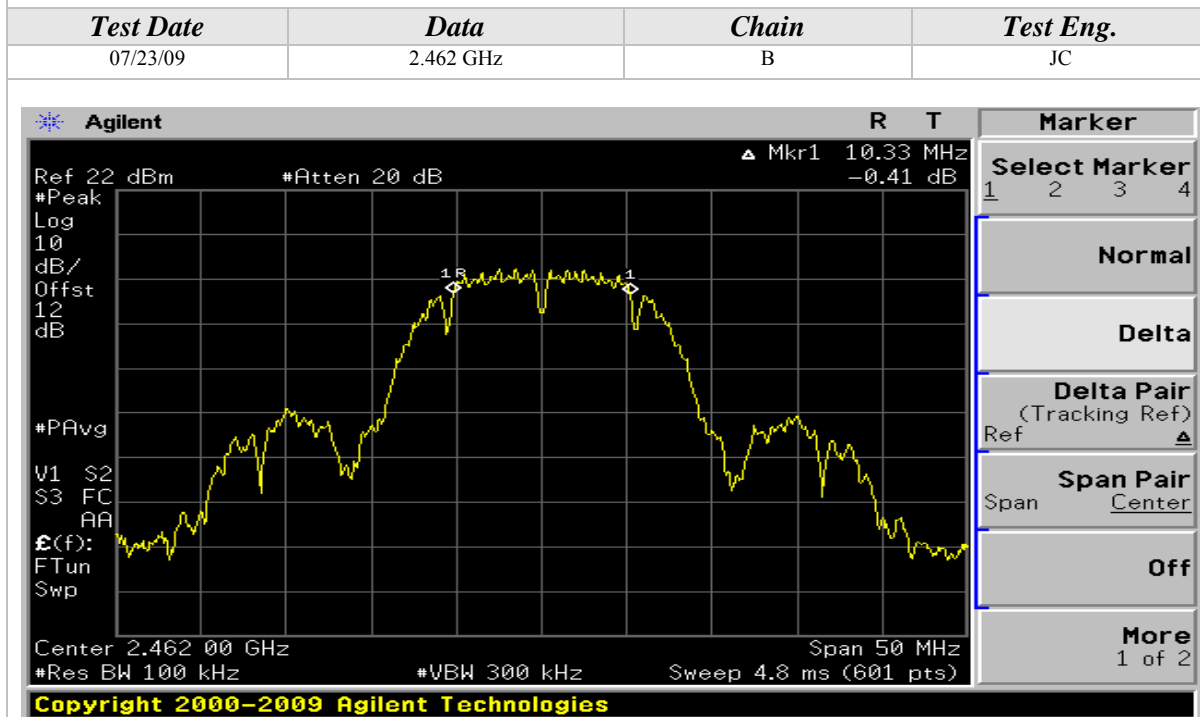
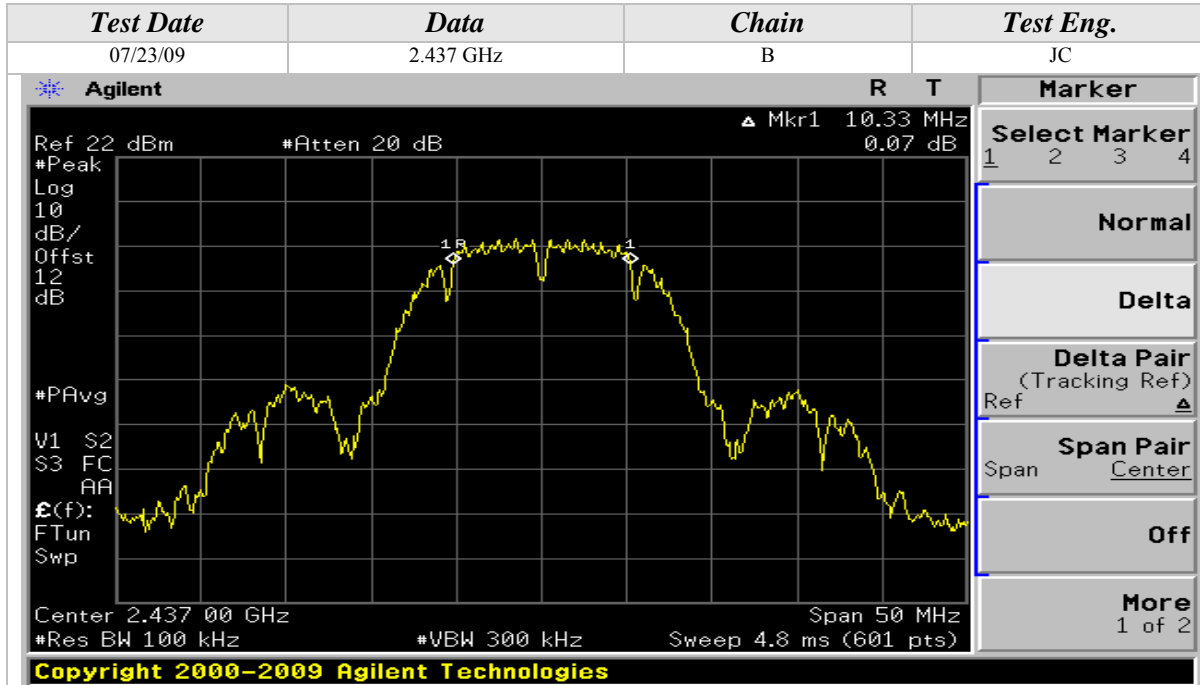

6dB Emissions Bandwidth (Continued)

802.11g Mode

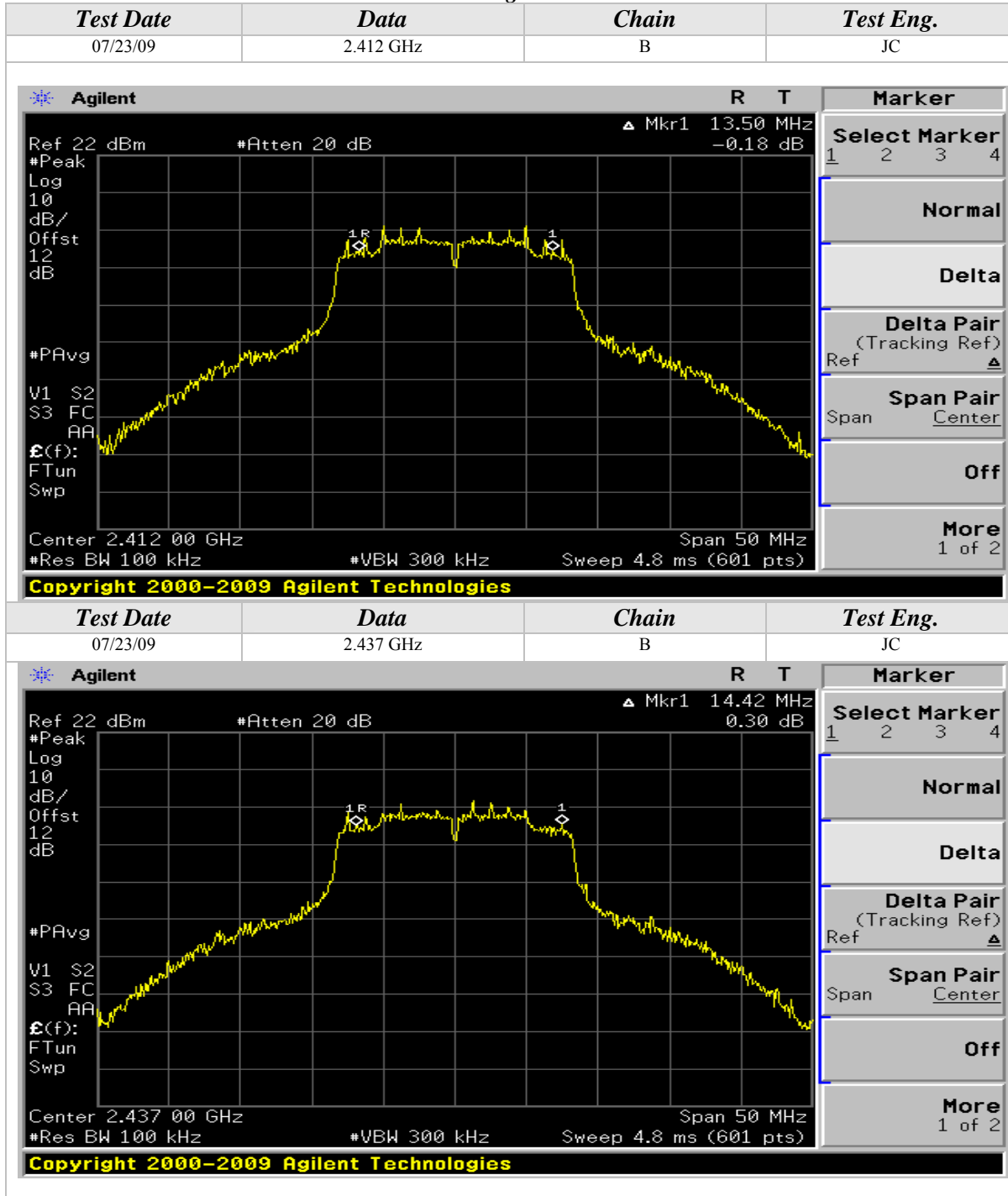

6dB Emissions Bandwidth (Continued)

802.11g Mode

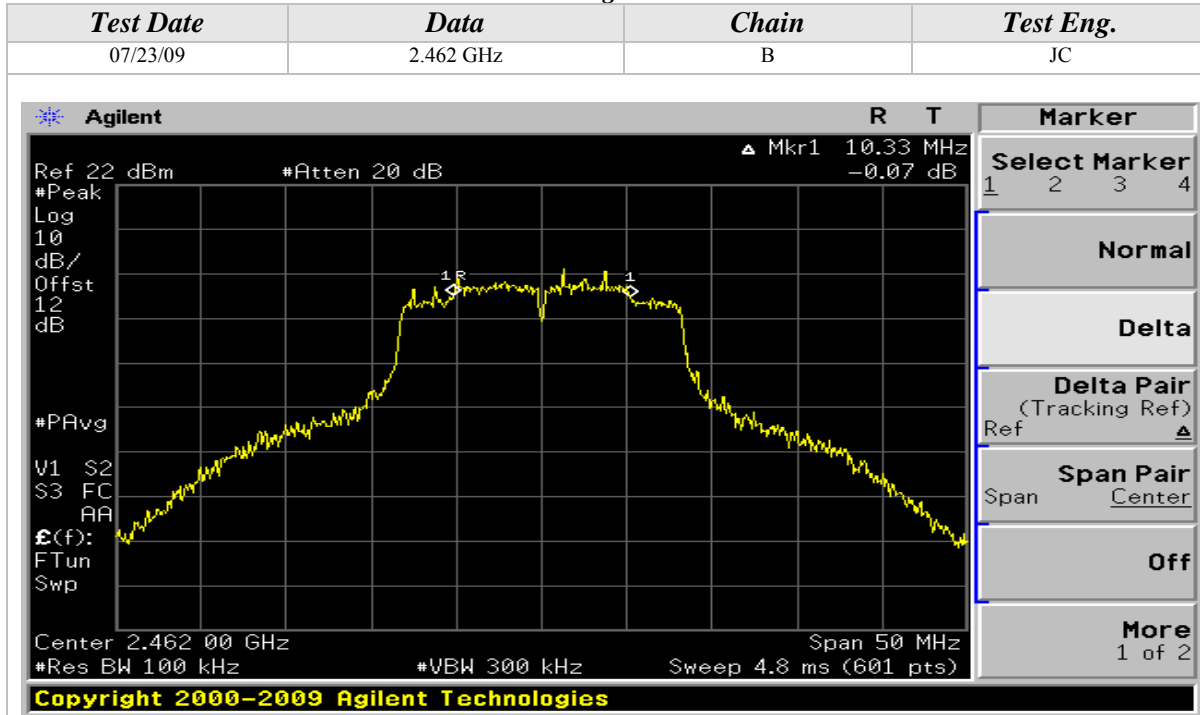

802.11n Mode, 2.4GHz, 20MHz Wide

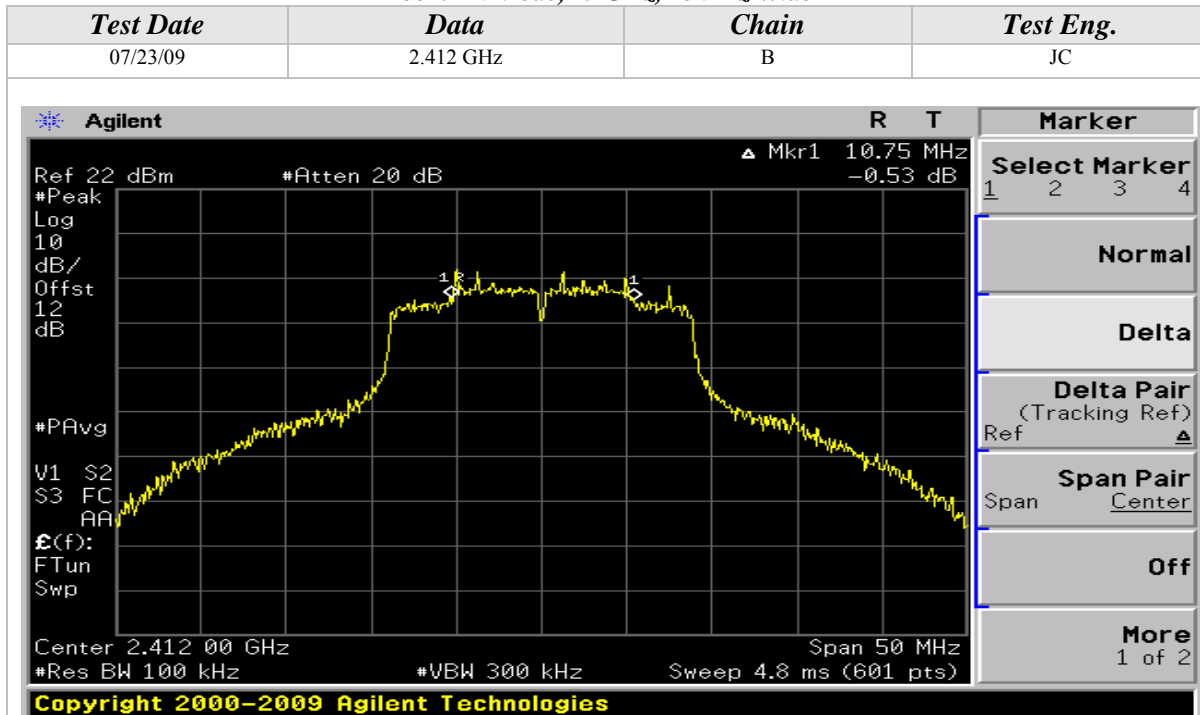

6dB Emissions Bandwidth (Continued)

802.11n Mode, 2.4GHz, 20MHz Wide

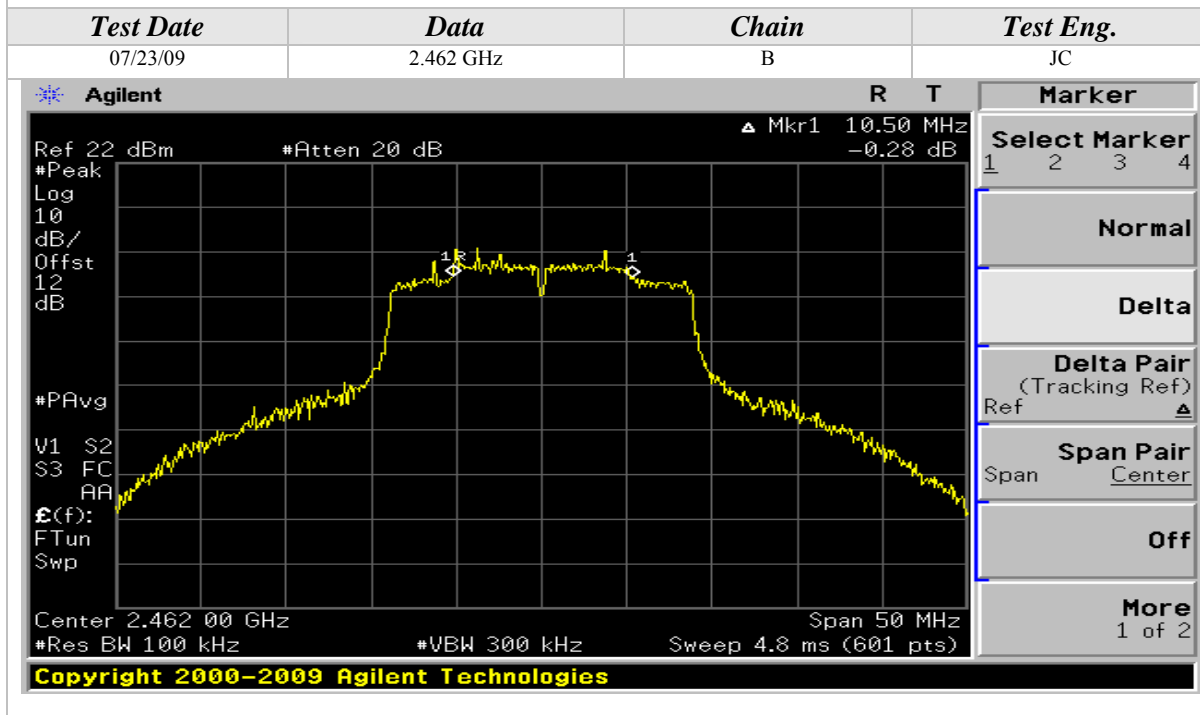
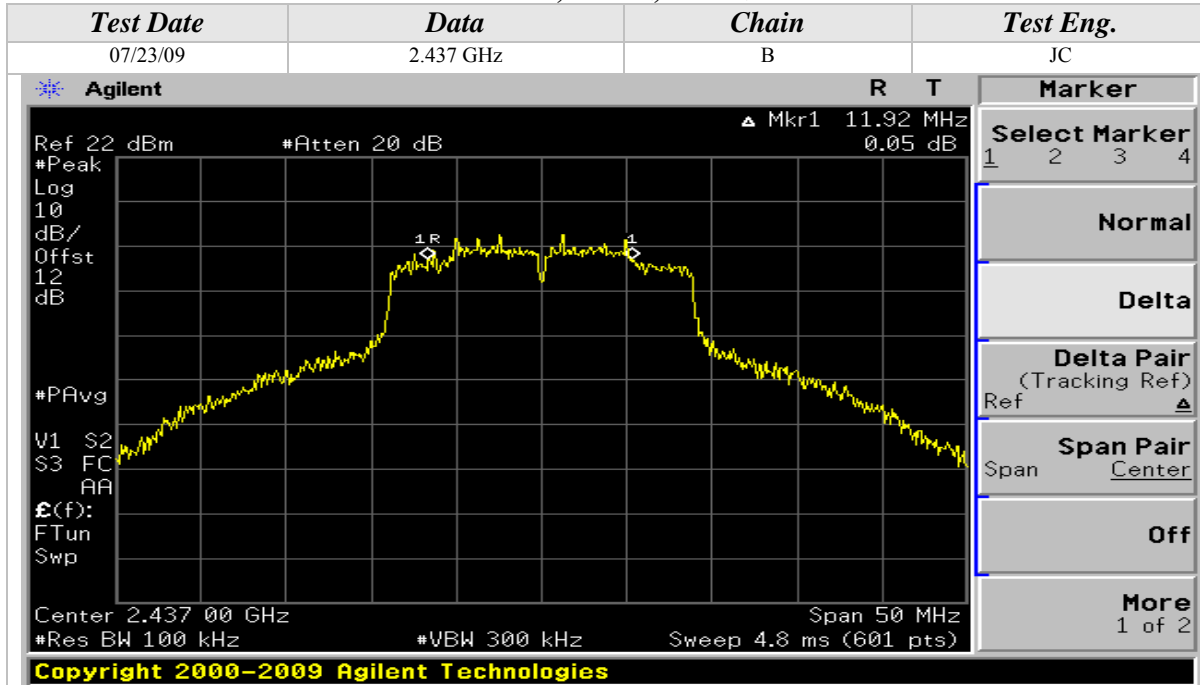

6dB Emissions Bandwidth (Continued)

802.11n Mode, 2.4GHz, 40MHz Wide

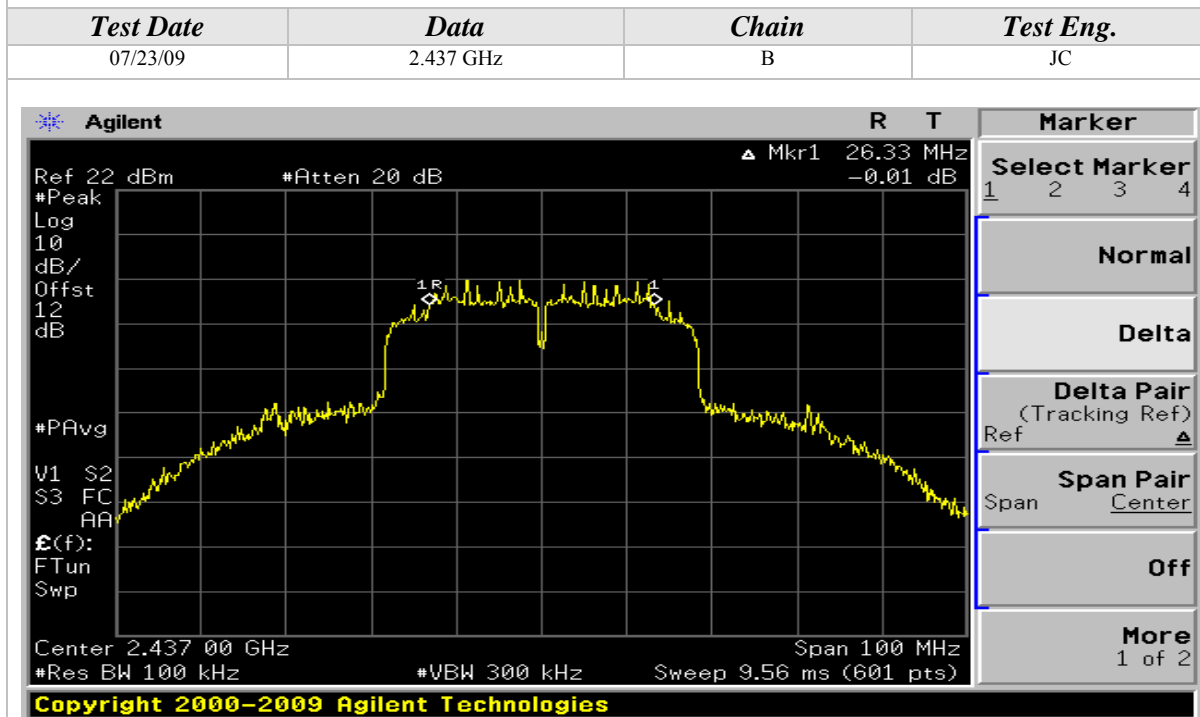
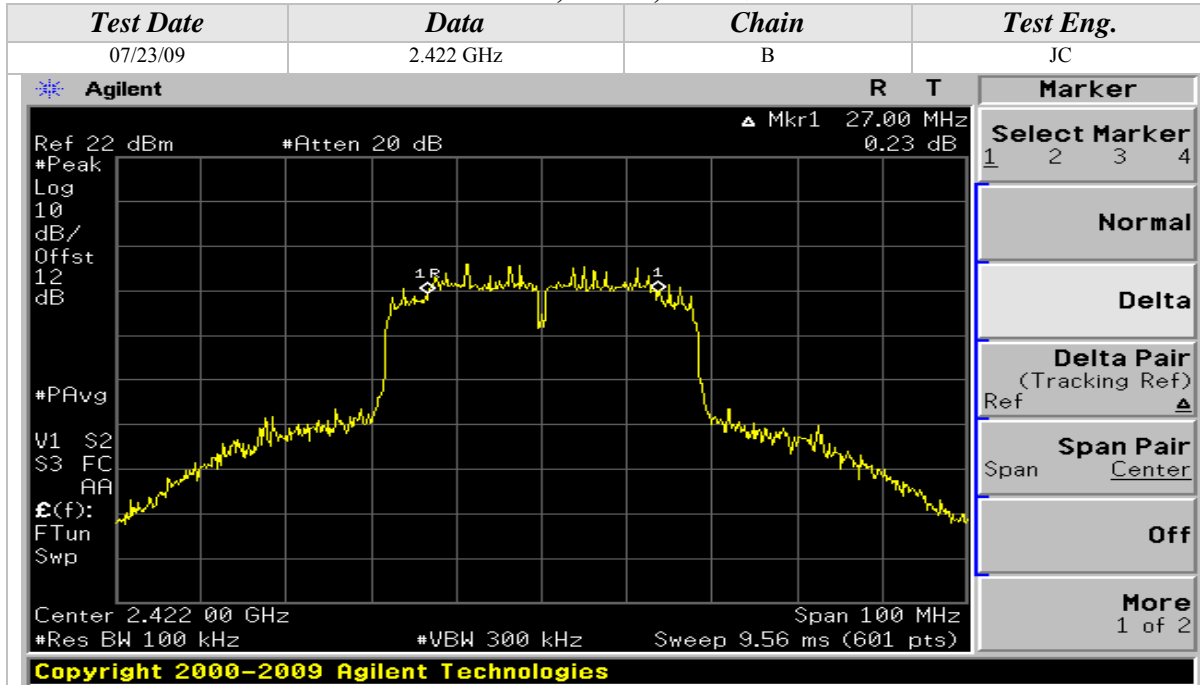

6dB Emissions Bandwidth (Continued)

802.11n Mode, 2.4GHz, 40MHz Wide

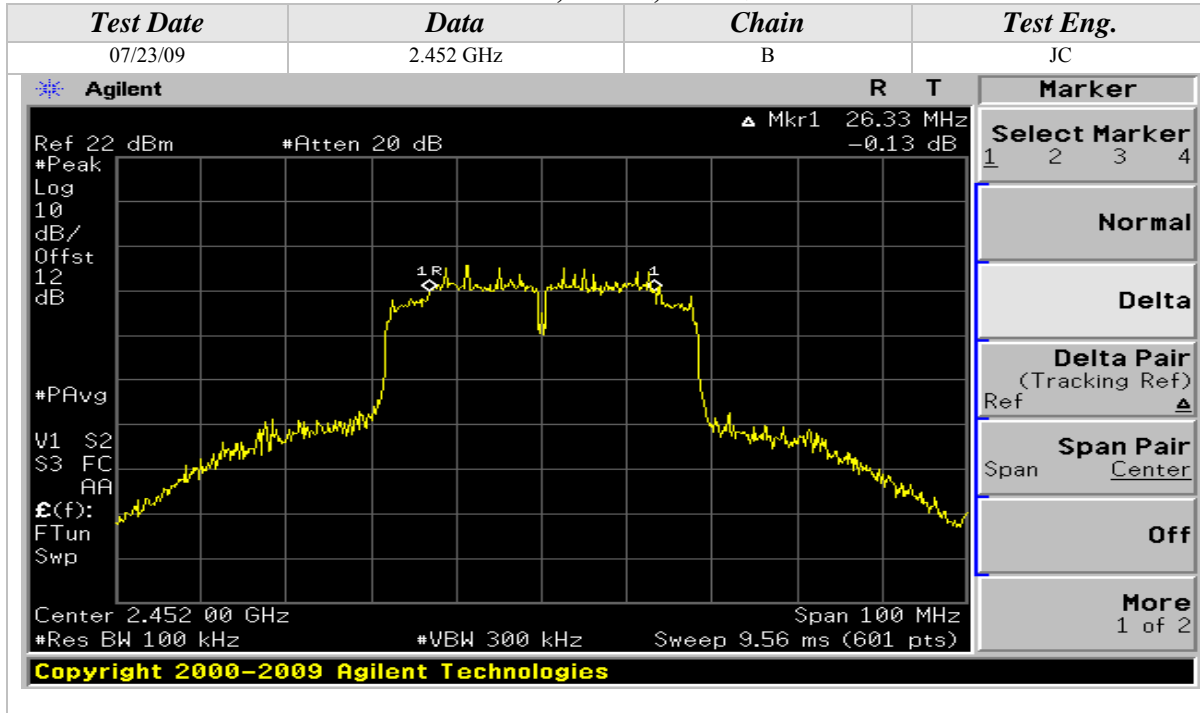

802.11n Mode, 5GHz, 20MHz Wide

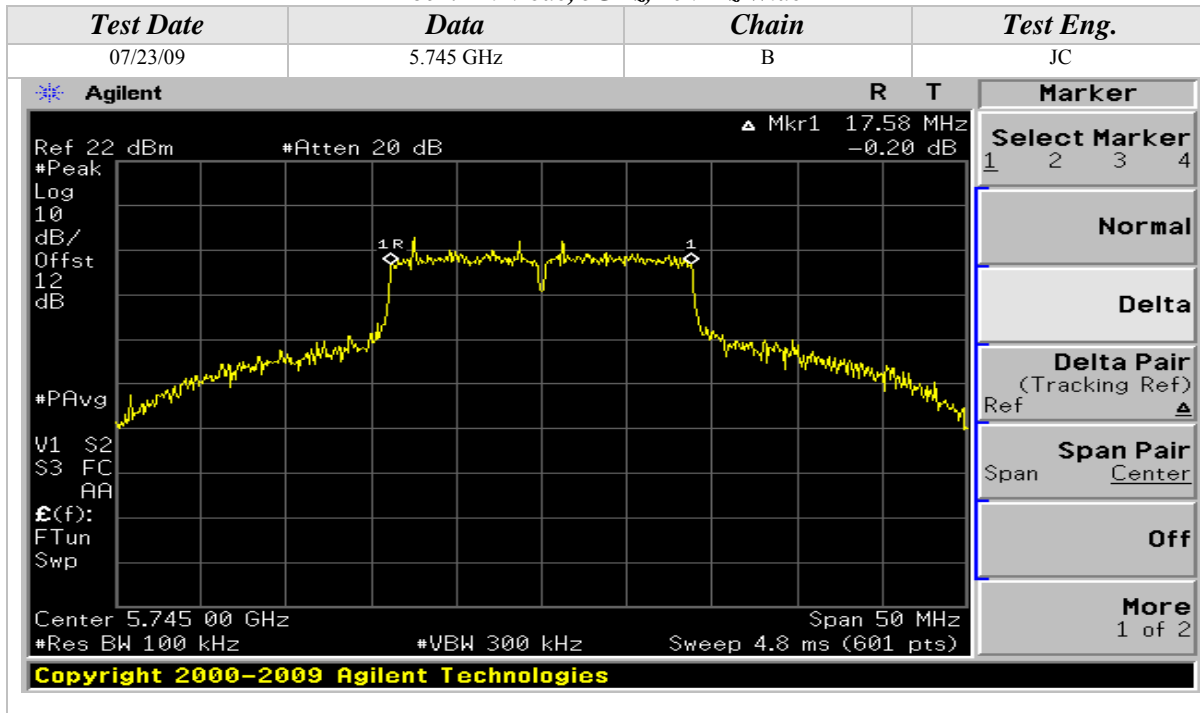

6dB Emissions Bandwidth (Continued)

802.11n Mode, 5GHz, 20MHz Wide

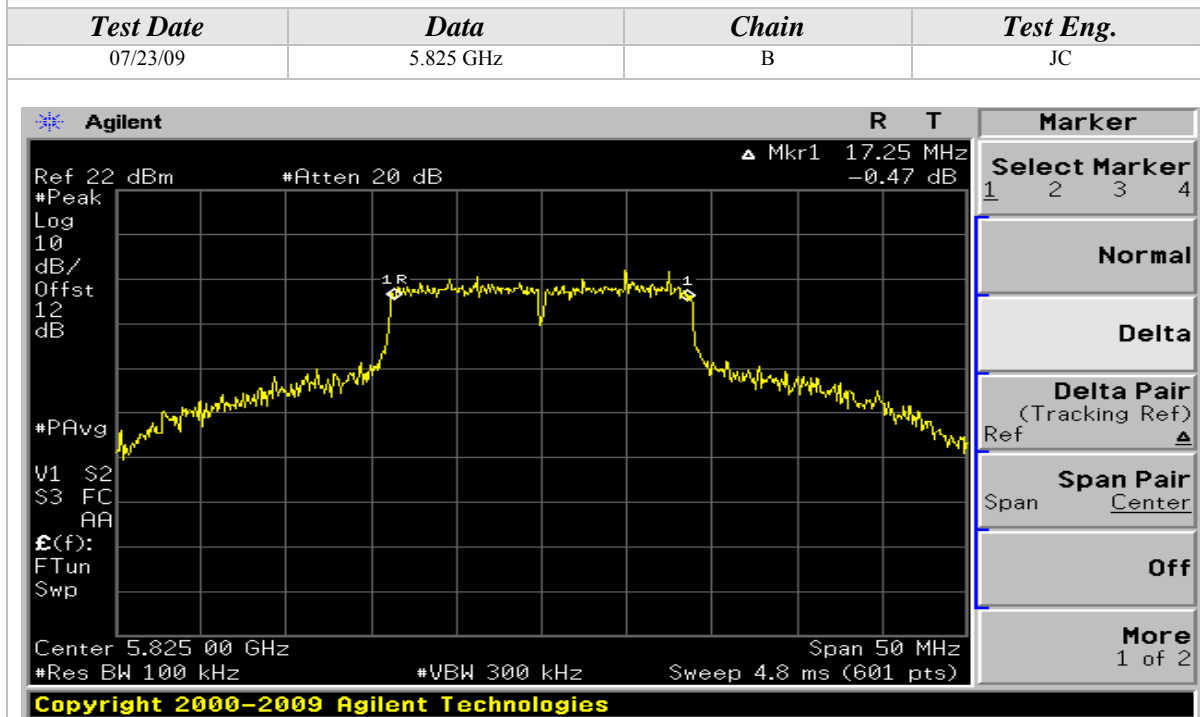
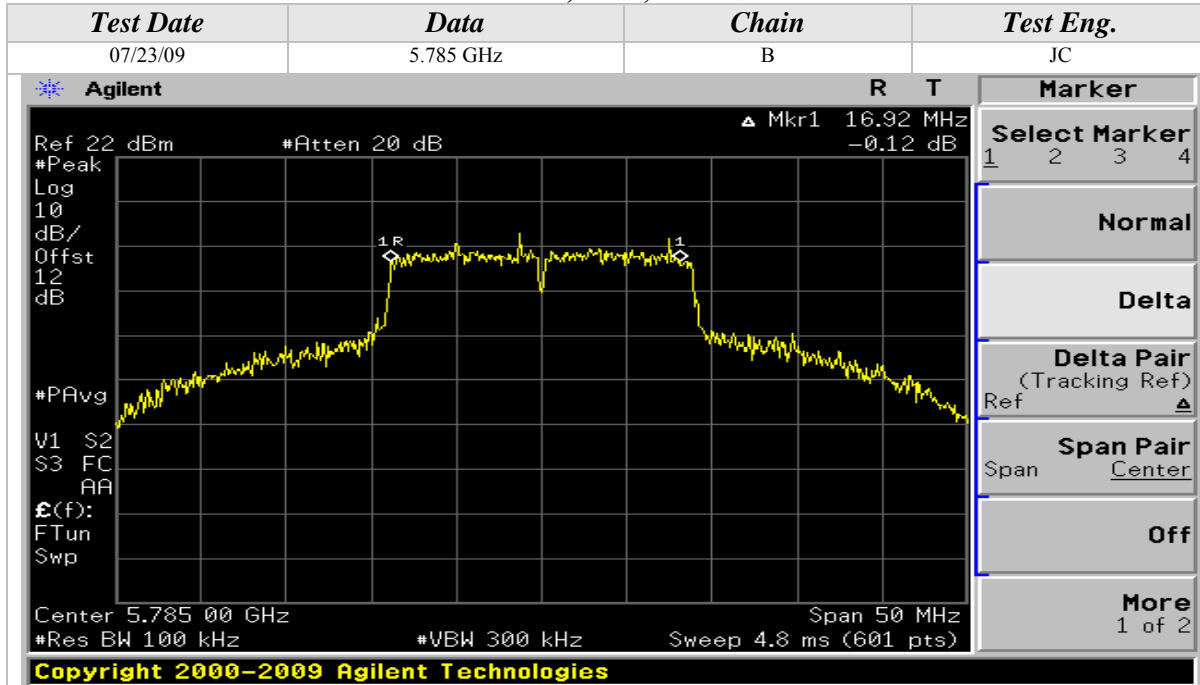

6dB Emissions Bandwidth (Continued)

802.11n Mode, 5GHz, 40MHz Wide

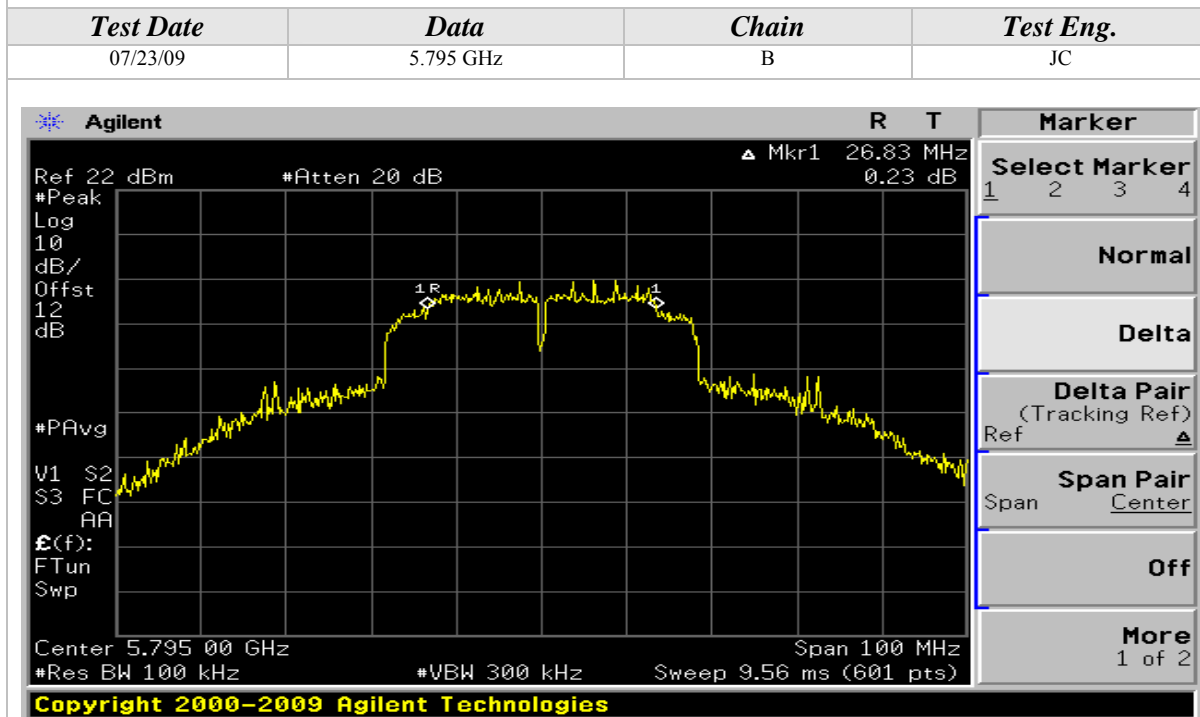
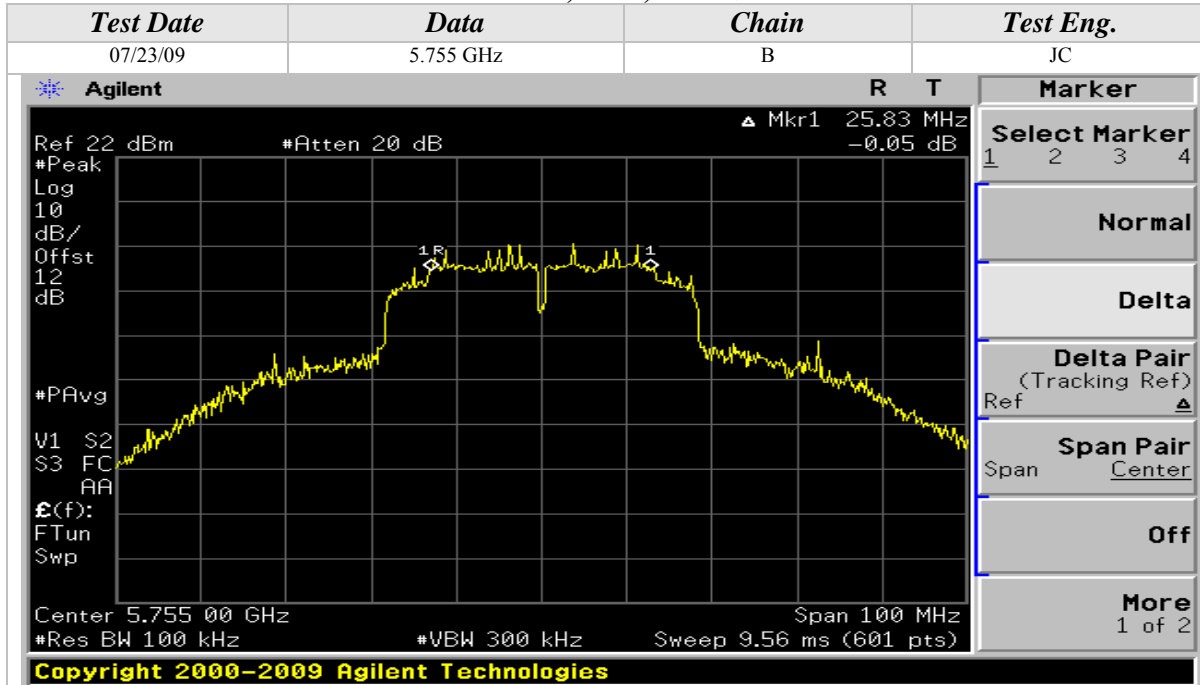

**PEAK POWER SPECTRAL DENSITY**

CLIENT:	Intel Corporation	DATE:	08/12/09
EUT:	Intel WiFi Link 6300	PROJECT NUMBER:	INTEL-090601
MODEL NUMBER:	622ANHMW	TEST ENGINEER:	JC
SERIAL NUMBER:	0015005A3C7C	SITE #:	2
CONFIGURATION:	Tested installed in an extender board connected to the host laptop's mini PCI slot	TEMPERATURE:	23 deg. C
		HUMIDITY:	56% RH
		TIME:	10:30 AM

Description:	The peak power spectral density conducted from the intentional radiator to the antenna shall not be greater than 8 dBm in any 3 kHz band during any time interval of continuous transmission.
Results:	See Data Sheet
Note:	Conducted Emissions Measurements were performed on the EUT with power supply set at the following voltage and frequency. <ul style="list-style-type: none">• 120VAC / 60 Hz.

Peak Power Spectral Density Limits	
Frequency (MHz)	Limit (dBm)
5725-5850	8
2412-2462	8

Peak Power Spectral Density (Continued)

802.11a Mode

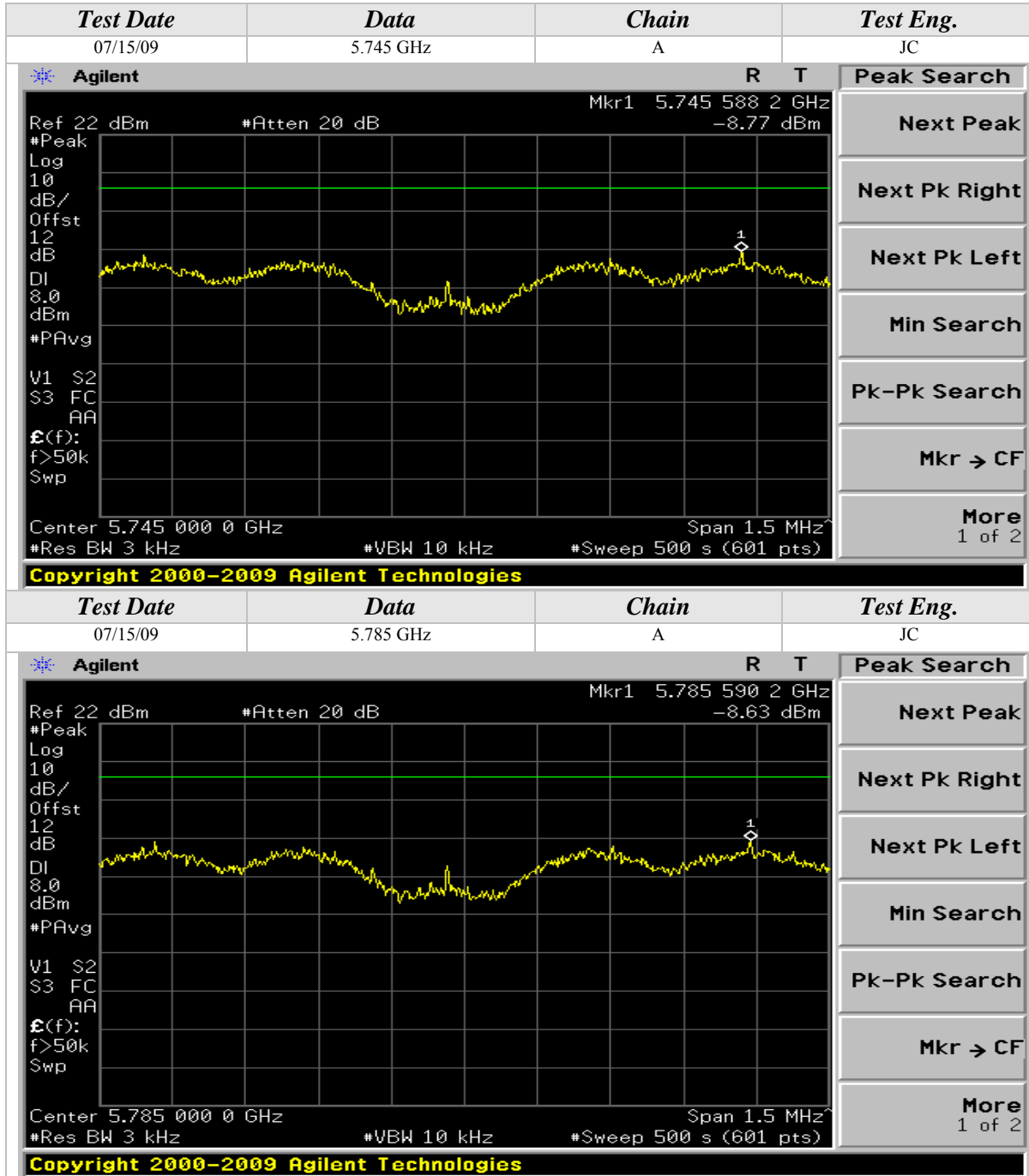

Peak Power Spectral Density (Continued)

802.11a Mode

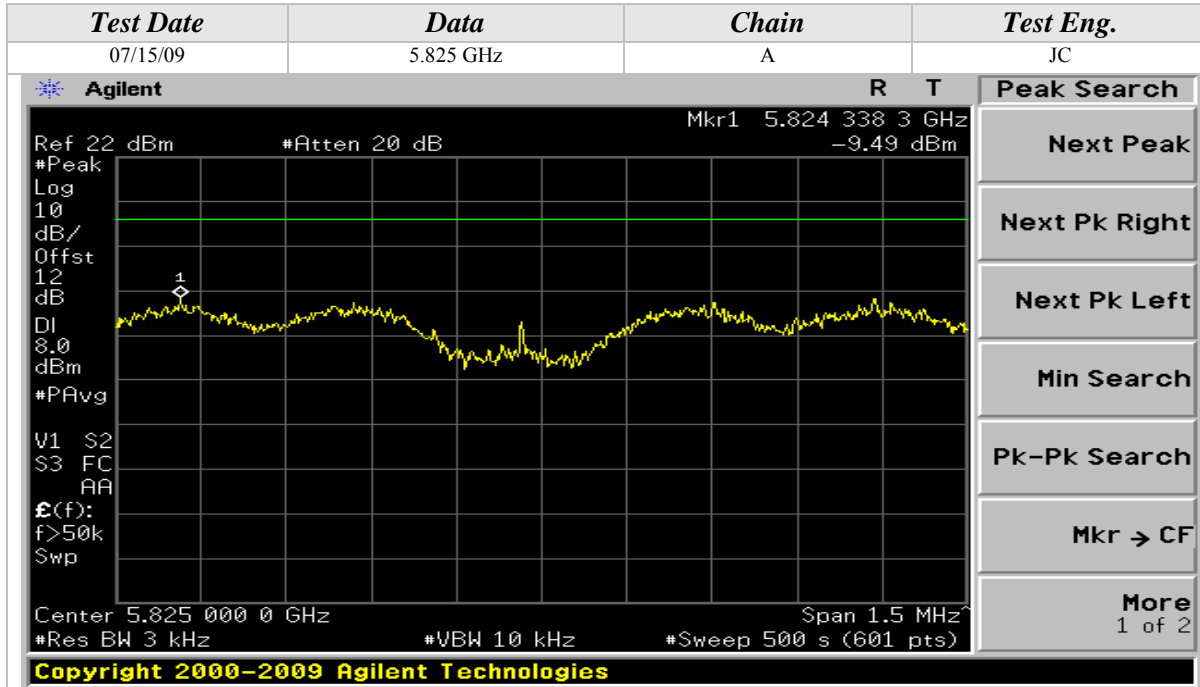

802.11b Mode

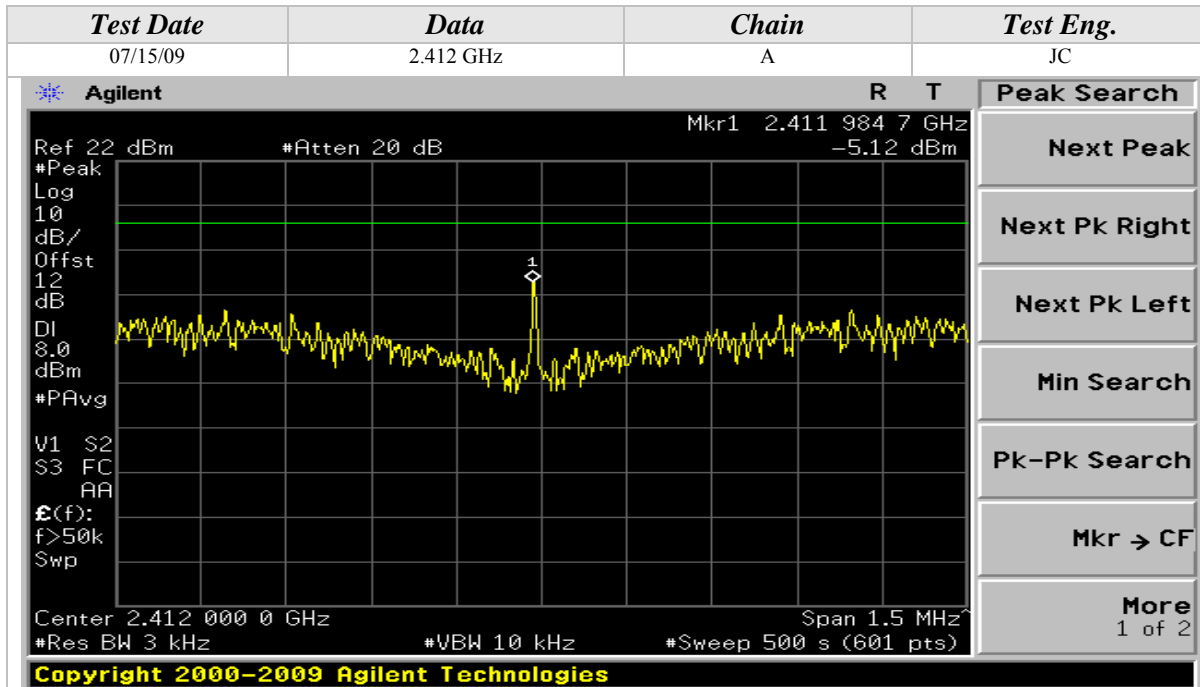

Peak Power Spectral Density (Continued)

802.11b Mode

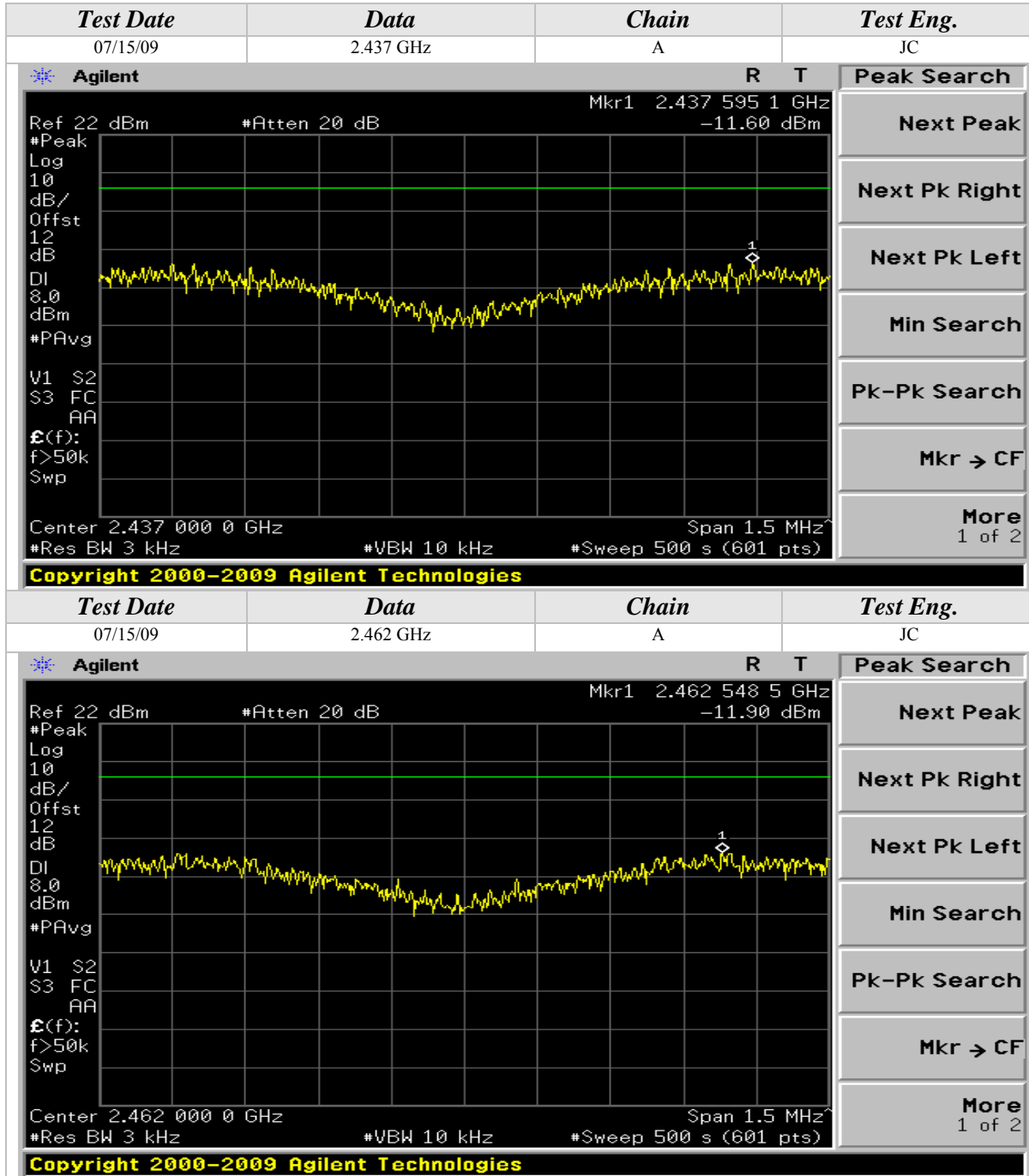

Peak Power Spectral Density (Continued)

802.11g Mode

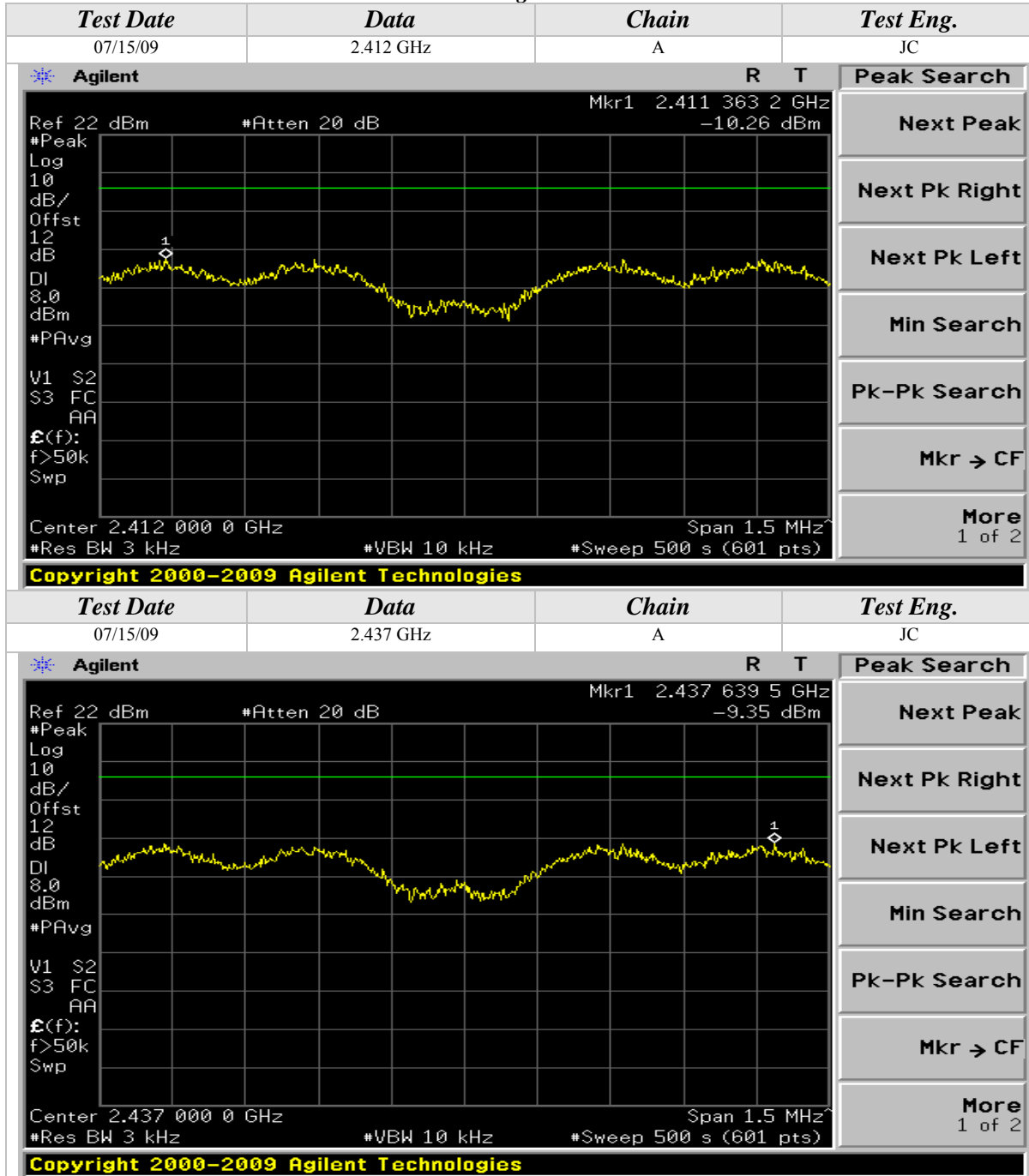

Peak Power Spectral Density (Continued)

802.11g Mode

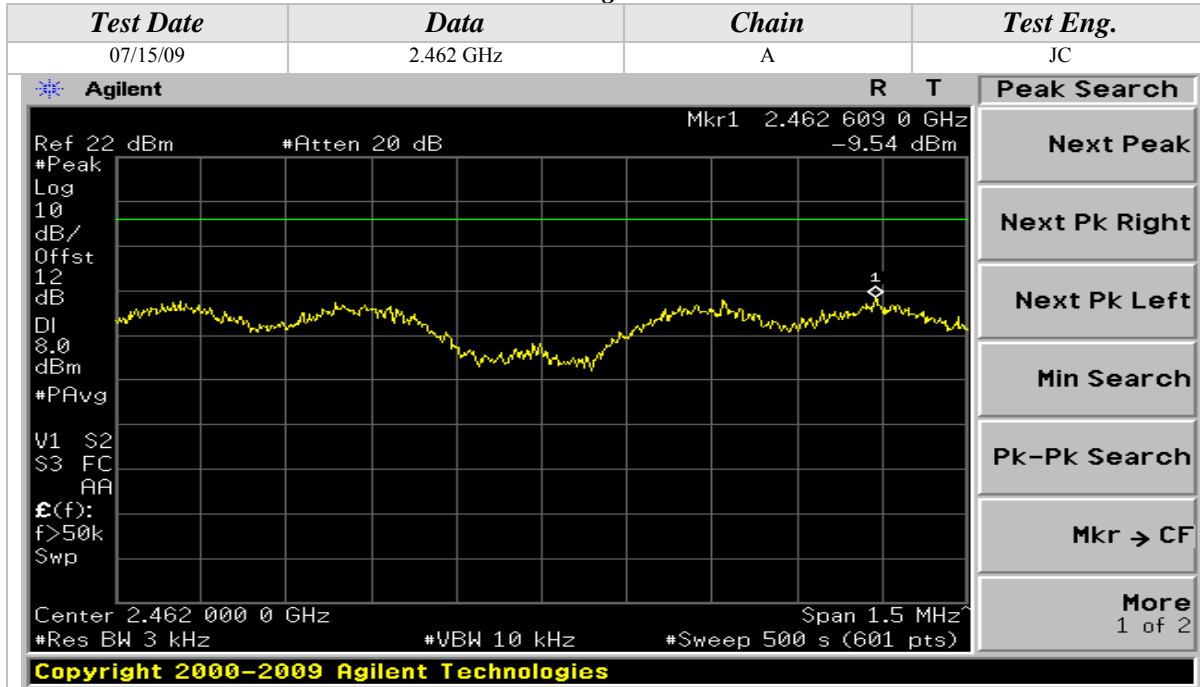

802.11n Mode, 2.4GHz, 20MHz Wide

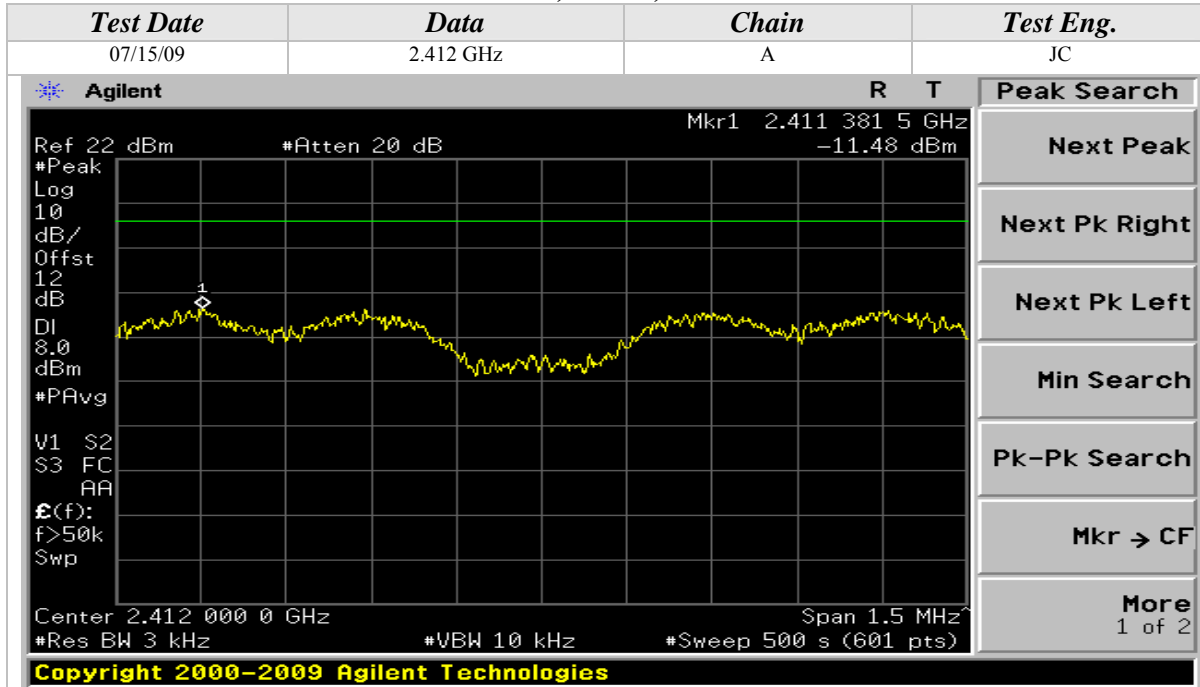

Peak Power Spectral Density (Continued)

802.11n Mode, 2.4GHz, 20MHz Wide

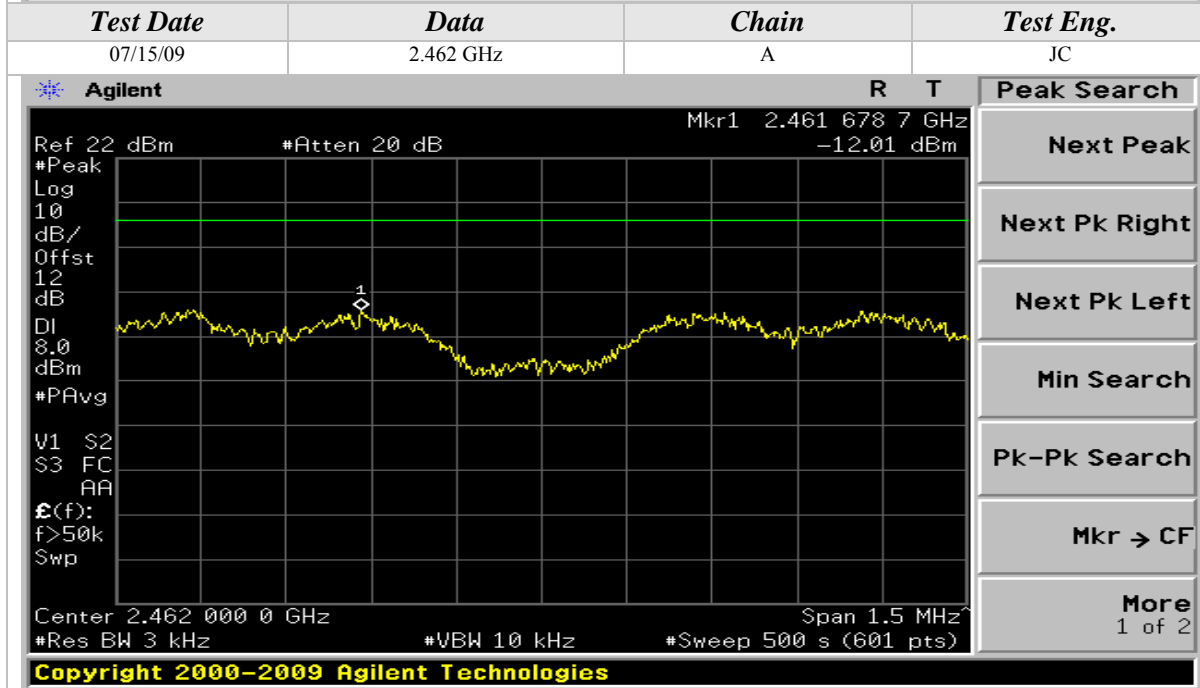
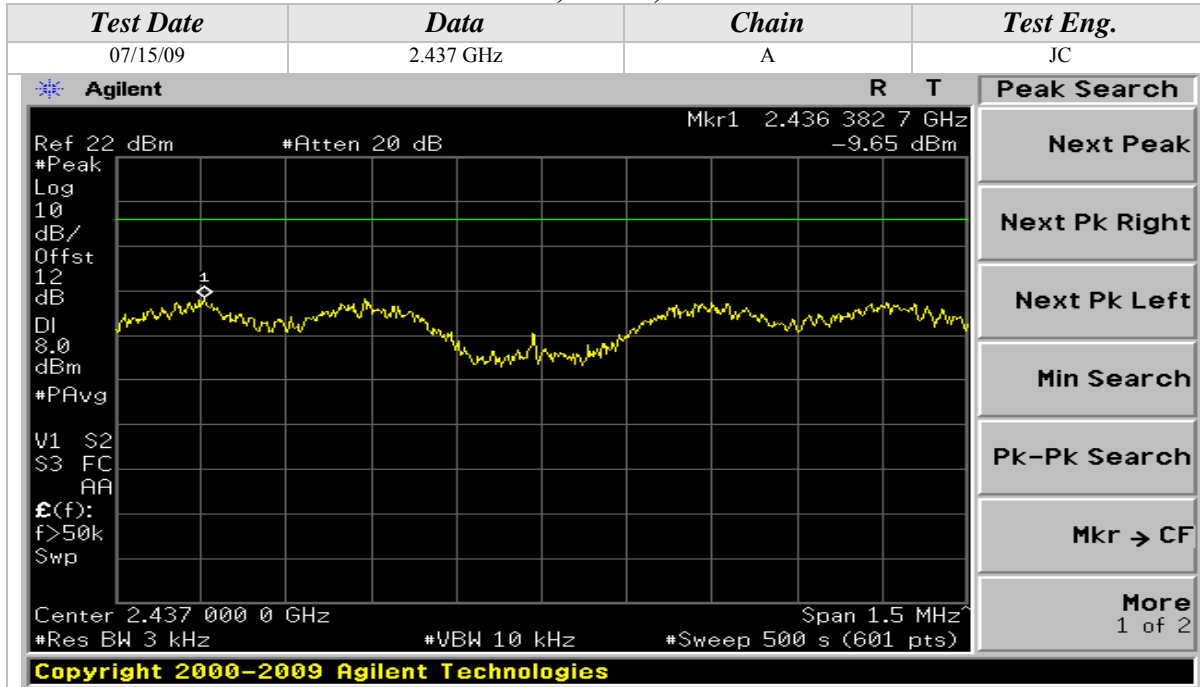

Peak Power Spectral Density (Continued)

802.11n Mode, 2.4GHz, 40MHz Wide

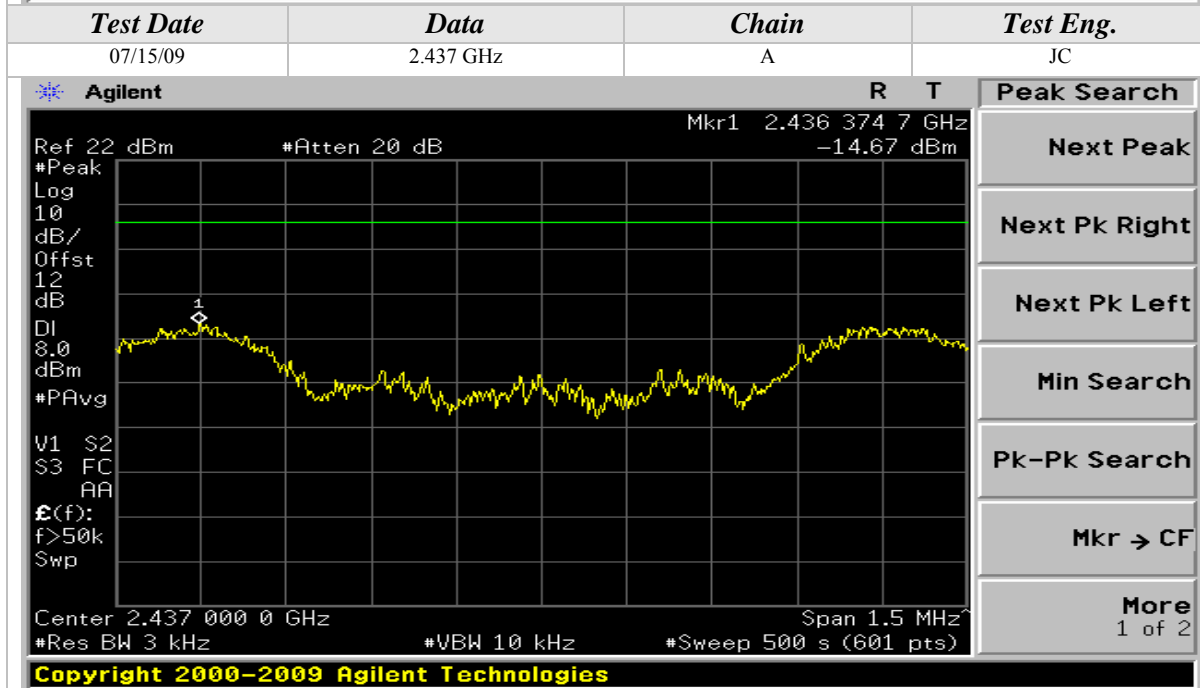
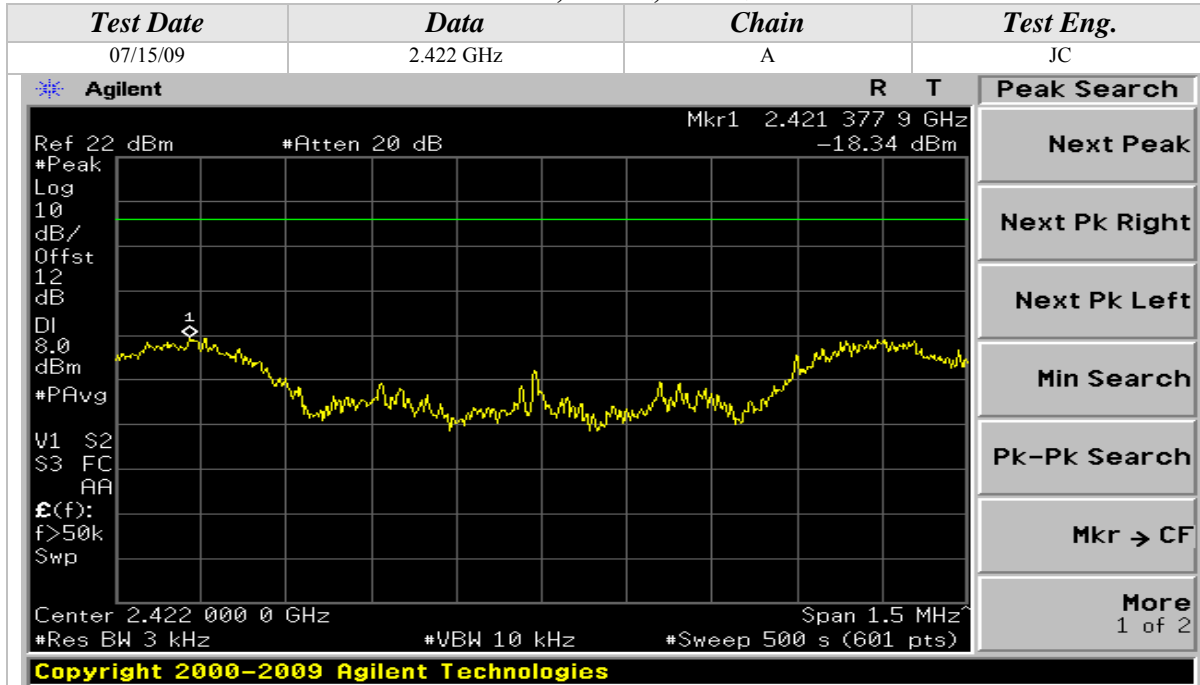

Peak Power Spectral Density (Continued)

802.11n Mode, 2.4GHz, 40MHz Wide

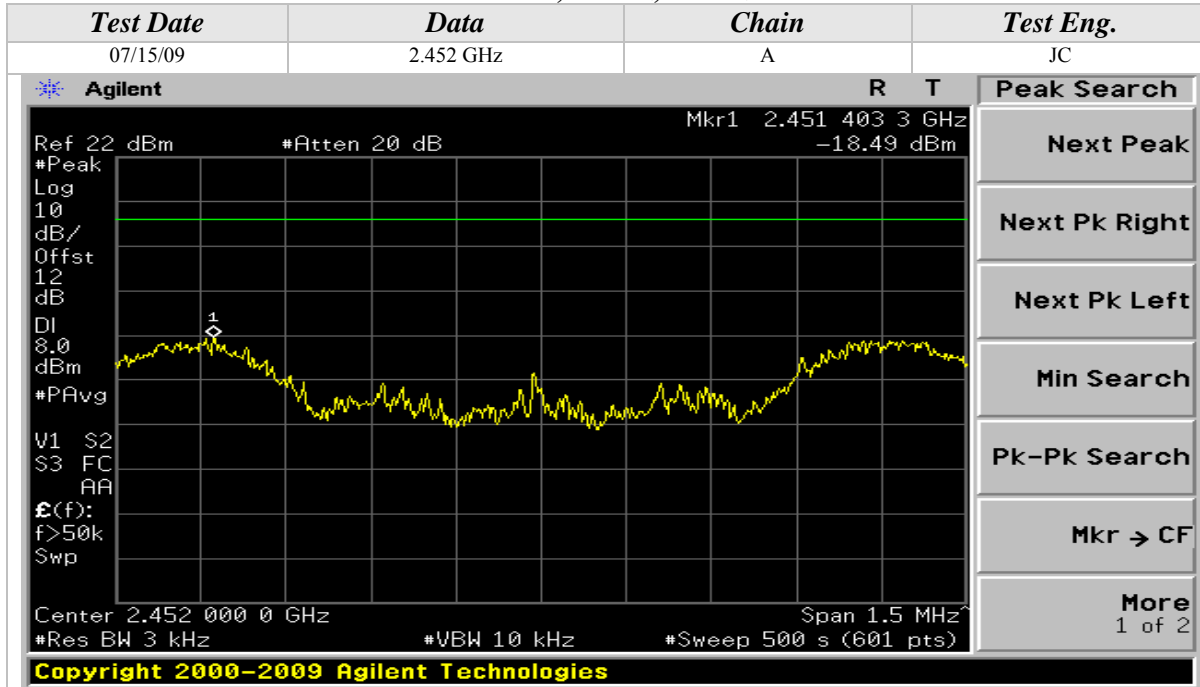

802.11n Mode, 5GHz, 20MHz Wide

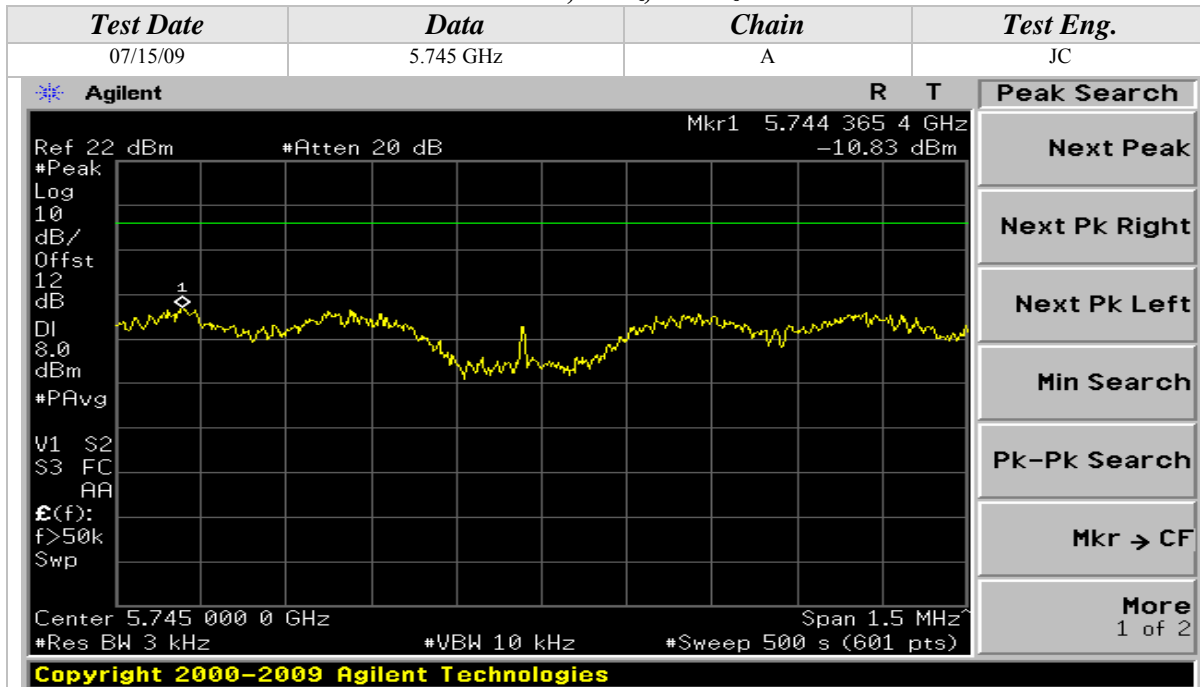

Peak Power Spectral Density (Continued)

802.11n Mode, 5GHz, 20MHz Wide

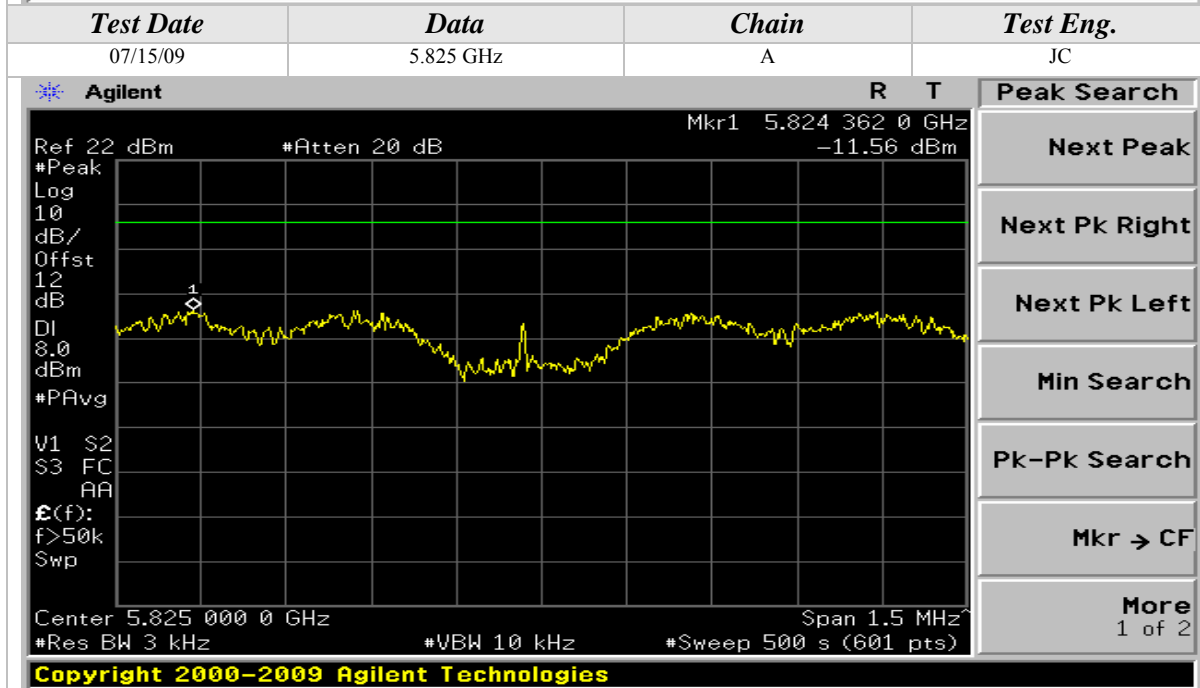
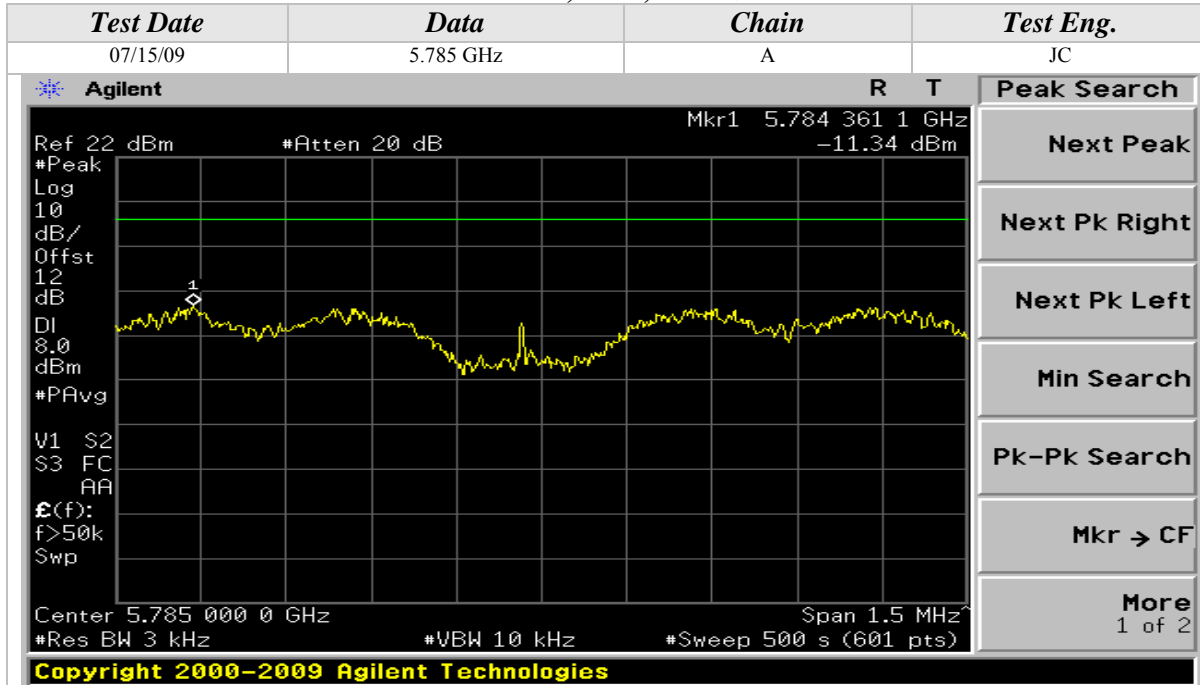

Peak Power Spectral Density (Continued)

802.11n Mode, 5GHz, 40MHz Wide

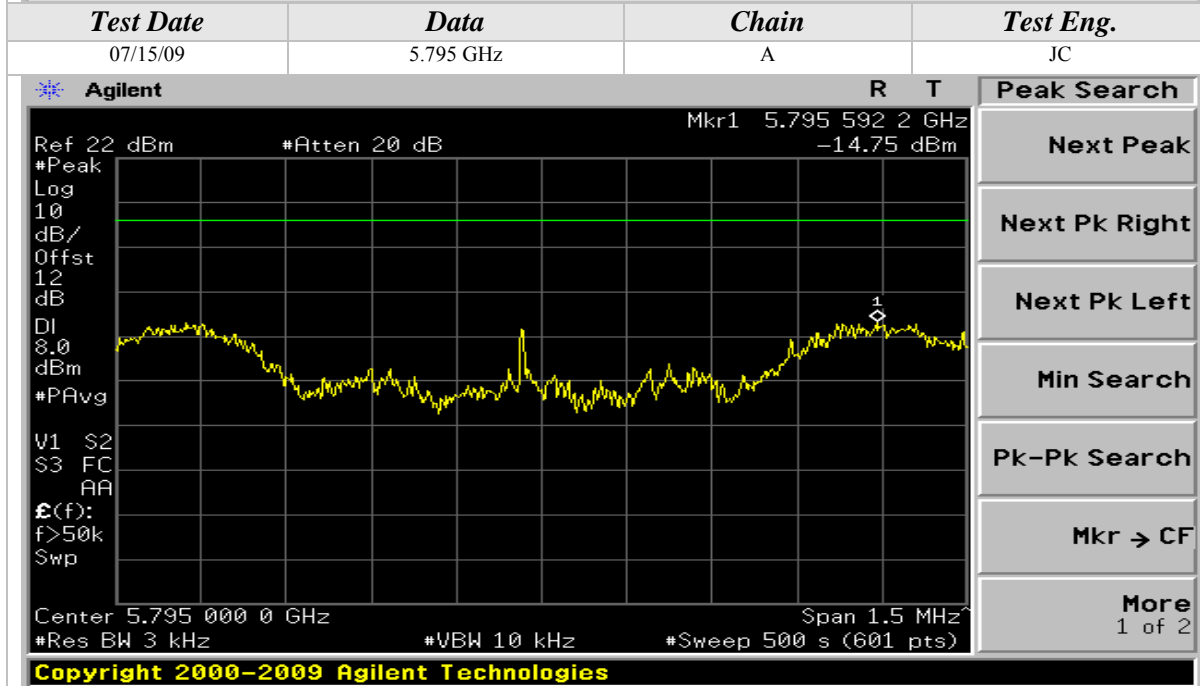
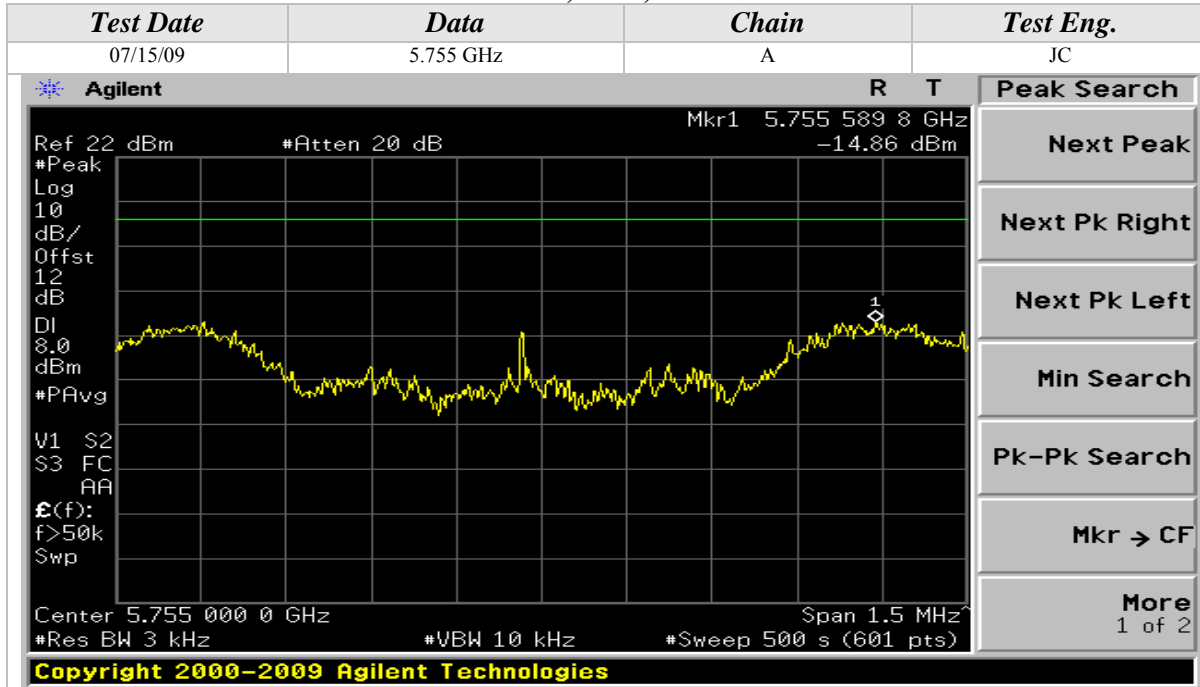

Peak Power Spectral Density (Continued)

802.11a Mode

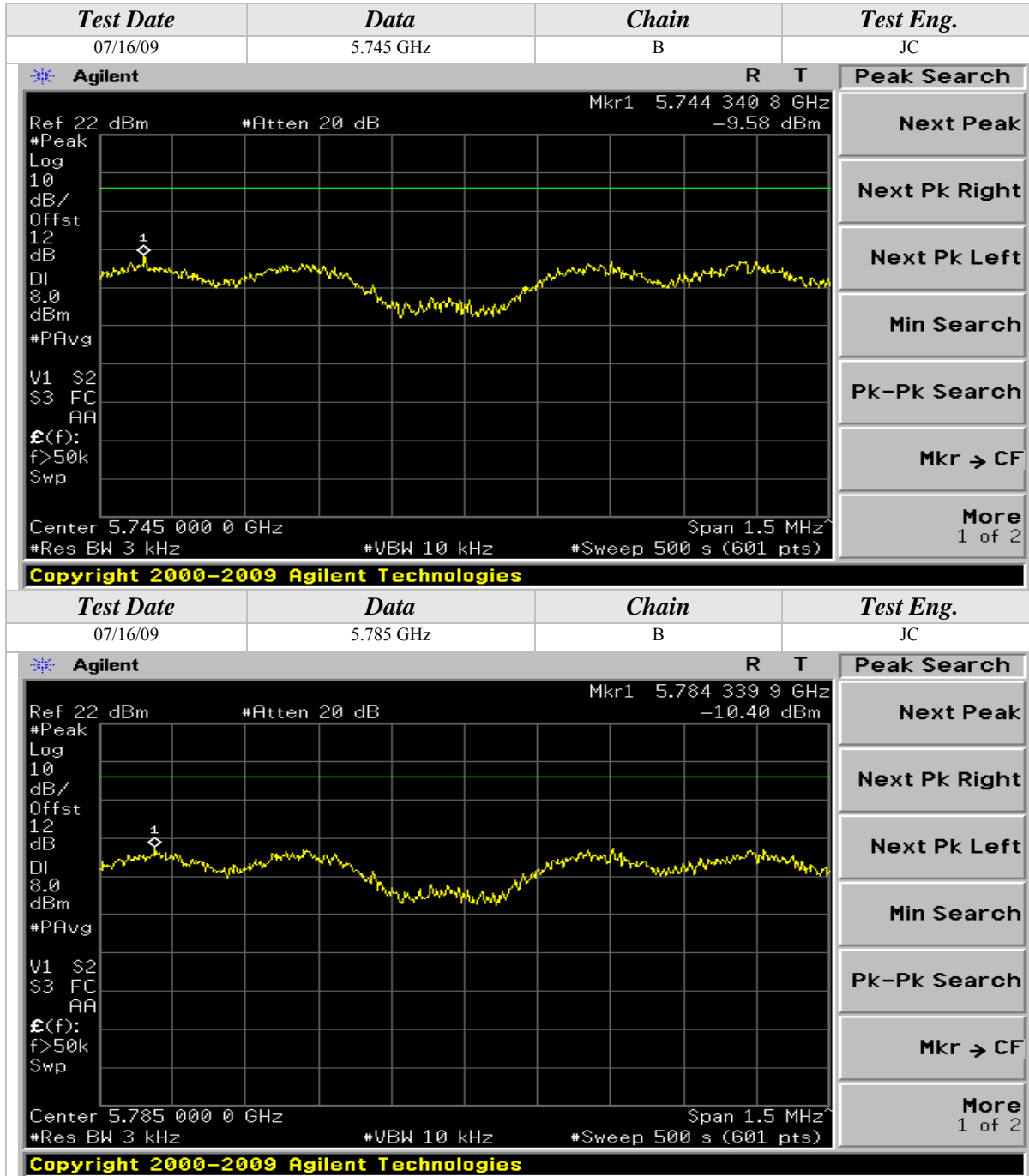

Peak Power Spectral Density (Continued)

802.11a Mode

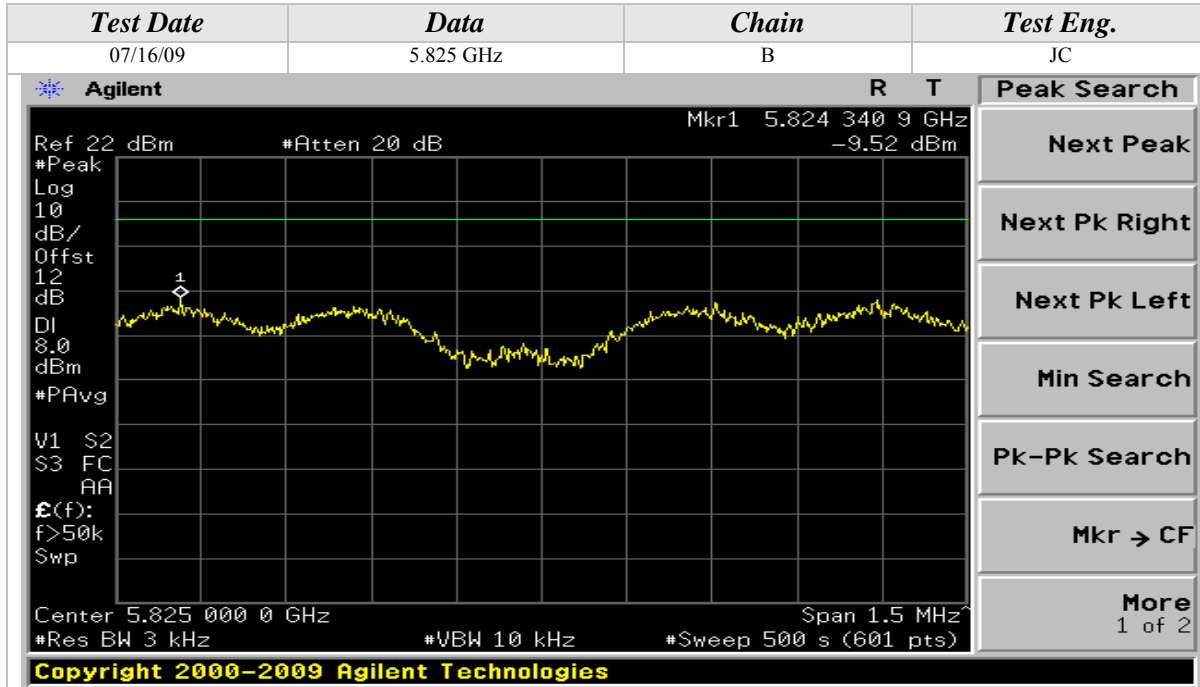

802.11b Mode

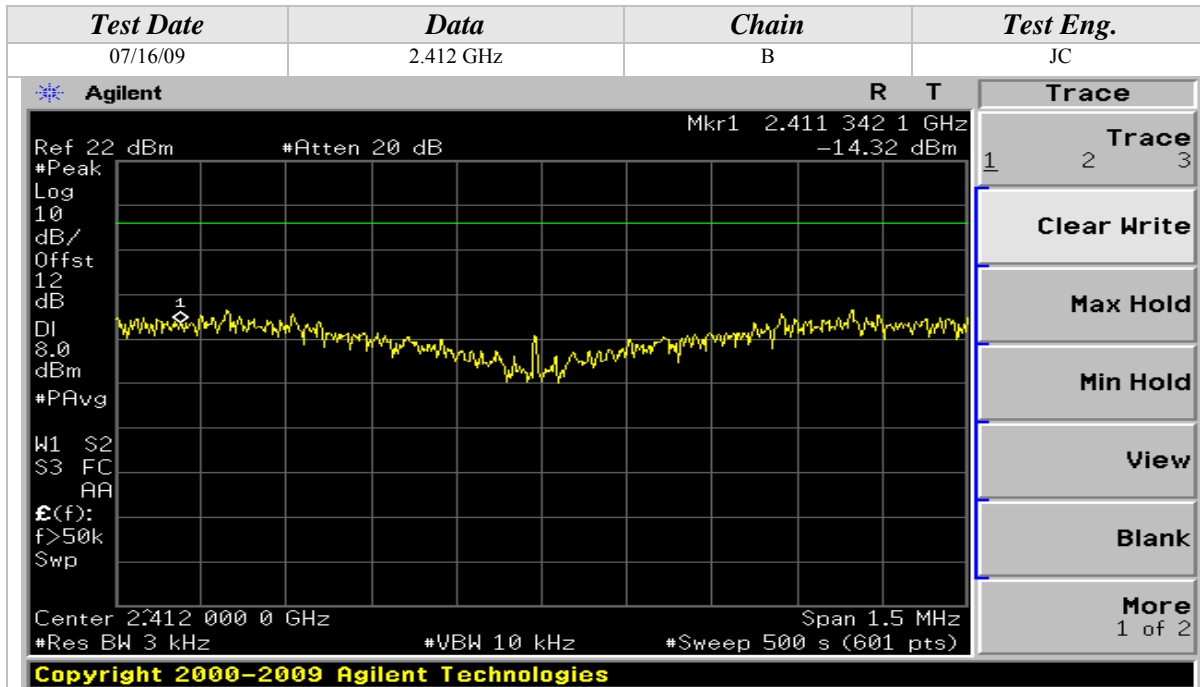

Peak Power Spectral Density (Continued)

802.11b Mode

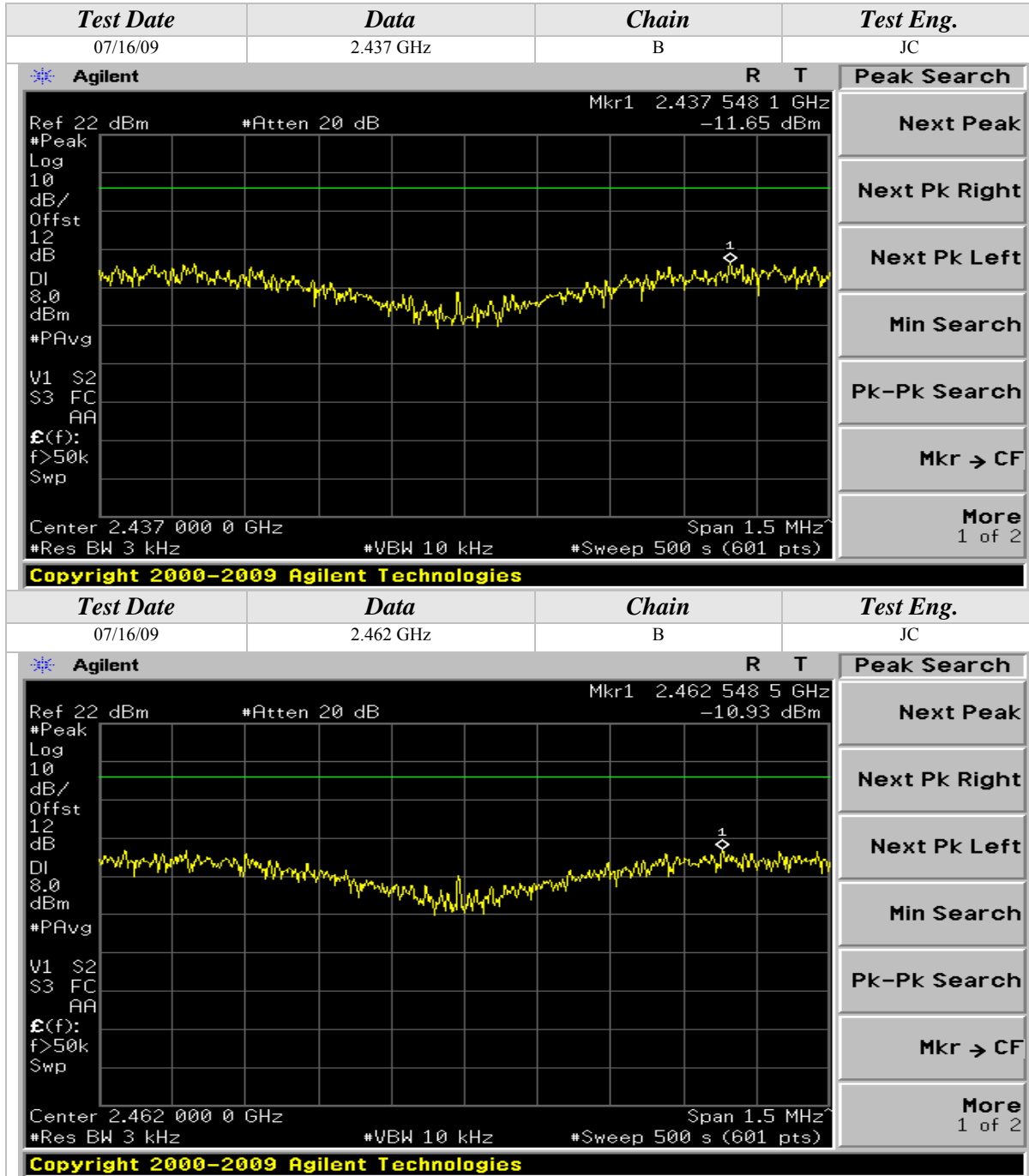

Peak Power Spectral Density (Continued)

802.11g Mode

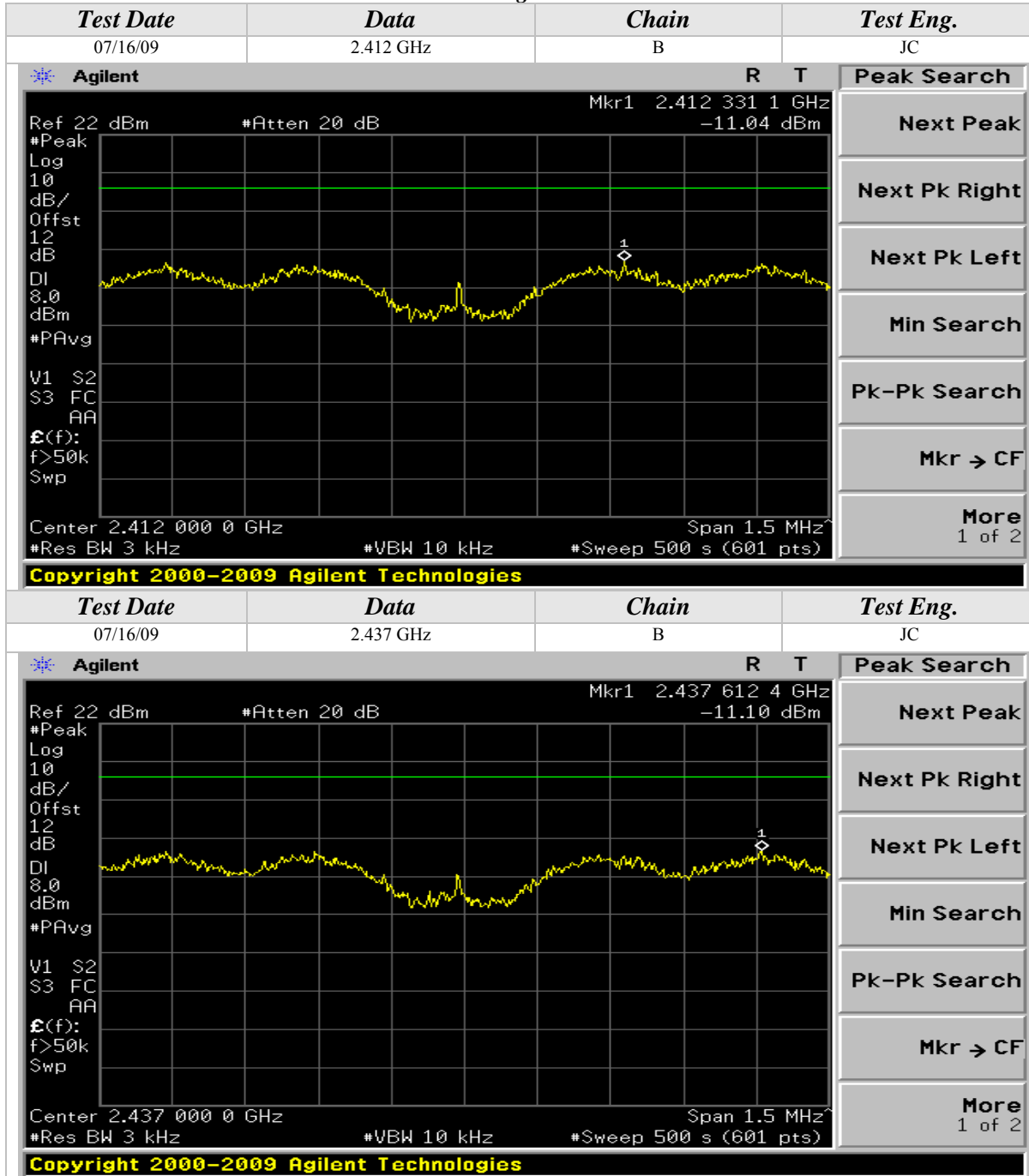

Peak Power Spectral Density (Continued)

802.11g Mode

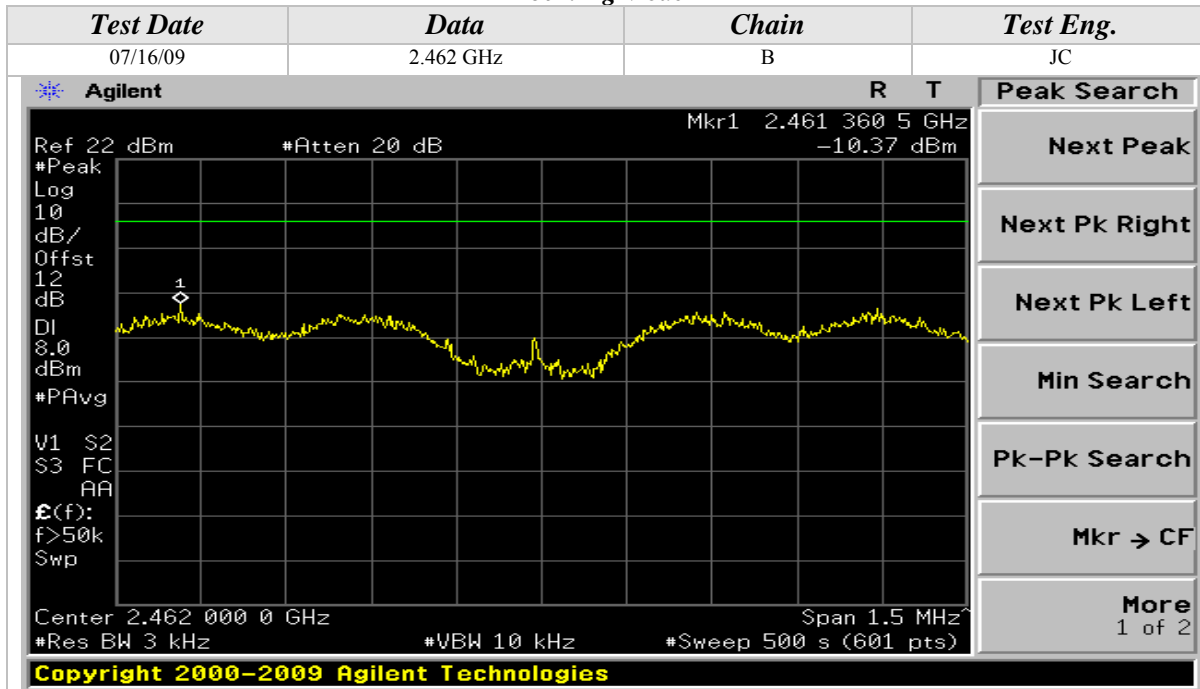

802.11n Mode, 2.4GHz, 20MHz Wide

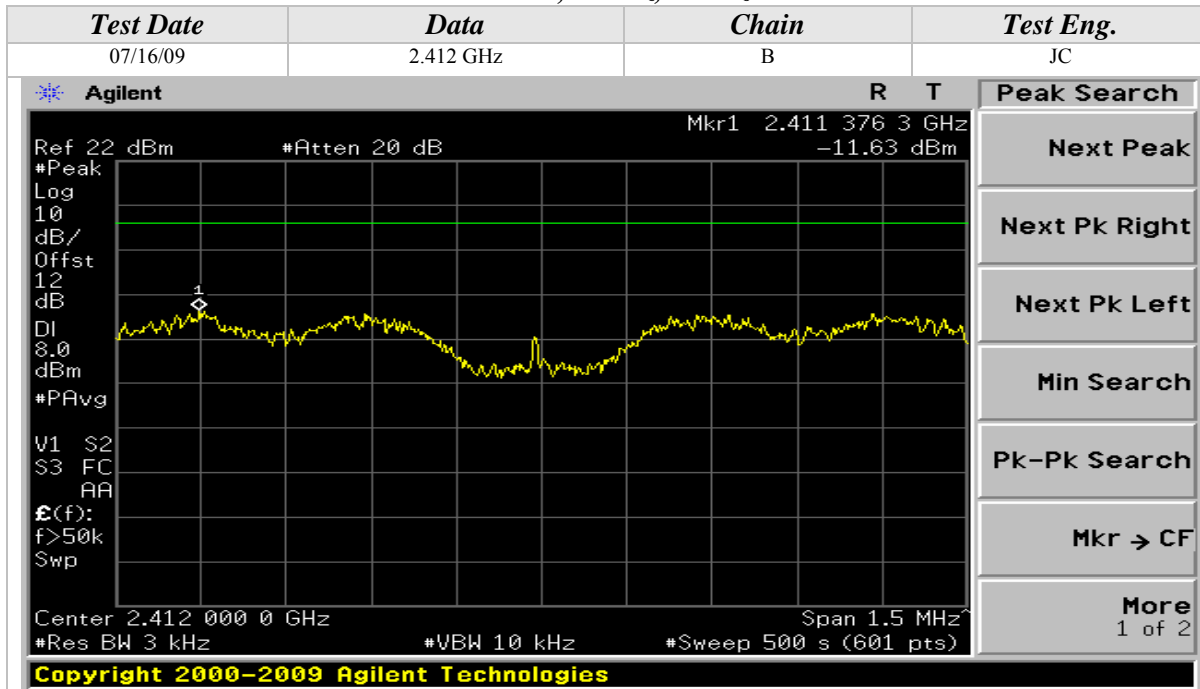



Peak Power Spectral Density (Continued)

802.11n Mode, 2.4GHz, 20MHz Wide

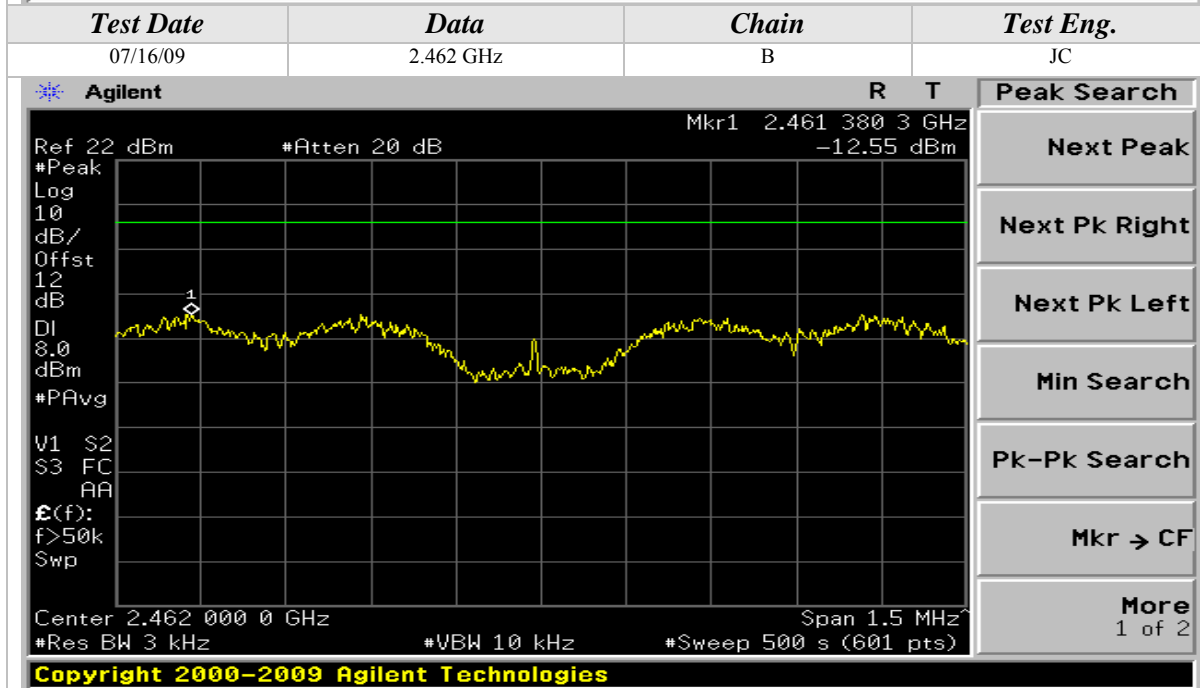
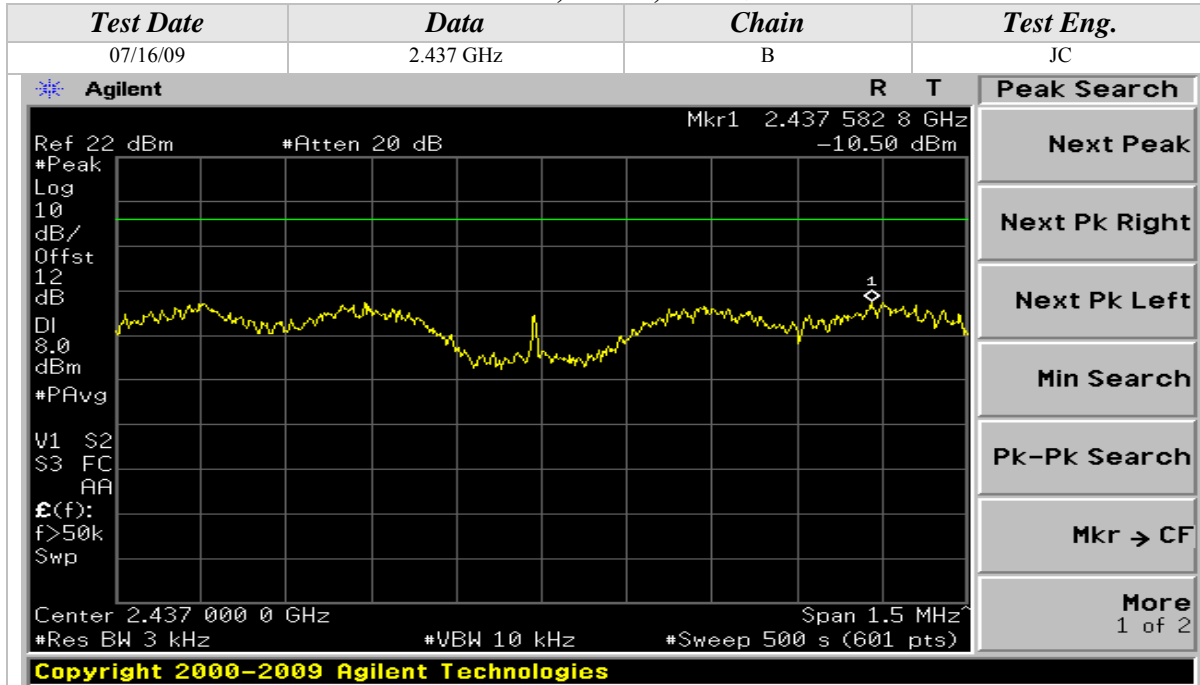

Peak Power Spectral Density (Continued)

802.11n Mode, 2.4GHz, 40MHz Wide

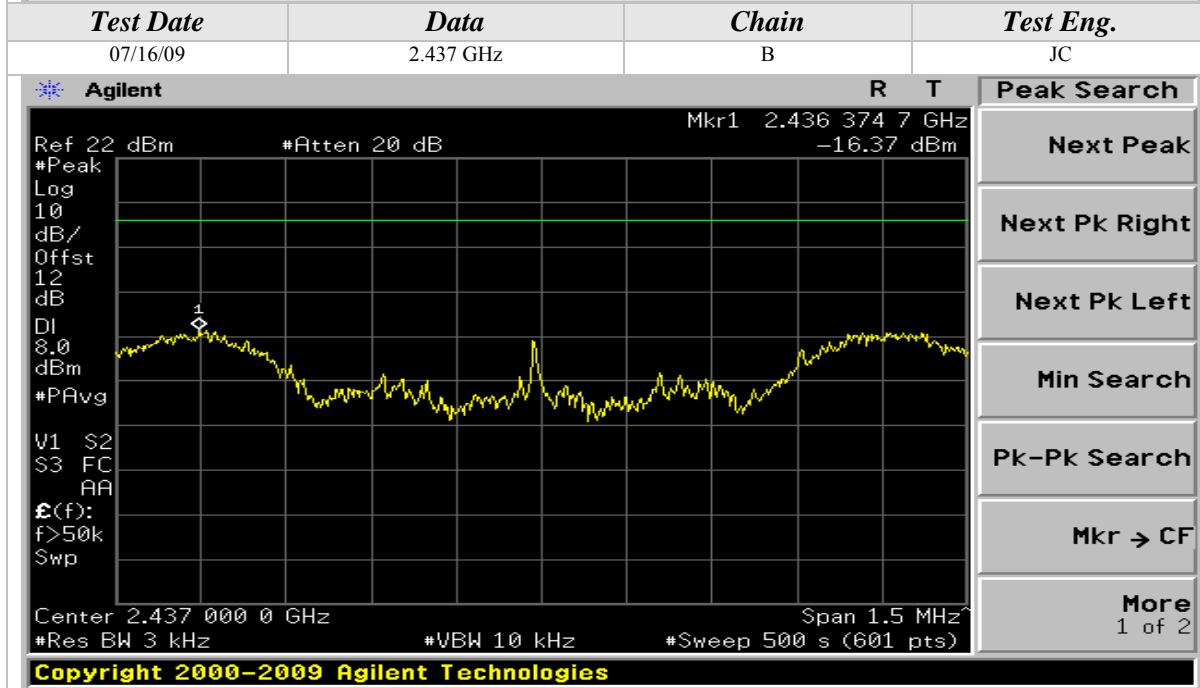
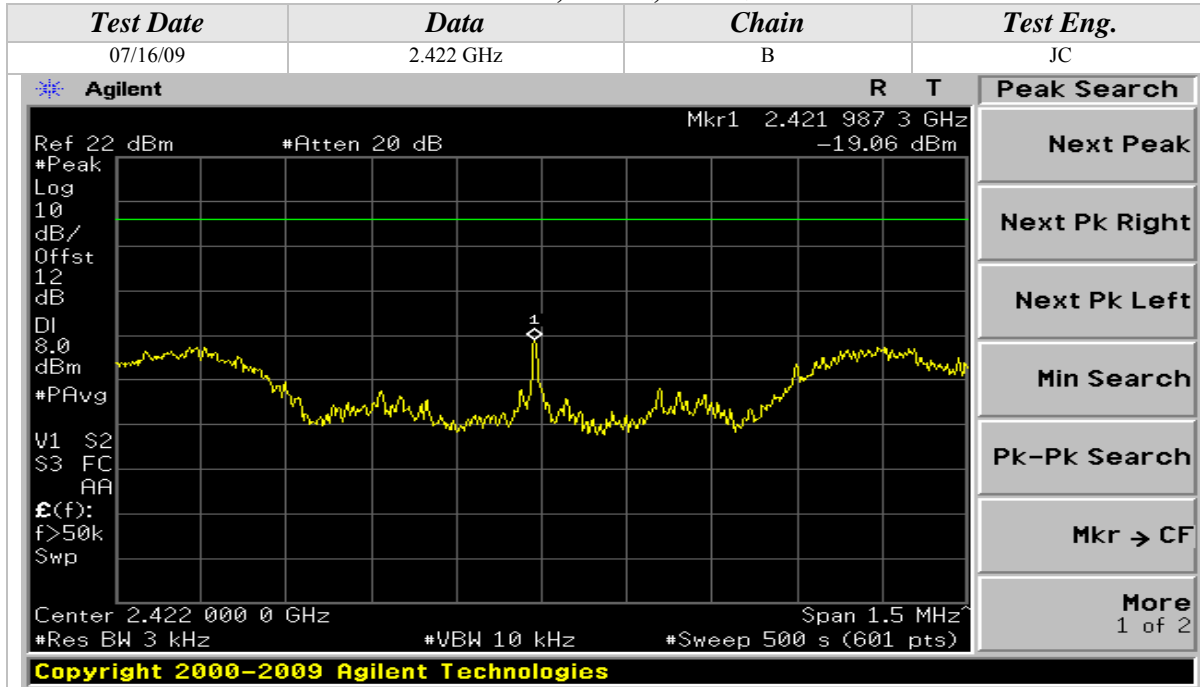

Peak Power Spectral Density (Continued)

802.11n Mode, 2.4GHz, 40MHz Wide

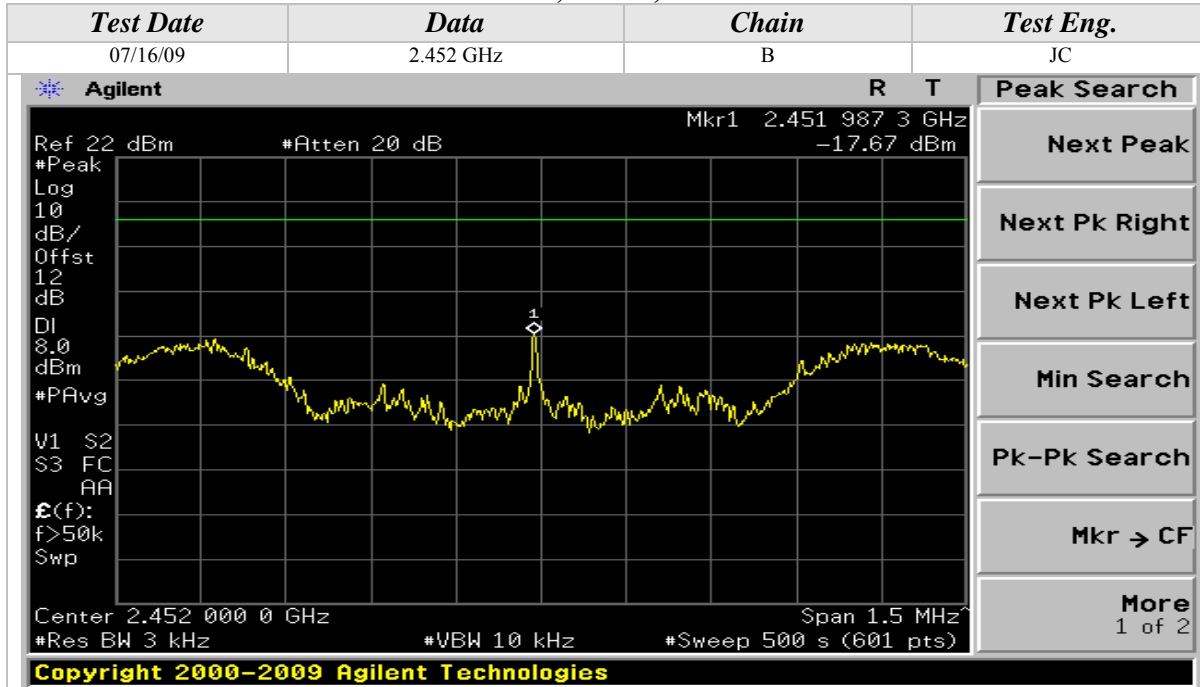

802.11n Mode, 5GHz, 20MHz Wide

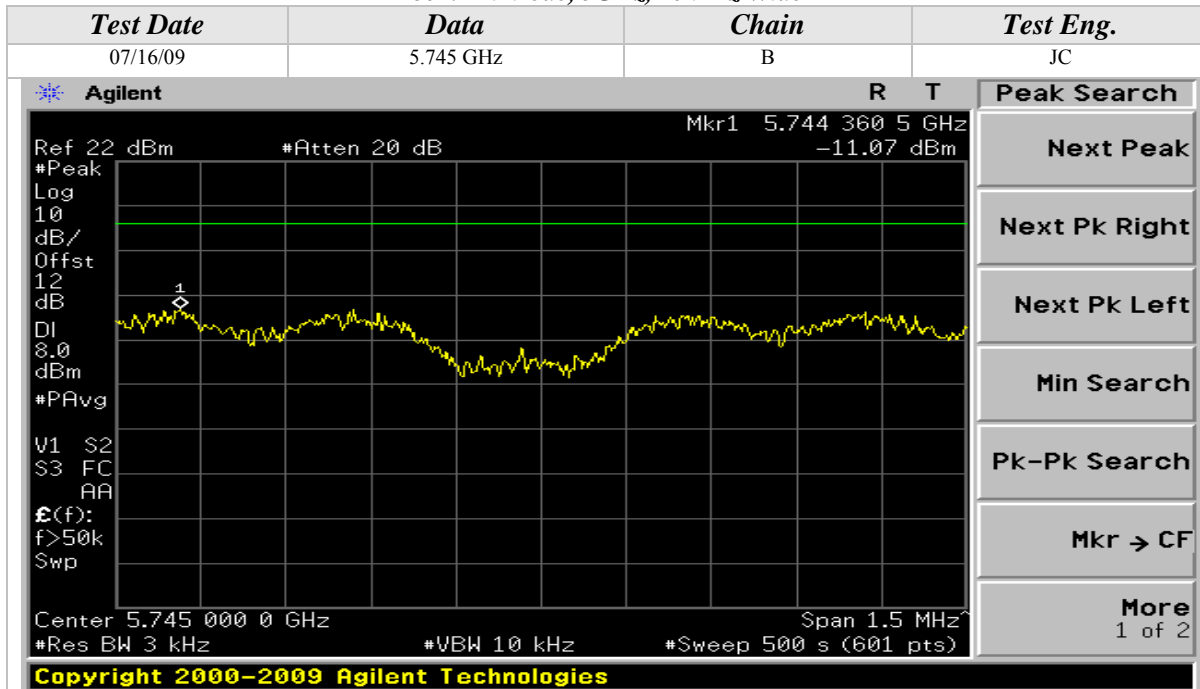

Peak Power Spectral Density (Continued)

802.11n Mode, 5GHz, 20MHz Wide

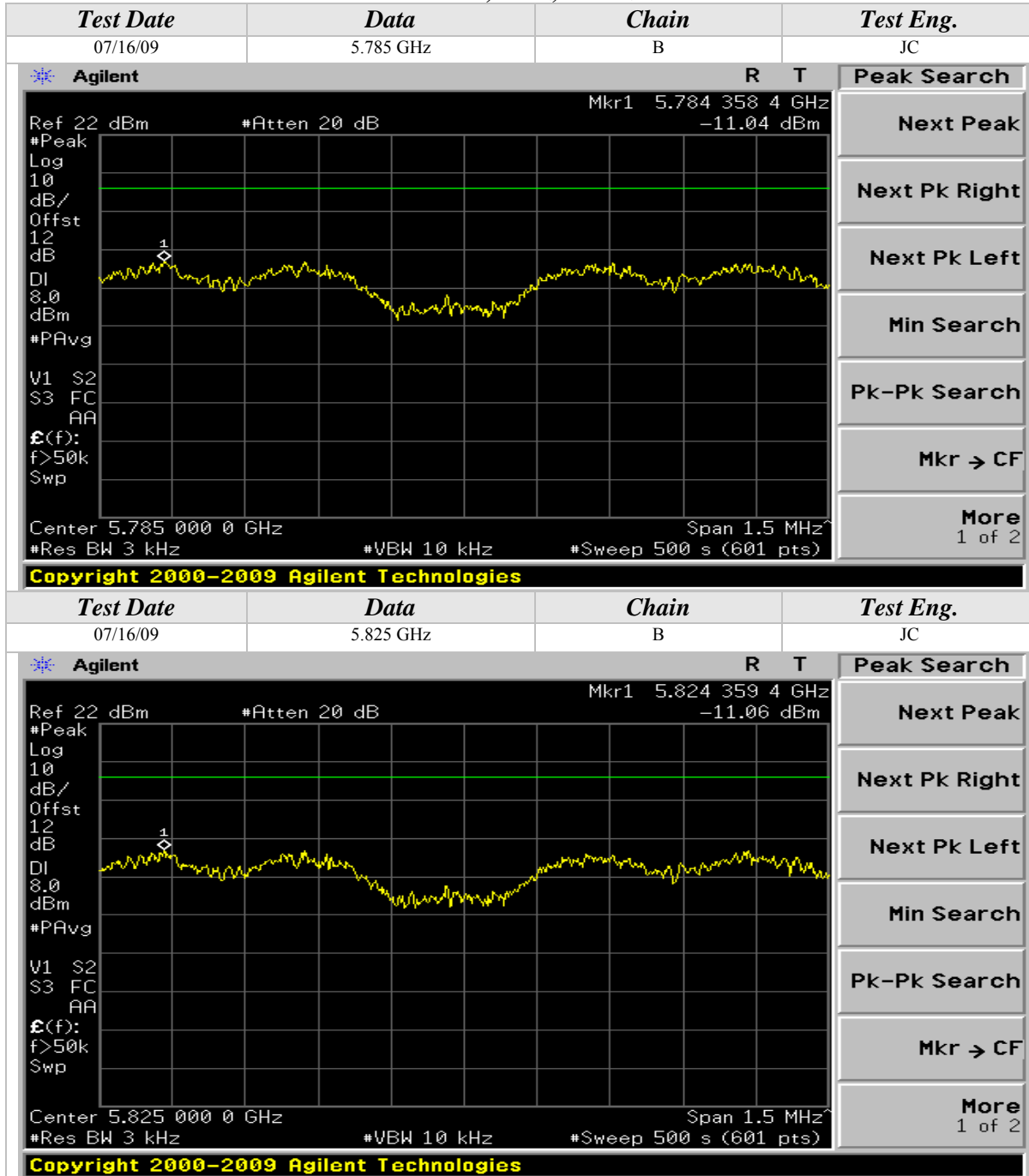

Peak Power Spectral Density (Continued)

802.11n Mode, 5GHz, 40MHz Wide

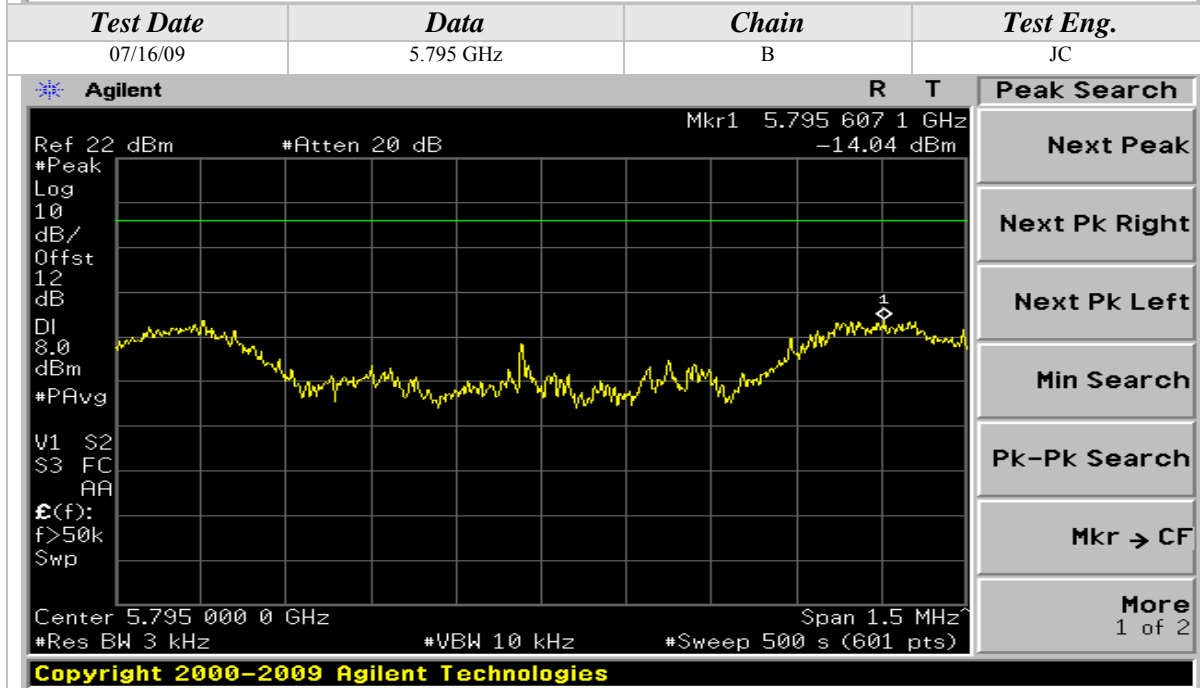
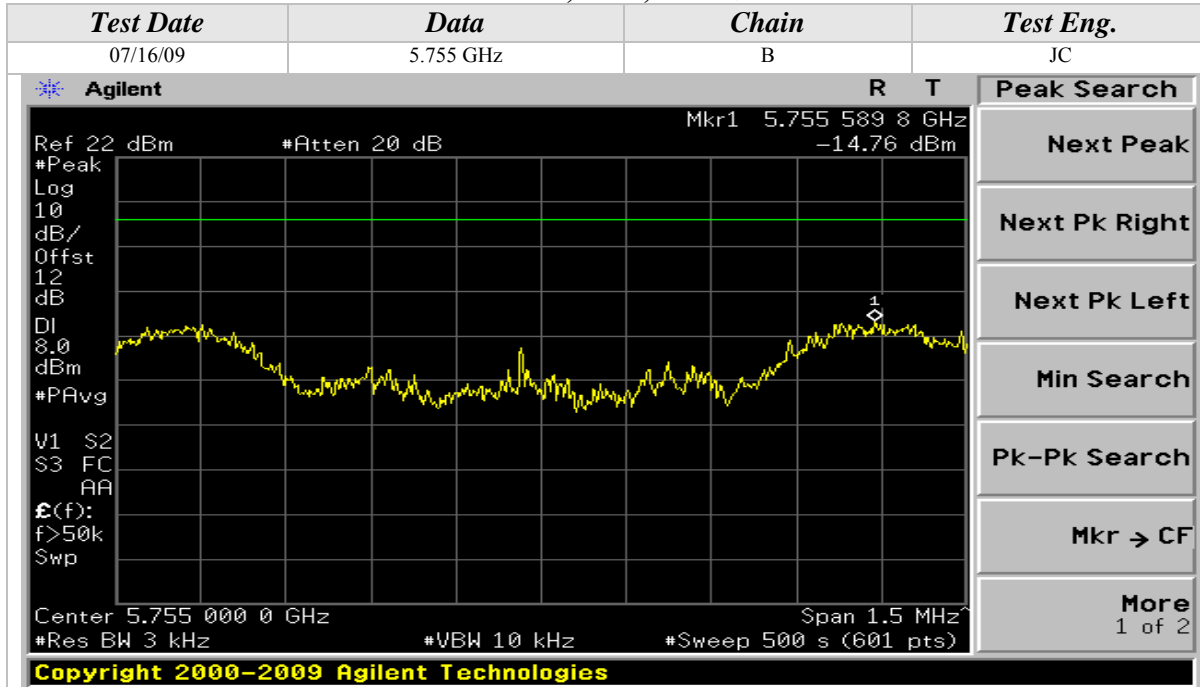

**CONDUCTED OUT OF BAND EMISSIONS**

CLIENT:	Intel Corporation	DATE:	07/31/09
EUT:	Intel WiFi Link 6300	PROJECT NUMBER:	INTEL-090601
MODEL NUMBER:	622ANHMW	TEST ENGINEER:	JC
SERIAL NUMBER:	0015005A3C7C	SITE #:	2
CONFIGURATION:	Tested installed in an extender board connected to the host laptop's mini PCI slot	TEMPERATURE:	26 deg. C
		HUMIDITY:	34% RH
		TIME:	9:30 AM

Description:	In any 100 kHz bandwidth outside the frequency band in which the spread spectrum intentional radiator is operating, the radio frequency power that is produced by the intentional radiator shall be at least 20 dB below that in the 100 kHz bandwidth within the band that contains the highest level of the desired power.
Results:	See Data Sheet
Note:	Conducted Emissions Measurements were performed on the EUT with power supply set at the following voltage and frequency. <ul style="list-style-type: none">• 120VAC / 60 Hz.

Conducted Out Of Band Emissions (Continued)

802.11a Mode

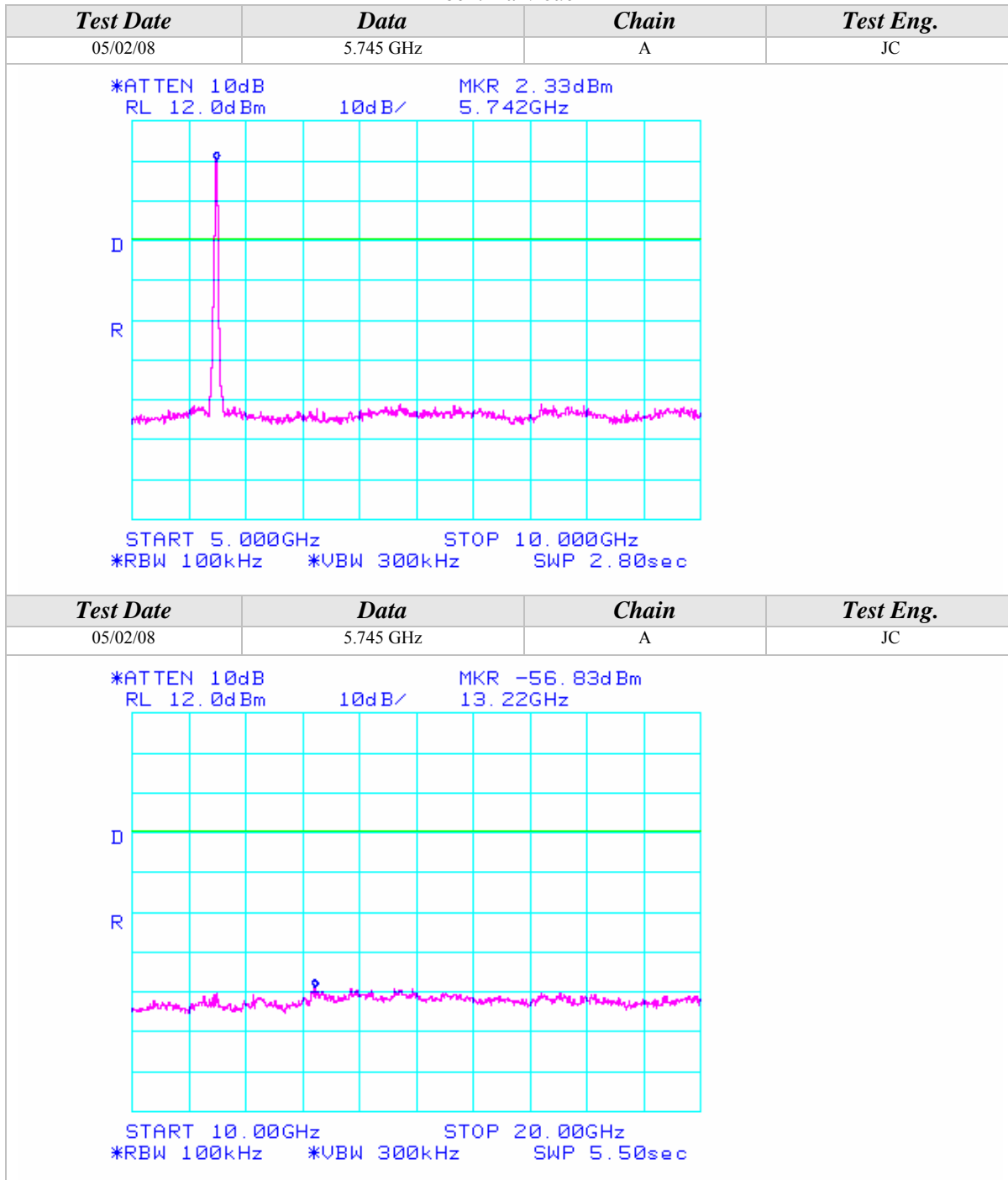

Conducted Out Of Band Emissions (Continued)

802.11a Mode

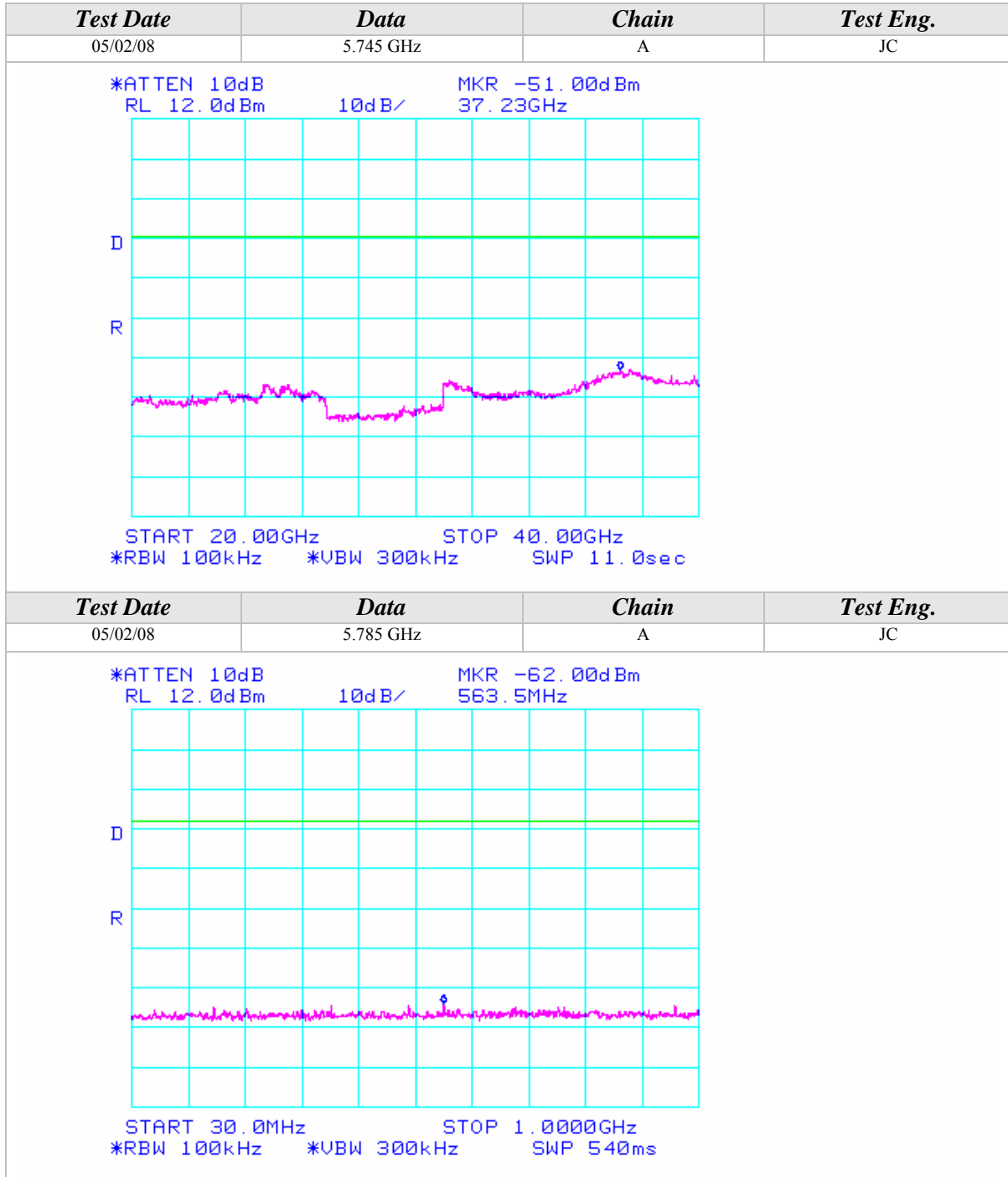



Conducted Out Of Band Emissions (Continued)

802.11a Mode

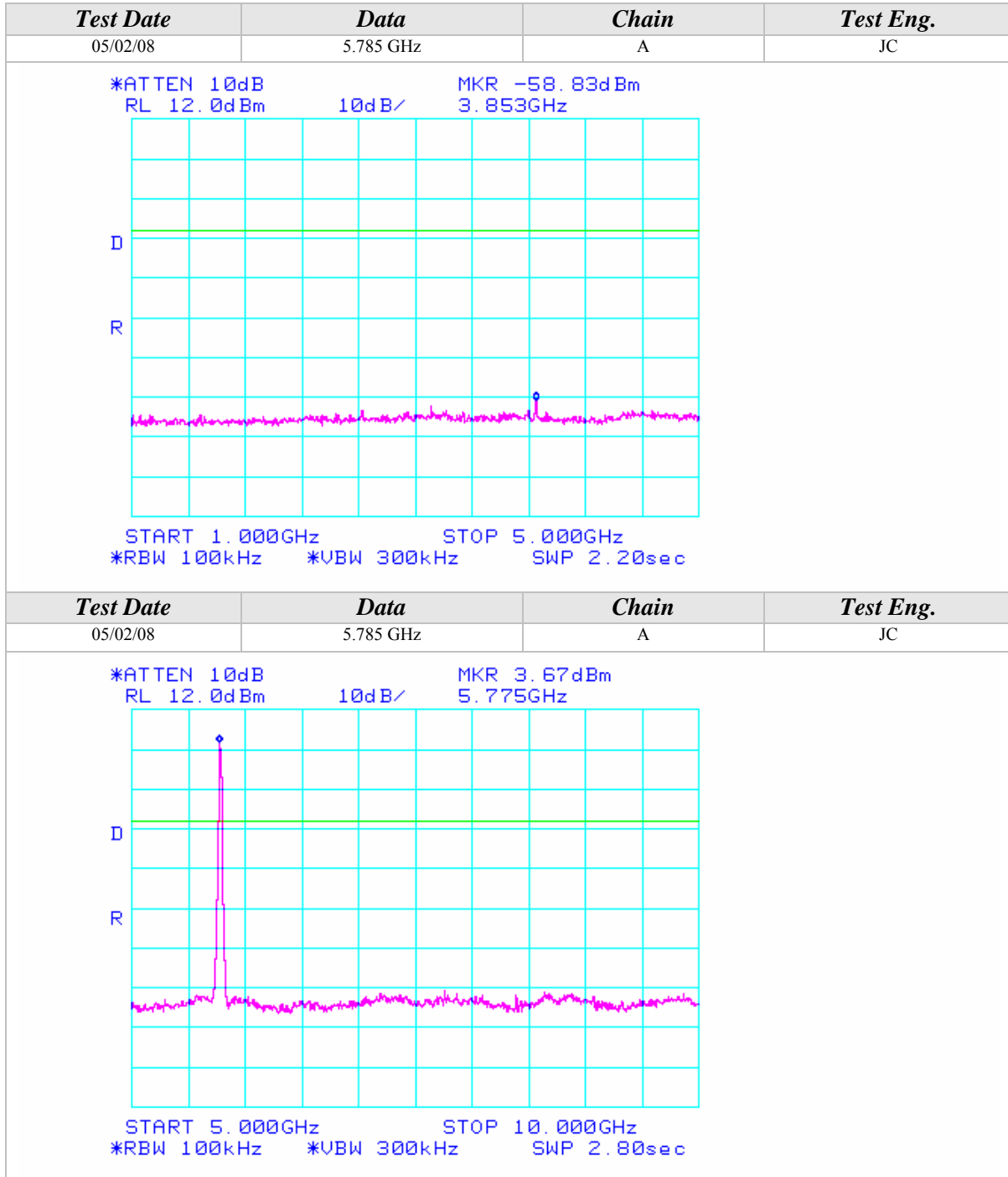

Conducted Out Of Band Emissions (Continued)

802.11a Mode

Test Date	Data	Chain	Test Eng.
05/02/08	5.785 GHz	A	JC
<p>*ATTEN 10dB MKR -56.50dBm RL 12.0dBm 10dB/ 11.57GHz</p> <p>START 10.00GHz STOP 20.00GHz *RBW 100kHz *VBW 300kHz SWP 5.50sec</p>			
Test Date	Data	Chain	Test Eng.
05/02/08	5.785 GHz	A	JC
<p>*ATTEN 10dB MKR -51.67dBm RL 12.0dBm 10dB/ 37.13GHz</p> <p>START 20.00GHz STOP 40.00GHz *RBW 100kHz *VBW 300kHz SWP 11.0sec</p>			

Conducted Out Of Band Emissions (Continued)

802.11b Mode

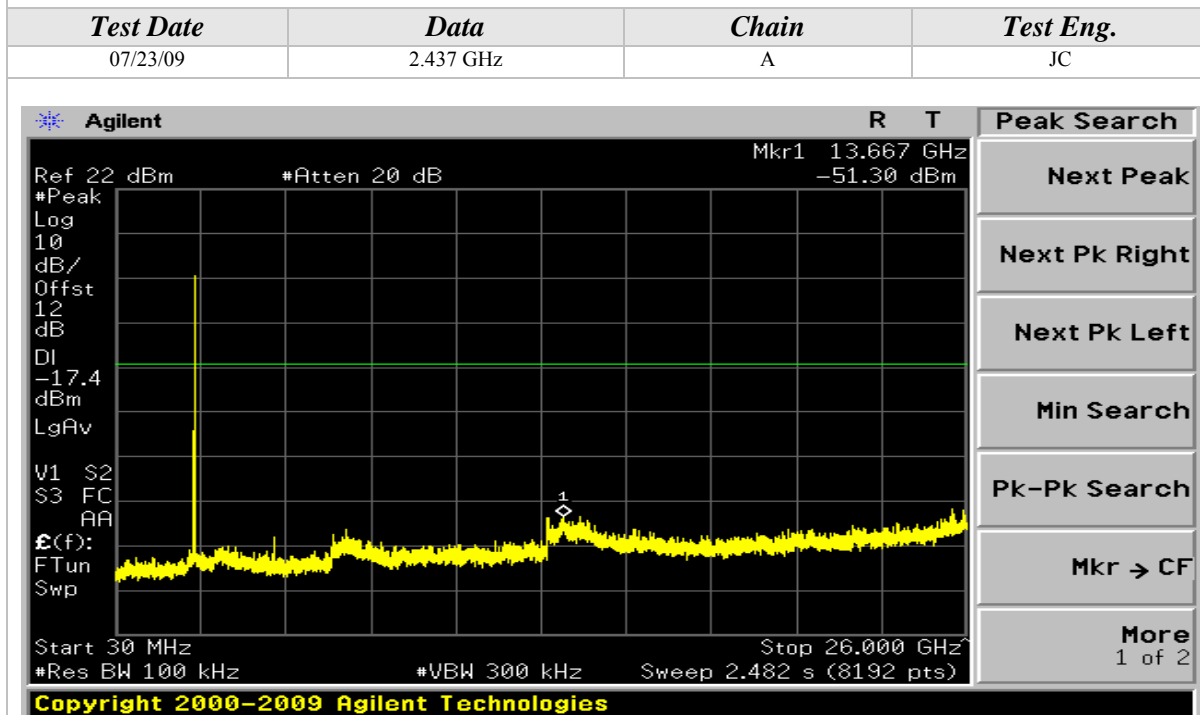
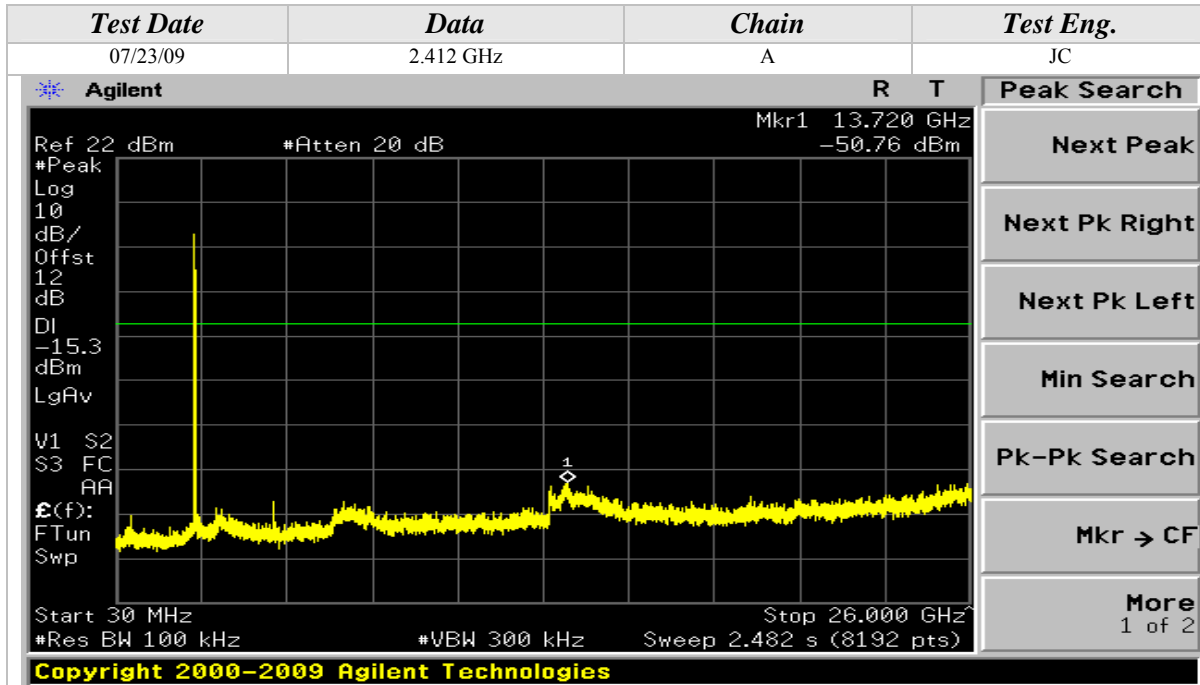

Conducted Out Of Band Emissions (Continued)

802.11b Mode

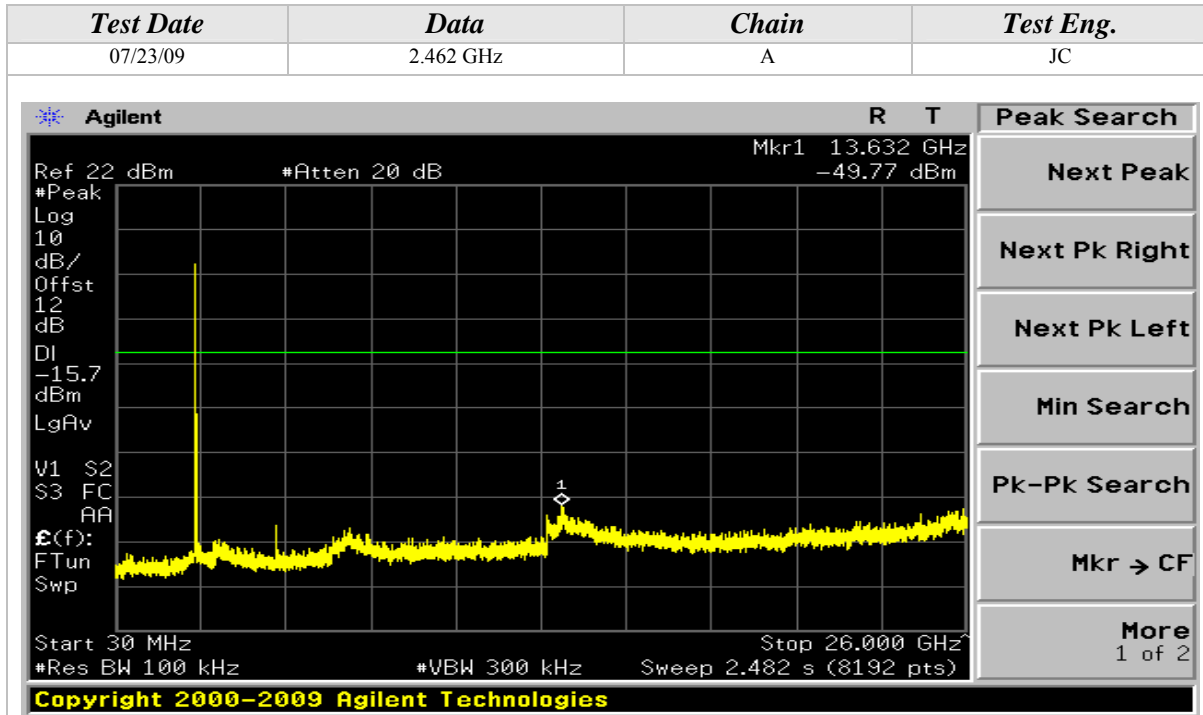

802.11g Mode

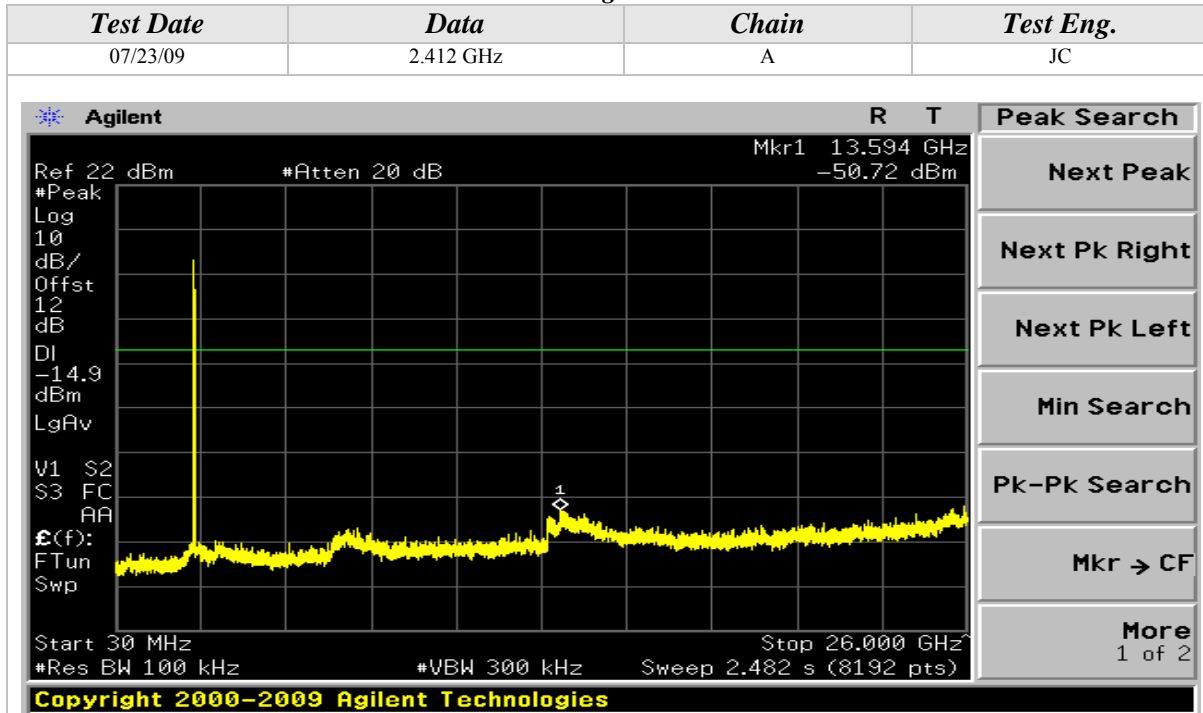

Conducted Out Of Band Emissions (Continued)

802.11g Mode

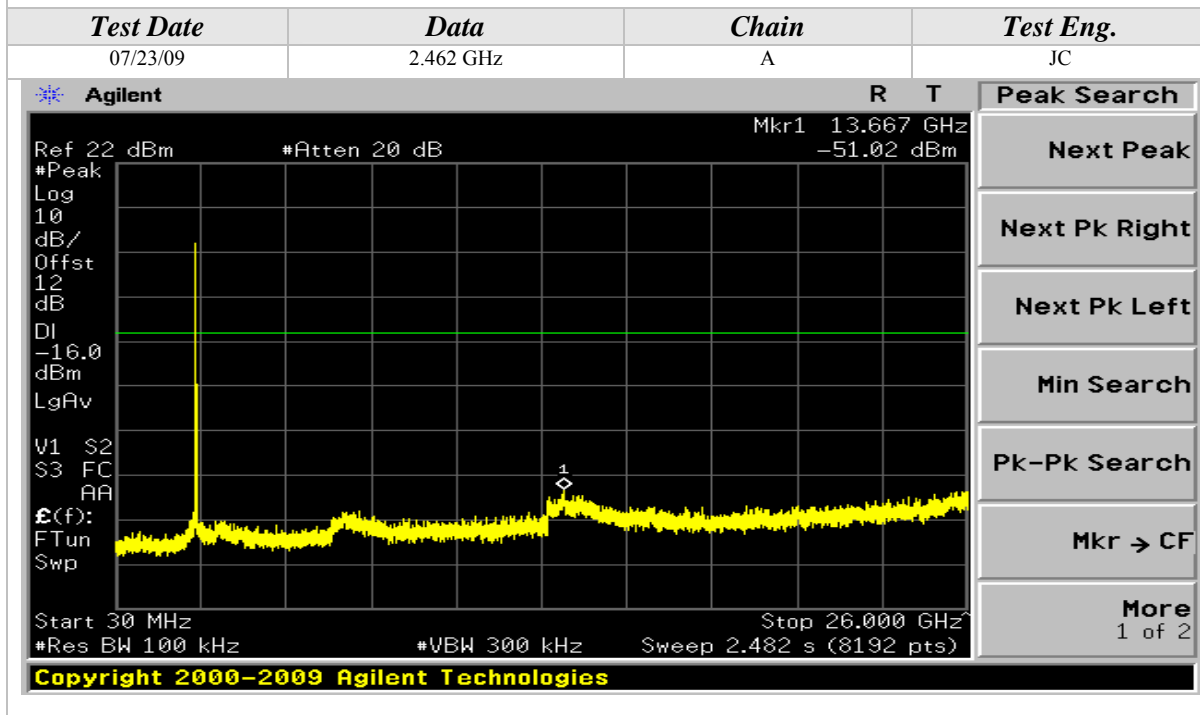
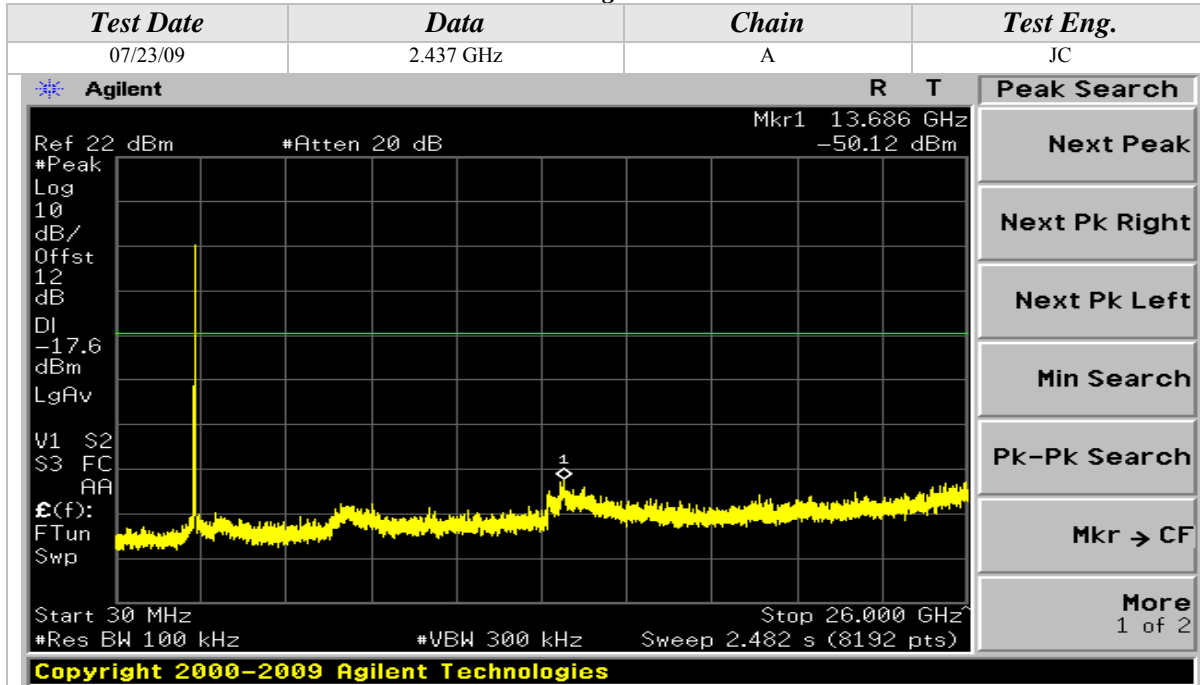

Conducted Out Of Band Emissions (Continued)

802.11n Mode, 2.4GHz, 20MHz Wide

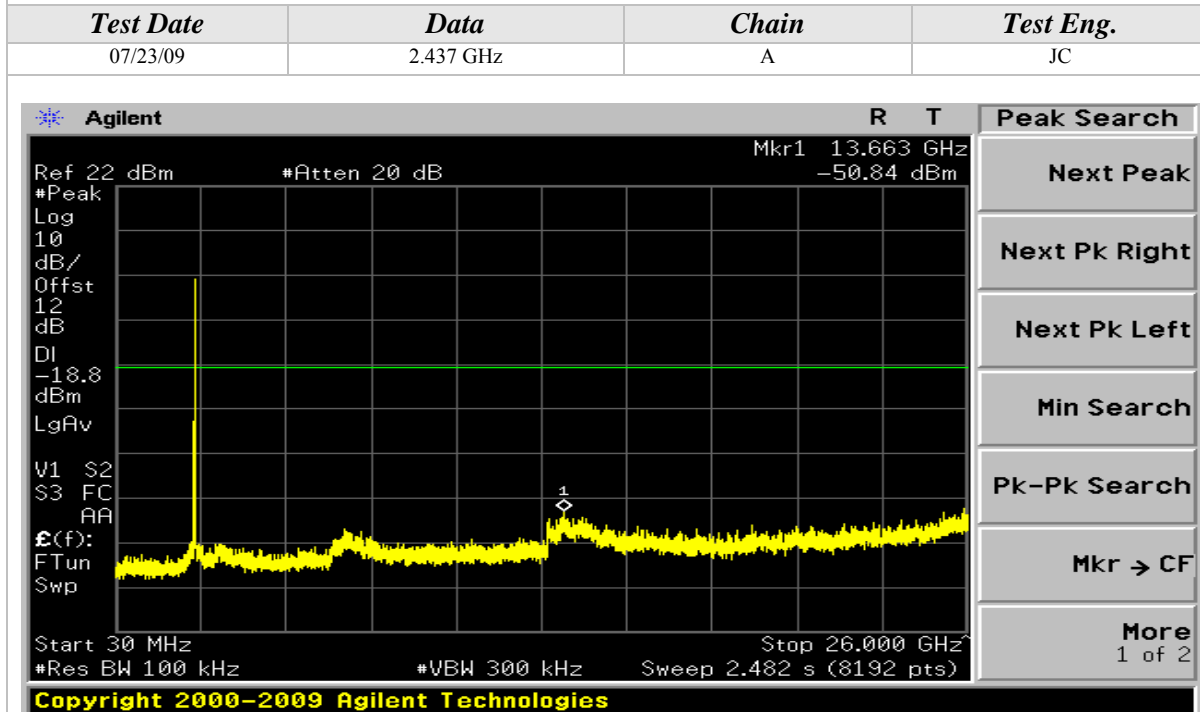
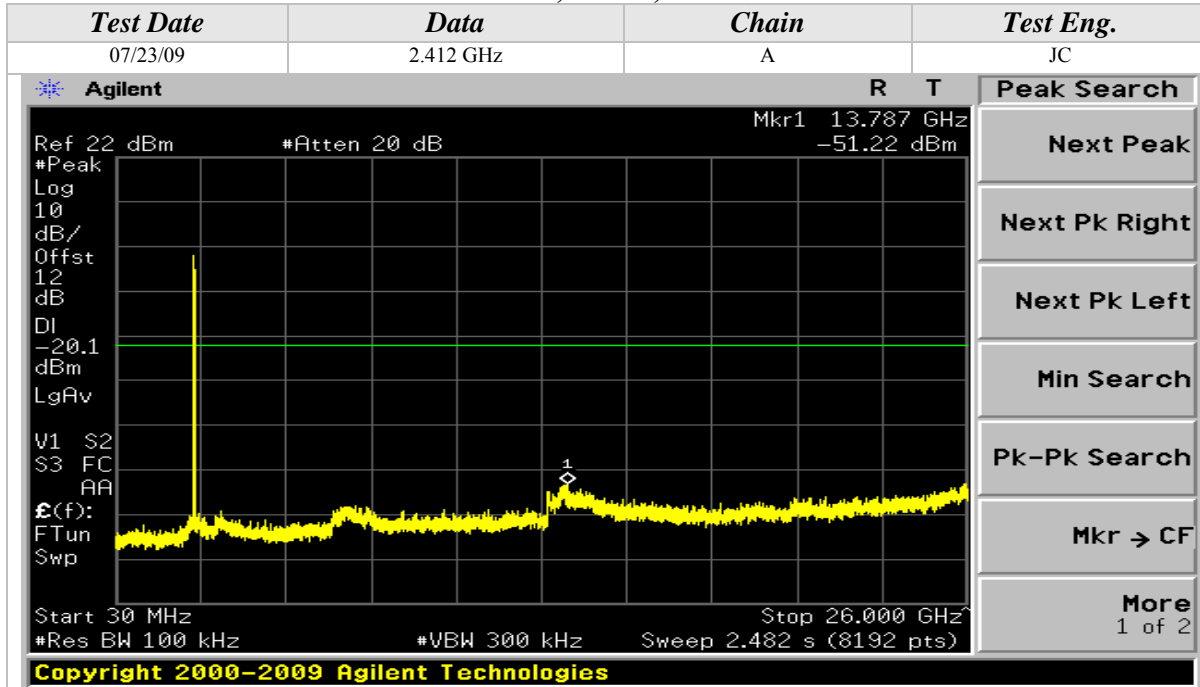

Conducted Out Of Band Emissions (Continued)

802.11n Mode, 2.4GHz, 20MHz Wide

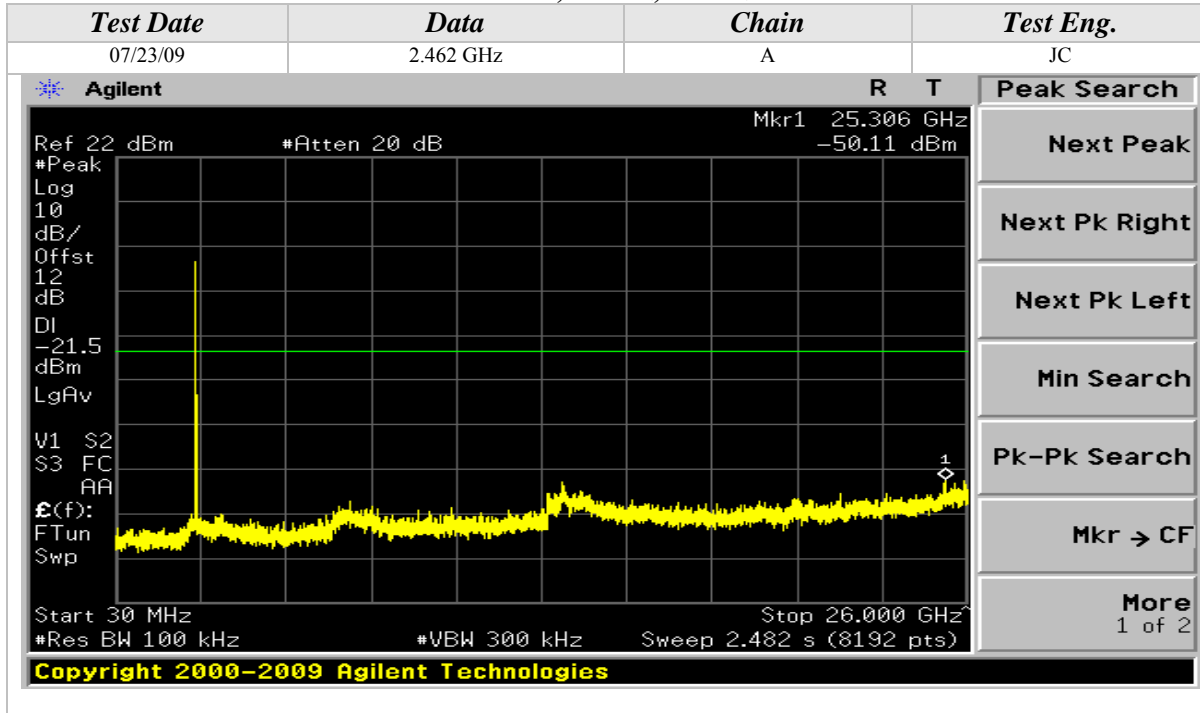

802.11n Mode, 2.4GHz, 40MHz Wide

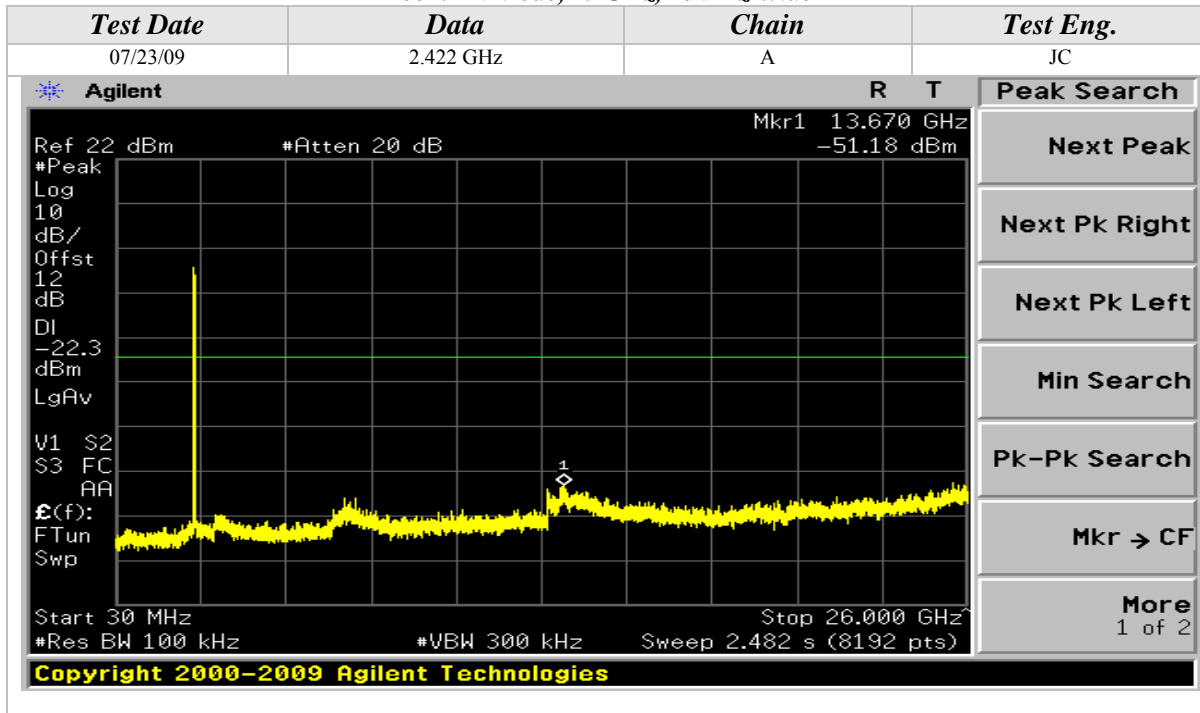

Conducted Out Of Band Emissions (Continued)

802.11n Mode, 2.4GHz, 40MHz Wide

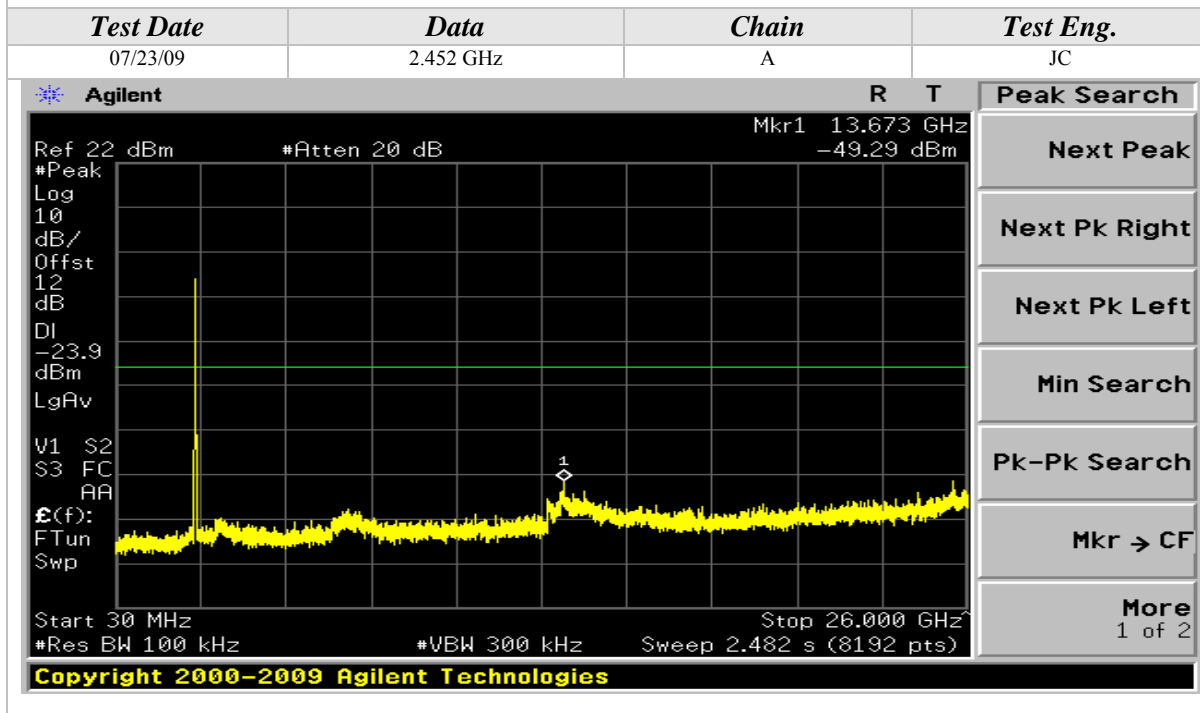
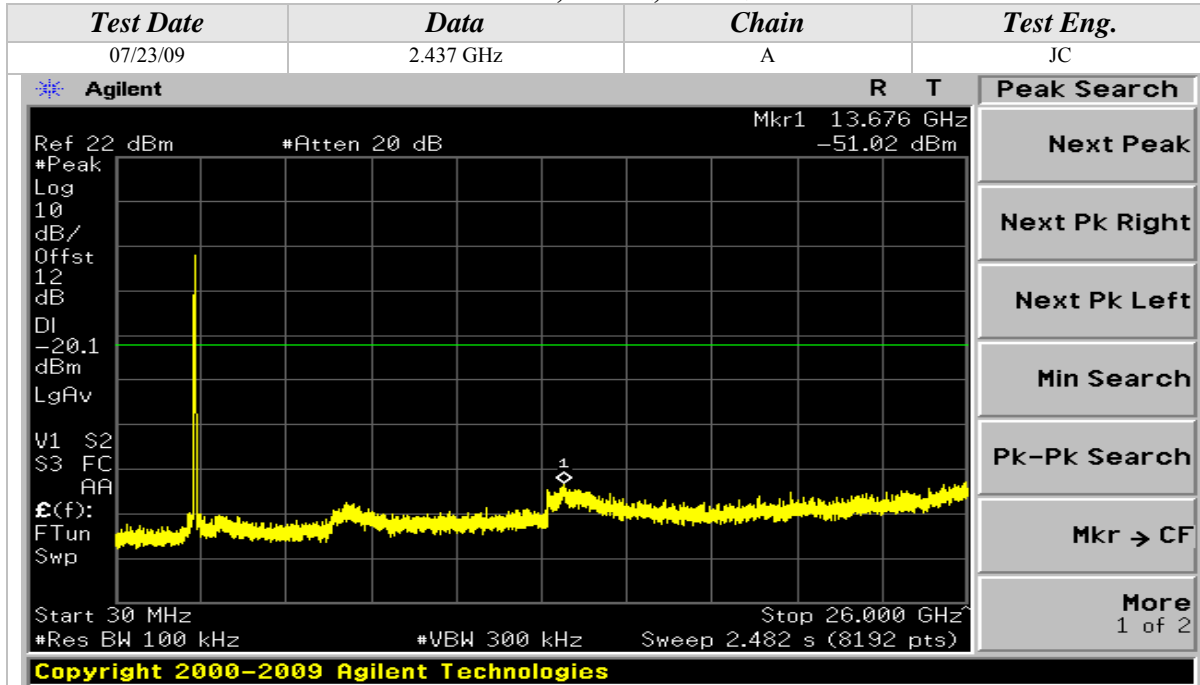



Conducted Out Of Band Emissions (Continued)

802.11n Mode, 5GHz, 20MHz Wide

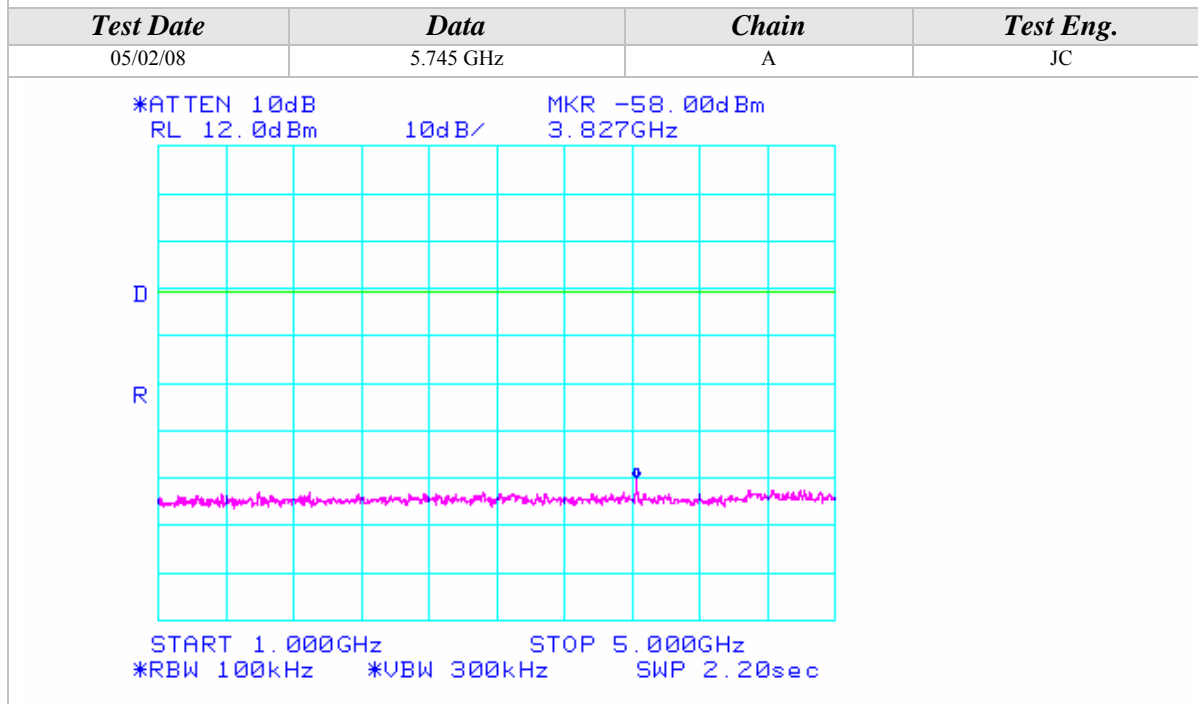
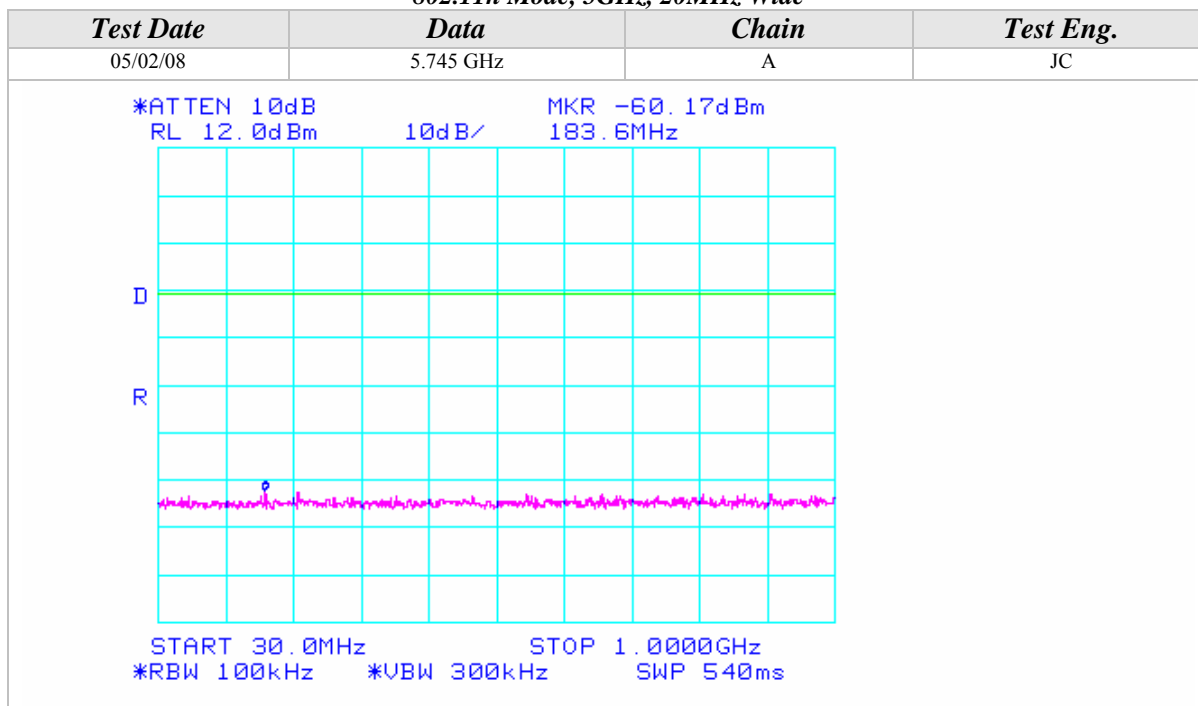

Conducted Out Of Band Emissions (Continued)

802.11n Mode, 5GHz, 20MHz Wide

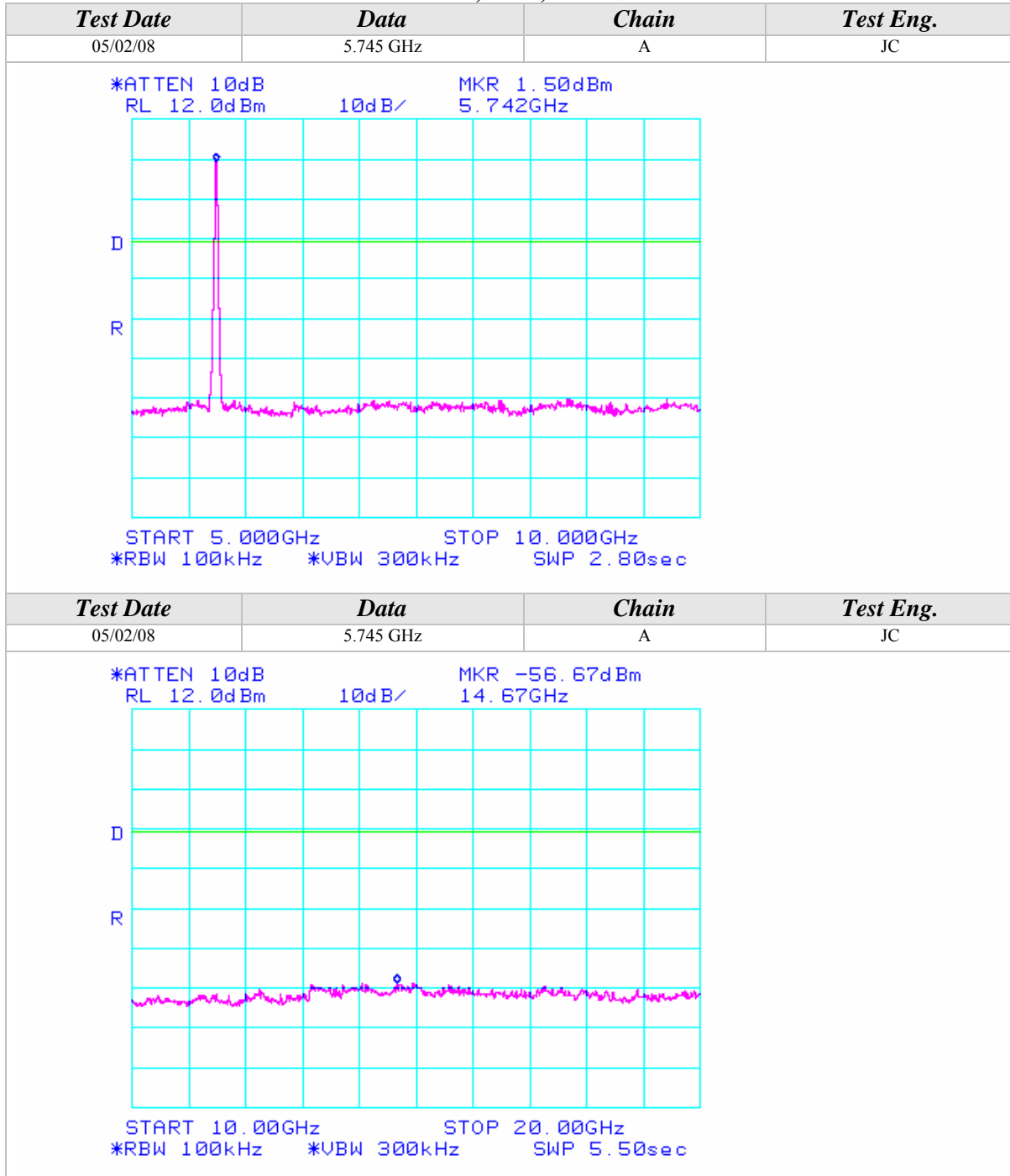



Conducted Out Of Band Emissions (Continued)

802.11n Mode, 5GHz, 20MHz Wide

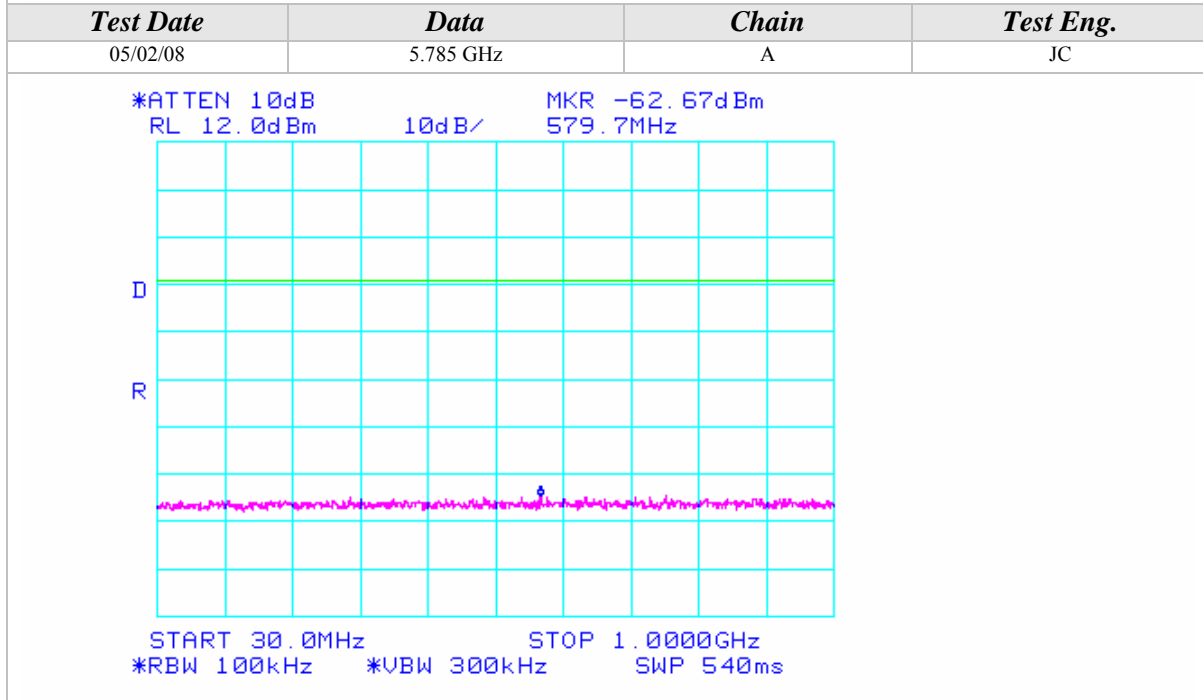
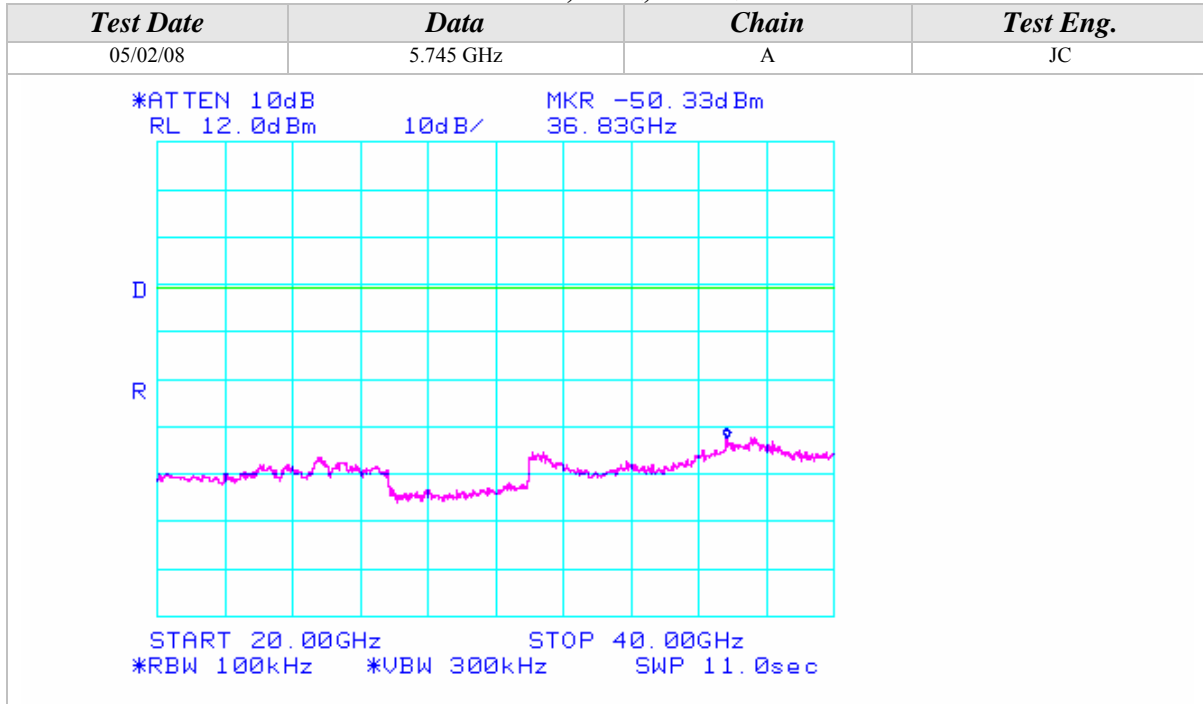

Conducted Out Of Band Emissions (Continued)

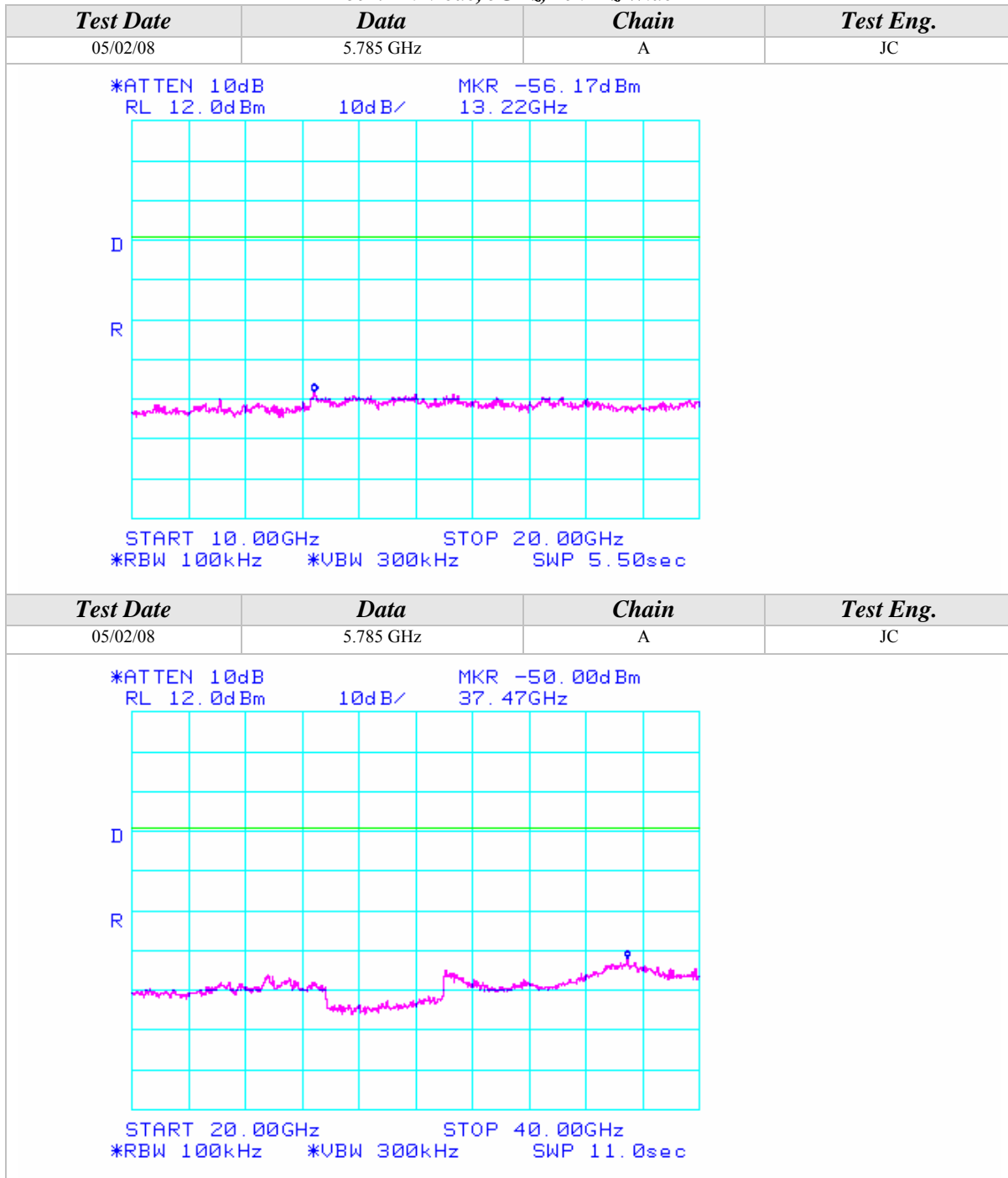
802.11n Mode, 5GHz, 20MHz Wide



Conducted Out Of Band Emissions (Continued)

802.11n Mode, 5GHz, 20MHz Wide

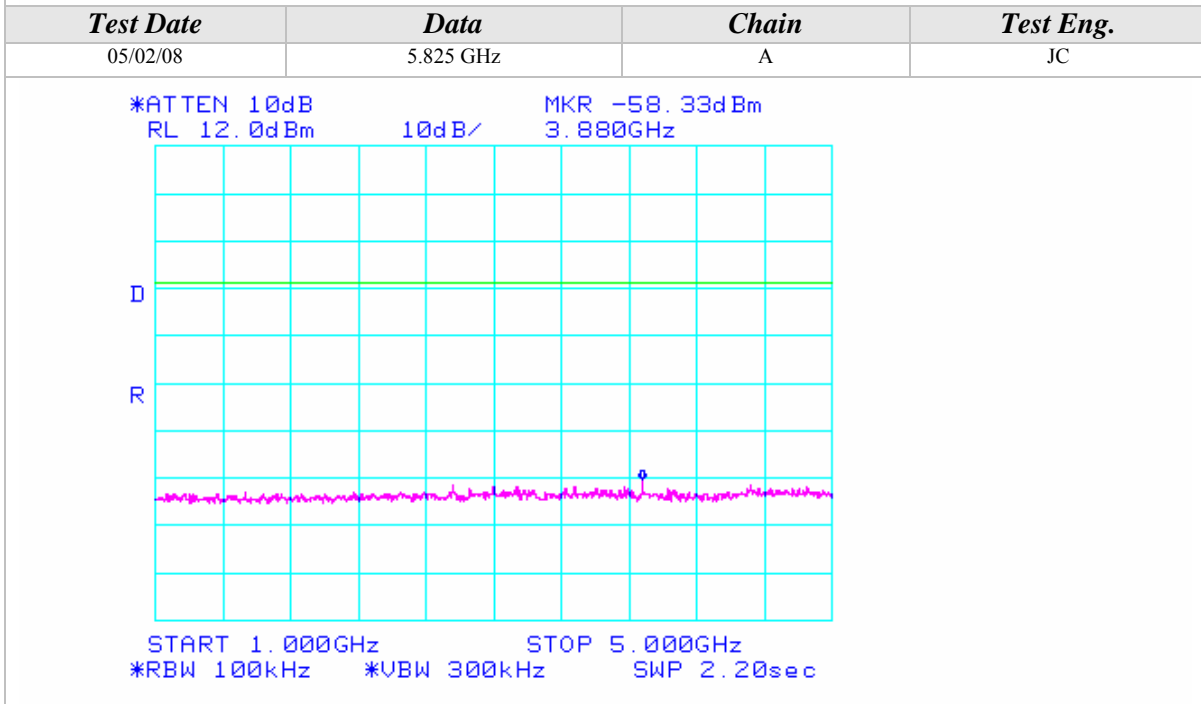
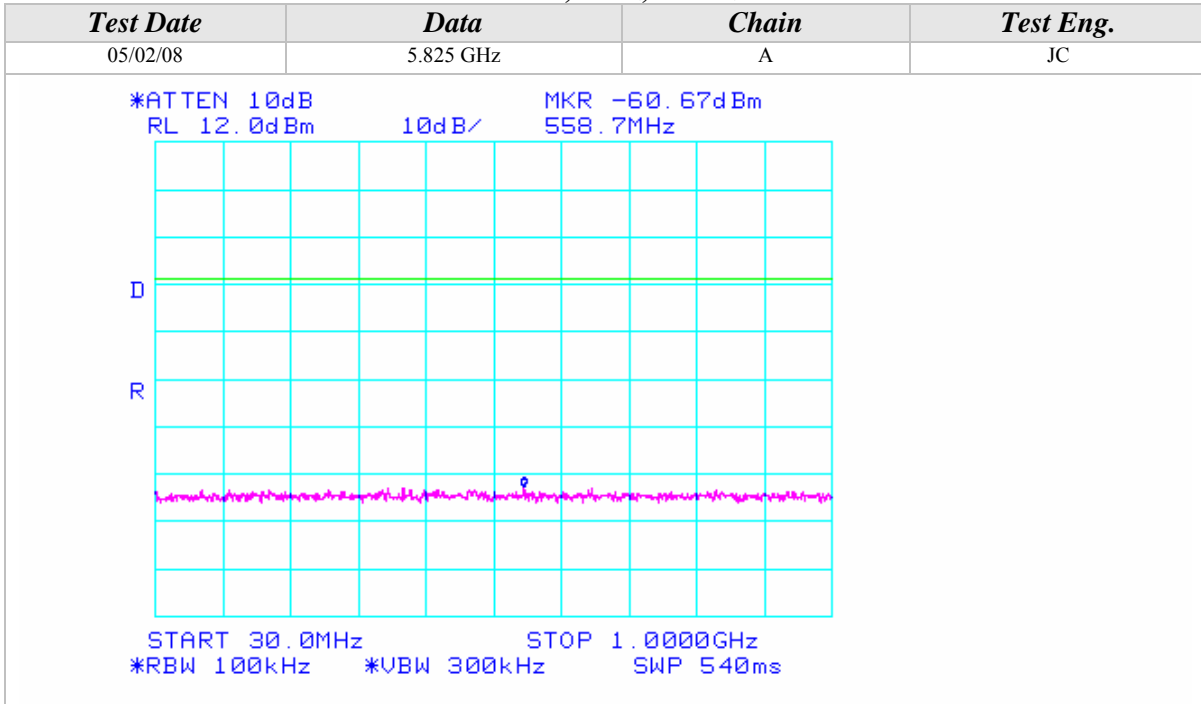

Conducted Out Of Band Emissions (Continued)

802.11n Mode, 5GHz, 20MHz Wide

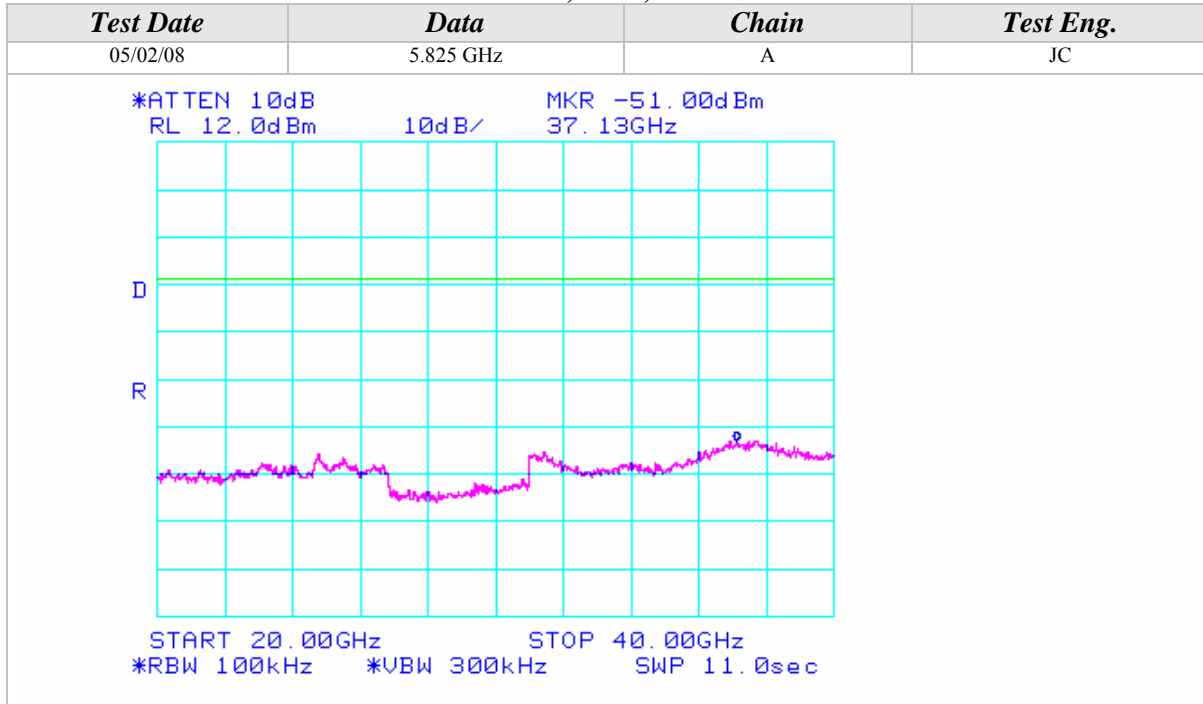



Conducted Out Of Band Emissions (Continued)

802.11n Mode, 5GHz, 40MHz Wide

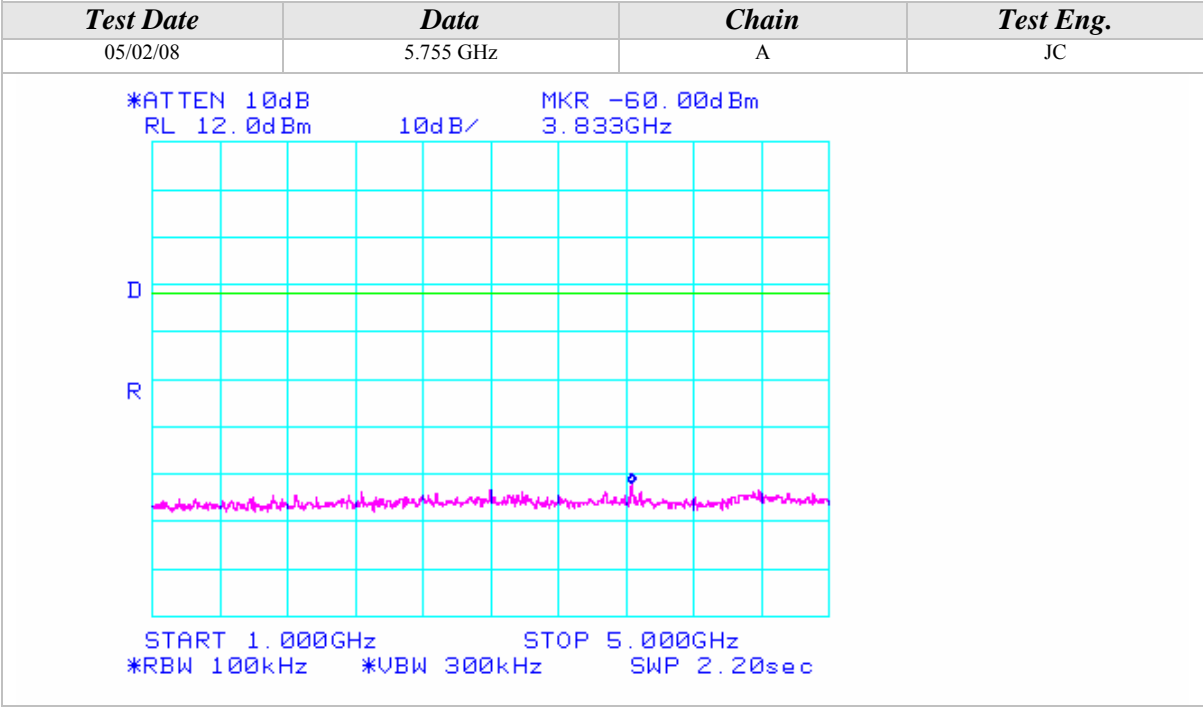
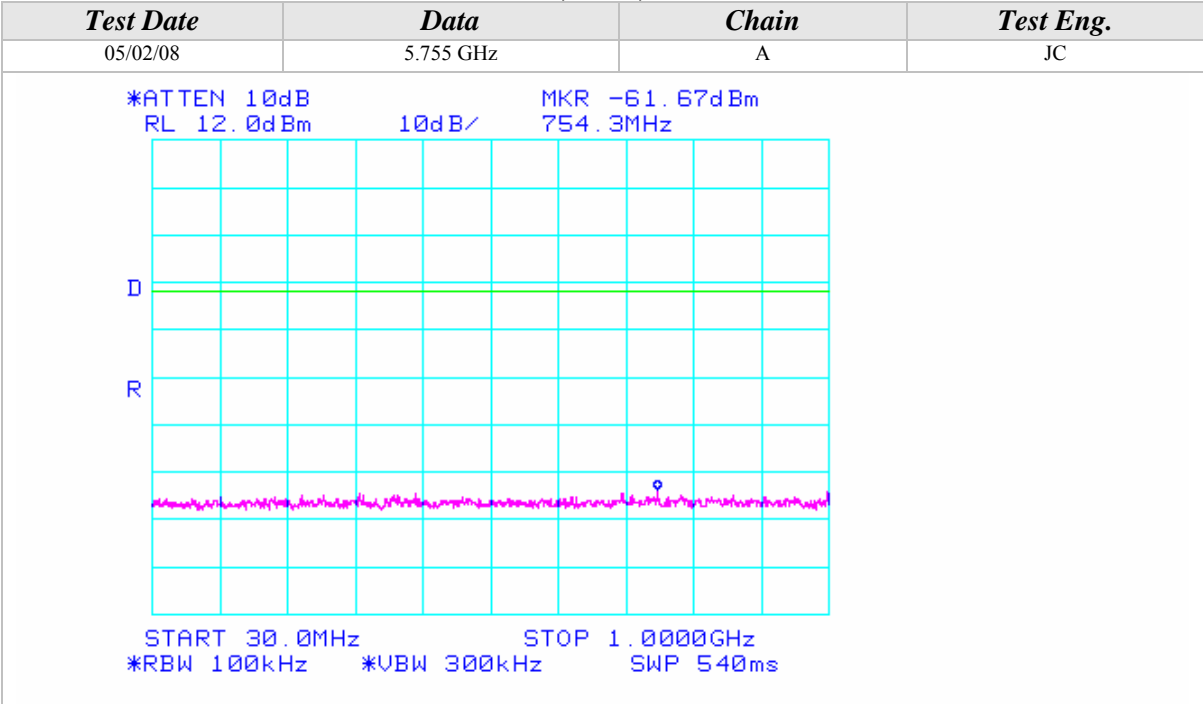

Conducted Out Of Band Emissions (Continued)

802.11n Mode, 5GHz, 40MHz Wide

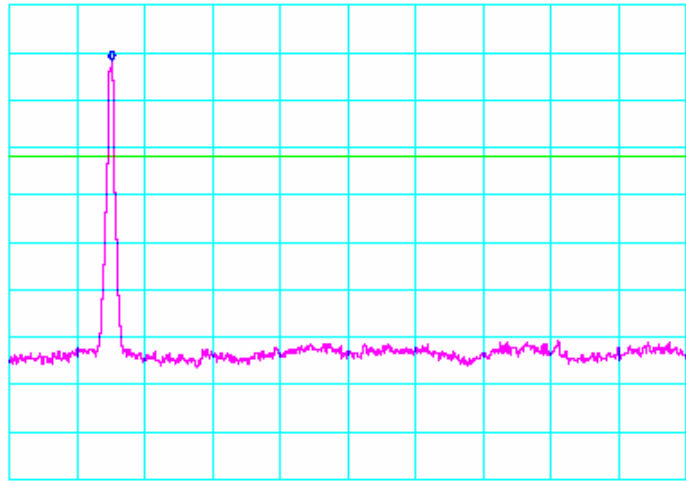
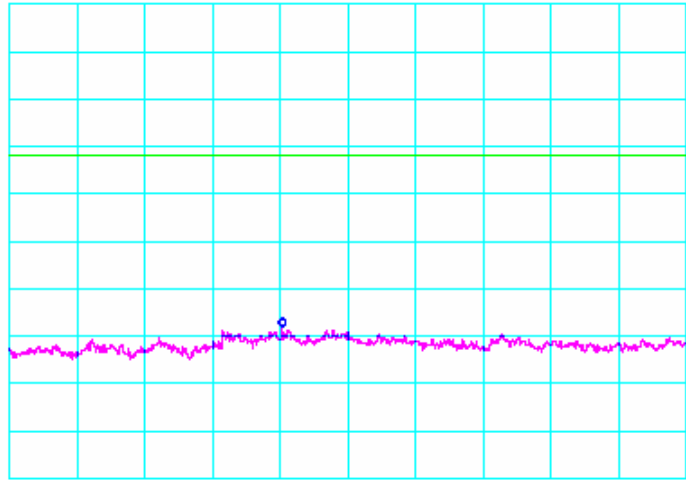
Test Date	Data	Chain	Test Eng.
05/02/08	5.755 GHz	A	JC
<p>*ATTEN 10dB MKR -33dBm RL 12.0dBm 10dB/ 5.758GHz</p>  <p>START 5.000GHz STOP 10.000GHz *RBW 100kHz *VBW 300kHz SWP 2.80sec</p>			
Test Date	Data	Chain	Test Eng.
05/02/08	5.755 GHz	A	JC
<p>*ATTEN 10dB MKR -56.17dBm RL 12.0dBm 10dB/ 14.03GHz</p>  <p>START 10.00GHz STOP 20.00GHz *RBW 100kHz *VBW 300kHz SWP 5.50sec</p>			

Conducted Out Of Band Emissions (Continued)

802.11n Mode, 5GHz, 40MHz Wide

Test Date	Data	Chain	Test Eng.
05/02/08	5.755 GHz	A	JC
<p> *ATTEN 10dB RL 12.0dBm MKR -50.50dBm 10dB/ 37.63GHz </p> <p> START 20.00GHz STOP 40.00GHz *RBW 100kHz *VBW 300kHz SWP 11.0sec </p>			
Test Date	Data	Chain	Test Eng.
05/02/08	5.795 GHz	A	JC
<p> *ATTEN 10dB RL 12.0dBm MKR -62.67dBm 10dB/ 542.5MHz </p> <p> START 30.0MHz STOP 1.0000GHz *RBW 100kHz *VBW 300kHz SWP 540ms </p>			

Conducted Out Of Band Emissions (Continued)

802.11n Mode, 5GHz, 40MHz Wide

Test Date	Data	Chain	Test Eng.
05/02/08	5.795 GHz	A	JC
<p>*ATTEN 10dB MKR -58.50dBm RL 12.0dBm 10dB/ 3.860GHz</p> <p>START 1.000GHz STOP 5.000GHz *RBW 100kHz *VBW 300kHz SWP 2.20sec</p>			
Test Date	Data	Chain	Test Eng.
05/02/08	5.795 GHz	A	JC
<p>*ATTEN 10dB MKR 1.00dBm RL 12.0dBm 10dB/ 5.783GHz</p> <p>START 5.000GHz STOP 10.000GHz *RBW 100kHz *VBW 300kHz SWP 2.80sec</p>			



Conducted Out Of Band Emissions (Continued)

802.11a Mode

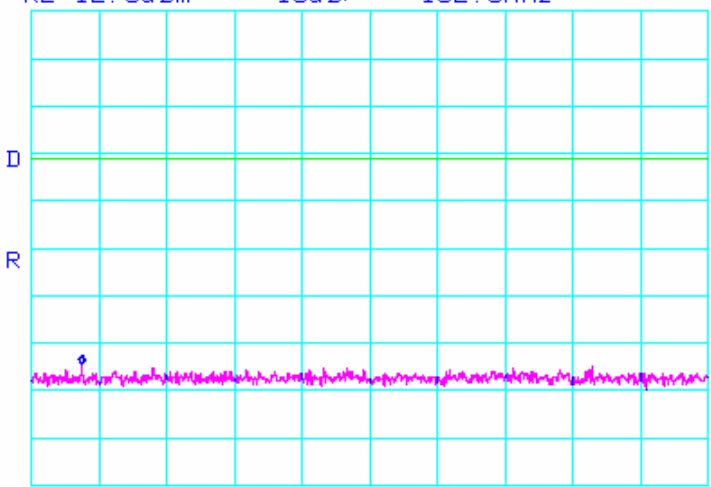
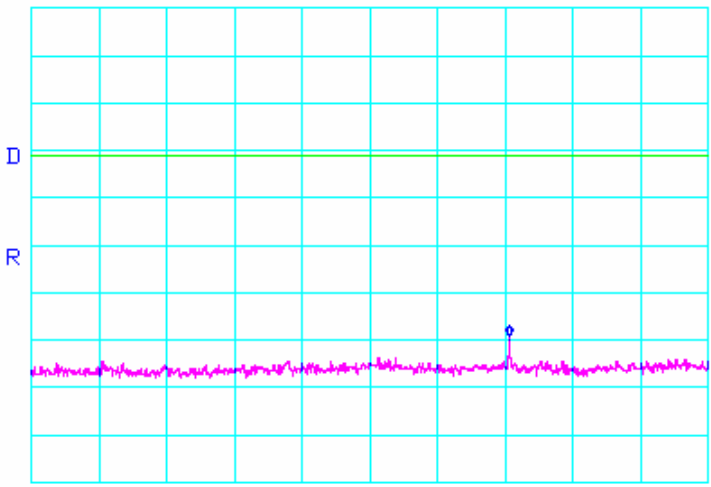
<i>Test Date</i>	<i>Data</i>	<i>Chain</i>	<i>Test Eng.</i>
05/02/08	5.745 GHz	B	JC
*ATTEN 10dB MKR -62.50dBm RL 12.0dBm 10dB/ 102.8MHz			
			
START 30.0MHz STOP 1.0000GHz *RBW 100kHz *VBW 300kHz SWP 540ms			
<i>Test Date</i>	<i>Data</i>	<i>Chain</i>	<i>Test Eng.</i>
05/02/08	5.745 GHz	B	JC
*ATTEN 10dB MKR -57.00dBm RL 12.0dBm 10dB/ 3.827GHz			
			
START 1.000GHz STOP 5.000GHz *RBW 100kHz *VBW 300kHz SWP 2.20sec			



Conducted Out Of Band Emissions (Continued)

802.11a Mode

Test Date	Data	Chain	Test Eng.
05/02/08	5.745 GHz	B	JC
<p>*ATTEN 10dB MKR -50.17dBm RL 12.0dBm 10dB/ 37.53GHz</p> <p>START 20.00GHz STOP 40.00GHz *RBW 100kHz *VBW 300kHz SWP 11.0sec</p>			
Test Date	Data	Chain	Test Eng.
05/02/08	5.785 GHz	B	JC
<p>*ATTEN 10dB MKR -61.33dBm RL 12.0dBm 10dB/ 767.2MHz</p> <p>START 30.0MHz STOP 1.0000GHz *RBW 100kHz *VBW 300kHz SWP 540ms</p>			

Conducted Out Of Band Emissions (Continued)

802.11a Mode

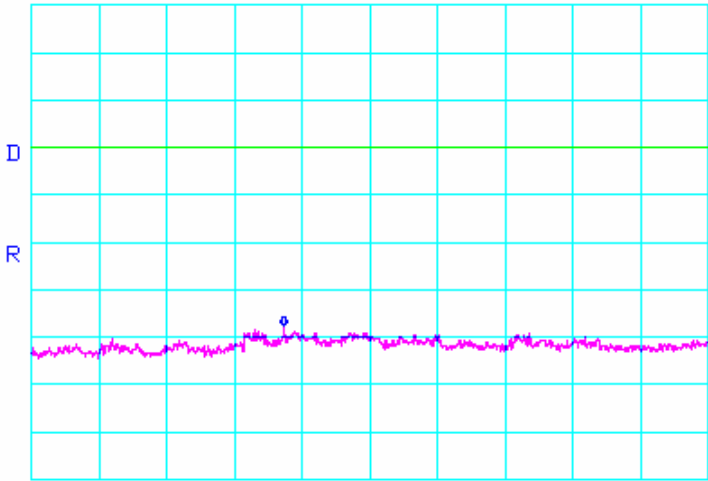
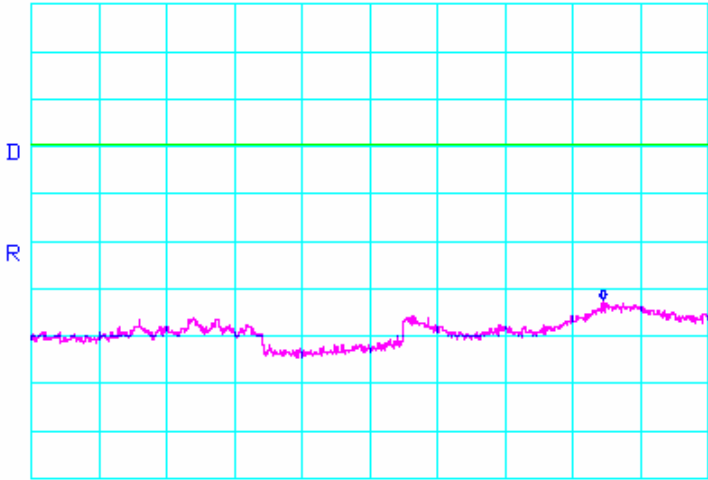
Test Date	Data	Chain	Test Eng.
05/02/08	5.785 GHz	B	JC
<p>*ATTEN 10dB MKR -55.67dBm RL 12.0dBm 10dB/ 13.73GHz</p>  <p>START 10.00GHz STOP 20.00GHz *RBW 100kHz *VBW 300kHz SWP 5.50sec</p>			
Test Date	Data	Chain	Test Eng.
05/02/08	5.785 GHz	B	JC
<p>*ATTEN 10dB MKR -50.33dBm RL 12.0dBm 10dB/ 36.90GHz</p>  <p>START 20.00GHz STOP 40.00GHz *RBW 100kHz *VBW 300kHz SWP 11.0sec</p>			



Conducted Out Of Band Emissions (Continued)

802.11a Mode

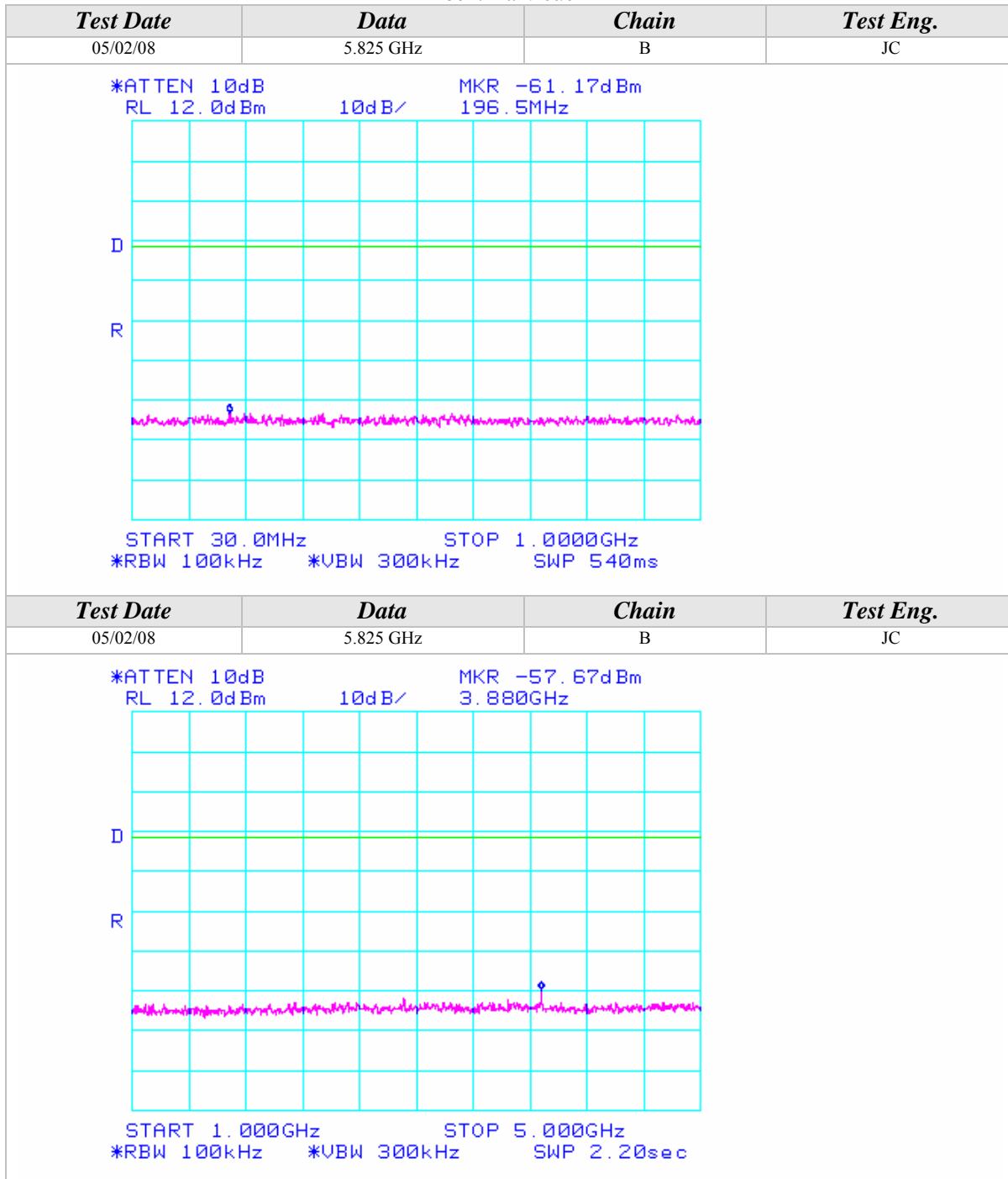



Conducted Out Of Band Emissions (Continued)

802.11a Mode

Test Date	Data	Chain	Test Eng.
05/02/08	5.825 GHz	B	JC
<p>*ATTEN 10dB MKR -50dBm RL 12.0dBm 10dB/ 5.817GHz</p> <p>START 5.000GHz STOP 10.000GHz *RBW 100kHz *VBW 300kHz SWP 2.80sec</p>			
Test Date	Data	Chain	Test Eng.
05/02/08	5.825 GHz	B	JC
<p>*ATTEN 10dB MKR -56.33dBm RL 12.0dBm 10dB/ 13.95GHz</p> <p>START 10.00GHz STOP 20.00GHz *RBW 100kHz *VBW 300kHz SWP 5.50sec</p>			

Conducted Out Of Band Emissions (Continued)

802.11b Mode

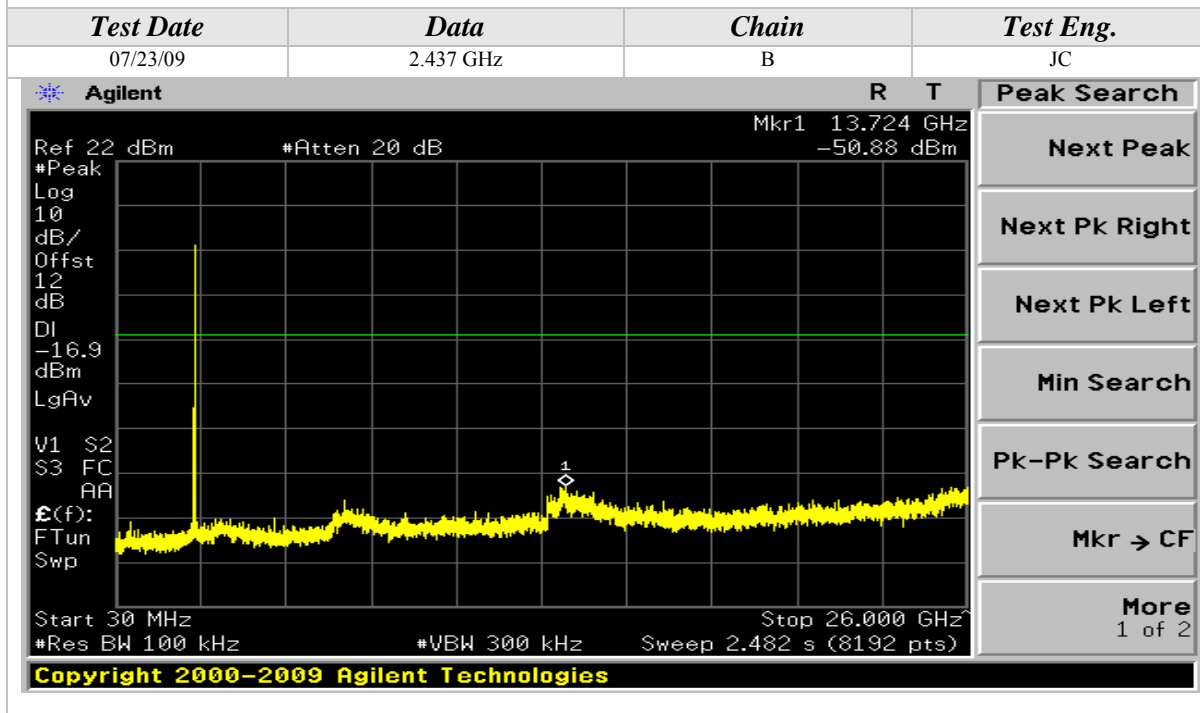
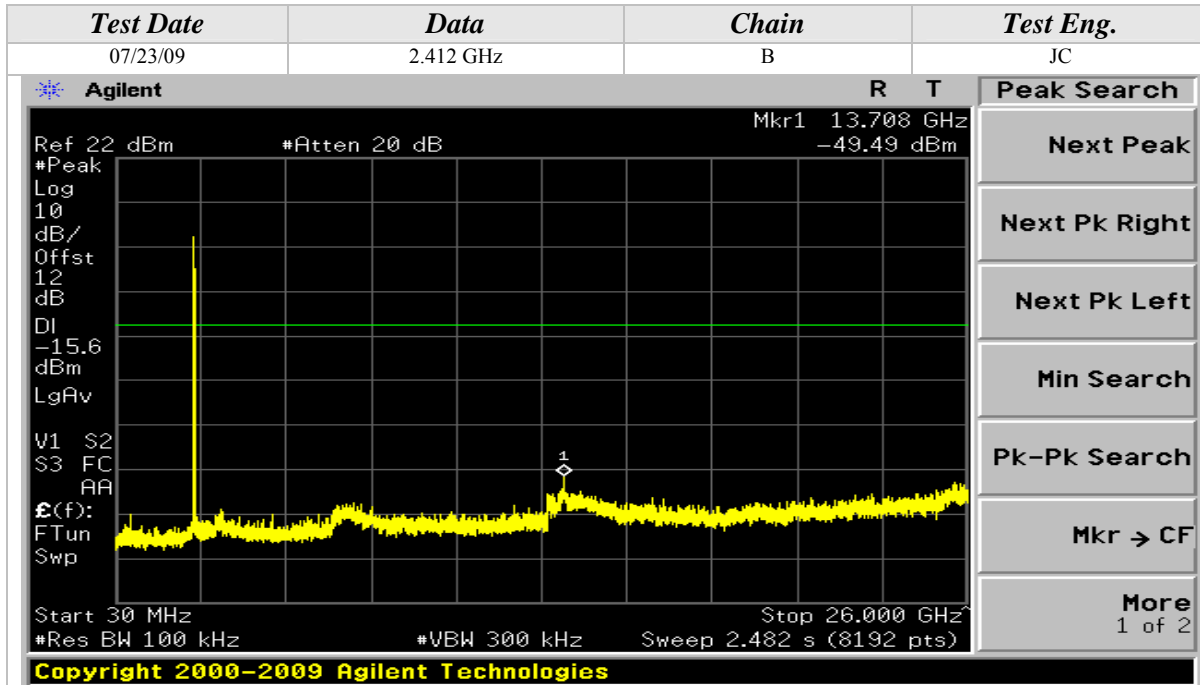

Conducted Out Of Band Emissions (Continued)

802.11b Mode

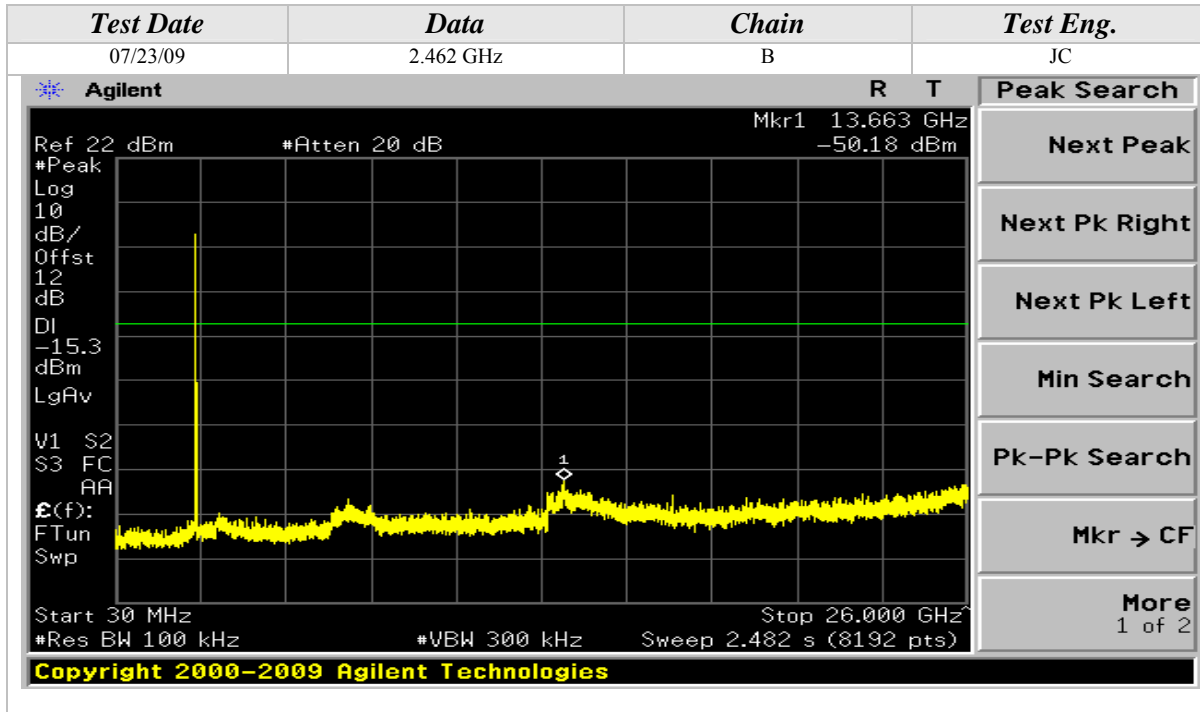

802.11g Mode

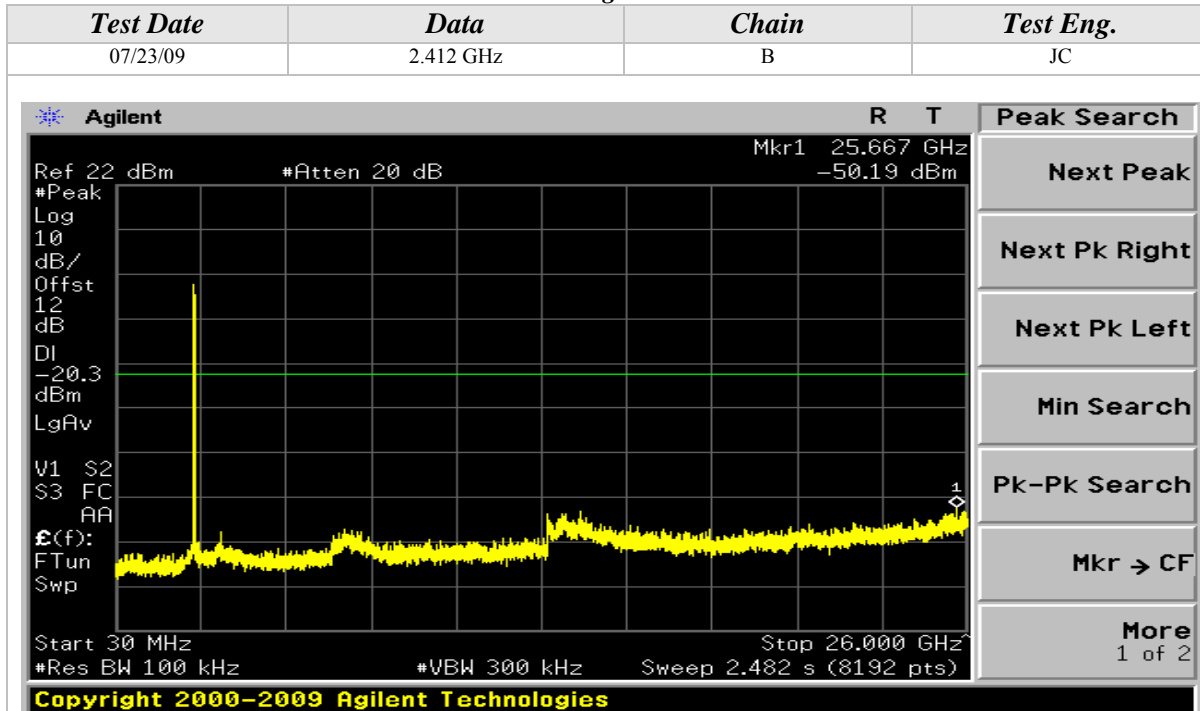

Conducted Out Of Band Emissions (Continued)

802.11g Mode

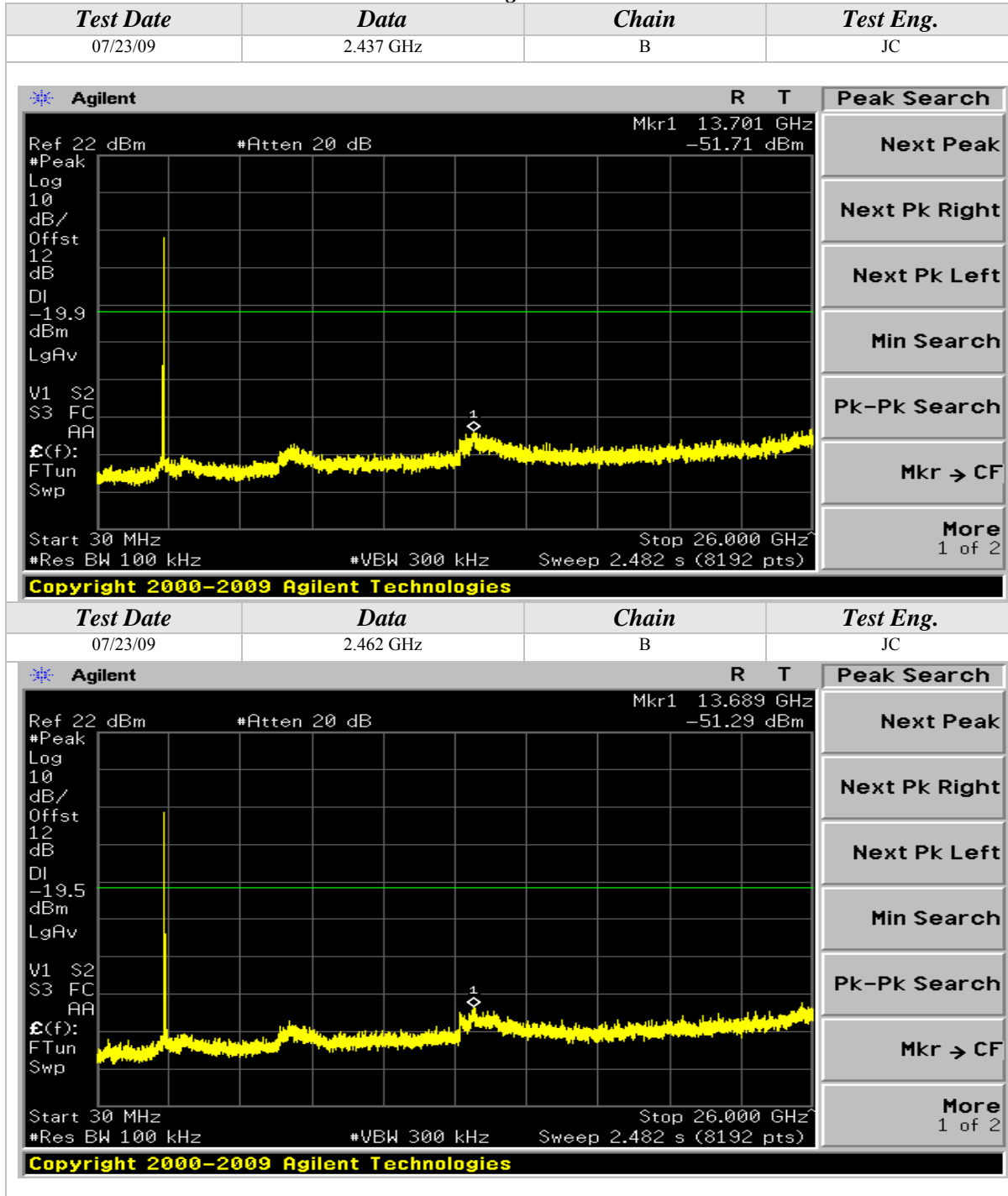

Conducted Out Of Band Emissions (Continued)

802.11n Mode, 2.4GHz, 20MHz Wide

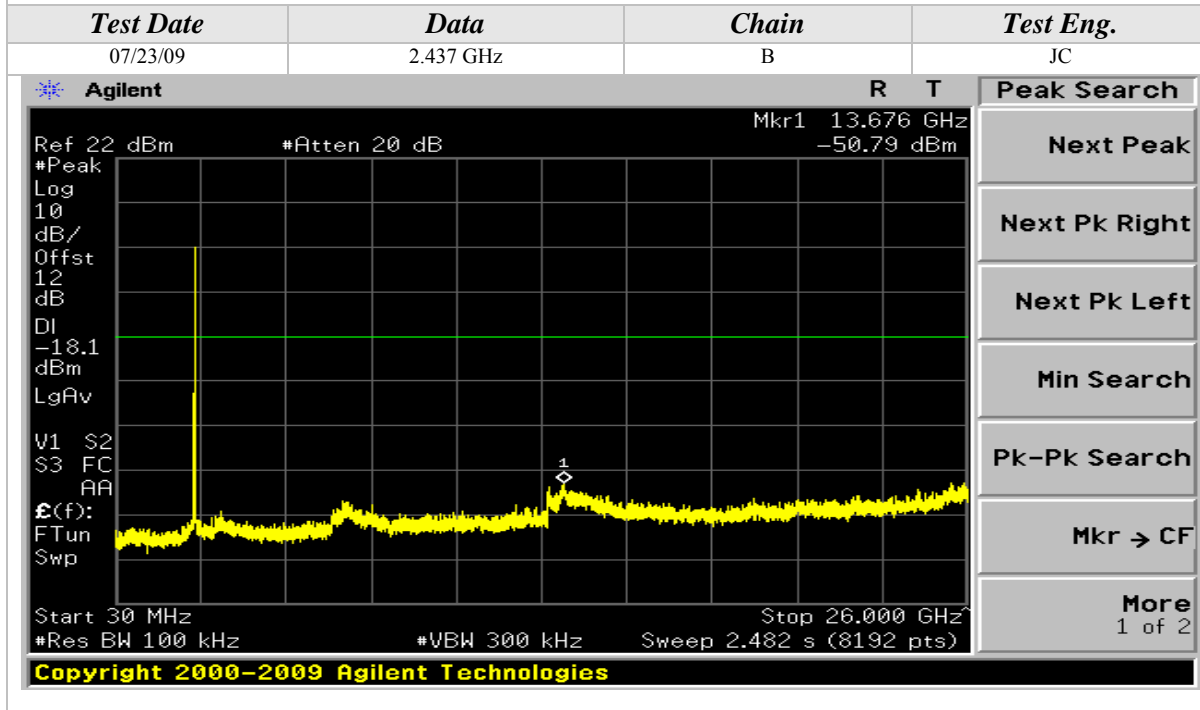
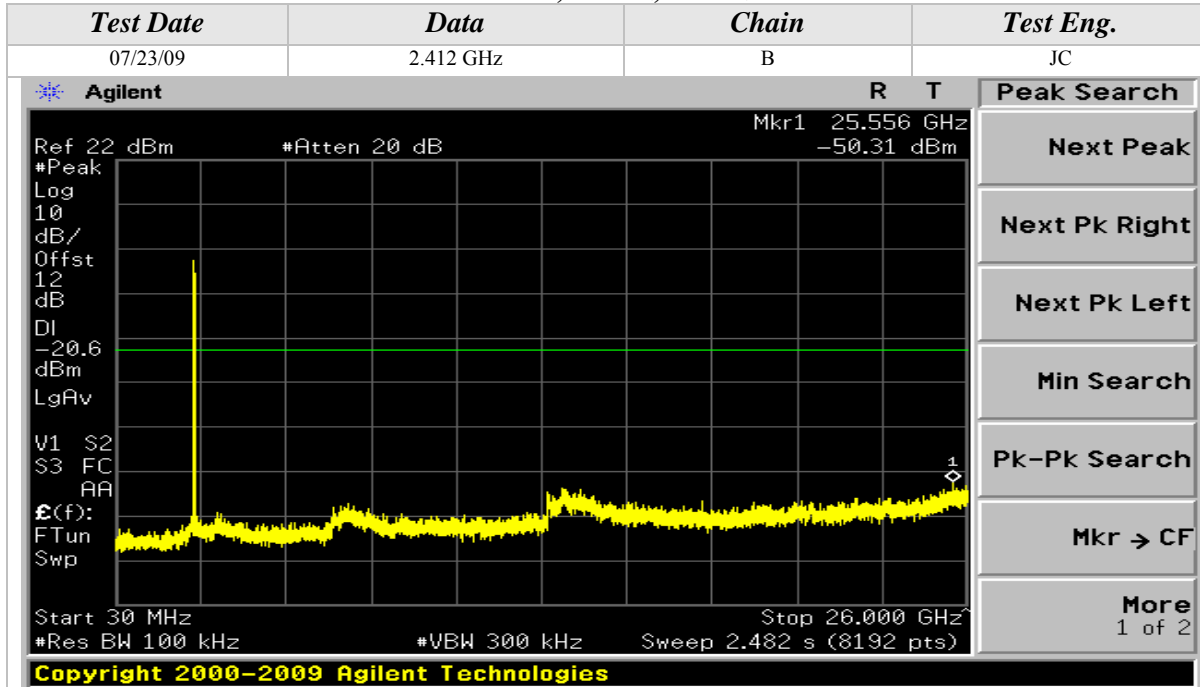

Conducted Out Of Band Emissions (Continued)

802.11n Mode, 2.4GHz, 20MHz Wide

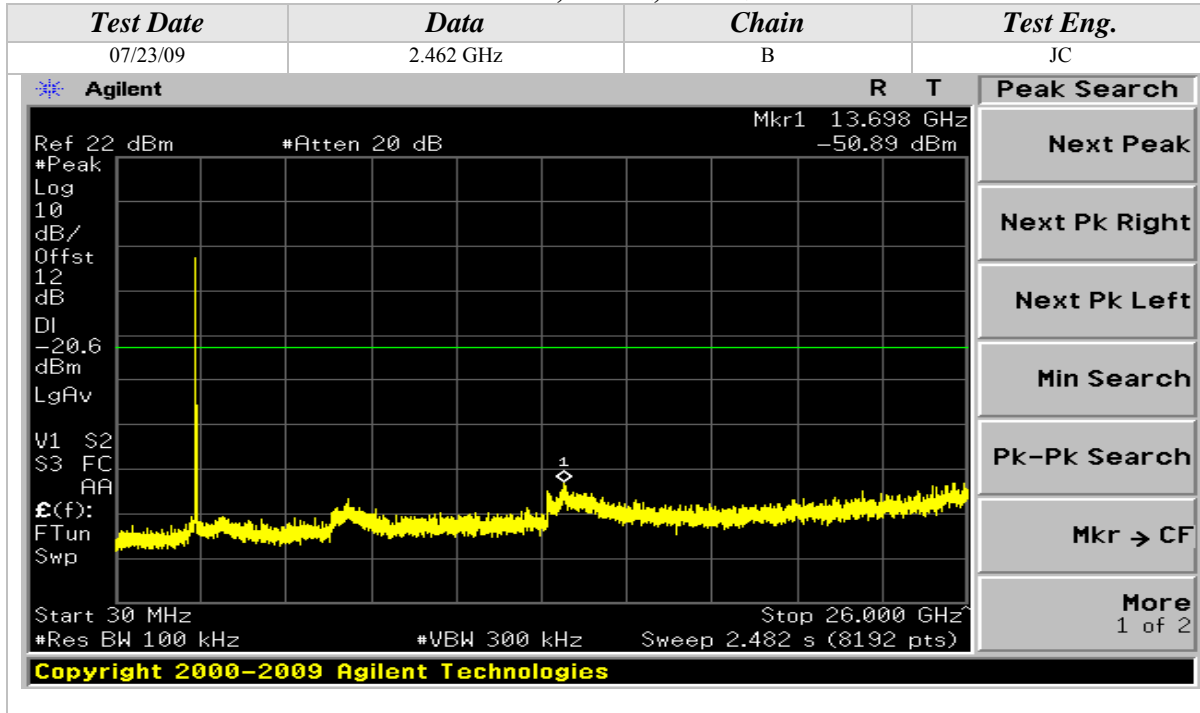

802.11n Mode, 2.4GHz, 40MHz Wide

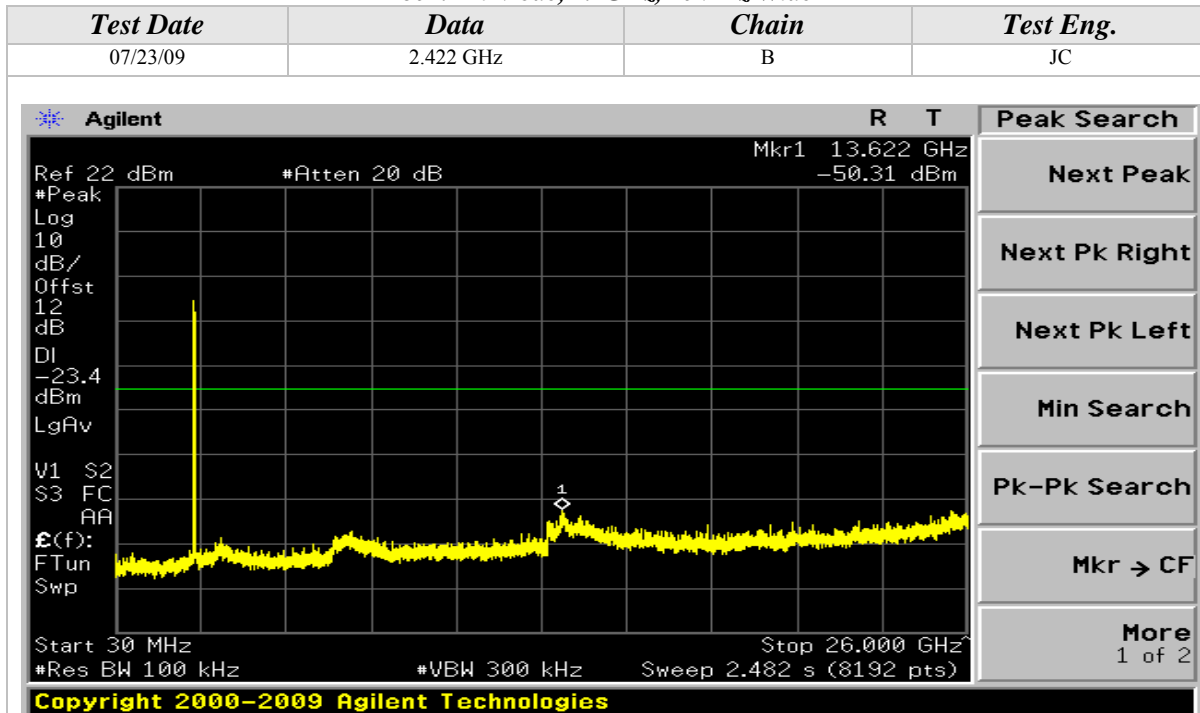

Conducted Out Of Band Emissions (Continued)

802.11n Mode, 2.4GHz, 40MHz Wide

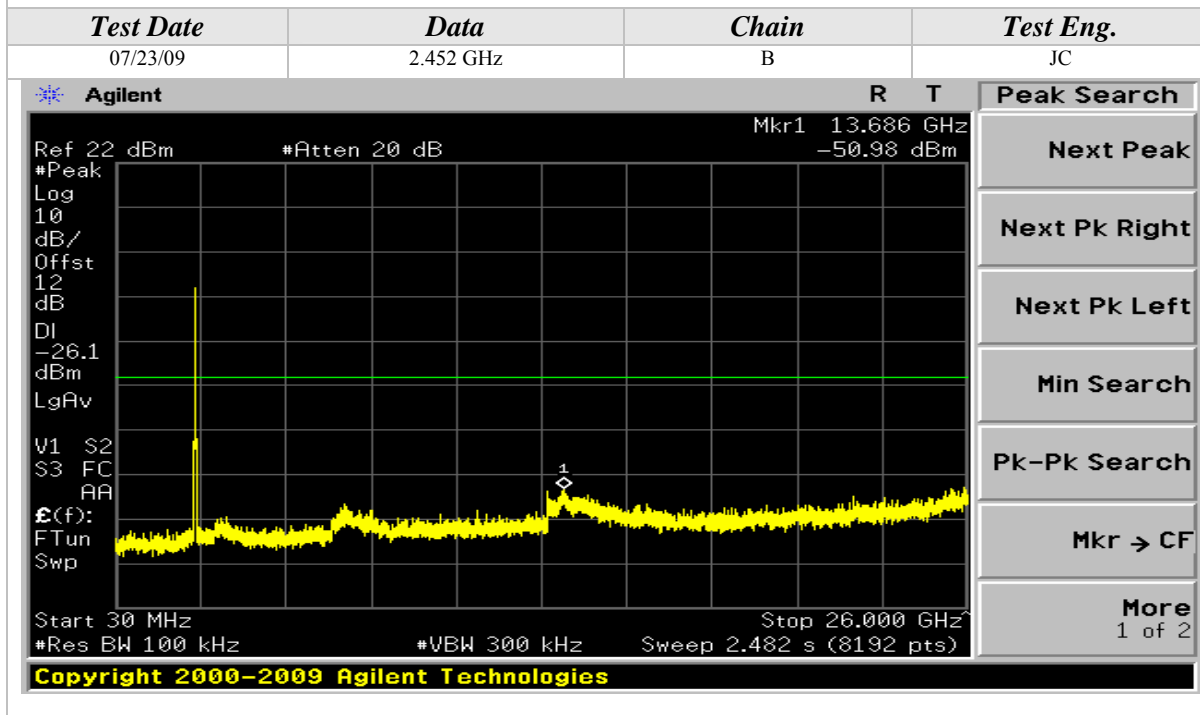
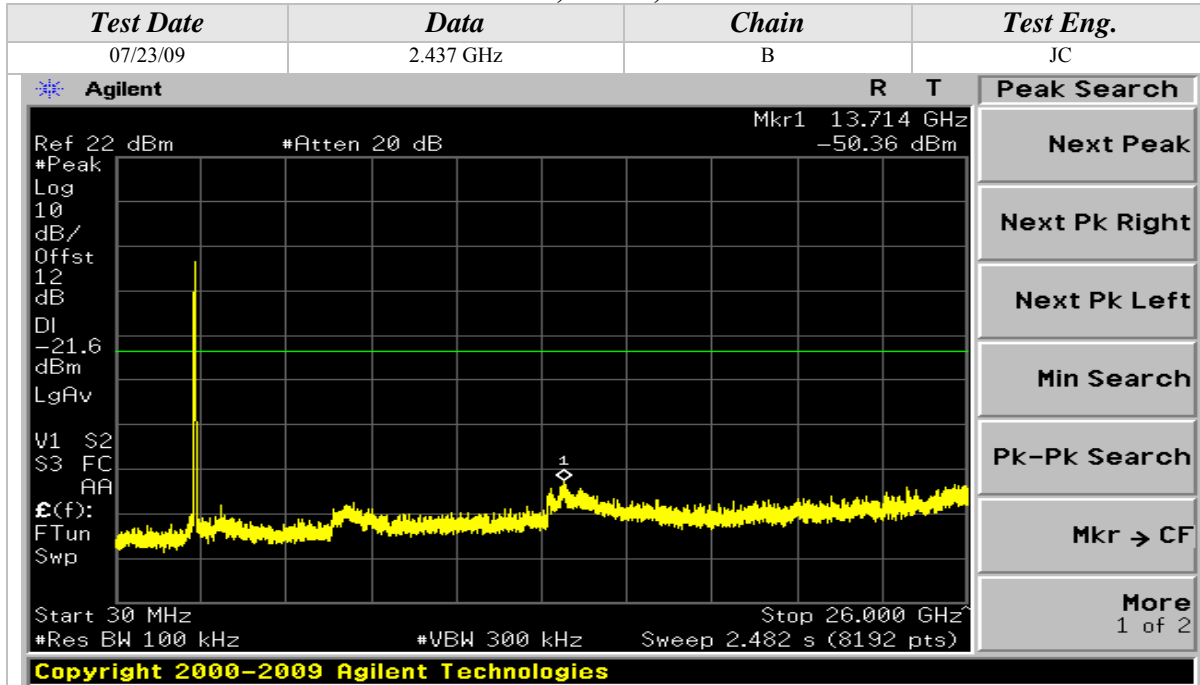

Conducted Out Of Band Emissions (Continued)

802.11n Mode, 5GHz, 20MHz Wide

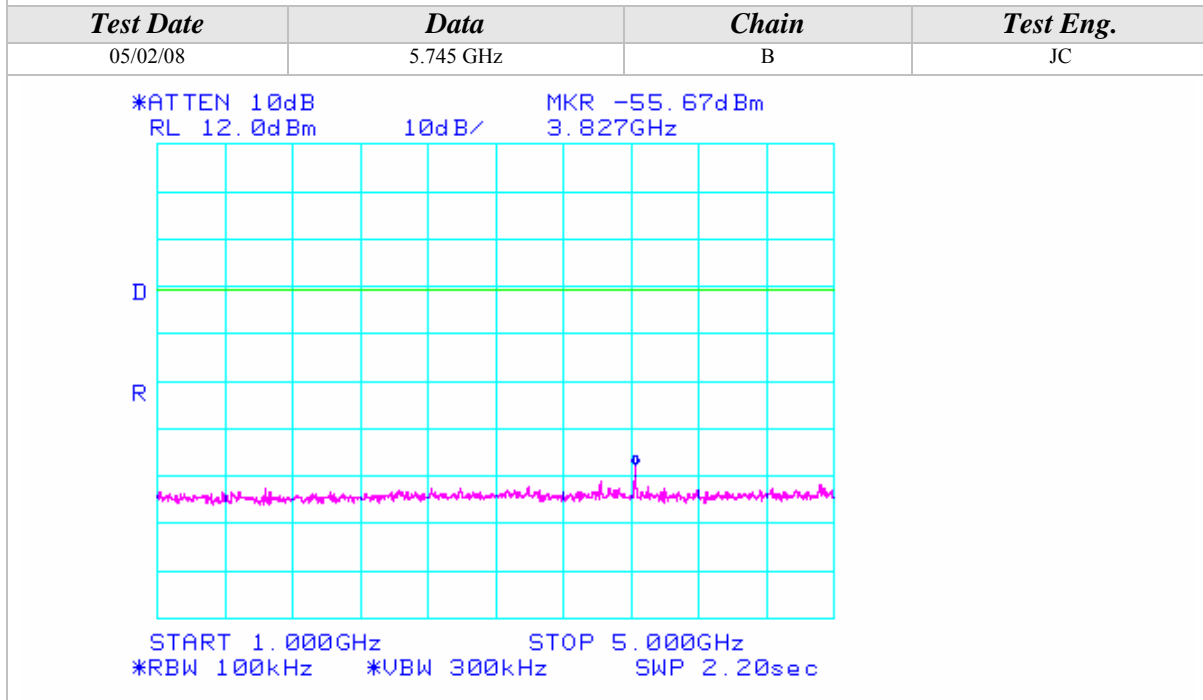
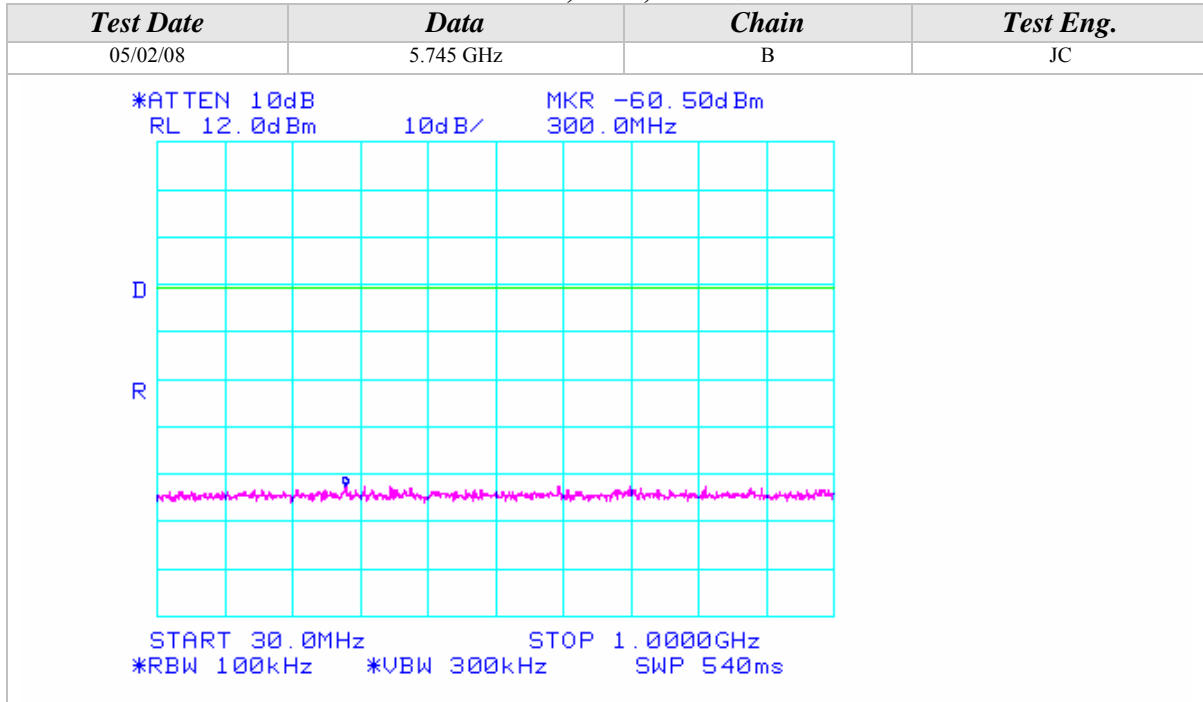



Conducted Out Of Band Emissions (Continued)

802.11n Mode, 5GHz, 20MHz Wide

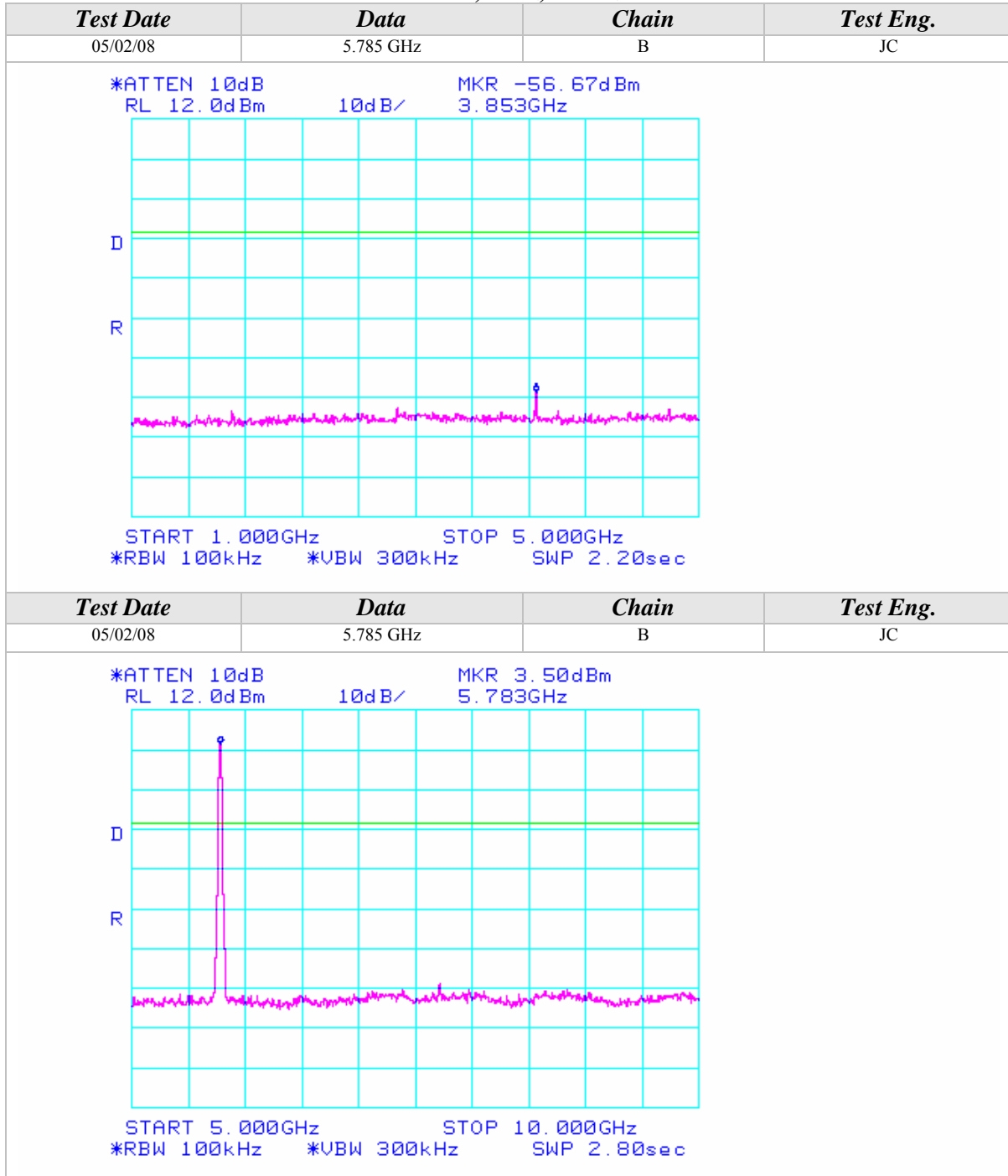



Conducted Out Of Band Emissions (Continued)

802.11n Mode, 5GHz, 20MHz Wide

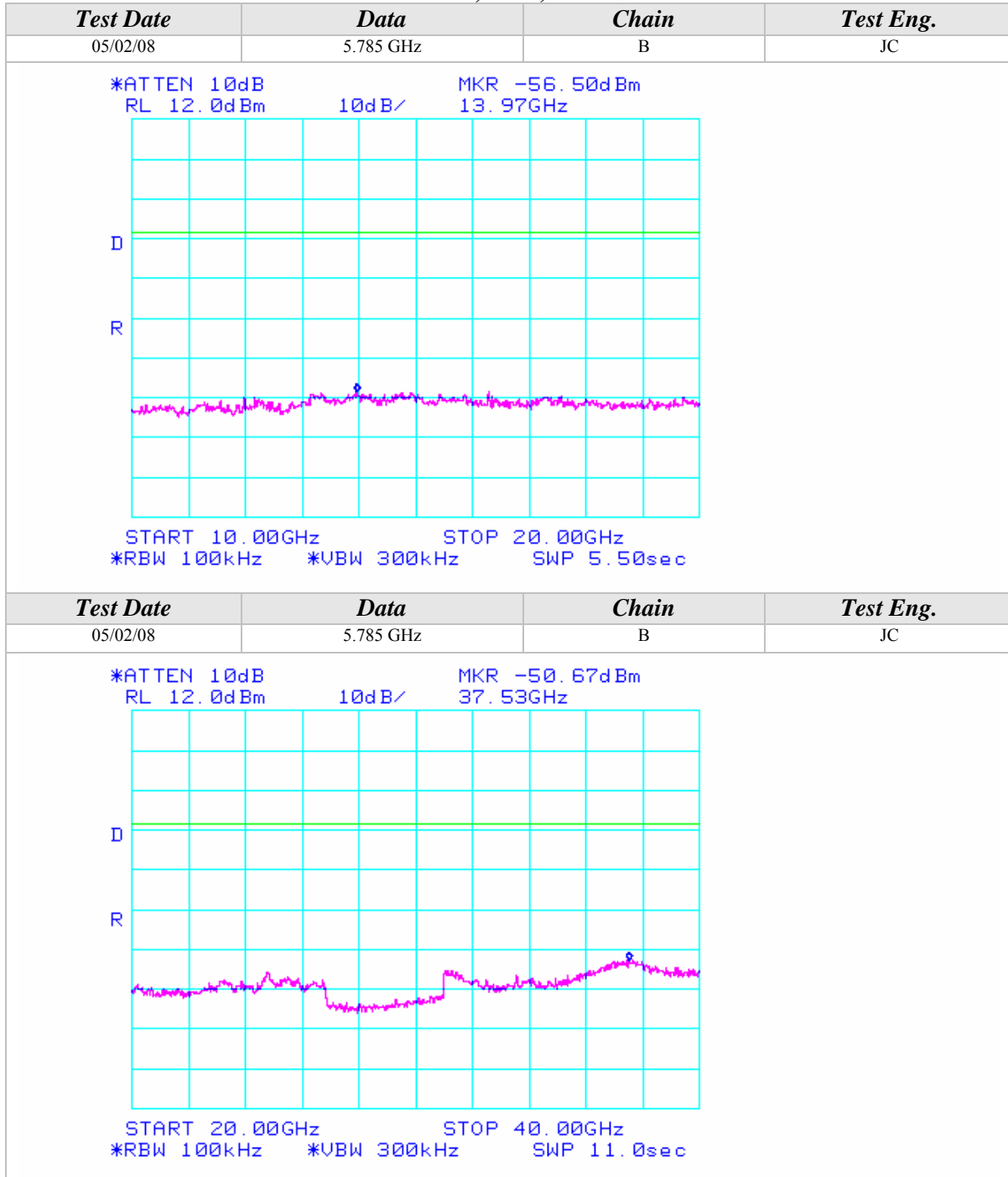



Conducted Out Of Band Emissions (Continued)

802.11n Mode, 5GHz, 20MHz Wide

Test Date	Data	Chain	Test Eng.
05/02/08	5.825 GHz	B	JC
<p>*ATTEN 10dB MKR 1.00dBm RL 12.0dBm 10dB/ 5.817GHz</p> <p>START 5.000GHz STOP 10.000GHz *RBW 100kHz *VBW 300kHz SWP 2.80sec</p>			
Test Date	Data	Chain	Test Eng.
05/02/08	5.825 GHz	B	JC
<p>*ATTEN 10dB MKR -56.50dBm RL 12.0dBm 10dB/ 13.97GHz</p> <p>START 10.00GHz STOP 20.00GHz *RBW 100kHz *VBW 300kHz SWP 5.50sec</p>			

Conducted Out Of Band Emissions (Continued)

802.11n Mode, 5GHz, 20MHz Wide

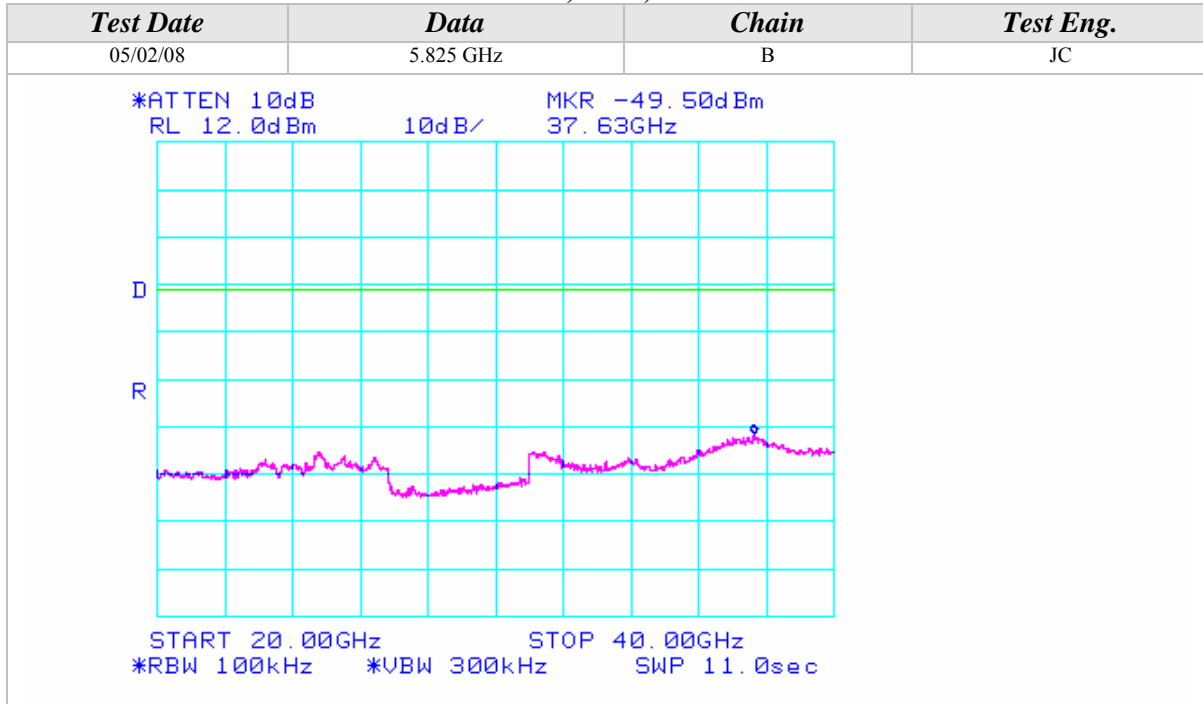



Conducted Out Of Band Emissions (Continued)

802.11n Mode, 5GHz, 40MHz Wide

Test Date	Data	Chain	Test Eng.
05/02/08	5.755 GHz	B	JC
<p>*ATTEN 10dB MKR -59.17dBm RL 12.0dBm 10dB/ 122.2MHz</p> <p>START 30.0MHz STOP 1.0000GHz *RBW 100kHz *VBW 300kHz SWP 540ms</p>			
Test Date	Data	Chain	Test Eng.
05/02/08	5.755 GHz	B	JC
<p>*ATTEN 10dB MKR -55.17dBm RL 12.0dBm 10dB/ 3.833GHz</p> <p>START 1.000GHz STOP 5.000GHz *RBW 100kHz *VBW 300kHz SWP 2.20sec</p>			



Conducted Out Of Band Emissions (Continued)

802.11n Mode, 5GHz, 40MHz Wide

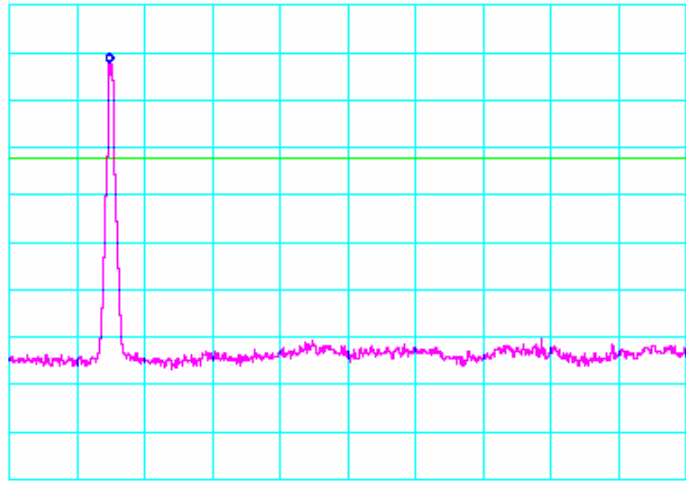
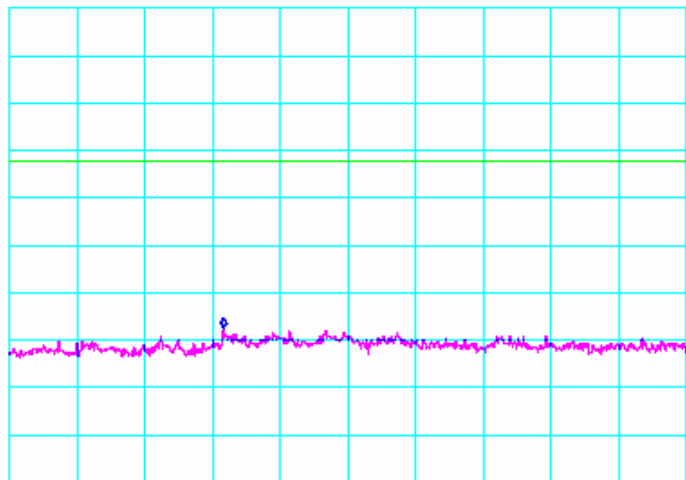
<i>Test Date</i>	<i>Data</i>	<i>Chain</i>	<i>Test Eng.</i>
05/02/08	5.755 GHz	B	JC
<p>*ATTEN 10dB MKR -.17dBm RL 12.0dBm 10dB/ 5.742GHz</p>  <p>START 5.000GHz STOP 10.000GHz *RBW 100kHz *VBW 300kHz SWP 2.80sec</p>			
<i>Test Date</i>	<i>Data</i>	<i>Chain</i>	<i>Test Eng.</i>
05/02/08	5.755 GHz	B	JC
<p>*ATTEN 10dB MKR -55.50dBm RL 12.0dBm 10dB/ 13.17GHz</p>  <p>START 10.00GHz STOP 20.00GHz *RBW 100kHz *VBW 300kHz SWP 5.50sec</p>			

Conducted Out Of Band Emissions (Continued)

802.11n Mode, 5GHz, 40MHz Wide

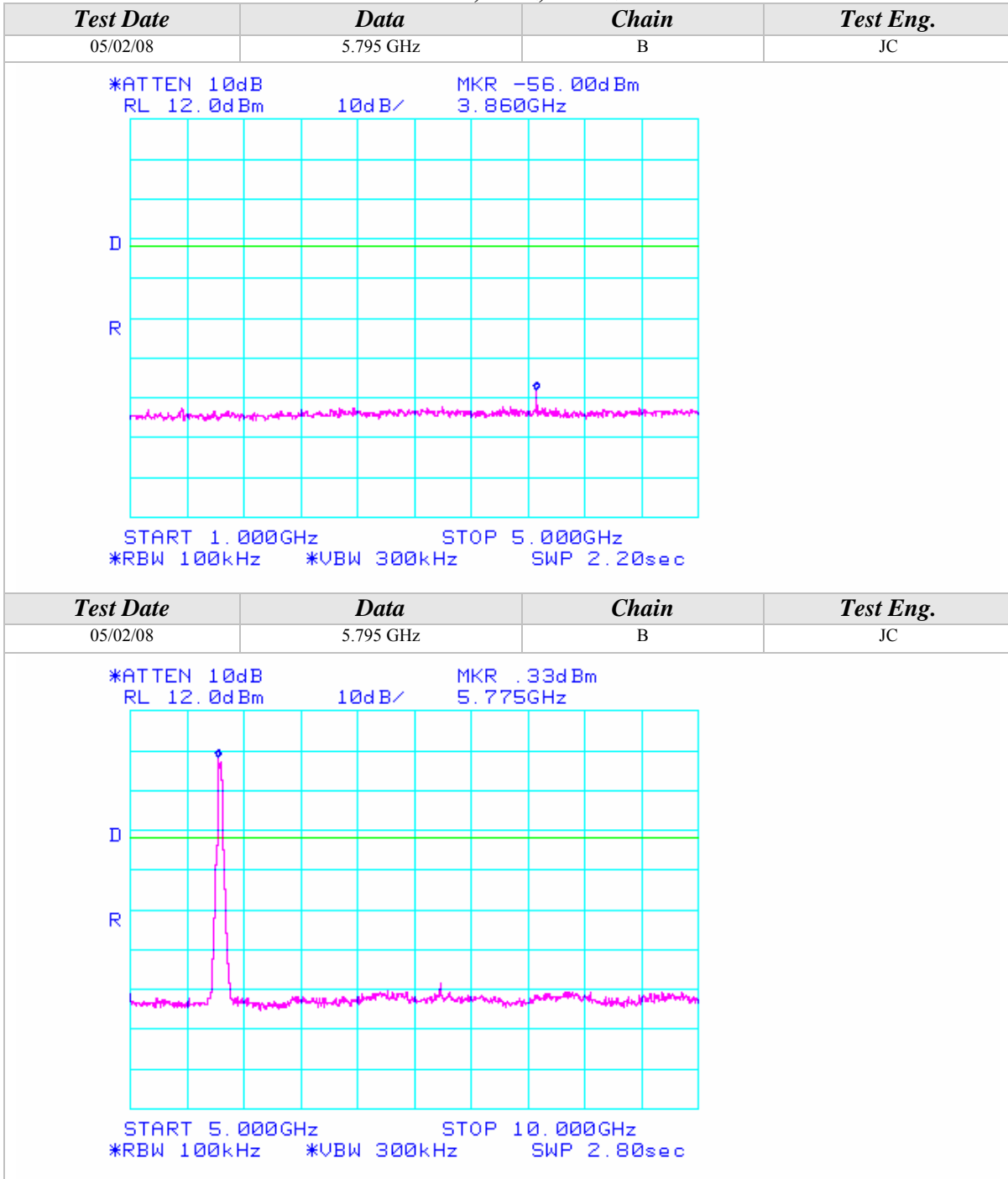



Conducted Out Of Band Emissions (Continued)

802.11n Mode, 5GHz, 40MHz Wide

Test Date	Data	Chain	Test Eng.
05/02/08	5.795 GHz	B	JC
<p>*ATTEN 10dB MKR -55.67dBm RL 12.0dBm 10dB/ 14.18GHz</p> <p>START 10.00GHz STOP 20.00GHz *RBW 100kHz *VBW 300kHz SWP 5.50sec</p>			
Test Date	Data	Chain	Test Eng.
05/02/08	5.795 GHz	B	JC
<p>*ATTEN 10dB MKR -50.33dBm RL 12.0dBm 10dB/ 36.97GHz</p> <p>START 20.00GHz STOP 40.00GHz *RBW 100kHz *VBW 300kHz SWP 11.0sec</p>			



APPENDIX B

MODIFICATIONS AND RECOMMENDATIONS

1.0	NONE