

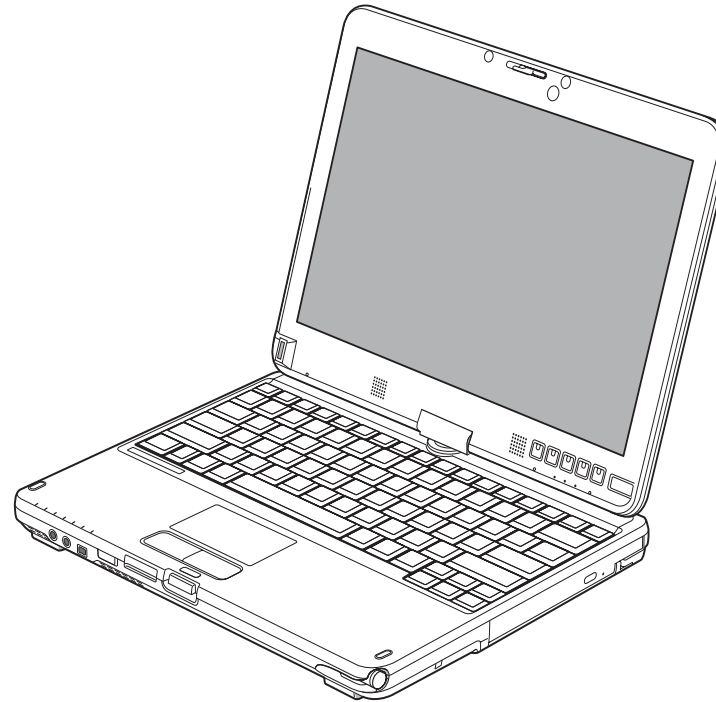

# User's Guide

Learn how to use  
your Fujitsu LifeBook  
T730 Tablet PC



  
FUJITSU



# Copyright and Trademark Information

Fujitsu America, Inc. has made every effort to ensure the accuracy and completeness of this document; however, as ongoing development efforts are continually improving the capabilities of our products, we cannot guarantee the accuracy of the contents of this document. We disclaim liability for errors, omissions, or future changes.

Fujitsu, the Fujitsu logo, and LifeBook are registered trademarks of Fujitsu Limited.

Intel, Intel Core, Centrino, and Intel Centrino Pro are trademarks or registered trademarks of Intel Corporation or its subsidiaries in the United States and other countries.

Microsoft and Windows are either registered trademarks or trademarks of Microsoft Corporation in the United States and/or other countries.

Bluetooth is a trademark of Bluetooth SIG, Inc., USA.

PowerDirector, PowerDVD, MakeDisc, and YouCam are trademarks of CyberLink Corp.

OmniPass is a trademark of Softex, Inc.

Google and Picasa are trademarks or registered trademarks of Google Incorporated.

Roxio is a trademark of Sonic Solutions.

Energy Star and the Energy Star mark are registered U.S. marks.

Wacom is a registered trademark of Wacom Company Limited.

Adobe, Acrobat, and Acrobat Reader are either a registered trademarks or trademarks of Adobe Systems Incorporated in the United States and/or other countries.

Norton and Norton Internet Security are trademarks or registered trademarks of Symantec Corporation in the United States and other countries.

All other trademarks mentioned herein are the property of their respective owners.

## WARNING



HANDLING THE CORD ON THIS PRODUCT WILL EXPOSE YOU TO LEAD, A CHEMICAL KNOWN TO THE STATE OF CALIFORNIA TO CAUSE BIRTH DEFECTS OR OTHER REPRODUCTIVE HARM.

WASH HANDS AFTER HANDLING.

© Copyright 2010 Fujitsu America, Incorporated. All rights reserved.

No part of this publication may be copied, reproduced, or translated, without prior written consent of Fujitsu. No part of this publication may be stored or transmitted in any electronic form without the written consent of Fujitsu. B6FJ-TBD-01ENZ0-00



## DECLARATION OF CONFORMITY

according to FCC Part 15

|                         |  |
|-------------------------|--|
| Responsible Party Name: | Fujitsu America, Incorporated                        |
| Address:                | 1250 E. Arques Avenue,<br>Sunnyvale, CA 94085        |
| Telephone:              | (408) 746-6000                                       |
| Declares that product:  | Base Model Configuration:<br>LifeBook T730 Tablet PC |

Complies with Part 15 of the FCC Rules.

This device complies with Part 15 of the FCC rules. Operations are subject to the following two conditions:

(1) This device may not cause harmful interference, (2) This device must accept any interference received, including interference that may cause undesired operation.

## IMPORTANT SAFETY INSTRUCTIONS

This unit requires an AC adapter to operate. Use only UL Listed I.T.E. Class II Adapters with an output rating of 19 VDC, with a current of 4.22 A (80 W).

**AC adapter output polarity:**



When using your notebook equipment, basic safety precautions should always be followed to reduce the risk of fire, electric shock and injury to persons, including the following:

- **CAUTION - HOT SURFACE:** The bottom of this notebook computer can become hot when used for long periods of time. When using this notebook, take caution to limit long term or continuous use while resting it on exposed skin, such as the lap.
- **CAUTION:** To reduce the risk of fire, use only No. 26 AWG or larger UL Listed or CSA Certified Telecommunication Line Cord.
- Do not use this product near water for example, near a bathtub, washbowl, kitchen sink or laundry tub, in a wet basement or near a swimming pool.
- Avoid using a modem during an electrical storm. There may be a remote risk of electric shock from lightning.
- Do not use a modem to report a gas leak in the vicinity of the leak.
- Use only the power cord and batteries indicated in this manual. Do not dispose of batteries in a fire. They may explode. Check with local codes for possible special disposal instructions.
- For TV tuner use: To protect from overvoltages and transients on the Cable Distribution System, make sure that the outer shield of the coaxial cable is connected to earth (grounded) at the building premise as close to the point of cable entrance as practicable, as required per NEC Article 820.93, ANSI/NFPA 70: 2005. If you have questions about your CATV installation, contact your service provider.

### SAVE THESE INSTRUCTIONS

#### For Authorized Repair Technicians Only



DANGER OF EXPLOSION IF LITHIUM (CLOCK) BATTERY IS INCORRECTLY REPLACED. REPLACE ONLY WITH THE SAME OR EQUIVALENT TYPE RECOMMENDED BY THE MANUFACTURER. DISPOSE OF USED BATTERIES ACCORDING TO THE MANUFACTURER'S INSTRUCTION.



FOR CONTINUED PROTECTION AGAINST RISK OF FIRE, REPLACE ONLY WITH THE SAME TYPE AND RATING FUSE.

## Recycling your battery

Over time, the batteries that run your mobile computer will begin to hold a charge for a shorter amount of time; this is a natural occurrence for all batteries. When this occurs, you may want to replace the battery with a fresh one\*. If you replace it, it is important that you dispose of the old battery properly because batteries contain materials that could cause environmental damage if disposed of improperly.



Fujitsu is very concerned with environmental protection, and has enlisted the services of the Rechargeable Battery Recycling Corporation (RBRC)\*\*, a non-profit public service organization dedicated to protecting our environment by recycling old batteries at no cost to you.

RBRC has drop-off points at tens of thousands of locations throughout the United States and Canada. To find the location nearest you, go to [www.RBRC.org](http://www.RBRC.org) or call 1-800-822-8837.

If there are no convenient RBRC locations near you, you can also go to the EIA Consumer Education Initiative website (<http://EIAE.org/>) and search for a convenient disposal location.

Remember – protecting the environment is a cooperative effort, and you should make every effort to protect it for current and future generations.

- \* To order a new battery for your Fujitsu mobile computer, go to the Fujitsu shopping site at [www.shopfujitsu.com](http://www.shopfujitsu.com) in the US or [www.fujitsu.ca/products/notebooks](http://www.fujitsu.ca/products/notebooks) in Canada.
- \*\* RBRC is an independent third party to which Fujitsu provides funding for battery recycling; RBRC is in no way affiliated with Fujitsu.



# Contents

## Preface

|                                     |           |
|-------------------------------------|-----------|
| <b>About This Guide</b> .....       | <b>13</b> |
| Conventions Used in the Guide ..... | 13        |
| Fujitsu Contact Information .....   | 14        |

## Chapter 1 Getting to Know Your LifeBook

|   |           |
|---|-----------|
| <b>Overview</b> .....                             | <b>16</b> |
| <b>Locating the Controls and Connectors</b> ..... | <b>17</b> |
| Top Components .....                              | 20        |
| Left-Side Panel Components .....                  | 23        |
| Right-Side Panel Components .....                 | 25        |
| Back Panel Components .....                       | 26        |
| Bottom Components .....                           | 28        |
| <b>Status Indicator Panel</b> .....               | <b>30</b> |
| Power Indicator .....                             | 30        |
| External Power Indicator .....                    | 31        |
| Battery Charging Indicators .....                 | 31        |
| Battery Level Indicator .....                     | 31        |

|   |           |
|---|-----------|
| <b>Display Panel</b> .....                                      | <b>33</b> |
| Opening the Display Panel .....                                 | 33        |
| Using the System as a Tablet .....                              | 34        |
| Adjusting Display Panel Brightness .....                        | 37        |
| Enabling/Disabling Ambient Light Sensor (Windows 7 only) .....  | 38        |
| <b>Keyboard</b> .....   | <b>39</b> |
| Using the Keyboard .....  | 39        |
| <b>Touchpad/Active Digitizer/Touchscreen</b> .....              | <b>42</b> |
| Using the Touchpad .....  | 42        |
| Active Digitizer Display .....                                  | 47        |
| Using the Optional Capacitive Touchscreen .....                 | 51        |
| Installing a Pen Tether .....                                   | 52        |
| <b>Volume Control</b> .....                                     | <b>53</b> |
| Controlling the Volume .....                                    | 53        |
| <b>Modular Bay Devices</b> .....                                | <b>54</b> |
| Removing and Installing Modular Devices .....                   | 55        |
| <b>LifeBook Security/Tablet PC Buttons</b> .....                | <b>56</b> |
| Security Button Functions .....                                 | 56        |
| Pre-logon button functions .....                                | 57        |
| Post-logon button functions .....                               | 59        |
| Changing Tablet PC Button Functions .....                       | 61        |
| Setting up LifeBook Security Panel .....                        | 62        |
| Passwords .....   | 62        |
| Using Your LifeBook Security Panel .....                        | 64        |
| Precautions .....   | 65        |
| Uninstalling/Re-installing the Security Panel Application ..... | 65        |

## **Chapter 2 Getting Started with Your LifeBook**

|  |           |
|--|-----------|
| <b>Power Sources</b> .....                             | <b>68</b> |
| Connecting the Power Adapters .....                    | 68        |
| <b>Starting Your LifeBook Tablet PC</b> .....          | <b>70</b> |
| Power On .....   | 70        |
| Boot Sequence .....                                    | 71        |
| Hard Disk Drive Passwords .....                        | 72        |
| BIOS Setup Utility .....                               | 72        |
| Booting the System .....                               | 73        |
| Starting Windows the first time .....                  | 74        |
| Registering Your LifeBook Tablet PC with Fujitsu ..... | 75        |
| Installing ClickMe! .....                              | 75        |
| Fujitsu Driver Update Utility .....                    | 76        |
| <b>Power Management</b> .....                          | <b>77</b> |
| Power/Suspend/Resume Button .....                      | 77        |
| Sleep Mode .....                                       | 77        |
| Hibernation (Save-to-Disk) Feature .....               | 79        |
| Windows Power Management .....                         | 79        |
| Restarting the System .....                            | 79        |
| Powering Off .....                                     | 80        |
| ENERGY STAR® Compliance .....                          | 80        |

## **Chapter 3 User-Installable Features**

|  |           |
|--|-----------|
| <b>Lithium ion Battery</b> .....               | <b>82</b> |
| Recharging the Batteries .....                 | 83        |
| Replacing the Battery .....                    | 85        |
| <b>Memory Stick/Secure Digital Cards</b> ..... | <b>87</b> |
| Installing Memory Stick/SD Cards .....         | 88        |
| Removing A Memory Stick/SD Card .....          | 88        |



|   |            |
|---|------------|
| <b>ExpressCards</b> .....                     | <b>89</b>  |
| Installing ExpressCards .....                 | 89         |
| Removing ExpressCards .....                   | 90         |
| <b>Memory Upgrade Module</b> .....            | <b>91</b>  |
| Installing Memory Upgrade Modules .....       | 91         |
| Removing a Memory Upgrade Module .....        | 93         |
| Checking the Memory Capacity .....            | 93         |
| <b>Optical Drive</b> .....                    | <b>94</b>  |
| Media Player Software .....                   | 94         |
| Loading Media on Your Drive .....             | 95         |
| Removing Media .....                          | 97         |
| Emergency Optical<br>Drive Tray Release ..... | 97         |
| Using the Media Player Software .....         | 97         |
| Using Media Player on Battery Power .....     | 99         |
| <b>Device Ports</b> .....                     | <b>100</b> |
| Internal LAN (RJ-45) Jack .....               | 100        |
| Port Replicator Connector .....               | 100        |
| Universal Serial Bus Ports .....              | 101        |
| IEEE 1394 Port .....                          | 101        |
| Headphone Jack .....                          | 102        |
| Microphone Jack .....                         | 103        |
| HDMI Port .....                               | 103        |
| External Video Port .....                     | 103        |

|                  |  |            |
|------------------|--|------------|
| <b>Chapter 4</b> | <b>Troubleshooting Your LifeBook</b>                   |            |
|                  | <b>Troubleshooting.....</b>                            | <b>105</b> |
|                  | Identifying the Problem .....                          | 105        |
|                  | Specific Problems .....                                | 107        |
|                  | Power On Self Test Messages .....                      | 117        |
|                  | <b>Restoring Your Pre-installed Software.....</b>      | <b>121</b> |
|                  | Re-installing Individual Drivers and Applications..... | 121        |
|                  | Restoring the Operating System for Windows.....        | 122        |
|                  | Automatically Downloading Driver Updates.....          | 125        |
| <b>Chapter 5</b> | <b>Care and Maintenance</b>                            |            |
|                  | <b>Caring for your LifeBook Tablet PC.....</b>         | <b>127</b> |
|                  | Cleaning your LifeBook Tablet PC .....                 | 129        |
|                  | Cleaning the dust filter .....                         | 130        |
|                  | Storing your LifeBook Tablet PC.....                   | 130        |
|                  | Traveling with your LifeBook Tablet PC.....            | 131        |
|                  | Batteries .....  | 132        |
|                  | Media Care .....                                       | 133        |
|                  | Express Cards .....                                    | 134        |
| <b>Chapter 6</b> | <b>System Specifications</b>                           |            |
|                  | <b>Specifications.....</b>                             | <b>135</b> |
|                  | Configuration Label .....                              | 135        |
|                  | Microprocessor .....                                   | 136        |
|                  | Chipset .....  | 136        |
|                  | Memory.....  | 136        |
|                  | Video.....   | 136        |
|                  | Digitizer .....  | 137        |
|                  | Audio .....  | 137        |

|  |     |
|--|-----|
| Mass Storage Device Options . . . . .  | 137 |
| Modular Bay Devices . . . . .          | 137 |
| Features . . . . .                     | 138 |
| Device Ports . . . . .                 | 139 |
| Keyboard . . . . .                     | 140 |
| Power . . . . .                        | 140 |
| Dimensions and Weight . . . . .        | 141 |
| Environmental Requirements . . . . .   | 141 |
| Popular Accessories . . . . .          | 141 |
| Pre-Installed Software . . . . .       | 142 |
| Learning About Your Software . . . . . | 143 |

## **Glossary/Regulatory**

|   |            |
|---|------------|
| <b>Glossary . . . . .</b>               | <b>146</b> |
| <b>Regulatory Information . . . . .</b> | <b>162</b> |

## **Appendix A: WLAN User's Guide**

|   |            |
|---|------------|
| <b>Before Using the Optional Wireless LAN . . . . .</b> | <b>166</b> |
| Wireless LAN Device Covered by this Document . . . . .  | 166        |
| Characteristics of the WLAN Device . . . . .            | 166        |
| Wireless LAN Modes Using this Device . . . . .          | 167        |
| Deactivating/Disconnecting the WLAN Device . . . . .    | 169        |
| Deactivation Using the Wireless On/Off Switch . . . . . | 170        |
| Disconnection Using the Icon in the Taskbar . . . . .   | 170        |
| Activating the WLAN Device . . . . .                    | 170        |
| <b>Configuring the Wireless LAN . . . . .</b>           | <b>171</b> |
| Configuring the WLAN . . . . .                          | 171        |
| Connection to the network . . . . .                     | 171        |

|   |            |
|---|------------|
| <b>Troubleshooting the WLAN</b> .....           | <b>172</b> |
| Troubleshooting .....                           | 172        |
| <b>WLAN Specifications</b> .....                | <b>174</b> |
| Specifications .....                            | 174        |
| <b>Using the Bluetooth Device</b> .....         | <b>177</b> |
| What is Bluetooth .....                         | 177        |
| Where to Find Information About Bluetooth ..... | 177        |

## **Appendix B: Fingerprint Sensor Device**

|  |            |
|--|------------|
| <b>Introducing the Fingerprint Sensor Device</b> ..... | <b>179</b> |
| Getting Started .....                                  | 180        |
| Installing OmniPass .....                              | 180        |
| User Enrollment .....                                  | 183        |
| Using OmniPass .....                                   | 185        |
| Configuring OmniPass .....                             | 191        |
| OmniPass Control Center .....                          | 193        |
| Troubleshooting .....                                  | 195        |
| <b>Index</b> .....                                     | <b>197</b> |



# Preface

---

## About This Guide

The LifeBook T730 Tablet PC from Fujitsu America is a powerful convertible computer. It can be used either as a standard notebook using keyboard input, or in tablet configuration using pen input. It is powered by an all new 2010 Intel® Core™ Processor , has a built-in color display with either an active digitizer or optional dual digitizer, and brings the computing power of desktop personal computers to a portable and versatile environment.

This manual explains how to operate your LifeBook T730 Tablet PC's hardware and pre-installed system software.

## Conventions Used in the Guide

Keyboard and on-screen keys appear in brackets. Example: [Fn], [F1], [ESC], [ENTER] and [CTRL].

Pages with additional information about a specific topic are cross-referenced within the text. For example: (“See [Installation Procedure on page 43](#)”). Note that all cross-references are linked to the referenced items, so by clicking the link, you will automatically go to the referenced item or page.

On-screen menu items appear in bold. Example: “Click **Fujitsu Menu**, and select your choice”.



THE INFORMATION ICON HIGHLIGHTS INFORMATION THAT WILL ENHANCE YOUR UNDERSTANDING OF THE SUBJECT MATERIAL.



THE CAUTION ICON HIGHLIGHTS INFORMATION THAT IS IMPORTANT TO THE SAFE OPERATION OF YOUR COMPUTER, OR TO THE INTEGRITY OF YOUR FILES. PLEASE READ ALL CAUTION INFORMATION CAREFULLY.



THE WARNING ICON HIGHLIGHTS INFORMATION THAT CAN BE HAZARDOUS TO EITHER YOU, YOUR LIFEBOOK TABLET PC, OR YOUR FILES. PLEASE READ ALL WARNING INFORMATION CAREFULLY.

## **Fujitsu Contact Information**

### **Service and Support**

You can contact Fujitsu Service and Support in the following ways:

- Toll free: 1-800-8Fujitsu (1-800-838-5487)
- Website: <http://www.computers.us.fujitsu.com/support>

Before you place the call, you should have the following information ready so that the customer support representative can provide you with the fastest possible solution:

- Product name
- Product configuration number
- Product serial number
- Purchase date

- Conditions under which the problem occurred
- Any error messages that have occurred
- Type of device connected, if any

### **Fujitsu Shopping Online**

You can go directly to the online store by going to the website at: [www.shopfujitsu.com](http://www.shopfujitsu.com).



YOU MUST HAVE AN ACTIVE INTERNET CONNECTION TO USE THE ONLINE URL LINKS.

### **Limited Warranty**

Your LifeBook T730 Tablet PC is backed by a Fujitsu International Limited Warranty. Check the service kit that came with your Tablet PC for the Limited Warranty period and terms and conditions.

## Chapter 1

# Getting to Know Your LifeBook

### Overview

This section describes the components of your Fujitsu LifeBook T730 Tablet PC. We strongly recommend that you read it before using your Tablet PC – even if you are already familiar with notebook computers.

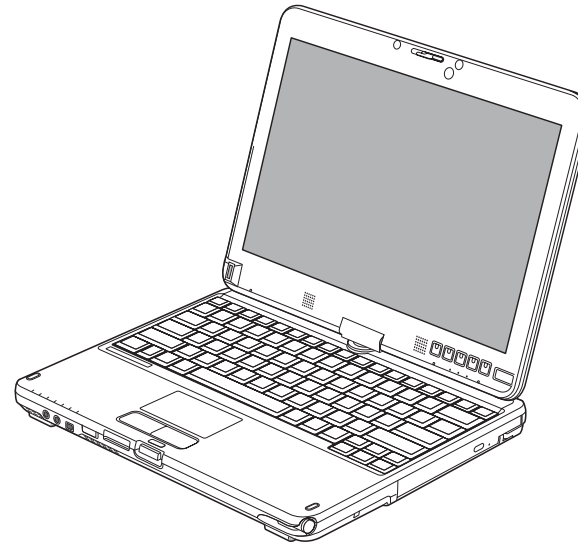















Figure 1. Fujitsu LifeBook T730 Tablet PC



## Locating the Controls and Connectors

Connectors and peripheral interfaces on the LifeBook T730 Tablet PC and the optional port replicator allow you to connect a variety of devices. Specific locations are illustrated in Figures 2 through 6. The table below provides a short description of each icon on the LifeBook T730 Tablet PC and/or optional port replicator. Each of the icons is either molded into or printed on the Tablet PC or port replicator chassis.

| Connection                    | Tablet PC Icon  | Purpose   |
|-------------------------------|---|---|
| DC in connector               |    | Connect an external power source such as the AC adapter or auto/airline adapter.  |
| SD Card/<br>Memory Stick Slot |    | The Secure Digital (SD) card/Memory Stick slot allows you to insert a flash memory card for data storage. Flash memory cards allow you to transfer data to and from a variety of different digital devices. |
| USB Port                      |    | Connect Universal Serial Bus 2.0 or 1.1 compliant devices to the Tablet PC.   |
| Microphone/Line<br>In Jack    |    | Connect an external microphone. The internal microphone is disabled when you plug in an external microphone.  |
| Headphone/Line<br>Out Jack    |   | Connect stereo headphones or powered external speakers. The internal speaker is disabled when you plug in external headphones or powered speakers.  |
| HDMI                          |  | The HDMI port allows you to connect compatible digital devices with your computer (such as a high-definition television or AV receiver).  |
| Dock port                     |  | Connect the Tablet PC port replicator or other approved docking device. Refer to documentation accompanying the dock for more information.  |

| Connection                           | Tablet PC Icon  | Purpose  |
|--------------------------------------|---|--|
| Security lock slot                   |    | The security slot allows you to secure the Tablet PC using compatible locking devices.   |
| Suspend/Resume button                |    | The Suspend/Resume button allows you to suspend Tablet PC activity without powering off, resume your Tablet PC from suspend mode, and power on the system when it has been shut down from Windows.   |
| Local Area Network (LAN)             |    | The LAN (RJ-45) jack is used to connect the internal 10/100/1000* Base-T/Tx Ethernet to a Local Area Network (LAN) in your office or home, or broadband devices such as a cable modem, DSL, or satellite Internet.<br><i>*1000 Mbps, commonly referred to as Gigabit Ethernet.</i> |
| Wireless LAN/Bluetooth On-Off Switch |    | The WLAN/Bluetooth switch allows you to turn power to the optional wireless devices on and off.  |
| External Video port                  |    | The external video port allows you to connect an external monitor or LCD projector to your computer.   |
| Digital Video Interface              |   | The DVI-D port on the optional port replicator allows you to connect a flat-panel LCD monitor or television that is equipped with a DVI-D port for ultra-crisp digital images and graphics.  |
| IEEE1394 port                        |  | The IEEE 1394 jack allows you to connect IEEE 1394 (Firewire) devices such as digital video cameras and external hard drives to your Tablet PC.  |

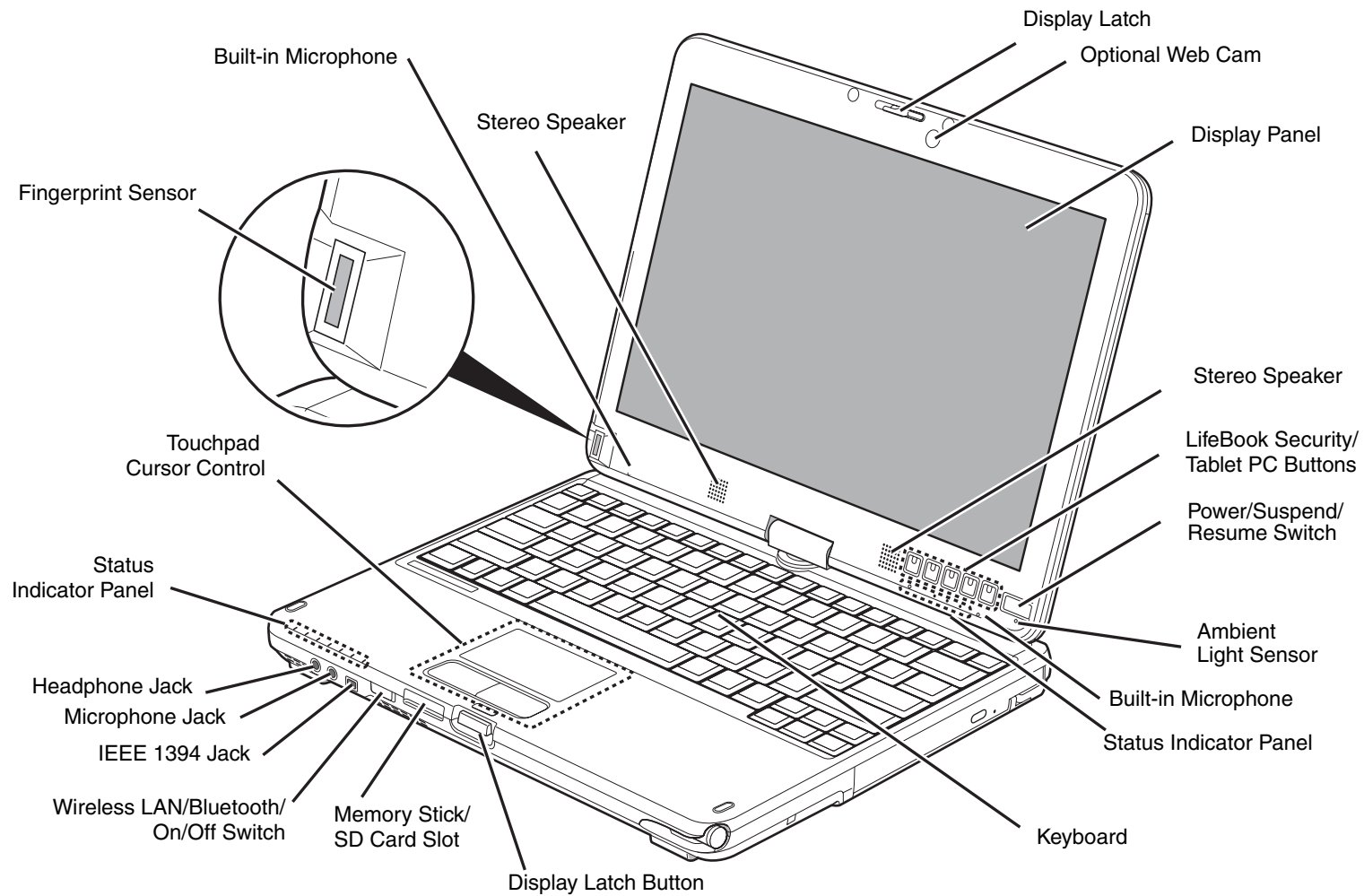

**Figure 2. LifeBook Tablet PC with display open**

## **Top Components**

The following is a brief description of your LifeBook Tablet PC's top components.

### **Display Latch**

The display latch is used to secure the tablet PC display when it is closed.

### **Web Camera**

The optional 2.0 megapixel web cam can be used to take pictures of yourself to send over the internet.

### **Display Panel**

The display panel is a color LED panel with backlighting for the display of text and graphics. There are two different displays available: an active digitizer that is used with a stylus, and a dual digitizer that can be used with either a stylus or your fingers.

### **Dual Stereo Speakers**

The built-in dual speakers provide stereo sound.

### **LifeBook Security/Tablet PC Buttons**

The LifeBook Security/Tablet PC Buttons provide password security for your system, as well as one-touch application launch capability. See “LifeBook Security/Tablet PC Buttons” on page 55.

### **Power/Suspend/Resume Switch**

The Power/Suspend/Resume button allows you to suspend Tablet PC activity without powering off, resume your LifeBook Tablet PC from sleep mode, and power on your Tablet PC when it has been shut down from Windows. See “Power/Suspend/Resume Button” on page 76.

### **Ambient Light Sensor**

The ambient light sensor measures the light in which the computer is operating and automatically adjusts the brightness of the display to suit the lighting conditions. See “Enabling/Disabling Ambient Light Sensor (Windows 7 only)” on page 36.

### **Status Indicator Panels**

The Status Indicator Panels display symbols that correspond to specific components of your Tablet PC. Status indicators are located in two locations: on the left front edge of the system (system status indicators) and below the application buttons (button status indicators). See “Status Indicator Panel” on page 30.

### **Keyboard**

A full-size keyboard with dedicated Windows keys. See “Keyboard” on page 38.

### **Display Latch Button**

The display latch button allows you to unlatch the front of the display from the case.

### **Memory Stick/SD Card Slot**

The Memory Stick/SD card slot allows you to install a Memory Stick or a Secure Digital (SD) card for data storage. This architecture allows you to transfer data from a variety of different digital devices. See “Installing Memory Stick/SD Cards” on page 87.

### **Wireless LAN/Bluetooth On/Off Switch**

The wireless LAN/Bluetooth On/Off switch is used to turn on and off the optional wireless devices. Switching the device off when not in use will help to extend battery life. See “Activating the WLAN Device” on page 169. Note that there is no wireless WAN available for systems with the optional dual digitizer.

### **IEEE 1394 (4-pin) Jack**

The 4-pin 1394 jack is used to connect between your Tablet PC and an IEEE 1394 peripheral such as a digital video camera for fast file transfer. See “IEEE 1394 Port” on page 100.

### **Microphone Jack**

The microphone jack allows you to connect an external mono microphone. See “Microphone Jack” on page 102.

**Headphone Jack**

The headphone jack allows you to connect headphones. See “Headphone Jack” on page 101.

**Touchpad Pointing Device**

The Touchpad pointing device is a mouse-like cursor control with a left and right button. See “Touchpad/Active Digitizer/Touchscreen” on page 41.

**Fingerprint Sensor**

The fingerprint sensor device allows you to log onto your system and password-protected websites and applications by swiping your finger over the sensor. See “Introducing the Fingerprint Sensor Device” on page 177.

**Dual Built-in Microphones**

The built-in microphones allows you to record voice and annotations.

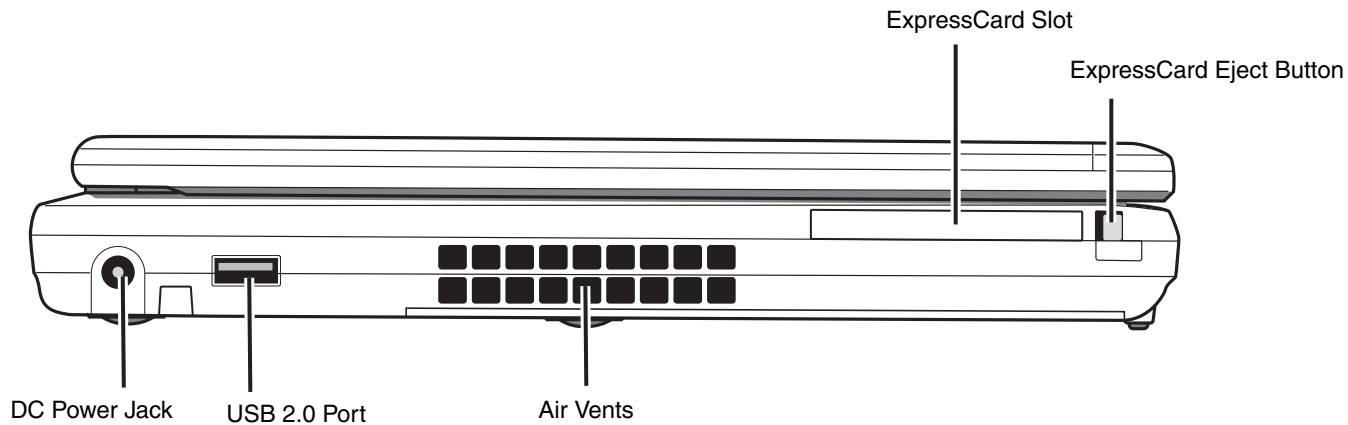

**Figure 3. LifeBook Tablet PC left-side panel**

### **Left-Side Panel Components**

The following is a brief description of your LifeBook Tablet PC's left-side components.

#### **DC Power Jack**

The DC power jack allows you to plug in the AC adapter to power your LifeBook Tablet PC and charge the internal Lithium ion battery.

#### **USB 2.0 Ports**

The USB 2.0 ports (one on the left side, two on the rear) allow you to connect Universal Serial Bus devices. USB 2.0 transfers data at up to 480 Mbps and is backward-compatible with USB 1.1 devices, which transfer data at up to 12 Mbps. See "Universal Serial Bus Ports" on page 100.

#### **Air Vents**

The air vents are used to cool the system to prevent overheating.



TO PROTECT YOUR TABLET PC FROM DAMAGE AND TO OPTIMIZE PERFORMANCE, BE SURE TO **KEEP ALL AIR VENTS UNOBSTRUCTED, CLEAN, AND CLEAR OF DEBRIS**. THIS MAY REQUIRE PERIODIC CLEANING, DEPENDING UPON THE ENVIRONMENT IN WHICH THE SYSTEM IS USED.

DO NOT OPERATE THE TABLET PC IN AREAS WHERE THE AIR VENTS CAN BE OBSTRUCTED, SUCH AS IN TIGHT ENCLOSURES OR ON SOFT SURFACES LIKE A BED OR CUSHION.

### **ExpressCard Slot**

The ExpressCard Slot allows you to install an ExpressCard. See “ExpressCards” on page 88.

### **ExpressCard Eject Button**

The ExpressCard eject button is used for removing an ExpressCard from the slot.



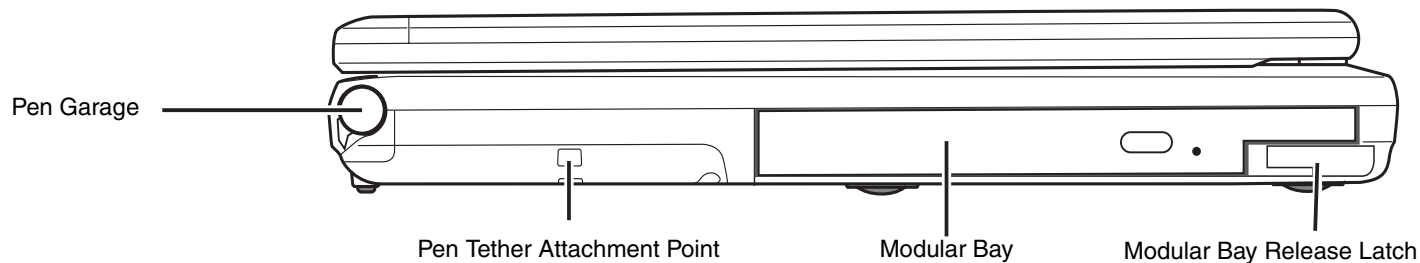

**Figure 4. LifeBook Tablet PC right-side panel**

### **Right-Side Panel Components**

The following is a brief description of your LifeBook Tablet PC's right-side components.

#### **Pen Garage**

The pen garage is used to store the pen (also called a “stylus”) when not in use. The pen is used as the interface with the active digitizer display.

#### **Modular Bay**

The Modular Bay can accommodate one of the following devices. See “Modular Bay Devices” on page 53.

- Modular Dual-Layer Multi-Format DVD Writer
- Modular bay battery
- Modular 2nd hard disk drive
- Weight Saver

#### **Modular Bay Release Latch**

The modular bay release latch is used to release the modular bay device from the modular bay.

#### **Pen Tether Attachment Point**

The pen tether attachment point is used to attach your pen to the system to prevent its loss.

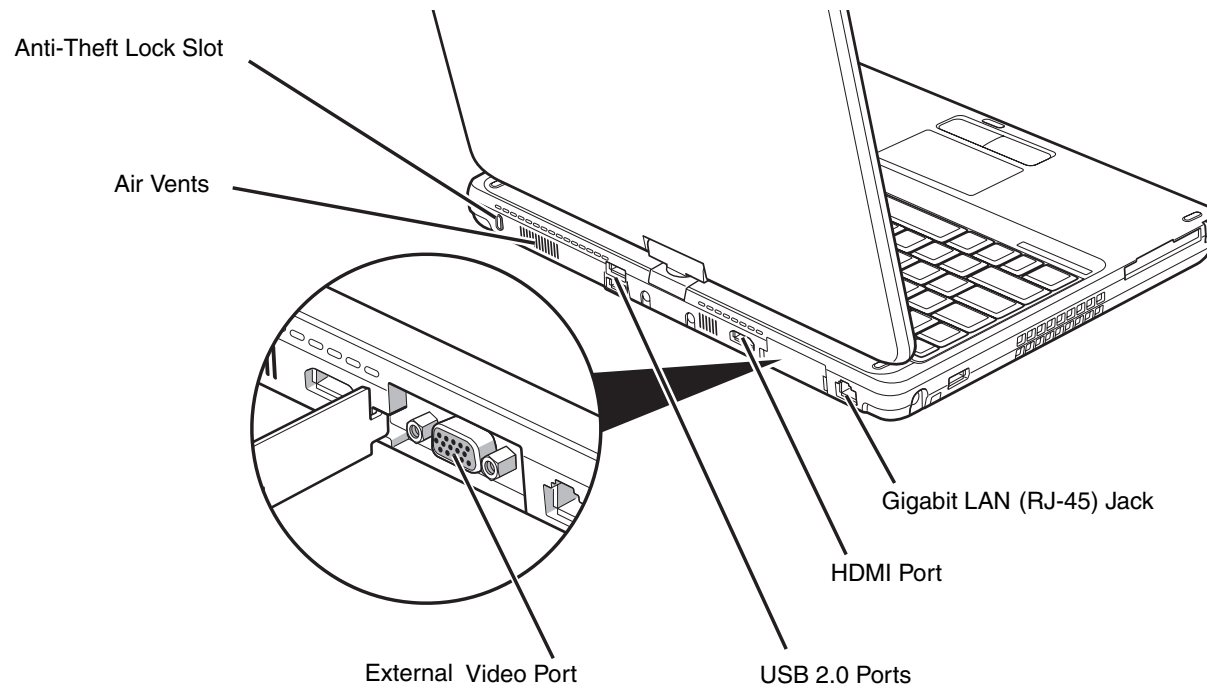

**Figure 5. LifeBook Tablet PC back panel**

### **Back Panel Components**

Following is a brief description of your LifeBook Tablet PC's back panel components.

#### **Anti-theft Lock Slot**

The anti-theft lock slot allows you to attach an optional physical lock down device.

#### **Air Vents**

The air vents allow air to circulate through the system to cool down the components.



TO PROTECT YOUR TABLET PC FROM DAMAGE AND TO OPTIMIZE PERFORMANCE, BE SURE TO **KEEP ALL AIR VENTS UNOBSTRUCTED, CLEAN, AND CLEAR OF DEBRIS**. THIS MAY REQUIRE PERIODIC CLEANING, DEPENDING UPON THE ENVIRONMENT IN WHICH THE SYSTEM IS USED.

DO NOT OPERATE THE TABLET PC IN AREAS WHERE THE AIR VENTS CAN BE OBSTRUCTED, SUCH AS IN TIGHT ENCLOSURES OR ON SOFT SURFACES LIKE A BED OR CUSHION.

### **External Video Port**

The external monitor port allows you to connect an external monitor or LCD projector. See “External Video Port” on page 102.

### **USB 2.0 Ports**

The USB 2.0 ports allow you to connect Universal Serial Bus devices. USB 2.0 transfers data at up to 480Mbps and is backward-compatible with USB 1.1 devices, which transfer data at up to 12Mbps. See “Universal Serial Bus Ports” on page 100.

### **HDMI Port**

The HDMI port is used to connect compatible digital devices with your computer (such as a high-definition television or AV receiver). See “*HDMI Port*” on page 102.

### **Gigabit LAN (RJ-45) Jack**

The internal LAN (RJ-45) jack is used for an internal Gigabit (10Base-T/100Base-Tx/1000Base-T) Ethernet LAN connection. See “Internal LAN (RJ-45) Jack” on page 99.

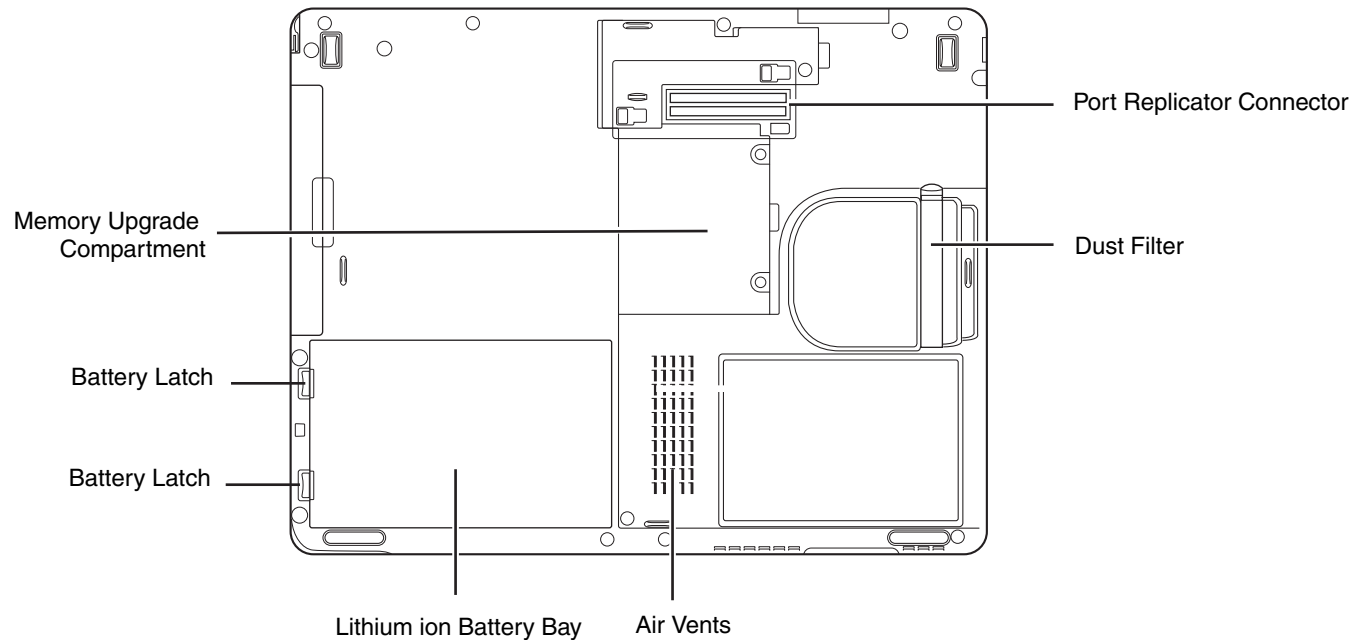

**Figure 6. LifeBook Tablet PC bottom panel**

### **Bottom Components**

The following is a brief description of your LifeBook Tablet PC's bottom panel components.

#### **Memory Upgrade Compartment**

Your Tablet PC comes with high speed Double Data Rate 3 Synchronous Dynamic RAM (DDR3 1066 MHz SDRAM). The memory upgrade compartment allows you to expand the system memory capacity of your Tablet PC, thus improving overall performance. See “Memory Upgrade Module” on page 90. Under normal circumstances, it should not be necessary to open this compartment.

### **Port Replicator Connector**

This connector allows you to connect the optional Port Replicator to your Tablet PC.

### **Dust Filter**

The dust filter is used to help remove dust and dirt from your system. See “Cleaning the dust filter” on page 129.

### **Air Vents**

The air vents allow air to circulate through the system to cool down the components.



TO PROTECT YOUR TABLET PC FROM DAMAGE AND TO OPTIMIZE SYSTEM PERFORMANCE, BE SURE TO **KEEP ALL AIR VENTS UNOBSTRUCTED, CLEAN, AND CLEAR OF DEBRIS.** THIS MAY REQUIRE PERIODIC CLEANING, DEPENDING UPON THE ENVIRONMENT IN WHICH THE SYSTEM IS USED.

DO NOT OPERATE THE TABLET PC IN AREAS WHERE THE AIR VENTS CAN BE OBSTRUCTED, SUCH AS IN TIGHT ENCLOSURES OR ON SOFT SURFACES LIKE A BED OR CUSHION.

### **Lithium ion Battery Bay**

The battery bay contains the internal Lithium ion battery. It can be opened for the removal of the battery when stored over a long period of time or for swapping a discharged battery with a charged Lithium ion battery. See “Lithium ion Battery” on page 81.

### **Battery Latches**

The battery latches are used to secure the Lithium ion battery in the battery bay.

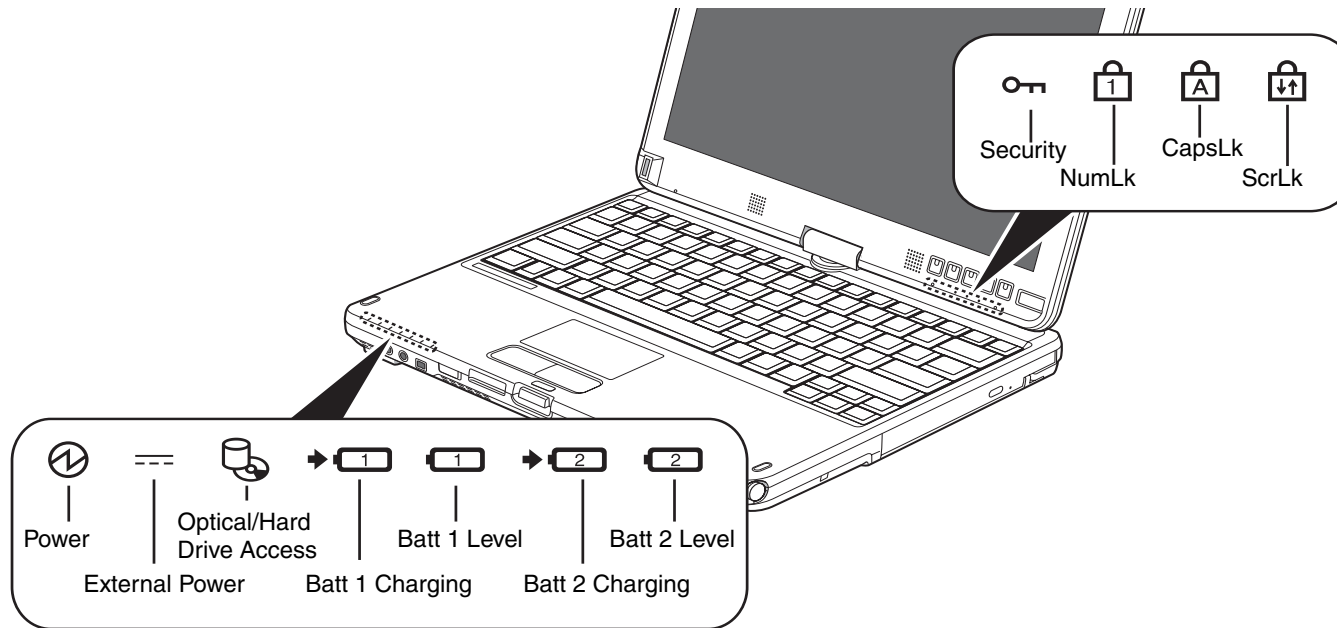

Figure 7. Status Indicator Panel

## Status Indicator Panel

The Status Indicator Panel displays symbols and associated LEDs that correspond to specific components of your Tablet PC. These symbols tell you how each of those components is operating.(Figure 7)

### Power Indicator

- The Power indicator symbol shows whether your system is operational. It has several different states, each of which tells you what mode your Tablet PC is in at that time.
- **Steady On:** This means that there is power to your Tablet PC and that it is ready for use.
- **Flashing:** This means that your Tablet PC is in Sleep mode.

- **Steady Off:** This means that your system is either in Hibernate mode, or that your Tablet PC has been turned off.

If you are charging your battery, the Power indicator symbol will remain on even if your LifeBook Tablet PC is shut off. Even if the system was shut down from Windows, the Power indicator symbol will remain on if you have an adapter connected

### **External Power Indicator**

The external power indicator shows whether your tablet is operating from the AC adapter, the auto/airline adapter or the batteries. This icon has two different states that can tell you what power source your LifeBook Tablet PC is using.

- **On:** This means that either of the adapters are currently in use.
- **Off:** Power is only coming from the batteries, and you do not have an adapter connected.



### **Hard Drive/Optical Drive Access Indicator**

The Hard Drive/Optical Drive Access indicator shows whether your internal hard drive or optical drive is being accessed.

### **Battery Charging Indicators**

The Battery Charging and Battery Level indicators state whether the Lithium ion battery (Battery 1) or the optional modular battery (Battery 2) are installed and charging.

### **Battery Level Indicator**

The Battery Level indicators display the charge level of the indicated battery pack, as follows:

- **Blue, solid:** Battery is between 50% and 100% charged.
- **Orange, solid:** Battery is between 13% and 49% charged.

- **Red, solid:** Battery is between 0% and 12% charged.
- **Orange, blinking:** Blinks during battery status measurement (Four seconds after the battery is installed).
- **Red, blinking:** There is a problem with the battery.
- **Off:** There is no battery installed.



- If the battery pack is installed while the power is turned off, the battery level indicator will display the charge level for five seconds after it blinks orange.
- If the AC adapter is not connected or the battery pack is not fully charged when the computer is switched to sleep mode, the indicator will blink. The LED blinks at the rate of one second on/five seconds off.



- Batteries subjected to shocks, vibration or extreme temperatures can be permanently damaged.
- A shorted battery is damaged and must be replaced.

### **Security Indicator**

The Security Indicator flashes (if a password was set) when the system resumes from Off or Sleep modes. You must enter the password that was set in the Security Panel before your system will resume operation.



### **NumLk Indicator**

The NumLk indicator glows when the integrated keyboard is set in ten-key numeric keypad mode.



### **CapsLock Indicator**

The CapsLock indicator glows when your keyboard is set to type in all capital letters.



### **ScrLk Indicator**

The ScrLk indicator glows when your scroll lock is active.



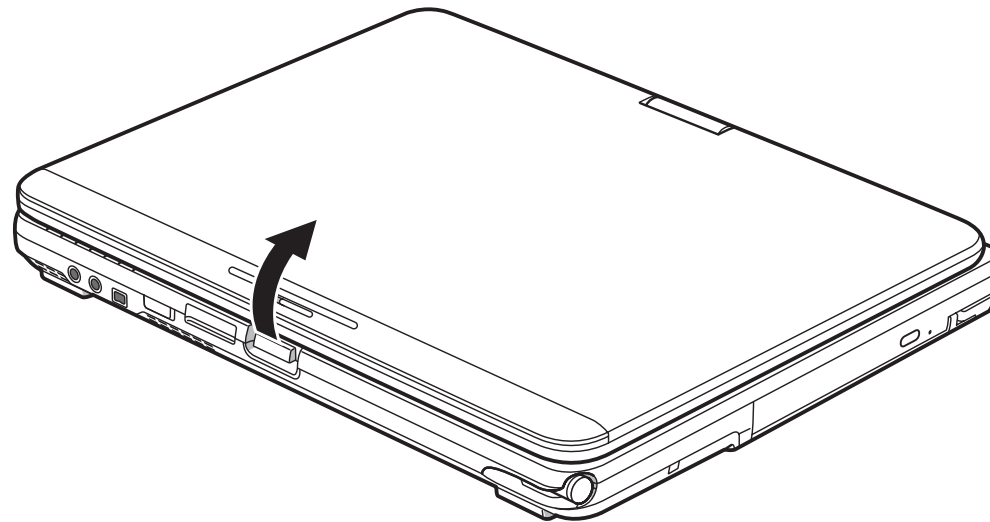

**Figure 8. Opening the Display Panel**

## **Display Panel**

Your LifeBook T730 Tablet PC contains an LED display panel that is backlit for easier viewing in bright environments. The convertible design of your Tablet PC allows you to open the display fully, rotate it in either direction 180 degrees, and lay it face up on the keyboard. This allows you to use the system as a tablet, much as you would a pad of paper.

### **Opening the Display Panel**

Lift the display backwards, being careful not to touch the screen with your fingers, until it is at a comfortable viewing angle. (Figure 8)

## Using the System as a Tablet

If you would like to use the system as a tablet, perform the following steps.



- The display can be rotated in either direction, but when returning the system to notebook mode, be sure to turn it back to its original position (i.e., the reverse of how you turned it when you opened it). Turning the display in the incorrect direction could cause hinge damage.
- In the following step, be sure to position the display perpendicular to the keyboard, otherwise the keyboard or display cover could get scratched.
- It is important to note that no matter which mode your tablet is in, the latch should always be engaged to prevent damage to it.

- 1** Press the latch button and lift the display until it is perpendicular to the keyboard. (Figure 10).
- 2** When the display is perpendicular to the keyboard, rotate it 180 degrees in either direction (Figure 11) so that it is facing backwards.
- 3** Holding the top edge of the display panel, pull it forward until it is lying nearly atop the keyboard.
- 4** Push the latch towards the display (See “A” in Figure 9). The latch will pivot so the top latch disappears, and the bottom latch appears (See “B” in Figure 9). Holding the latch down, lay the display flush against the system so that the latch engages. You can now use your system as a tablet. (Figure 12)

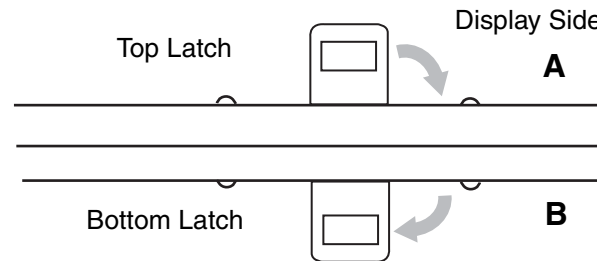

**Figure 9. Latching/unlatching**

To return the system to notebook configuration:

- 1** Press the latch button and lift the display until it is perpendicular to the keyboard.
- 2** When the display is perpendicular to the keyboard, rotate it 180 degrees in either direction so that it is facing forward.

- 3 Holding the top edge of the display panel, pull it forward until it is lying atop the keyboard with the display facing the keyboard



Figure 10. Fully Open Display

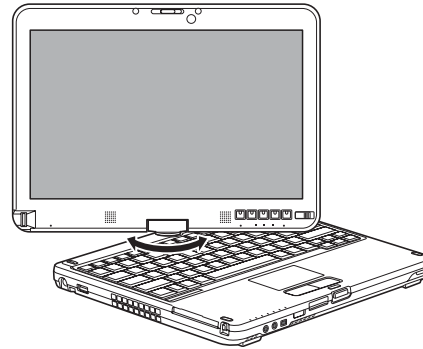

Figure 11. Rotating Display

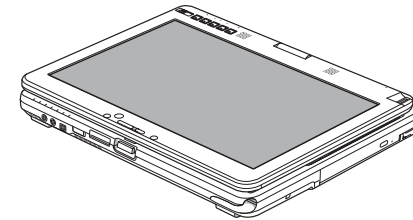

Figure 12. Tablet Mode

### Adjusting Display Panel Brightness

Once you have turned on your Tablet PC, you may want to adjust the brightness level of the screen to a more comfortable viewing level. There are three ways to adjust the brightness: keyboard, power management utility, and Fujitsu Menu.

#### Using Keyboard to Adjust Brightness

Adjusting the brightness using the keyboard changes the system setting (i.e., the settings you make via the function keys automatically changes the brightness settings in the system's Pen and Tablet Settings).

- [Fn+F6]: Pressing repeatedly will lower the brightness of your display.
- [Fn+F7]: Pressing repeatedly will increase the brightness of the display.

Note that changing the brightness with the [Fn] key is temporary. When you resume or restart, you will need to reset them if you used this method.

## Using Power Management to Adjust Brightness (Windows 7)

**Windows 7:** To adjust brightness with the power management utility in Windows 7:

Click Start -> **Control Panel**. In **View by:**, select one of the icon views. Select **Display**, then click **Adjust brightness** in the left pane. Drag **Screen brightness:** bar to the left or right, depending on your preference.

## Using the Fujitsu Menu to Adjust Brightness

To adjust brightness using the Fujitsu menu, click on the Fujitsu Menu icon in the system tray in the lower right corner of the screen. Double-click Windows Mobility Center, then double-click the icon adjacent to **Display brightness**. Set the screen brightness sliders for **On battery** and **Plugged in** scenarios.



IF USING AC POWER, YOUR BRIGHTNESS SETTING IS SET TO ITS HIGHEST LEVEL BY DEFAULT. IF USING BATTERY POWER, YOUR BRIGHTNESS SETTING IS SET TO APPROXIMATELY MID-LEVEL BY DEFAULT.

THE HIGHER THE BRIGHTNESS, THE MORE POWER THE SYSTEM WILL CONSUME AND THE FASTER YOUR BATTERIES WILL DISCHARGE. FOR MAXIMUM BATTERY LIFE, SET THE BRIGHTNESS AS LOW AS POSSIBLE.

## Enabling/Disabling Ambient Light Sensor (Windows 7 only)

Systems which are running the Windows 7 operating system have an ambient light sensor (just below the Power/Suspend/Resume switch) that automatically senses the light conditions in which the computer is operating. If the lighting is very bright, the brightness of the LCD will increase to make it easier to see the display. Conversely, if it is used in a darkened room, the display will automatically dim.



NOTE THAT WHEN YOU FIRST START YOUR SYSTEM, THE AMBIENT LIGHT SENSOR IS DISABLED. YOU WILL INITIALLY NEED TO ENABLE IT USING THE FOLLOWING STEPS.

The light sensor can be enabled or disabled from the Control Panel as follows:

- 1** Open the system Control Panel and click in the **View by:** field, select either large or small icons.
- 2** Click on the **Location and Other Sensors** icon.
- 3** To enable or disable the Light Sensor utility, check or uncheck the box in the Enabled column.

- 4 For more information about the light sensor, click on **Light Sensor** in the Sensor column to open the Sensor Properties window.
- 5 From the Sensor Properties window, you can change the sensor's description, uninstall the sensor, or enable or disable selected users.
  - To change the sensor's description, click the [Change description] button, enter the new description, and click the [OK] button.
  - To limit who can access the sensors, click **Change who can access sensors**, then check or uncheck the box adjacent to the individual you would like to grant or prohibit access.
  - To uninstall the sensor, click **Uninstall this sensor**.

# Keyboard

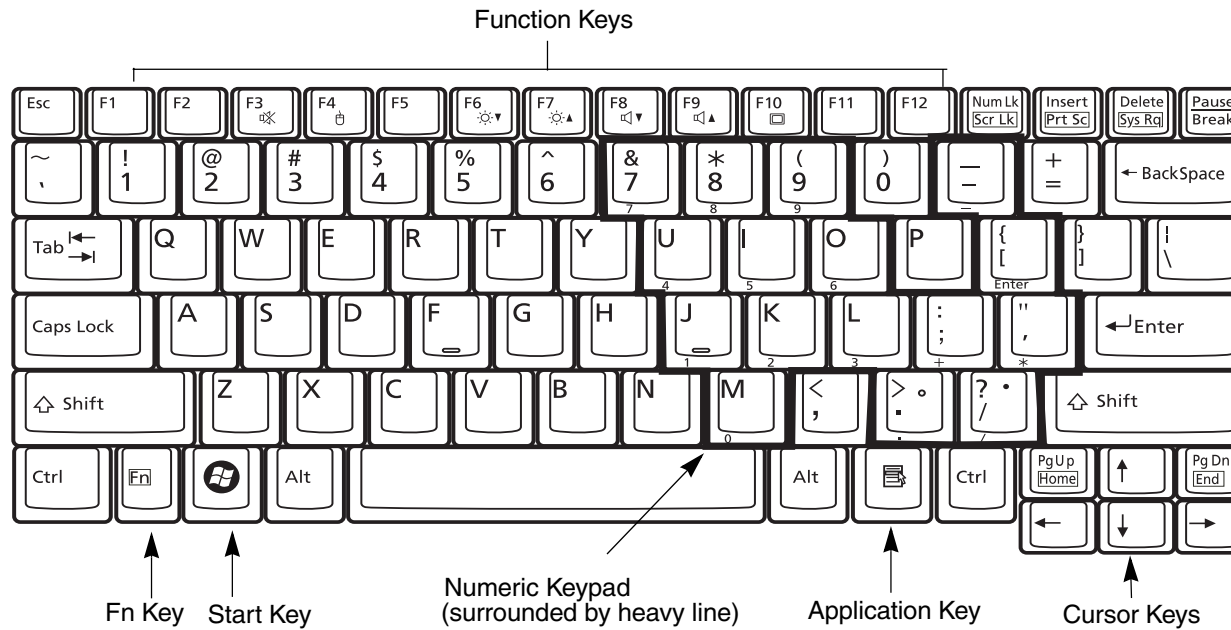

Figure 13. Keyboard

## Using the Keyboard

Your Fujitsu LifeBook Tablet PC has an integral 84-key keyboard. The keys perform all the standard functions of a 101-key keyboard, including the Windows keys and other special function keys. This section describes the following keys (Figure 13):

- **Numeric keypad:** Your Tablet PC allows certain keys to serve dual purposes, both as standard characters and as numeric and mathematical keys. The ability to toggle between the standard character and numerical keys is controlled through the [NumLk] key.
- **Cursor keys:** Your keyboard contains four arrow keys for moving the cursor or insertion point to the right, left, up, or down within windows, applications and documents.

- **Function keys:** The keys labeled [F1] through [F12], are used in conjunction with the [Fn] key to produce special actions that vary depending on what program is running.
- **Windows keys:** These keys work with your Windows operating system and function the same as the onscreen Start menu button, or the right button on your pointing device.

### **Numeric Keypad**

Certain keys on the keyboard perform dual functions as both standard character keys and numeric keypad keys. NumLk can be activated by pressing the [NumLk] keys. Turning off the NumLk feature is done the same way. Once this feature is activated you can enter numerals 0 through 9, perform addition ( + ), subtraction ( - ), multiplication ( \* ), or division ( / ), and enter decimal points ( . ) using the keys designated as ten-key function keys. The keys in the numeric keypad are marked on the front edge of the key to indicate their secondary functions.

### **Windows Keys**

Your LifeBook Tablet PC has two Windows keys, consisting of a Start key and an Application key. The Start key displays the Start menu. This button functions the same as your onscreen Start menu button. The Application key functions the same as your right mouse button and displays shortcut menus for the selected item. (Please refer to your Windows Help and Support documentation in the Start menu for additional information regarding the Windows keys.)

### **Cursor Keys**

The cursor keys are the four arrow keys on the keyboard which allow you to move the cursor up, down, left and right in applications. In programs such as Windows Explorer, it moves the “focus” (selects the next item up, down, left, or right).

### **Function Keys**

Your LifeBook Tablet PC has 12 function keys, F1 through F12. Functions assigned to these keys differ for each application. You should refer to your software documentation to find out how these keys are used.

- The [Fn] key provides extended functions for the Tablet PC and is always used in conjunction with another key.

- [Fn+F3]: Pressing [F3] while holding [Fn] will toggle the Audio Mute on and off.
- [Fn+F4]: Pressing [F4] while holding [Fn] will toggle the Quick Point feature on and off. Note that the [Fn+F4] combination only works if Manual Setting is selected in the BIOS. (See “BIOS Setup Utility” on page 71)
- [Fn+F6]: Pressing [F6] repeatedly while holding [Fn] will lower the brightness of your display.
- [Fn+F7]: Pressing [F7] repeatedly while holding [Fn] will increase the brightness of the display.
- [Fn+F8]: Pressing [F8] repeatedly while holding [Fn] will decrease the volume of your LifeBook Tablet PC.
- [Fn+F9]: Pressing [F9] repeatedly while holding [Fn] will increase the volume of your LifeBook Tablet PC.
- [Fn+F10]: Pressing [F10] while holding [Fn] allows you to change your selection of where to send your display video. The order is determined by which type of external video device(s) is connected. Each time you press the key combination, you will step to the next choice.
  - If you only have an external CRT connected, the order is: internal display -> external CRT -> simultaneous display -> internal display.
  - If you only have an HDMI device connected, the order is: internal display -> HDMI display -> simultaneous display -> internal display.
  - If you have external CRT and HDMI devices connected, the order is: internal display -> external CRT -> simultaneous internal and external CRT -> HDMI display - simultaneous internal and HDMI display -> internal display.
  - If you have an external CRT and DVI devices connected to the port replicator, the order is: internal display -> external CRT -> simultaneous internal and external CRT -> DVI display -> simultaneous internal and DVI display. -> internal display.



## Touchpad/Active Digitizer/Touchscreen

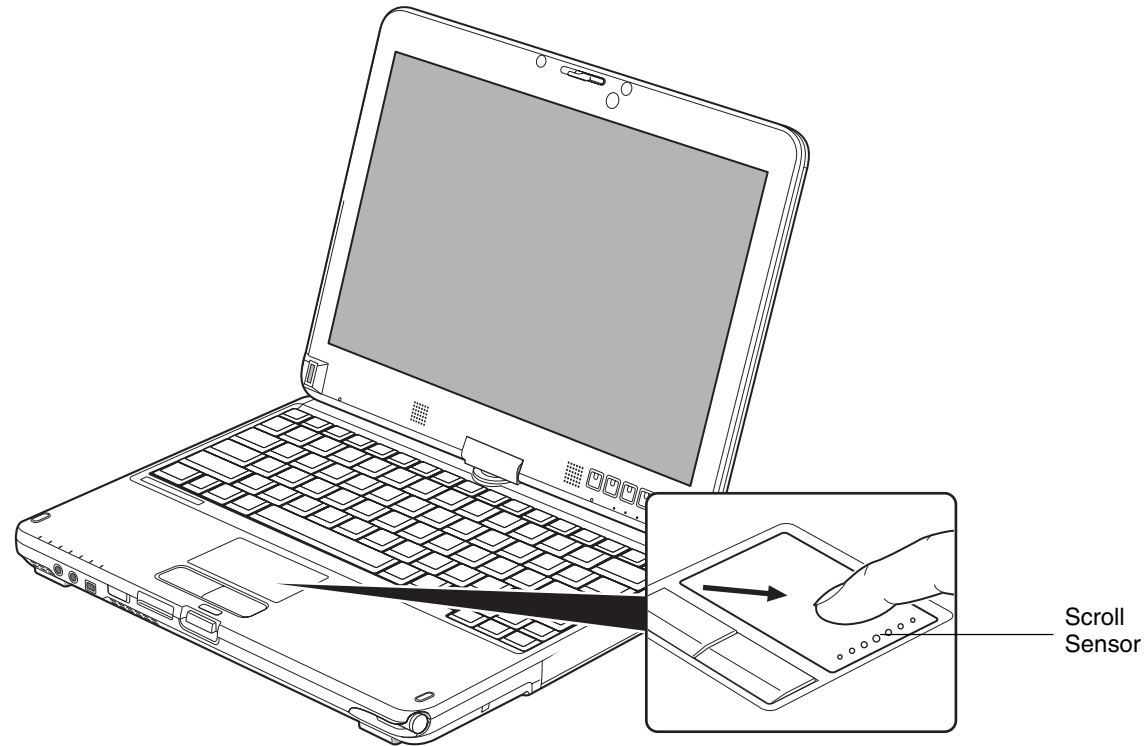

Figure 14. Touchpad pointing device

### Using the Touchpad

The touchpad is built into your LifeBook Tablet PC. It is used to control the movement of the cursor to select items on your display panel. The touchpad is composed of a cursor control below the center of the keyboard, two buttons below it, and a scroll sensor on the right edge of the cursor control. The left button functions the same as a left mouse button while the right button has the same function as a right mouse button. When used with the cursor control, the scroll sensor allows you to scroll up and down a screen. The actual functionality of the buttons may vary depending on the application that is being used.

## Clicking

Clicking means pushing and releasing a button. To left-click, move the cursor to the item you wish to select, press the left button once, and then immediately release it. To right-click, move the mouse cursor to the item you wish to select, press the right button once, and then immediately release it. You also have the option to perform the clicking operation by tapping lightly on the touchpad once.

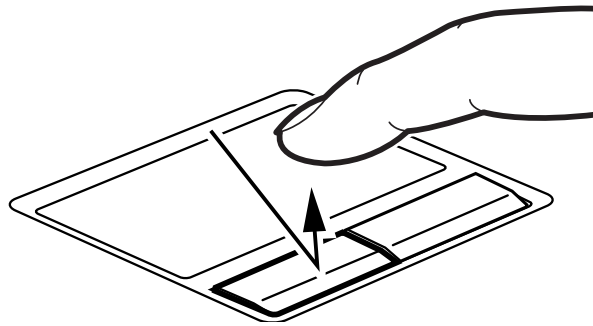

**Figure 15. Clicking with button**

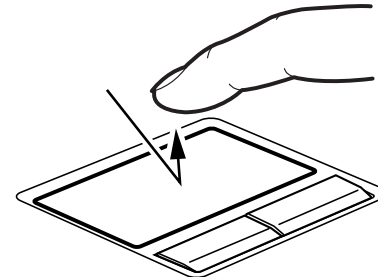

**Figure 16. Clicking with Touchpad**

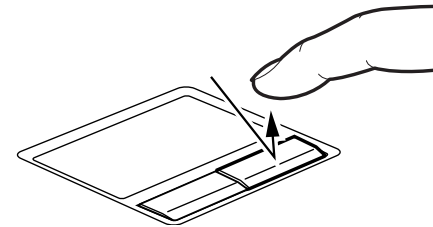

**Figure 17. Right-clicking with button**

### Double-Clicking

Double-clicking means pushing and releasing the left button twice in rapid succession. This procedure does not function with the right button. To double-click, move the cursor to the item you wish to select, press the left button twice, and immediately release it. You can also perform the double-click operation by tapping lightly on the Touchpad twice.

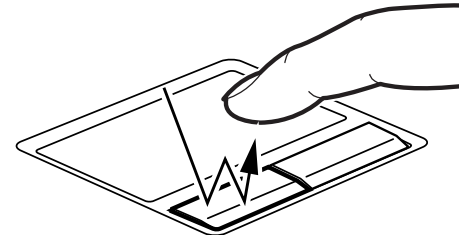

Figure 18. Double-clicking with button

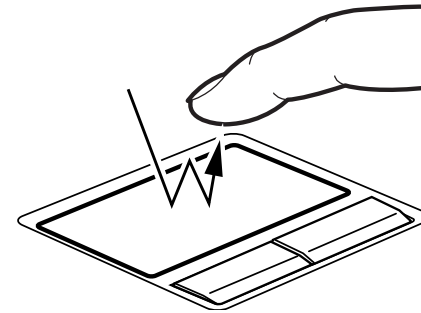

Figure 19. Double-clicking with Touchpad



- IF THE INTERVAL BETWEEN CLICKS IS TOO LONG, THE DOUBLE-CLICK WILL NOT BE EXECUTED.
- PARAMETERS FOR THE QUICK POINT CAN BE ADJUSTED FROM THE MOUSE DIALOG BOX LOCATED IN THE WINDOWS CONTROL PANEL.

## Dragging

Dragging means pressing and holding the left button, while moving the cursor. To drag, move the cursor to the item you wish to move. Press and hold the left button while moving the item to its new location and then release it. Dragging can also be done using the Touchpad. First, tap the Touchpad twice over the item you wish to move making sure to leave your finger on the pad after the final tap. Next, move the object to its new location by moving your finger across the Touchpad, and then release your finger.

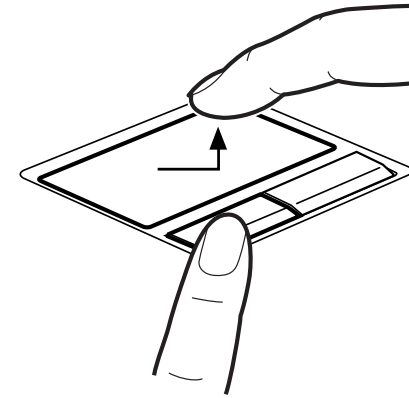

Figure 20. Dragging with button

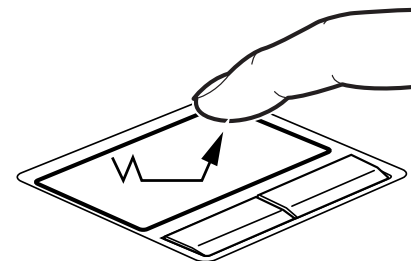

Figure 21. Dragging with Touchpad

## Scrolling

Using the scrolling strip allows you to navigate through a document quickly without using the window's scroll bars. This is particularly useful when you are navigating through on-line pages. To scroll, slide your finger up and down the scroll strip on the right side of the cursor control pad.

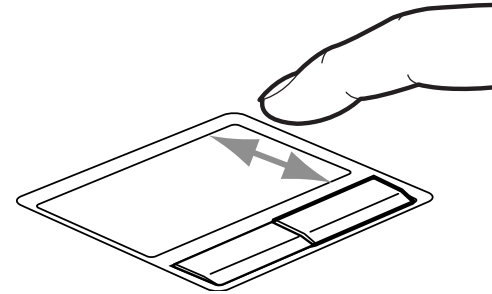

Figure 22. Scrolling with the Scroll Strip

## Touchpad Control Adjustment

The Windows Control Panel allows you to customize your touchpad with selections made from within the Mouse Properties dialog box. There are three aspects of operation which you can adjust:

- **Buttons:** This tab lets you set up the buttons for right or left handed operation, in addition to setting up the time interval allowed between clicks in double-clicking.
- **Pointers:** This tab lets you set up the scheme for the cursor depending on its functionality.
- **Pointer Options:** This tab lets you set up a relation between the speed of your finger motion and the speed of the cursor. It also allows you to enable a Pointer Trail for the cursor arrow.

## Active Digitizer Display

**NOTE:** Depending upon your system configuration, in addition to the active digitizer, you may also have a capacitive touch panel that responds to finger touch and touch gestures. (This configuration is called a “Dual Digitizer”.) For more information about the touchscreen, refer to “Using the Optional Capacitive Touchscreen” on page 50.

The integrated active digitizer allows you to use the included stylus as a pointing device. You can use the stylus to click, double-click, drag items and icons, write text, or to draw like a pen or pencil in applications that support this behavior, such as drawing or painting programs. See the documentation that came with your application for details.

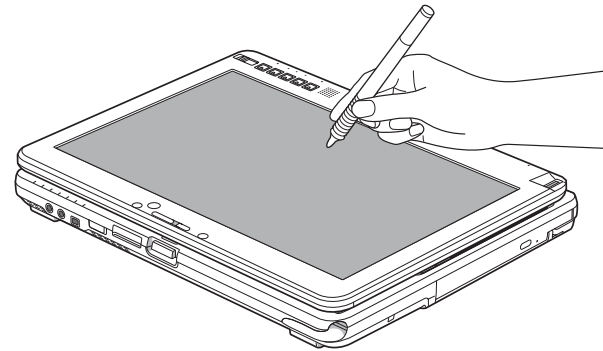

**Figure 23. Using the Active Digitizer Display**



- **DO NOT USE EXCESSIVE FORCE** WHEN TAPPING OR WRITING ON THE SCREEN WITH THE STYLUS. EXCESSIVE FORCE COULD RESULT IN DAMAGE TO THE LED AND/OR ACTIVE DIGITIZER.
- TO PURCHASE ADDITIONAL OR REPLACEMENT STYLUSES, VISIT FUJITSU’S ACCESSORIES WEBSITE AT: [WWW.SHOPFUJITSU.COM](http://WWW.SHOPFUJITSU.COM).

### Clicking on Active Digitizer Display

To left-click, touch the object you wish to select and then lift the stylus tip immediately.

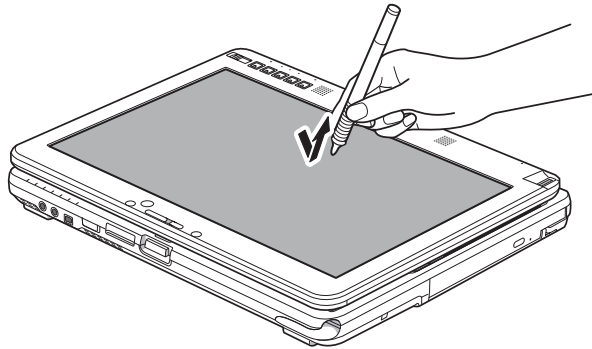

**Figure 24. Clicking on the Active Digitizer Display**

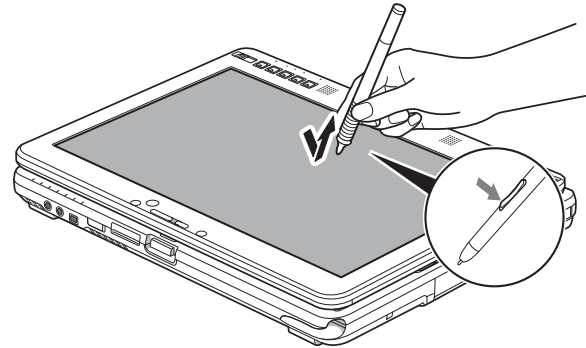

**Figure 25. Right-clicking Active Digitizer  
Right-Clicking on Active Digitizer**

Right-click can be accomplished by holding the front of the toggle button down while tapping on the screen. To change the settings for the right-click feature, go to Start -> Control Panel -> Pen and Input Devices. In the Pen Options tab, select “Press and Hold” then click the [Settings] button.

### Double-Clicking

To double-click, touch the item twice, and then immediately remove the stylus tip.

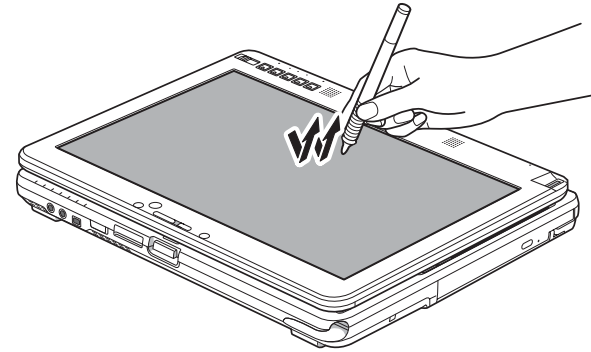

Figure 26. Double-clicking the Display

### Dragging

Dragging means moving an item with the stylus by touching the screen, moving and then lifting the stylus. To drag, touch the Active Digitizer Display with your stylus on the item you wish to move. While continuing to touch the screen with the stylus, drag the item to its new location by moving the stylus across the screen, and then lifting the stylus to release it.

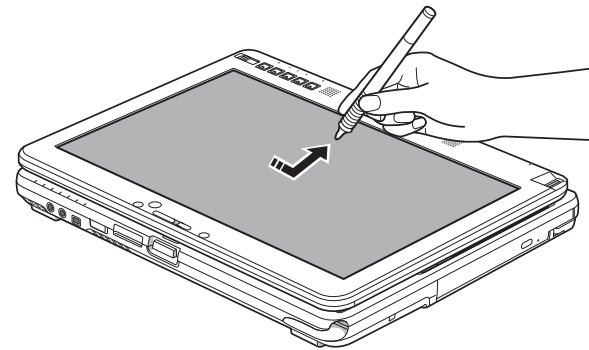

Figure 27. Dragging on the Display



## Calibrating the Active Digitizer Display

In order to ensure accurate tracking between the stylus and cursor, you must run the Calibration Utility before you use the system for the first time, or after you change the display resolution.

To run the calibration utility:

- 1 Go to Start -> Settings -> Control Panel.
- 2 Double-click the Tablet PC Settings icon and select the General tab
- 3 Click the [Calibrate] button.
- 4 Adjust the display of your Tablet PC to a comfortable angle and find the (+) symbol in the upper-left corner of the display.



**DO NOT USE EXCESSIVE FORCE** WHEN TAPPING ON THE SCREEN DURING CALIBRATION. USE OF EXCESSIVE FORCE COULD RESULT IN DAMAGE TO THE LED AND/OR TOUCH PANEL.

- 5 Using the stylus, firmly touch the screen directly on the (+) symbol. Lift the stylus from the screen and the target will move to a different location on the screen.
- 6 Repeat step 5 until you have selected all of the (+) symbols.
- 7 Once you have selected all the symbols, press the [OK] button.
- 8 Touch the stylus to various points on the screen to verify that the screen is correctly calibrated. If you are not satisfied with the screen's calibration, press the [Calibrate] button to begin again.

## Using the Optional Capacitive Touchscreen

Certain configurations of this Tablet PC have an optional dual digitizer that allows you to use either the stylus or your finger(s) as a pointing device. This type of display also allows you to use “gestures” to perform such actions as scroll, zoom, and rotate.



- GESTURE SUPPORT IS DETERMINED BY THE APPLICATION IN USE.
- THE STYLUS TAKES PRECEDENCE OVER FINGER TOUCH. IF THE STYLUS IS WITHIN ACTIVE RANGE OF THE SCREEN, FINGER TOUCH WILL BE DISABLED.
- WHEN ONE FINGER IS USED ON THE TOUCHSCREEN, IT BEHAVES IN THE SAME MANNER AS A STYLUS.

### Right-clicking the touchscreen

To perform a right-click action using two fingers, press the first finger at the location you want to perform a right-click, then quickly tap and release the second finger on the screen.

### Gesture Mode

To initiate gesture mode, two fingers must touch the screen within one 10th of a second of each other. If the second finger touches the screen after one 10th of a second has elapsed, the second finger is ignored. Gesture mode ends when both fingers are removed from the screen. Note that if a gesture can't be recognized, no action is taken. In that case, remove both fingers from the screen and try again.

### Scrolling Gesture

To scroll through long documents or on a web page, place both fingers on the screen and move them in parallel in the same direction; if only one finger moves, no scrolling will occur. You can scroll vertically or horizontally, depending upon the direction of the gesture.

### Zoom Gesture

The zoom gesture is especially helpful when viewing pictures. To zoom in, place two fingers on the item you want to enlarge, then spread them away from each other. To zoom out, place two fingers on the item you want to reduce, then move them towards each other.

### Rotate Gesture

To change the orientation of an object on the screen, place two fingers on the image you want to rotate, then move them in opposite directions (as if you were turning a knob). The direction the item turns is dependant upon the direction you move your fingers.

### Installing a Pen Tether

To prevent dropping or losing your pen, you should attach it to your system using the pen tether that is included with the system.

To attach the pen tether to your Tablet PC, perform the following steps:

- 1** Attach the end of the pen tether with the smaller loop to your pen. To do so, push the end of the tether through the hole in the pen, then thread the opposite end of the tether through the loop.
- 2** Attach the end of the pen tether with the larger loop to the attachment point on your tablet. To do so, insert the end of the pen tether through the attachment point, then feed the pen through the large loop in the tether.

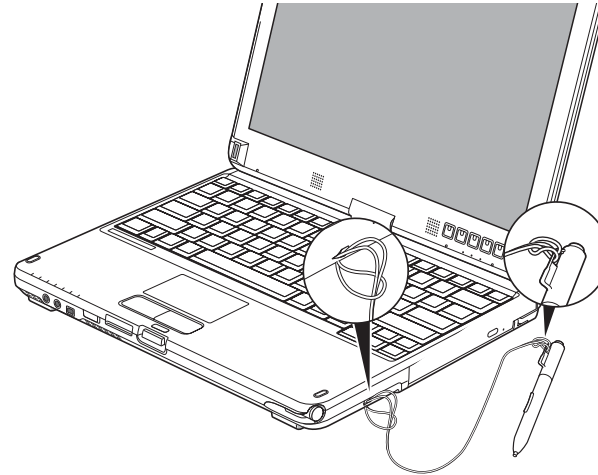

**Figure 28. Installing a Pen Tether**

## Volume Control

Your Fujitsu LifeBook Tablet PC has multiple volume controls which interact with each other.



ANY SOFTWARE THAT CONTAINS AUDIO FILES WILL ALSO CONTAIN A VOLUME CONTROL OF ITS OWN. IF YOU INSTALL AN EXTERNAL AUDIO DEVICE THAT HAS AN INDEPENDENT VOLUME CONTROL, THE HARDWARE VOLUME CONTROL AND THE SOFTWARE VOLUME CONTROL WILL INTERACT WITH EACH OTHER. IT SHOULD BE NOTED THAT IF YOU SET YOUR SOFTWARE VOLUME TO OFF, YOU WILL OVERRIDE THE EXTERNAL VOLUME CONTROL SETTING.

### Controlling the Volume

The volume can be controlled in several different ways:

- Volume can be changed or muted from within the Volume Control in the system tray.
- Volume can be controlled with the F8 and F9 functions keys. Pressing [F8] repeatedly while holding [Fn] will decrease the volume of your Tablet PC. Pressing [F9] repeatedly while holding [Fn] will increase the volume of your Tablet PC.
- Volume can be muted by pressing the [F3] key while holding down the [Fn] key. To restore audio, repeat the [Fn+F3] procedure.
- Volume can be controlled by many volume controls that are set within individual applications.
- Certain external audio devices you might connect to your system may have hardware volume controls.

Each source discussed above puts an upper limit on the volume level that must then be followed by the other sources. We recommend that you experiment with the various volume controls to discover the optimal sound level.

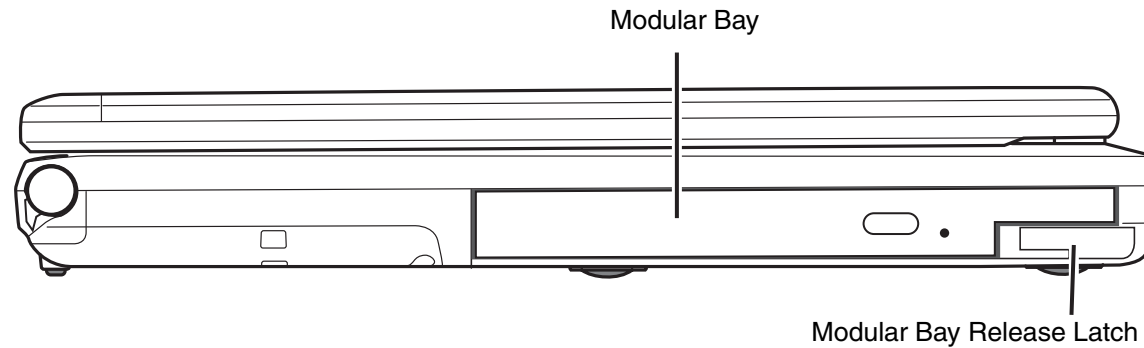

**Figure 29. Modular Bay**

## Modular Bay Devices

Your Fujitsu LifeBook Tablet PC contains a Modular Bay. The Modular Bay can house an optical drive, a Lithium ion battery, a modular second hard disk drive and a weight saver.

Your Modular Bay will have one of the following devices installed.

- **Modular Dual-Layer Multi-Format DVD Writer:** This allows you to access movies, software, and audio DVD/CDs and record to DVD, CD, and DVD-RAM discs.
- **Modular Lithium ion battery:** This is a rechargeable battery that can be used to power your LifeBook Tablet PC when an adapter is not connected.
- **Modular hard drive:** This allows you to increase the storage capacity of your Tablet PC.
- **Weight Saver:** This is used to fill the bay when no device is needed.



YOU SHOULD NEVER LEAVE YOUR MODULAR BAY EMPTY WHEN THE TABLET PC IS IN OPERATION. IF LEFT EMPTY, DUST OR FOREIGN MATTER MAY ACCUMULATE INSIDE THE TABLET PC.

## Removing and Installing Modular Devices

There are two ways to remove and install modular devices in the Modular Bay:

- Cold-swapping: swapping devices while your LifeBook Tablet PC is powered off.
- Hot-swapping: swapping devices while your system is active using the Safely Remove Hardware icon from your system tray.

### Cold-swapping

To cold-swap modular devices in your Modular Bay follow these easy steps:

- 1** Close any open files.
- 2** Shut down your LifeBook Tablet PC.
- 3** Press the Modular Bay release latch in the direction shown in Figure 30.
- 4** While holding the latch, slide your device out until it is clear of the bay. This will require light force.
- 5** Slide the device you are installing into your Tablet PC until it clicks into place.
- 6** It is now safe to turn your Tablet PC back on.
- 7** You can now access and use the device.

Your Tablet PC will automatically detect the device and activate it within your system. The drive letters associated with the device will be created and listed under My Computer and Windows Explorer.

### Hot-swapping

Hot-swapping is provided through the Safely Remove Hardware utility. The icon for the utility appears in the system tray. Click on the icon and follow the on-screen instructions.

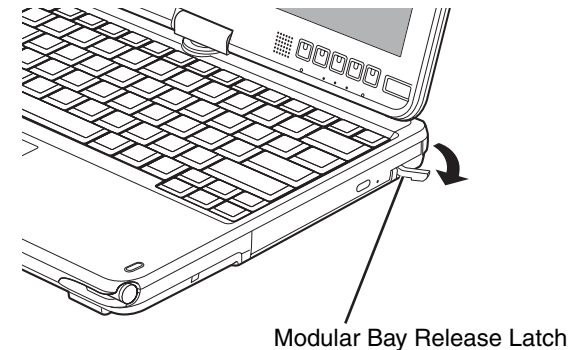

**Figure 30. Removing/Installing Modular Bay Device**

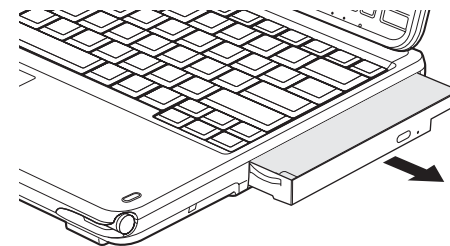

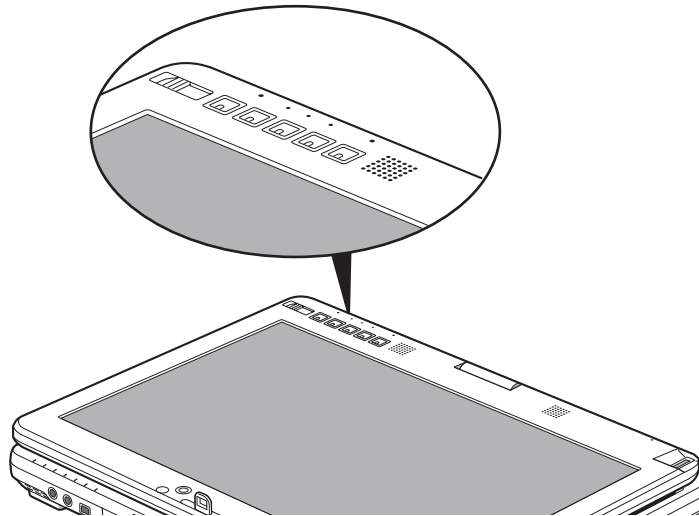

**Figure 31. LifeBook T730 Tablet PC Security/Tablet PC Buttons**

## **LifeBook Security/Tablet PC Buttons**





A unique feature of your LifeBook T730 Tablet PC is the array of Security and Tablet PC buttons. These buttons allow you to secure your Tablet PC from unauthorized use and to launch specific applications and functions with the touch of a button.

### **Security Button Functions**

If the security system is activated, upon starting your Tablet PC or resuming from Sleep, Hibernate, or shutdown mode, the security system will require you to enter a password code using the security buttons. After you enter the correct password, your system will resume operation.

The five security/Tablet PC buttons are located on the bottom right-hand side of the display when it is configured to be used as a notebook.

All five buttons are used when implementing security functions. Four of the buttons are used to enter the password, and the fifth is used as an Enter button. See Table 1 for information about each of the Security buttons.

| Button Icon   | System State                                | Security Panel Function |
|---|---|-------------------------|
|  | System is pre-boot or resuming from suspend | Security Button 1       |
|  |   | Security Button 2       |
|  |   | Security Button 3       |
| <b>Fn</b>   |   | Security Button 4       |
|  |   | Security Enter Button   |

**Table 1. Security Panel Button Functions**

### Pre-logon button functions

All five buttons can be used before logging on to Windows (i.e., when the Windows logon screen is displayed). Three of the buttons have secondary functions. See Table 2 for information about the pre-logon functions.

#### <Tab>/<Shift><Tab>





When you press the [Page Down] button when the system is pre-logon, each press of the button will act as if you had pressed the [Tab] key.

When you press the [Fn] button then press and release the [Page Down] button, each press of the button will act as if you had pressed the [Shift]+[Tab] key combination.



### <Enter>/<Escape>

When you press the [Page Up] button when the system is pre-logout, each press of the button will act as if you had pressed the [Enter] key.

| Button Icon   | System State   | Tablet PC Function                | Secondary Functions (Fn + Button) |
|---|--|-----------------------------------|-----------------------------------|
|  | System is pre-logout (Windows logon screen is displayed) | <Tab>                             | <Shift><Tab>                      |
|  |  | <Enter>                           | <Escape>                          |
|  |  | Rotate screen                     | None                              |
| <b>Fn</b>   |  | Used to invoke secondary function | None                              |
|  |  | Ctl+Alt+Del Button                | None                              |

**Table 2. Pre-logout Tablet PC Button Functions**

When you press the [Fn] button then press and release the [Page Up] button, each press of the button will act as if you had pressed the [Escape] key.

### Screen Rotation

The screen rotation feature would normally be used when the system is configured as a tablet. When you would like to use the tablet as an eBook, for example, you would use the portrait orientation; when accessing spreadsheets or using the system as a notebook, you would more typically use landscape orientation.

When the system is changed to tablet configuration, the orientation automatically changes to portrait mode by default.



THE SCREEN ORIENTATION DEFAULT CAN BE CHANGED BY GOING TO THE CONTROL PANEL AND DOUBLE-CLICKING ON THE FUJITSU TABLET CONTROLS ICON AND SELECTING THE DESIRED SETTINGS IN THE DISPLAY PROPERTIES. AFTER CHANGING THE SETTINGS, SAVE THEM IN FUJITSU TABLET CONTROLS.

When you press the [Screen Rotation] button when the system is in pre-boot, the system screen orientation changes from portrait (vertical) to landscape (horizontal) or from landscape to portrait.

### **Function / Fujitsu Menu Utility Button**

The [Function] button works in conjunction with the other application buttons to provide additional functionality for the buttons. Refer to specific details above.

### **Post-logon button functions**

All five buttons can be used after logging on to Windows. Four of the buttons have secondary functions. See Table 3 for information about each of the post-logon functions.

### **Page Down / Application A Button**





When you press the [Page Down] button when the system is running, each press of the button will scroll the screen down one frame. This allows you to navigate quickly through large documents.

When you press the [Fn] button then press and release the [Page Down/Application A] button, you will automatically start whichever program is assigned to the button. The default application for this button is Calculator. See “Changing Tablet PC Button Functions” on page 60 to select a different application for this button.

### **Page Up / Application B Button**

When you press the [Page Up] button when the system is running, each press of the button will scroll the screen up one frame. This allows you to navigate quickly through large documents.

When you press the [Fn] button then press and release the [Page Up/Application B] button, you will automatically start whichever program is assigned to the button. The default application for this button is Microsoft Journal. See “Changing Tablet PC Button Functions” on page 60 to select a different application for this button.

| Button Icon   | System State  | Primary Tablet PC Function   | Secondary Functions (Fn + Button)                                   |
|---|---|------------------------------|---|
|  | System is post-logon (Windows desktop is displayed) | Page Down                    | User-defined Application A (Default = Calculator)                   |
|  |   | Page Up                      | User-Defined Application B (Default = MS Journal)                   |
|  |   | Screen Rotation              | Display Switching:<br>1. LED only<br>2. CRT only<br>3. Dual Display |
| <b>Fn</b>   |   | Secondary Function Selection | Fujitsu Menu Utility  |
|  |   | Ctl+Alt+Del Button           | None  |

**Table 3. Post-logon Tablet PC Button Functions**

### Screen Rotation /Display Switching Button

The screen rotation feature would normally be used only when the system is configured as a tablet. When you would like to use the tablet as an eBook, for example, you would use the portrait orientation; when accessing spreadsheets or using the system as a notebook, you would more typically use landscape orientation.

When the system is changed to tablet configuration, the orientation automatically changes to portrait mode by default.



THE SCREEN ORIENTATION DEFAULT CAN BE CHANGED BY GOING TO THE CONTROL PANEL AND DOUBLE-CLICKING ON THE TABLET PC SETTINGS ICON AND SELECTING THE DESIRED SETTINGS IN THE DISPLAY TAB. AFTER CHANGING THE SETTINGS, SAVE THEM IN FUJITSU TABLET CONTROLS.

When you press the [Screen Rotation /Display Switching] button, the system screen orientation changes from portrait (vertical) to landscape (horizontal) or from landscape to portrait.

Pressing the [Fn] button while pressing the [Screen Rotation] button will switch the display output in the following order: built-in display only, external display only, dual display.

#### **Function / Fujitsu Menu Utility Button**

The [Function] button works in conjunction with the other application buttons to provide additional functionality for the buttons. Refer to specific details above.

Pressing the [Fn] button twice in succession causes the Fujitsu Menu Utility to appear on your screen, allowing you to modify certain system settings.

#### **Ctrl+Alt+Del Button**

Pressing and holding the [Ctl-Alt-Del] button for up to 8 seconds launches the Logon screen or the Windows Task Manager.

#### **Changing Tablet PC Button Functions**

The Application A and B buttons can be changed to launch a program or perform an action you select. By default, the Application A button launches the Calculator, and the Application B button launches MS Journal.

To launch different applications or cause the Application A or B buttons to perform a specific action:

- 1** Click on the Tablet PC Settings icon in the Control Panel.
- 2** Select the **Buttons** tab and select the button you would like to change from the list.

- 3 Click [Change] and open the drop down list in the **Press:** field.
- 4 Select the action you would like the button to perform. If you want to launch a program, click on **Launch an Application** then browse to the location of the program.
- 5 Click [OK], then click [OK] again. The buttons will now perform the actions you have assigned to them.

### Setting up LifeBook Security Panel

When you receive your Tablet PC, the security panel application is pre-installed without any passwords. The following sections provide detailed information on your security panel, how to set, change or remove passwords.

#### Numbered Buttons

Use these buttons to enter your password.

#### Enter Button

After entering the button strokes, push this button to enter the password into the Tablet PC.

#### Passwords

The user and supervisor password may be set on this Tablet PC. A supervisor password is typically the same for all tablets and notebooks in a work group, office, or company to allow for system management. Individual computers in a group environment should not use a common password. A password consists of one to five button strokes plus the enter button. A valid stroke consists of pushing one or up to four buttons simultaneously.

The following are valid button strokes:

- Pushing [4] by itself
- Pushing [2] and [3] at the same time
- Pushing [1], [2], and [4] at the same time
- Pushing [1], [2], [3], and [4] at the same time

The following are valid passwords. The numbers within braces ( { } ) are button strokes using more than one button.

- {[2]+[3]}, [1], [Enter]
- [4], [enter]
- {[1]+[3]}, {[2]+[3]+[4]}, [1], [4], [2], [Enter]

### Setting Passwords

When shipped from the factory, no passwords are set. You have a choice of having no password or setting a supervisor and user password. You must set the supervisor password before the user password.



- THE PURPOSE OF SUPERVISOR PASSWORD IS TO BE ABLE TO BYPASS THE USER PASSWORD IN CASE THE USER PASSWORD IS FORGOTTEN. THE SUPERVISOR PASSWORD ALONE WILL NOT LOCK THE SYSTEM.
- YOU MUST SET THE SUPERVISOR **AND** USER PASSWORDS FOR THE SECURITY PANEL TO WORK.

### Setting Supervisor Password

You must have set a supervisor password before setting any user passwords. The supervisor password can bypass the user password.

- 1 Go to the **Start** menu.
- 2 Click on **Run**.
- 3 Type in: **C:\Program Files\Fujitsu\Security Panel Application\Supervisor\FJSECS.EXE**, then press [Enter]
- 4 Follow the on-screen instructions to set the Supervisor password.

### Setting User Password

- 1 Go to the **Start** menu.
- 2 Click on **All Programs**.
- 3 Click on **Security Panel Application -> Security Panel Application**.
- 4 Follow the on-screen instructions to set the user password.



YOU MAY CHANGE OR REMOVE THE SUPERVISOR OR USER PASSWORD BY REPEATING THE STEPS DEFINED ABOVE.

### Using Your LifeBook Security Panel

The security lock feature is in effect both when the system resumes from Off, Sleep, or Hibernation state. You always need to push the Security Panel buttons to input the user password. Your system will not begin the boot sequence until you enter your supervisor/user password.

#### From Off State

- 1 Turn on your system.
- 2 When the Security Indicator flashes, enter the password and press Enter button (e.g., if the password is 22222, first press Button 2 five times, then press the Enter button). The Tablet PC will boot to normal operation.

#### From Sleep/Hibernation State

- 1 Press your Suspend/Resume button.
- 2 When the Security Indicator flashes, enter the password and press Enter button. The Tablet PC should resume normal operation.

#### Incorrect Password Entry

If an invalid supervisor or user password is entered three times in succession, the system will “beep” for about one minute. If a valid password is entered within a minute (while system beeps), the beeping will stop and the Tablet PC will resume normal operation. If no password is entered or an invalid password is entered while the system beeps, the system will return to its previous locked state (sleep or off) and the Security Indicator will go off. To reactivate the Tablet PC after a password failure, you must press the Suspend/Resume button, then enter a correct password.



REMEMBER THE USER PASSWORD YOU SPECIFIED ON THE SECURITY PANEL APPLICATION. IF YOU FORGET THE PASSWORD YOU WILL NOT BE ABLE TO USE YOUR COMPUTER. THE SUPERVISOR PASSWORD CAN OVERRIDE THE USER PASSWORD.

## Precautions

### Opening and Closing the Cover

By default, closing the cover automatically places your system into Sleep mode.

To change the default when the cover is closed:

- 1 Open the system Control Panel and select Power Options. (Windows XP: Select the Advanced tab).
- 2 Click **Choose what closing the lid does** in the left pane.
- 3 Select the desired action for **When I close the lid**, then click the [Save changes] or [Apply] button (depending upon your operating system).

### Low Battery Operations

If your Tablet PC has a low battery, pushing the suspend/resume button only turns on the Security Indicator. Your Tablet PC does not unlock, the Security Indicator turns off after one minute. To resume normal operation, first attach a power supply to the Tablet PC. Then you may unlock the Tablet PC.

## Uninstalling/Re-installing the Security Panel Application

You have two options when uninstalling the security panel application:

- Remove passwords and uninstall the security panel application software. This will disable all security features.
- Uninstall the security panel application with password still active. This will not allow any changes to the password.



## Uninstalling the Security Panel Application Software

Remove passwords when User wants no password protection whatsoever and doesn't want to give anybody the utility to set a password on their computer. In this case, if passwords (supervisor, user, or both) are set, the passwords must first be cleared BEFORE removing the application. To clear passwords, follow same procedure in SETTING PASSWORD CODES except this time, select REMOVE, enter current password then click **Next**. When asked to confirm select **Yes**.

## Removing Security Panel Application with Passwords Still Active

Using this feature will not allow any changes to the password.



REMOVING THE APPLICATIONS DOES NOT REMOVE THE PASSWORD. IT SIMPLY REMOVES THE ABILITY TO CHANGE/ADD/REMOVE PASSWORDS. TO CHANGE YOUR PASSWORD YOU MUST REINSTALL THE APPLICATION.

*User:*

- 1** Go to Start -> Control Panel.
- 2** Open **Programs and Features** in the Control Panel.
- 3** Select **Security Panel for User** in the list, and click **Uninstall/Change**.
- 4** When User Account Control box appears, click **Continue**.

*Supervisor:*

- 1** Go to Start -> Control Panel.
- 2** Open **Add or Remove Programs Properties** in the Control Panel.
- 3** Select the **Security Panel for Supervisor** in the list, and click **Uninstall/Change**.
- 4** When User Account Control box appears, click **Continue**.

## Reinstalling the Security Panel Application

To reinstall supervisor or user security application, you will need your Drivers and Applications CD. The **Utilities\Security Panel Application** folder contains two separate folders: **Supervisor** and **User**. The setup files for supervisor and user security applications are contained in those folders.

- 1** Go to the **Utilities\Security Panel Application\Supervisor** folder on the CD and double-click the **setup.exe** file. The Installing Security Panel Application window will appear. Follow the instructions on the screen.
- 2** Go to the **Utilities\Security Panel Application\User** folder on the CD and double-click the **setup.exe** file. The Installing Security Panel Application window will appear. Follow the instructions on the screen.

Supervisor and user passwords can be set via Windows software using the FJSECS.exe and FJSECU.exe files, respectively. FJSECU.exe for the user password cannot run without first setting a supervisor password. You need to run FJSECS.exe first to set the supervisor password. Follow instructions under Setting Passwords on page 62.

If you forget both passwords, please contact Fujitsu America Service and Support at 1-800-8FUJITSU (1-800-838-5487). Fujitsu America charges a service fee for unlocking a password-restricted Tablet PC. When calling please have a valid credit card and provide proof of ownership. You will then be given instructions on where to ship your Tablet PC.



## Chapter 2

# Getting Started with Your LifeBook

---

## Power Sources

Your Fujitsu LifeBook Tablet PC has three possible power sources: a primary Lithium ion battery, an AC adapter or an optional Auto/Airline adapter.

### Connecting the Power Adapters

The AC adapter or optional Auto/Airline adapter provides power for operating your Tablet PC and charging the batteries.

#### Connecting the AC Adapter

- 1 Plug the DC output cable into the DC power jack of your LifeBook Tablet PC.
- 2 Plug the AC adapter into an AC electrical outlet.

#### Connecting the Optional Auto/Airline Adapter

- 1 Plug the DC output cable into the DC power jack on your Tablet PC.
- 2 Plug the Auto/Airline adapter into the cigarette lighter of an automobile, or,
- 3 Plug the Auto/Airline adapter into the DC power jack on an airplane seat.

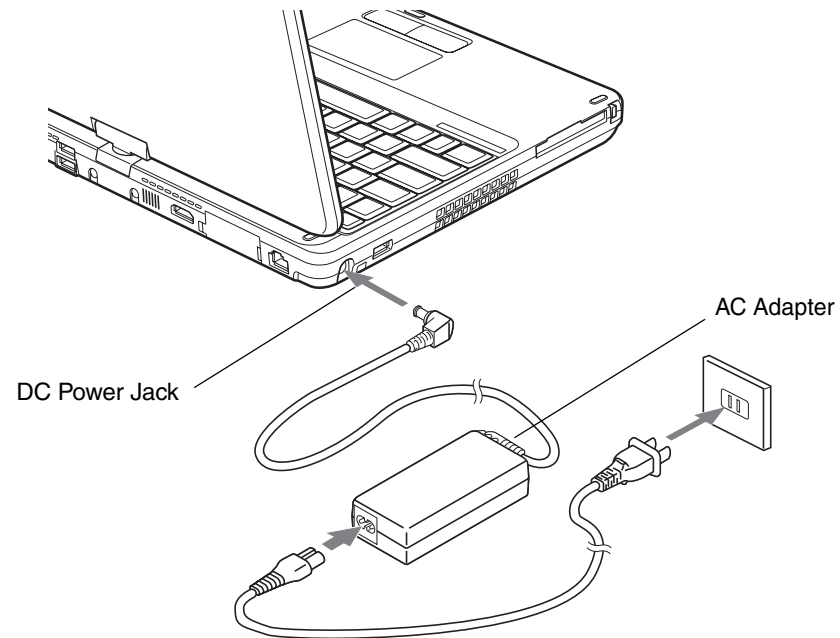

**Figure 32. Connecting the AC Adapter**

**Switching from AC Adapter Power or the Auto/Airline Adapter to Battery Power**

- 1** Be sure that you have at least one charged battery installed.
- 2** Remove the AC adapter or the Auto/Airline adapter.



THE LITHIUM ION BATTERY IS NOT CHARGED UPON PURCHASE. INITIALLY, YOU WILL NEED TO CONNECT EITHER THE AC ADAPTER OR THE AUTO/AIRLINE ADAPTER TO USE YOUR TABLET PC.

## Starting Your LifeBook Tablet PC

### Power On

#### Power/Suspend/Resume Button

The Power/Suspend/Resume button is used to turn on your LifeBook Tablet PC from its off state. Once you have connected your AC adapter or charged the internal Lithium ion battery, you can power on your LifeBook Tablet PC.



WHEN YOU TURN ON YOUR LIFEBOOK TABLET PC BE SURE YOU HAVE A POWER SOURCE. THIS MEANS THAT AT LEAST ONE BATTERY IS INSTALLED AND CHARGED, OR THAT THE AC OR AUTO/AIRLINE ADAPTER IS CONNECTED AND HAS POWER.

To turn on your LifeBook Tablet PC from its off state, slide the Power/Suspend/Resume switch, located above the keyboard to the right. When you are done working you can either leave your Tablet PC in Suspend mode or you can turn it off. See “Sleep Mode” on page 76 and “Powering Off” on page 79.

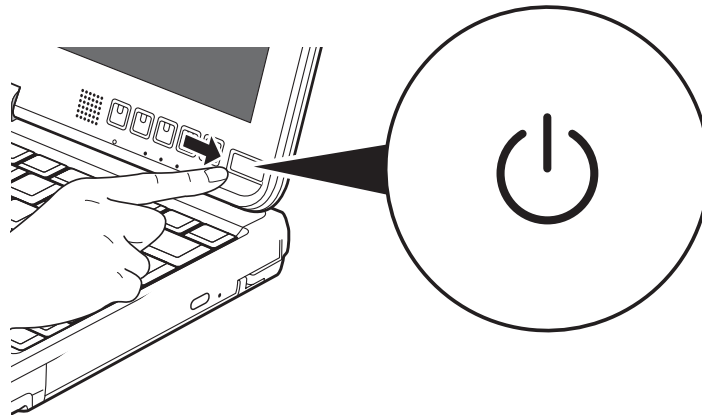

**Figure 33. Power/Suspend/Resume Button**



DO NOT CARRY YOUR LIFEBOOK TABLET PC AROUND WITH THE POWER ON OR SUBJECT IT TO SHOCKS OR VIBRATION, AS YOU RISK DAMAGING YOUR TABLET PC.

When you power on your LifeBook, it will perform a Power On Self Test (POST) to check the internal parts and configuration for correct functionality. If a fault is found, your LifeBook Tablet PC will emit an audio warning and/or an error message will be displayed. See “Power On Self Test Messages” on page 116. Depending on the nature of the problem, you may be able to continue by starting the operating system or by entering the BIOS setup utility and revising the settings.

After satisfactory completion of the POST, your Tablet PC will load your operating system.



NEVER TURN OFF YOUR LIFEBOOK TABLET PC DURING THE POWER ON SELF TEST (POST) OR IT WILL CAUSE AN ERROR MESSAGE TO BE DISPLAYED WHEN YOU TURN YOUR LIFEBOOK TABLET PC ON THE NEXT TIME. See “Power On Self Test Messages” on page 116.

### **Boot Sequence**

The procedure for starting-up your Tablet PC is termed the Bootup sequence and involves your Tablet PC’s BIOS. When your LifeBook Tablet PC is first turned on, the main system memory is empty, and it needs to find instructions to start up your Tablet PC. This information is in the BIOS program. Each time you power up or restart your Tablet PC, it goes through a boot sequence which displays a Fujitsu logo until your operating system is loaded. During booting, your Tablet PC is performing a standard boot sequence including a Power On Self Test (POST). When the boot sequence is completed without a failure and without a request for the BIOS Setup Utility, the system displays the operating system’s opening screen.

The boot sequence is executed when:

- You turn on the power to your LifeBook Tablet PC.
- You restart your Tablet PC from the Windows Shut Down dialog box.
- The software initiates a system restart. Example: When you install a new application.

### Hard Disk Drive Passwords

To provide additional security for your data, you can assign passwords to your hard disk drive(s). This feature is managed in the system BIOS Setup Utility. See *BIOS Setup Utility* below for information about accessing the utility.



**REMEMBER YOUR PASSWORDS.** IF YOU SET AND FORGET YOUR USER AND MASTER HARD DISK PASSWORDS, FUJITSU WILL NOT BE ABLE TO RESET IT. YOU MAY LOSE DATA AND HAVE TO REPLACE YOUR SYSTEM BOARD OR HARD DISK DRIVE.

### BIOS Setup Utility

The BIOS Setup Utility is a program that sets up the operating environment for your LifeBook Tablet PC. Your BIOS is set at the factory for normal operating conditions, therefore there is no need to set or change the BIOS' environment to operate your Tablet PC.

The BIOS Setup Utility configures:

- Device control feature parameters, such as changing I/O addresses and boot devices.
- System Data Security feature parameters, such as passwords.

### Entering the BIOS Setup Utility

To enter the setup utility, do the following (or use the TrustedCore Menu, as detailed in the next section):

- 1** Turn on or restart your LifeBook Tablet PC.
- 2** To enter the BIOS Setup Utility, press the [F2] key once the Fujitsu logo appears on the screen. This will open the main menu of the BIOS Setup Utility with the current settings displayed.

- 3 Press the [RIGHT ARROW] or [LEFT ARROW] key to scroll through the other setup menus to review or alter the current settings.

### **Using the TrustedCore Menu**

When the Fujitsu logo appears on the screen, press the [Enter] key or click on the left mouse or touchpad button; the TrustedCore Menu will appear.

The TrustedCore Menu provides shortcuts to the following menus and information screens:

- BIOS Setup
- Diagnostic Screen
- Boot Menu
- Patent Information
- System Information
- Continue Booting

Clicking on any of the fields will invoke the screen, information, or action described.

The Boot Menu can also be invoked by pressing the [F12] key when the Fujitsu logo appears on the screen.

### **BIOS Guide**

A guide to your Tablet PC's BIOS is available online. Please visit our service and support website at <http://www.computers.us.fujitsu.com/support>, then select User's Guides under Online Support. Select your Product, Series, and Model, then click [Go]. Under the Manuals tab, select the BIOS Guide.

### **Booting the System**

We strongly recommend that you not attach any external devices until you have gone through the initial power on sequence.

When you turn on your Tablet PC for the first time, it will display a Fujitsu logo on the screen. If you do nothing the system will load the operating system, and then the Windows Welcome will begin.



## Starting Windows the first time



**THE FIRST TIME YOU INITIALIZE YOUR WINDOWS SYSTEM, THE SCREEN WILL BE BLANK FOR APPROXIMATELY TWO MINUTES.** THIS IS NORMAL. AFTER INITIALIZATION, A "SET UP WINDOWS" DIALOG BOX WILL APPEAR.

**IMPORTANT:** DURING THE SETUP PROCEDURE, DO NOT DISCONNECT THE POWER SUPPLY, PRESS ANY BUTTONS, OR USE ANY PERIPHERAL DEVICES SUCH AS A MOUSE, KEYBOARD, OR REMOTE CONTROL.

In order to ensure that you receive the most benefits from the Windows operating system, it should be registered the first time you use it.

**1** First of all, you will need to read and accept the End User License Agreements (EULAs).



- IF YOU REJECT THE TERMS OF THE LICENSE AGREEMENTS YOU WILL BE ASKED TO REVIEW THE LICENSE AGREEMENTS FOR INFORMATION ON RETURNING WINDOWS OR TO SHUT DOWN YOUR LIFEBOOK TABLET PC.
- YOU CANNOT USE YOUR TABLET PC UNTIL YOU HAVE ACCEPTED THE LICENSE AGREEMENTS. IF YOU STOP THE PROCESS YOUR TABLET PC WILL RETURN TO THE BEGINNING OF THE WINDOWS WELCOME PROCESS, EVEN IF YOU SHUT YOUR TABLET PC DOWN AND START IT UP AGAIN.

**2** You will be prompted to enter your User Name and Password and you will be given a chance to select an icon for your account.

**3** The next screen asks for a Computer Name and allows you to choose a desktop background.

**4** You will next see a "Help protect Windows automatically" screen in which the default choice is "Use recommended settings". The other two choices are "Install important updates only" and "Ask me later". Select from the three choices.

**5** On the next screen set your time and date settings.

**6** You will next see the "Select your computer's current location" screen. Make your selection from Home, Work (Default), and Public location.

- 7 The "Thank you" screen follows and an offer for free Norton Internet Security is extended. Following are several screens while Windows checks the system performance.
- 8 Windows will then boot up for the first time. As noted above, the first time you initialize your system, the screen will be blank for approximately two minutes. This is normal. During this period, do not disconnect the power supply, press any buttons, or use any peripheral devices such as mouse, keyboard, or remote control.

### Registering Windows with Microsoft

- 1 After Windows has booted up for the first time, the Control Panel Welcome Center will appear. If the Register Windows Online icon is not seen in the window, click on "Show all xx items" (where "xx" is the number of topics in the Welcome Center).
- 2 Click on Register Windows Online and follow the instructions that appear to register your copy of Windows.

### Registering Your LifeBook Tablet PC with Fujitsu

You can register your LifeBook by going to our website at: <http://solutions.us.fujitsu.com/>. You will need to be set up with an Internet Service Provider (ISP) to register online.



### Installing ClickMe!



BEFORE INSTALLING THE CLICKME! UTILITY, BE SURE THE WIRELESS LAN SWITCH IS TURNED ON.

The first time you boot up your system, you will see a "Primary Settings for the PC" window. This window explains the installations which will be performed by the Click Me! utility. If you click [Execute], ClickMe! will begin installing. If after clicking the button you receive a "User Account Control" window, you will be asked for your permission to continue. Click [Continue] to continue. If you cancel the operation, the ClickMe! icon will appear on your desktop for later installation.



THERE MAY BE SOME THIRD-PARTY APPLICATIONS THAT DO NOT GET INSTALLED USING THE CLICKME! UTILITY. FOR MORE INFORMATION, REFER TO YOUR GETTING STARTED GUIDE.



### **Fujitsu Driver Update Utility**

Your system has a convenient tool called the Fujitsu Driver Update (FDU) utility. With FDU, you can choose to automatically or manually go to the Fujitsu site to check for new updates for your system. For more information about the FDU utility, refer to “Automatically Downloading Driver Updates” on page 124.

## Power Management

Your Fujitsu LifeBook Tablet PC has many options and features for conserving battery power. Some of these features are automatic and need no user intervention. However, others depend on the parameters you set to best suit your operating conditions, such as those for the display brightness. Internal power management for your Tablet PC may be controlled from settings made in your operating system, pre-bundled power management application, or from settings made in BIOS setup utility.

Besides the options available for conserving battery power, there are also some things that you can do to prevent your battery from running down as quickly. For example, you can create an appropriate power saving profile, put your Tablet PC into Sleep mode when it is not performing an operation, and you can limit the use of high power devices. As with all mobile, battery powered computers, there is a trade-off between performance and power savings.

### Power/Suspend/Resume Button

When your Tablet PC is active, the Power/Suspend/Resume button can be used to manually put the Tablet PC into Sleep mode. Push the Power/Suspend/Resume button when the Tablet PC is active, but not actively accessing anything, and immediately release the button.

If your Tablet PC is suspended, pushing the Power/Suspend/Resume button returns it to active operation. You can tell whether the system is Suspended by looking at the Power indicator. If the indicator is visible and not flashing, your Tablet PC is fully operational. If the indicator is visible *and* flashing, the Tablet PC is in Sleep mode. If the indicator is not visible, the power is off or your Tablet PC is in Hibernation mode.

### Sleep Mode

Sleep mode in Windows saves the contents of your system memory during periods of inactivity by maintaining power to critical parts. This mode turns off the CPU, display, hard drive, and all other internal components except those necessary to maintain system memory and for restarting.

Your Tablet PC can be put in sleep mode by:

- Pressing the Power/Suspend/Resume button when your system is turned on.

- Selecting “Sleep” after clicking [Start] then clicking the small arrow at the bottom right of the window.
- Timing out from lack of activity.
- Allowing the battery to reach the Dead Battery Warning condition.

Your Tablet PC’s system memory typically stores the file on which you are working, open application information, and any other data required to support operations in progress. When you resume operation from Sleep mode, your Tablet PC will return to the point where it left off. You must use the Power/Suspend/Resume button to resume operation, and there must be an adequate power source available, or your Tablet PC will not resume.



- IF RUNNING YOUR TABLET PC ON BATTERY POWER, BE AWARE THAT THE BATTERY CONTINUES TO DISCHARGE WHILE YOUR TABLET PC IS IN SLEEP MODE, THOUGH NOT AS QUICKLY AS WHEN FULLY OPERATIONAL.
- DISABLING THE POWER/SUSPEND/RESUME BUTTON PREVENTS IT FROM BEING USED TO PUT THE TABLET PC INTO SLEEP OR HIBERNATION (SAVE-TO-DISK) MODE. THE BUTTON RESUME FUNCTION CANNOT BE DISABLED.
- THE SLEEP OR HIBERNATION MODE SHOULD NOT BE USED WITH CERTAIN EXPRESSCARDS. CHECK YOUR EXPRESSCARD DOCUMENTATION FOR MORE INFORMATION. WHEN EXPRESSCARDS OR EXTERNAL DEVICES ARE IN USE, HIBERNATION MODE CANNOT RETURN TO THE EXACT STATE PRIOR TO SUSPENSION, BECAUSE ALL OF THE PERIPHERAL DEVICES WILL BE RE-INITIALIZED WHEN THE SYSTEM RESTARTS.
- IF YOUR TABLET PC IS ACTIVELY ACCESSING INFORMATION WHEN YOU ENTER THE SLEEP OR HIBERNATION MODE, CHANGES TO OPEN FILES ARE NOT LOST. THE FILES ARE LEFT OPEN AND MEMORY IS KEPT ACTIVE DURING SLEEP MODE OR THE MEMORY IS TRANSFERRED TO THE INTERNAL HARD DRIVE DURING HIBERNATION MODE.

THE MAIN ADVANTAGE OF USING HIBERNATION IS THAT POWER IS NOT REQUIRED TO MAINTAIN YOUR DATA. THIS IS PARTICULARLY IMPORTANT IF YOU WILL BE LEAVING YOUR TABLET PC IN A SUSPENDED STATE FOR A PROLONGED PERIOD OF TIME. THE DRAWBACK OF USING HIBERNATION MODE IS THAT IT LENGTHENS THE POWER DOWN AND POWER UP SEQUENCES AND RESETS PERIPHERAL DEVICES.

## Hibernation (Save-to-Disk) Feature

The Hibernation feature saves the contents of your Tablet PC's system memory to the hard drive as a part of the Suspend/Resume mode. You can enable or disable this feature.

### Enable or Disable the Hibernation Feature

The default settings are not enabled. To enable or disable the Hibernation feature follow these steps:

- 1 From the Start menu, select Control Panel, then select the Power Options icon.
- 2 Select "Choose what the power button does" or "Choose what closing the lid does", then make your selections (Do Nothing, Sleep, Hibernate, or Shut Down).

## Windows Power Management

The Power Options icon located in the Windows Control Panel allows you to configure some of the power management settings. For example, you can use the Power Options to set the timeout values for turning off the display and hard disks whether you are running the Tablet PC on battery power or one of the adapters.

## Restarting the System

If your system is on and you need to restart it, be sure that you use the following procedure.

- 1 Click the [Start] button, and then move the mouse over the small arrow at the bottom right of the right-hand pane.
- 2 Select **Restart** from the list.



TURNING OFF YOUR LIFEBOOK TABLET PC WITHOUT EXITING WINDOWS OR TURNING ON YOUR TABLET PC WITHIN 10 SECONDS OF THE SYSTEM BEING SHUT OFF MAY CAUSE AN ERROR WHEN YOU START THE NEXT TIME.

## Powering Off

Before turning off the power, check that the hard drive/optical drive access indicator is off. If you turn off the power while accessing a disk there is a risk of data loss. To ensure that your Tablet PC shuts down without error, use the Windows shut down procedure.



BE SURE TO CLOSE ALL FILES, EXIT ALL APPLICATIONS, AND SHUT DOWN YOUR OPERATING SYSTEM PRIOR TO TURNING OFF THE POWER. IF FILES ARE OPEN WHEN YOU TURN THE POWER OFF, YOU WILL LOSE ANY CHANGES THAT HAVE NOT BEEN SAVED, AND MAY CAUSE DISK ERRORS.

Using the correct procedure to shut down from Windows allows your Tablet PC to complete its operations and turn off power in the proper sequence to avoid errors. The proper sequence is:

- 1 Click the [Start] button, and then move the mouse over the small arrow at the bottom right of the right-hand pane.
- 2 Select **Shut Down** from the list.

If you are going to store your Tablet PC for a month or more, see Care and Maintenance Section.

## ENERGY STAR® Compliance



Your Fujitsu system is an ENERGY STAR® qualified mobile PC. By choosing a computer with the latest energy-saving technology, you're helping to preserve our environment for future generations.

**ENERGY STAR** is a joint program of the U.S. Environmental Protection Agency, U.S. Department of Energy, Natural Resources Canada, and other governments around the world helping us save money while protecting the environment through energy efficient products and practices. With energy costs and global warming top-of-mind for consumers, Fujitsu is committed to offering solutions that help consumers conserve energy and improve the quality of our environment.

**Sleep Mode:**

You will notice that your computer is initially set so that the display turns off after 15 minutes of user inactivity, and the computer goes into Sleep mode after 20 minutes of user inactivity. When going into Sleep mode, the computer also reduces the speed of any active Ethernet network links. To “wake” the computer from Sleep mode, press the Suspend/Resume Button.

**Energy saving benefits:**

Fujitsu ENERGY STAR qualified mobile PCs use about half as much electricity as standard equipment – saving half in utility costs. But more than that, ENERGY STAR also makes a difference for the environment. Did you know that the average house can be responsible for twice the greenhouse gas emissions as the average car? That’s because every time you flip on a light switch, run your dishwasher, or turn on your PC, you use energy, which means more greenhouse gas emissions from power plants. So the more energy we can save through energy efficiency, the more we help to reduce greenhouse gases and the risks of global warming.

To learn more about the important ENERGY STAR program, visit: [www.energystar.gov](http://www.energystar.gov).

To read about how Fujitsu is supporting Sustainable Management along with several other environmental activities, visit the Fujitsu Corporate Citizenship page at:

<http://www.computers.us.fujitsu.com/www/content/aboutus/environmental/environment.php>



## Chapter 3

# User-Installable Features

---

### Lithium ion Battery

Your LifeBook Tablet PC has a Lithium ion battery that provides power for operating your Tablet PC when no external power source is available. The battery is durable and long lasting, but should not be exposed to extreme temperatures, high voltages, chemicals or other hazards.

The Lithium ion battery operating time may become shorter if it is used under the following conditions:

- When used at temperatures that exceed a low of 5°C or a high of 35°C (41° to 95° F). Extreme temperatures not only reduce charging efficiency, but can also cause battery deterioration. The Charging icon on the Status Indicator panel will flash when you try to charge a battery that is outside its operating temperature range.
- When using a high current device such as a modem, external optical drive, or the hard drive, using the AC adapter will conserve your battery life.



DO NOT LEAVE A FAULTY BATTERY IN YOUR TABLET PC. IT MAY DAMAGE YOUR AC ADAPTER, OPTIONAL AUTO/AIRLINE ADAPTER, ANOTHER BATTERY OR YOUR TABLET PC ITSELF. IT MAY ALSO PREVENT OPERATION OF YOUR TABLET PC BY DRAINING ALL AVAILABLE CURRENT INTO THE BAD BATTERY.



- ACTUAL BATTERY LIFE WILL VARY BASED ON SCREEN BRIGHTNESS, APPLICATIONS, FEATURES, POWER MANAGEMENT SETTINGS, BATTERY CONDITION AND OTHER CUSTOMER PREFERENCES. OPTICAL DRIVE OR HARD DRIVE USAGE MAY ALSO HAVE A SIGNIFICANT IMPACT ON BATTERY LIFE. THE BATTERY CHARGING CAPACITY IS REDUCED AS THE BATTERY AGES. IF YOUR BATTERY IS RUNNING LOW QUICKLY, YOU SHOULD REPLACE IT WITH A NEW ONE.
- UNDER FEDERAL, STATE, OR LOCAL LAW IT MAY BE ILLEGAL TO DISPOSE OF BATTERIES BY PUTTING THEM IN THE TRASH. PLEASE TAKE CARE OF OUR ENVIRONMENT AND DISPOSE OF BATTERIES PROPERLY. CHECK WITH YOUR LOCAL GOVERNMENT AUTHORITY FOR DETAILS REGARDING RECYCLING OR DISPOSING OF OLD BATTERIES. IF YOU CANNOT FIND THIS INFORMATION ELSEWHERE, CONTACT YOUR SUPPORT REPRESENTATIVE AT 1-800-8FUJITSU (1-800-838-5487)

### Recharging the Batteries

If you want to know the condition of the primary Lithium ion battery, check the Battery Level indicator located on the Status Indicator panel. The indicator changes as the battery level changes.

The Lithium ion battery is recharged internally using the AC adapter or Auto/Airline adapter. To recharge the battery make sure the battery that needs to be charged is installed in your LifeBook Tablet PC and connect the AC or Auto/Airline adapter.



MAKE SURE THAT THE PERCENTAGE CHARGE IS INDICATED BY THE BATTERY CHARGING INDICATOR ON THE STATUS INDICATOR PANEL.

There is no memory effect on the Lithium ion battery therefore you do not need to discharge the battery completely before recharging. The charge times will be significantly longer if your Tablet PC is in use while the battery is charging. If you want to charge the battery more quickly, put your Tablet PC into Sleep mode, or turn it off while the adapter is charging the battery. *(See Power Management on page 76 for more information on Sleep mode and shutdown procedure)*



USING HEAVY CURRENT DEVICES OR FREQUENT EXTERNAL OPTICAL DRIVE ACCESSES MAY PREVENT CHARGING COMPLETELY.

### **Low Battery State**

When the battery is running low, a low battery notification message will appear. If you do not respond to the low battery message, the batteries will continue to discharge until they are too low to operate. When this happens, your Tablet PC will go into Sleep mode. There is no guarantee that your data will be saved once the Tablet PC reaches this point.



- ONCE THE LOW BATTERY NOTIFICATION MESSAGE APPEARS, YOU NEED TO SAVE ALL YOUR ACTIVE DATA AND PUT YOUR LIFEBOOK TABLET PC INTO SLEEP MODE UNTIL YOU CAN PROVIDE A NEW POWER SOURCE. YOU SHOULD PROVIDE A CHARGED BATTERY, AN AC POWER ADAPTER, OR AUTO/AIRLINE ADAPTER AS SOON AS POSSIBLE.
- WHEN YOU ARE IN SLEEP MODE THERE MUST ALWAYS BE AT LEAST ONE POWER SOURCE ACTIVE. IF YOU REMOVE ALL POWER SOURCES WHILE YOUR LIFEBOOK TABLET PC IS IN SLEEP MODE, ANY DATA THAT HAS NOT BEEN SAVED TO THE HARD DRIVE WILL BE LOST.

Dead Battery Suspend mode shows on the Status indicator just like the normal Sleep mode. Once your Tablet PC goes into Dead Battery Suspend mode you will be unable to resume operation until you provide a source of power either from an adapter, or a charged battery. Once you have provided power, you will need to press the Power/Suspend/Resume button to resume operation.

In the Dead Battery Suspend mode, your data can be maintained for some time, but if a power source is not provided promptly, the Power indicator will stop flashing and go out, meaning that you have lost the data that was not stored. Once you provide power, you can continue to use your Tablet PC while an adapter is charging the battery.

## Shorted Batteries

The Status Indicator panel indicator associated with the Battery Level indicator displays the operating level available in that battery. If this display shows a flashing red LED, it means the battery is damaged and must be replaced so it does not damage other parts of your LifeBook Tablet PC.

## Replacing the Battery

With the purchase of an additional battery, you can have a fully charged spare to swap with one that is not charged. There are two ways to swap batteries, cold-swapping and hot-swapping:

### Cold-swapping Batteries

To cold-swap batteries in your battery bay, follow these easy steps (Figure 34):

- 1 Have a charged battery ready to install.
- 2 Shut down your Tablet PC and disconnect the AC adapter.
- 3 While pushing the battery bay release latches towards each other, slide the battery out of the bay.
- 4 Insert a new battery into the bay, and press it in firmly so that the latches click into place.
- 5 Plug in the AC adapter and turn the power on.

### Hot-swapping Batteries

To hot-swap batteries in your battery bay follow these easy steps:



**BE SURE TO PLUG IN AN AC ADAPTER PRIOR TO REMOVING THE BATTERY.** THERE IS NO BRIDGE BATTERY PRESENT TO SUPPORT THE SYSTEM WHILE THE BATTERY IS BEING REPLACED. IF YOU DO NOT USE AN AC ADAPTER YOU WILL LOSE ANY UNSAVED FILES.

- 1 Plug an AC Adapter into the system and connect it to a power outlet.

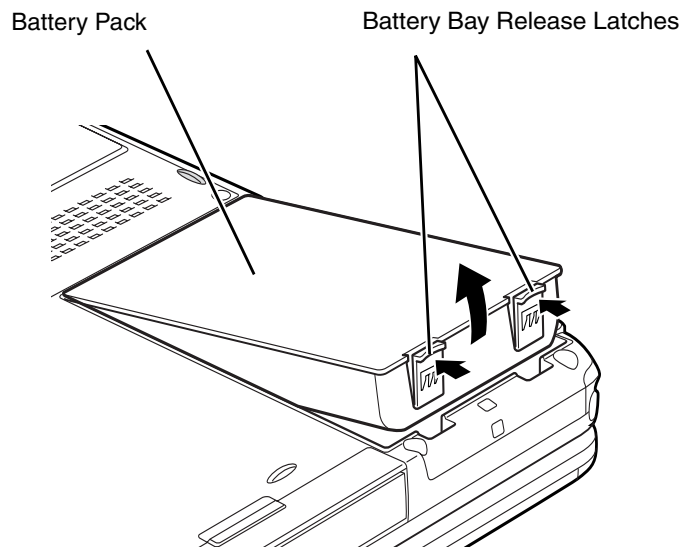
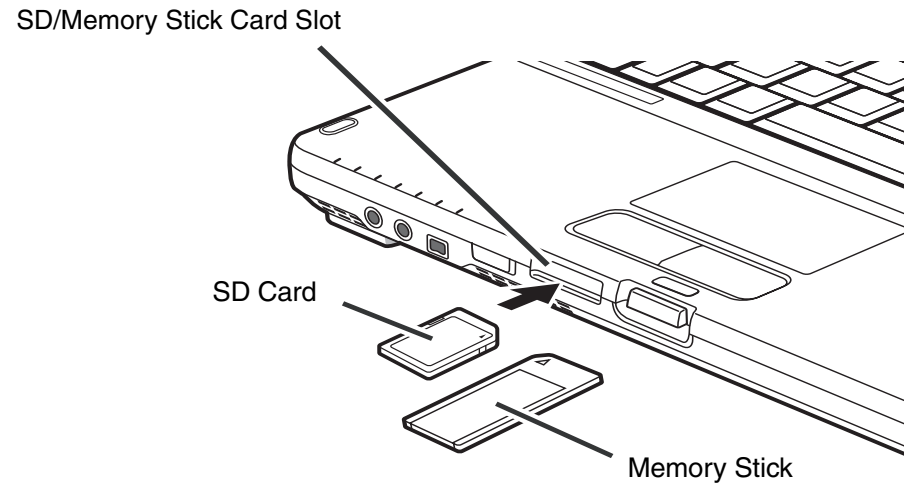

**Figure 34. Removing a Battery**

- 2** Follow steps 3 through 5 in “Cold Swapping Batteries”.



IF THE LITHIUM ION BATTERY CONNECTOR IS NOT FULLY SEATED, YOU MAY NOT BE ABLE TO USE YOUR TABLET PC OR CHARGE YOUR BATTERY.



**Figure 35. Installing a Memory Stick or SD Card**

## **Memory Stick/Secure Digital Cards**

Your LifeBook Tablet PC supports Memory Sticks and Secure Digital (SD) cards, on which you can store and transfer data to and from a variety of digital devices. These cards use flash memory architecture, which means they don't need a power source to retain data.

Memory Stick is a flash memory technology that allows you to record, transfer and share digital content, such as digital pictures, movies, music, voice, and computer data and applications.

Secure Digital (SD) Cards are very similar to Memory Sticks. Like Memory Sticks, SD Cards allow portable storage among a variety of devices, such as cell phones, GPS systems, digital cameras, and PDAs. SD Cards transfer data quickly, with low battery consumption. Like the memory stick, it uses flash memory architecture.

## Installing Memory Stick/SD Cards

Memory Stick and SD Cards are installed in the Memory Stick/SD Card slot. To install a Memory Stick or SD Card, follow these steps:



INSTALLING OR REMOVING A MEMORY STICK OR SD CARD DURING YOUR LIFEBOOK TABLET PC'S SHUTDOWN OR BOOTUP PROCESS MAY DAMAGE THE CARD AND/OR YOUR LIFEBOOK TABLET PC.

DO NOT INSERT A CARD INTO A SLOT IF THERE IS WATER OR ANY OTHER SUBSTANCE ON THE CARD AS YOU MAY PERMANENTLY DAMAGE THE CARD, YOUR LIFEBOOK TABLET PC, OR BOTH.

- 1 See your specific card manual for instructions on the installation of your card. Some cards may require that your Tablet PC is off while installing them.
- 2 Make sure there is no card currently in the slot. If there is, see Removing a Memory Stick/SD Card.
- 3 Insert your card into the slot with the product label facing up.
- 4 Push the card firmly into the slot until it is seated in the connector.

## Removing A Memory Stick/SD Card

To remove a Memory Stick or SD Card, follow these easy steps:



SEE YOUR CARD MANUAL FOR SPECIFIC INSTRUCTIONS ON THE REMOVAL OF YOUR CARD. SOME CARDS MAY REQUIRE YOUR LIFEBOOK TABLET PC TO BE IN SLEEP MODE OR OFF WHILE REMOVING THEM.

- 1 Select Safely Remove Hardware from the System Tray. Highlight the card in the list, then click [Stop].
- 2 Push the Memory Stick or SD Card in until it unlatches. It will then eject from the slot for removal.

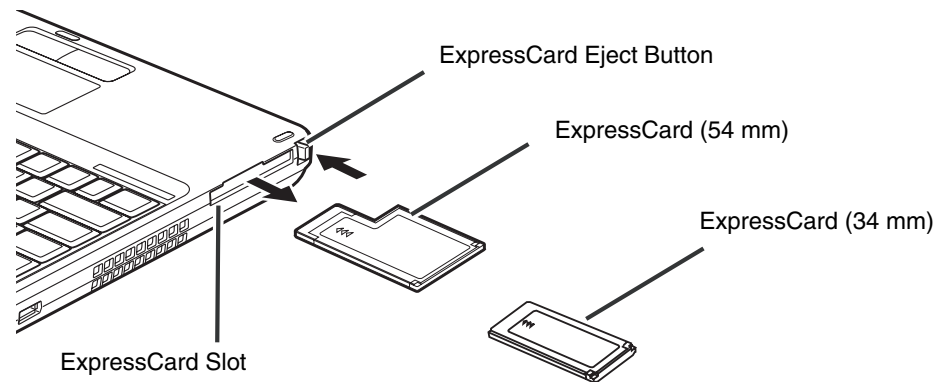

**Figure 36. Installing/Removing an ExpressCard**

## ExpressCards

Your LifeBook supports ExpressCards™ which can perform a variety of functions depending on which type of card you install.

There are two different width ExpressCards: 34 mm and 54 mm. The connector inside the slot is located on the left-hand side of the slot. If you insert a 34 mm card, be sure to align it with the left side of the slot when inserting it.

For further information, refer to the instructions supplied with your card(s).

### Installing ExpressCards

ExpressCards are installed in the ExpressCard slot on the left-hand side of the system.



- INSTALLING OR REMOVING AN EXPRESSCARD DURING YOUR NOTEBOOK'S SHUTDOWN OR BOOTUP PROCESS MAY DAMAGE THE CARD AND/OR YOUR NOTEBOOK.
- DO NOT INSERT AN EXPRESSCARD INTO A SLOT IF THERE IS WATER OR ANY OTHER SUBSTANCE ON THE CARD AS YOU MAY PERMANENTLY DAMAGE THE CARD, YOUR NOTEBOOK, OR BOTH.





YOU MAY BE REQUIRED TO LOG ON AS ADMINISTRATOR OR A MEMBER OF THE ADMINISTRATOR'S GROUP TO COMPLETE THIS PROCEDURE. IF YOUR COMPUTER IS CONNECTED TO A NETWORK, NETWORK POLICY SETTINGS MAY ALSO PREVENT YOU FROM COMPLETING THIS PROCEDURE.

See your ExpressCard manual for instructions on the installation of your card. Some cards may require that your notebook is off while installing them.

To install an ExpressCard, follow these steps (see Figure 36):

- 1** Make sure there is no ExpressCard currently in the slot. If there is, see Removing ExpressCards.
- 2** If the eject button is extended, press it in until it clicks.
- 3** Insert your ExpressCard into the slot with the product label facing up. If you are inserting a 34 mm card, be sure to align it with the left side of the slot when inserting it.
- 4** Push the card firmly into the slot until it is seated in the connector.

### Removing ExpressCards

See your ExpressCard manual for specific instructions on removing your card. Some cards may require your notebook to be in Sleep Mode or Off during removal.



- REMOVE DEVICES USING THE SAFELY REMOVE HARDWARE ICON IN THE SYSTEM TRAY AT THE BOTTOM RIGHT OF YOUR SCREEN.
- IF THE DIALOG BOX STATES THAT THE DEVICE CANNOT BE REMOVED, YOU MUST SAVE ALL OF YOUR OPEN FILES, CLOSE ANY OPEN APPLICATIONS AND SHUT DOWN YOUR NOTEBOOK.

To remove an ExpressCard, follow these steps:

- 1** Unlock the card from the slot by pressing the eject button to the right of the slot in which the card is located. When pressed, the button will pop out.
- 2** Firmly press the button again until it is flush with the notebook. This will eject the card slightly out of the slot allowing you to remove the card.

## Memory Upgrade Module

Your Fujitsu LifeBook Tablet PC comes with a minimum of 1 GB of high speed Double Data Rate Synchronous Dynamic RAM (DDR3-1066 SDRAM) factory installed. To increase your Tablet PC's memory capacity, you may install an additional memory upgrade module. The memory upgrade must be a dual-in-line (DIMM) SDRAM module. To ensure 100% compatibility, purchase the SDRAM module only from the Fujitsu web store at [www.shopfujitsu.com](http://www.shopfujitsu.com).



- DO NOT REMOVE ANY SCREWS FROM THE MEMORY UPGRADE MODULE COMPARTMENT EXCEPT THE ONES SPECIFICALLY SHOWN IN THE DIRECTIONS FOR INSTALLING AND REMOVING THE MEMORY UPGRADE MODULE.
- THE MEMORY UPGRADE MODULE CAN BE SEVERELY DAMAGED BY ELECTROSTATIC DISCHARGE (ESD). TO MINIMIZE RISK TO THE MODULE, OBSERVE THE FOLLOWING PRECAUTIONS:
  - BEFORE HANDLING A MEMORY MODULE, TOUCH A GROUNDED METAL OBJECT TO DISCHARGE STATIC ELECTRICITY BUILT UP IN YOUR BODY.
  - WHEN INSTALLING OR REMOVING A MEMORY MODULE, HOLD IT BY THE EDGE SO AS NOT TO TOUCH ANY CONTACTS OR CHIPS. BE CAREFUL NOT TO TOUCH ANY INTERNAL COMPUTER TERMINALS OR COMPONENTS; THE OIL FROM YOUR FINGERS COULD CAUSE A SHORT TO THE COMPONENTS.
  - BE SURE TO POWER DOWN YOUR SYSTEM BEFORE ADDING OR REMOVING MEMORY MODULES. EVEN IF THE SYSTEM IS IN HIBERNATE OR SLEEP STATES, DATA COULD BE LOST OR THE MEMORY COULD BE DAMAGED IF POWER IS STILL AVAILABLE TO THE SYSTEM.

### Installing Memory Upgrade Modules

- 1** Turn off power to your Tablet PC, remove any power adapter (AC or auto/airline). Remove the battery.
- 2** Make sure that all the connector covers are closed.
- 3** Turn the Tablet PC bottom side up, and remove the screws from the memory upgrade module compartment.
- 4** Slide the cover towards the battery compartment slightly, then lift it and remove it (Figure 37).
- 5** Remove the memory upgrade module from the static guarded sleeve.
- 6** Align the memory upgrade module with the part side up. Align the connector edge of the memory upgrade module with the connector slot in the compartment.(Figure 38)

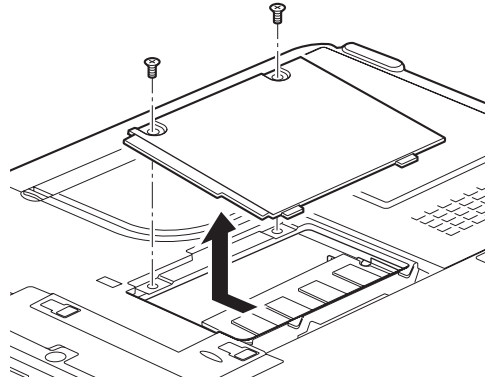

**Figure 37. Opening Memory Compartment**

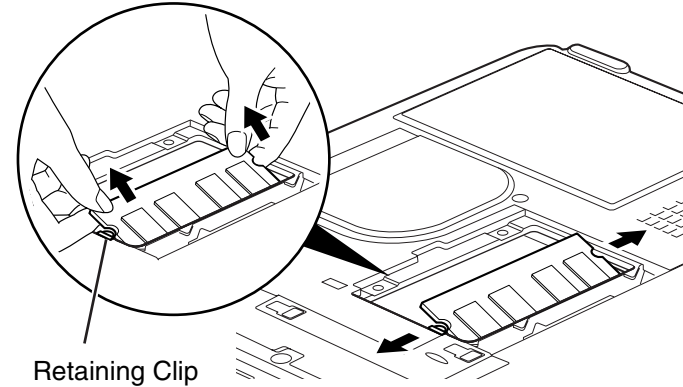

**Figure 38. Installing a Second Memory Module**

- 7** Insert the memory upgrade module at a 45° angle. Press the connector edge of the module firmly down and into the connector until it lodges under the retaining clip. You'll hear a click when it is properly in place.
- 8** Replace the cover and reinstall the screws.



THE MEMORY UPGRADE MODULE IS NOT SOMETHING YOU ROUTINELY REMOVE FROM YOUR TABLET PC. ONCE IT IS INSTALLED, YOU CAN LEAVE IT IN PLACE UNLESS YOU WANT TO CHANGE SYSTEM MEMORY CAPACITY.

## Removing a Memory Upgrade Module

- 1 Perform steps 1 through 4 of Installing a Memory Upgrade Module.
- 2 Pull the clips sideways away from each side of the memory upgrade module at the same time.
- 3 While holding the clips out, remove the module by lifting it up and pulling it away from your Tablet PC.
- 4 Store the memory upgrade module in a static guarded sleeve.

Replace the cover and reinstall the screws.

## Checking the Memory Capacity

Once you have changed the system memory capacity by replacing the installed module with a larger one, be sure to check that your Tablet PC has recognized the change.

- If you are in Control Panel Home view, check the memory capacity by clicking [Start] -> Control Panel -> System and Maintenance -> System -> **View amount of RAM and processor speed**. The amount of memory is displayed next to “Memory - RAM:”
- If you are in Classic view, check the memory capacity by clicking [Start] -> Control Panel -> System. The amount of memory is displayed next to “Memory - RAM:”

There may be a variation between the actual memory size and what is displayed. This is possible if your system is configured with an integrated Intel Graphics Media Accelerator which dynamically allocates system memory to accelerate graphics performance.



IF THE TOTAL MEMORY DISPLAYED IS INCORRECT, CHECK THAT YOUR MEMORY UPGRADE MODULE IS PROPERLY INSTALLED. (IF THE MODULE IS PROPERLY INSTALLED AND THE CAPACITY IS STILL NOT CORRECTLY RECOGNIZED, SEE TROUBLESHOOTING ON PAGE 104.)

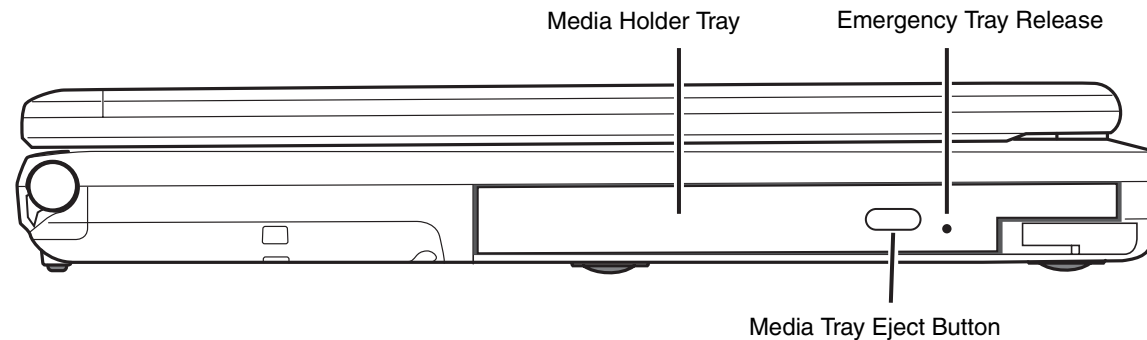

**Figure 39. Optical Drive**

## Optical Drive

There is a variety of media available to use with your Multi-Format DVD Writer, also known as an “optical drive”.

DVD-R and DVD-RW discs hold up to 4.7 GB of data (DVD-R discs used with Multi-Format Dual-Layer DVD writer hold up to 8.5 GB). A DVD-R disc can only be written to once; DVD-RW discs can be written to over and over. DVD-R and DVD-RW discs can be played on most standard players. CD-R and CD-RW discs hold up to 700 MB of data. A CD-R disc can only be written to once; CD-RW discs can be written to over and over.

Your system contains the following optical drive:

**Dual-Layer Multi-Format DVD Writer:** This drive allows you to access movies, software, and audio DVD/CDs as well as to read and write to CD-R, CD-RW, DVD-R, DVD+R, DVD-RW, DVD+RW, and DVD RAM discs. The dual-layer architecture allows you to record up to 8.5 GB of data on DVD+R discs.

### Media Player Software

With the Dual-Layer Multi-Format DVD Writer and media player software you can play DVD movies and music CDs on your notebook. The media player includes controls which allow you to take full advantage of the features of a DVD movie, as well as standard features such as fast forward, fast reverse, pause, etc. With this drive you can also burn onto recordable DVD-R/RW, DVD+R/RW, or CD-R/RW discs.



- DO NOT OPERATE YOUR OPTICAL DRIVE UNLESS YOUR LIFEBOOK NOTEBOOK IS SITTING ON A FLAT SURFACE. USING A DRIVE WHEN THE SYSTEM IS NOT LEVEL MAY DAMAGE THE DRIVE OR PREVENT PROPER OPERATION.
- PROLONGED USE OF THE OPTICAL DRIVE, SUCH AS WATCHING A DVD MOVIE, WILL SUBSTANTIALLY REDUCE YOUR BATTERY LIFE IF NO EXTERNAL POWER SOURCE IS ATTACHED.

## Loading Media on Your Drive

To load a disc into your optical drive:

- 1 Push and release the eject button on the front of the optical drive to open the holder tray. The tray will come out of the LifeBook notebook a short distance.
- 2 Gently pull the tray out until a media disc can easily be placed in the tray.



- YOU SHOULD PERIODICALLY CHECK THE FUJITSU WEBSITE AT [US.FUJITSU.COM/COMPUTERS](http://US.FUJITSU.COM/COMPUTERS) FOR THE MOST CURRENT DRIVERS.
  - ALL LIFEBOOK DVD PLAYERS ARE SET TO PLAY DVD TITLES WITH REGION CODE NUMBER 1 WHICH IS SPECIFIED FOR THE NORTH AMERICAN MARKET. THE REGION NUMBER IS A REGIONAL RESTRICTION CODE DEFINED BY THE DVD FORUM ACTING ON HOLLYWOOD REQUIREMENTS. DIFFERENT REGION CODES ARE RECORDED ON VIDEO DVD TITLES FOR PUBLICATION IN DIFFERENT AREAS OF THE WORLD. IF THE REGIONAL CODE OF THE DVD PLAYER DOES NOT MATCH THE REGIONAL CODES ON THE TITLES, THEN PLAYBACK IS IMPOSSIBLE.
  - YOU CAN CHANGE THE REGION CODE ON THE DVD PLAYER USING THE PROPERTIES MENU OF THE DVD SOFTWARE. NOTE, HOWEVER, THAT **YOU CAN ONLY CHANGE THE REGION CODE UP TO FOUR TIMES**. AFTER THE 4TH CHANGE, THE LAST CODE ENTERED BECOMES PERMANENT, AND CANNOT BE CHANGED.
- 3 Place the media into the tray, label side up, with the hole in the center of the disc. Snap the disc onto the raised circle in the center of the tray.

- 4 Gently push the holder tray back in until you hear a click



IF YOU HAVE DISABLED THE AUTO INSERT NOTIFICATION FUNCTION, YOU WILL HAVE TO START THE DRIVE EITHER BY USING MY COMPUTER OR FROM WITHIN WINDOWS EXPLORER, SINCE YOUR NOTEBOOK WILL NOT AUTOMATICALLY RECOGNIZE THAT MEDIA HAS BEEN LOADED.

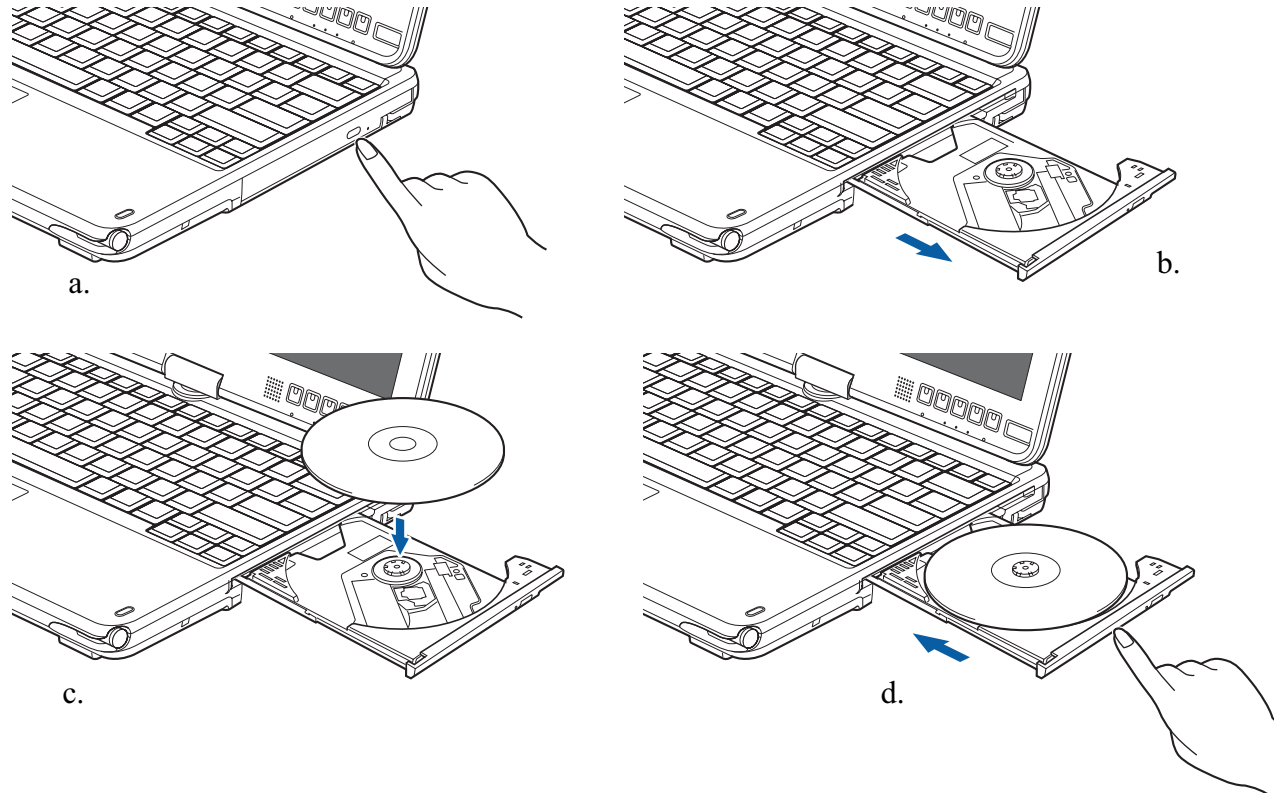

**Figure 40. Loading/Ejecting Media**

## Removing Media

- 1 Push and release the eject button on the front of the optical drive. This will stop the drive and the holder tray will come out of the LifeBook notebook a short distance.
- 2 Gently pull the tray out until the disc can easily be removed from the tray.
- 3 Carefully remove the media disc from the holder tray.
- 4 Gently push the holder tray back in until you hear a click.

## Emergency Optical Drive Tray Release

If for some reason the eject button fails, you can open the media tray with a paper clip or similar tool inserted into the eject hole in the right side of the front of the tray. Straighten one side of a paper clip and push it gently into the hole. The tray will pop out.

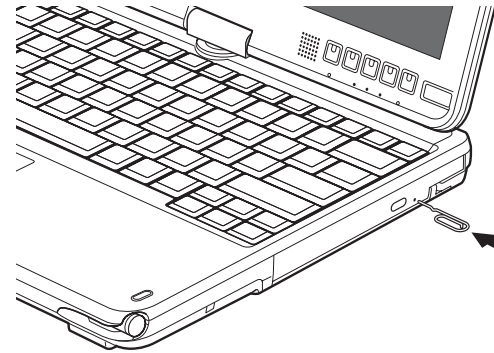

Figure 41. Emergency Tray Release

## Using the Media Player Software



DEPENDING UPON ITS CONFIGURATION, YOUR SYSTEM MAY NOT HAVE THE MEDIA PLAYER SOFTWARE PRE-INSTALLED. IF IT IS NOT INSTALLED, REFERENCE THE DOCUMENTATION THAT ACCOMPANIES THE MEDIA APPLICATION.



### Starting a DVD Movie

- 1 Insert the DVD into the optical drive of the notebook. If the CD AutoRun feature activates, skip Step 2.
- 2 The first time you insert a movie into the DVD/CD-RW tray, you will be prompted to select what you want the system to do when discs are inserted (e.g., start automatically or wait for a prompt). Until you make a selection, you will receive the same prompt whenever you insert a disc.
- 3 Click **OK** to close the About DVD Player Performance dialog box and the movie will begin.

### Opening the Media Player Control Panel

With most DVD-ROMs, you have the option of altering how the movie should play and what you wish to view. You can do this by using the media player control panel and the mouse.

- 1 Right-click on the movie screen to open a dropdown menu for options.
- 2 Select **View**, then **Player** for all controls available. This will open the control panel at the bottom of the screen.

### Using the Media Player Control Panel

The media player software allows you to watch the movie much like a VCR player. You can pause, rewind, fast-forward and stop the movie at any point.

- 1 To pause the movie, click the on-screen **II** button.
- 2 To rewind the movie, click the **◀** button to rewind to a specific portion of the movie, or the **◀◀** button to return to the opening screen.
- 3 To fast-forward the movie, click the **▶** button to forward to a specific portion of the movie, or the **▶▶** button to jump to the ending credits.
- 4 To stop the movie, click the **■** button.

### Exiting the Media Player

- 1 Click the **X** located in the upper right corner of the title bar. This will open a media player dialog box.
- 2 Click Yes to stop and exit the movie, or No to close the media player dialog box and return to the movie.

## Using Media Player on Battery Power

Since optical drives consume a lot of power, your overall battery life will be significantly shorter when operating the optical drive continuously (such as watching a DVD movie) than during standard operation.



- MANY MOVIE RUN-TIMES ARE LONGER THAN YOUR SYSTEM CAN SUPPORT ON A SINGLE BATTERY. IF YOU ARE WATCHING A DVD MOVIE ON BATTERY POWER YOU MAY NEED TO SWAP IN AN ADDITIONAL, CHARGED BATTERY OR ATTACH AC POWER DURING THE MOVIE TO VIEW IT IN ITS ENTIRETY.
- AN ADDITIONAL FULLY-CHARGED BATTERY IS HIGHLY RECOMMENDED IF YOU WILL BE WATCHING DVD MOVIES ON BATTERY POWER. IF YOU DON'T HAVE AN ADDITIONAL BATTERY, YOU MAY PURCHASE ONE EITHER ONLINE AT: [HTTP://WWW.COMPUTERS.US.FUJITSU.COM](http://www.computers.us.fujitsu.com) OR BY CALLING 1-877-372-3473.

### To Watch a Movie on Battery Power:

- 1 Have an additional full-charged battery or your AC adapter ready for use.
- 2 Start watching your DVD movie.
- 3 When the low battery warning occurs, immediately stop the movie and exit the media player.



IF YOU DO NOT STOP THE MEDIA PLAYER QUICKLY AND THE LIFEBOOK NOTEBOOK ATTEMPTS TO AUTO-SUSPEND (CRITICAL BATTERY LOW STATE) THE LIFEBOOK NOTEBOOK WILL SHUT DOWN IMPROPERLY. IF THIS OCCURS, YOU MAY NEED TO PERFORM A HARD RESET AND FOLLOW THE INSTRUCTIONS, IF ANY, PRESENTED TO YOU BEFORE THE SYSTEM WILL REBOOT.

- 4 Power down your notebook and replace the discharged battery with an additional fully-charged battery. If you do not have an additional battery, you may attach AC power as soon as you see the low battery warning.
- 5 Resume operation by pressing the Suspend button again. This is not required if you attached AC power without entering standby mode.
- 6 Restart your media player, locate and skip to the chapter of the movie you were last watching, then continue watching your DVD movie.



SOME SHORTER DVD MOVIES MAY NOT REQUIRE YOU TO SWAP BATTERIES OR ATTACH AC POWER TO COMPLETE THEM. HOWEVER, IT IS BEST TO BE PREPARED SINCE ACTUAL BATTERY LIFE WHILE OPERATING THE OPTICAL DRIVE CANNOT BE GUARANTEED.

## Device Ports

Your Fujitsu LifeBook Tablet PC and the optional Port Replicator come equipped with multiple ports to which you can connect external devices including: disk drives, keyboards, printers, etc.

### Internal LAN (RJ-45) Jack

The internal LAN (RJ-45) jack is used for a Gigabit (10Base-T/100Base-Tx/1000Base-T) Ethernet LAN connection. You may need to configure your Tablet PC to work with your particular network. (Please refer to your network administrator for information on your network configuration.) To connect the LAN cable follow these easy steps:

- 1** Align the connector with the port opening.
- 2** Push the connector into the port until it is seated.
- 3** Plug the other end of the cable into a LAN outlet.

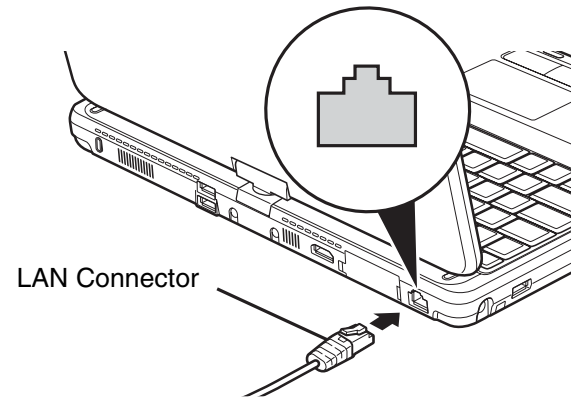

**Figure 42. Connecting the LAN**

### Port Replicator Connector

The port replicator connector located on the bottom of your system is used for the connection of your Tablet PC to an optional port replicator. (See Figure 6 for location). In order to connect your Tablet PC to this device, follow the instructions that came with your port replicator.

## Universal Serial Bus Ports

The Universal Serial Bus 2.0 ports (USB) allow you to connect USB devices such as external game pads, pointing devices, keyboards and/or speakers. There are three USB 2.0 ports on your Tablet PC: one on the left side and two on the rear..

In order to connect a USB device follow these steps:

- 1 Align the connector with the port opening.
- 2 Push the connector into the port until it is seated.

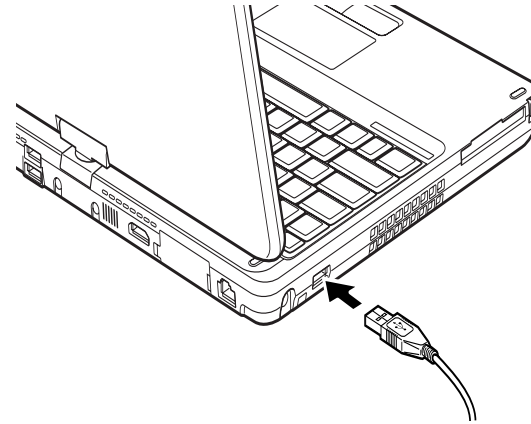

**Figure 43. Connecting a USB Device**



DUE TO THE ONGOING CHANGES IN USB TECHNOLOGY AND STANDARDS, NOT ALL USB DEVICES AND/OR DRIVERS ARE GUARANTEED TO WORK.

## IEEE 1394 Port

The 4-pin 1394 port allows you to connect digital devices that are compliant with IEEE 1394 standard. The IEEE 1394 standard is easy to use, connect, and disconnect. This port can allow up to 400 Mbps transfer rate. A third-party application may be required to operate your device with the 1394 port.



THE 1394 PORT USED IN THIS SYSTEM USES A FOUR-PIN CONFIGURATION. IF YOU INTEND TO INTERFACE WITH DEVICES WHICH USE A SIX-PIN CONFIGURATION, YOU WILL NEED TO PURCHASE AN ADAPTER.

In order to connect a 1394 device, follow these steps:

- 1 Align the connector with the port opening.
- 2 Push the connector into the port until it is seated.

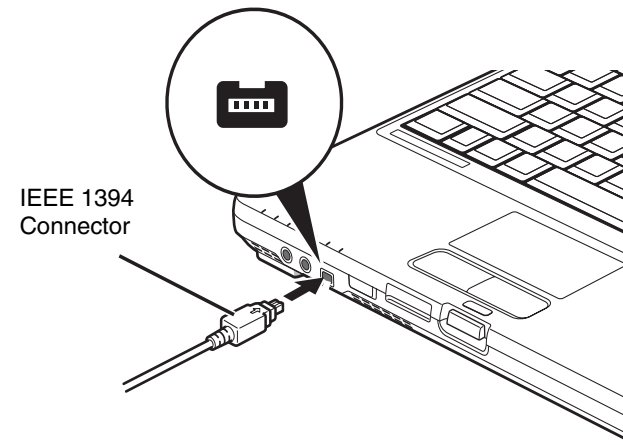

**Figure 44. Connecting an IEEE1394 Device**

### **Headphone Jack**

The headphone jack allows you to connect headphones or powered external speakers to your Tablet PC. Your headphones or speakers must be equipped with a 1/8" (3.5 mm) stereo mini-plug. In order to connect headphones or speakers follow these easy steps:

- 1 Align the connector with the port opening.
- 2 Push the connector into the port until it is seated.

### Microphone Jack

The microphone jack allows you to connect an external microphone. Your microphone must be equipped with a 1/8" (3.5 mm) mono mini-plug in order to fit into the microphone jack of your Tablet PC. In order to connect a microphone follow these easy steps:

- 1 Align the connector with the port opening and push the connector into the port until it is seated.

### HDMI Port

The High-Definition Multimedia Interface (HDMI) port is a digital audio/video interface over which uncompressed streams can be transmitted. HDMI is used to connect compatible digital devices with your computer (such as big-screen TVs and video recorders). See the note on the next page regarding the steps for selecting the HDMI device using keyboard shortcuts.

To connect an HDMI device:

- 1 Align the connector with the port opening.
- 2 Push the connector into the port until it is seated.

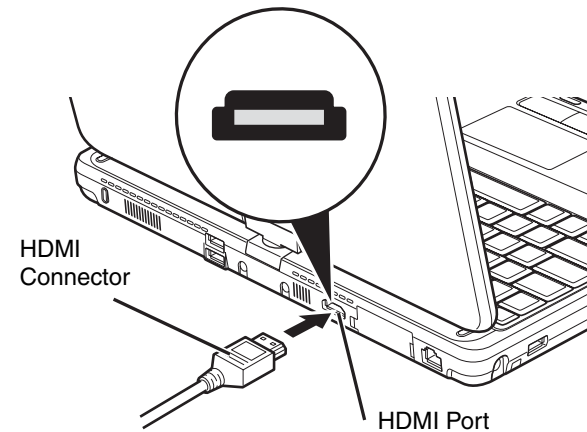

**Figure 45. Connecting an HDMI device**

### External Video Port

The external video port allows you to connect an external monitor or LCD projector. In order to connect an external video device, follow these easy steps:

- 1 Align the connector with the port opening.
- 2 Push the connector into the port until it is seated.
- 3 Tighten the two hold-down screws, located on each end of the connector.



PRESSING THE [FN] + [F10] KEYS ALLOWS YOU TO CHANGE YOUR SELECTION OF WHERE TO SEND YOUR DISPLAY VIDEO. THE ORDER IS DETERMINED BY WHICH TYPE OF EXTERNAL VIDEO DEVICE(S) IS CONNECTED. EACH TIME YOU PRESS THE KEY COMBINATION, YOU WILL STEP TO THE NEXT CHOICE.

IF YOU ONLY HAVE AN EXTERNAL CRT CONNECTED, THE ORDER IS: INTERNAL DISPLAY -> EXTERNAL CRT -> SIMULTANEOUS DISPLAY -> INTERNAL DISPLAY.

IF YOU ONLY HAVE AN HDMI DEVICE CONNECTED, THE ORDER IS: INTERNAL DISPLAY -> HDMI DISPLAY -> SIMULTANEOUS DISPLAY -> INTERNAL DISPLAY.

IF YOU HAVE EXTERNAL CRT AND HDMI DEVICES CONNECTED, THE ORDER IS: INTERNAL DISPLAY -> EXTERNAL CRT -> SIMULTANEOUS INTERNAL AND EXTERNAL CRT -> HDMI DISPLAY - SIMULTANEOUS INTERNAL AND HDMI DISPLAY -> INTERNAL DISPLAY.

IF YOU HAVE AN EXTERNAL CRT AND DVI DEVICES CONNECTED TO THE PORT REPLICATOR, THE ORDER IS: INTERNAL DISPLAY -> EXTERNAL CRT -> SIMULTANEOUS INTERNAL AND EXTERNAL CRT -> DVI DISPLAY -> SIMULTANEOUS INTERNAL AND DVI DISPLAY. -> INTERNAL DISPLAY.

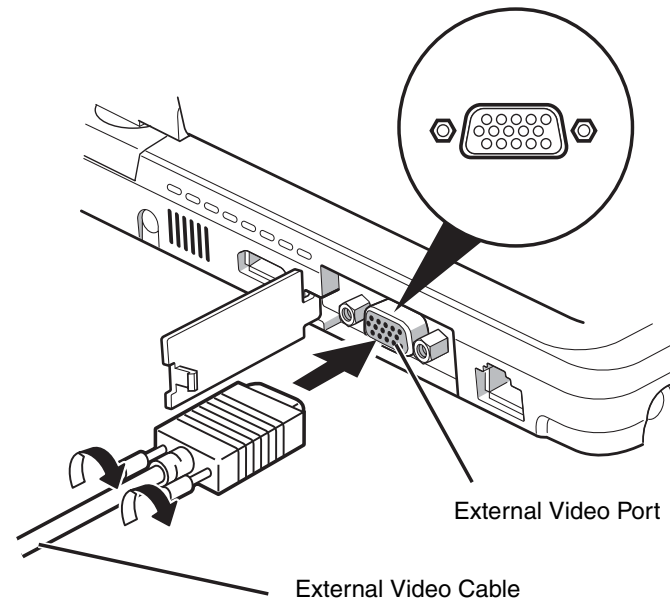

**Figure 46. Connecting an External Video Device**



## Chapter 4

# Troubleshooting Your LifeBook

---

## Troubleshooting

There may be occasions when you encounter simple setup or operating problems that you can solve on the spot, or problems with peripheral devices that can be solved by replacing the device. The information in this section helps you isolate and resolve some of these straightforward issues and identify failures that require service.

### Identifying the Problem

If you encounter a problem, go through the following procedure before pursuing complex troubleshooting:

- 1 Turn off your LifeBook Tablet PC.
- 2 Make sure the AC adapter is plugged into your Tablet PC and to an active AC power source.
- 3 Make sure that any card installed in the ExpressCard slot is seated properly. You can also remove the card from the slot, thus eliminating it as a possible cause of failure.
- 4 Make sure that any devices connected to the external connectors are plugged in properly. You can also disconnect such devices, thus eliminating them as possible causes of failure.
- 5 Turn on your Tablet PC. Make sure it has been off at least 10 seconds before you turn it back on.
- 6 Go through the boot sequence.



- 7** If the problem has not been resolved, refer to the Troubleshooting Table, that follows, for more detailed troubleshooting information.



IF YOU KEEP NOTES ABOUT WHAT YOU HAVE TRIED, YOUR SUPPORT REPRESENTATIVE MAY BE ABLE TO HELP YOU MORE QUICKLY BY GIVING ADDITIONAL SUGGESTIONS OVER THE PHONE.

- 8** If you have tried the solutions suggested in the Troubleshooting Table without success, contact your support representative:

Toll free: 1-800-8Fujitsu (1-800-838-5487)

E-mail: [8fujitsu@us.fujitsu.com](mailto:8fujitsu@us.fujitsu.com)

Web site: <http://www.computers.us.fujitsu.com/support>.

Before you place the call, you should have the following information ready so that the customer support representative can provide you with the fastest possible solution:

- Product name
- Product configuration number
- Product serial number
- Purchase date
- Conditions under which the problem occurred
- Any error messages that have occurred
- Type of device connected, if any

See the Configuration Label on the bottom of your Tablet PC for configuration and serial numbers.

## Specific Problems

### Using the Troubleshooting Table

When you have problems with your LifeBook Tablet PC, try to find the symptoms under the Problem column of the troubleshooting table for the feature giving you difficulty. You will find a description of common causes for that symptom under the column Possible Cause and what, if anything, you can do to correct the condition under Possible Solutions. All possible causes or solutions may not apply to your Tablet PC.

### Troubleshooting Table

| <b>Problem</b>                       | <b>Page</b> | <b>Problem</b>                         | <b>Page</b> |
|--------------------------------------|-------------|--|-------------|
| Audio Problems . . . . .             | page 107    | USB Device Problems . . . . .          | page 109    |
| Optical Drive Problems. . . . .      | page 107    | ExpressCard Problems . . . . .         | page 110    |
| Port Replicator Problems . . . . .   | page 108    | Power Failures. . . . .                | page 110    |
| Hard Drive Problems . . . . .        | page 108    | Shutdown and Startup Problems. . . . . | page 112    |
| Keyboard or Mouse Problems . . . . . | page 109    | Video Problems. . . . .                | page 113    |
| Memory Problems . . . . .            | page 109    | Miscellaneous Problems . . . . .       | page 115    |

| Problem   | Possible Cause   | Possible Solutions  |
|---|--|---|
| <b>Audio Problems</b>                                     |  |   |
| There is no sound coming from the built-in speaker.       | The volume is turned too low.  | Adjust the volume control on your Tablet PC and operating system. Use the [Fn+F9] key combination on your keyboard. Pressing [F9] repeatedly while holding [Fn] will increase the volume of your Tablet PC.   |
|   | The software volume control is set too low.                            | Manually adjusting the volume (i.e., keyboard "hot keys") should dynamically adjust the volume of the operating system (see above). If that doesn't work, adjust the sound volume control settings in your software or application.   |
|   | Headphones are plugged into your Tablet PC.                            | Plugging in headphones disables the built-in speakers. Remove the headphones.   |
|   | BIOS audio settings are incorrect.                                     | Set the BIOS setup utility to the default values within the Multimedia Device Configuration menu. <i>See "BIOS Setup Utility" on page 71.</i>   |
|   | Software driver is not configured correctly.                           | The audio driver may be installed or reinstalled using the Drivers and Applications CD that came with your Fujitsu LifeBook. Refer to your application and operating system documentation for help.   |
|   | The speakers have been muted using the Volume icon in the system tray. | Click the Volume icon in the system tray on the bottom right of the screen. (It looks like a speaker). If the Mute box has a red circle on it, click on it to unselect it. You can also use the [Fn+F3] key combination to toggle the volume on and off. Pressing [F3] while holding [Fn] will toggle the audio mute. |
| <b>Optical Drive Problems (optional external device)</b>  |  |   |
| LifeBook Tablet PC fails to recognize DVD/CD-RW/CD-ROM's. | The disc is not pushed down onto raised center circle of the drive.    | Open optical drive tray and re-install the disc properly.   |
|   | Incorrect DVD Player or no DVD Player software is installed.           | Install DVD Player software. <i>(See "Media Player Software" on page 93 for more information.)</i>  |

| Problem   | Possible Cause  | Possible Solutions  |
|---|---|---|
| LifeBook Tablet PC fails to recognize DVD/CD-RW/CD-ROM's.<br><br>(continued)  | Optical drive tray is not latched shut.   | Push on the front of the optical drive tray until it latches. If that doesn't work, pull out the modular drive latch to remove the device from the bay, then re-insert the drive until it latched; this ensures that the drive is properly seated.  |
|   | Wrong drive designator was used for the disc in the application.  | Verify the drive designator used by the application is the same as the one used by the operating system. When the operating system is booted from a DVD/CD, drive designations are automatically adjusted. Note that the drive designation can be changed with the Disk Management tool located at Administrative Tools -> Computer Management. |
|   | DVD/CD-RW/CD-ROM is dirty or defective.   | Wipe the disc with a non-abrasive CD cleaning cloth and reinsert. If it still will not work try another DVD/CD-RW/CD-ROM in the drive.  |
| The drive access indicator on the Status Indicator Panel blinks regularly with no disc in the tray or the drive is not installed. | The Windows auto insertion function is active and is checking to see if a disc is ready to run.             | This is normal. However, you may disable this feature.  |
| <b>Port Replicator Problems</b>   |   |   |
| <b>Note:</b> Be sure to power down your LifeBook Tablet PC before adding a printer to the Port Replicator parallel port.          |   |   |
| Tablet PC does not turn on when installed in the optional Port Replicator   | Port Replicator AC adapter is not plugged in.   | Provide power to the Port Replicator.   |
|   | Tablet PC is not properly seated in the Port Replicator.  | Remove and re-dock your LifeBook Tablet PC.   |
| <b>Hard Drive Problems</b>  |   |   |
| You cannot access your hard drive.  | The wrong drive designator was used by an application when a bootable disc was used to start the Tablet PC. | Verify drive designator used by application is in use by the operating system. When the operating system is booted from a CD, drive designations are automatically adjusted.  |

| <b>Problem</b>  | <b>Possible Cause</b>   | <b>Possible Solutions</b>   |
|---|---|---|
| You cannot access your hard drive.<br>(continued)   | Security is set so your operating system cannot be started without a password.    | Verify your password and security settings.   |
| <b>Keyboard or Mouse Problems</b>   |   |   |
| The built-in keyboard does not seem to work.  | The Tablet PC has gone into Sleep mode.   | Push the <b>Power/Suspend/Resume</b> button.  |
|   | Your application has locked out your keyboard.                                    | Try to use your integrated pointing device to restart your system.                                  |
| You have installed an external keyboard or mouse, and it does not seem to work.                               | Your external device is not properly installed.                                   | Re-install your device. See <i>“Device Ports” on page 99.</i>                                       |
|   | Your operating system is not set up with correct software driver for that device. | Check your device and operating system documentation and activate the proper driver.                |
| You have connected an external keyboard or a mouse and it seems to be locking up the system.                  | Your operating system is not setup with correct software driver for that device.  | Check your device and operating system documentation and activate the proper driver.                |
|   | Your system has crashed.  | Try to restart your Tablet PC.  |
| <b>Memory Problems</b>  |   |   |
| Your System screen in the Control Panel does not show the correct amount of installed memory.                 | Your memory upgrade module is not properly installed.                             | Remove and re-install your memory upgrade module. See <i>“Memory Upgrade Module” on page 90.</i>    |
|   | You have a memory failure.  | Check for Power On Self Test (POST) messages. See <i>“Power On Self Test Messages” on page 116.</i> |
| <b>USB Device Problems</b>  |   |   |
| Your system does not recognize a USB device you have installed, or the device does not seem to work properly. | The device is not properly installed.   | Remove and re-install the device. See <i>“Device Ports” on page 99.</i>                             |

| <b>Problem</b>   | <b>Possible Cause</b>   | <b>Possible Solutions</b>   |
|--|---|---|
| Your system does not recognize a USB device you have installed, or the device does not seem to work properly.<br>(continued) | The device may have been installed while an application was running, so your system is not aware of its installation. | Close the application and restart your Tablet PC.   |
|  | Your device may not have the correct software driver active.  | See your software documentation and activate the correct driver.  |
| <b>ExpressCard Problems</b>  |   |   |
| A card inserted in the ExpressCard slot does not work or is locking up the system.   | Card is not properly installed.   | Remove and re-install the card. <i>See "ExpressCards" on page 88.</i>   |
|  | Card may have been installed while an application was running, so your Tablet PC is not aware of its installation.    | Close the application and restart your Tablet PC.   |
|  | Your software may not have the correct driver active.   | See your software documentation and activate the correct driver.  |
| <b>Power Failures</b>  |   |   |
| You turn on your LifeBook Tablet PC and nothing seems to happen.   | The installed battery is completely discharged or there is no Power adapter (AC or Auto/Airline) installed.           | Check the Status Indicator Panel to determine the presence and condition of the battery. See "Status Indicator Panel" on page 30. Install a charged battery or a Power adapter.   |
|  | The battery is installed but is faulty.   | Use the Status Indicator panel to verify the presence and condition of the battery. See "Status Indicator Panel" on page 30. If the battery indicates a short, remove it and operate from another power source or replace that battery. |
|  | The battery is low.   | Check the Status Indicator Panel to determine the presence and condition of the battery. See "Status Indicator Panel" on page 30. Use a Power adapter to operate until a battery is charged or install a charged battery.               |

| <b>Problem</b>  | <b>Possible Cause</b>  | <b>Possible Solutions</b>  |
|---|--|--|
| You turn on your LifeBook Tablet PC and nothing seems to happen.<br>(continued) | The power adapter (AC or auto/airline) is not plugged in properly.   | Verify that your adapter is connected correctly. <i>See "Power Sources" on page 67.</i>  |
|   | The power adapter (AC or auto/airline) has no power from the AC outlet, airplane jack, or car cigarette lighter. | Move the AC cord to a different outlet, check for a line switch or tripped circuit breaker for the AC outlet. If you are using an auto/airline adapter in a car make sure the ignition switch is in the On or Accessories position.  |
|   | The power adapter (AC or auto/airline) is faulty.  | Try a different power adapter.   |
| Your LifeBook Tablet PC turns off all by itself.                                | The power management parameters are set for auto timeouts which are too short for your operating needs.          | Press any button on the keyboard, or move the mouse to restore operation. If that fails, push the Power/Suspend/Resume button. Check your power management settings, or close your applications and go to the Power Options located in the Control Panel to adjust the timeout values to better suit your needs. |
|   | You ignored a low battery alarm until the battery entered Dead Battery Suspend mode.                             | Install a power adapter, then push the Power/Suspend/Resume button. <i>See "Power Sources" on page 67.</i>   |
|   | You have a battery failure.  | Verify the condition of the battery using the Status Indicator panel. If the battery is shorted, replace or remove it. <i>See "Status Indicator Panel" on page 30.</i>   |
|   | Your power adapter has failed or lost its power source.  | Make sure the adapter is plugged in and the outlet has power.  |
| Your Tablet PC will not work on battery alone.                                  | The installed battery is dead.   | Replace the battery with a charged one or install a power adapter.   |
|   | No battery is installed.   | Install a charged battery.   |
|   | The battery is improperly installed.   | Verify that the battery is properly connected by re-installing it.   |

| <b>Problem</b>  | <b>Possible Cause</b>  | <b>Possible Solutions</b>   |
|---|--|---|
| Your Tablet PC will not work on battery alone.<br>(continued)                                   | Your installed battery is faulty.  | Verify the condition of the battery using the Status Indicator panel and replace or remove any batteries that are shorted. See "Status Indicator Panel" on page 30.             |
| The battery seems to discharge too quickly.   | The power savings features may be disabled.  | Check the Power Options menu settings and adjust according to your operating needs.   |
|   | You're running an application that uses a lot of power due to frequent optical drive access, or use of a LAN ExpressCard, WLAN, or Bluetooth device. | Use a power adapter for this application when at all possible.  |
|   | The brightness is turned all the way up.   | Turn down the brightness adjustment. The higher the brightness the more power your display uses.  |
|   | The battery is very old.   | Replace the battery.  |
|   | The battery was exposed to high temperatures.  | Replace the battery.  |
|   | The battery is too hot or too cold.  | Restore the Tablet PC to normal operating temperature. Charging icon on the Status Indicator panel will flash when battery is outside of operating range.                       |
| <b>Shutdown and Startup Problems</b>  |  |   |
| The Suspend/Resume button does not work.  | Suspend/Resume button is disabled.   | To enable the button, go to the Control Panel -> Power Options and click on the Advanced tab. In the Power buttons area, select the "Change what the power button does" option. |
|   | There may be application software. conflict  | Close all applications and try the button again.  |
| The system powers up and displays power on information, but fails to load the operating system. | You have a secured system requiring a password to load your operating system.  | Make sure you have the right password. Enter the setup utility and verify the Security settings and modify them as accordingly. See "BIOS Setup Utility" on page 71.            |



| Problem  | Possible Cause  | Possible Solutions   |
|--|---|--|
| The system powers up, and displays power on information, but fails to load the operating system. (continued) | The boot sequence settings of the setup utility are not compatible with your configuration.               | Set the operating source by pressing the [ESC] key while the Fujitsu logo is on screen or use the [F2] key and enter the setup utility and adjust the source settings from the Boot menu. See "BIOS Setup Utility" on page 71. |
|  | Internal hard drive was not detected.   | Use the BIOS setup utility to try to auto detect the internal hard drive.  |
| An error message is displayed on the screen during the boot sequence.  | Power On Self Test (POST) has detected a problem.   | See the Power On Self Test (POST) messages to determine the meaning and severity of the problem. Not all messages are errors; some are simply status indicators. See "Power On Self Test Messages" on page 116.                |
| Your Tablet PC appears to change setup parameters when you start it.   | BIOS setup changes were not saved when made and you exited the setup utility.                             | Make sure you select <b>Save Changes And Exit</b> when exiting the BIOS setup utility.   |
|  | The BIOS CMOS hold-up battery has failed.   | Contact your support representative for repairs. This is not a user serviceable part but has a normal life of 3 to 5 years.  |
| Your system display won't turn on when the system is turned on or has resumed.                               | You have installed the LifeBook/Security Application panel.   | Check the Status Indicator Panel for presence of the Security icon. If it is visible, enter your password See "Status Indicator Panel" on page 30.   |
| <b>Video Problems</b>  |   |  |
| The built-in display is blank when you turn on your LifeBook Tablet PC.                                      | Display angle and brightness settings are not adequate for your lighting conditions.                      | Move the display and the brightness control until you have adequate visibility. Pressing either the [F6] or [F7] keys while holding down the [Fn] key also allows you to change the brightness level of the display.           |
|  | Power management timeouts are set for short intervals and you didn't see the display go on and off again. | Press a keyboard button or move the mouse to restore operation. If that fails, push the Power/Suspend/Resume button. (The display may be shut off by Sleep mode, Auto Suspend or Video Timeout)                                |

| Problem  | Possible Cause   | Possible Solutions  |
|--|--|---|
| The built-in display is blank when you turn on your LifeBook Tablet PC.<br>(continued) | The Tablet PC is set for an external monitor only.   | Pressing [F10] while holding down the [Fn] key allows you to change your selection of where to send your display video. Each time you press the keys you will step to the next choice. The choices, in order are: built-in display only, external monitor only, both built-in display and external monitor.   |
| The Tablet PC turned on with a series of beeps and the built-in display is blank.      | Power On Self Test (POST) has detected a failure which does not allow the display to operate.                                    | Contact your support representative.  |
| The display goes blank by itself after you have been using it.                         | The Tablet PC has gone into Video timeout, Sleep mode, or Save-to-Disk mode because you have not used it for a period of time.   | Press any button on the keyboard, or move the mouse to restore operation. If that fails, push the Power/Suspend/Resume button. Check your power management settings, or close your applications and go to the Power Savings menu of the setup utility to adjust the timeout values to better suit your operation needs. <i>See "BIOS Setup Utility" on page 71.</i> |
|  | The power management timeouts may be set for very short intervals and you failed to notice the display come on and go off again. | Press any button on the keyboard, or move the mouse to restore operation. If that fails, push the Power/Suspend/Resume button. (The display may be shut off by Sleep Mode, Auto Suspend or Video Timeout)   |
| Your display won't turn on when the system is turned on or when it has resumed.        | The system may be password-protected.  | Check the status indicator panel to verify that the Security icon is blinking. If it is blinking, enter your password.  |
| The display does not close.  | A foreign object, such as a paper clip, is stuck between the display and keyboard.   | Remove all foreign objects from the keyboard.   |

| <b>Problem</b>   | <b>Possible Cause</b>   | <b>Possible Solutions</b>  |
|--|---|--|
| The display has bright or dark spots.  | If the spots are very tiny and few in number, this is normal for a large LCD display. | This is normal; do nothing.  |
|  | If the spots are numerous or large enough to interfere with your operation needs.     | Display is faulty; contact your support representative.  |
| The Display is dark when on battery power.                                       | The Power Management utility default is set on low brightness to conserve power.      | Press [Fn] + [F7] to increase brightness or click the battery gauge, click on <b>More power options</b> , and select <b>Adjust the display brightness</b> .  |
| You have connected an external monitor and it does not display any information.  | Your BIOS setup is not set to enable your external monitor.                           | Toggle the video destination by pressing [Fn]+ [F10] together, or check your BIOS setup and enable your external monitor. (See the Video Features submenu, located within the Advanced Menu of the BIOS. See “ <i>BIOS Setup Utility</i> ” on page 71. |
|  | Your external monitor is not properly installed.                                      | Reinstall your device. See “ <i>External Video Port</i> ” on page 102.   |
|  | Your operating system is not setup with the correct software driver for that device.  | Check your device and operating system documentation and activate the proper driver.   |
| You have connected an external monitor and it does not come on.                  | Your external monitor is not compatible with your LifeBook Tablet PC.                 | See your monitor documentation and the External Monitor Support portions of the Specifications section. See “ <i>Specifications</i> ” on page 134.   |
| <b>Miscellaneous Problems</b>  |   |  |
| Error message is displayed on the screen during the operation of an application. | Application software often has its own set of error message displays.                 | See your application manual and help displays screens for more information. Not all messages are errors some may simply be status.   |

## **Power On Self Test Messages**

The following is an alphabetic list of error-and-status messages that Phoenix BIOS and/or your operating system can generate and an explanation of each message. Error messages are marked with an \*. If an error message is displayed that is not in this list, write it down and check your operating system documentation both on screen and in the manual. If you can find no reference to the message and its meaning is not clear, contact your support representative for assistance.

### **nnnn Memory Cache Passed**

Where nnnn is the amount of system cache in kilobytes successfully tested by the Power On Self Test. (This can only appear if you have an SRAM card installed.)

### **\*Extended Memory Failed at address line: xx**

Extended memory not working or not configured properly. If you have installed a memory upgrade module, verify that it is properly installed. If it is properly installed, check your Windows Setup to be sure it is not using unavailable memory until you can contact your support representative.

### **nnnn Extended RAM Passed**

Where nnnn is the amount of memory in kilobytes successfully tested.

### **\*Failure Fixed Disk n (where x=1-4)**

The fixed disk is not working or not configured properly. This may mean that the hard drive type identified in your setup utility does not agree with the type detected by the Power On Self Test. Run the setup utility to check for the hard drive type settings and correct them if necessary. If the settings are OK and the message appears when you restart the system, there may be a serious fault which might cause you to lose data if you continue. Contact your support representative.

### **\*Incorrect Drive A type – run SETUP**

Type of floppy drive A: not correctly identified in Setup. This means that the floppy disk drive type identified in your setup utility does not agree with the type detected by the Power On Self Test. Run the setup utility to correct the inconsistency.

**\*Incorrect Drive B type – run SETUP**

Type of floppy drive B: not correctly identified in Setup. This means that the floppy disk drive type identified in your setup utility does not agree with the type detected by the Power On Self Test. Run the setup utility to correct the inconsistency.

**\*Invalid NVRAM Data**

Problem with NVRAM access. In the unlikely case that you see this message you may have some display problems. You can continue operating but should contact your support representative for more information.

**\*Keyboard controller error**

The keyboard controller test failed. You may have to replace your keyboard or keyboard controller but may be able to use an external keyboard until then. Contact your support representative.

**\*Keyboard error**

Keyboard not working. You may have to replace your keyboard or keyboard controller but may be able to use an external keyboard until then. Contact your support representative.

**\*Stuck Key**

BIOS discovered a stuck key and displays the scan code for the stuck key. You may have to replace your keyboard but may be able to use an external keyboard until then. Contact your support representative.

**\*Monitor type does not match CMOS – Run SETUP**

Monitor type not correctly identified in Setup. This error probably means your BIOS is corrupted, run the setup utility and set all settings to the default conditions. If you still get this error, contact your support representative.

**\*Operating system not found**

Operating system cannot be located on either drive A: or drive C: Enter the setup utility and see if both the fixed disk, and drive A: are properly identified and that the boot sequence is set correctly. Unless you have changed your installation greatly, the operating system should be on drive C:. If the setup utility is correctly set, your hard drive may be corrupted.

**\*Parity Check 1 nnnn**

Parity error found in the system bus. BIOS attempts to locate the address and display it on the screen. If it cannot locate the address, it displays ????. This is a potentially data destroying failure. Contact your support representative.

**\*Parity Check 2 nnnn**

Parity error found in the I/O bus. BIOS attempts to locate the address and display it on the screen. If it cannot locate the address, it displays ????. This is a potentially data-destroying failure. Contact your support representative.

**\*Press <F1> to resume, <F2> to SETUP**

Displayed after any recoverable error message. Press the [F1] key to continue the boot process or the [F2] key to enter Setup and change any settings.

**\*Previous boot incomplete – Default configuration used**

Previous Power On Self Test did not complete successfully. The Power On Self Test will load default values and offer to run Setup. If the previous failure was caused by incorrect values and they are not corrected, the next boot will likely fail also. If using the default settings does not allow you to complete a successful boot sequence, you should turn off the power and contact your support representative.

**\*Real time clock error**

Real-time clock fails BIOS test. May require board repair. Contact your support representative.

**\*Shadow RAM Failed at offset: nnnn**

Shadow RAM failed at offset nnnn of the 64k block at which the error was detected. You are risking data corruption if you continue. Contact your support representative.

**nnnn Shadow RAM Passed**

Where nnnn is the amount of shadow RAM in kilobytes successfully tested.

**\*System battery is dead – Replace and run SETUP**

The BIOS CMOS RAM memory hold up battery is dead. This is part of your BIOS and is a board mounted battery which requires a support representative to change. You can continue operating but you will have to use setup utility default values or reconfigure your setup utility every time you turn off your Tablet PC. This battery has an expected life of 2 to 3 years.

**System BIOS shadowed**

System BIOS copied to shadow RAM.

**\*System CMOS checksum bad – Default Configuration Used**

BIOS CMOS RAM has been corrupted or modified incorrectly, perhaps by an application program that changes data stored in BIOS memory. Run Setup and reconfigure the system.

**\*System RAM Failed at offset: nnnn**

System memory failed at offset nnnn of in the 64k block at which the error was detected. This means that there is a fault in your built-in memory. If you continue to operate, you risk corrupting your data. Contact your support representative for repairs.

**nnnn System Memory Passed**

Where nnnn is the amount of system memory in kilobytes successfully tested.

**\*System timer error**

The timer test failed. The main clock that operates the computer is faulty. Requires repair of system board. Contact your support representative for repairs.

**Video BIOS shadowed**

Video BIOS successfully copied to shadow RAM.

.

## Restoring Your Pre-installed Software

The location of your applications, drivers, and utilities is determined by the operating system you are running.

**Microsoft Windows 7 Professional:** Please use the information contained in the “Saving and Recovering Your Factory and System Images” booklet that was packed with your system.

**Microsoft Windows XP Edition:** Please use the following instructions.

The Drivers and Applications Restore (DAR) CD contains sets of device drivers and Fujitsu utilities (in specific directories) that are unique to your computer configuration for use as documented below.



IF YOU HAVE ACCESS TO THE INTERNET, VISIT THE FUJITSU SUPPORT WEBSITE AT [HTTP://WWW.COMPUTERS.US.FUJITSU.COM/SUPPORT](http://www.computers.us.fujitsu.com/support) TO CHECK FOR THE MOST CURRENT INFORMATION, DRIVERS AND HINTS ON HOW TO PERFORM RECOVERY AND SYSTEM UPDATES.

### Re-installing Individual Drivers and Applications

The Drivers and Applications CD can be used to selectively re-install drivers and/or applications that may have been un-installed or corrupted.



THERE MAY BE CERTAIN FREE THIRD-PARTY APPLICATIONS PRE-INSTALLED ON YOUR SYSTEM THAT ARE NOT ON THE DAR CD. THE LATEST VERSIONS OF THE APPLICATIONS CAN BE DOWNLOADED FROM THE THIRD-PARTY'S WEBSITE.

To re-install drivers and/or applications:

- 1** Boot up the system and insert the DAR CD after Windows has started. A Fujitsu Installer screen is displayed after the CD is inserted.
- 2** After reading the License Agreement, click [I agree].



- 3 A window will appear containing a list of applications, drivers, and utilities that you can install from the Drivers and Applications CD.



THE COMPONENTS LISTED ARE COLOR-CODED IN TERMS OF THEIR INSTALL STATUS. BLUE INDICATES THAT THE COMPONENT CAN BE INSTALLED. GREEN INDICATES THAT THE COMPONENT NEEDS TO BE INSTALLED SEPARATELY. GREY INDICATES A COMPONENT THAT IS ALREADY INSTALLED; GREY ITEMS CAN BE REINSTALLED, BUT PRIOR TO INSTALLATION YOU WILL RECEIVE A REMINDER THAT THE COMPONENT IS ALREADY INSTALLED.

- 4 In the list, check off all the components you want to install. If you want to install all components, click [Select All]. Clicking [Select All] will select all of the blue-coded components; you must select grey and green components separately.
- 5 Once you have selected the components you wish to install, click [Install Selected Subsystems]; the components will be installed.
- 6 After the components are installed, click [OK], then click [Yes] when asked if you want to reboot the system.

## Restoring the Operating System for Windows

The Recovery and Utility disc contains four utilities:

- The **Recovery** utility allows you to restore the system operating system (OS). The restored OS is the same one that was originally installed on the hard disk drive. After the OS is restored, you will need to reinstall the drivers and applications from the Drivers and Applications Restore disc and from any application discs that were bundled with the system when you purchased it.
- The **Hard Disk Data Delete** utility on this disc is used to delete all data on your hard disk and prevent it from being reused. Do not use the Hard Disk Data Delete utility unless you are absolutely certain that you want to erase your entire hard disk, including all partitions.
- The **Partition Creation** utility allows you to create a new D: partition or resize existing partitions on your hard disk. **NOTE: Creating or resizing partitions with this utility will cause all data on the hard disk to be completely erased.**
- The **Diagnostics** utility allows the IT professional to determine device status/condition by executing diagnostics tests on selected system components.

## Methods for accessing the utilities

Certain LifeBook models have the Recovery and Utility applets pre-installed. Other systems require that the Recovery and Utility disc be used (or in the event the hard disk has been reformatted).

In order to determine the method for accessing the Recovery and Utility applet, perform the following procedures in order.

### Determining whether Recovery and Utility is pre-loaded

- 1 Turn on or reboot your system. When the Fujitsu logo appears, press [F12] key.
- 2 From the Boot Menu that appears, check whether the <Recovery and Utility> option is present. If it is not present, it means that the utility must be used from the disc. Proceed to “Running Recovery and Utility from the disc” if <Recovery and Utility> is unavailable.
- 3 You can also use the TrustedCore menu to determine whether the utility is pre-loaded by powering on your system then pressing the {Enter} key when the Fujitsu logo appears on the screen. The TrustedCore Menu will appear and the Recovery and Utility option will appear in the menu.

### Running Recovery and Utility from hard disk

- 1 Cursor down to <Recovery and Utility> and press the [Enter] key.
- 2 While the files are being loaded from the disc, a progress bar will appear at the bottom of the screen.
- 3 When the System Recovery Options dialog opens, select a new keyboard layout, if necessary, then click [Next].
- 4 When the Operating System dialog appears, click [Next].
- 5 If necessary, enter your password, then click [OK].
- 6 When System Recovery Options window appears, click on Recovery and Utility.
- 7 The Recovery and Utility screen appears on the screen with three tabs: Diagnostics, Recovery and Utility. Please note that Diagnostics tab is not supported on certain LifeBook/Stylistic models when running Recovery and Utility from the hard disk. In order to restore the operating system, please insert the “Recovery and Utility” disc in the CD/DVD drive and use the Start Recovery function under the Recovery tab. For more information about the tabs, go to “Recovery and Utility tabs” on page 123.

## Running Recovery and Utility from the disc



- THE USE OF THIS DISC REQUIRES THAT YOU HAVE A DEVICE CAPABLE OF READING CDS ATTACHED TO YOUR SYSTEM. YOU WILL NEED TO ATTACH AN EXTERNAL PLAYER. FOR MORE INFORMATION ON AVAILABLE EXTERNAL DEVICES, VISIT OUR WEB SITE AT: [HTTP://SOLUTIONS.US.FUJITSU.COM/](http://solutions.us.fujitsu.com/).
- THIS DISC CAN ONLY BE USED WITH THE SYSTEM WITH WHICH IT WAS PURCHASED.

### Procedure

To verify/change the boot-up priority (rather than booting-up from the hard drive or an external floppy disk drive), perform the following steps:

- 1** Power on your system. When the Fujitsu logo appears on the screen. press the [Enter] key or click on the left mouse or touchpad button; the TrustedCore Menu will appear.
- 2** Select the **Boot Menu** from the TrustedCore Menu.
- 3** Highlight the **CD/DVD** option.
- 4** Insert the Recovery and Utility Disc into the drive tray.
- 5** Click [OK]. While the files are being loaded from the disc, a progress bar will appear at the bottom of the screen.
- 6** When the Recovery and Utility screen appears, three tabs will be present: Diagnostics, Recovery, and Utility.

### Recovery and Utility tabs

**Diagnostics tab:** The Diagnostics tool is designed for use by IT professionals. It is not likely you will need to use this tool. When you select devices from the Diagnosis window then click [Execute], several tests are performed on the selected components.

**Recovery tab:** The Recovery tab contains the Start Recovery tool. Note that the recovery process erases all data from the C: drive. If you decide to use the recovery tool, be sure to back up all data that you don't want to lose. Also note that you must run the system using your AC adapter while running the recovery tool. To use the Recovery tool, select the Start Recovery function, click on the [Execute] button, then follow the instructions on the screen.

**Utility tab:** The Utility tab contains three tools: System Restore, Hard Disk Data Delete and Partition Creation.

- **System Restore** can help fix problems that might be making your computer run slowly or stop responding. System Restore enables you in rolling back the system to an earlier restore point, and does not affect any of your documents, pictures, or other personal data.
- The **Hard Disk Data Delete** utility is used to delete all data on the hard disk and prevent the data from being reused. **NOTE: Do not use the Hard Disk Data Delete utility unless you are absolutely certain that you want to erase your entire hard disk, including all partitions.**
- The **Partition Creation** utility allows you to create a D: partition or resize existing partitions on your hard disk. **NOTE: Creating or resizing partitions with this utility will cause all data on the hard disk to be completely erased.**

### **Automatically Downloading Driver Updates**

Your system has a convenient tool called the Fujitsu Driver Update (FDU) utility. With FDU, you can choose to automatically or manually go to the Fujitsu site to check for new updates for your system.

The FDU icon should appear in the system tray at the bottom right of your screen (roll the cursor over the icons to find the correct one). If the icon does not appear in the system tray, go to [Start] -> All Programs, and click on Fujitsu Driver Update; this will create the icon automatically.

To invoke the FDU menu, you can either right-click on the FDU icon or hold the pen on the icon for a couple of seconds until the menu appears. The menu contains the following items:

#### **Check for updates now**

Allows for manual driver update search. The first time it is used, you are prompted to agree to a user agreement. After clicking on the icon, the FDU automatically connects with the Fujitsu site to check for updates and downloads them. While downloading, the icon has a red bar through it, indicating that it cannot be used while the download is in process. When the update is complete, a message appears informing you of the fact.

**Enable Automatic Update Notifications**

Automatically searches for new updates on a regular basis (approximately every 3 days).

**Show update history**

Brings up a screen that displays a history of updates that have been made via the FDU.

**About Fujitsu Driver Update**

Displays the FDU version number and copyright information

**Fujitsu Driver Update Readme**

Displays the FDU readme.

## Chapter 5

# Care and Maintenance

---

### Caring for your LifeBook Tablet PC

If you use your Fujitsu LifeBook Tablet PC carefully, you will increase its life and reliability. This section provides some tips for looking after the Tablet PC and its devices.

THE SYSTEM CONTAINS COMPONENTS THAT CAN BE SEVERELY DAMAGED BY ELECTROSTATIC DISCHARGE (ESD). TO MINIMIZE RISK TO THE COMPONENTS, OBSERVE THE FOLLOWING PRECAUTIONS:



- BEFORE DOCKING OR UNDOCKING YOUR LIFEBOOK TABLET PC (WHEN USING A PORT REPLICATOR), IT IS A GOOD PRACTICE TO ALWAYS TOUCH A GROUNDED METAL OBJECT TO DISCHARGE STATIC ELECTRICITY BUILT UP IN YOUR BODY.
- BE SURE TO POWER DOWN YOUR SYSTEM BEFORE ADDING OR REMOVING SYSTEM COMPONENTS. EVEN IF THE SYSTEM IS IN HIBERNATE OR SLEEP STATES, DATA COULD BE LOST OR MEMORY COULD BE DAMAGED IF POWER IS STILL AVAILABLE TO THE SYSTEM.
- WHEN INSTALLING OR REMOVING A MEMORY MODULE, HOLD IT BY THE EDGE SO AS NOT TO TOUCH ANY CONTACTS OR CHIPS. BE CAREFUL NOT TO TOUCH ANY INTERNAL COMPUTER TERMINALS OR COMPONENTS; THE OIL FROM YOUR FINGERS COULD CAUSE A SHORT TO THE COMPONENTS.
- ELECTRICAL EQUIPMENT MAY BE HAZARDOUS IF MISUSED. OPERATIONS OF THIS PRODUCT OR SIMILAR PRODUCTS, MUST ALWAYS BE SUPERVISED BY AN ADULT. DO NOT ALLOW CHILDREN ACCESS TO THE INTERIOR OF ANY ELECTRICAL PRODUCTS AND DO NOT PERMIT THEM TO HANDLE ANY CABLES.

- Your LifeBook Tablet PC is a durable but sensitive electronic device. Treat it with respect and care.
- Make a habit of transporting it in a suitable carrying case.
- Do not attempt to service the computer yourself. Always follow installation instructions closely.
- Keep it away from food and beverages.
- To protect your Tablet PC from damage and to optimize system performance, be sure to **keep all air vents unobstructed, clean, and clear of debris**. This may require periodic cleaning, depending upon the environment in which the system is used.
- Do not operate the Tablet PC in areas where the air vents can be obstructed, such as in tight enclosures or on soft surfaces like a bed or cushion.
- If you accidentally spill liquid on your LifeBook Tablet PC:
  - 1 Turn it off.
  - 2 Position it so that the liquid can run out.
  - 3 Let it dry out for 24 hours, or longer if needed.
  - 4 If your Tablet PC will not boot after it has dried out, call your support representative.
- Do not use your Fujitsu LifeBook Tablet PC in a wet environment (near a bathtub, swimming pool).
- Always use the AC adapter and batteries that are approved for your Tablet PC.
- Avoid exposure to sand, dust and other environmental hazards.
- Do not expose your Tablet PC to direct sunlight for long periods of time as temperatures above 140° F (60° C) may damage your Tablet PC.
- Keep the covers closed on the connectors and slots when they are not in use.
- Do not put heavy or sharp objects on the computer.
- If you are carrying your LifeBook Tablet PC in a briefcase, or any other carrying case, make sure that there are no objects in the case pressing on the lid.
- Never position your Tablet PC such that the optical drive is supporting the weight of the Tablet PC.

## Cleaning your LifeBook Tablet PC

- Always disconnect the power plug. (Pull the plug, not the cord.)
- Clean your LifeBook Tablet PC with a damp, lint-free cloth. Do not use abrasives or solvents.
- Use a soft cloth to remove dust from the screen. Never use glass cleaners.
- Always shut down the computer, unplug the power adapter, and remove the battery when cleaning or disinfecting the computer exterior, keyboard or LCD display.

NOTE: Avoid wetting the thermal suede in all cases.

## Cleaning guidelines using recommended off-the-shelf cleaners

### Computer exterior, computer keyboard

To clean the exterior and keyboard, use one of the following off-the-shelf products:

- Office Depot® #154-616 Notebook Cleaning Kit
- Meridrew Enterprises Klear Screen® Wipes
- 3M CL563 Cleaner Wipes

Note: After cleaning with one of these products, gently polish with a dry, soft, lint-free cloth until the solution is no longer visible.

### Disinfecting LifeBook computers

Wipe the surface with a soft cloth wipe and a 50% ethanol solution or use another ethanol-based germicide which has been registered as a hospital disinfectant by the EPA.



- USE OF INCORRECT CLEANERS CAN RESULT IN OPTICAL IMPAIRMENT OF THE LCD AND/OR DAMAGE TO THE COMPUTER. ALWAYS REFER TO THE CLEANER MANUFACTURER'S GUIDELINES AND MATERIAL SAFETY DATA SHEETS FOR PROPER HANDLING AND USE OF THE PRODUCTS.
- NEVER USE AMMONIA, ACIDIC, OR ALKALINE CLEANERS OR ORGANIC CHEMICALS SUCH AS PAINT THINNER, ACETONE, PROPYL OR ISOPROPYL ALCOHOL, OR KEROSENE. IT MAY DAMAGE SURFACE FINISHES AND THE COATING OF THE LCD SCREEN.
- NEVER USE COMPRESSED AIR FOR CLEANING STYLISTIC AND LIFEBOOK PCs.



## Cleaning the dust filter

Your LifeBook is equipped with fans to make air flow inside by pulling in outside air to cool the inside of the system. Depending on the environment in which the system is used, dust and dirt may be pulled in along with the air. Accumulated dust and dirt could impair the function of the system.



- **REMOVE AC ADAPTER:** BEFORE REMOVING THE FILTER, TURN OFF THE SYSTEM AND PERIPHERALS AND DISCONNECT THE AC ADAPTER.
- **CLEANING THE FILTER:**
  - DO NOT USE DETERGENT
  - AVOID DAMAGING THE FILTER; DAMAGE TO THE FILTER IS NOT COVERED BY WARRANTY.
  - USE PLASTIC TOOLS TO CLEAN THE FILTER. METAL OR WOODEN TOOLS COULD DAMAGE THE FILTER.
- **ESD:** BEFORE CLEANING THE FILTER, TOUCH A METAL OBJECT TO DISCHARGE STATIC ELECTRICITY.
- ALWAYS BE SURE THE DUST FILTER IS INSTALLED WHEN RUNNING YOUR SYSTEM. NOT USING THE FILTER COULD CAUSE CONTAMINATION AND POSSIBLE DAMAGE TO THE SYSTEM.

- 1 Turn off your computer and disconnect the AC adapter.
- 2 Close the display panel and turn the system upside down.
- 3 Remove the dust filter by pressing the latch towards the filter and lifting it out (Figure 47).
- 4 Carefully clean the dust filter and the air-cooling duct.
- 5 Put back the dust filter by inserting the end without latch first and pushing in the filter until it latches.

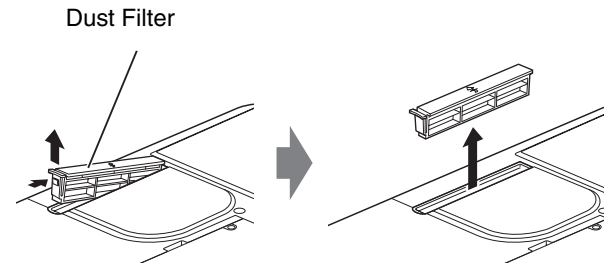

Figure 47. Removing the dust filter

## Storing your LifeBook Tablet PC

- If storing your Tablet PC for a month or longer, turn your LifeBook Tablet PC off, fully charge the battery, then remove and store all Lithium ion batteries.
- Store your Fujitsu LifeBook in a cool, dry location. Temperatures should remain between 13°F (-25°C) and 140°F (60°C).

- Store your Tablet PC and batteries separately. If you store your LifeBook with a battery installed, the battery will discharge, and battery life will be reduced. In addition, a faulty battery might damage your LifeBook.







- ALWAYS POWER OFF THE COMPUTER BEFORE TRANSPORTING AND/OR PACKAGING IT. AFTER SHUTTING DOWN THE SYSTEM, WAIT UNTIL THE STATUS LED PANEL INDICATES POWER OFF CONDITION (I.E., NO LIGHTS ARE ILLUMINATED).
- IT IS POSSIBLE THAT THE UNIT MAY NOT AUTOMATICALLY GO TO POWER OFF OR HIBERNATE MODE WHEN YOU CLOSE THE LID. THIS SITUATION MAY OCCUR DUE TO PRE-OS BOOT PASSWORD SECURITY SETTINGS OR SOME OTHER APPLICATION RUNNING ON THE COMPUTER.
- ATTEMPTING TO TRANSPORT THE COMPUTER WHILE POWER IS ON MAY DAMAGE THE TABLET PC DUE TO SHOCK OR OVERHEATING SINCE THE AIR VENTS MAY BE BLOCKED OR RESTRICTED.

### **Traveling with your LifeBook Tablet PC**

- Do not transport your Tablet PC while it is turned on.
- It is recommended that you carry your Tablet PC with you while traveling, rather than checking it in as baggage.
- Always bring your System Recovery CD that came with your Tablet PC when you travel. If you experience system software problems while traveling, you may need it to correct any problems.
- Never put your Tablet PC through a metal detector. Have your Tablet PC hand-inspected by security personnel. You can however, put your Tablet PC through a properly tuned X-ray machine. To avoid problems, place your Tablet PC close to the entrance of the machine and remove it as soon as possible or have your Tablet PC hand-inspected by security personnel. Security officials may require you to turn your Tablet PC on, so make sure you have a charged battery on hand.

- Take the necessary plug adapters if you're traveling overseas. Check the following diagram to determine which plug adapter you'll need or ask your travel agent.

| Outlet Type  | Location  | Outlet Type   | Location  |
|--|---|---|---|
| <br> | United States, Canada, parts of Latin America, Mexico, Japan, Korea, the Philippines, Taiwan  |  | United Kingdom, Ireland, Malaysia, Singapore, parts of Africa |
|   | Russia and the Commonwealth of Independent States (CIS), most of Europe, parts of Latin America, the Middle East, parts of Africa, Hong Kong, India, most of South Asia |  | China, Australia, New Zealand                                 |

## Batteries

### Caring for your Batteries

- Always handle batteries carefully.
- Do not short-circuit the battery terminals (that is, do not touch both terminals with a metal object). Do not carry loose batteries in a pocket or purse where they may mix with coins, keys, or other metal objects. Doing so may cause an explosion or fire.
- Do not drop, puncture, disassemble, mutilate or incinerate the battery.
- Recharge batteries only as described in this manual and only in ventilated areas.
- Do not leave batteries in hot locations for more than a day or two. Intense heat can shorten the life of your battery.
- Do not leave a battery in storage for longer than 6 months without recharging it.

## **Increasing Battery Life**

- Power your Tablet PC through the AC or optional auto/airline adapter whenever possible.
- If your tablet runs on battery power all day, connect it to an AC adapter overnight to recharge it.
- Keep brightness to the lowest level comfortable.
- Set the power management for maximum battery life.
- Put your Tablet PC in Sleep mode when it is turned on and you are not actually using it.
- Limit your media drive access.
- Disable the Media Player auto insert notification function.
- Eject ExpressCards when not in use.

## **Media Care**

### **Caring for your Media (DVD/CD/CD-R)**

Media discs are precision devices and will function reliably if given reasonable care.

- Always store your media disc in its case when it is not in use.
- Always handle discs by the edges and avoid touching the surface.
- Avoid storing any media discs in extreme temperatures.
- Do not bend or scratch media discs or set heavy objects on them.
- Do not spill liquids on media discs.
- Do not get dust on media discs.
- Never write on the label surface with a ballpoint pen or pencil. Always use a felt pen.
- If a disc is subjected to a sudden change in temperature, condensation may form on the surface. Wipe moisture off with a soft, lint free cloth and let it dry at room temperature. DO NOT use a hair dryer or heater to dry media discs.
- If a disc is dirty, use only a DVD/CD cleaner or wipe it with a clean, soft, lint free cloth starting from the inner edge and wiping to the outer edge.

### **Caring for your Optical Drive**

Your optical drive is durable but you must treat it with care. Please pay attention to the following points:

- The drive rotates the compact disc at a very high speed. Do not carry it around or subject it to shock or vibration with the power on.
- Avoid using or storing the drive where it will be exposed to extreme temperatures.
- Avoid using or storing the drive where it is damp or dusty.
- Avoid using or storing the drive near magnets or devices that generate strong magnetic fields.
- Avoid using or storing the drive where it will be subjected to shock or vibration.
- Do not disassemble or dismantle the optical drive.
- Use of a commercially available lens cleaner is recommended for maintenance of your drive.

### **Express Cards**

#### **Caring for your Cards**

Express Cards are durable, but you must treat them with care. The documentation supplied with your card will provide specific information, but you should pay attention to the following points:

- To keep out dust and dirt, store cards in their protective sleeves when they are not installed in your LifeBook Tablet PC.
- Avoid prolonged exposure to direct sunlight or excessive heat.
- Keep the cards dry.
- Do not flex or bend the cards, and do not place heavy objects on top of them.
- Do not force cards into the slot.
- Avoid dropping cards, or subjecting them to excessive vibration.

## Chapter 6

# System Specifications

### Specifications

This section provides the hardware and environmental specifications for your Fujitsu LifeBook Tablet PC. Specifications of particular configurations will vary.

#### Configuration Label

The configuration label located on the bottom of your Tablet PC contains specific information regarding the options you've chosen for your Tablet PC. Following is an example configuration label.

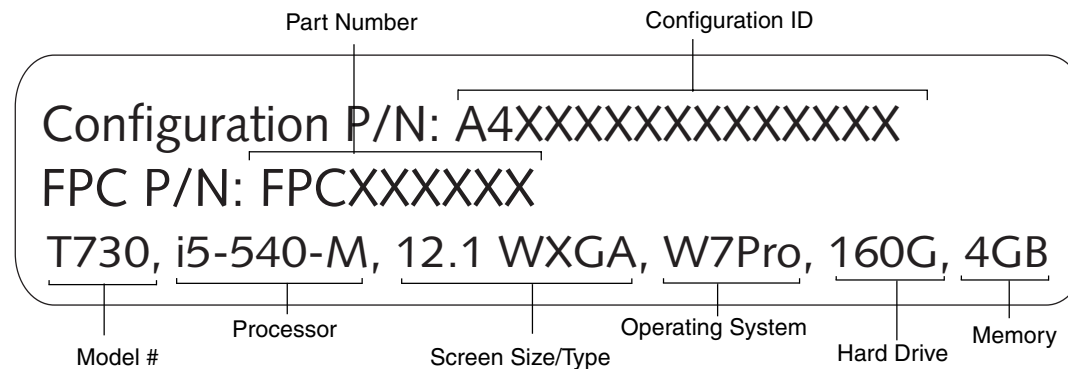

## **Microprocessor**

New 2010 Intel® Core™ Processor (Refer to the system label to determine the speed of your processor).

## **Chipset**

- Mobile Intel® QM57 Express
- Platform Control Hub (PCH)

## **Memory**

### **System Memory**

- DDR3-1066 MHz SDRAM dual-channel memory module.
- Two DIMM slots; upgradeable to 8 GB of total memory (4 GB x 2).

### **Cache Memory**

Up to 4MB L3 cache on-die (depending upon CPU)

## **Video**

Built-in color flat-panel TFT active matrix LED backlit display with simultaneous display capability.

### **Video Color and Resolution**

#### **12.1" Wide XGA display**

- Internal: 1280 x 800 pixel resolution, 16M colors
- External: 1920 x 1200 pixel resolution, 16M colors
- Simultaneous: 1280 x 800, 16M colors

### **Video RAM**

Intel(R) HD Graphics with dynamic frequency. Automatically distributes performance to CPU and graphics applications that need an extra boost up to approximately 20%.

## Digitizer

Depending upon the configuration of your system, one of two digitizer options is included:

- Active digitizer (uses active stylus input), or,
- Dual Digitizer, consisting of active digitizer and capacitive touch panel (uses active stylus input and two finger touch input).

## Audio

- Realtek codec ALC269 with High Definition (HD) audio.
- **Headphones:** Stereo headphone jack, 3.5 mm, 1 V<sub>rms</sub> or less, minimum impedance 32 Ohms
- **Microphone:** Stereo microphone jack, 3.5 mm, 100 mV<sub>p-p</sub> or less, minimum impedance 10K Ohms
- Two built-in speakers, 25 mm x 16 mm, 0.6 W
- Two built-in digital microphones

## Mass Storage Device Options

### Hard Drive

Serial ATA, 2.5", 9.5 mm, shock-mounted with Shock Sensor utility. Capacity and speed of the hard drive are determined by system configuration.

### Modular Bay Devices

One of the following devices is pre-installed:

- Dual-Layer Multi-Format DVD Writer: 24x CD-ROM, 24x CD-R, 10x CD-RW, 8x DVD-ROM, 5x DVD-RAM, 8x DVD+/-R, 4x DVD+/-R(DL), 6x DVD-RW, 8x DVD+RW
- Modular Bay Battery
- Weight Saver



## Features

### Integrated Pointing Device

Touchpad cursor control buttons, with scroll strip built-in

### Communications

- **Gigabit LAN:** Intel 82577LM 10/100/1000 Gigabit Ethernet LAN
- **WLAN:** Optional integrated Intel Centrino Advanced-N 6200 (a/b/g/n, 2 x 2) or Atheros XSPAN 802.11bgn
- **Bluetooth:** Optional Bluetooth V2.1 device for wireless personal area network communication

### Web Camera

Optional built-in 2.0 megapixel web camera.

### Security

**Trusted Platform Module:** The LifeBook T730 has a Trusted Platform Module (TPM) installed for added system security.

**Theft Prevention Lock:** Lock slot for use with security restraint systems.

**Fingerprint Reader:** The fingerprint sensor uses biometric readings to ensure that only a person with a registered fingerprint can access the system.

**iAMT Support (using Intel® vPro™ technology):** Intel vPro technology is a set of features that work together to allow for remote wired or wireless access of a computer. This technology can be used whether or not the computer is running, and enhances the administrator's ability to maintain the system, enhance security, and increase the cost benefits by allowing off-site service

## Device Ports

### On the LifeBook Tablet PC:

- Express Card slot for one Express Card
- Memory Stick/SD Card slot
- One 15-pin D-SUB connector for VGA external monitor (see Display specifications)
- Three USB 2.0 (Universal Serial Bus) connectors for input/output devices
- One DC In connector
- One IEEE 1394 (4-pin type) jack
- One LAN (RJ-45) connector
- One HDMI port
- Docking port (100-pin, to dock with port replicator)
- One stereo headphone jack
- One stereo microphone/line-in jack

### On the Optional Port Replicator:

- One 15-pin D-SUB connector for VGA external monitor
- Four USB 2.0 connectors for input/output devices
- One LAN (RJ-45) connector
- One DC-in connector
- One DVI-D connector
- One Line-Out connector

## Keyboard

Built-in keyboard with all functions of 101 key PS/2 compatible keyboards.

- Total number of keys: 84
- Function keys: F1 through F12, plus Fn extension key
- Two Windows keys: one Start key, one application key
- Key pitch: 19 mm; key stroke: 3.0 mm
- Built-in Touchpad pointing device with two left and two right buttons and scroll strip.
- Built-in Palm Rest
- Spill-resistant
- External USB keyboard/mouse support

## Power

### Battery

- Standard Lithium ion battery, rechargeable, 6-cell, 10.8V, 5200 mAh
- TBD - Optional Lithium ion battery, rechargeable, 6-cell, 10.8V, 5800 mAh
- Optional Lithium ion bay battery, rechargeable, 6-cell 10.8V, 3800 mAh

### AC Adapter

Autosensing 100-240V AC, supplying 19V DC, 4.22A, 80W to the LifeBook; includes an AC cable

### Power Management

Conforms to ACPI (Advanced Configuration and Power Interface).

## **Dimensions and Weight**

### **Overall Dimensions**

11.69"(w) x 9.17"(d) x 1.49"(h) (297 mm x 233 mm x 37.9 mm)

### **Weight**

Wide-view display, active digitizer with weight saver - 3.92 lbs. (1.78 kg)

Wide-view display, active digitizer with optical drive: 4.3 lbs. (1.95 kg)

Standard display, dual-digitizer with optical drive: 4.54 lbs. (2.06 kg)

## **Environmental Requirements**

### **Temperature**

Operating: 41° to 95° F (5° to 35° C). Non-operating: 5° to 140° F (-15° to 60° C)

### **Humidity**

Operating: 20% to 85%, relative, non-condensing. Non-operating: 8% to 85%, relative, non-condensing

### **Altitude**

Operating: 10,000 feet (3,048 m) maximum

## **Popular Accessories**

For ordering or additional information on Fujitsu accessories please visit our Web site at [www.shopfujitsu.com](http://www.shopfujitsu.com) or call 1-800-FUJITSU.

## Pre-Installed Software

Depending on your pre-installed operating system, your Tablet PC comes with pre-installed software for playing audio and video files of various formats. In addition there is file transfer software and virus protection software.



THE FOLLOWING LIST CONSTITUTES THE SOFTWARE THAT MAY BE INSTALLED ON YOUR COMPUTER. THE PRE-INSTALLED SOFTWARE MAY VARY, AND IS DETERMINED BY YOUR OPERATING SYSTEM AND CONFIGURATION.

- Adobe Reader
- Norton Internet Security™ (60-day free trial)
- CyberLink PowerDirector
- CyberLink PowerDVD
- CyberLink MakeDisc (Windows 7 models only)
- CyberLink YouCam
- Google Picasa (Windows XP models only)
- Google Toolbar (Windows XP models only)
- Roxio Creator
- OmniPass Fingerprint application
- Fujitsu Driver Update utility
- Microsoft Office Ready SP1 2007
- Microsoft Office Activation Assistant
- Microsoft Touch Pack
- Microsoft Windows Live Mail
- Microsoft Office OneNote 2007

## **Learning About Your Software**

### **Tutorials**

All operating systems and most application software have tutorials built into them upon installation. We highly recommend that you step through the tutorial before you use an application.

### **Manuals**

Included with your Tablet PC you will find manuals for your installed operating system and other pre-installed software. Any manuals that are not included are available online through the software's "Help" menu. We recommend that you review these manuals for information on the use of these applications.

### **Adobe Reader**

Adobe Reader allows you to view, navigate, and print PDF files across all major computing platforms.

### **Google Picasa**

(XP systems only.) Google Picasa lets you to search for, locate, move and label all photos on the computer.

### **Google Toolbar**

(Windows XP systems only.) Google Toolbar lets you to search the Internet quickly, block pop-ups, and perform a variety of other tasks to make your Internet experience easier and more pleasant.

### **Norton Internet Security**

Your system is preinstalled with a free 60-day trial version of Symantec's Norton Internet Security™. Internet Security is a suite of tools designed to protect your LifeBook from viruses, hackers, spam, and spyware. It helps you protect data currently on your hard disk from destruction or contamination. The trial version is activated upon your acceptance of software license agreement. After 60 days, you will need to purchase a subscription from Symantec to download latest virus, spyware, and spam definitions.

### **CyberLink MakeDisc**

(Windows 7 systems only) CyberLink MakeDisc allows you to burn data, videos and photographs to CDs or DVDs.

**CyberLink PowerDVD**

CyberLink PowerDVD allows you to produce and edit home movies and slideshows on discs.

**CyberLink YouCam**

CyberLink YouCam allows you to capture photos or movies on the embedded webcam, add special effects to them, and share them in a variety of formats or via social networks.

**CyberLink PowerDirector**

CyberLink PowerDirector allows you to edit and enhance your videos, and add special effects to them.

**Roxio Creator**

Roxio Creator lets you burn CDs and organize, edit and share digital photos, music, data, or videos.

**OmniPass Fingerprint application**

The fingerprint sensor uses Softex OmniPass which provides password management capabilities to Microsoft Windows operating systems. OmniPass lets you use a "master password" for all Windows, applications, and on-line passwords, and presents a convenient user interface through which you can securely manage passwords, users, and multiple identities for each user.

**Fujitsu Driver Update Utility**

The Fujitsu Driver Update (FDU) utility is pre-installed on your system. With FDU, you can choose to automatically or manually go to the Fujitsu site to check for new updates for your system. See “Automatically Downloading Driver Updates” on page 121.

**Microsoft OneNote**

Microsoft<sup>®</sup> Office OneNote<sup>®</sup> 2007 is a digital notebook that provides a flexible way to gather and organize your notes and information, powerful search capabilities so you can find what you're looking for quickly, and easy-to-use shared notebooks for teams to work together more effectively. Unlike paper-based systems, word processing programs, e-mail systems, or other productivity programs, Office OneNote<sup>®</sup> 2007 delivers the flexibility to gather and organize text, pictures, digital handwriting, audio and

video recordings, and more — all in one digital notebook on your computer. Office OneNote<sup>®</sup> 2007 can help you become more productive by keeping the information you need at your fingertips and reducing time spent searching for information across e-mail messages, paper notebooks, file folders, and printouts.

### **Microsoft Touch Pack**

The Microsoft Touch Pack is a set of three applications and three games that let you enjoy the interactive touch screen with the use of gestures and touches. The three applications include Microsoft Surface Globe, which lets you navigate around the globe via your desktop; Microsoft Surface Collage which lets you arrange, move and resize pictures using your fingertips; and Microsoft Surface Lagoon, which produces an interactive touch screensaver. The games include Microsoft Blackboard, Microsoft Rebound, and Microsoft Garden Pond, all of which use gestures and finger touch controls to play.

### **Microsoft Office Ready SP1 2007 with Office Activation Assistant**

With Office Ready PCs it's now even easier to take advantage of Microsoft<sup>®</sup> Office 2007. The full versions of Microsoft<sup>®</sup> Office Basic, Small Business and Professional 2007 are already preinstalled on your PC, so there's nothing to install, and all Office Ready PCs give you the option to activate a 60 day trial of Microsoft<sup>®</sup> Office Professional 2007! All you need to do is purchase the appropriate Office 2007 license kit which allows you to "un-lock" the full version of Office that you want.

Fujitsu offers a Media License Kit for Microsoft<sup>®</sup> Office Small Business 2007. Simply enter your product key and you're ready to go!

Another option is to purchase a Microsoft<sup>®</sup> Office 2007 media-less license kit (MLK) from either your computer reseller or online from Microsoft within 90 days of the purchase of your computer.

### **Operating System Options**

#### **Microsoft Windows 7 Professional**

With Microsoft OneNote and Microsoft OfficeReady with Office Assistant

#### **Microsoft Windows XP Tablet PC Downgrade Edition**

Available by special order only.





# Glossary

---

## **AC Adapter**

A device which converts the AC voltage from a wall outlet to the DC voltage needed to power your LifeBook Tablet PC.

## **Access point**

Wireless network device used to bridge wireless and wired network traffic.

## **ACPI**

Advanced Configuration and Power Interface

## **Active-Matrix Display**

A type of technology for making flat-panel displays which has a transistor or similar device for every pixel on the screen.

## **Ad Hoc Mode**

Ad Hoc Mode refers to a wireless network architecture where wireless network connectivity between multiple computers is established without a central wireless network device, typically known as Access Points. Connectivity is accomplished using only client devices in a peer-to-peer fashion.

**ADSL**

Asymmetric Digital Subscriber Line. Technology for transporting high bit-rate services over ordinary phone lines.

**AGP**

Accelerated Graphics Port. Graphics port specifically designed for graphics-intensive devices, such as video cards and 3D accelerators.

**Auto/Airline Adapter**

A device which converts the DC voltage from an automobile cigarette lighter or aircraft DC power outlet to the DC voltage needed to power your LifeBook Tablet PC.

**BIOS**

Basic Input-Output System. A program and set of default parameters stored in ROM which tests and operates your LifeBook Tablet PC when you turn it on until it loads your installed operating system from disk. Information from the BIOS is transferred to the installed operating system to provide it with information on the configuration and status of the hardware.

**Bit**

An abbreviation for binary digit. A single piece of information which is either a one (1) or a zero (0).

**bps**

An abbreviation for bits per second. Used to describe data transfer rates.

**Boot**

To start-up a computer and load its operating system from disk, ROM or other storage media into RAM.

**Bus**

An electrical circuit which passes data between the CPU and the sub-assemblies inside your LifeBook Tablet PC.

**Byte**

8 bits of parallel binary information.

**Cache Memory**

A block of memory built into the micro-processor which is much faster to access than your system RAM and used in specially structured ways to make your overall data handling time faster.

**CD-ROM**

Compact disk read only memory. This is a form of digital data storage which is read optically with a laser rather than a magnetic head. A typical CD-ROM can contain about 600MB of data and is not subject to heads crashing into the surface and destroying the data when there is a failure nor to wear from reading.

**Channel**

Range of narrow-band frequencies used by the WLAN device to transmit data. IEEE802.11b/g - 11 channels, 22 MHz wide channels.

**CMOS RAM**

Complementary metal oxide semiconductor random access memory. This is a technology for manufacturing random access memory which requires very low levels of power to operate.

**Command**

An instruction which you give your operating system. Example: run a particular application or format a floppy disk.

**Configuration**

The combination of hardware and software that makes up your system and how it is allocated for use.

**CRT**

Cathode Ray Tube. A display device which uses a beam of electronic particles striking a luminescent screen. It produces a visual image by varying the position and intensity of the beam.

**Data**

The information a system stores and processes.

**DC**

Direct current. A voltage or current that does not fluctuate periodically with time.

**Default Value**

A pre-programmed value to be used if you fail to set your own.

**DHCP**

Dynamic Host Configuration Protocol. A protocol used to automatically acquire parameters required for the communication, such as IP address. The sender of IP address is called a DHCP server, and the receiver is called a DHCP client.

**DIMM**

Dual-in-line memory module.

**Disk**

A spinning platter of magnetic data storage media. If the platter is very stiff it is a hard drive, if it is highly flexible it is a floppy disk, if it is a floppy disk in a hard housing with a shutter it is commonly called a diskette.

**Disk Drive**

The hardware which spins the disk and has the heads and control circuitry for reading and writing the data on the disk.

**Diskette**

A floppy disk in a hard housing with a shutter.

**DMA**

Direct Memory Access. Special circuitry for memory to memory transfers of data which do not require CPU action.

**DMI**

Desktop Management Interface. A standard that provides PC management applications with a common method of locally or remotely querying and configuring PC computer systems, hardware and software components, and peripherals.

**DNS**

Domain Name System. A function to control the association between the IP address and the name assigned to the computer. If you do not know the IP address but if you know the computer name, you can still communicate to that computer.

**DOS**

Disk Operating System (MS-DOS is a Microsoft Disk Operating System).

**Driver**

A computer program which converts application and operating system commands to external devices into the exact form required by a specific brand and model of device in order to produce the desired results from that particular equipment.

**DVMT**

Dynamic Video Memory Technology. A video memory architecture that increases the efficiency of the motherboard by using innovative memory utilization and direct AGP.

**ECP**

Extended Capability Port. A set of standards for high speed data communication and interconnection between electronic devices.

**Encryption Key (Network Key)**

Data encryption key used to encrypt message text and for computing message integrity checks. Data encryption protects data from unauthorized viewing.

This device uses the same encryption key to encode and decode the data, and the identical encryption key is required between the sender and receiver.

**ESD**

Electro-Static Discharge. The sudden discharge of electricity from a static charge which has built-up slowly. Example: the shock you get from a doorknob on a dry day or the sparks you get from brushing hair on a dry day.

**FCC**

Federal Communications Commission.

**Floppy Disk**

A spinning platter of magnetic data storage media which is highly flexible.

**GB**

Gigabyte. One billion bytes.

**Hard drive**

A spinning platter of magnetic data storage media where the platter is very stiff.

**I/O**

Input/Output. Data entering and leaving your Tablet PC in electronic form.

**I/O Port**

The connector and associated control circuits for data entering and leaving your Tablet PC in electronic form.

**IDE**

Intelligent Drive Electronics. A type of control interface for a hard drive which is inside the hard drive unit.

**IEEE802.11a**

Wireless LAN standard that supports a maximum data rate of 54 Mbps. 802.11a devices operate in the 5 GHz lower and middle UNII bands.

**IEEE802.11b**

Wireless LAN standard that supports a maximum data rate of 11 Mbps. 802.11b devices operate in the 2.4 GHz ISM band.

**IEEE802.11g**

Wireless LAN standard that supports a maximum data rate of 54 Mbps. 802.11g devices operate in the 2.4 GHz ISM band.

**Infrared**

Light just beyond the red portion of the visible light spectrum which is invisible to humans.

**Infrastructure**

A name of a wireless LAN configuration. This type of communication uses an access point. Another type of communication is called Ad Hoc.

**IP Address**

An identifier for a computer or device on a TCP/IP network. Networks using the TCP/IP protocol route messages based on the IP address of the destination. The format of an IP address is a 32-bit numeric address written as four numbers separated by periods. Each number can be zero to 255. For example, 1.160.10.240 could be an IP address.

Within an isolated network, you can assign IP addresses at random as long as each one is unique. However, connecting a private network to the Internet requires using registered IP addresses (called Internet addresses) to avoid duplicates.

The four numbers in an IP address are used in different ways to identify a particular network and a host on that network. Three regional Internet registries -- ARIN, RIPE NCC and APNIC -- assign Internet addresses from the following three classes.

Class A - supports 16 million hosts on each of 126 networks

Class B - supports 65,000 hosts on each of 16,000 networks

Class C - supports 254 hosts on each of 2 million networks

The number of unassigned Internet addresses is running out, so a new classless scheme called CIDR is gradually replacing the system based on classes A, B, and C and is tied to adoption of IPv6.

**IR**

An abbreviation for infrared.

**IrDA**

Infrared Data Association. An organization which produces standards for communication using infrared as the carrier.



**IRQ**

Interrupt Request. An acronym for the hardware signal to the CPU that an external event has occurred which needs to be processed.

**KB**

Kilobyte. One thousand bytes.

**LAN**

Local Area Network. An interconnection of computers and peripherals within a single limited geographic location which can pass programs and data amongst themselves.

**LCD**

Liquid Crystal Display. A type of display which makes images by controlling the orientation of crystals in a crystalline liquid.

**Lithium ion Battery**

A type of rechargeable battery which has a high power-time life for its size and is not subject to the memory effect as Nickel Cadmium batteries.

**LPT Port**

Line Printer Port. A way of referring to parallel interface ports because historically line printers were the first and latter the most common device connected to parallel ports.

**MAC Address**

Media Access Control Address. A unique physical address of a network card. For Ethernet, the first three bytes are used as the vendor code, controlled and assigned by IEEE. The remaining three bytes are controlled by each vendor (preventing overlap), therefore, every Ethernet card is given a unique physical address in the world, being assigned with a different address from other cards. For Ethernet, frames are sent and received based on this address.

**MB**

Megabyte. One million bytes.

**Megahertz**

1,000,000 cycles per second.

**Memory**

A repository for data and applications which is readily accessible to your LifeBook Tablet PC's CPU.

**MHz**

Megahertz.

**MIDI**

Musical Instrument Digital Interface. A standard communication protocol for exchange of information between computers and sound producers such as synthesizers.

**Modem**

A contraction for MODulator-DEModulator. The equipment which connects a computer or other data terminal to a communication line.

**Monaural**

A system using one channel to process sound from all sources.

**MTU**

Maximum Transmission Unit

The maximum data size that can be transferred at a time through the Internet or other networks. You can set a smaller MTU size to obtain successful communication, if you have difficulty transferring data due to the fact that the maximum size is too large.

**Network key**

Data that is used for encrypting data in data communication. The personal computer uses the same network key both for data encryption and decryption, therefore, it is necessary to set the same network key as the other side of communication.

**Network name (SSID: Service Set Identifier )**

When a wireless LAN network is configured, grouping is performed to avoid interference or data theft. This grouping is performed with “Network name (SSID)”. In order to improve security, the network key is set allowing no communication unless “Network name (SSID)” coincides with the network key.

**NTSC**

National TV Standards Commission. The standard for TV broadcast and reception for the USA.

**Open system authentication**

Null authentication method specified in the 802.11 standard that performs no authentication checks on a wireless client before allowing it to associate.

**Operating System**

A group of control programs that convert application commands, including driver programs, into the exact form required by a specific brand and model of microprocessor in order to produce the desired results from that particular equipment.

**Partition**

A block of space on a hard drive which is set aside and made to appear to the operating system as if it were a separate disk, and addressed by the operating system accordingly.

**PCMCIA**

PCMCIA is a trademark of the Personal Computer Memory Card International Association. The Personal Computer Memory Card International Association is an organization that sets standards for add-in cards for personal computers.

**Peripheral Device**

A piece of equipment which performs a specific function associated with but not integral to a computer. Examples: a printer, a modem, a CD-ROM.

**Pitch (keyboard)**

The distance between the centers of the letter keys of a keyboard.

**Pixel**

The smallest element of a display, a dot of color on your display screen. The more pixels per area the clearer your image will appear.

**POST**

Power On Self Test. A program which is part of the BIOS which checks the configuration and operating condition of your hardware whenever power is applied to your Tablet PC. Status and error messages may be displayed before the operating system is loaded. If the self test detects failures that are so serious that operation cannot continue, the operating system will not be loaded.

**PPPoE**

Point to Point Protocol over Ethernet. A protocol for Ethernet, using a Point-to-Point Protocol (PPP), which is used for connection on the phone line.

**Program**

An integrated set of coded commands to your computers telling your hardware what to do and how and when to do it.

**Protocol**

Procedures and rules use to send and receive data between computers.

- Method of sending and receiving data
- Process used to handle communication errors

Conditions required for communication are organized in procedures for correct transfer of information.

**RAM**

Random Access Memory. A hardware component of your LifeBook Tablet PC that holds binary information (both program and data) as long as it has the proper power applied to it.

**RAM Module**

A printed circuit card with memory and associated circuitry which allows the user to add additional memory to the computer without special tools.

**Reset**

The act of reloading the operating system. A reset erases all information stored in RAM.

**Restart**

See Reset.

**Resume**

To proceed after interruption. In your Tablet PC this refers to returning to active operation after having been in one of the suspension states.

**ROM**

Read Only Memory. A form of memory in which information is stored by physically altering the material. Data stored in this way cannot be changed by your Tablet PC and does not require power to maintain it.

**SDRAM**

Synchronous Dynamic Random Access Memory.

**Serial Port**

A connection to another device through which data is transferred one bit at a time on a single wire with any other wires only for control of the device not for transfer of data.

**Shared key authentication**

802.11 network authentication method in which the AP sends the client device a challenge text packet that the client must then encrypt with the correct WEP key and return to the AP. If the client has the wrong key or no key, authentication will fail and the client will not be allowed to associate with the AP. Shared key authentication is not considered secure, because a hacker who detects both the clear-text challenge and the same challenge encrypted with a WEP key can decipher the key.

**Sleep**

To make inoperative for a period of time. Your LifeBook Tablet PC uses various suspension states to reduce power consumption and prolong the charge of your battery.

**SSID**

Service Set Identifier, a 32-character unique identifier attached to the header of packets sent over a WLAN that acts as a password when a mobile device tries to connect to the BSS. The SSID differentiates one WLAN from another, so all access points and all devices attempting to connect to a specific WLAN must use the same SSID. A device will not be permitted to join the BSS unless it can provide the unique SSID. Because the SSID is broadcast in plain text, it does not supply any security to the network.

**Status Indicator**

A display which reports the condition of some portion of your hardware. On your LifeBook Tablet PC this is an LCD screen just above the keyboard.

**Stereo (audio)**

A system using two channels to process sound from two different sources.

**Subnet mask**

TCP-IP network is controlled by being divided into multiple smaller networks (subnets). IP address consists of the subnet address and the address of each computer. Subnet mask defines how many bits of IP address comprise the subnet address. The same value shall be set among computers communicating with each other.

**SVGA**

Super VGA.

**S-Video**

Super Video. A component video system for driving a TV or computer monitor.

**System Clock**

An oscillator of fixed precise frequency which synchronizes the operation of the system and is counted to provide time of day and date.

**TCP/IP**

Transmission Control Protocol/Internet Protocol. A standard Internet protocol that is most widely used.

**TFT**

Thin Film Transistor – A technology for flat display panels which uses a thin film matrix of transistors to control each pixel of the display screen individually.

**UL**

Underwriters Laboratories – An independent organization that tests and certifies the electrical safety of devices.

**USB**

Universal Serial Bus. Standard that allows you to simultaneously connect up to 127 USB devices such as game pads, pointing devices, printers, and keyboards to your computer.

**VRAM**

Video Random Access Memory. A memory dedicated to video display data and control.

**WFM**

Wired for Management is Intel's broad-based initiative to reduce the total cost of ownership (TCO) of business computing without sacrificing power and flexibility.

**Wi-Fi Compatible**

Wi-Fi (Wireless Fidelity) Identifies that the product has passed the interoperability test, supplied by the WECA (Wireless Ethernet Compatibility Alliance), which guarantees the interoperability of wireless IEEE 802.11 LAN products. For more information on the Wi-Fi standard, go to the WECA Web site at: [www.wirelessethernet.com](http://www.wirelessethernet.com).

**WLAN**

Wireless Local Area Network. A wireless interconnection of computers and peripherals within a single limited geographic location which can pass programs and data amongst themselves.



## Regulatory Information

### Notice

Changes or modifications not expressly approved by Fujitsu could void this user's authority to operate the equipment.

### FCC NOTICES

#### Notice to Users of Radios and Television

This equipment has been tested and found to comply with the limit for class B digital devices, pursuant to parts 15 of the FCC Rules.

These limits are designed to provide reasonable protection against harmful interference in a residential installation. This equipment generates, uses, and can radiate radio frequency energy and, if not installed and used in accordance with the instructions, may cause harmful interference to radio communications. However, there is no guarantee that interference will not occur in a particular installation. If this equipment does cause harmful interference to radio or television reception, which can be determined by turning the equipment off and on, the user is encouraged to try to correct the interference by one or more of the following measures:

- Reorient or relocate the receiving antenna.
- Increase the separation between the equipment and receiver.
- Connect the equipment into an outlet that is on a different circuit than the receiver.
- Consult the dealer or an experienced radio/TV technician for help.

Shielded interconnect cables must be employed with this equipment to ensure compliance with the pertinent RF emission limits governing this device.

### DOC (INDUSTRY CANADA) NOTICES

#### Notice to Users of Radios and Television

This Class B digital apparatus complies with Canadian ICES-003.

Cet appareil numérique de classe B respecte la norme canadienne ICES-003.



# Appendix A: WLAN User's Guide

## **FC** FCC Regulatory Information

Please note the following regulatory information related to the optional wireless LAN device.

### **Regulatory Notes and Statements**

#### **Wireless LAN, Health and Authorization for use**

Radio frequency electromagnetic energy is emitted from Wireless LAN devices. The energy levels of these emissions, however, are far much less than the electromagnetic energy emissions from wireless devices such as mobile phones. Wireless LAN devices are safe for use by consumers because they operate within the guidelines found in radio frequency safety standards and recommendations. The use of Wireless LAN devices may be restricted in some situations or environments, such as:

- On board an airplane, or
- In an explosive environment, or
- In situations where the interference risk to other devices or services is perceived or identified as harmful.

In cases in which the policy regarding use of Wireless LAN devices in specific environments is not clear (e.g., airports, hospitals, chemical/oil/gas industrial plants, private buildings), obtain authorization to use these devices prior to operating the equipment.

## **Regulatory Information/Disclaimers**

Installation and use of this Wireless LAN device must be in strict accordance with the instructions included in the user documentation provided with the product. Any changes or modifications made to this device that are not expressly approved by the manufacturer may void the user's authority to operate the equipment. The manufacturer is not responsible for any radio or television interference caused by unauthorized modification of this device, or the substitution or attachment of connecting cables and equipment other than those specified by the manufacturer. It is the responsibility of the user to correct any interference caused by such unauthorized modification, substitution or attachment. The manufacturer and its authorized resellers or distributors will assume no liability for any damage or violation of government regulations arising from failure to comply with these guidelines.

This device must not be co-located or operated in conjunction with any other antenna or transmitter.

**For IEEE 802.11a Wireless LAN:** For operation within 5.15~5.25 GHz frequency range, it is restricted to indoor environments, and the antenna of this device must be integral.

## **Federal Communications Commission statement**

This device complies with Part 15 of FCC Rules.

Operation is subject to the following two conditions: (1) This device may not cause interference, and, (2) This device must accept any interference, including interference that may cause undesired operation of this device.

## **FCC Interference Statement**

This equipment has been tested and found to comply with the limits for a Class B digital device, pursuant to Part 15 of the FCC Rules. These limits are designed to provide reasonable protection against harmful interference in a residential installation. This equipment generates, uses, and can radiate radio frequency energy. If not installed and used in accordance with the instructions, it may cause harmful interference to radio communications. However, there is no guarantee that interference will not occur in a particular installation.

If this equipment does cause harmful interference to radio or television reception, which can be determined by turning the equipment off and on, the user is encouraged to try and correct the interference by one or more of the following measures:

- 1** Reorient or relocate the receiving antenna.
- 2** Increase the distance between the equipment and the receiver.
- 3** Connect the equipment to an outlet on a circuit different from the one the receiver is connected to.
- 4** Consult the dealer or an experienced radio/TV technician for help.

### **FCC Radio Frequency Exposure statement**

The available scientific evidence does not show that any health problems are associated with using low power wireless devices. There is no proof, however, that these low power wireless devices are absolutely safe. Low power wireless devices emit low levels of radio frequency energy (RF) in the microwave range while being used. Whereas high levels of RF can produce health effects (by heating tissue), exposure to low-level RF that does not produce heating effects causes no known adverse health effects. Many studies of low-level RF exposure have not found any biological effects. Some studies have suggested that some biological effects might occur, but such findings have not been confirmed by additional research.

The wireless LAN radio device has been tested and found to comply with FCC radiation exposure limits set forth for an uncontrolled equipment and meets the FCC radio frequency (RF) Exposure Guidelines in Supplement C to OET65.

### **Export restrictions**

This product or software contains encryption code which may not be exported or transferred from the US or Canada without an approved US Department of Commerce export license. This device complies with Part 15 of FCC Rules., as well as ICES 003 B / NMB 003 B. Operation is subject to the following two conditions: (1) this device may not cause harmful interference, and (2) this device must accept any interference received, including interference that may cause undesirable operation. Modifications not expressly authorized by Fujitsu America, Inc. may invalidate the user's right to operate this equipment.

### **Canadian Notice**

The device for the 5150 - 5250 MHz band is only for indoor usage to reduce the potential for harmful interference to co-channel mobile satellite systems.

The maximum antenna gain of 6 dBi permitted (for devices in the 5250 - 5350 MHz, 5470 - 5725 MHz and 5725 - 5825 MHz bands) to comply with the e.i.r.p. limit as stated in A9.2 of RSS210.

In addition, users are cautioned to take note that high power radars are allocated as primary users (meaning they have priority) of 5250 - 5350 MHz and 5650 - 5850 MHz and these radars could cause interference and/or damage to LE-LAN devices.

## Before Using the Optional Wireless LAN

This manual describes the procedures required to properly set up and configure the optional integrated Wireless LAN Mini-PCI device (referred to as "WLAN device" in the rest of the manual). Before using the WLAN device, read this manual carefully to ensure its correct operation. Keep this manual in a safe place for future reference.

### Wireless LAN Device Covered by this Document

This document is applicable to systems containing one of the following optional devices:

- Optional integrated Intel Centrino Advanced-N 6200 (a/b/g/n, 2 x 2)
- Optional integrated Atheros XSPAN 802.11bgn

### Characteristics of the WLAN Device

- The WLAN device is a Mini-PCI card attached to the main board of the mobile computer.
- The WLAN device operates in license-free RF bands, eliminating the need to procure an FCC operating license. The WLAN operates in the 2.4GHz Industrial, Scientific, and Medical (ISM) RF band and the lower, middle, and upper bands of the 5GHz Unlicensed National Information Infrastructure (UNII) bands.
- The WLAN devices are capable of four operating modes, IEEE802.11a, IEEE802.11b, IEEE802.11g, and IEEE802.11n (draft)
- The WLAN devices are Wi-Fi certified and operate (as applicable) at a the maximum data rate of 540 Mbps (theoretical) in IEEE802.11n (draft) mode; 54 Mbps in IEEE802.11a or IEEE802.11g mode; and 11 Mbps in IEEE802.11b mode.
- The WLAN devices support the following encryption methods - WEP, TKIP, CKIP, and AES encryption.
- The Wireless LAN devices are compliant with the following standards: WPA, WPA2, CCX1.0, CCX2.0, CCX3.0, and CCX4.0.

## Wireless LAN Modes Using this Device

### Ad Hoc Mode

"Ad Hoc Mode" refers to a wireless network architecture where wireless network connectivity between multiple computers is established without a central wireless network device, typically known as Access Point(s). Connectivity is accomplished using only client devices in a peer-to-peer fashion. That is why Ad Hoc networks are also known as peer-to-peer networks. Ad Hoc networks are an easy and inexpensive method for establishing network connectivity between multiple computers. Ad Hoc mode requires that the SSID, network authentication, and encryption key settings are identically configured on all computers in the Ad Hoc network.

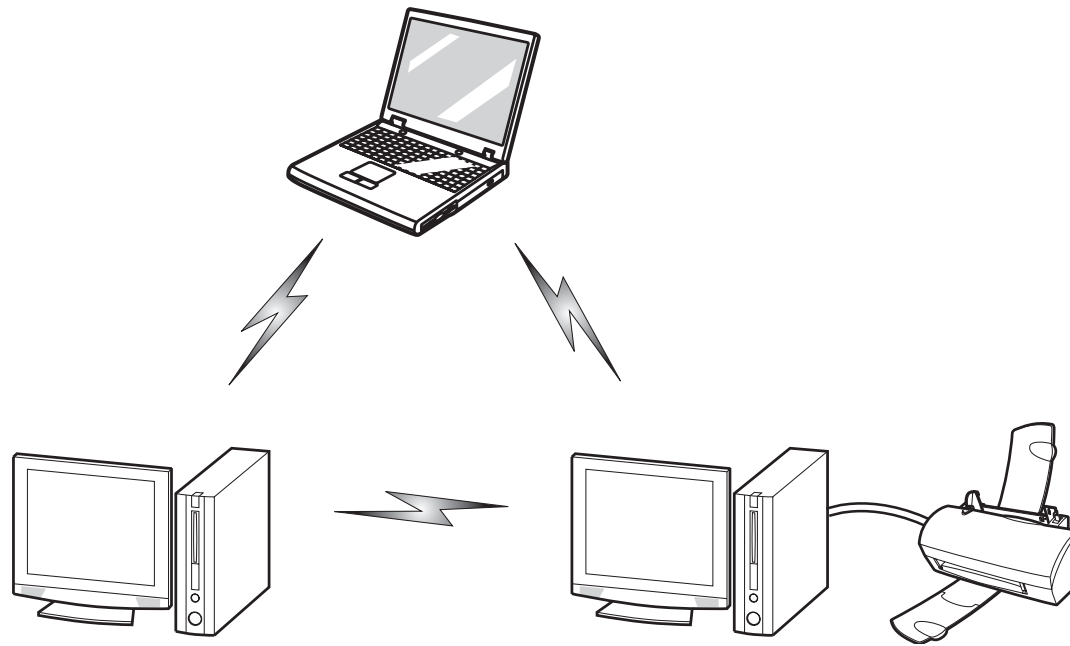

Figure 48. Ad Hoc Mode Network

### Access Point (Infrastructure) Mode

Infrastructure mode refers to a wireless network architecture in which devices communicate with wireless or wired network devices by communicating through an Access Point. In infrastructure mode, wireless devices can communicate with each other or with a wired network. Corporate wireless networks operate in infrastructure mode because they require access to the WLAN in order to access services, devices, and computers (e.g., file servers, printers, databases).

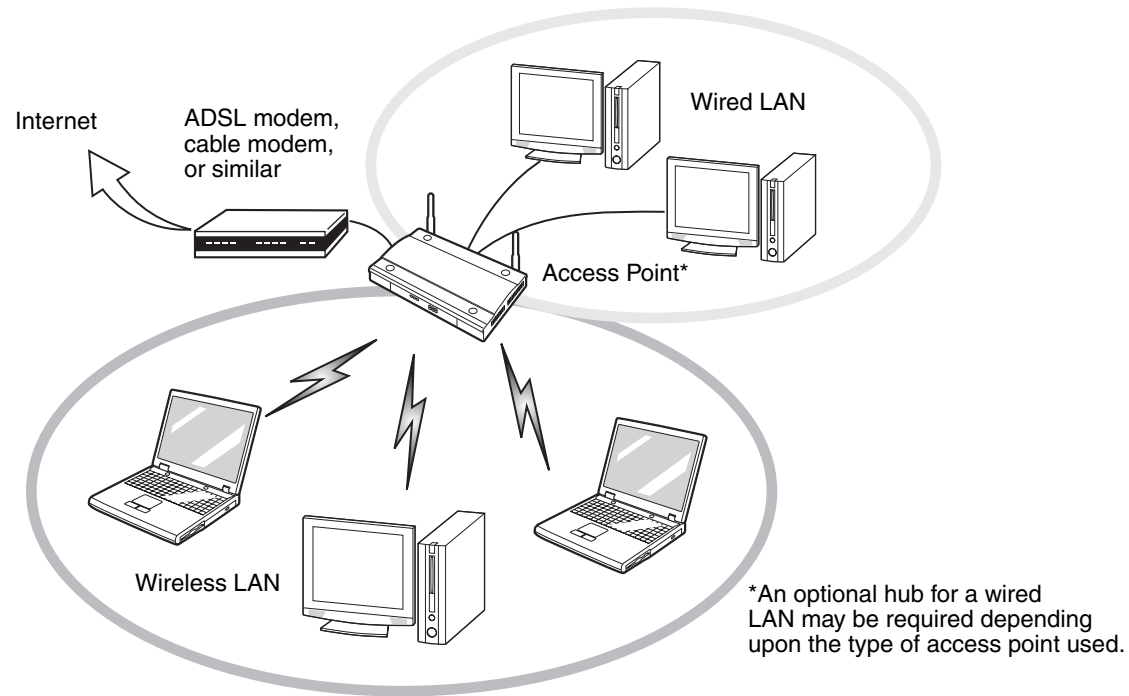

Figure 49. Access Point (Infrastructure) Mode Network

## How to Handle This Device

The WLAN device is an optional device that may come pre-installed in your mobile computer. Under normal circumstances, it should not be necessary for you to remove or re-install it. The operating system that your mobile computer comes with has been pre-configured to support the WLAN device.

- The Wireless LAN devices support IEEE802.11a, IEEE802.11b, IEEE802.11g, and IEEE802.11n.
- The WLAN devices operate in the 2.4 GHz ISM band and the 5 GHz lower, middle, and upper UNII bands.
- Microwave ovens may interfere with the operation of WLAN devices since they operate in the same 2.4 GHz frequency range as IEEE802.11b/g/n devices. Interference by microwaves does not occur with IEEE802.11a radio which operates in the 5 GHz RF band.
- Wireless devices that transmit in the 2.4 GHz range may interfere with operation of WLAN devices in IEEE802.11b/g/n modes. Symptoms of interference include reduced throughput, intermittent disconnects, and many frame errors. It is HIGHLY recommended that these interfering devices be powered off to ensure proper operation of the WLAN device.

## Deactivating/Disconnecting the WLAN Device

Disconnecting the WLAN device may be desired in certain circumstances (to extend battery life) or where certain environments require it (i.e. hospitals, clinics, airplanes, etc.). The WLAN device can be deactivated by using the Wireless On/Off Switch, and it can be disconnected in Windows using the WLAN icon in the system tray (Note that disconnecting via the icon in the system tray does not turn off the radio; it continues to transmit and receive even though it's not connected.).



BEFORE USING THE WIRELESS LAN DEVICE, YOU MUST FIRST INSTALL CLICKME! TO ENSURE THAT THE CORRECT SOFTWARE FOR YOUR DEVICE IS INSTALLED. SEE "INSTALLING CLICKME!" ON PAGE 74.



### Deactivation Using the Wireless On/Off Switch

The WLAN device can be deactivated quickly and efficiently by toggling the Wireless LAN/Bluetooth On/Off Switch to the Off position. The switch has no effect on non-Wireless LAN models.

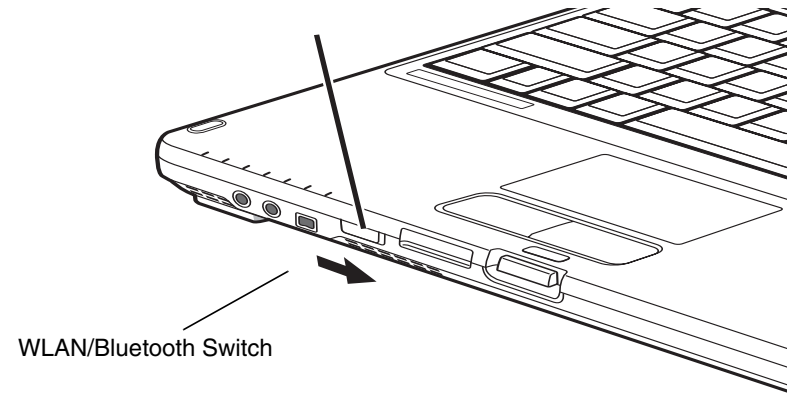

Figure 50. Wireless LAN/Bluetooth On/Off Switch Location

### Disconnection Using the Icon in the Taskbar

Note that disconnecting via the icon in the system tray does not turn off the radio; it continues to transmit and receive even though it's not connected.

- 1 Right-click the WLAN icon in the taskbar at the bottom right of your screen.
- 2 Choose Disconnect from a network.

### Activating the WLAN Device

Activation of the WLAN device can be accomplished using the same methods as the deactivation process

- Using the Wireless On/Off Switch
- In Windows, by right-clicking the WLAN icon then clicking "Connect to a network"

## Configuring the Wireless LAN

The WLAN device can be configured to establish wireless network connectivity using the software that is built into Windows. Support for most industry standard security solutions is contained in this software.

Pre-defined parameters will be required for this procedure. Please consult with your network administrator for these parameters:

### Configuring the WLAN

- 1 Click the Start button, then select Control Panel.
- 2 If the Control Panel is not in Classic View, select Classic View from the left panel. Double-click the Network Connections icon.
- 3 Double-click on the Wireless Network Connection icon.
- 4 Click on [View Wireless Networks]
- 5 Choose a wireless network.
- 6 Click [Connect].
- 7 Enter the Network Key, if required.
- 8 Enter any required information. It may be necessary to consult with your network administrator for some of the information.
- 9 If you require assistance, go to [Start] -> Help and Support -> Networking and the Web. Select the main topic in which you are interested, then type in relevant keywords in the Search box. Connecting to a Network

### Connection to the network

After you have configured your computer, you can connect to an active network by performing the following steps:

- 1 Click on the WLAN icon in the system tray.
- 2 Select "Connect to a network".
- 3 Select a network from the list that appears, and click the [Connect] button.

After you have configured your computer, you can connect to an active network by clicking on the Wireless Network icon in the system tray:

# Troubleshooting the WLAN

## Troubleshooting

Causes and countermeasures for troubles you may encounter while using your wireless LAN are described in the following table. If you are unfamiliar with the steps required, consult your System Administrator or go to [Start] -> Help and Support -> Networking and the Web

| Problem                        | Possible Cause                                    | Possible Solution  |
|--------------------------------|---|--|
| Unavailable network connection | Incorrect network name (SSID) or network key      | <p><b>Ad hoc connection:</b> verify that the network names (SSID's) and network keys (WEP) of all computers to be connected have been configured correctly. SSID's and WEP key values must be identical on each machine.</p> <p><b>Access Point (Infrastructure) connection:</b> set network name (SSID) and network key to the same values as those of the access point.</p> <p>Set the Network Authentication value identically to that of the Access Point. Please consult your network administrator for this value, if necessary.</p> |
|                                | Weak received signal strength and/or link quality | <p>Ad hoc connection: Retry connection after shortening the distance to the destination computer or removing any obstacles for better sight.</p> <p>Access Point (Infrastructure) connection: Retry connection after shortening the distance to the access point or removing any obstacles for better transmission.</p>  |
|                                | The WLAN device has been deactivated or disabled  | Check if the wireless switch is turned On. Go to Start -> Control Panel, and double-click on Windows Mobility Center. If the wireless network is off, click the [Turn wireless on] button.   |
|                                | The computer to be connected is turned off        | Check if the computer to be connected is turned ON.  |

| <b>Problem</b>                                    | <b>Possible Cause</b>   | <b>Possible Solution</b>   |
|---|---|--|
| Unavailable network connection<br><br>(continued) | RF interference from Access Points or other wireless networks | The use of identical or overlapping RF channels can cause interference with the operation of the WLAN device. Change the channel of your Access Point to a channel that does not overlap with the interfering device.  |
|   | Wireless network authentication has failed                    | Re-check your Network Authentication, Encryption, and Security settings. Incorrectly configured security settings such as an incorrectly typed WEP key, a misconfigured LEAP username, or an incorrectly chosen authentication method will cause the LAN device to associate but not authenticate to the wireless network. |
|   | Incorrectly configured network settings                       | Recheck the configuration of your network settings.  |
|   | Incorrect IP address configuration                            | This only applies to networks using static IP addresses. Please contact your network administrator for the correct settings.   |

# WLAN Specifications

## Specifications

| Item   | Specification  |
|--|--|
| Type of network  | The optional integrated Intel Centrino Advanced-N 6200 (a/b/g/n, 2 x 2) and Atheros XSPAN 802.11bgn) WLAN devices conform to IEEE 802.11a, 802.11b/g, and 802.11n (draft-compliant), Wi-Fi based*.   |
| Transfer rate  | (Automatic switching) 54 Mbps maximum data rate (IEEE802.11n to be determined)   |
| Active frequency   | <ul style="list-style-type: none"> <li>• 802.11n (draft): 2.4 GHz or 5 GHz</li> <li>• 802.11b/g: 2400~2473 MHz</li> <li>• 802.11a: 4900 ~ 5850 MHz</li> </ul>  |
| Typical operating distances**  | <ul style="list-style-type: none"> <li>• 802.11a: 40 ft. (12 m) @ 54 Mbps; 300 ft. (91 m) @ 6 Mbps</li> <li>• 802.11b: 100 ft. (30 m) @ 11 Mbps; 300 ft. (91 m) @ 1 Mbps</li> <li>• 802.11g: 100 ft. (30 m) @ 54 Mbps; 300 ft. (91 m) @ 1 Mbps</li> <li>• 802.11n (draft): Estimated double the operating distance of 802.11g and 802.11a in their respective frequencies.</li> </ul>  |
| Number of channels   | <ul style="list-style-type: none"> <li>• 802.11a: 8 independent channels</li> <li>• 802.11b/g: 11 channels, 3 non-overlapping channels</li> <li>• 802.11n (draft): 2.4 GHz - 3 non-overlapping channels when Channel Bonding is not used; 2 non-overlapping channels when Channel Bonding is used. 5 GHz - 12 non-overlapping UNII channels with or without Channel Bonding</li> </ul> |
| Security   | Encryption Types - WEP, TKIP, AES***, WPA 1.0 compliant<br>Encryption Key lengths Supported: 64 bits and 128 bits 802.1x/EAP   |
| Maximum recommended number of computers to be connected over wireless LAN (during ad hoc connection) | 10 units or less ****  |

- \* “Wi-Fi based” indicates that the interconnectivity test of the organization which guarantees the interconnectivity of wireless LAN (Wi-Fi Alliance) has been passed.
- \*\* The communication ranges shown above will increase or decrease depending on factors such as number of walls, reflective material, or interference from external RF sources.
- \*\*\* Encryption with network key (WEP) is performed using the above number of bits, however, users can set 40 bits/ 104 bits after subtracting the fixed length of 24 bits.
- \*\*\*\* Depending on practical environments, the allowable number of computers to be connected may be decreased.

## Using the Bluetooth Device

The optional Integrated Bluetooth module (BSMAN3) is a wireless device installed in selected Fujitsu mobile computers.

### What is Bluetooth

Bluetooth technology is designed as a short-range wireless link between mobile devices, such as laptop computers, phones, printers, and cameras. Bluetooth technology is used to create Personal Area Networks (PANs) between devices in short-range of each other.



THE WIRELESS LAN/BLUETOOTH ON/OFF SWITCH WILL POWER OFF BOTH THE OPTIONAL WIRELESS LAN AND BLUETOOTH DEVICES AT THE SAME TIME. TO ENABLE OR DISABLE EITHER ONE OF THE DEVICES INDIVIDUALLY, PERFORM THE FOLLOWING STEPS:

- 1 Slide the Wireless LAN/Bluetooth on/off switch to On position.
- 2 Go to Start > **All Programs** > **Bluetooth**.
- 3 Click on **Options** under the Bluetooth menu and click on the **Bluetooth Radio Power** button.
- 4 Click [OK].

### Where to Find Information About Bluetooth

The Bluetooth module contains a robust Help user's guide to assist you in learning about operation of the Bluetooth device.

To access the Help file, click [Start] -> All Programs, and click on Bluetooth, then select User's Guide.

For additional information about Bluetooth Technology, visit the Bluetooth Web site at: [www.bluetooth.com](http://www.bluetooth.com).

**FCC Radiation Exposure Statement**

This equipment complies with FCC radiation exposure limits set forth for an uncontrolled environment. The Bluetooth antenna is located on the front edge of the right palm rest and is exempt from minimum distance criteria due to its low power.

The transmitters in this device must not be co-located or operated in conjunction with any other antenna or transmitter.

**Canadian Notice**

To prevent radio interference to the licensed service, this device is intended to be operated indoors and away from windows to provide maximum shielding. Equipment (or its transmit antenna) that is installed outdoors is subject to licensing.

**Warranty**

Users are not authorized to modify this product. Any modifications invalidate the warranty.

This equipment may not be modified, altered, or changed in any way without signed written permission from Fujitsu. Unauthorized modification will void the equipment authorization from the FCC and Industry Canada and the warranty.



# Appendix B: Fingerprint Sensor Device

## Introducing the Fingerprint Sensor Device

Your system has a fingerprint sensor device at the bottom left below the display screen.

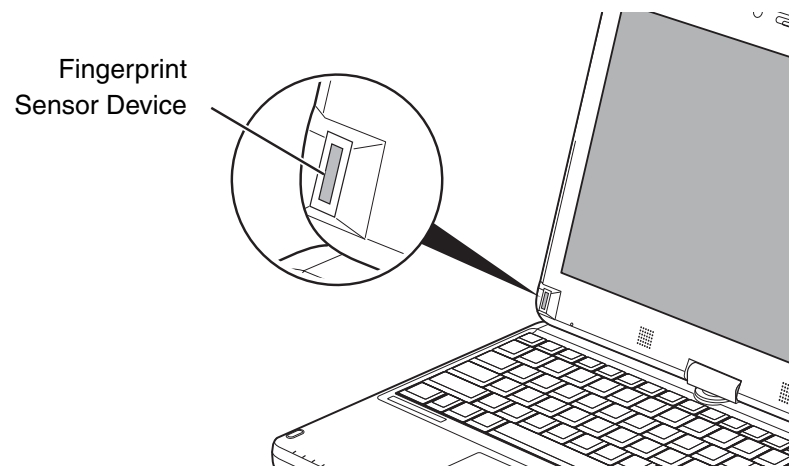

**Figure 51. Fingerprint sensor**

With a fingerprint sensor, you can avoid having to enter a username and password every time you want to:

- Log onto Windows
- Resume from sleep mode
- Cancel a password-protected screen saver

- Log into homepages that require a username and password

After you have “enrolled” - or registered - your fingerprint, you can simply swipe your fingertip over the sensor for the system recognize you.

The fingerprint sensor uses Softex OmniPass which provides password management capabilities to Microsoft Windows operating systems. OmniPass enables you to use a "master password" for all Windows, applications, and on-line passwords.

OmniPass requires users to authenticate themselves using the fingerprint sensor before granting access to the Windows desktop. This device results in a secure authentication system for restricting access to your computer, applications, web sites, and other password-protected resources.

OmniPass presents a convenient graphical user interface, through which you can securely manage passwords, users, and multiple identities for each user.

## Getting Started

This section guides you through the preparation of your system for the OmniPass fingerprint recognition application. You will be led through the OmniPass installation process. You will also be led through the procedure of enrolling your first user into OmniPass.

## Installing OmniPass

If OmniPass has already been installed on your system, skip this section and go directly to “User Enrollment” on page 181. You can determine whether OmniPass has already been installed by checking to see if the following are present:

- The gold key-shaped OmniPass icon in the system tray at the bottom right of the screen.
- The Softex program group in the **Programs** group of the **Start** menu

## System Requirements

The OmniPass application requires space on your hard drive; it also requires specific Operating Systems (OS's). The minimum requirements are as follows:

- Windows XP Professional operating system
- At least 35 MB available hard disk space

### Installing the OmniPass Application

If OmniPass is already installed on your system, go to “User Enrollment” on page 181. Otherwise continue with this section on software installation.



- INSTALLATION OF THE APPLICATION REQUIRES THAT YOU HAVE AN EXTERNAL OPTICAL DRIVE ATTACHED TO YOUR SYSTEM.
- FOR INSTALLATION, OMNIPASS REQUIRES THAT THE USER INSTALLING OMNIPASS HAVE ADMINISTRATIVE PRIVILEGES TO THE SYSTEM. IF YOUR CURRENT USER DOES NOT HAVE ADMINISTRATIVE PRIVILEGES, LOG OUT AND THEN LOG IN WITH AN ADMINISTRATOR USER BEFORE PROCEEDING WITH OMNIPASS INSTALLATION.

To install OmniPass on your system you must:

- 1** Insert the installation media for the OmniPass application into the appropriate drive. If you are installing from CD-ROM or DVD-ROM, you must find and launch the OmniPass installation program (setup.exe) from the media.
- 2** Follow the directions provided in the OmniPass installation program. Specify a location to which you would like OmniPass installed. It is recommended that you NOT install OmniPass in the root directory (e.g. C:\).
- 3** Once OmniPass has completed installation you will be prompted to restart your system. Once your system has rebooted you will be able to use OmniPass. If you choose not to restart immediately after installation, OmniPass will not be available for use until the next reboot.
- 4** The installation program automatically places an icon (Softex OmniPass) in the Windows Control Panel as well as a golden key shaped icon in the taskbar.

### Verifying Information about OmniPass

After you have completed installing OmniPass and restarted your system, you may wish to check the version of OmniPass on your system.

To check the version information of OmniPass:

- 1 From the Windows Desktop, double-click the key-shaped OmniPass icon in the taskbar (usually located in the lower right corner of the screen),  
or,  
Click the **Start** button, select **Settings**, and click **Control Panel**. Double-click **Softex OmniPass** in the Control Panel, and the OmniPass Control Center will appear. If it does not appear, then the program is not properly installed,  
or,  
Click the **Start** button, select **Programs**, and from the submenu select the **Softex** program group, from that submenu click **OmniPass Control Center**.
- 2 Select the **About** tab at the top of the OmniPass Control Center. The About tab window appears with version information about OmniPass.

### Uninstalling OmniPass



FOR UNINSTALLATION, OMNIPASS REQUIRES THAT THE USER UNINSTALLING OMNIPASS HAVE ADMINISTRATIVE PRIVILEGES TO THE SYSTEM. IF YOUR CURRENT USER DOES NOT HAVE ADMINISTRATIVE PRIVILEGES, LOG OUT AND THEN LOG IN WITH AN ADMINISTRATOR USER BEFORE PROCEEDING WITH OMNIPASS UNINSTALLATION.

To remove the OmniPass application from your system:

- 1 Click **Start** on the Windows taskbar. Select **Settings**, and then **Control Panel**.
- 2 Double-click **Add/Remove Programs**.
- 3 Select **OmniPass**, and then click **Change/Remove**.
- 4 Follow the directions to uninstall the OmniPass application.
- 5 Once OmniPass has finished uninstalling, reboot your system when prompted.

## User Enrollment

Before you can use any OmniPass features you must first enroll a user into OmniPass.

### Master Password Concept

Computer resources are often protected with passwords. Whether you are logging into your computer, accessing your email, e-banking, paying bills online, or accessing network resources, you often have to supply credentials to gain access. This can result in dozens of sets of credentials that you have to remember.

During user enrollment a "master password" is created for the enrolled user. This master password "replaces" all other passwords for sites you register with OmniPass.

**Example:** A user, John, installs OmniPass on his system (his home computer) and enrolls an OmniPass user with username "John\_01" and password "freq14". He then goes to his webmail site to log onto his account. He inputs his webmail credentials as usual (username "John\_02" and password "lifebook"), but instead of clicking [Submit], he directs OmniPass to **Remember Password**. Now whenever he returns to that site, OmniPass will prompt him to supply access credentials.

John enters his OmniPass user credentials ("John\_01" and "freq14") in the OmniPass authentication prompt, and he is allowed into his webmail account. He can do this with as many web sites or password protected resources he likes, and he will gain access to all those sites with his OmniPass user credentials ("John\_01" and "freq14"). This is assuming he is accessing those sites with the system onto which he enrolled his OmniPass user. OmniPass does not actually change the credentials of the password protected resource. If John goes to another computer without he OmniPass account to access his webmail, he would need to enter his original webmail credentials ("John\_02" and "lifebook") to gain access. If he attempts his OmniPass user credentials on a system other than a system he's enrolled on, he will not gain access.



THE ENROLLMENT PROCEDURE ASSUMES YOU HAVE NO HARDWARE AUTHENTICATION DEVICES OR ALTERNATE STORAGE LOCATIONS THAT YOU WISH TO INTEGRATE WITH OMNIPASS. IF YOU DESIRE SUCH FUNCTIONALITY, CONSULT THE APPROPRIATE SECTIONS OF THIS DOCUMENT.

## Basic Enrollment

The Enrollment Wizard will guide you through the process of enrolling a user. Unless you specified otherwise, after OmniPass installation the Enrollment Wizard will launch on Windows login. If you do not see the Enrollment Wizard, you can bring it up by clicking **Start** on the Windows taskbar; select **Programs**; select **Softex**; click **OmniPass Enrollment Wizard**.

- 1 Click **Enroll** to proceed to username and password verification. By default, the OmniPass Enrollment Wizard enters the credentials of the currently logged in Windows user.
- 2 Enter the password you use to log in to Windows. This will become the “master password” for this OmniPass user. In most cases, the **Domain:** value will be your Windows computer name. In a corporate environment, or when accessing corporate resources, the **Domain:** may not be your Windows computer name. Click [Next] to continue.
- 3 In this step OmniPass captures your fingerprint. Refer to “Enrolling a Fingerprint” on page 182 for additional information.
- 4 Next, choose how OmniPass notifies you of various events. We recommend you keep **Taskbar Tips** on **Beginner mode taskbar tips** and **Audio Tips** on at least **Prompt with system beeps only** until you get accustomed to how OmniPass operates. Click [Next] to proceed with user enrollment. You will then see a Congratulations screen indicating your completion of user enrollment.
- 5 Click [Done] to exit the OmniPass Enrollment Wizard. You will be asked if you’d like to log in to OmniPass with your newly enrolled user; click [Yes].

## Enrolling a Fingerprint

Enrolling a fingerprint will increase the security of your system and streamline the authentication procedure.

You enroll fingerprints in the OmniPass Control Center. With an OmniPass user logged in, double-click the system tray OmniPass icon. Select the **User Settings** tab and click **Enrollment** under the **User Settings** area. Click **Enroll Authentication Device** and authenticate at the authentication prompt to start device enrollment.

- 1 During initial user enrollment, you will be prompted to select the finger you wish to enroll. Fingers that have already been enrolled will be marked by a green check. The finger you select to enroll at this time will be marked by a red arrow. OmniPass will allow you re-enroll a finger. If you choose a finger that has already been enrolled and continue enrollment, OmniPass will enroll the fingerprint, overwriting the old fingerprint. Select a finger to enroll and click [Next].
- 2 It is now time for OmniPass to capture your selected fingerprint. It may take a several capture attempts before OmniPass acquires your fingerprint. Should OmniPass fail to acquire your fingerprint, or if the capture screen times out, click [Back] to restart the fingerprint enrollment process.

Your system has a “swipe” fingerprint sensor. A swipe sensor is small and resembles a skinny elongated rectangle. To capture a fingerprint, gently swipe or pull your fingertip over the sensor (starting at the second knuckle) **towards yourself**. Swiping too fast or too slow will result in a failed capture. The **Choose Finger** screen has a [Practice] button; click it to practice capturing your fingerprint. When you are comfortable with how your fingerprint is captured, proceed to enroll a finger.

- 3 Once OmniPass has successfully acquired the fingerprint, the **Verify Fingerprint** screen will automatically appear. To verify your enrolled fingerprint, place your fingertip on the sensor and hold it there as if you were having a fingerprint captured. Successful fingerprint verification will show a green fingerprint in the capture window and the text **Verification Successful** under the capture window.

## Using OmniPass

You are now ready to begin using OmniPass. Used regularly, OmniPass will streamline your authentications.

### Password Replacement

You will often use the password replacement function. When you go to a restricted access website (e.g., your bank, your web-based email, online auction or payment sites), you are always prompted to enter your login credentials. OmniPass can detect these prompts and you can teach OmniPass your login credentials. The next time you go to that website, you can authenticate with your fingerprint to gain access.

## OmniPass Authentication Toolbar

After installing OmniPass and restarting, you will notice a dialog you have not seen before at Windows Logon. This is the OmniPass Authentication Toolbar, and it is displayed whenever the OmniPass authentication system is invoked. The OmniPass authentication system may be invoked frequently: during Windows Logon, during OmniPass Logon, when unlocking your workstation, when resuming from sleep or hibernate, when unlocking a password-enabled screensaver, during password replacement for remembered site or application logins, and more. When you see this toolbar, OmniPass is prompting you to authenticate.

The **Logon Authentication** window indicates what OmniPass-restricted function you are attempting. The icons in the lower left (fingerprint and key) show what authentication methods are available to you. Selected authentication methods are highlighted while unselected methods are not. When you click the icon for an unselected authentication method, the authentication prompt associated with that method is displayed.

When prompted to authenticate, you must supply the appropriate credentials: an enrolled finger for the fingerprint capture window or your master password for the master password prompt (the key icon).

## Remembering a Password

OmniPass can remember any application, GUI, or password protected resource that has a password prompt.

Using the following procedure, you can store a set of credentials into OmniPass. These credentials will then be linked to your “master password” or fingerprint.

Go to a site that requires a login (username and password), but *do not log in yet*. At the site login prompt, enter your username and password in the prompted fields, but *do not enter the site* (do not hit [Enter], [Submit], [OK], or Login). Right-click the OmniPass system tray icon and select **Remember Password** from the submenu. The Windows arrow cursor will change to a golden key OmniPass cursor. Click the OmniPass cursor in the login prompt area, but don't click [Login] or [Submit].



### Associating a Friendly Name

After clicking the OmniPass key cursor near the login prompt, OmniPass will prompt you to enter a “friendly name” for this site. You should enter something that reminds you of the website, the company, or the service you are logging into. In its secure database, OmniPass associates this friendly name with this website.

### Additional Settings for Remembering a Site

When OmniPass prompts you to enter a “friendly name” you also have the opportunity to set how OmniPass authenticates you to this site. There are three effective settings for how OmniPass handles a remembered site.

The default setting is **Automatically click the “OK” or “Submit” button for this password protected site once the user is authenticated.** With this setting, each time you navigate to this site OmniPass will prompt you for your master password or fingerprint authentication device. Once you have authenticated with OmniPass, you will automatically be logged into the site.

Less secure is the option to **Automatically enter this password protected site when it is activated. Do not prompt for authentication.** Check the upper box to get this setting, and each time you navigate to this site OmniPass will log you into the site without prompting you to authenticate.



THIS SETTING IS MORE CONVENIENT IN THAT WHENEVER YOU GO TO A SITE REMEMBERED WITH THIS SETTING, YOU WILL BYPASS ANY AUTHENTICATION PROCEDURE AND GAIN INSTANT ACCESS TO THE SITE. BUT SHOULD YOU LEAVE YOUR SYSTEM UNATTENDED WITH YOUR OMNIPASS USER LOGGED IN, ANYONE USING YOUR SYSTEM CAN BROWSE TO YOUR PASSWORD PROTECTED SITES AND GAIN AUTOMATIC ACCESS.

If you uncheck both boxes in **Settings for this Password Site**, OmniPass will prompt you for your master password or fingerprint authentication device. Once you have authenticated with OmniPass your credentials will be filled in to the site login prompt, but you will have to click the website [OK], [Submit], or [Login] button to gain access to the site.

Click **Finish** to complete the remember password procedure. The site location, the credentials to access the site, and the OmniPass authentication settings for the site are now stored in the OmniPass secure database. The OmniPass authentication settings (**Settings for this Password Site**) can always be changed in **Vault Management**.

### **Logging in to a Remembered Site**

Whether or not OmniPass prompts you to authenticate when you return to a remembered site is determined by **Settings for this Password Site** and can be changed in **Vault Management**.

The following cases are applicable to using OmniPass to login to: Windows, remembered web sites, and all other password protected resources.

#### **With Master Password**

Once you return to a site you have remembered with OmniPass, you may be presented with a master password prompt. Enter your master password and you will be allowed into the site.

#### **Logging into Windows with a Fingerprint Device**

When logging into Windows with a fingerprint device, the fingerprint capture window will now appear next to the Windows Login screen. Place your enrolled fingertip on the sensor to authenticate. You will be simultaneously logged into Windows and OmniPass. The capture window will also appear if you have used **Ctrl-Alt-Del** to lock a system, and the fingerprint device can be used to log back in as stated above.



IF A MACHINE IS LOCKED AND OMNIPASS DETECTS A DIFFERENT USER LOGGING BACK IN WITH A FINGERPRINT, THE FIRST USER WILL BE LOGGED OUT AND THE SECOND USER LOGGED IN.

## Password Management

OmniPass provides an interface that lets you manage your passwords. To access this GUI, double-click the OmniPass key in the system tray. Click **Vault Management**; you will be prompted to authenticate. Once you gain access to **Vault Management**, click **Manage Passwords** under **Vault Settings**. You will see the **Manage Passwords** interface, with a list of friendly names.

You can view the credentials stored for any remembered website by highlighting the desired resource under **Password Protected Dialog** and clicking **Unmask Values**. Should a password be reset, or an account expire, you can remove stored credentials from OmniPass. Highlight the desired resource under **Password Protected Dialog** and click **Delete Page**. You will be prompted to confirm the password deletion.

The two check boxes in **Manage Passwords** govern whether OmniPass prompts you to authenticate or directly logs you into the remembered site.

OmniPass will overwrite an old set of credentials for a website if you attempt to use **Remember Password** on an already remembered site.

The exception to the above rule is when resetting the Windows password. If your password is reset in Windows, the next time you login to Windows, OmniPass will detect the password change and prompt you to “Update” or “Reconfirm” the password with OmniPass. Enter your new Windows password in the prompt and click **OK**. Your OmniPass "master password" will still be your Windows password.

## OmniPass User Identities

Identities allow OmniPass users to have multiple accounts to the same site (e.g., *bob@biblomail.com* and *boballen@biblomail.com*). If OmniPass did not provide you identities, you would be limited to remembering one account per site.

To create and manage identities, double-click the OmniPass key in the system tray. Click **Vault Management**; OmniPass will prompt you to authenticate. Once you gain access to **Vault Management**, click **Manage Identities** under **Vault Settings**. You can only manage the identities of the currently logged in OmniPass user

To add a new identity, click **New Identity** or double-click **Click here to add a new identity**. Name the new identity and click [OK], then click [Apply]. You can now switch to the new identity and start remembering passwords.

To delete an identity, highlight the identity you want to delete and click [Delete Identity], then [Apply].



WHEN YOU DELETE AN IDENTITY, ALL OF ITS ASSOCIATED REMEMBERED SITES AND PASSWORD PROTECTED DIALOGS ARE LOST.

To set the default identity, highlight the identity you want as default and click [Set as Default]; click [Apply] to ensure the settings are saved. If you log in to OmniPass with a fingerprint device, you will automatically be logged in to the default identity for that OmniPass user. You can choose the identity with which you are logging in if you login using "master password".

### **Choosing User Identity during Login**

To choose your identity during login, type your username in the **User Name:** field. Press [Tab] and see that the **Domain:** field self-populates. Click the **Password:** field to bring the cursor to it, and you will see the pull-down menu in the **Identity:** field. Select the identity to login as, then click **OK**.

### **Switch User Identity**

To switch identities at any time, right-click the OmniPass system tray icon and click **Switch User Identity** from the submenu. The **Switch Identity** dialog will appear. Select the desired identity and then click **OK**.

### **Identities and Password Management**

On the **Manage Passwords** interface of the **Vault Management** tab of the OmniPass Control Center, there is a pull-down selection box labeled, **Identity**. This field lets you choose which identity you are managing passwords for. When you select an identity here, only those password protected dialogs that are associated with that identity are shown. You can perform all the functions explained in “Password Management” on page 187.

## Configuring OmniPass

This section gives an overview of both the Export/Import function and the OmniPass Control Center.

### Exporting and Importing Users



YOU CANNOT IMPORT A USER INTO OMNIPASS IF THERE ALREADY IS A USER WITH THE SAME NAME ENROLLED IN OMNIPASS.

Using OmniPass Control Center, you can export and import users in and out of OmniPass. The export process backs up all remembered sites, credentials, and enrolled fingerprints for an OmniPass user. All OmniPass data for a user is backed up to a single encrypted database file. During the import process, the Windows login of the exported user is required. If the proper credentials cannot be supplied, the user profile will not be imported.



- YOU SHOULD PERIODICALLY EXPORT YOUR USER PROFILE AND STORE IT IN A SAFE PLACE. IF ANYTHING HAPPENS TO YOUR SYSTEM, YOU CAN IMPORT YOUR OMNIPASS PROFILE TO A NEW SYSTEM AND HAVE ALL YOUR REMEMBERED SETTINGS AND FINGERPRINTS INSTANTLY.
- YOU DON'T FORGET THE WINDOWS LOGIN CREDENTIALS WHEN EXPORTING. WHEN YOU EXAMINE THE IMPORTATION, YOU ARE PROMPTED FOR AUTHENTICATION. THE CREDENTIALS THAT WILL ALLOW A USER PROFILE TO BE IMPORTED ARE THE WINDOWS LOGIN CREDENTIALS OF THE EXPORTED USER. THEY ARE THE CREDENTIALS THAT HAD TO BE SUBMITTED WHEN THE USER PROFILE WAS EXPORTED. YOU WILL NEED USER NAME, PASSWORD, AND DOMAIN.

### Exporting an OmniPass User Profile

To export a user, open the OmniPass Control Center, and click **Import/Export User** under **Manage Users**.

Click **Exports an OmniPass user profile**. OmniPass will prompt you to authenticate. Upon successfully authentication, you must name the OmniPass user profile and decide where to save it. An .opi file is generated, and you should store a copy of it in a safe place.

This .opi file contains all your user specific OmniPass data, and it is both encrypted and password protected. This user profile does NOT contain any of your encrypted data files.

### **Importing an OmniPass User Profile**

To import an OmniPass user open the OmniPass Control Center, and click Import/Export User under Manage Users. Click Imports a new user into OmniPass and then select OmniPass Import/Export File (\*.opi) and click Next. OmniPass will then prompt you to browse for the file you had previously exported (.opi file). When you select the .opi file for importation, OmniPass will prompt you for authentication. The credentials that will allow a user profile to be imported are the Windows login credentials of the exported user. They are the credentials that had to be submitted when the user profile was exported. You will need User Name, Password, and Domain. If you don't remember the value for Domain, in a PC or SOHO environment Domain should be your computer name.

OmniPass will notify you if the user was successfully imported.

### **Things to Know Regarding Import/Export**

- Assume you export a local Windows User profile from OmniPass. You want to import that profile to another machine that has OmniPass. Before you can import the profile, a Windows user with the same login credentials must be created on the machine importing the profile.

**Example:** I have a Windows user with the username “Tom” and the password “Sunshine” on my system. I have enrolled Tom into OmniPass and remembered passwords. I want to take all my passwords to new system. I export Tom’s OmniPass user profile. I go to my new system and using the Control Panel I create a user with the username "Tom" and the password "Sunshine". I can now successfully import the OmniPass user data to the new system.

- If you export an OmniPass-only user, you can import that user to any computer running OmniPass, provided that a user with that name is not already enrolled in OmniPass.
- If you attempt to import a user profile who has the same name as a user already enrolled in OmniPass, the OmniPass import function will fail.

## OmniPass Control Center

This section will serve to explain functions within the OmniPass Control Center that weren't explained earlier.

You can access the OmniPass Control Center any of three ways:

- Double-click the golden OmniPass key shaped icon in the Windows taskbar (typically in the lower-right corner of the desktop)
- Click the **Start** button; select the **Programs** group; select the **Softex** program group; and click the **OmniPass Control Center** selection.
- Open the Windows **Control Panel** (accessible via **Start** button --> **Settings** --> **Control Panel**) and double-click the **Softex OmniPass** icon.

## User Management

The User Management tab has two major interfaces: **Add/Remove User** and **Import/Export User**. Import/Export User functionality is documented in "Exporting and Importing Users" on page 189. Add/Remove User functionality is straightforward.

If you click **Adds a new user to OmniPass** you will start the OmniPass Enrollment Wizard. The Enrollment Wizard is documented in "User Enrollment" on page 181.

If you click **Removes a user from OmniPass**, OmniPass will prompt you to authenticate. Authenticate with the credentials (or enrolled fingerprint) of the user you wish to remove. OmniPass will prompt you to confirm user removal. Click **OK** to complete user removal.



REMOVING A USER WILL AUTOMATICALLY DESTROY ALL OMNIPASS DATA ASSOCIATED WITH THAT USER. ALL IDENTITIES AND CREDENTIALS ASSOCIATED WITH THE USER WILL BE LOST.

IF YOU'RE SURE YOU WANT TO REMOVE THE USER, WE RECOMMEND YOU EXPORT THE USER PROFILE.

## User Settings

The User Settings tab has four interfaces: **Audio Settings**, **Taskbar Tips**, and **Enrollment**. User settings allow users to customize OmniPass to suit their individual preferences. Under **User Settings (Audio Settings and Taskbar Tips)** you can set how OmniPass notifies the user of OmniPass events (e.g., successful login, access denied, etc.). The details of each setting under the **Audio Settings** and **Taskbar Tips** interfaces are self-explanatory.

The **Enrollment** interface allows you to enroll fingerprints. For the procedure to enroll and authentication device refer to *Chapter 2.3*. To enroll additional fingerprints, click **Enroll Authentication Device**, and authenticate with OmniPass. Select the fingerprint recognition device in the **Select Authentication Device** screen (it should already be marked by a green check if you have a finger enrolled) and click **Next**.

## System Settings

The OmniPass **Startup Options** interface can be found in the System Settings tab. With these options you can specify how your OmniPass Logon is tied to your Windows Logon.

The first option, **Automatically log on to OmniPass as the current user**, will do just as it says; during Windows login, you will be logged on to OmniPass using your Windows login credentials. If the user logging into Windows was never enrolled into OmniPass, upon login no one will be logged on to OmniPass. This setting is appropriate for an office setting or any setting where users must enter a username and password to log into a computer. This is the default setting.

With the second option, **Manually log on to OmniPass at startup**, OmniPass will prompt you to login once you have logged on to Windows.

With the third option, **Do not log on to OmniPass at startup**, OmniPass will not prompt for a user to be logged on.

You can manually log on to OmniPass by right-clicking the OmniPass taskbar icon and clicking **Log in User** from the right-click menu.



## Troubleshooting

You cannot use OmniPass to create Windows users. You must first create the Windows user, and you will need administrative privileges to do that. Once the Windows user is created, you can add that user to OmniPass using the same username and password

### Cannot add Windows users to OmniPass

If you experience difficulties adding a Windows user to OmniPass, you may need to adjust your local security settings. You can do this by going to **Start, Control Panel, Administrative Tools, and Local Security Settings**. Expand **Local Policies**, expand **Security Options**, and double-click **Network Access: Sharing and Security Model for Local Accounts**. The correct setting should be *Classic - Local Users Authenticate as Themselves*.

### Cannot add a User with a Blank Password to OmniPass

If you experience difficulties adding a user with a blank password to OmniPass, you may need to adjust your local security settings. First attempt the procedure explained in the *Cannot add Windows user to OmniPass* section. If the difficulties persist, then try the following procedure.

Click **Start, Control Panel, Administrative Tools, and Local Security Settings**. Expand **Local Policies**, expand **Security Options**, and double-click **Accounts: Limit local account use of blank passwords to console login only**. This setting should be set to Disabled.

### Dialog appears after OmniPass authentication during Windows Logon

After installing OmniPass on your system, you can choose to logon to Windows using OmniPass. You authenticate with OmniPass (via master password, or an enrolled security device) and OmniPass logs you into Windows. You may, during this OmniPass authentication, see a **Login Error** dialog box.

This dialog box occurs when OmniPass was unable to log you into Windows with the credentials supplied (username and password). This could happen for any of the following reasons:

- Your Windows password has changed
- Your Windows account has been disabled

If you are having difficulties due to the first reason, you will need to update OmniPass with your changed Windows account password. Click **Update Password** and you will be prompted with a dialog to reconfirm your password.

Enter the new password to your Windows user account and click **OK**. If the error persists, then it is unlikely the problem is due to your Windows user account password changing.

# Index

---

## A

About This Guide 13  
AC  
    adapter 68  
    indicator 31  
    plug adapters 132  
Active Digitizer 47  
Air Vents 27, 29  
Anti-theft lock slot 26  
Auto/Airline Adapter 68, 69  
Automatically Downloading Driver Updates 125

## B

Battery 82  
    care 132  
    cold-swapping 85  
    conserving power 77  
    dead 112  
    faulty 113  
    hot-swapping 85  
    increasing life 133  
    level indicator 31  
    lithium ion battery 82  
    low 84  
    problems 112, 113  
    recharging 83  
    replacing 85  
    shorted 85  
    Standby mode 84

Battery Latches 29  
BIOS  
    guide 73  
    setup utility 72  
Bluetooth  
    Where to Find Information 177  
Boot Sequence 71  
Booting the System 73  
Built-in Speakers 108  
Button Icons 57, 60

## C

CapsLock 32  
CD-ROM 108, 109  
Click Me! 75  
Cold-swapping 55  
Configuration Label 135  
Contact Information 14  
Controls and Connectors 17  
Conventions Used in the Guide 13  
Cursor Keys 40

## D

DC in connector 17  
DC Output Cable 68  
DC Power Jack 68  
Device Ports 100  
DIMM 91

- Display Panel 20, 33
  - brightness 37
  - opening 33
  - problems 114, 115
- Dock port 17
- Docking Port 100
- Double-Clicking 43
- Dragging 43, 45
- Drivers and Application Restore CD 121
- Dual Built-in Microphones 22
- DVD drive
  - problems 108, 109
- E**
- Error Messages 117
- ExpressCard
  - problems 111
- ExpressCard Eject Button 24
- ExpressCard Slot 24
- ExpressCards 89
  - installing 89
  - removing 90
- External Monitor Port 103
- External Video Port 28
- External Video port 18
- F**
- FDU 76, 125, 144
- Fingerprint Sensor 22
- Fingerprint Sensor Device 179
  - enrolling a fingerprint 184
  - getting started 180
  - installing OmniPass 180
  - logging into a remembered site 188
  - OmniPass authentication toolbar 186

- password replacement 185
- remembering a password 186
- uninstalling OmniPass 182
- user enrollment 183
- using OmniPass 185
- Fujitsu Contact Information 14
- Fujitsu Driver Update utility 76, 125, 144
- Fujitsu LifeBook
  - storing 130
  - traveling 131
- Fujitsu Shopping Online 15
- Function Key
  - F10 41
  - F3 41
  - F4 41
  - F6 41
  - F7 41
  - F8 41, 53
  - F9 41, 53
  - FN 40

- G**
- Gigabit LAN (RJ-45) Jack 27
- Glossary 146

- H**
- Hard Disk Drive
  - access indicator 31
  - problems 109, 110
- Hard Disk Drive Passwords 72
- Headphone Jack 17, 102
- Hibernation Feature 79
  - disable/enable 79

## I

IEEE 1394 (4-pin) Jack 21  
IEEE 1394 Port 101  
Internal LAN Jack 100

## K

Keyboard 21, 39  
    cursor keys 39  
    function keys 40  
    numeric keypad 39  
    problems 110  
    windows keys 40

## L

LifeBook Security Panel  
    operating 64  
    passwords 62  
    setting up 62  
    uninstalling 65  
LifeBook Security/Tablet PC Buttons 56  
LifeBook SecurityTablet PC Buttons 20  
Lithium ion Battery Bay 29  
Local Area Network (LAN) 18

## M

Media Player  
    battery power 99  
    care 134  
    Control Panel 98  
    loading 95  
    removing 97  
    Software 94, 97  
    using 99  
Memory

    capacity 93  
    checking capacity 93  
    compartment 28, 91  
    installing 91  
    problems 110  
    upgrade module 91

Memory Stick  
    installing 88  
    removing 88  
Memory Stick/Secure Digital Cards 87  
Microphone Jack 17, 23, 103  
Modular Bay 54  
    cold-swapping 55  
    devices 54  
    installing 55  
    removing 55  
Modular Devices 55  
    installing 55  
    removing 55  
Mouse  
    problems 110

## N

NumLk 32

## O

Optical Drive 94  
    Modular Multi-Format DVD Writer 94  
    tray release 97

## P

Pen  
    installing a pen tether 52  
Pen tether 52

- Pen Tether Attachment Point 25
- Port Replicator
  - connector 29
  - problems 109
- Post-logon button functions 59
- Power
  - AC adapter 68
  - Auto/Airline adapter 68
  - failure 111, 112
  - indicator 30
  - management 77
  - off 80
  - on 70
  - problems 113
  - sources 68
- Power Management 77
- Power On Self Test 71, 117
- Power/Suspend/Resume Button 20, 77
- Pre-Installed Software 142
  - Adobe Acrobat Reader 143
  - Google Toolbar 143, 144
  - manuals 143
- Pre-logon button functions 57

**R**

- Registration 75
- Regulatory Information 162
- Restarting 79
- Restoring Your Pre-installed Software 121

**S**

- ScrLk 32
- Scrolling 46
- SD Card
  - installing 88
  - removing 88

- SD/Memory Stick Slot 17
- SDRAM 28, 91
- Secure Digital Card
  - removing 88
- Security Buttons
  - Functions 56
- Security lock slot 18
- Specifications 135
  - Audio 137
  - Chipset 136
  - Device Ports 139
  - Dimensions and Weight 141
  - Environmental Requirements 141
  - Keyboard 140
  - mass storage device options 137
  - Memory 136
  - Microprocessor 136
  - Power 140
  - Video 136
- Status Indicator Panel 20, 30
- Suspend/ Resume button 18

**T**

- Tablet Configuration 34
- Tablet PC Button Functions
  - changing 61
- Touch Screen
  - calibrating 50
  - clicking 48
  - dragging 49
- Touchpad
  - pointing device 22
  - scroll button 22
- Touchpad Control Adjustment 46
- Troubleshooting 105

## U

- Universal Serial Bus Ports 101
- USB 101, 110
- USB 2.0 Ports 26, 27
- USB Port 17
- Using the Optional Capacitive Touchscreen 51

## V

- Volume control 53

## W

- Warranty 15
- Windows keys 40
  - Application key 40
  - Start keys 40
- Windows Power Management 79
- Wireless LAN
  - Before Using the Wireless LAN 166
  - configuring 166
  - connection to the network 171
  - deactivating/disconnecting 169
  - modes 167
  - Specifications 174
  - Troubleshooting 172
- Wireless LAN On-Off Switch 18