

**802.11n40 (MIMO), HT8 – Chain B, CH7F**

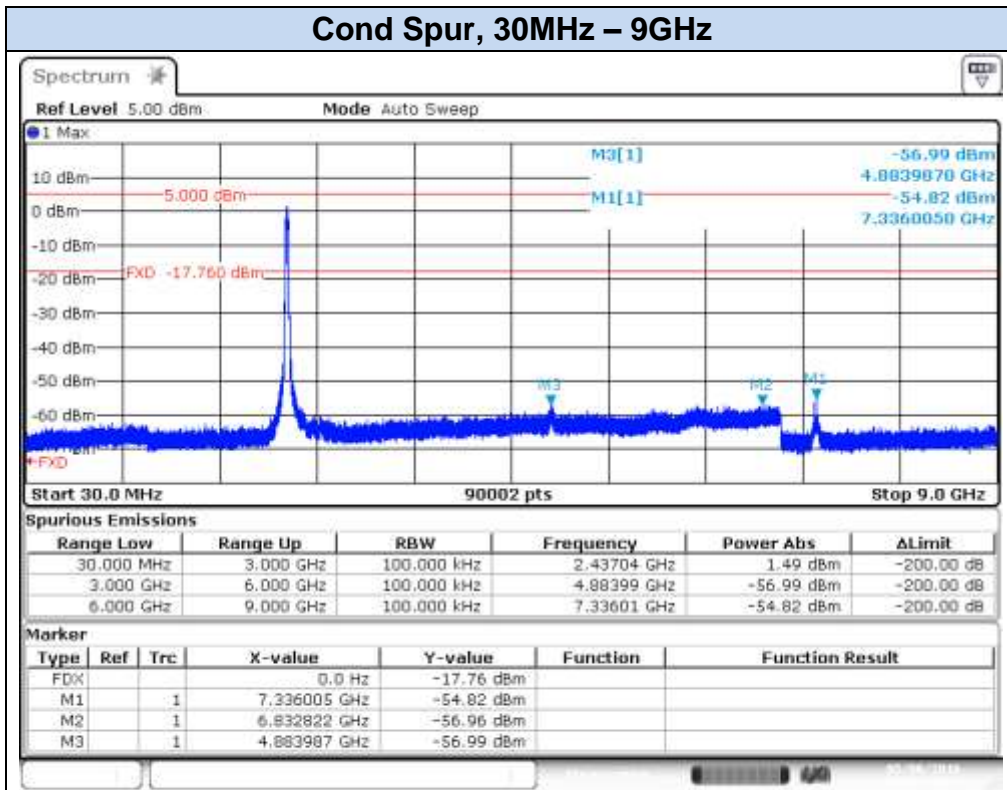

Date: 6 MAY 2016 18:46:22

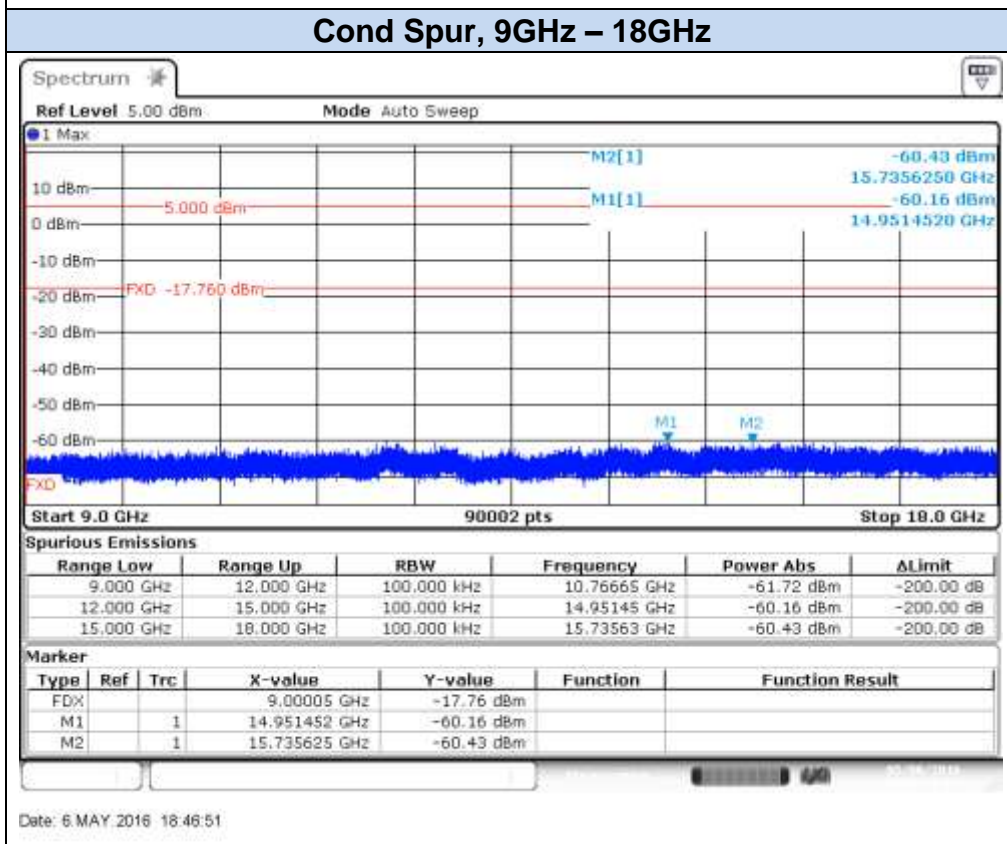

Date: 6 MAY 2016 18:46:51

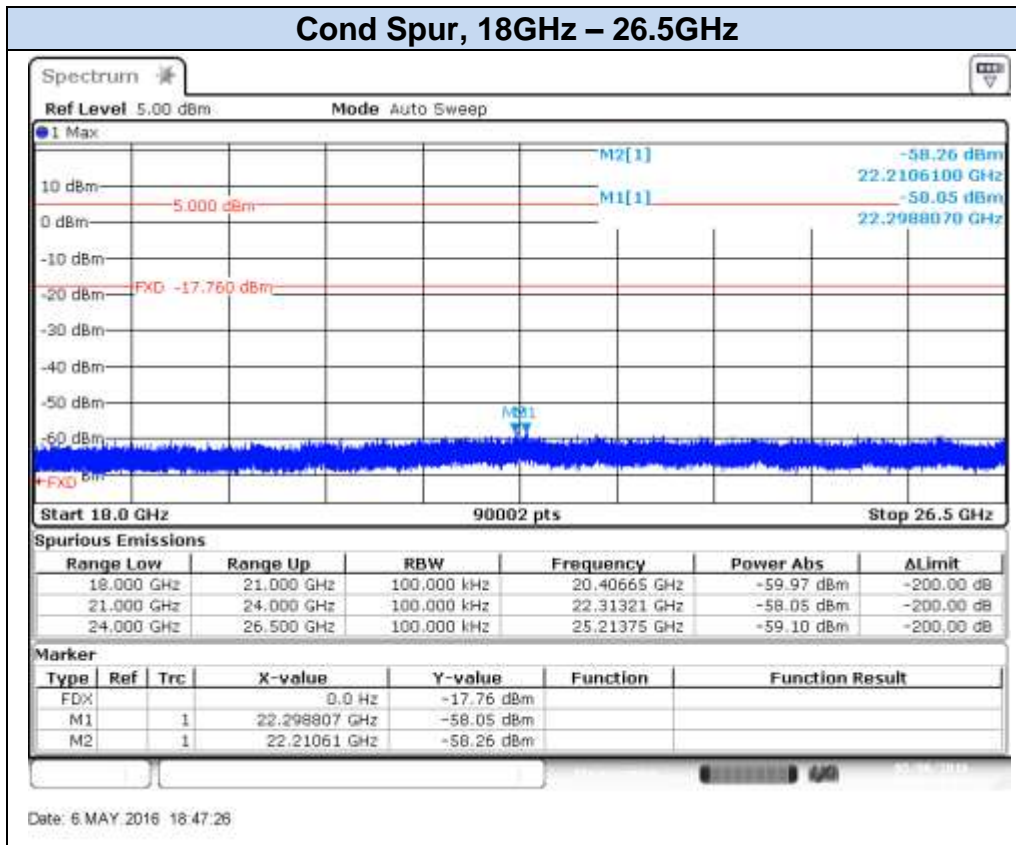

## 802.11n40 (MIMO), HT8 – Chain B, CH9F

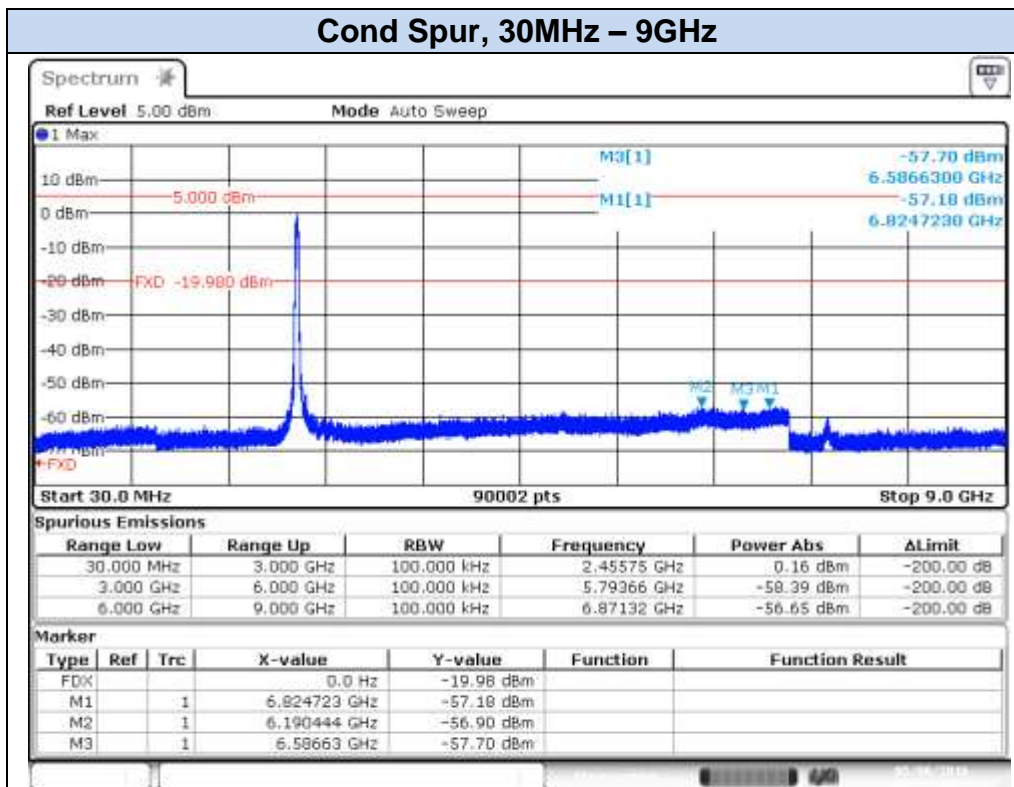

Date: 6 MAY 2016 18:37:12

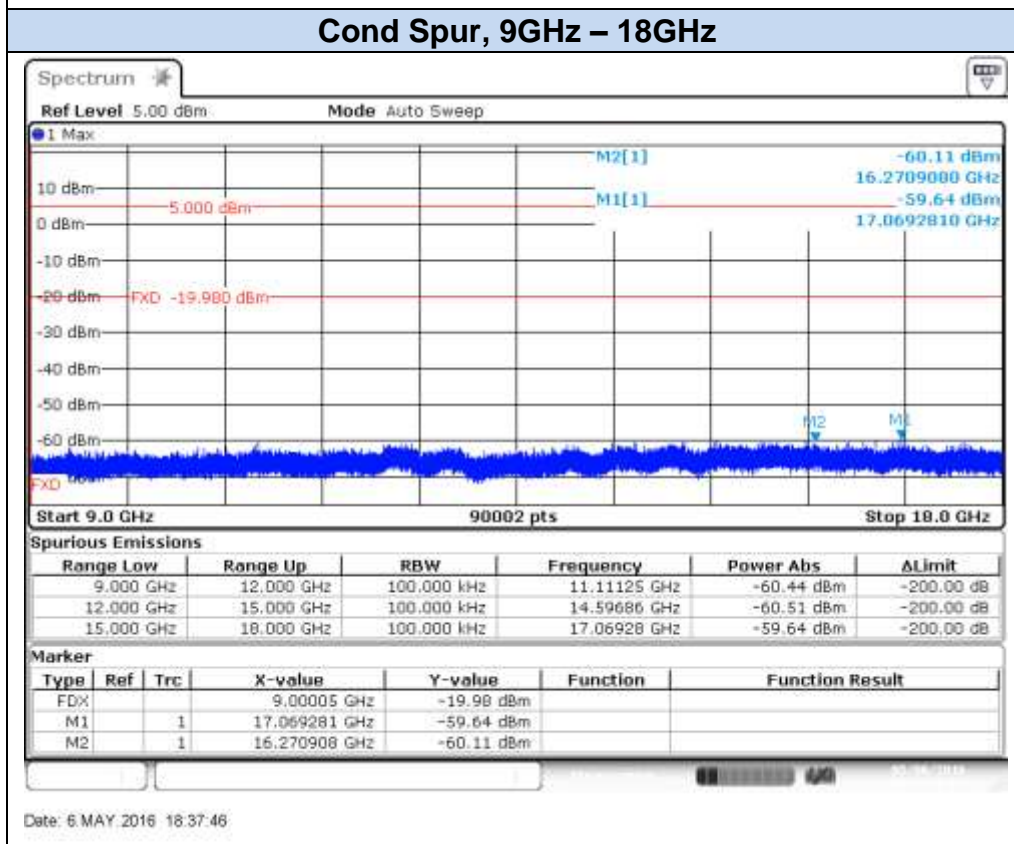

Date: 6 MAY 2016 18:37:46

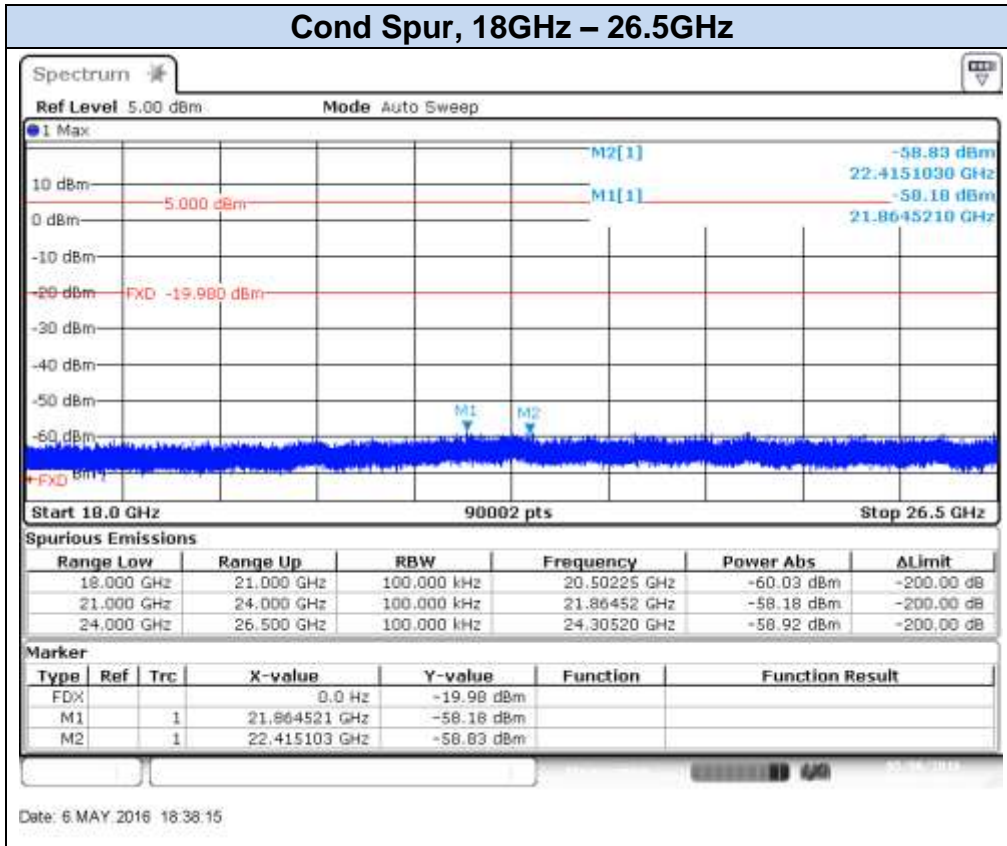

**802.11n40 (MIMO), HT8 – Chain B, CH10F**

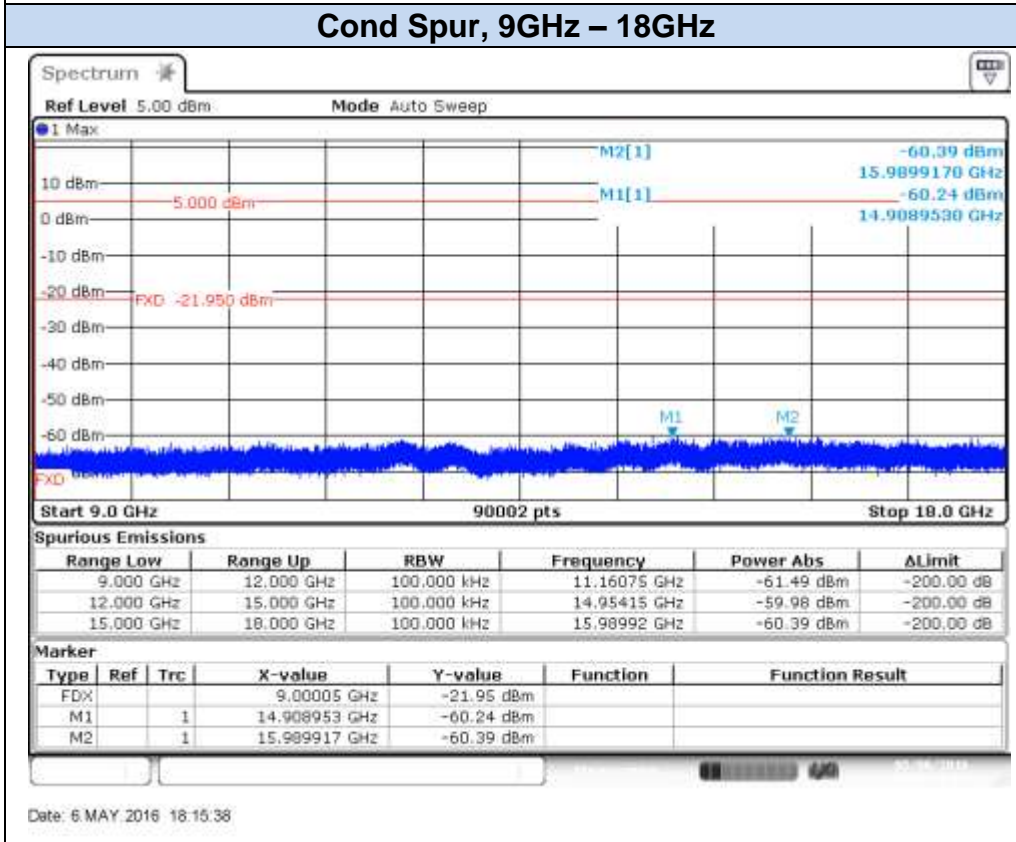
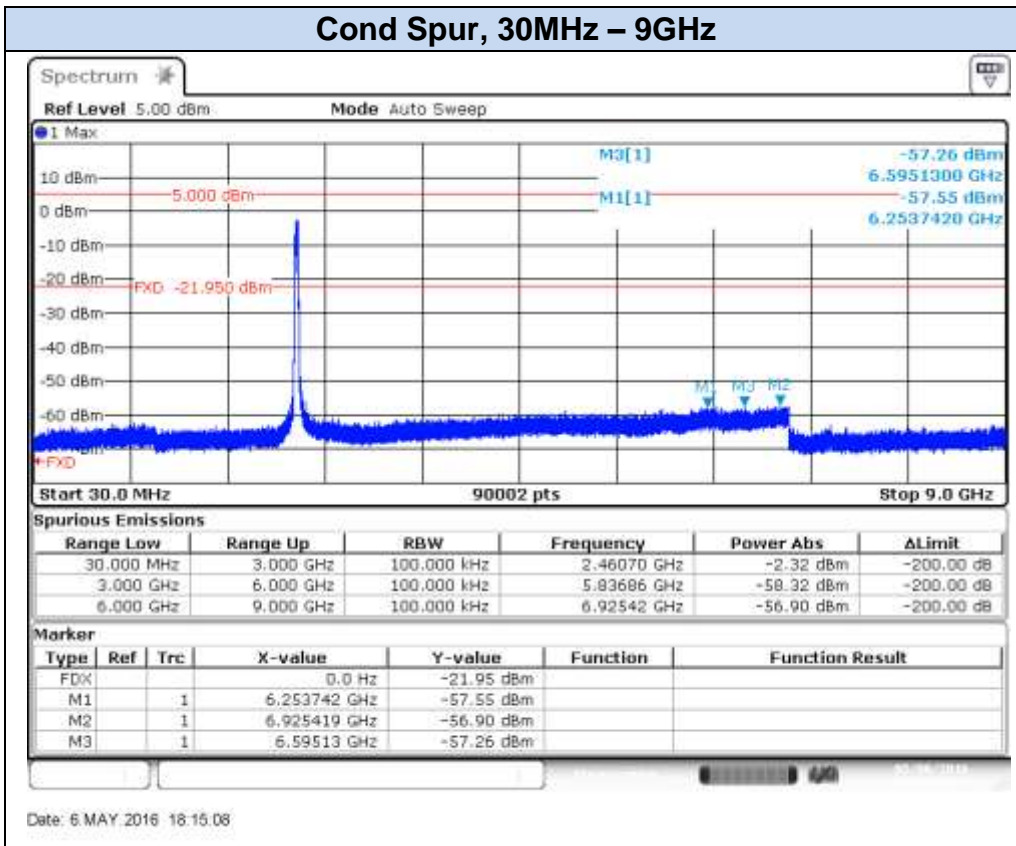

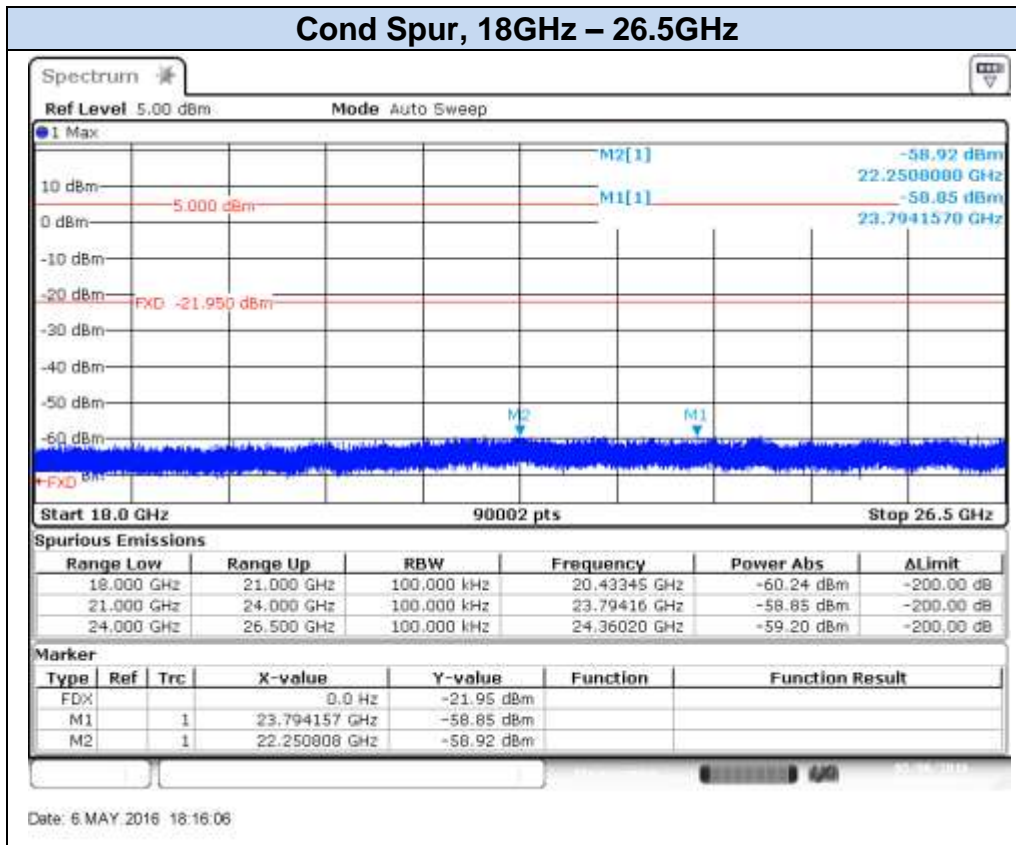

**802.11n40 (MIMO), HT8 – Chain B, CH11F**

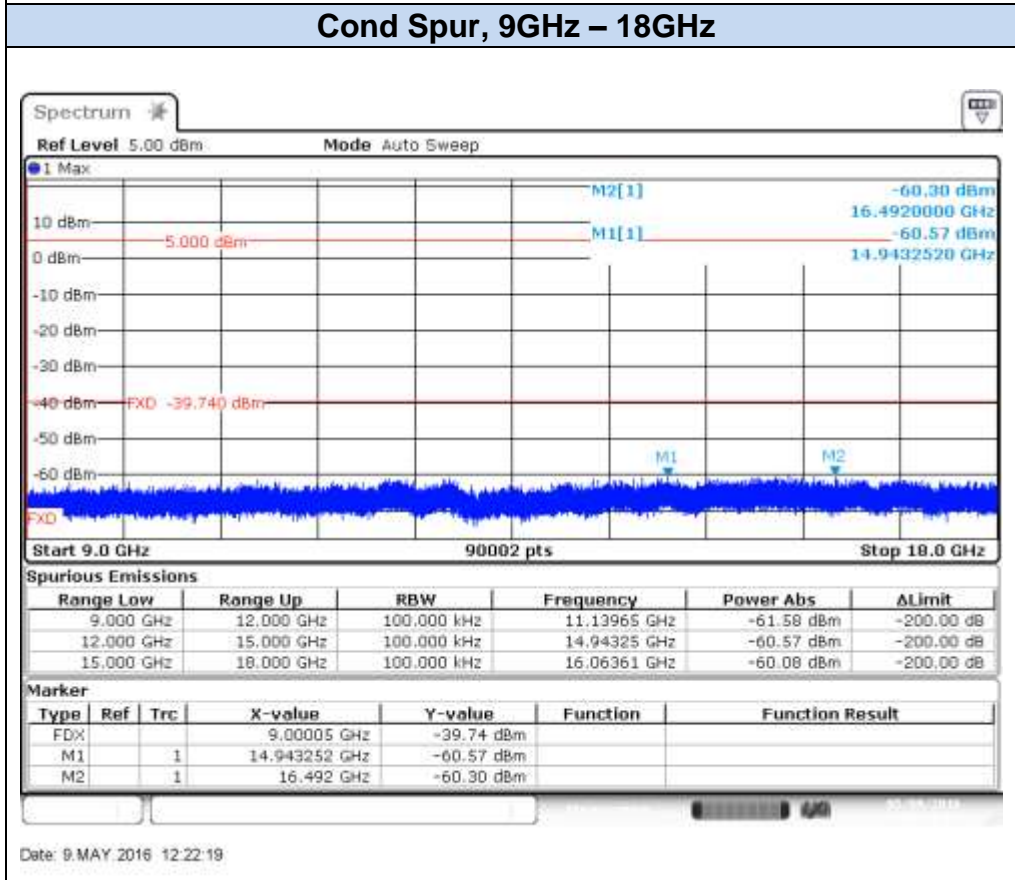
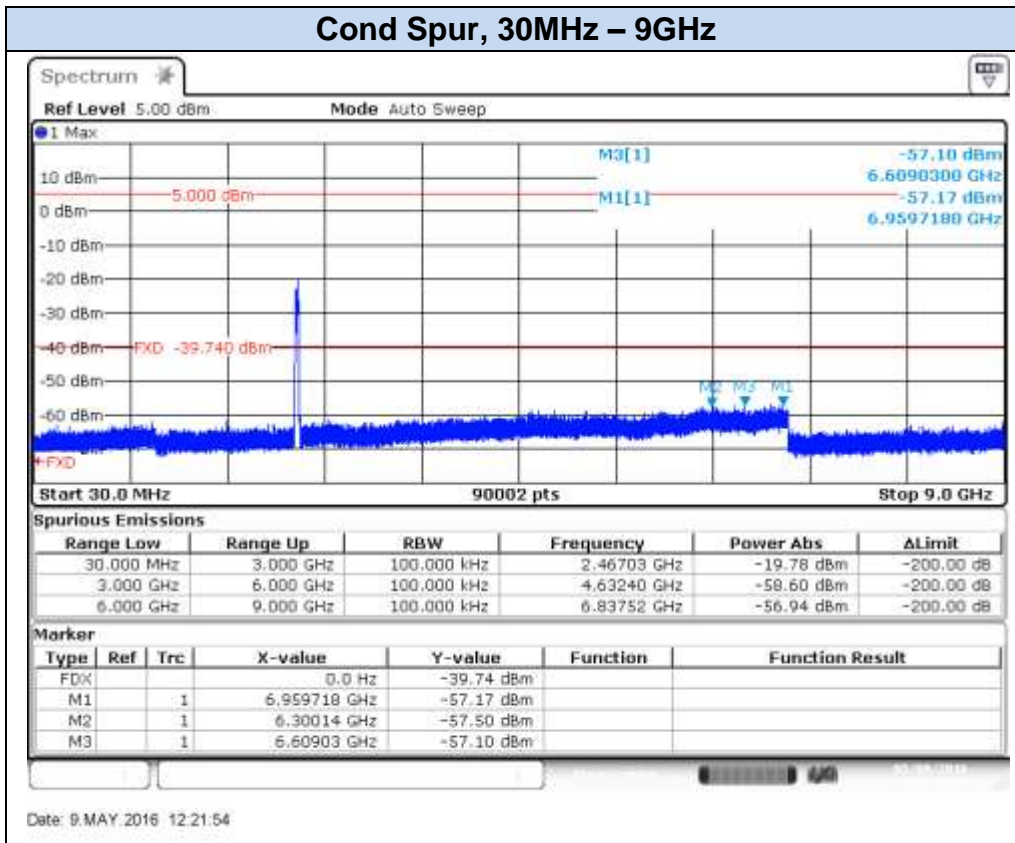



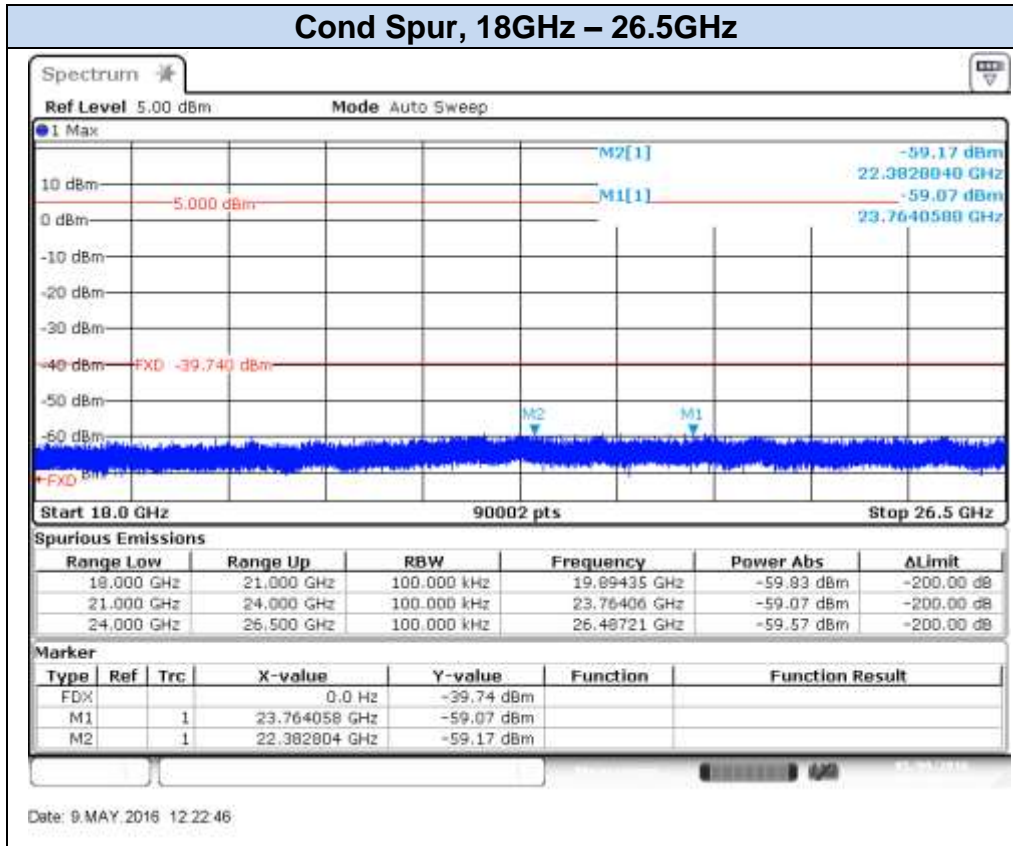

## B.4 Power Spectral Density

### Test limits:

FCC part	RSS part	Limits
15.247 (e)	RSS-247 Clause 5.2 (2)	For digitally modulated systems, the power spectral density conducted from the intentional radiator to the antenna shall not be greater than 8 dBm in any 3 kHz band during any time interval of continuous transmission. This power spectral density shall be determined in accordance with the provisions of paragraph (b) of this section. The same method of determining the conducted output power shall be used to determine the power spectral density.

### Test procedure:

The peak power spectral density level in the fundamental emission was measured using the *Method PKPSD (peak PSD)* according to point 10.2 of KDB 558074 D01 DTS Meas Guidance. This method was used for 802.11b, 802.11g, 802.11n20 and 802.11n40 modes.

For MIMO mode, the *Measure and add  $10 \log(N_{ANT})$  dB*, (where  $N_{ANT}$  is the number of outputs) technique was used according to the Guidance for Emission Testing of Transmitters with Multiple Outputs in the Same Band 662911 D01 Multiple Transmitter Output v02r01.

With this technique, spectrum measurements are performed at each output of the device, and the quantity  $10 \log(N_{ANT})$  dB is added to each spectrum value before comparing to the emission limit. Number of outputs = 2.

The setup below was used to measure the power spectral density. The antenna terminal of the EUT is connected to the spectrum through an attenuator, and the spectrum analyzer reading is compensated to include the RF path loss.

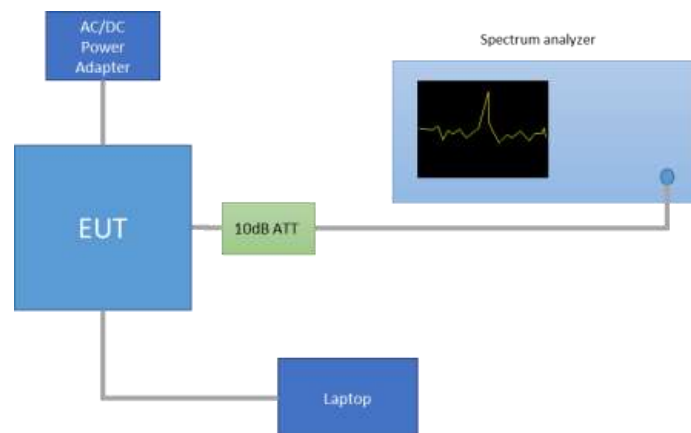

**Results tables:**

Mode	Rate	Measured Duty Cycle [%]	Channel	Frequency [MHz]	Antenna	PSD Peak [dBm]			
802.11b	1Mbps	97.4	1	2412	SISO CHAIN A	-6.37			
					SISO CHAIN B	-6.47			
			7	2442	SISO CHAIN A	-4.58			
					SISO CHAIN B	-4.53			
			11	2462	SISO CHAIN A	-6.11			
					SISO CHAIN B	-5.60			
			12	2467	SISO CHAIN A	-10.27			
					SISO CHAIN B	-9.37			
			13	2472	SISO CHAIN A	-16.89			
					SISO CHAIN B	-16.18			
			802.11g	6Mbps	98.1	1	2412	SISO CHAIN A	-7.13
								SISO CHAIN B	-6.55
7	2442	SISO CHAIN A				-4.84			
		SISO CHAIN B				-3.38			
11	2462	SISO CHAIN A				-7.08			
		SISO CHAIN B				-5.97			
12	2467	SISO CHAIN A				-11.86			
		SISO CHAIN B				-15.01			
13	2472	SISO CHAIN A				-27.16			
		SISO CHAIN B				-26.61			
802.11n20	HT0	96.7				1	2412	SISO CHAIN A	-6.58
								SISO CHAIN B	-7.24
			7	2442	SISO CHAIN A	-2.94			
					SISO CHAIN B	-2.52			
			11	2462	SISO CHAIN A	-7.81			
					SISO CHAIN B	-5.90			
			12	2467	SISO CHAIN A	-11.18			
					SISO CHAIN B	-10.72			
			13	2472	SISO CHAIN A	-27.18			
					SISO CHAIN B	-26.33			
			802.11n40	HT0	97.4	3F	2422	SISO CHAIN A	-8.77
								SISO CHAIN B	-6.32
7F	2442	SISO CHAIN A				-6.49			
		SISO CHAIN B				-5.88			
9F	2452	SISO CHAIN A				-6.48			
		SISO CHAIN B				-7.06			
10F	2457	SISO CHAIN A				-10.19			
		SISO CHAIN B				-10.27			
11F	2462	SISO CHAIN A				-26.03			
		SISO CHAIN B				-25.41			

MIMO modes						PSD Peak [dBm]	
Mode	Rate	Meas. Duty Cycle [%]	CH	Freq. [MHz]	Antenna	Measured Conducted	MIMO Compensated +10·log(N <sub>ant</sub> )
802.11n20	HT8	97.0	1	2412	CHAIN A	-8.62	-5.62
					CHAIN B	-8.88	-5.88
			7	2442	CHAIN A	-6.32	-3.32
					CHAIN B	-4.66	-1.66
			11	2462	CHAIN A	-8.31	-5.31
					CHAIN B	-8.26	-5.26
			12	2467	CHAIN A	-14.47	-11.47
					CHAIN B	-15.61	-12.61
			13	2472	CHAIN A	-30.07	-27.07
					CHAIN B	-31.11	-28.11
802.11n40	HT8	97.2	3F	2422	CHAIN A	-9.11	-6.11
					CHAIN B	-7.80	-4.80
			7F	2442	CHAIN A	-6.59	-3.59
					CHAIN B	-6.07	-3.07
			9F	2452	CHAIN A	-8.35	-5.35
					CHAIN B	-8.95	-5.95
			10F	2457	CHAIN A	-11.46	-8.46
					CHAIN B	-10.63	-7.63
			11F	2462	CHAIN A	-28.14	-25.14
					CHAIN B	-28.28	-25.28

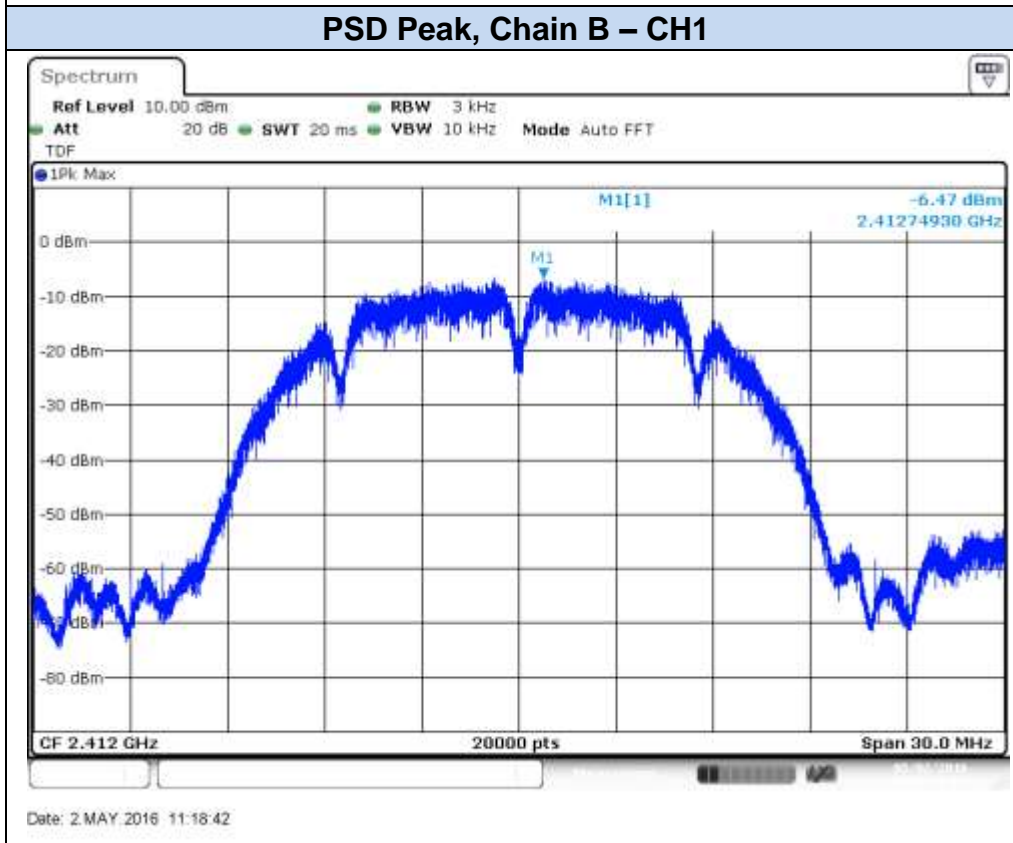
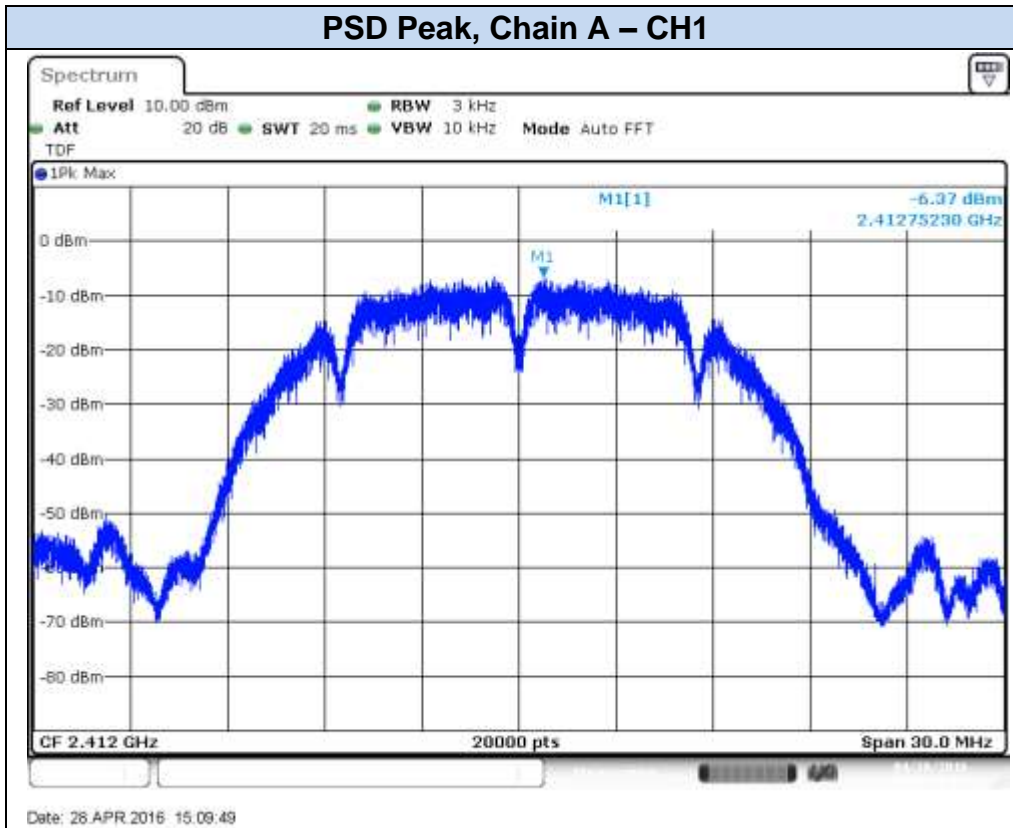
**Results screenshot:****802.11b, 1Mbps**

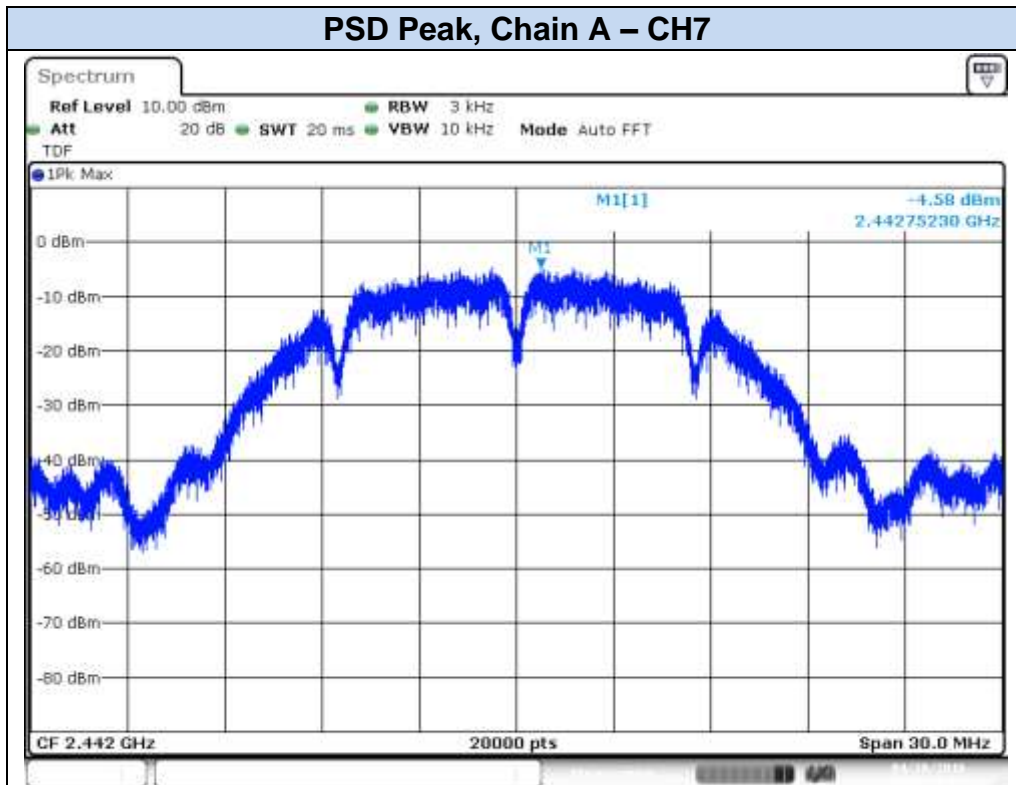

Date: 26 APR 2016 15:19:48

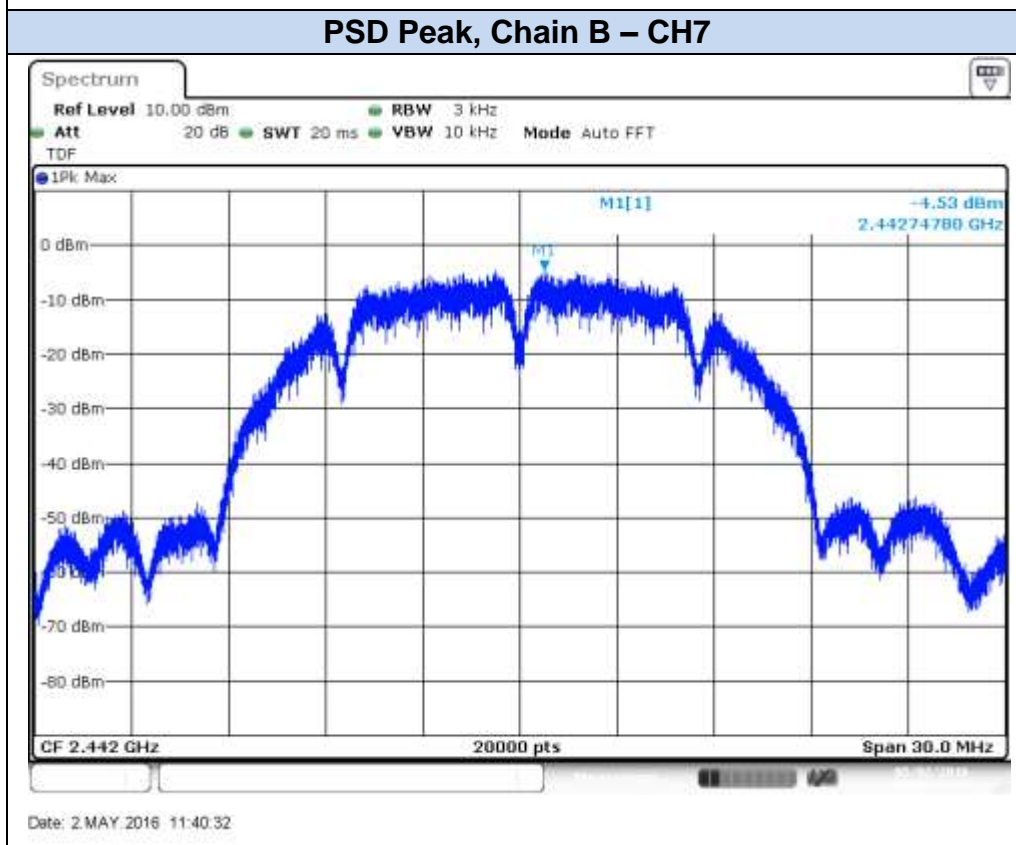

Date: 2 MAY 2016 11:40:32

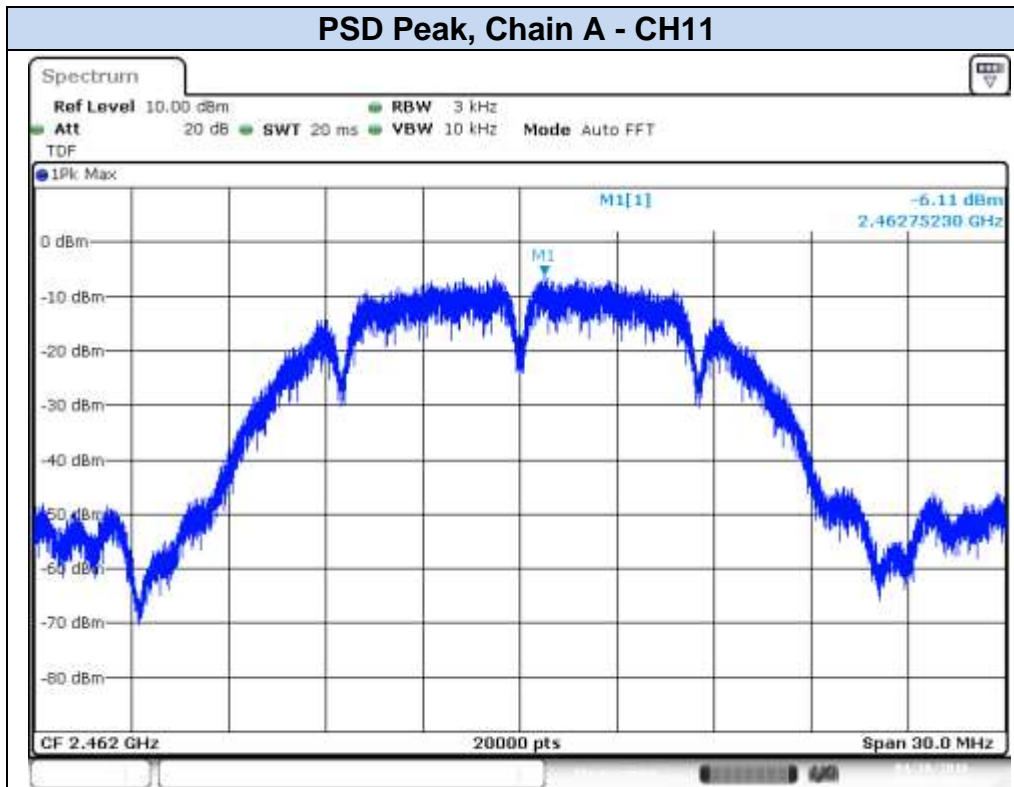

Date: 28 APR 2016 15:45:44

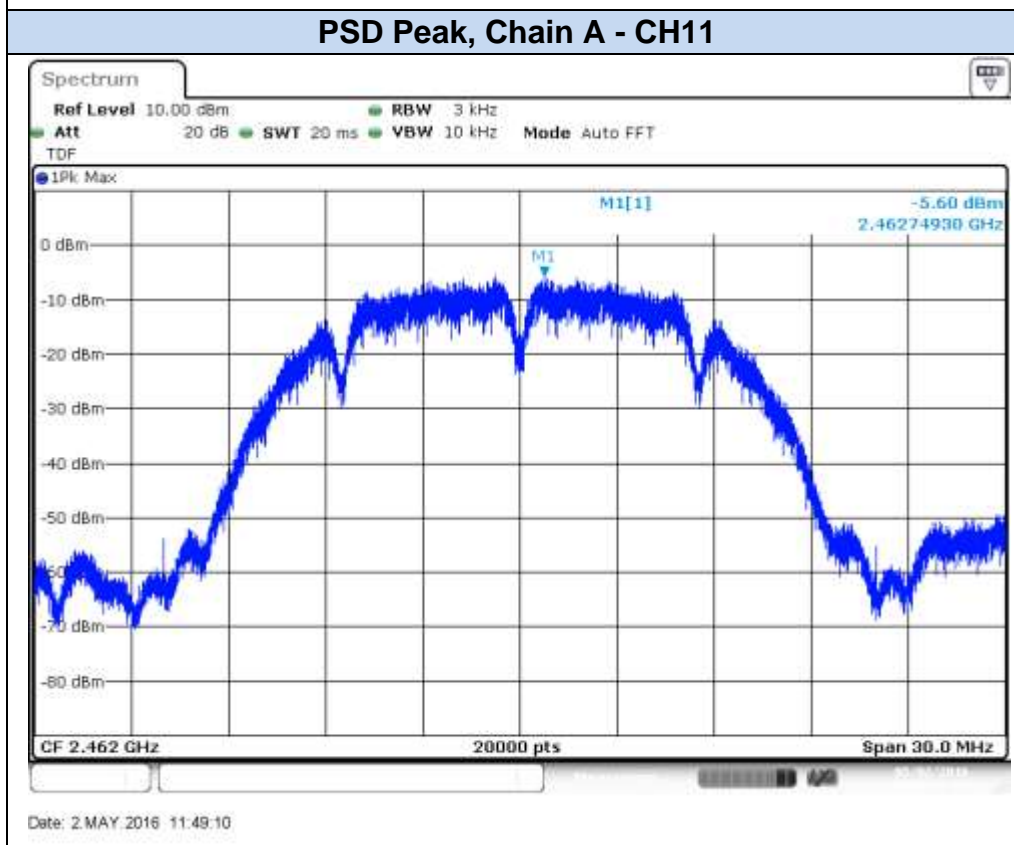

Date: 2 MAY 2016 11:49:10

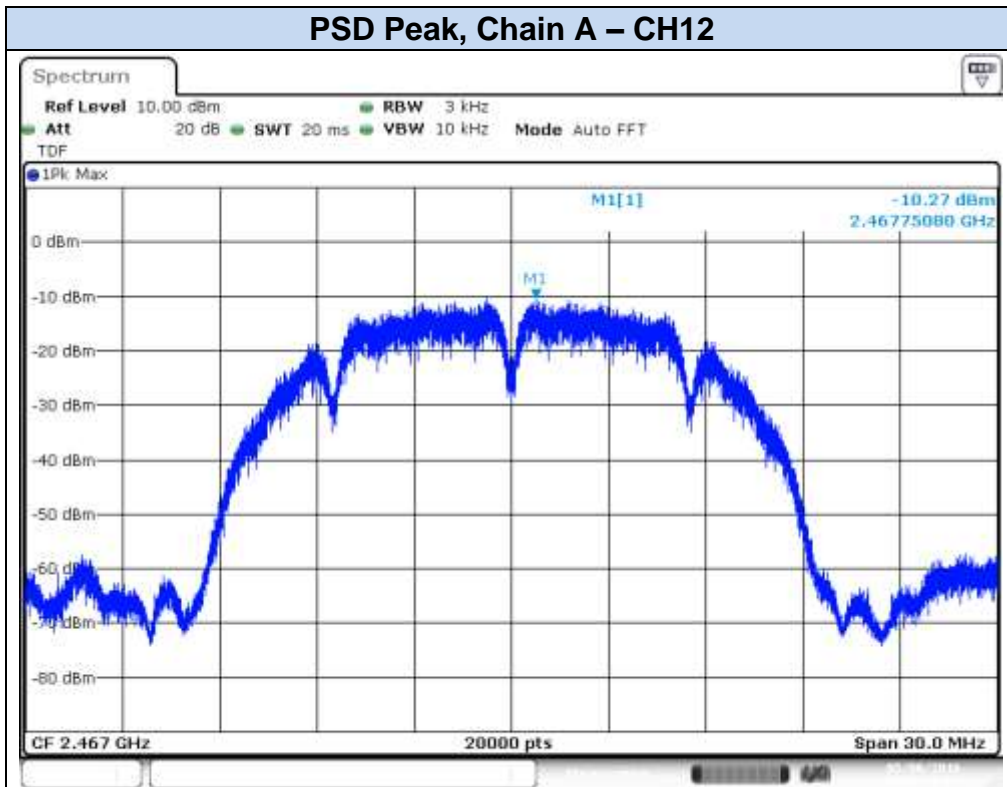

Date: 6 MAY 2016 16:03:46

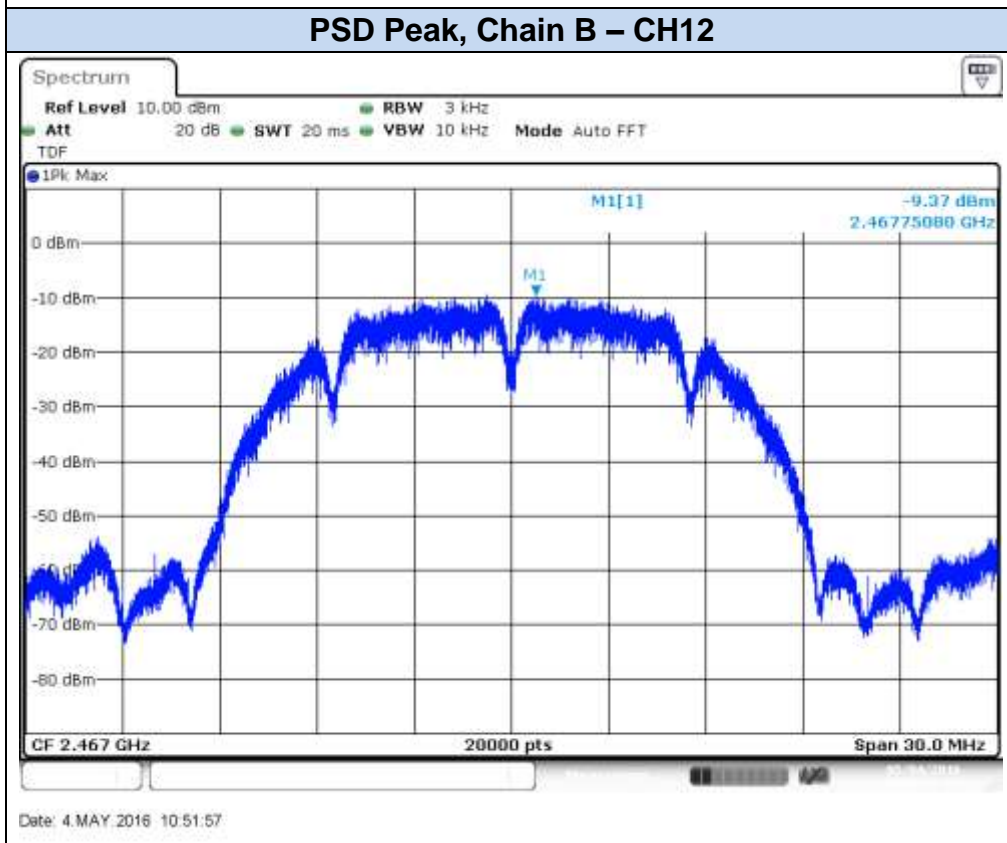

Date: 4 MAY 2016 10:51:57



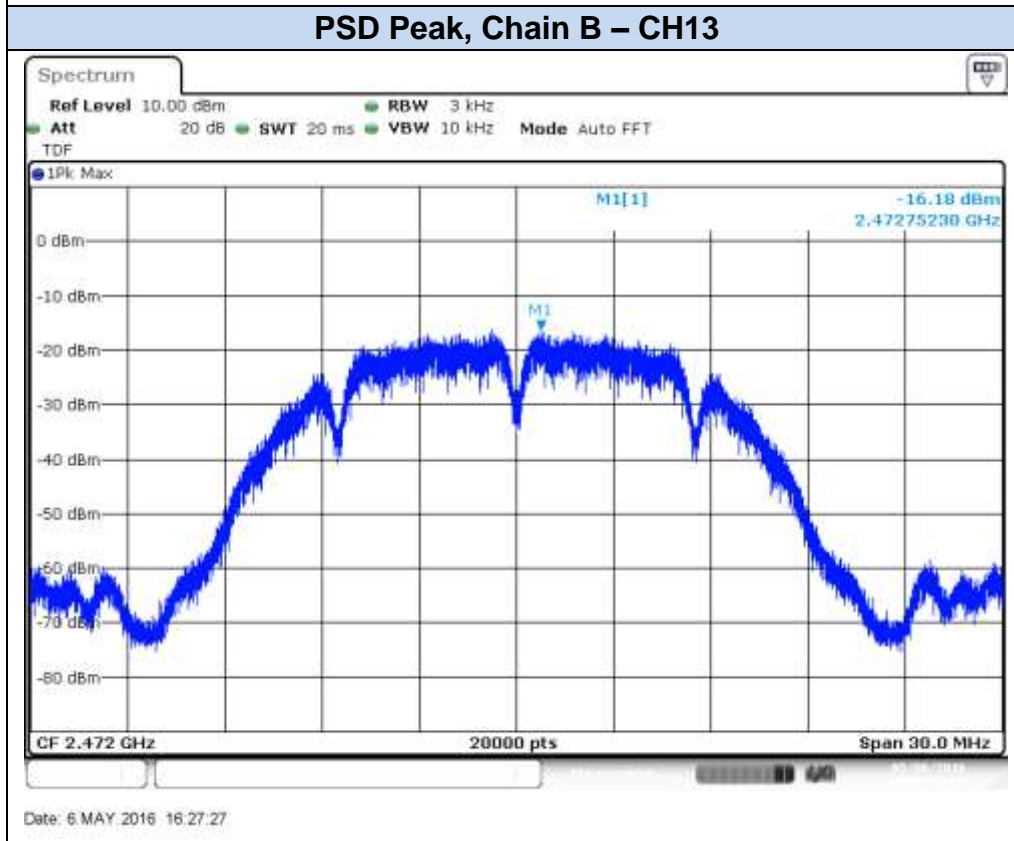
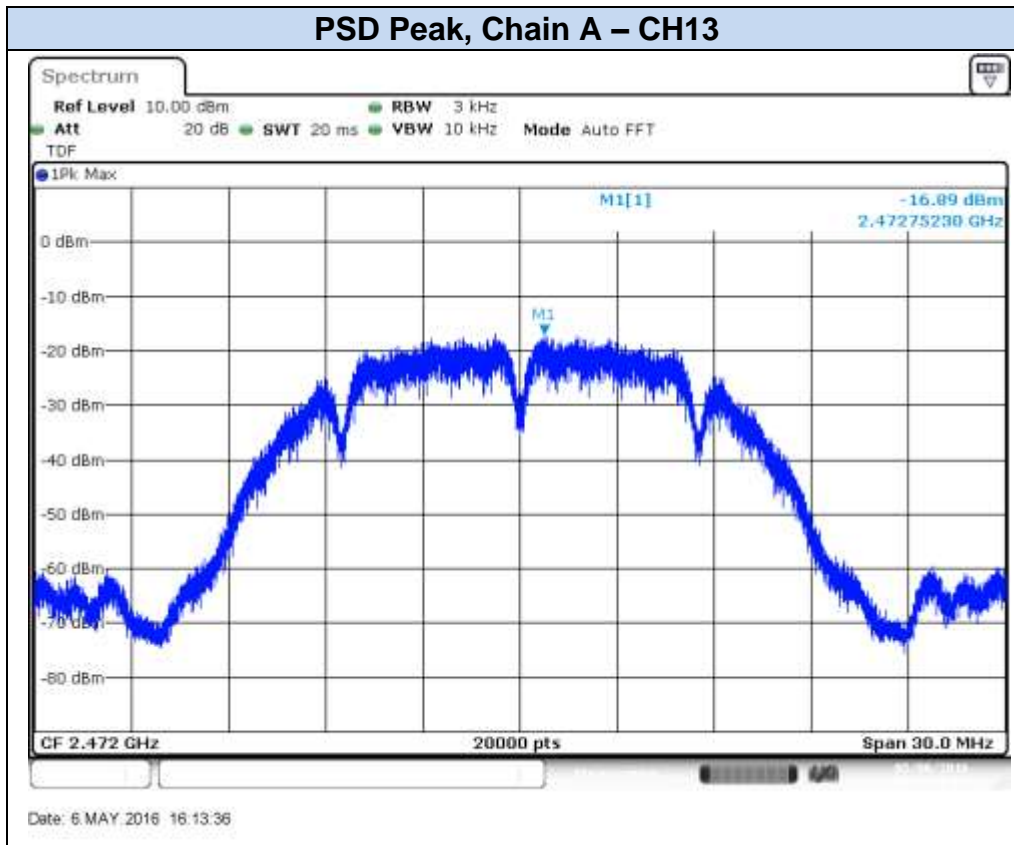

### 802.11g, 6Mbps

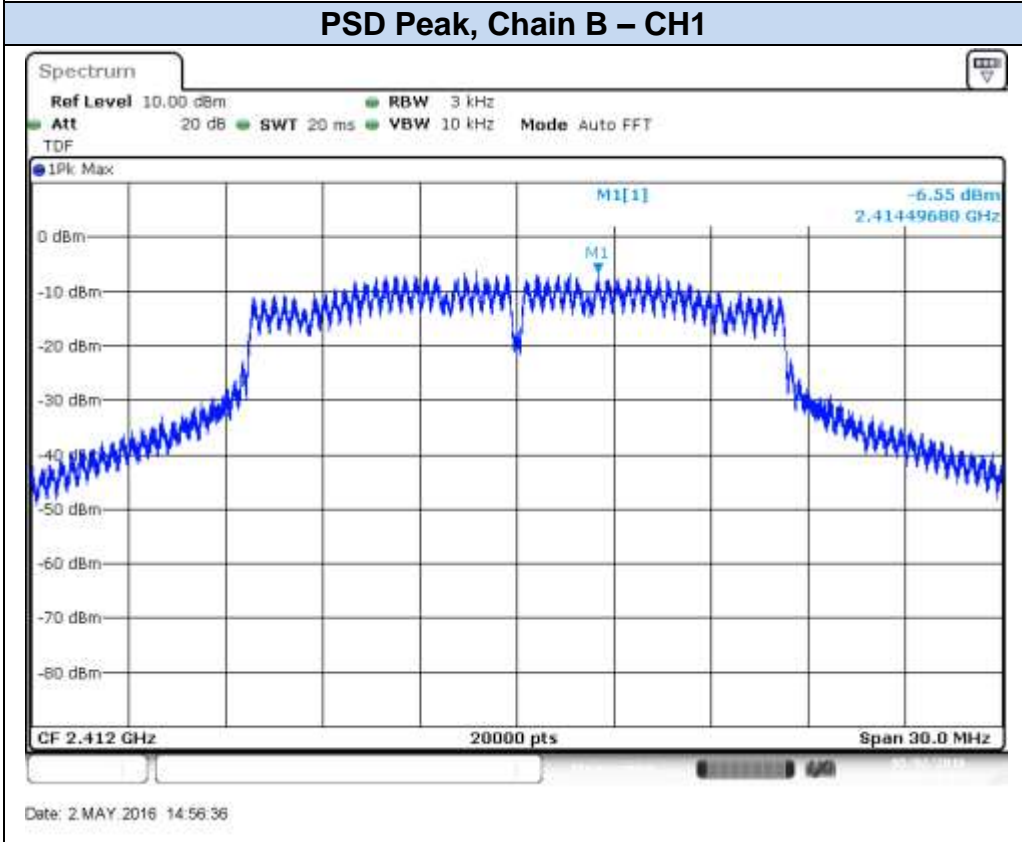
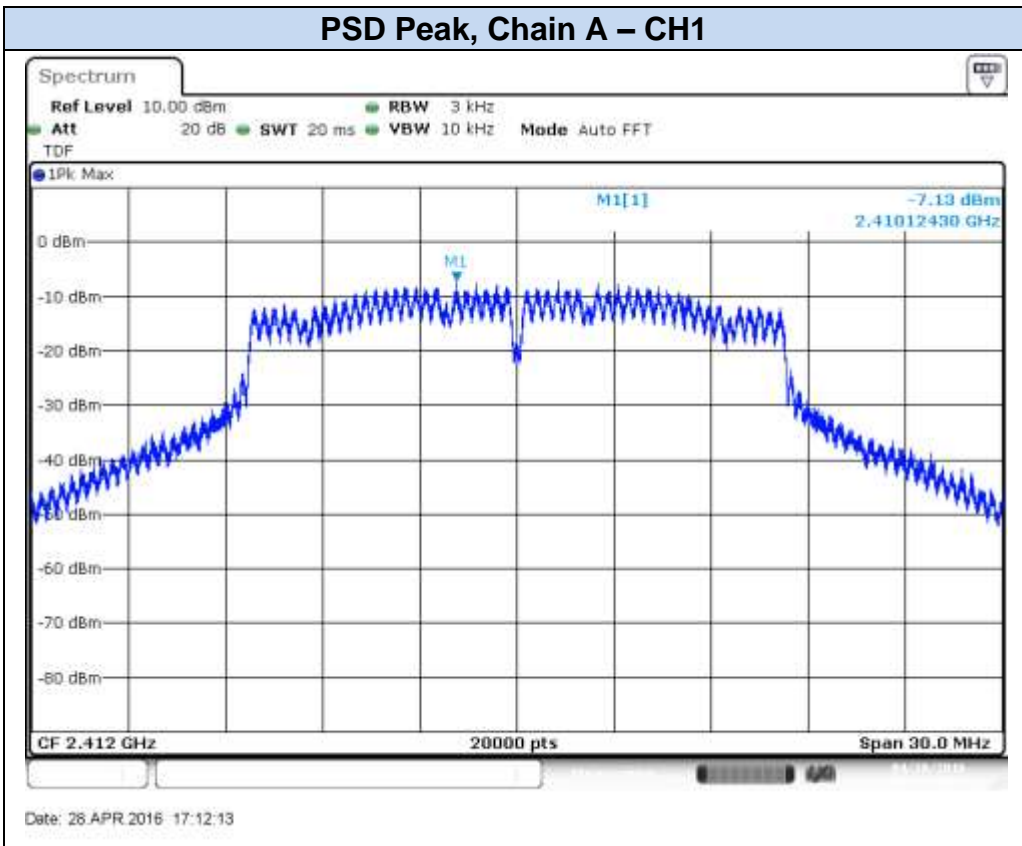

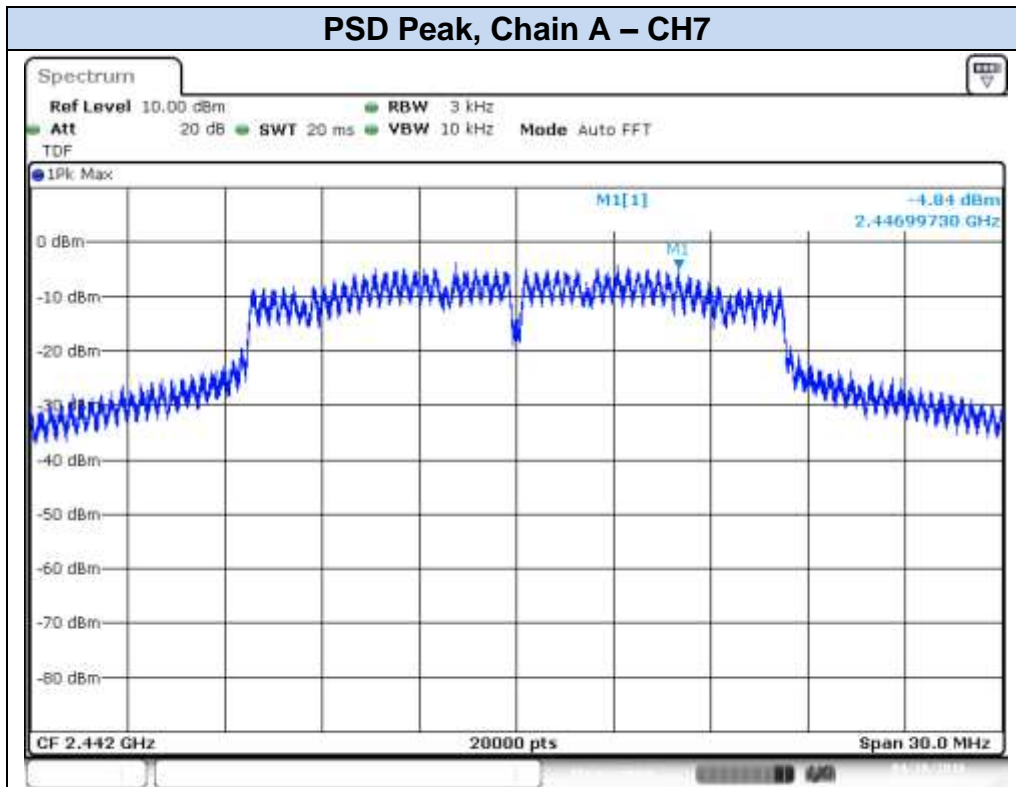

Date: 28 APR 2016 17:25:07

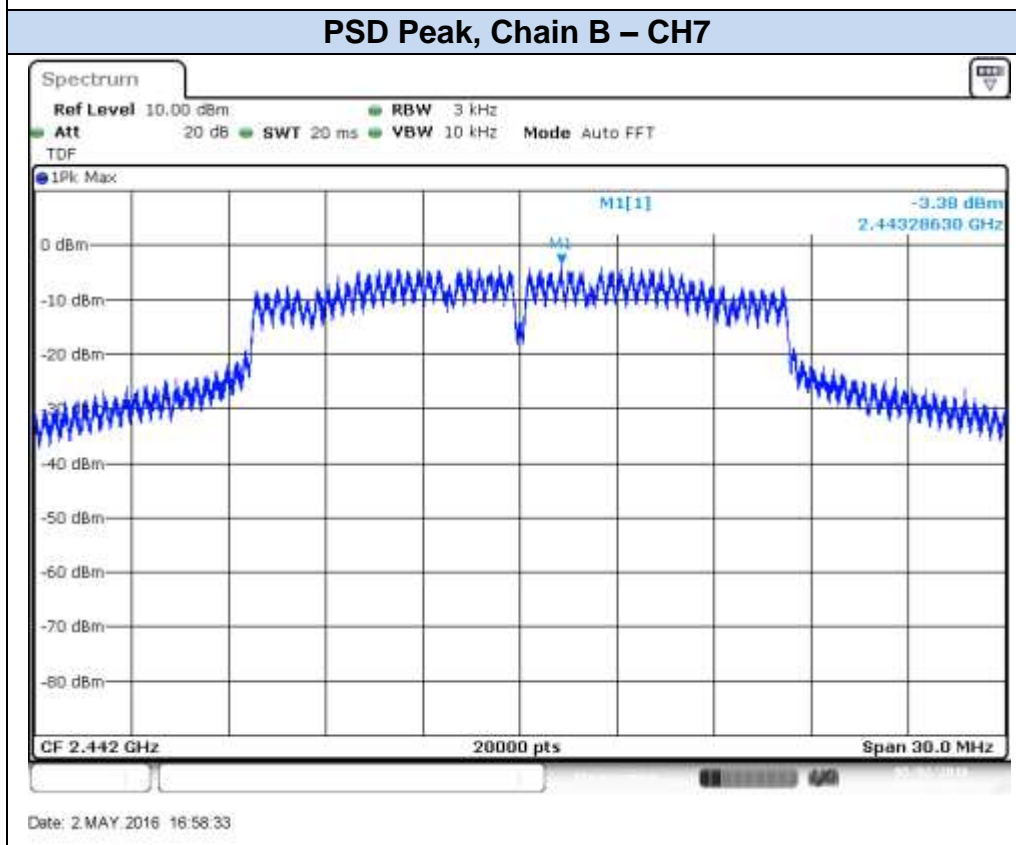

Date: 2 MAY 2016 16:58:33

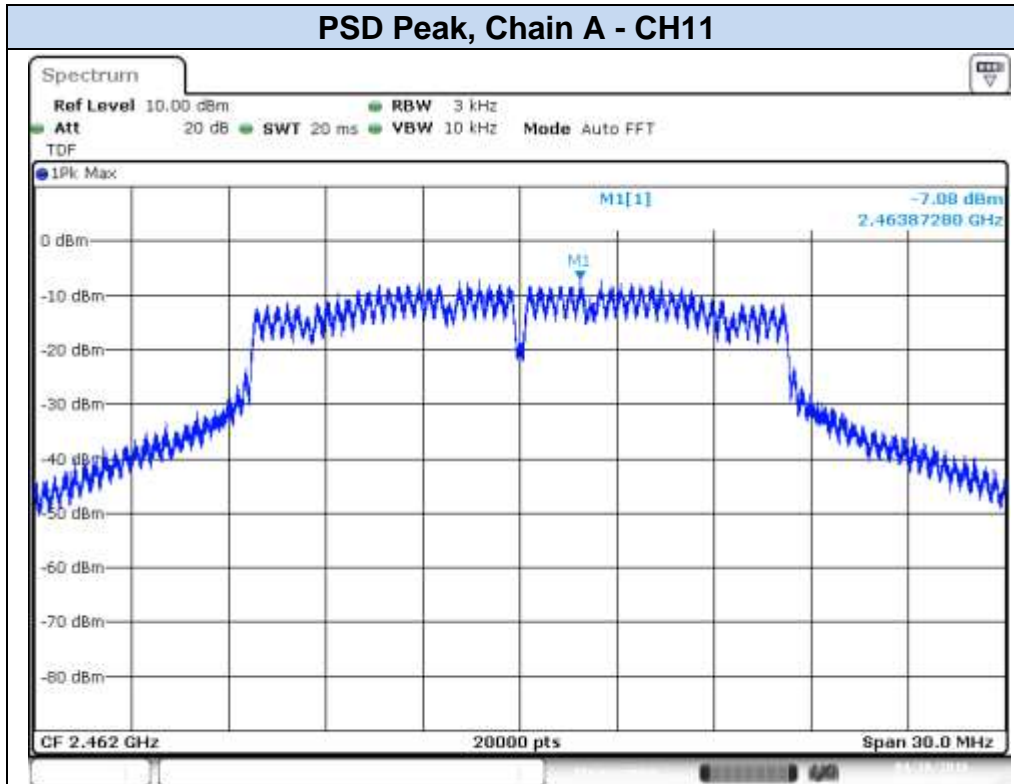

Date: 28 APR 2016 18:21:13

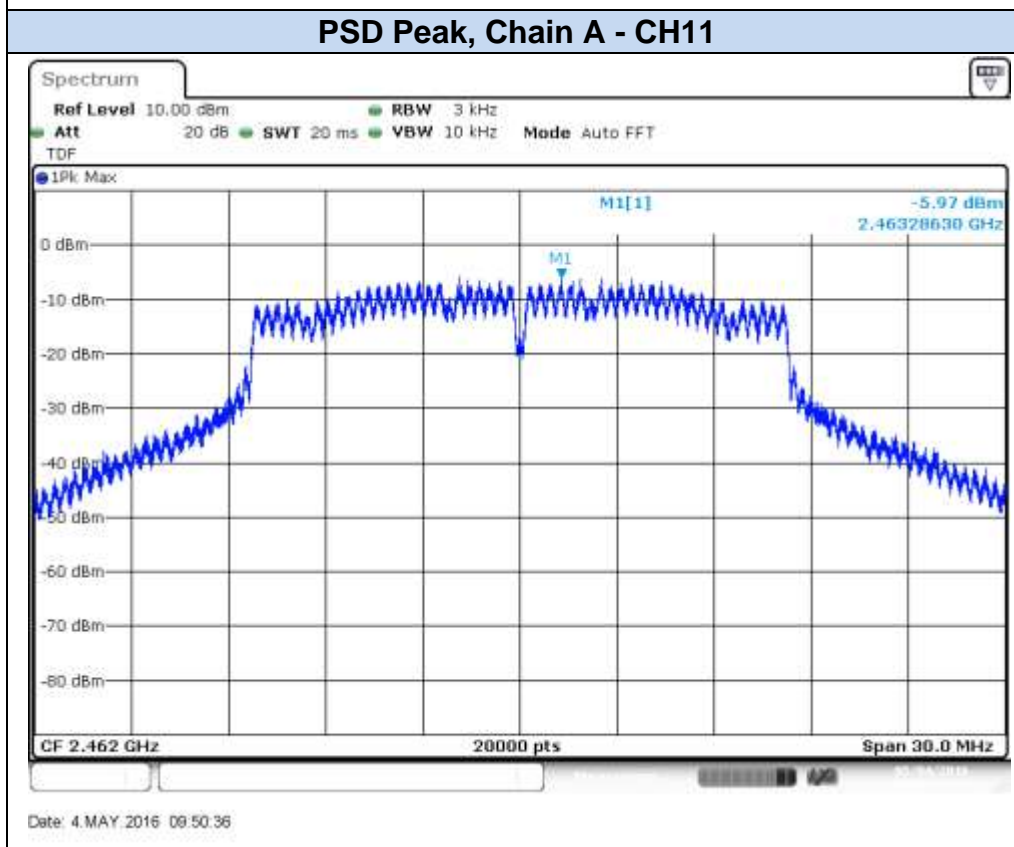

Date: 4 MAY 2016 08:50:36

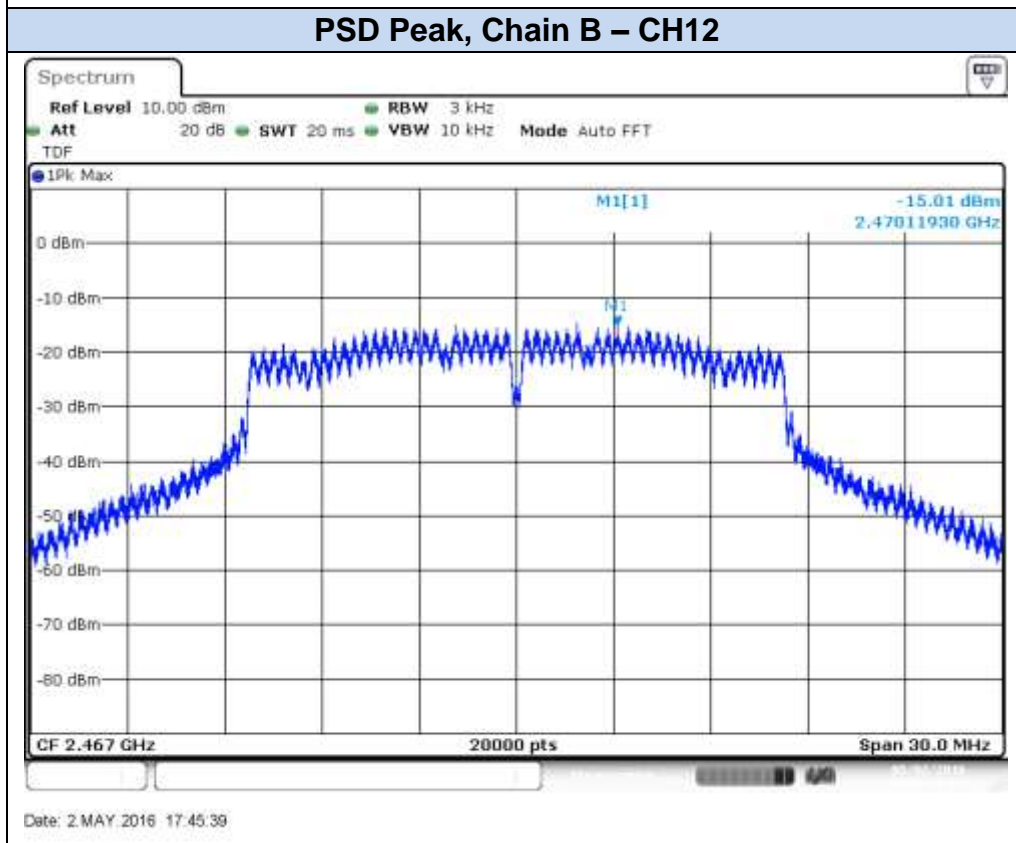
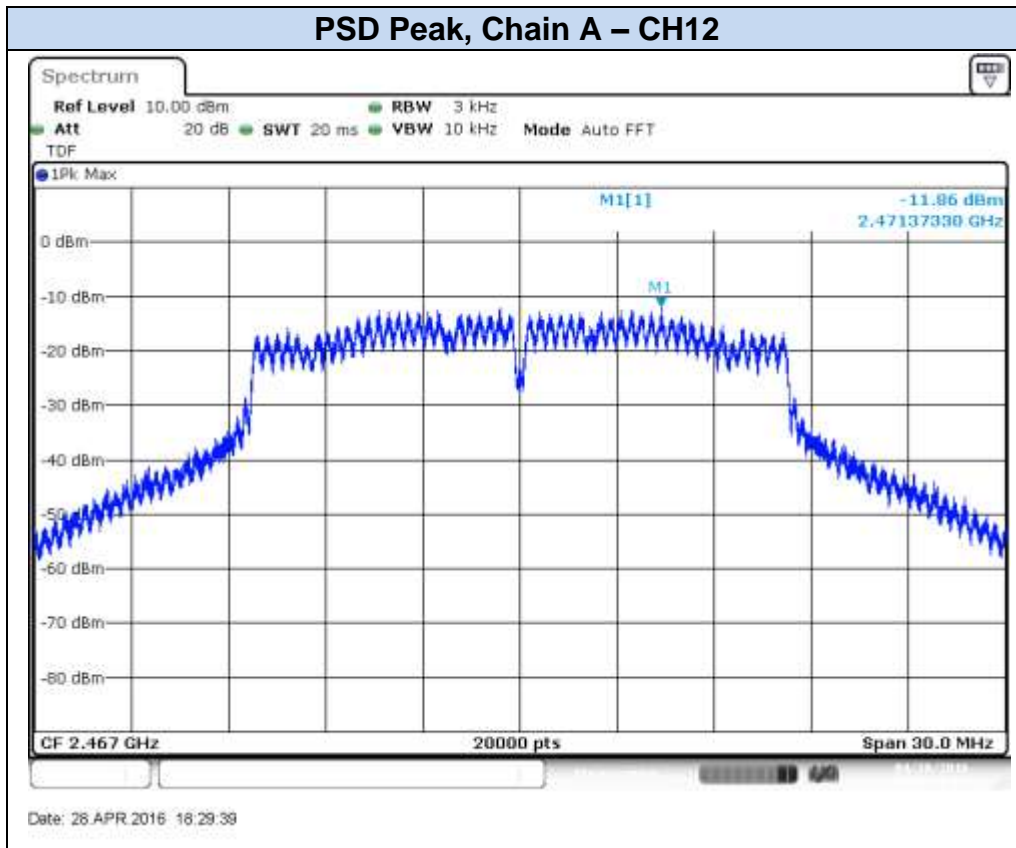

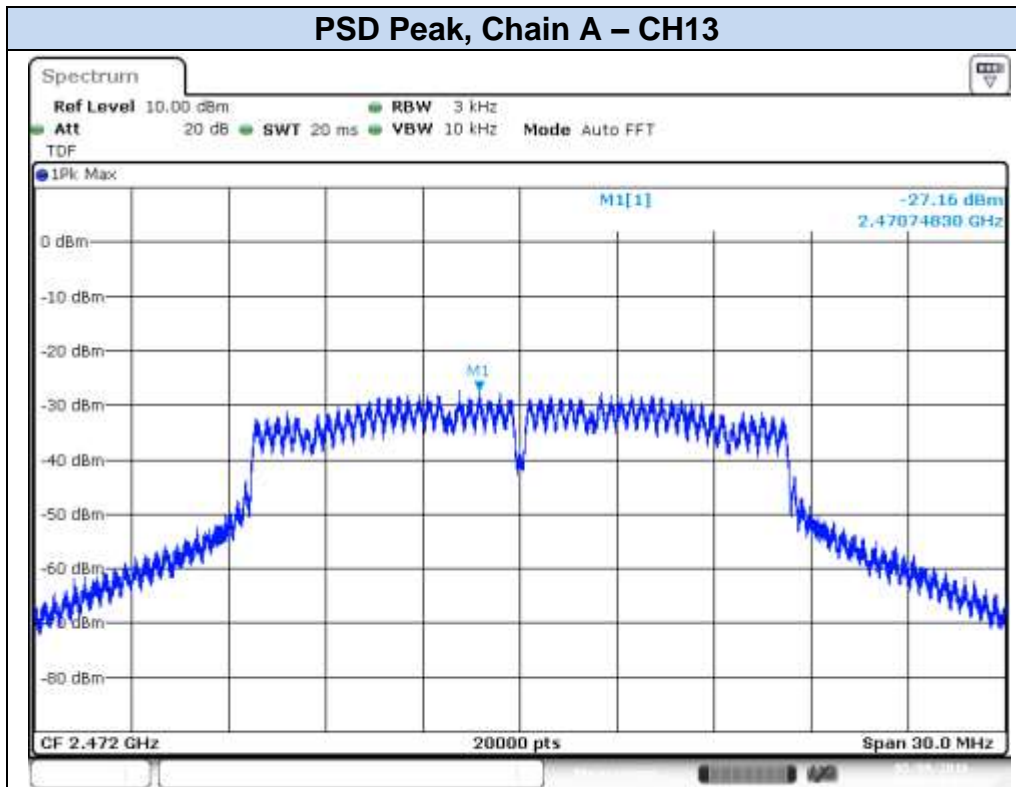

Date: 9.MAY 2016 11:37:44

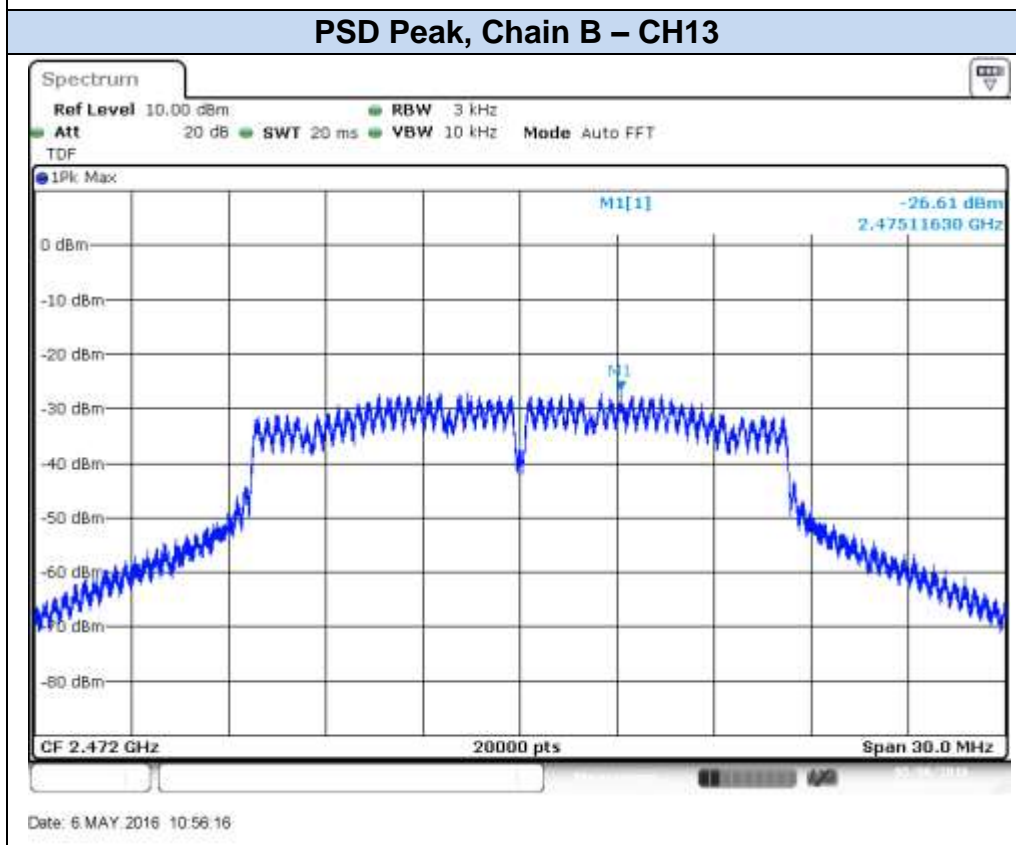

Date: 6.MAY 2016 10:56:16

### 802.11n20, HT0 (SISO)

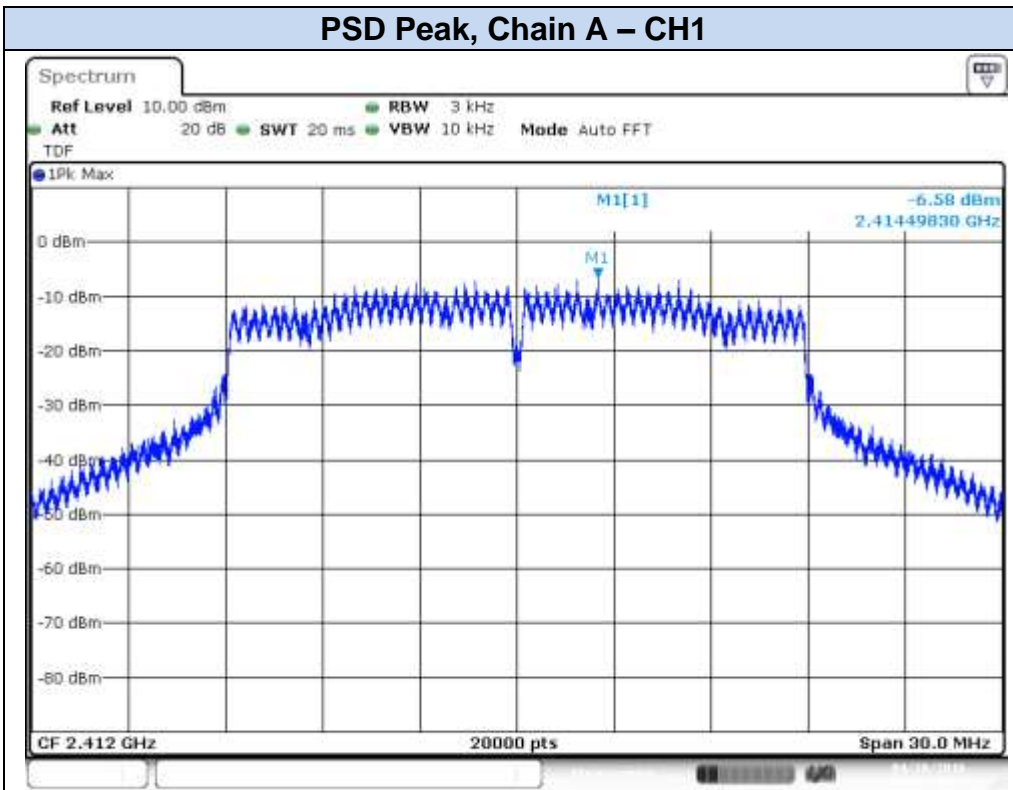

Date: 26 APR 2016 19:06:36

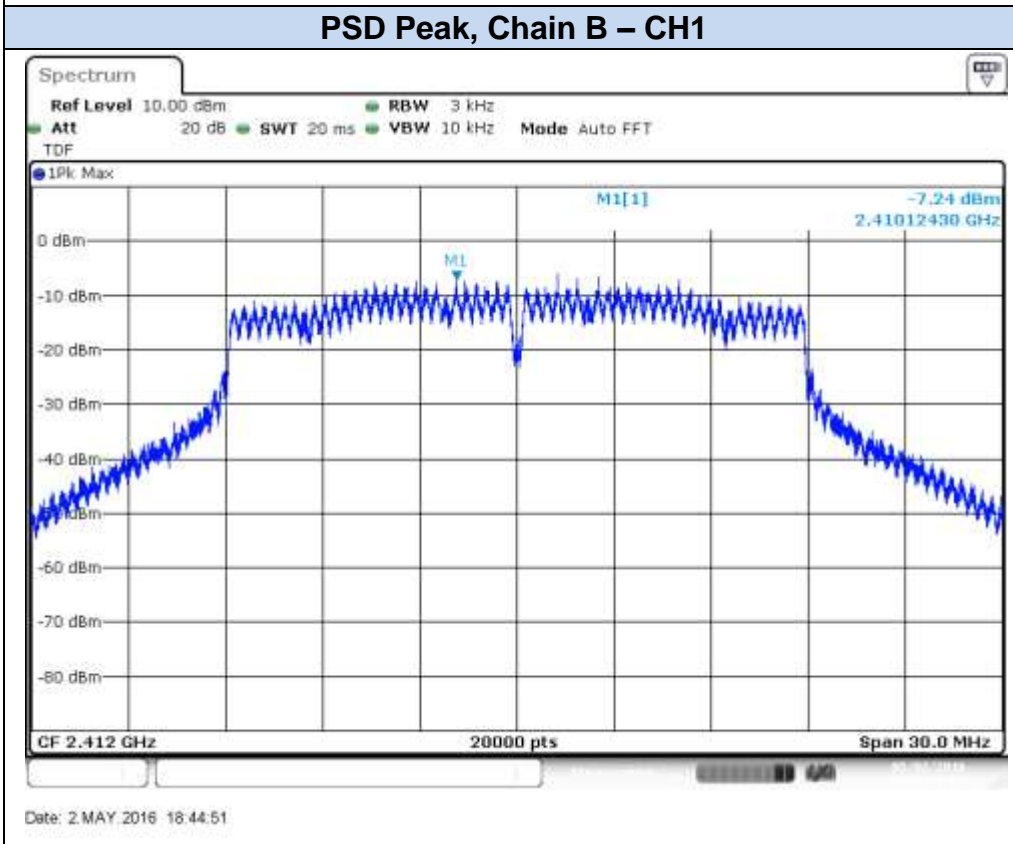

Date: 2 MAY 2016 16:44:51

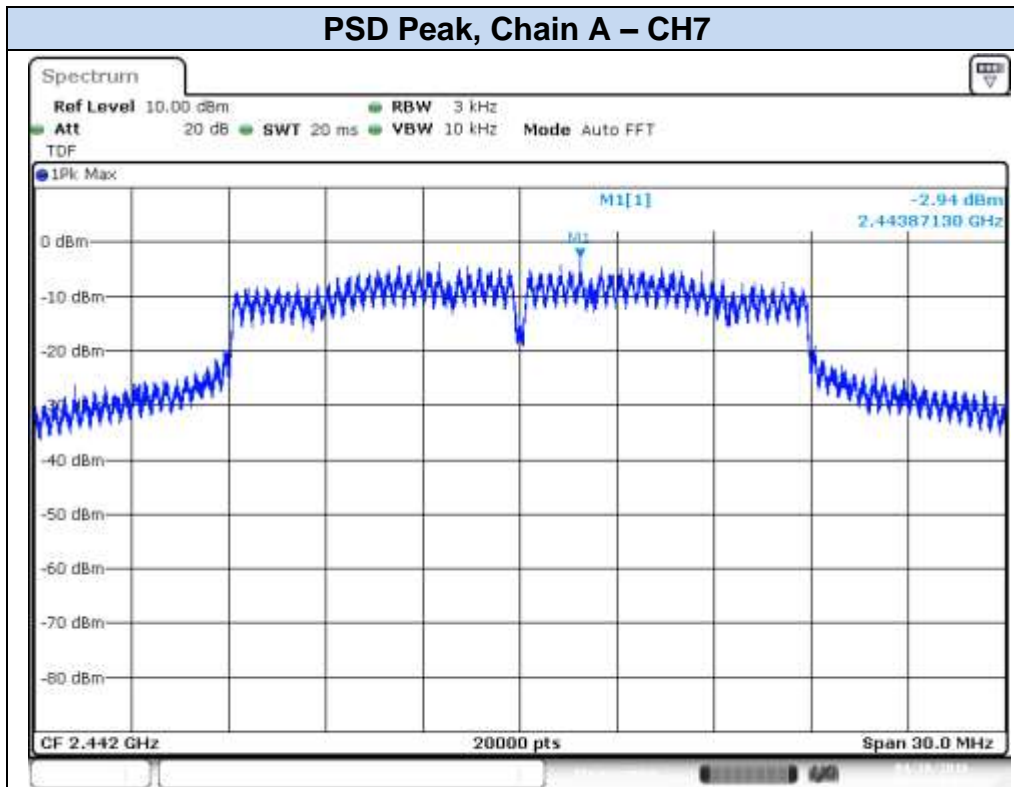

Date: 26.APR.2016 19:14:31

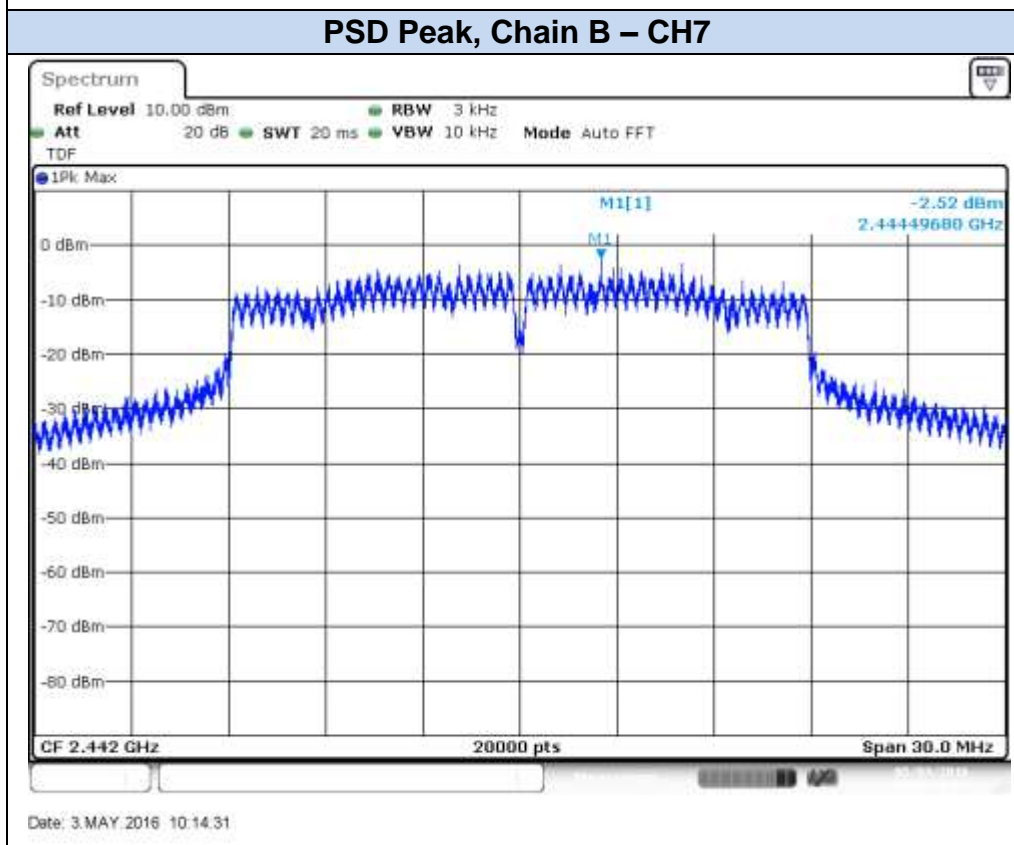

Date: 3.MAY.2016 10:14:31



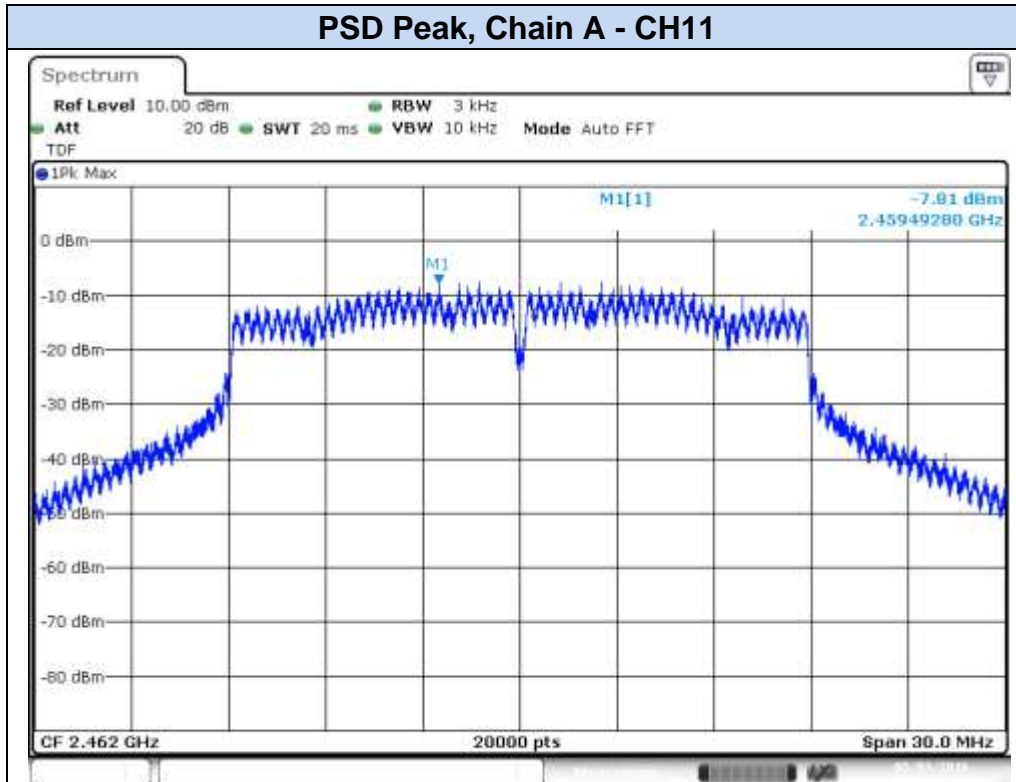

Date: 3.MAY.2016 11:04:33

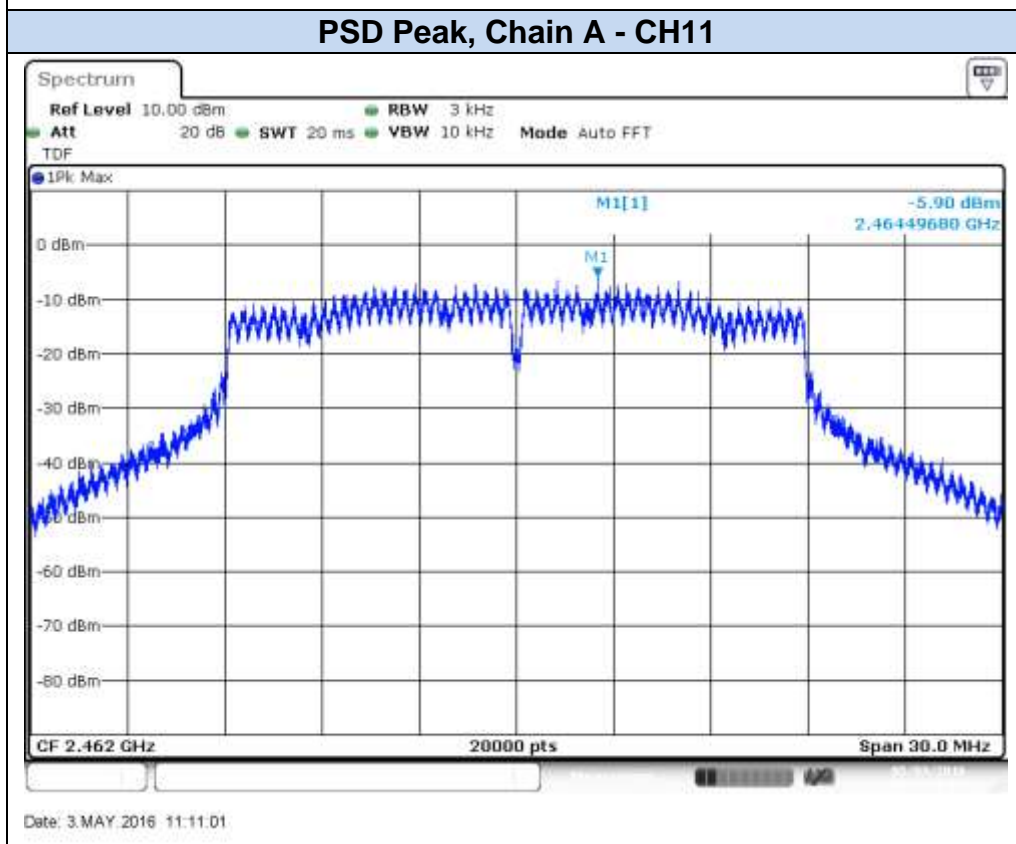

Date: 3.MAY.2016 11:11:01

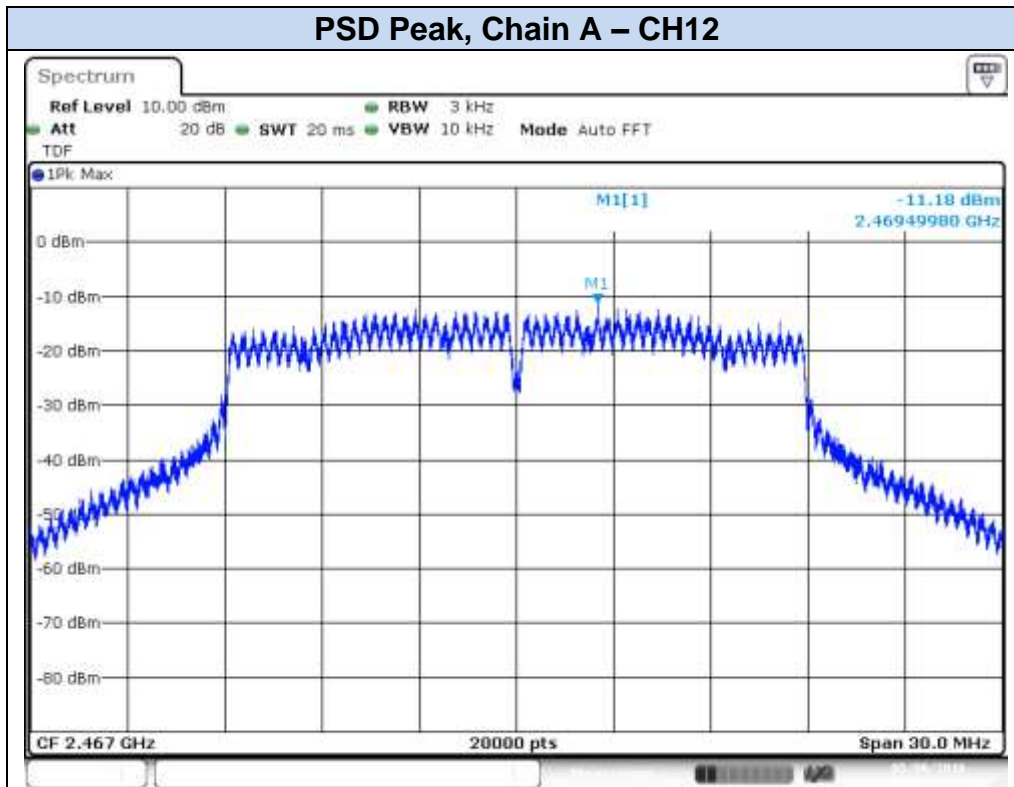

Date: 6 MAY 2016 11:14:12

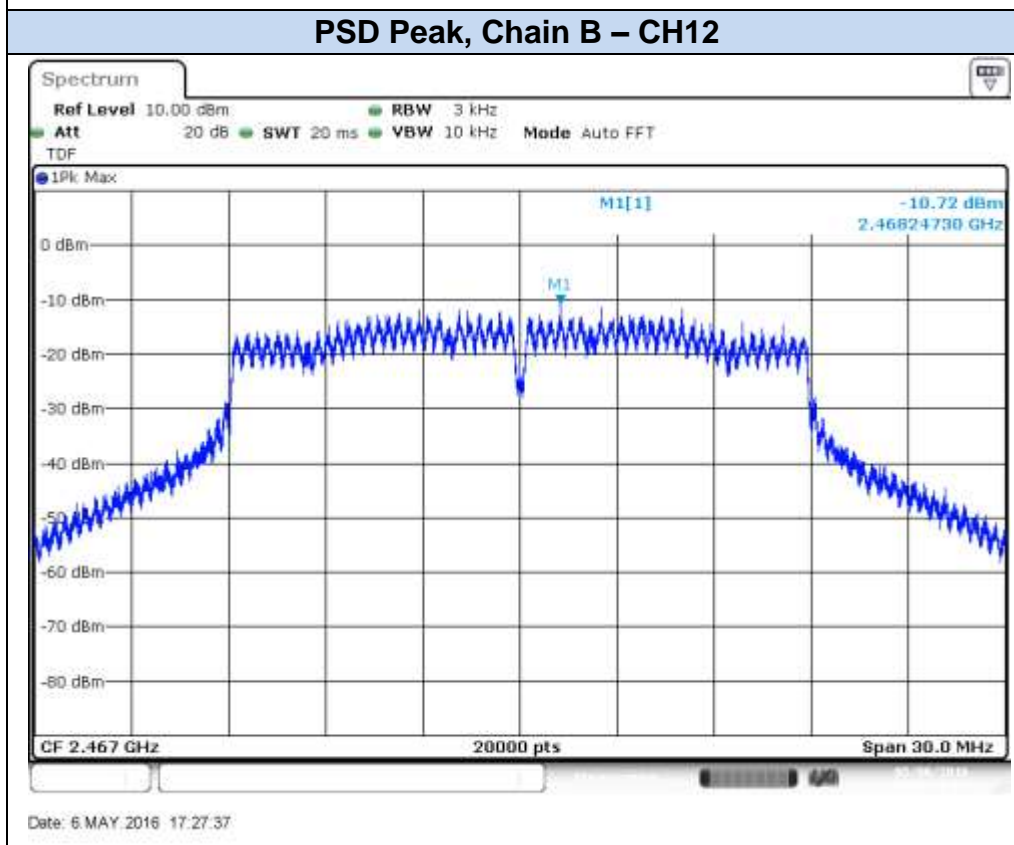

Date: 6 MAY 2016 17:27:37

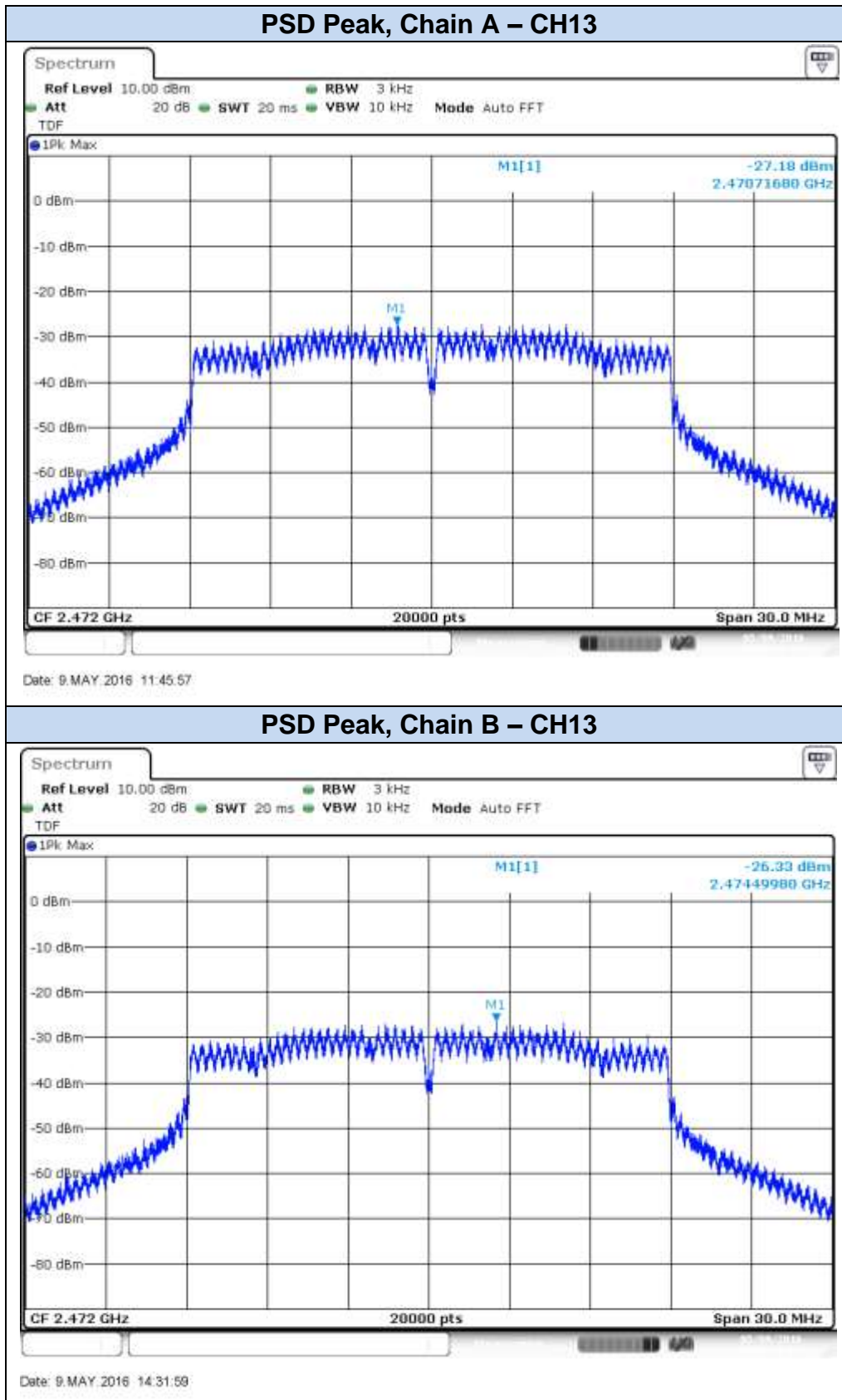

**802.11n20, HT8 (MIMO)**

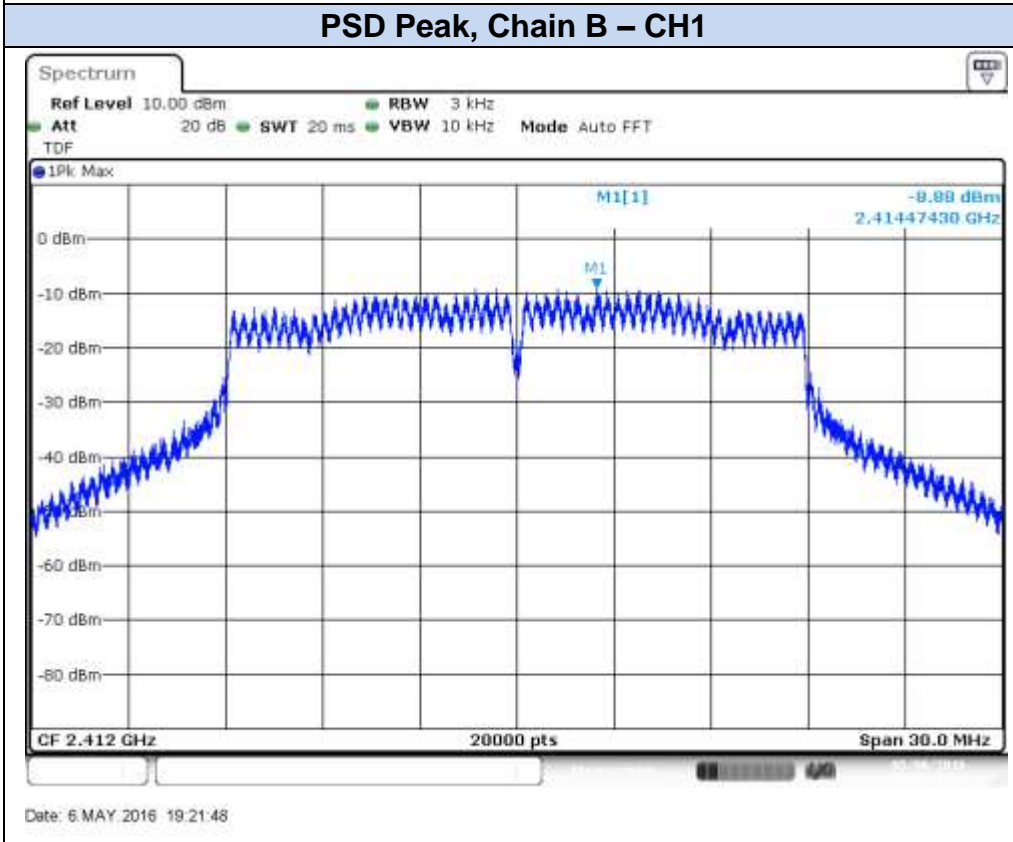
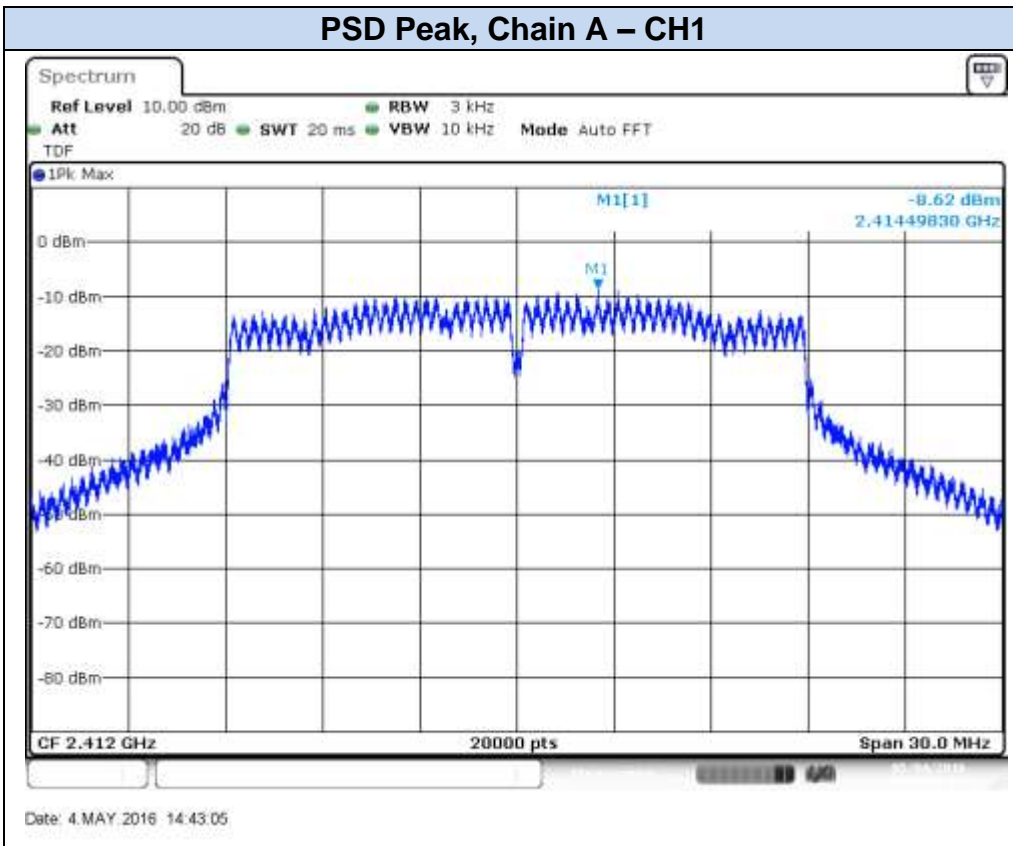

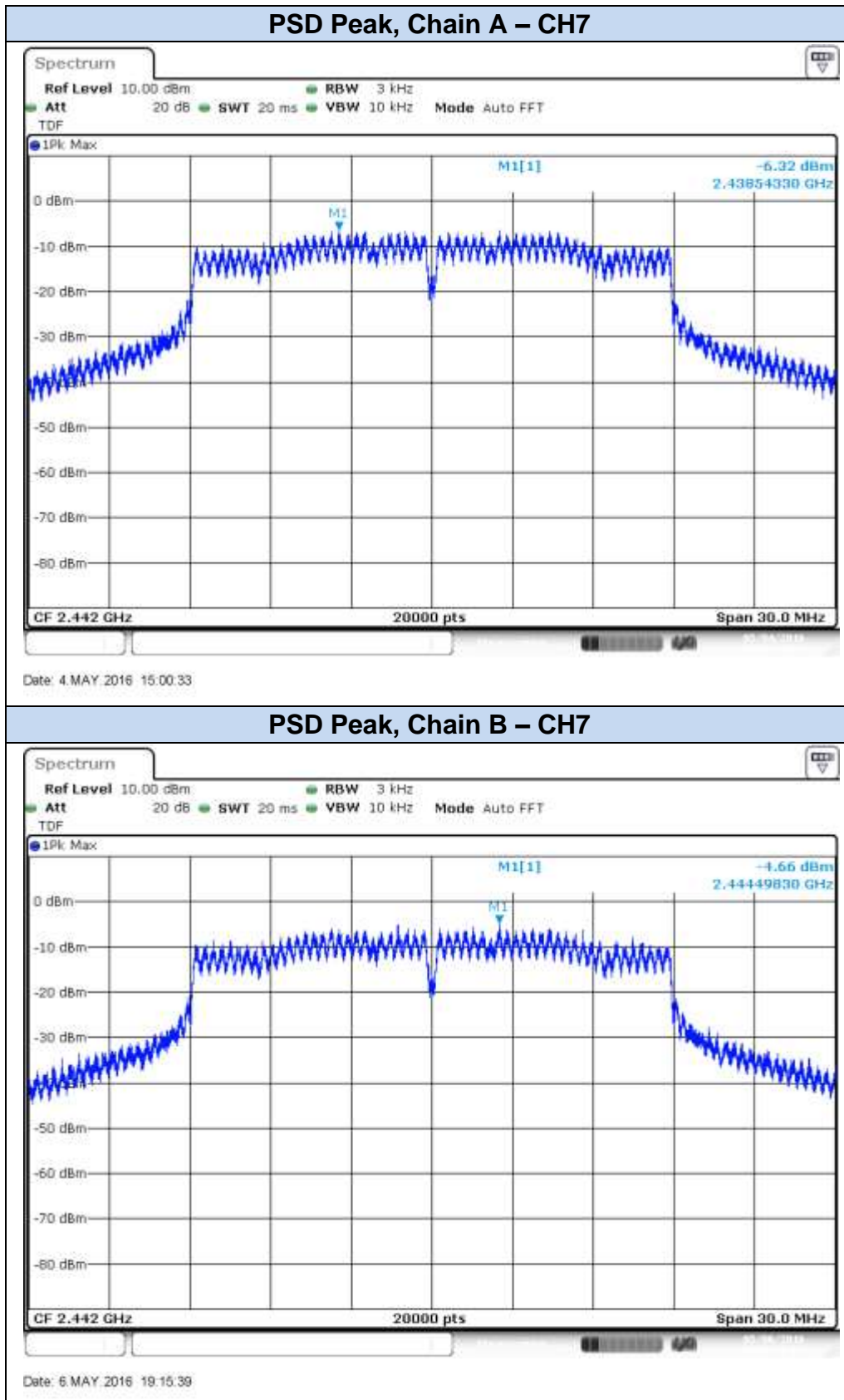

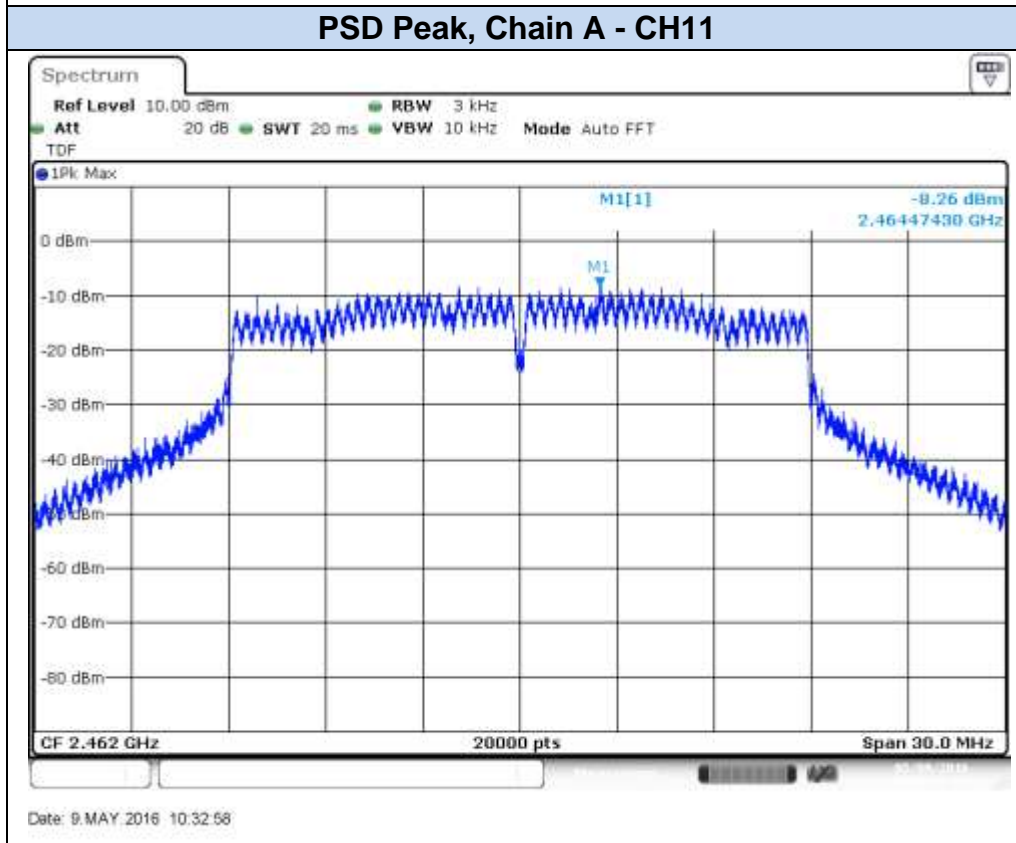
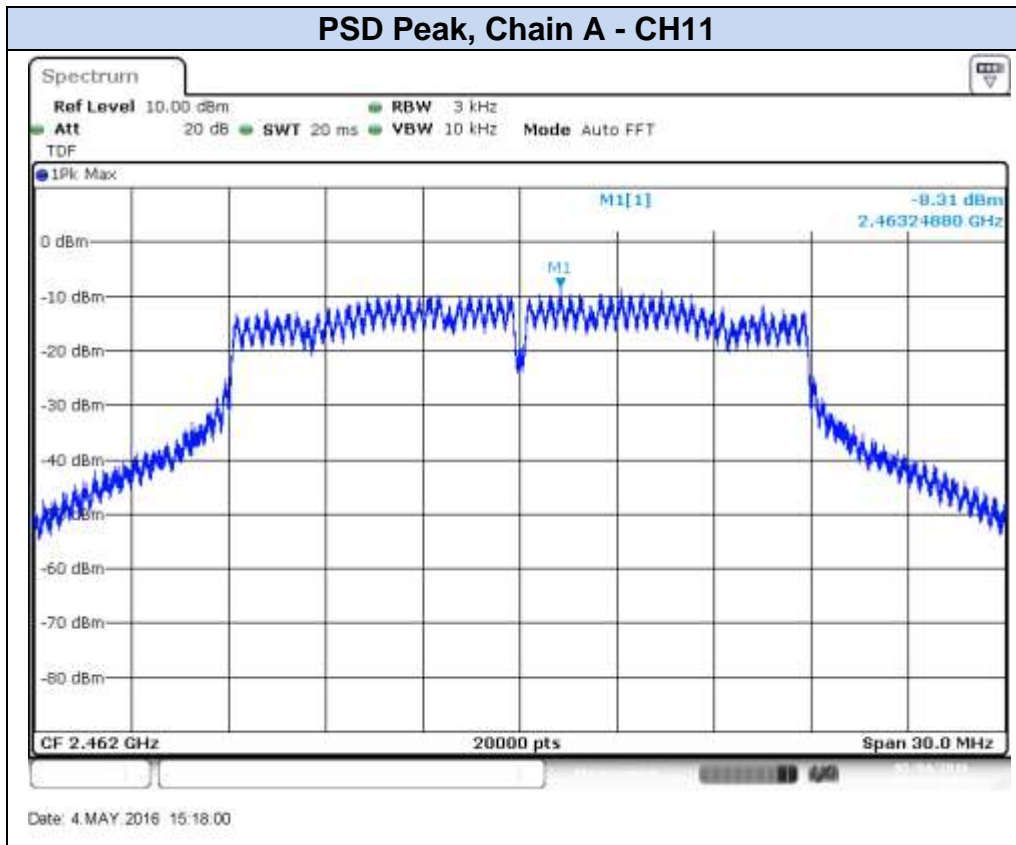

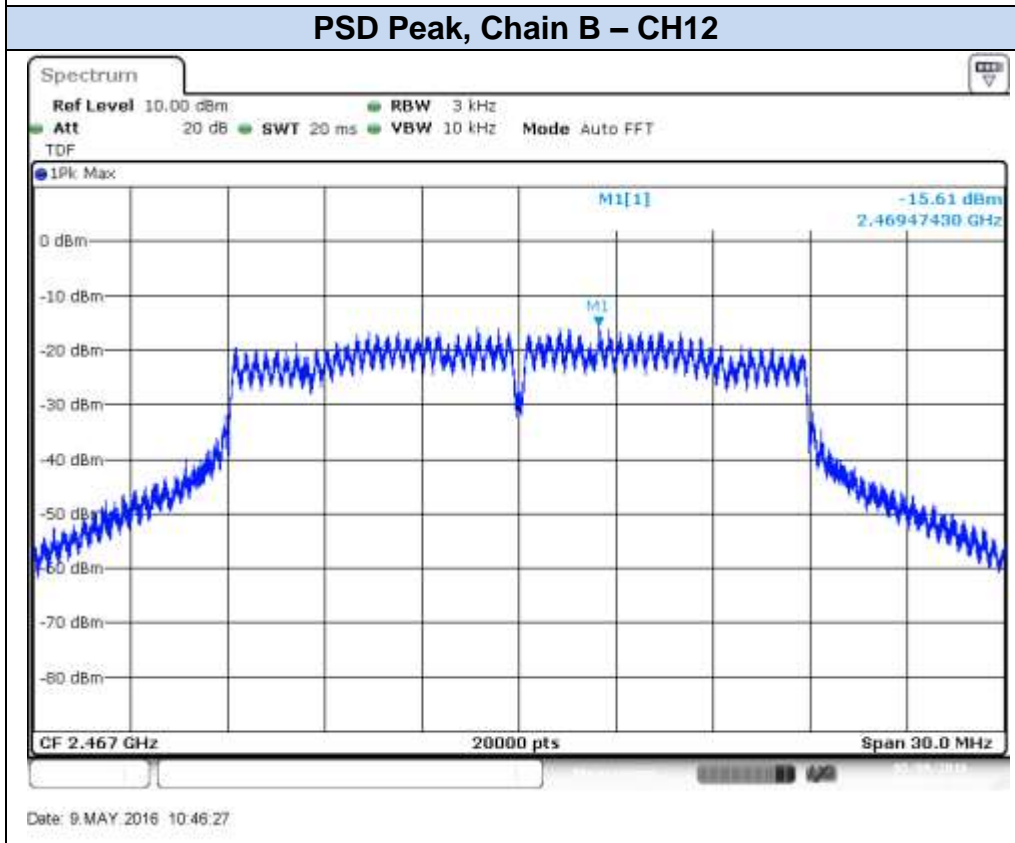
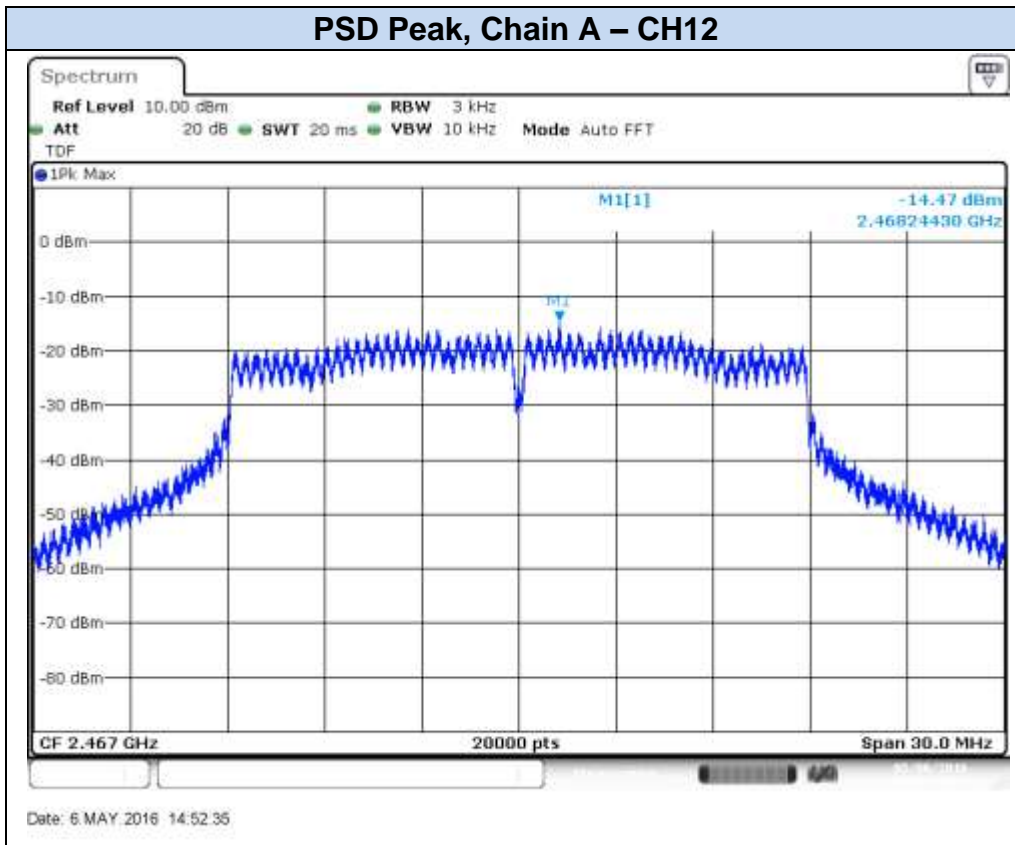

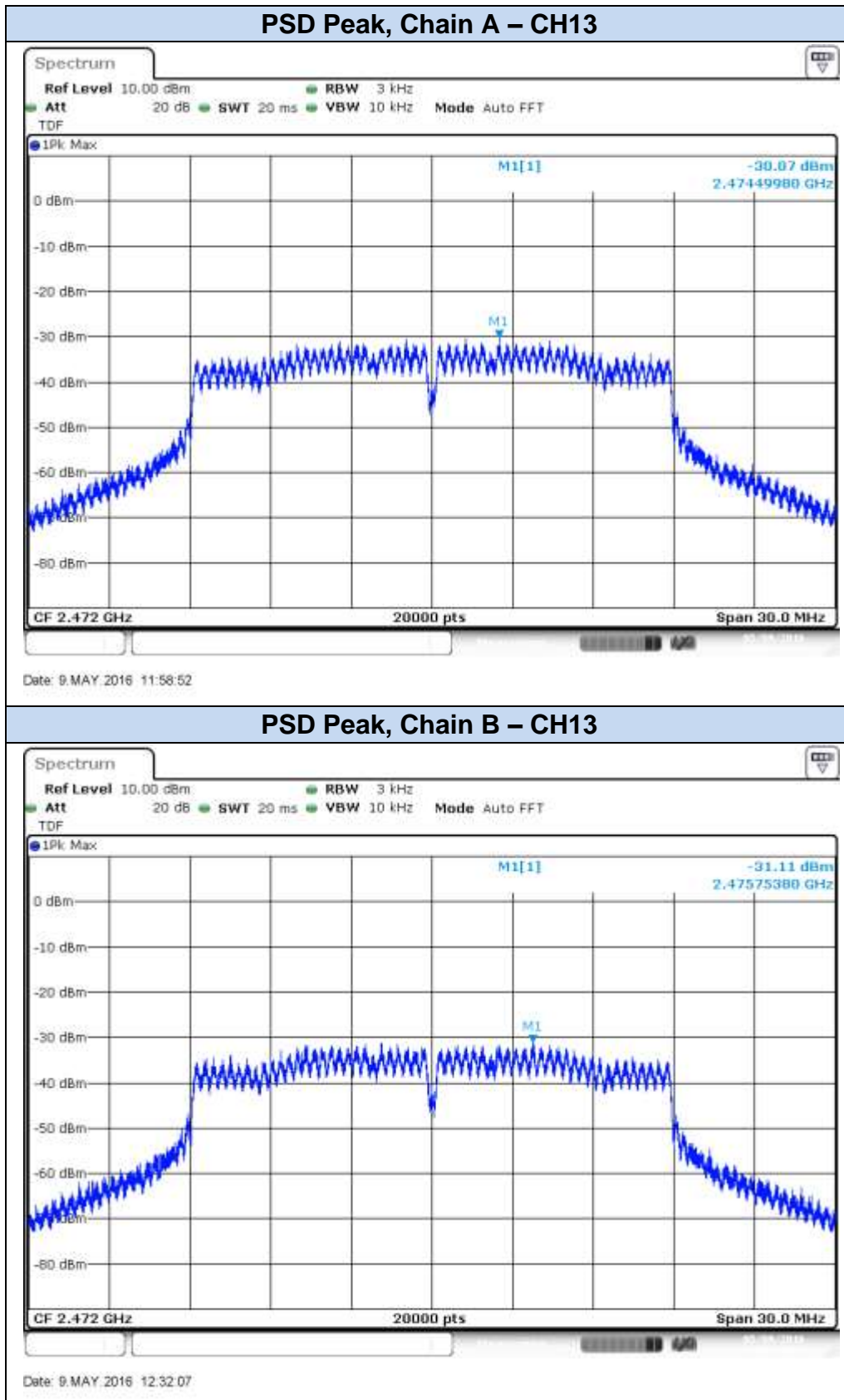



### 802.11n40, HT0 (SISO)

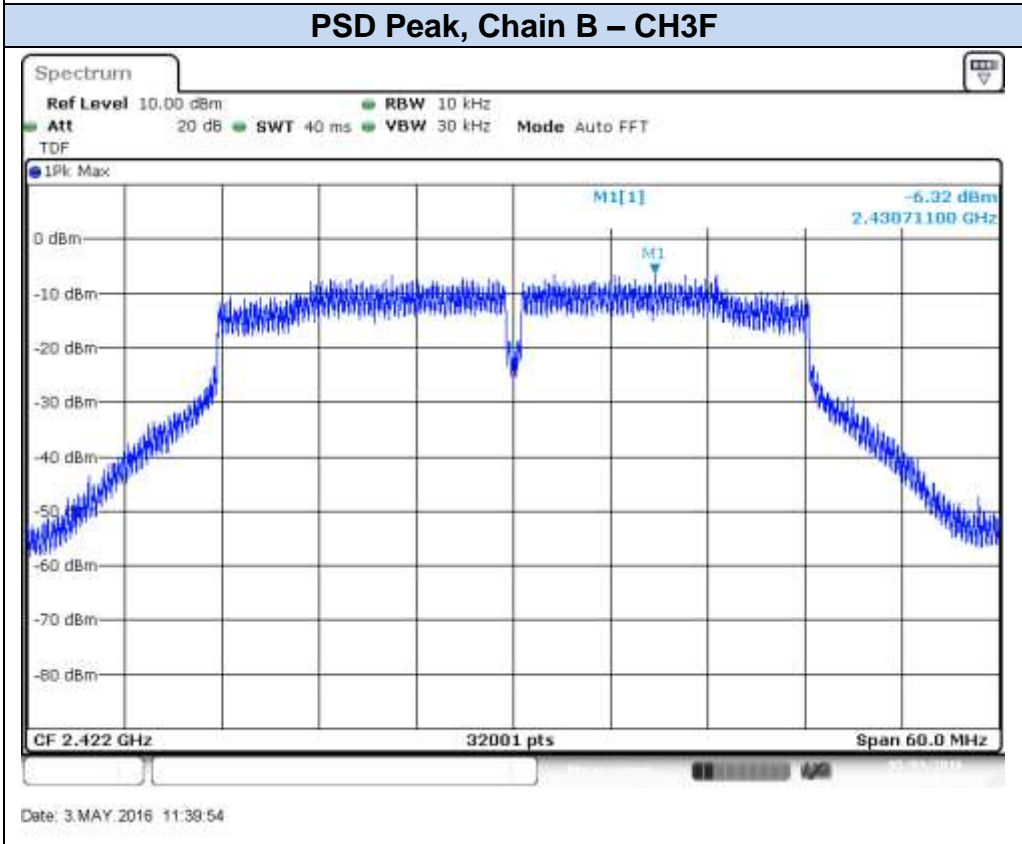
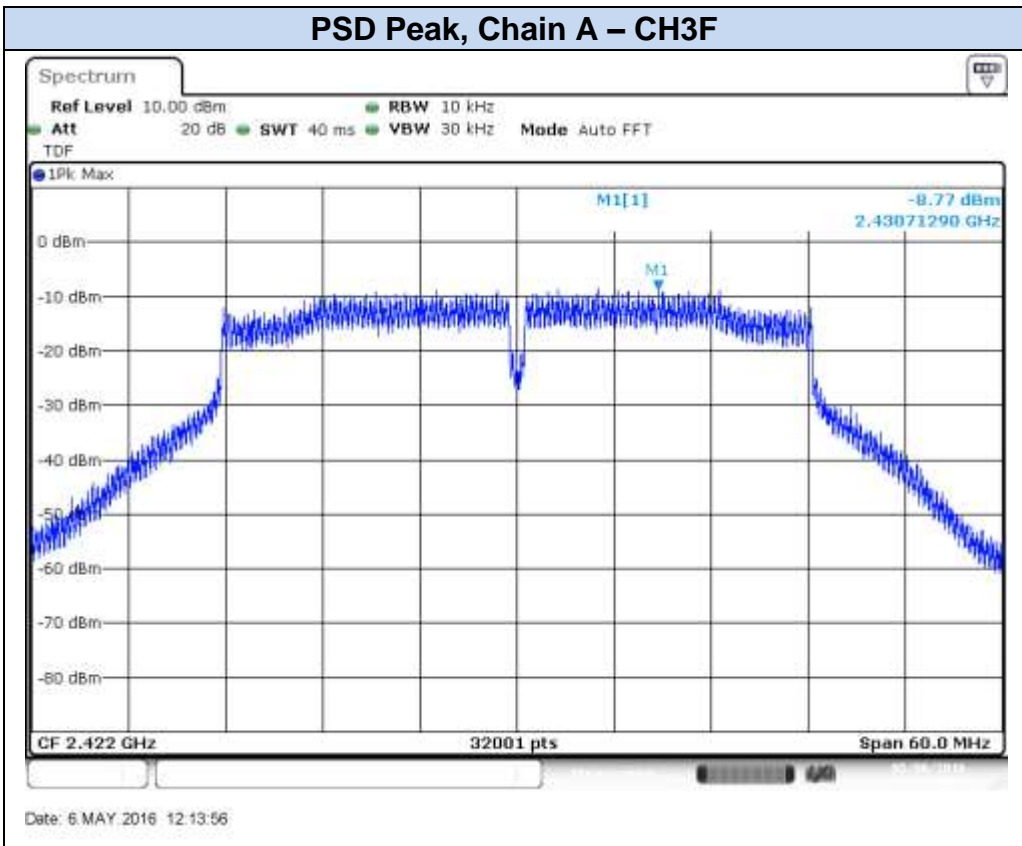

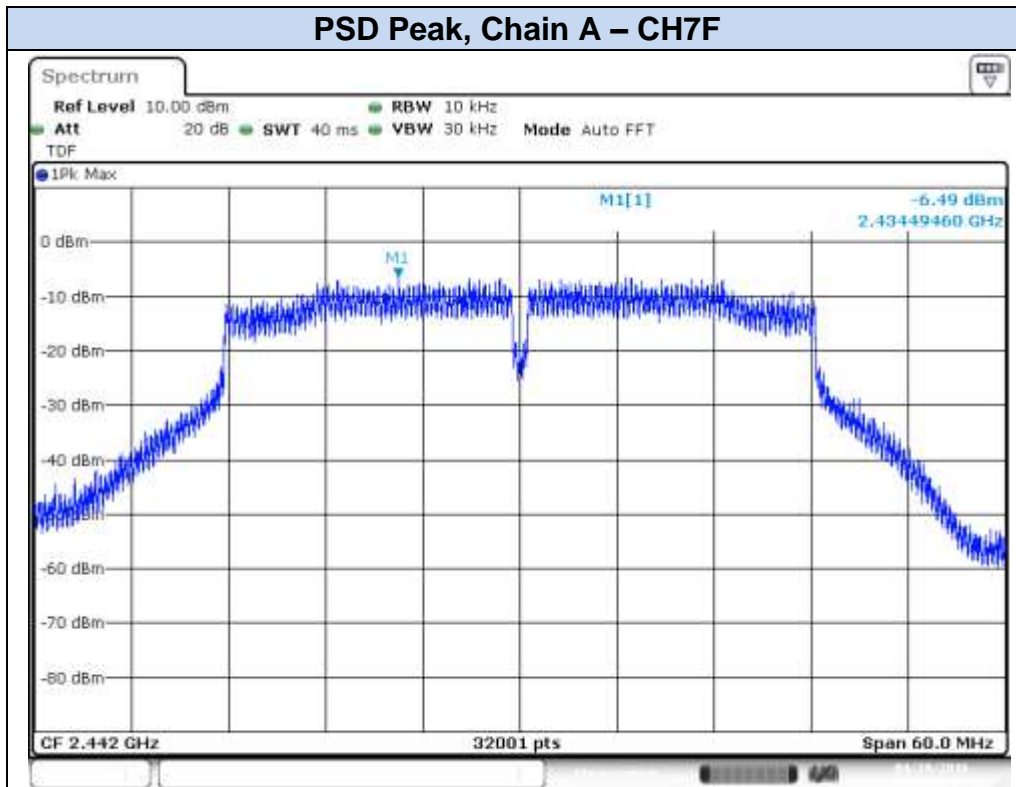

Date: 29.APR.2016 15:32:09

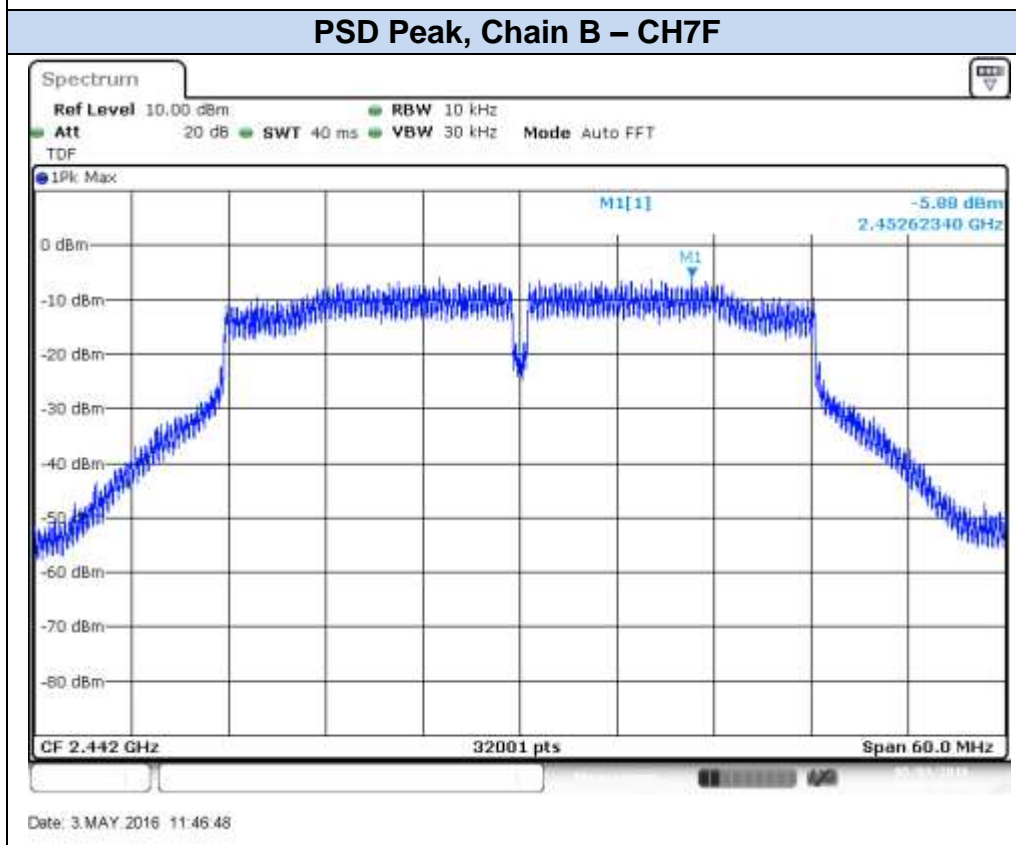

Date: 3.MAY.2016 11:46:48

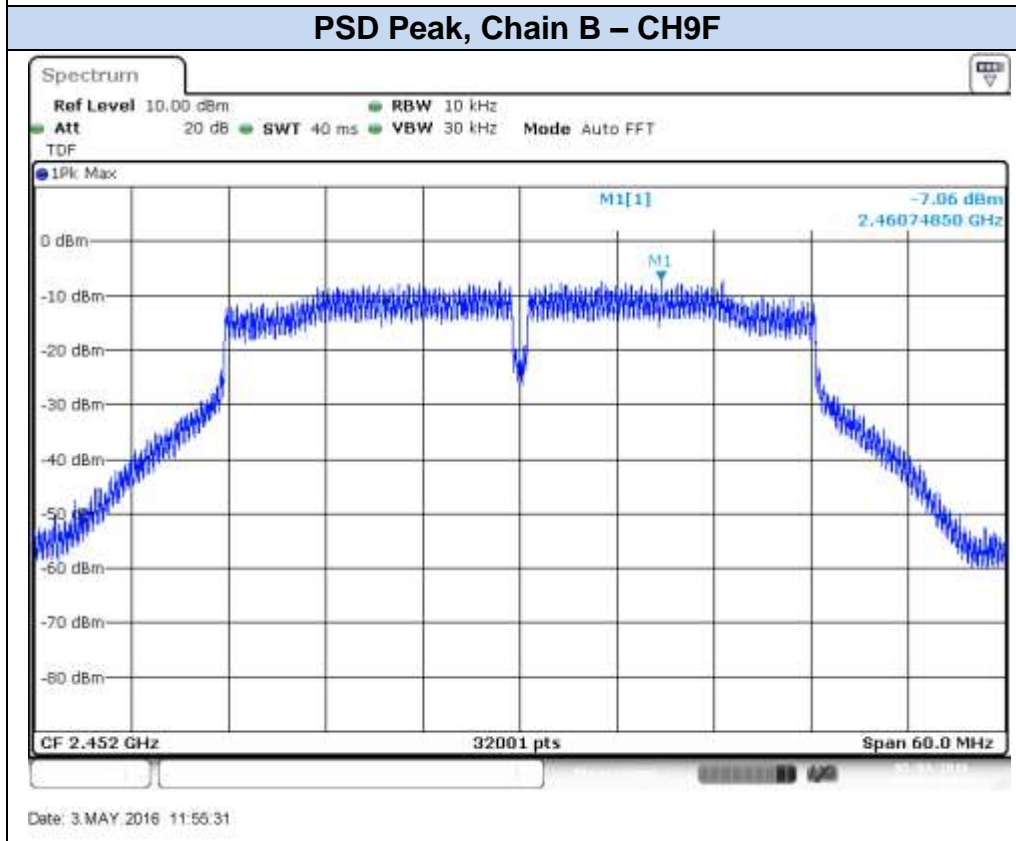
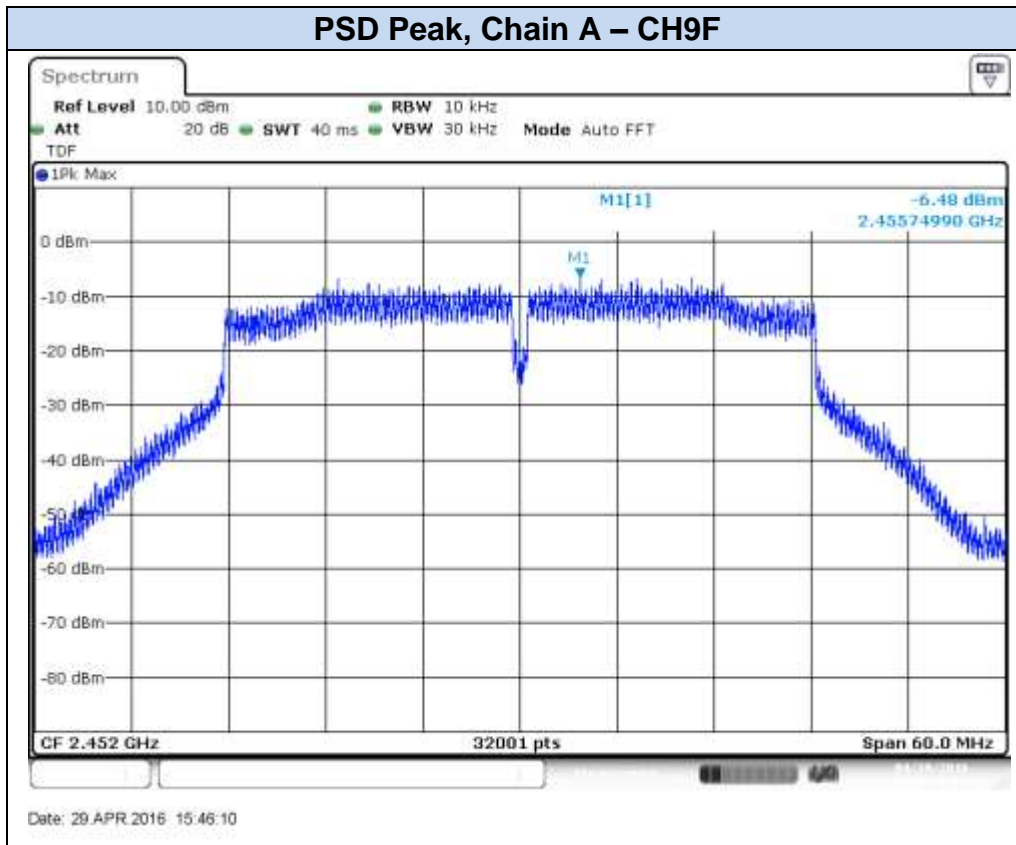

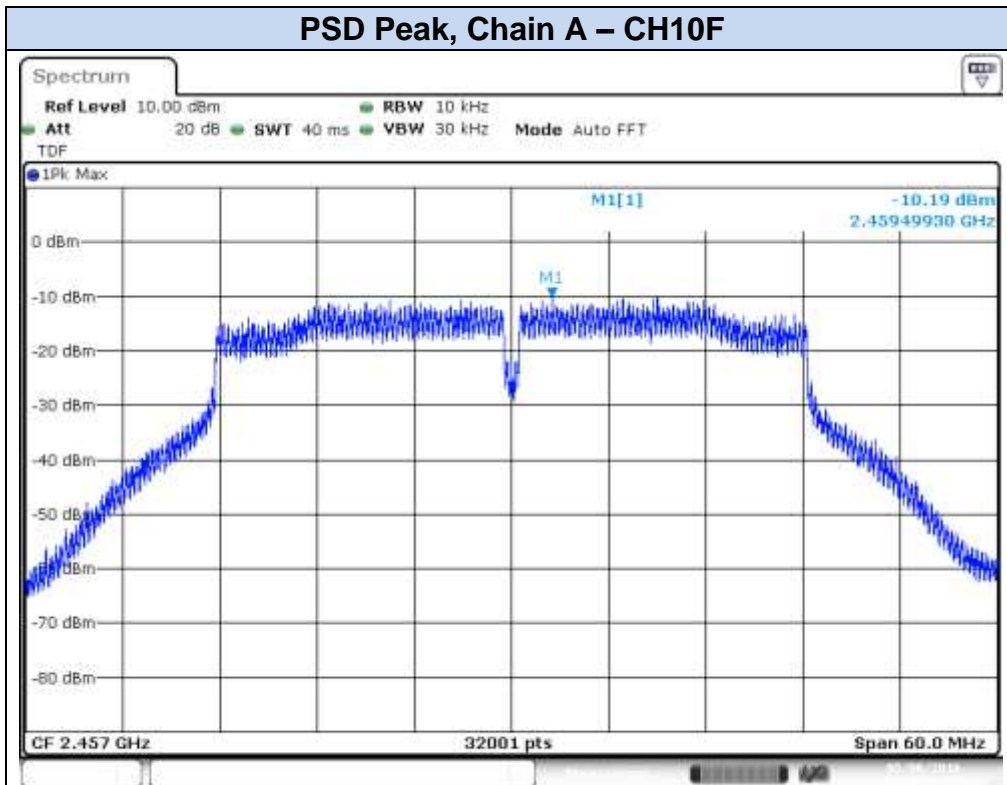

Date: 6 MAY 2016 11:36:46

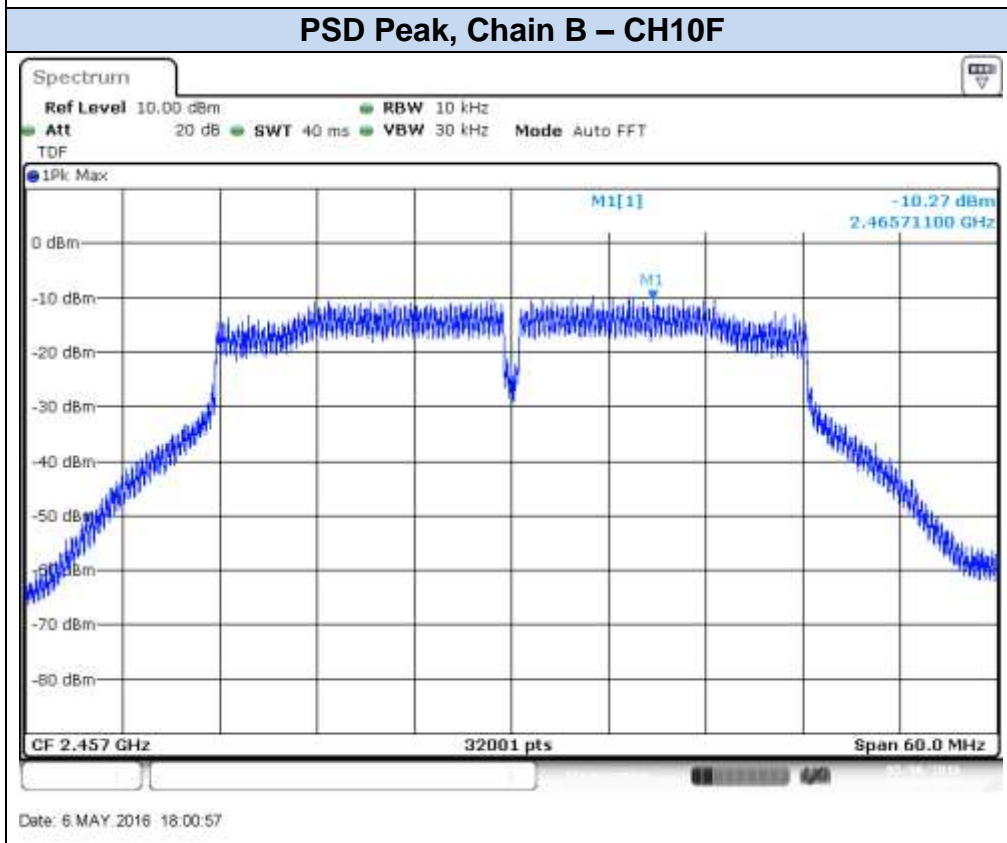

Date: 6 MAY 2016 18:00:57

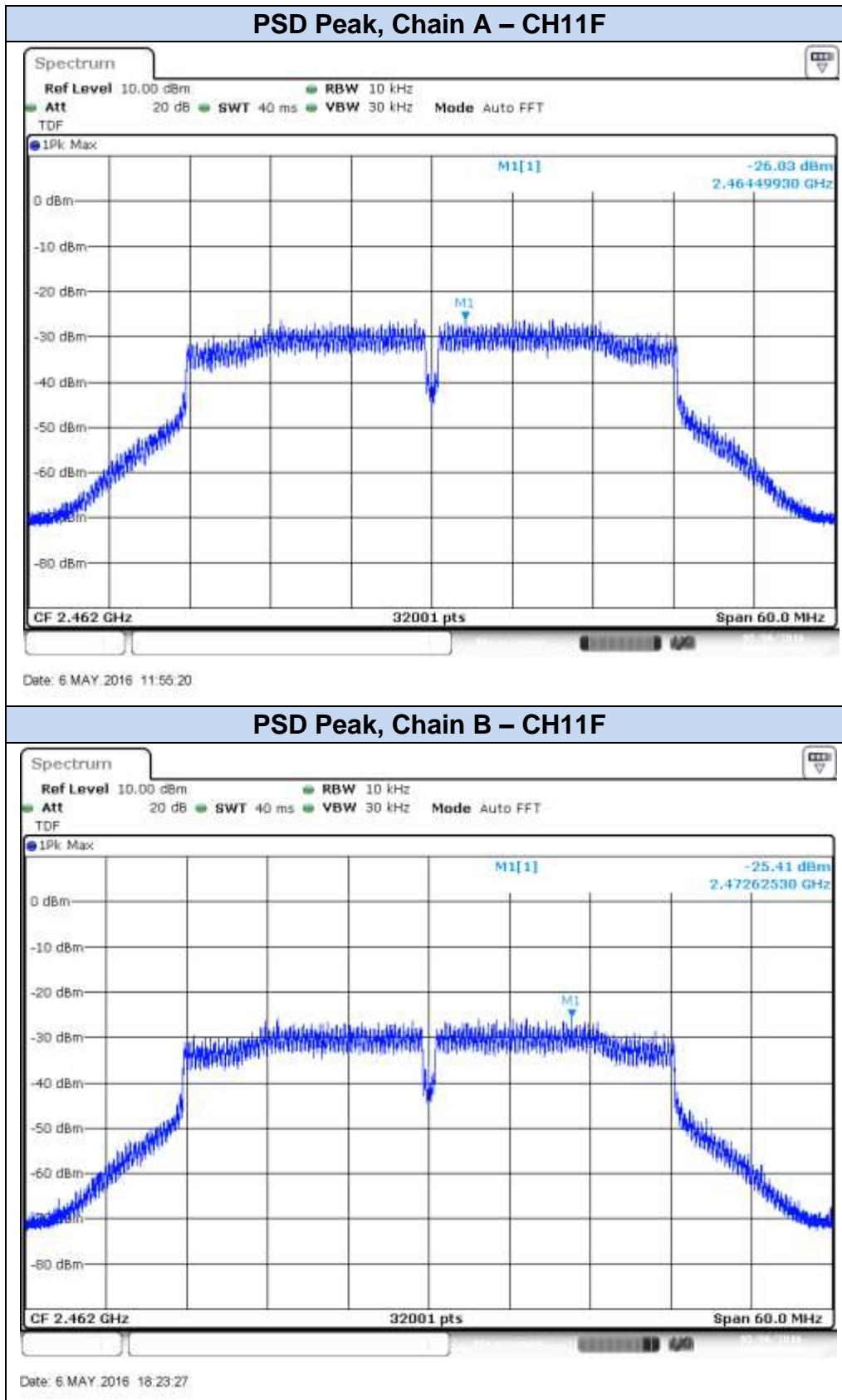

### 802.11n40, HT8 (MIMO)

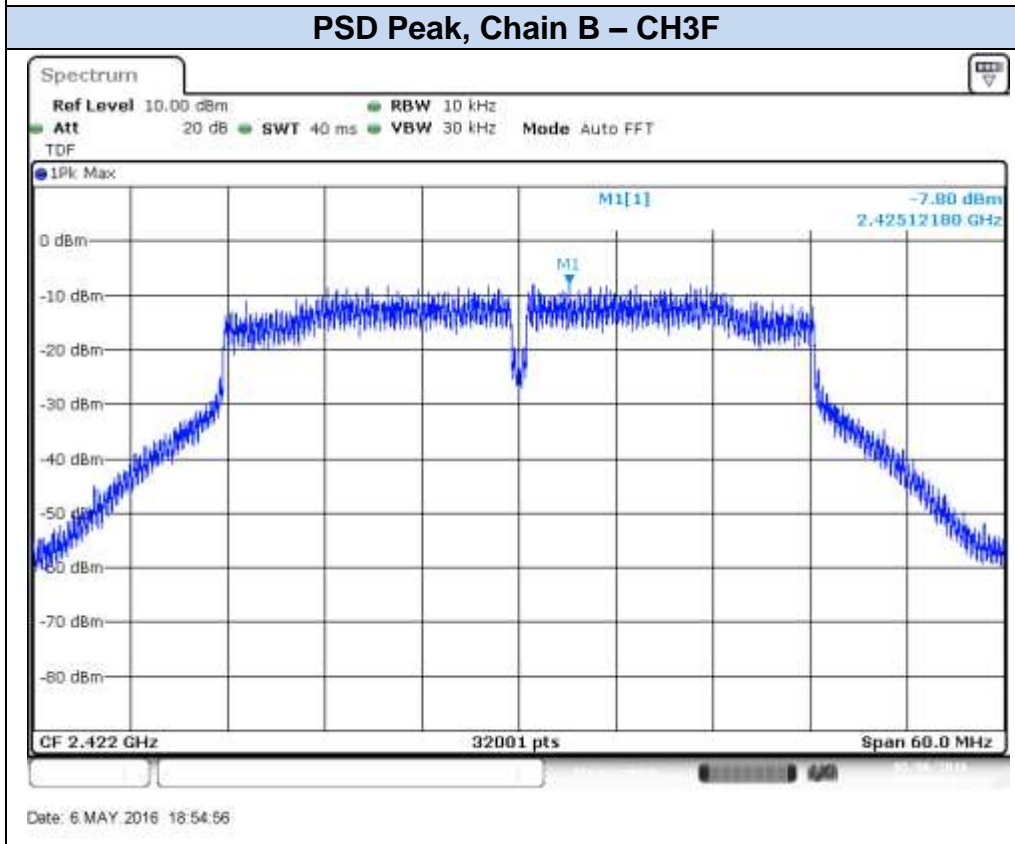
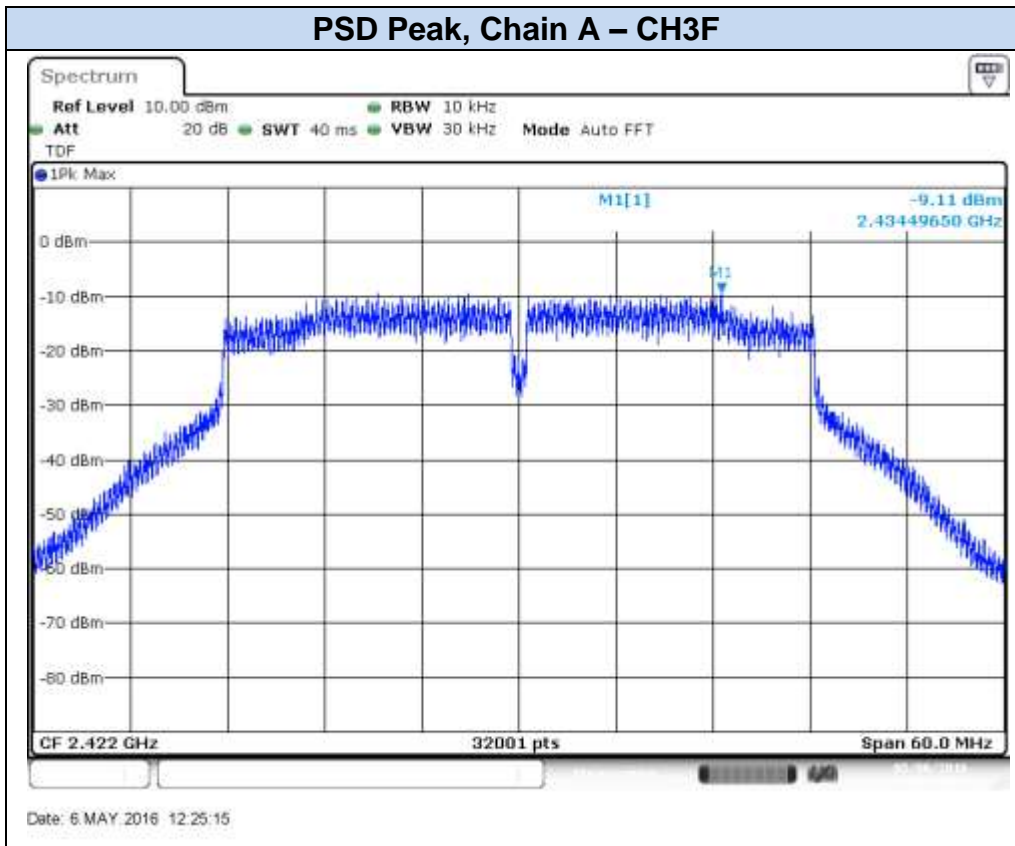

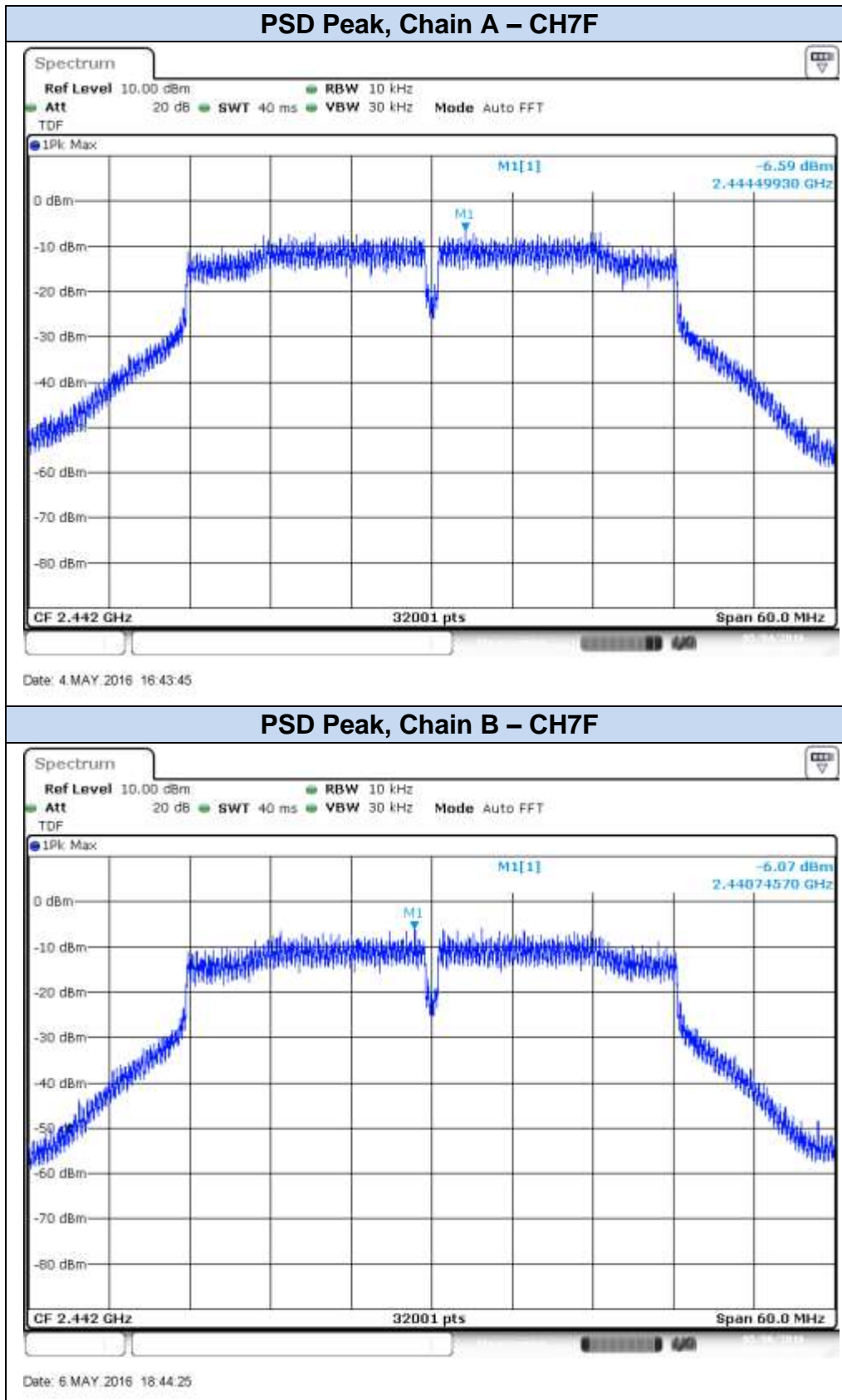

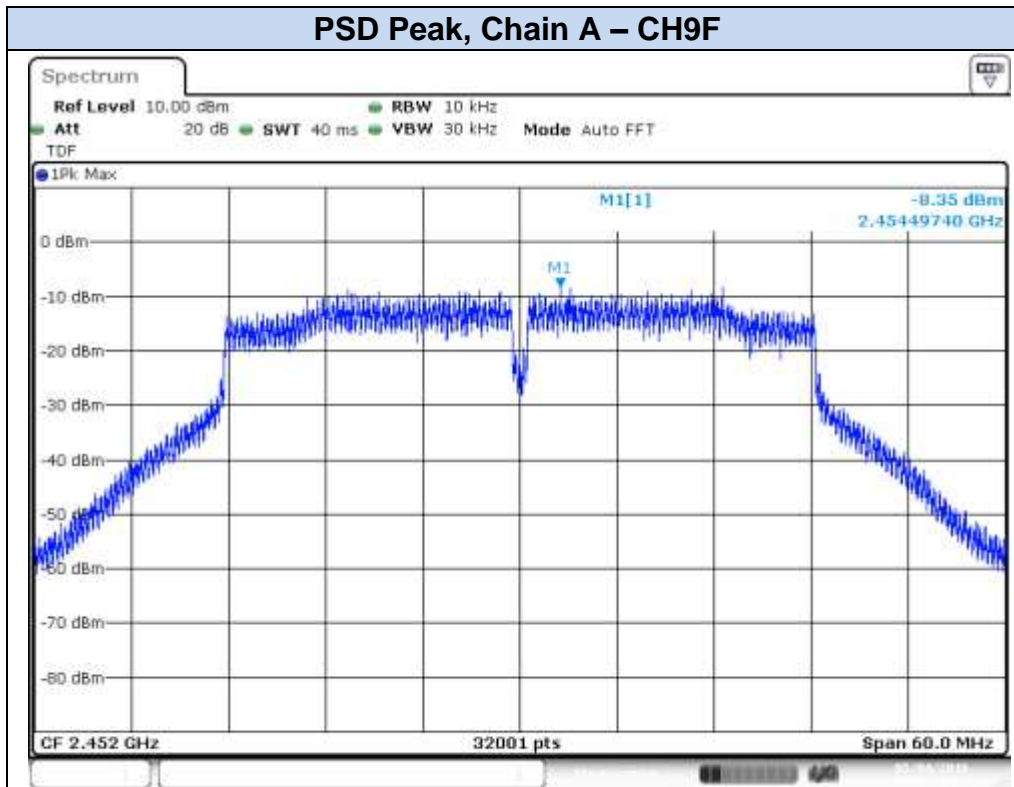

Date: 4.MAY 2016 17:47:58

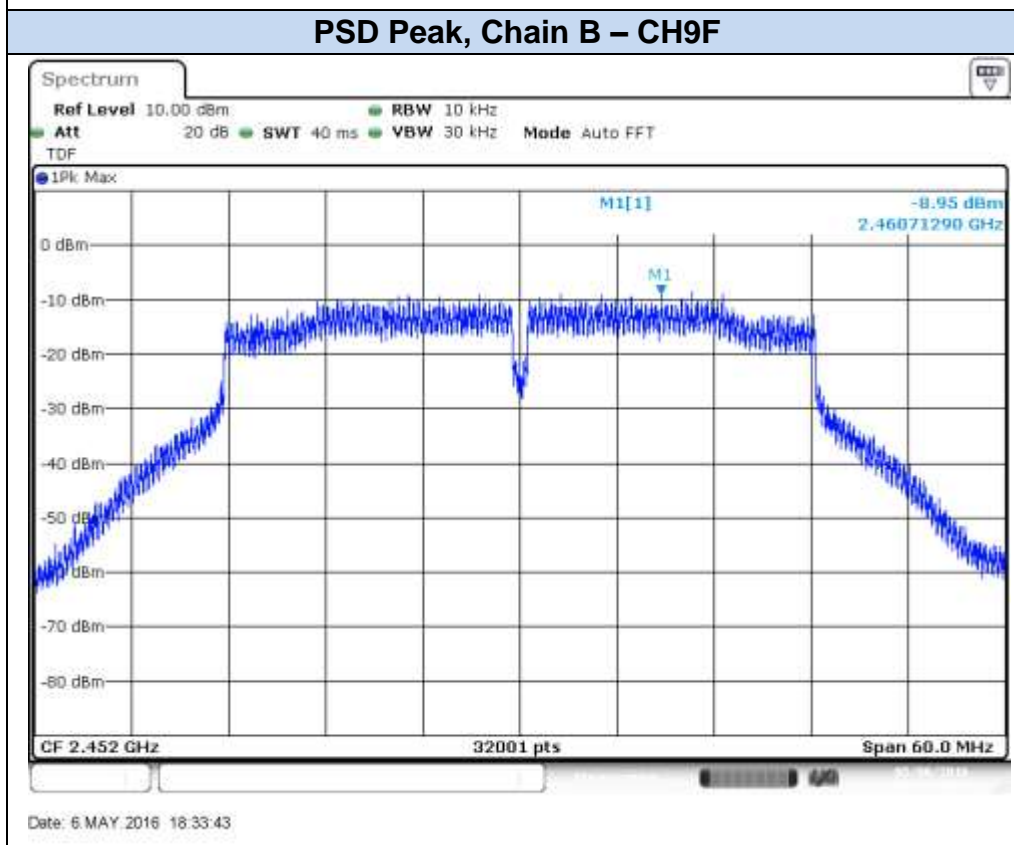

Date: 6.MAY 2016 18:33:43



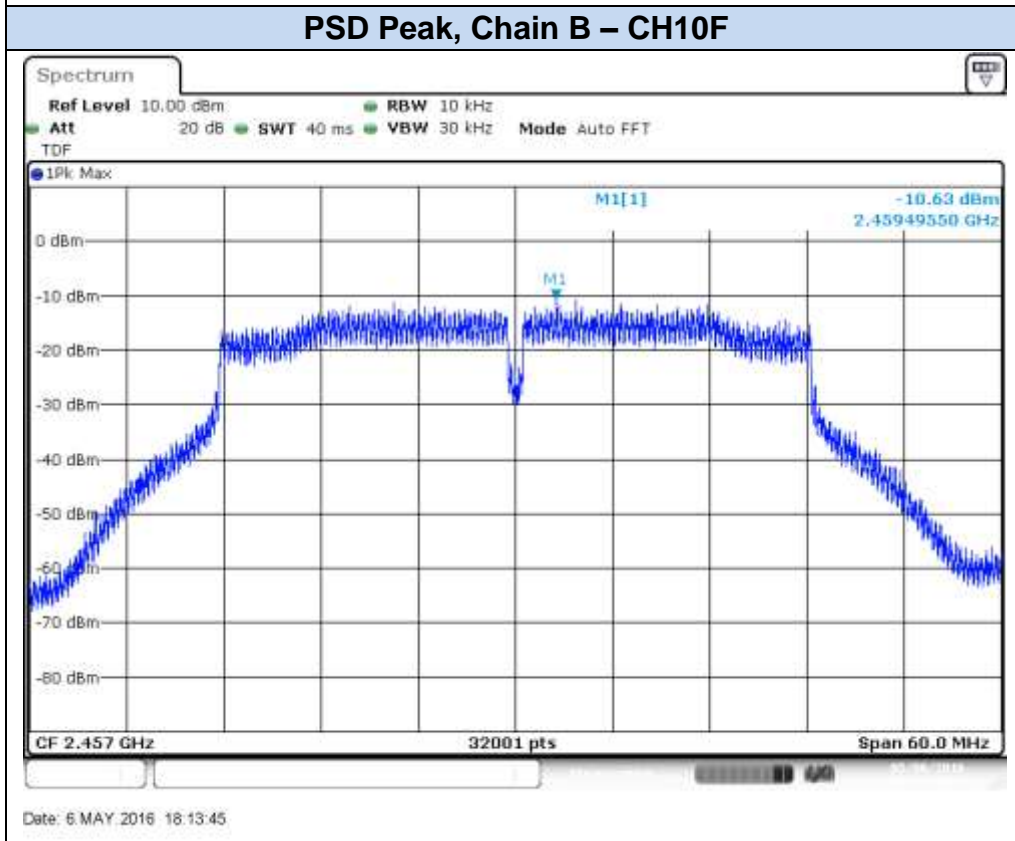
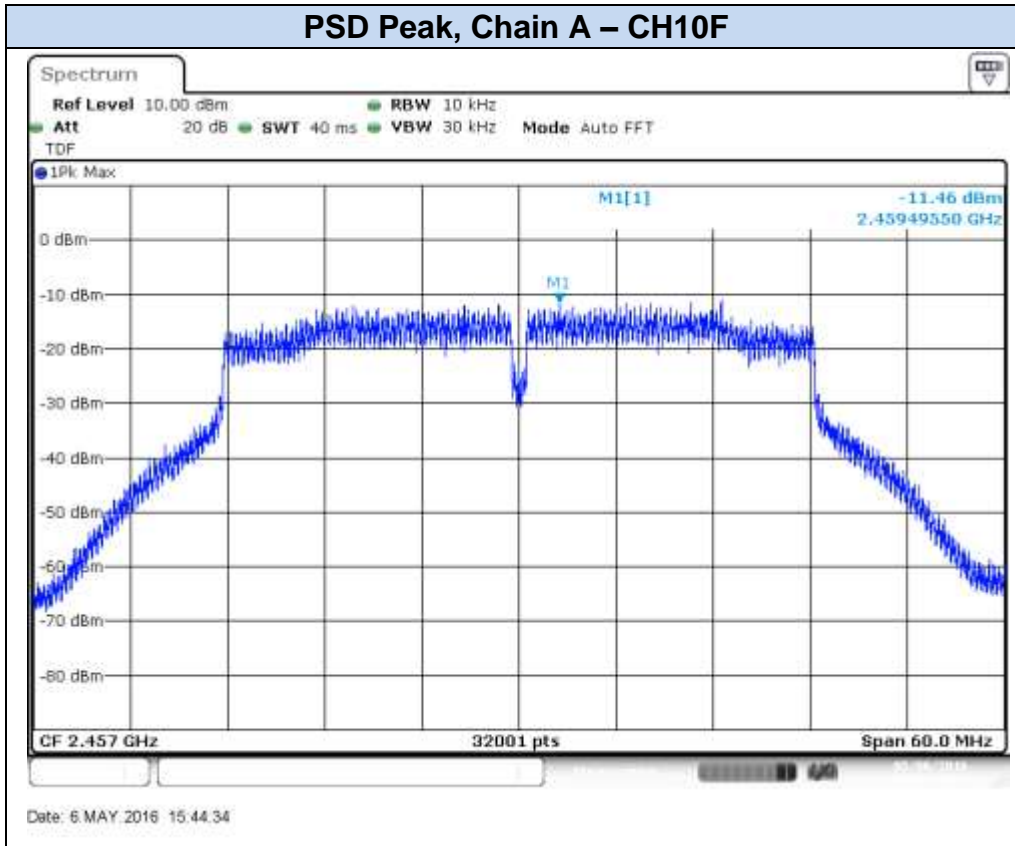

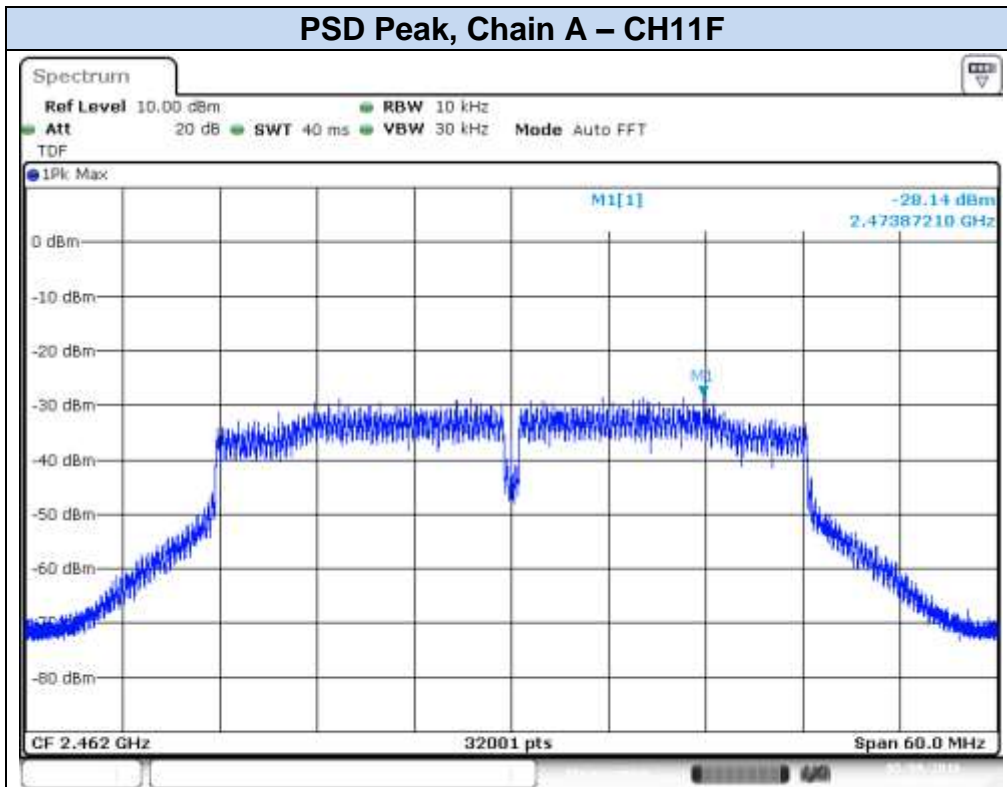

Date: 9.MAY.2016 12:09:38

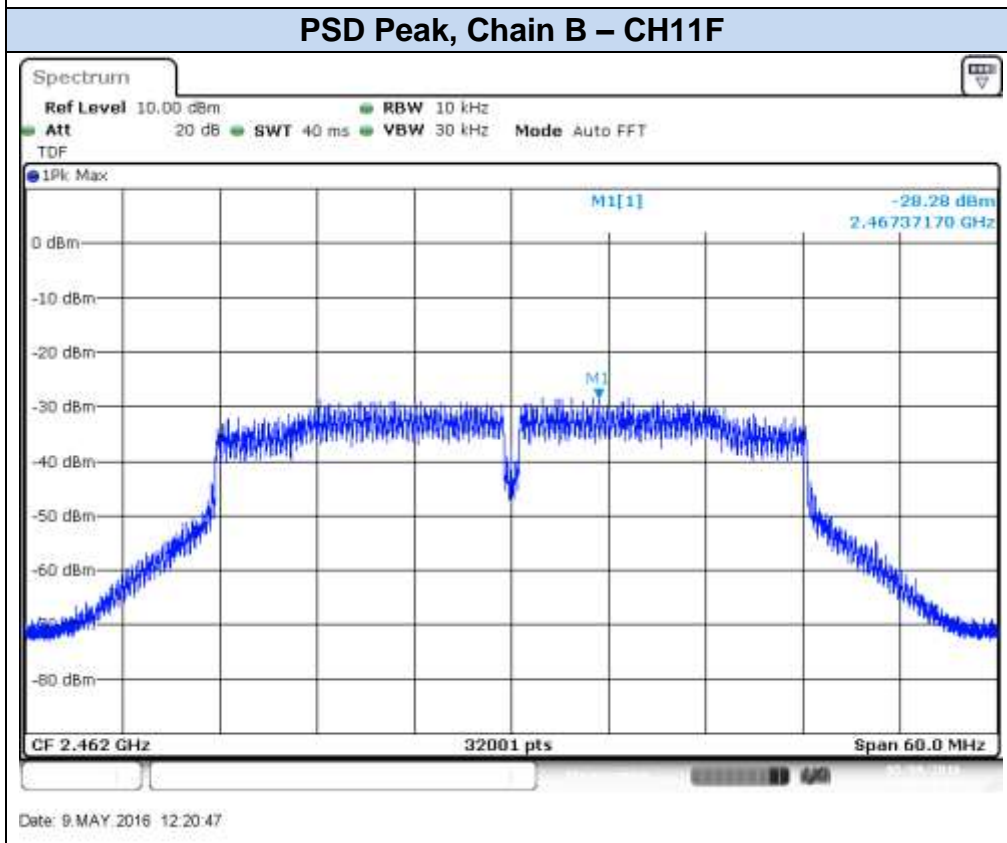

Date: 9.MAY.2016 12:20:47

## B.5 Radiated spurious emission

### Standard references:

FCC part	RSS part	Limits			
15.247 (d)	RSS-247 Clause 5.5	Radiated emissions which fall in the restricted bands, as defined in §15.205(a), must also comply with the radiated emission limits specified in §15.209(a):			
		Freq Range (MHz)	Field Strength (μV/m)	Field Strength (dBμV/m)	Meas. Distance (m)
		0.009-0.490	2400/f(kHz)	-	300
		0.490-1.705	24000/f(kHz)	-	300
		1.705-30.0	30	-	30
		30-88	100	40	3
		88-216	150	43.5	3
		216-960	200	46	3
		Above 960	500	54	3
		The emission limits shown in the above table are based on measurements employing CISPR quasi-peak detector except for the frequency bands 9-90 kHz, 110-490 kHz and above 1000 MHz. Radiated emission limits in these three bands are based on measurements employing an average detector. For average radiated emission measurements above 1000 MHz, there is also a limit specified when measuring with peak detector function corresponding to 20 dB above the indicated values in the table.			

### Test procedure:

The setups below were used to measure the radiated spurious emissions. Depending of the frequency range and bands being tested, different antennas and filters were used. The final measurement is done by varying the antenna height from 1 to 4 meters, the EUT azimuth over 360° and for both Vertical and Horizontal polarizations. The radiated spurious emissions were measured on the worst case configuration selected from the chapter *B.2 Maximum Output Power and antenna gain* and using the lowest, middle and highest channels.

#### Radiated Setup < 1GHz

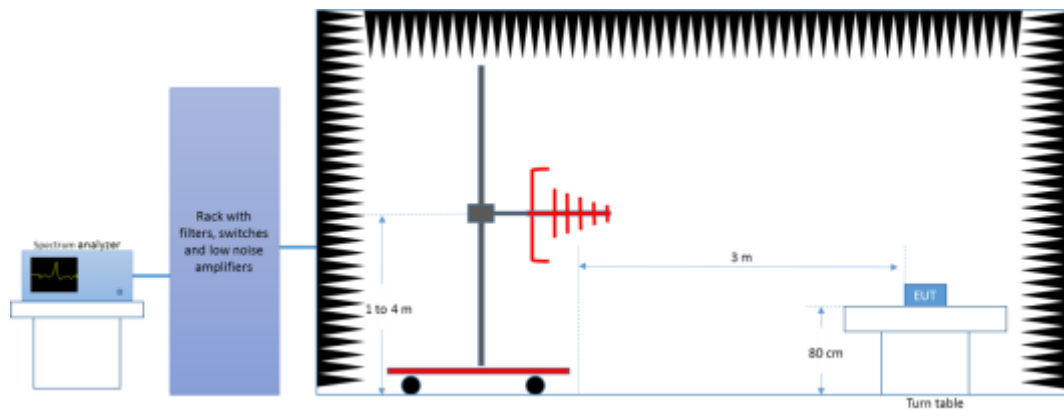

*Radiated Setup 1GHz - 18GHz*

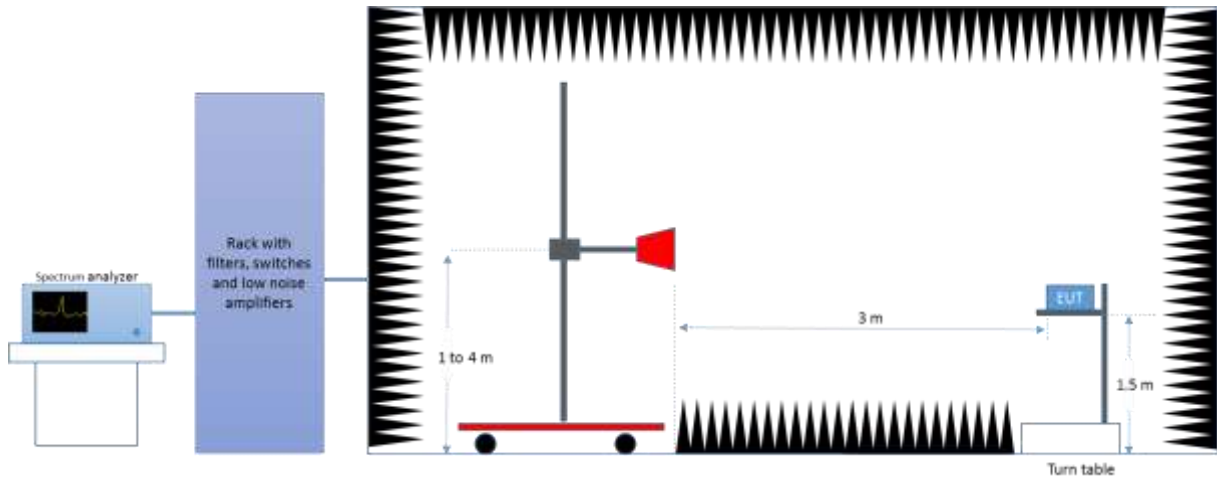

*Radiated Setup > 18GHz*

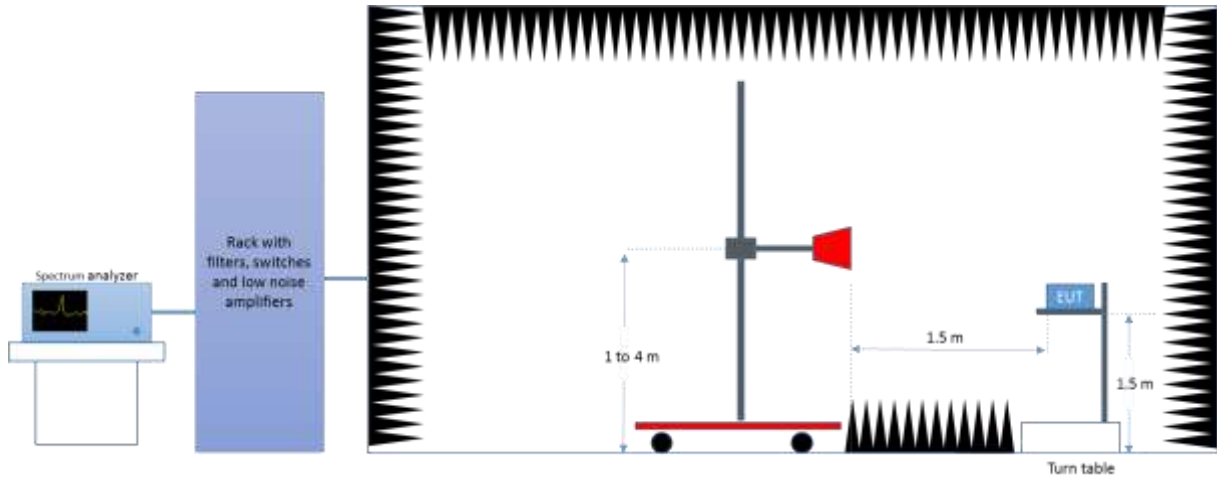

**Test Results:**

**Radiated Spurious – 30MHz – 1GHz**

**Radiated Spurious – All Modes**

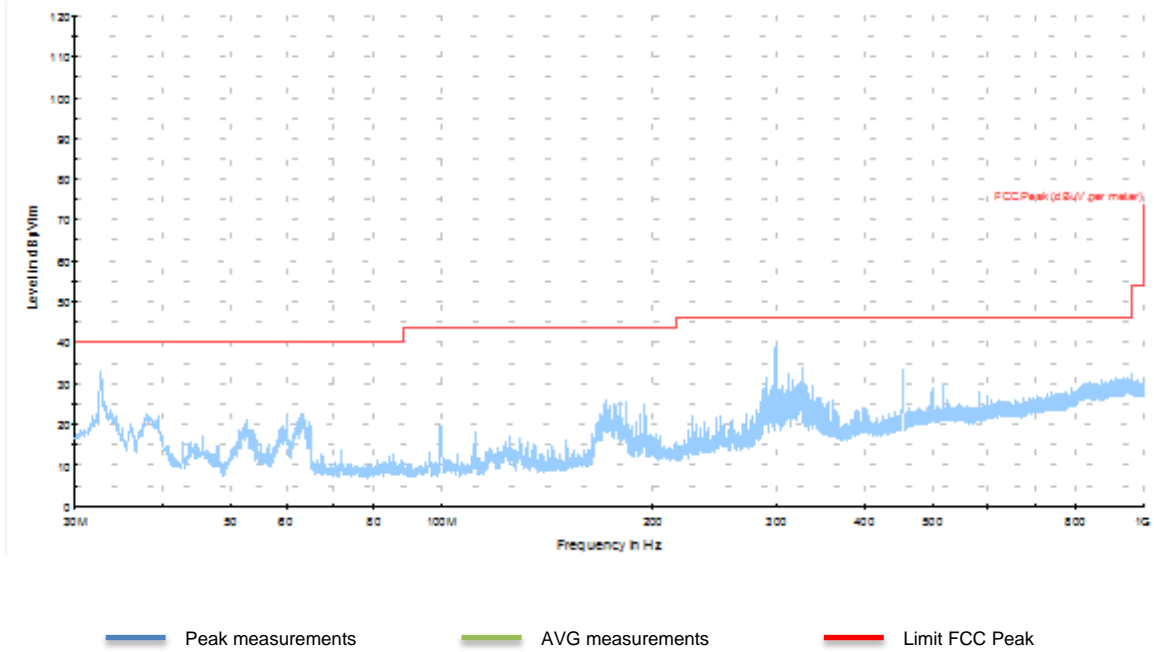

Frequency	Max Peak	Limit	Margin
MHz	dBuV/m	dBuV/m	dB
299.88	39.32	46	6.68

Note 1: The spurious signals detected do not depend on either the operating channel or the modulation mode.

## Radiated Spurious – 1 GHz to 18GHz 802.11b, 1Mbps, Chain A

### Ch1

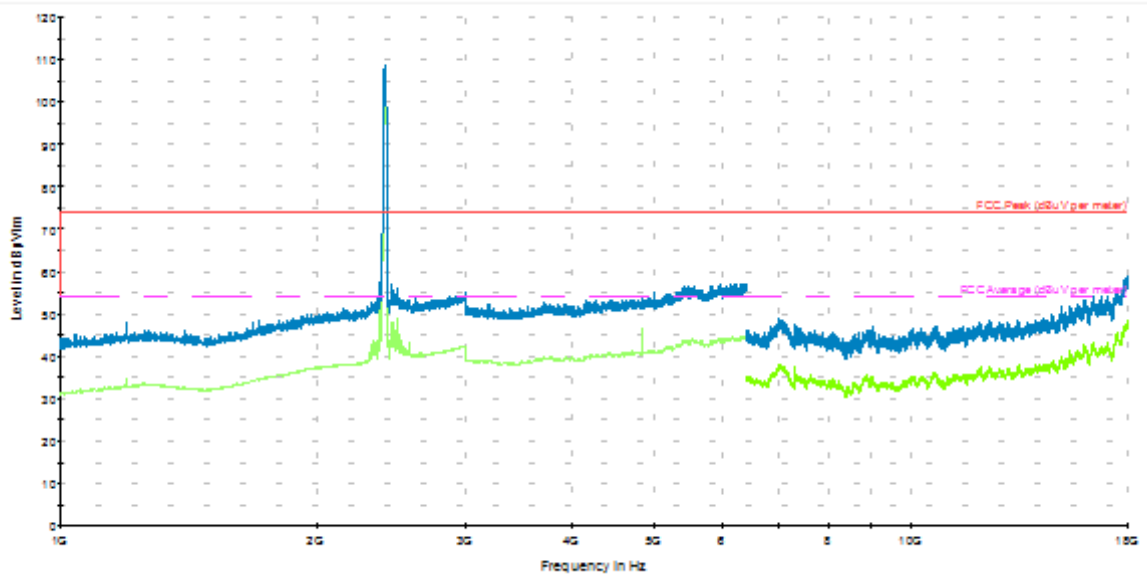

— Peak measurements    
 — AVG measurements    
 — Limit FCC Peak    
 — Limit FCC Avg

Frequency	Max Peak	Avg	Limit	Margin
MHz	dBuV/m	dBuV/m	dBuV/m	dB
2997.50	55.33	---	74.06	18.73
2997.50	---	42.50	54.06	11.55
4823.99	---	47.60	54.06	6.46
4835.22	53.65	---	74.06	20.41
17910.10	58.48	---	74.06	15.58
17918.31	---	46.99	54.06	7.07

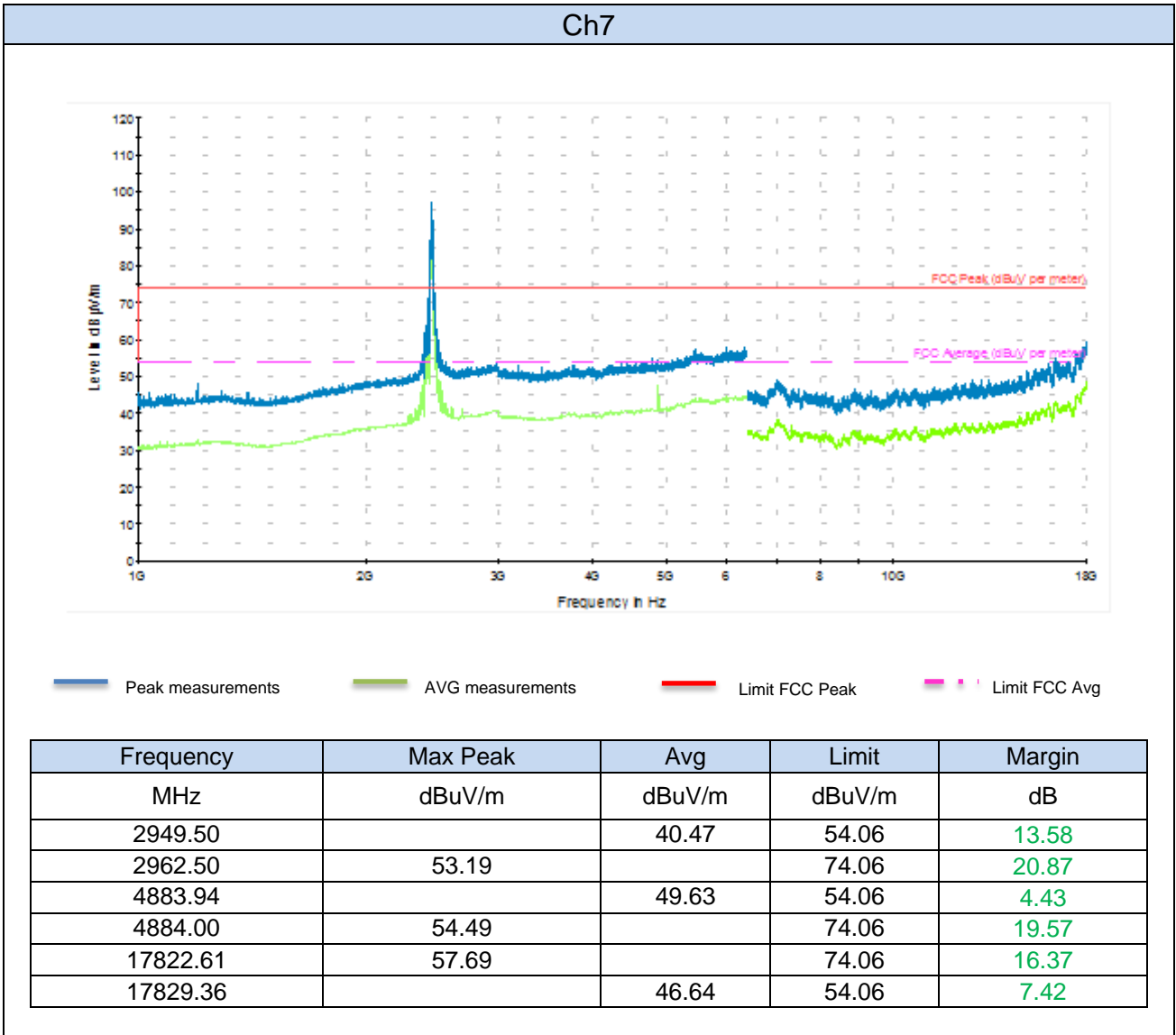

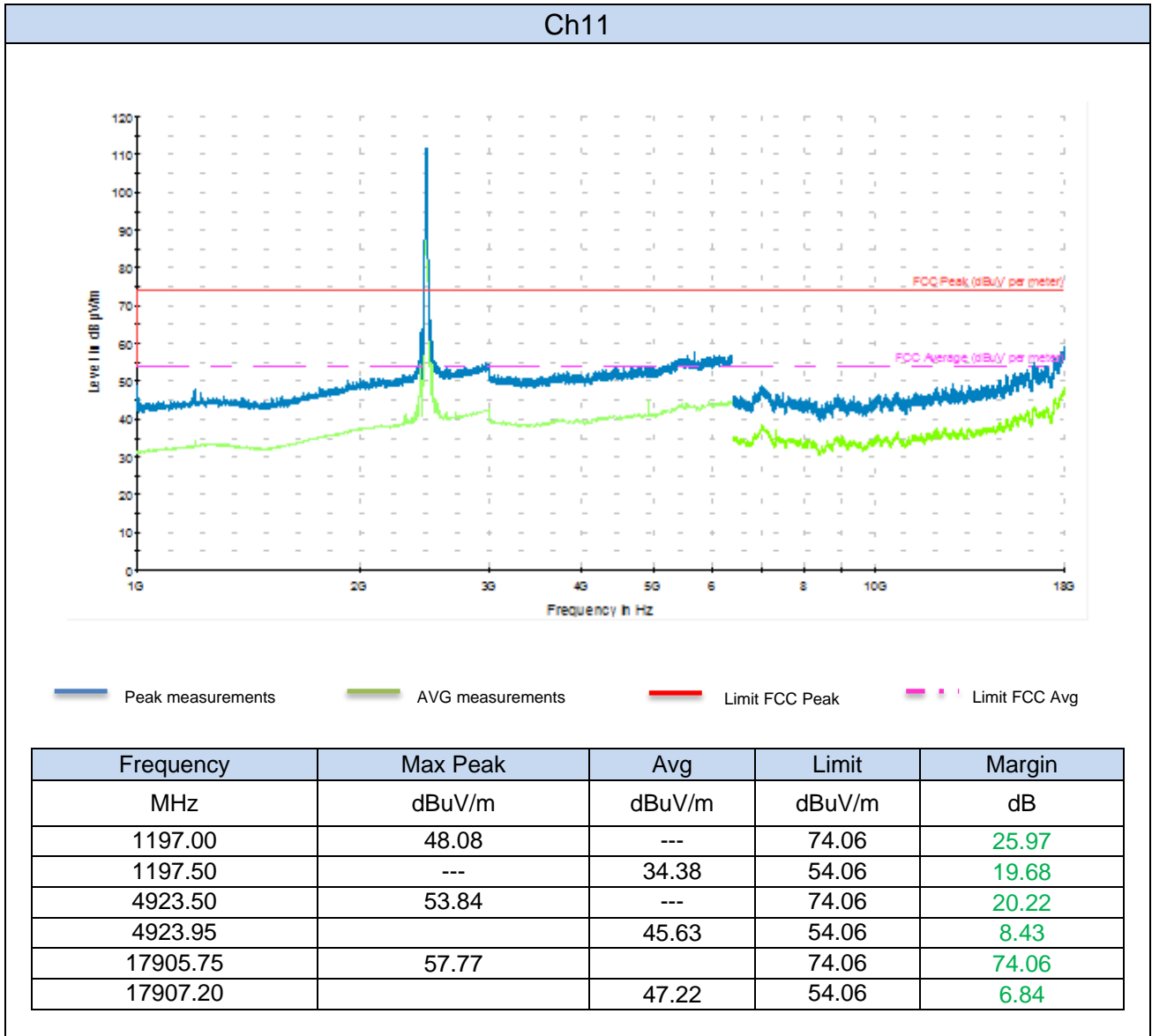



## Radiated Spurious – 1 GHz to 18GHz 802.11b, 1Mbps, Chain B

### Ch1

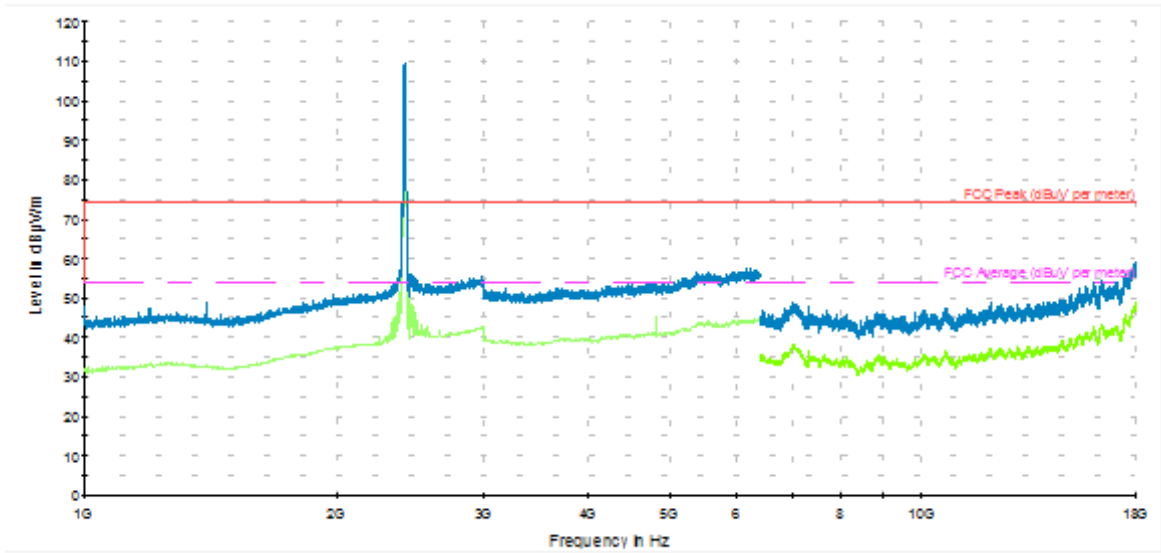

— Peak measurements    
 — AVG measurements    
 — Limit FCC Peak    
 — Limit FCC Avg

Frequency	Max Peak	Avg	Limit	Margin
MHz	dBuV/m	dBuV/m	dBuV/m	dB
2977.50	---	42.47	54.06	11.59
2988.50	55.55	---	74.06	18.51
4824.00	53.33	---	74.06	20.73
4824.00	---	45.25	54.06	8.80
17899.95	58.38	---	74.06	15.68
17907.68	---	47.81	54.06	6.25

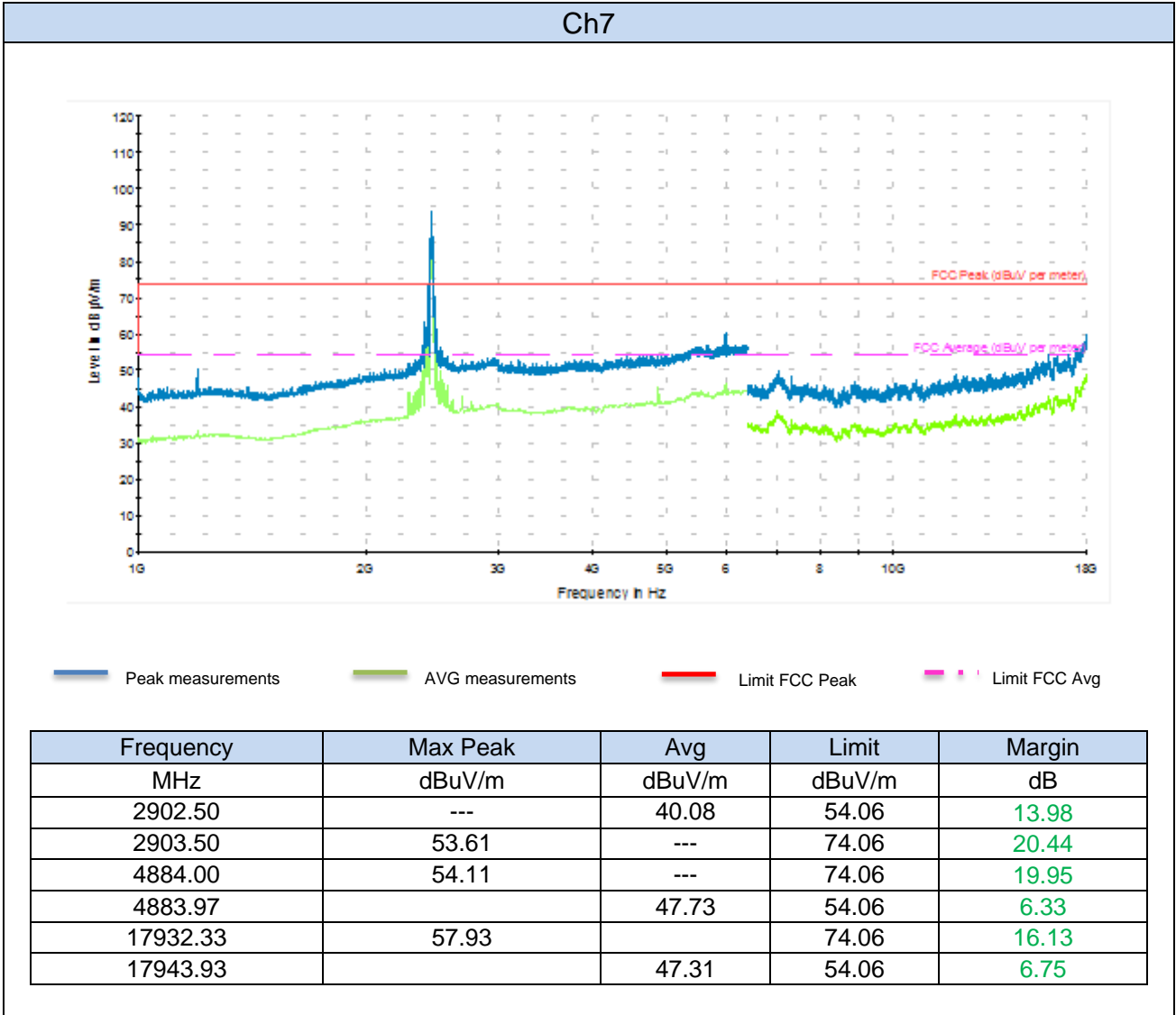

Ch11

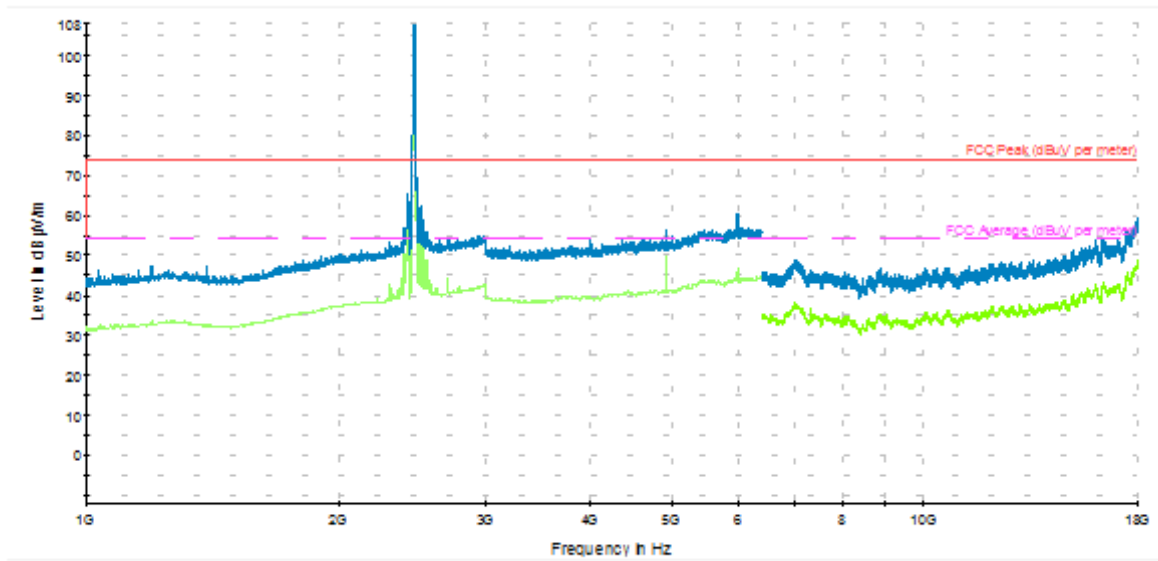

— Peak measurements     
 — AVG measurements     
 — Limit FCC Peak     
 — Limit FCC Avg

Frequency MHz	Max Peak dBuV/m	Avg dBuV/m	Limit dBuV/m	Margin dB
2981.50	55.01	---	74.06	19.04
2993.50	---	42.69	54.06	11.37
4923.89	---	48.22	54.06	5.84
4928.56	53.75	---	74.06	20.31
17978.25	58.31	---	74.06	15.75
17991.30	---	48.73	54.06	5.33

## Radiated Spurious – 1 GHz to 18GHz 802.11g, 6Mbps, Chain A

### Ch1

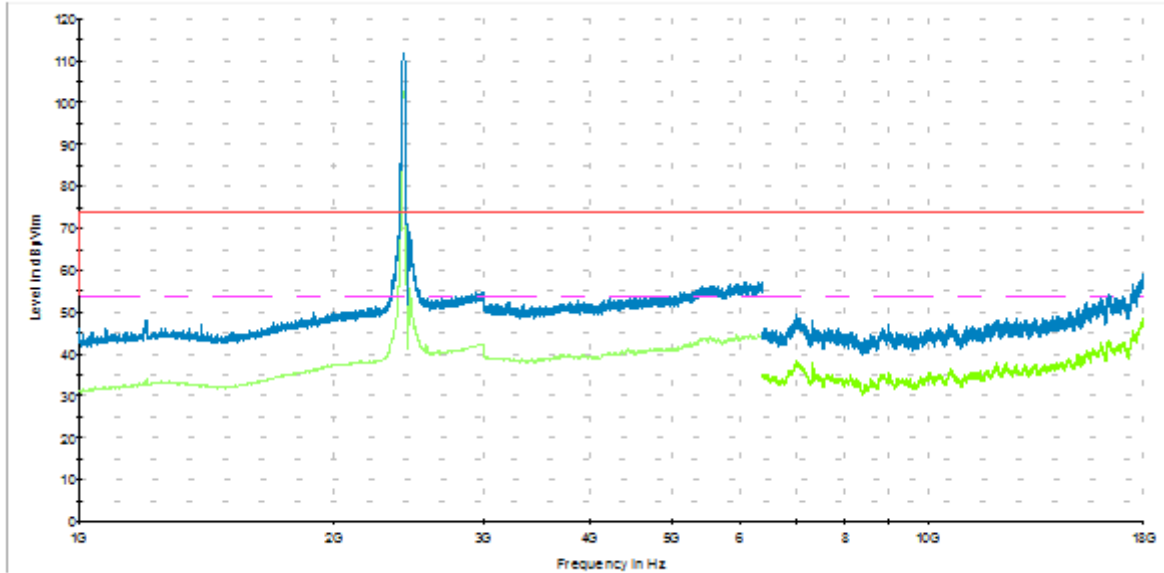

— Peak measurements    
 — AVG measurements    
 — Limit FCC Peak    
 — Limit FCC Avg

Frequency MHz	Max Peak dBuV/m	Avg dBuV/m	Limit dBuV/m	Margin dB
2992.00	---	42.51	54.06	11.55
2993.50	55.02	---	74.06	19.04
6325.50	56.97	---	74.06	17.09
6326.50	---	44.66	54.06	9.40
17976.80	58.79	---	74.06	15.27
17986.46	---	48.27	54.06	5.79

Ch7

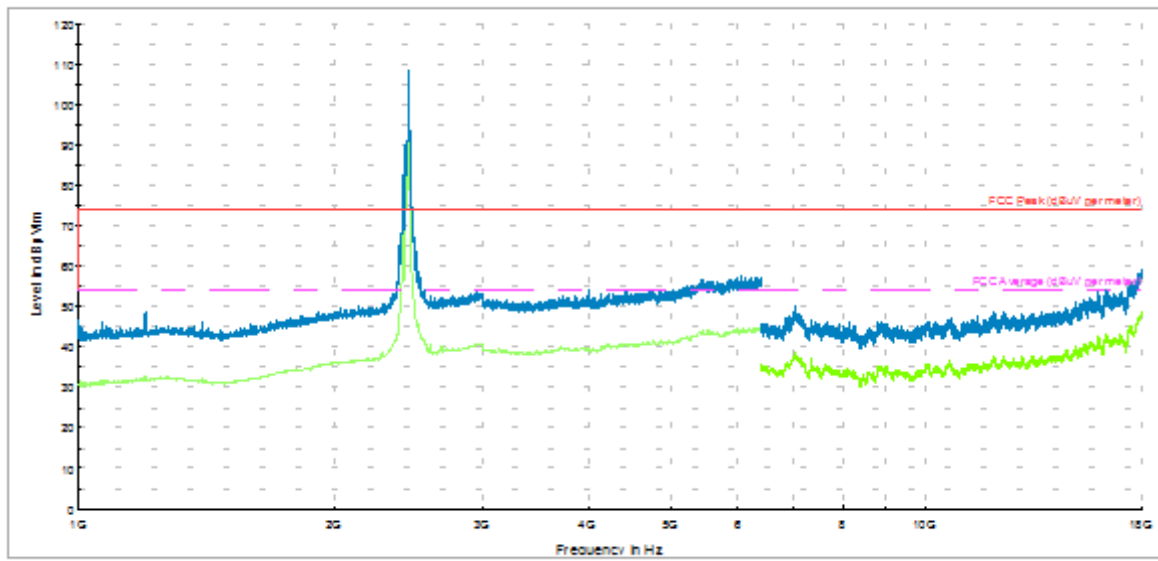

— Peak measurements    
 — AVG measurements    
 — Limit FCC Peak    
 — Limit FCC Avg

Frequency	Max Peak	Avg	Limit	Margin
MHz	dBuV/m	dBuV/m	dBuV/m	dB
2976.50	53.13	---	74.06	20.92
2982.50	---	40.74	54.06	13.31
6317.50	57.27	---	74.06	16.79
6318.00	---	44.75	54.06	9.31
17991.30	59.46	---	74.06	14.60
17991.30	---	48.80	54.06	5.26

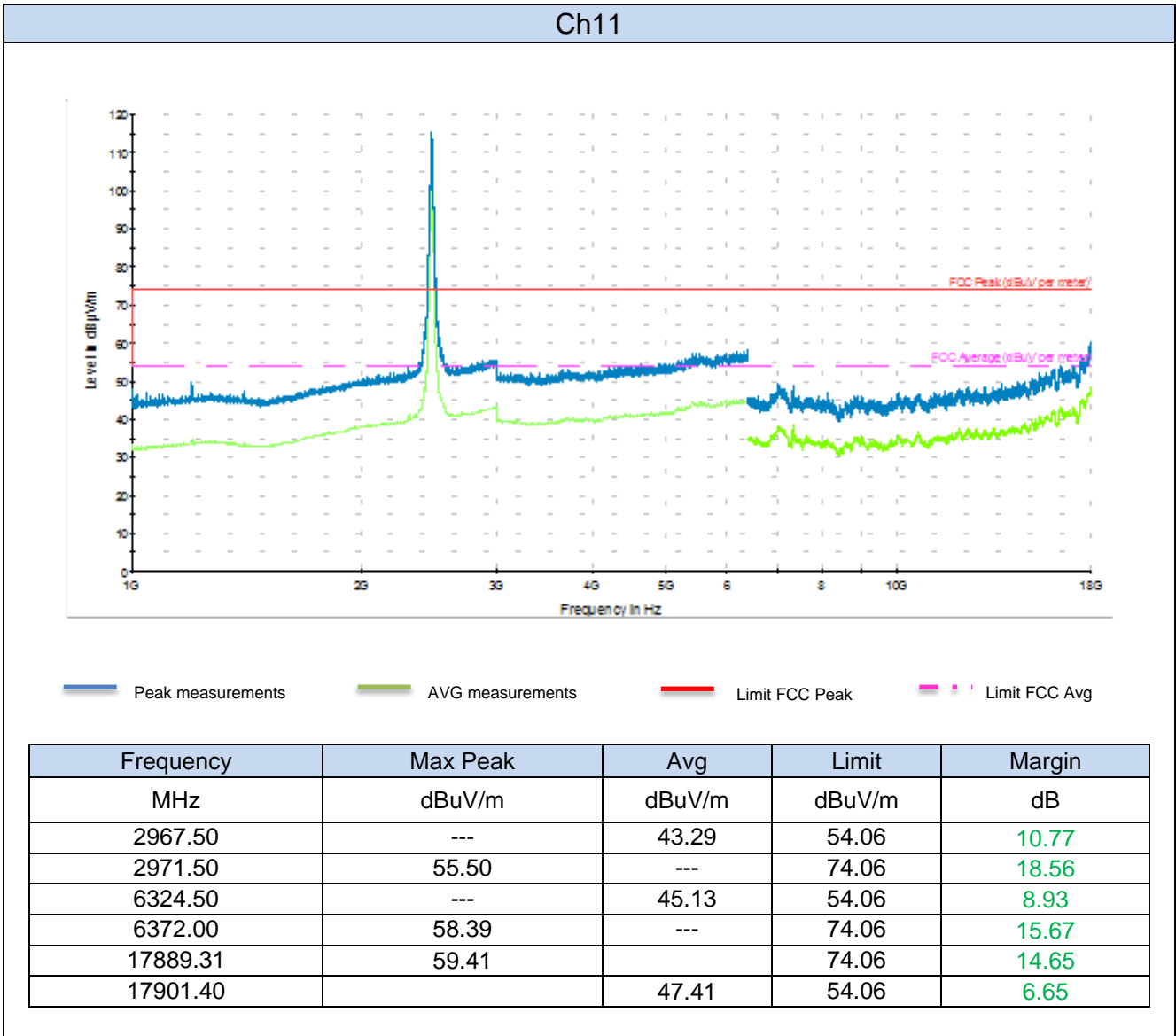

## Radiated Spurious – 1 GHz to 18 GHz 802.11g, 6Mbps, Chain B

### Ch1

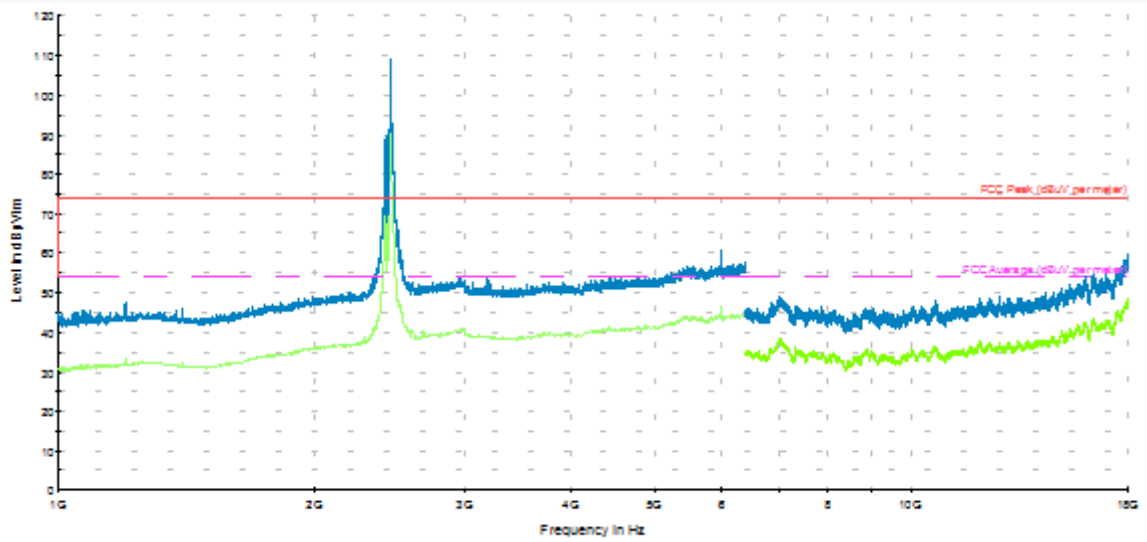

— Peak measurements    
 — AVG measurements    
 — Limit FCC Peak    
 — Limit FCC Avg

Frequency	Max Peak	Avg	Limit	Margin
MHz	dBuV/m	dBuV/m	dBuV/m	dB
2965.50	53.99	---	74.06	20.07
2968.50	---	40.77	54.06	13.29
5994.50	60.74	---	74.06	13.32
5994.50	---	46.36	54.06	7.69
17990.81	59.08	---	74.06	14.98
17993.71	---	48.34	54.06	5.72

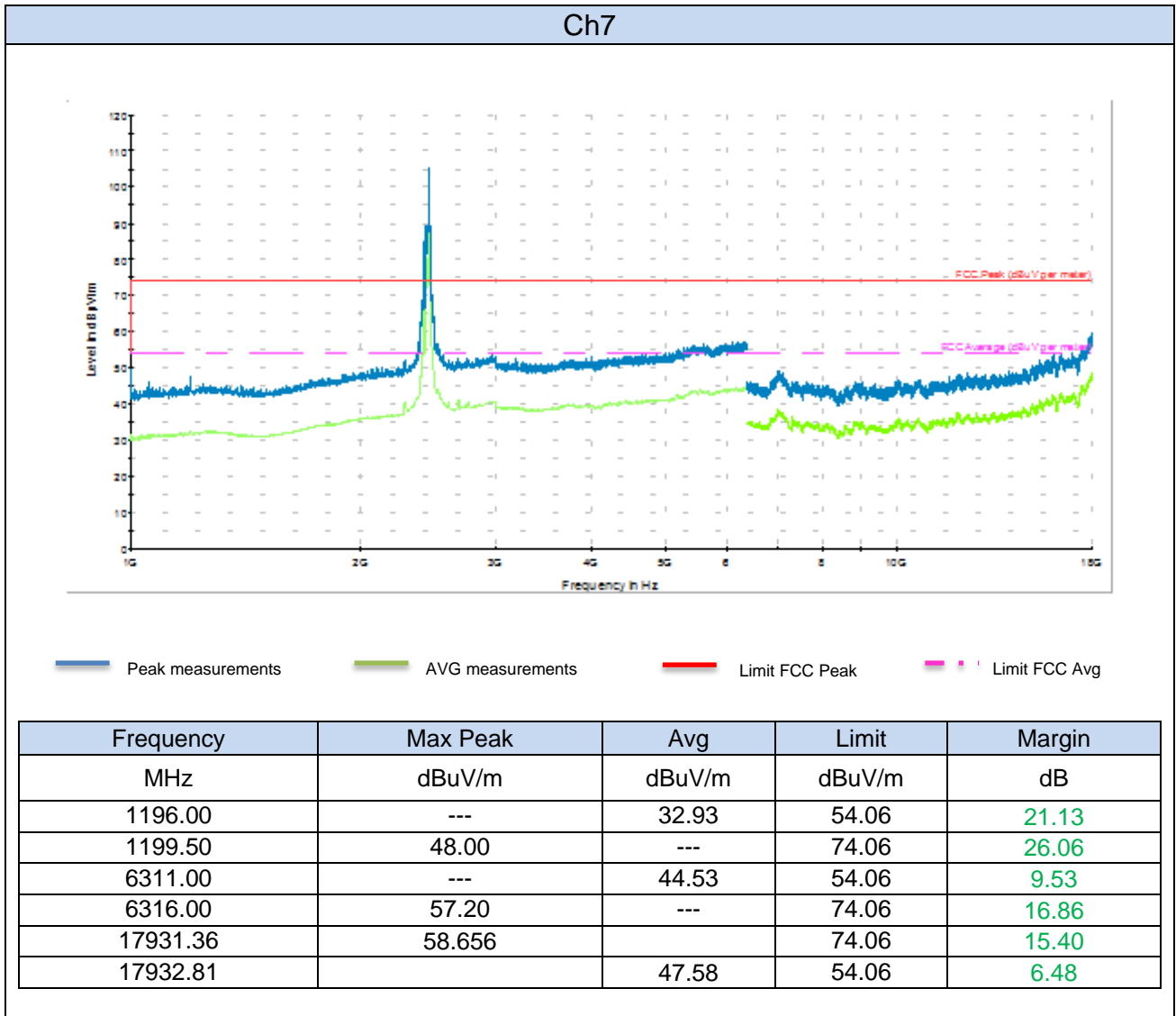



Ch11

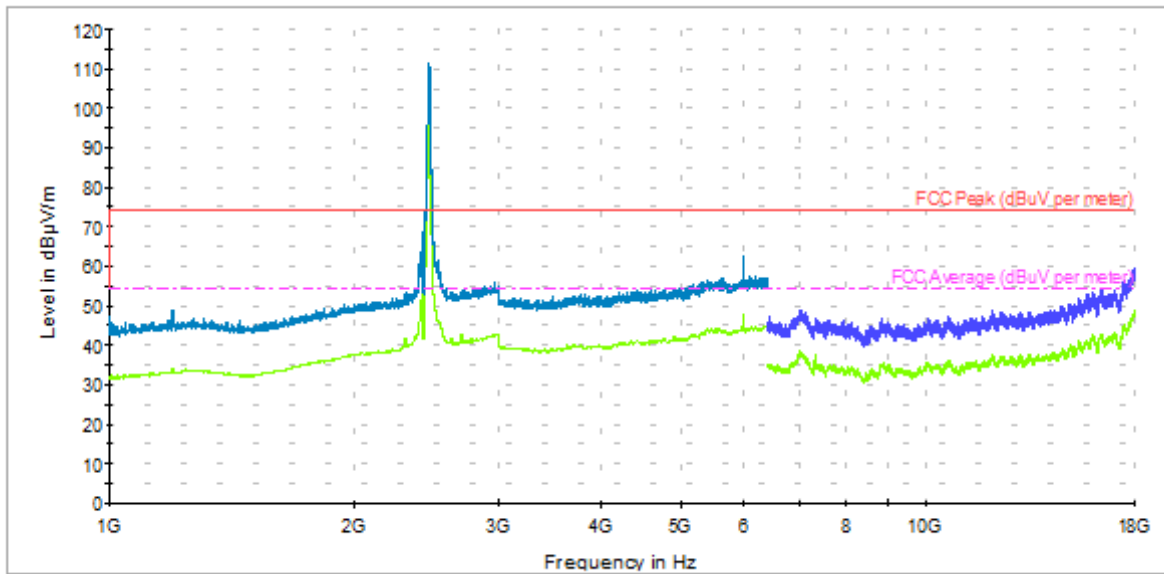

— Peak measurements    
 — AVG measurements    
 — Limit FCC Peak    
 - - - Limit FCC Avg

Frequency	Max Peak	Avg	Limit	Margin
MHz	dBuV/m	dBuV/m	dBuV/m	dB
2962.00	55.86	---	74.06	18.19
2974.00	---	42.63	54.06	11.43
5996.50	61.60	---	74.06	12.45
5995.07		49.68	54.06	4.38
17962.30	58.95		74.06	15.11
17981.63		48.13	54.06	5.93

## Radiated Spurious – 1 GHz to 18GHz 802.11n20, HT0, Chain A

### Ch1

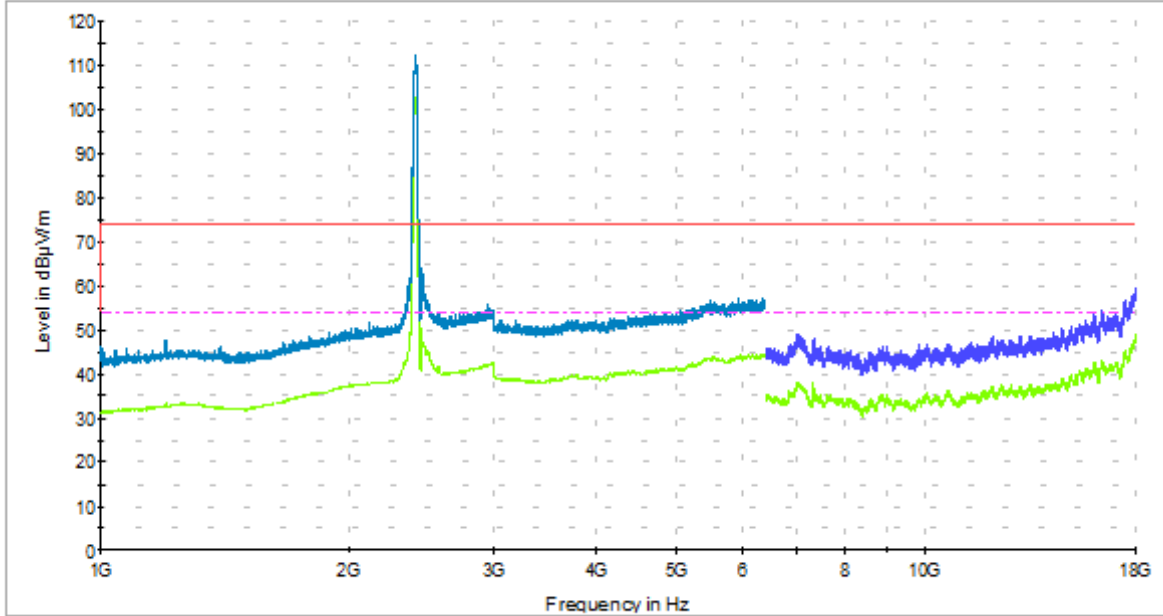

— Peak measurements    
 — AVG measurements    
 — Limit FCC Peak    
 - - - Limit FCC Avg

Frequency	Max Peak	Avg	Limit	Margin
MHz	dBuV/m	dBuV/m	dBuV/m	dB
2944.50	---	42.07	54.06	11.98
2955.50	56.11	---	74.06	17.95
6180.00	---	44.37	54.06	9.68
6251.50	56.78	---	74.06	17.28
17924.11	58.10	---	74.06	15.96
17956.50	---	47.86	54.06	6.20

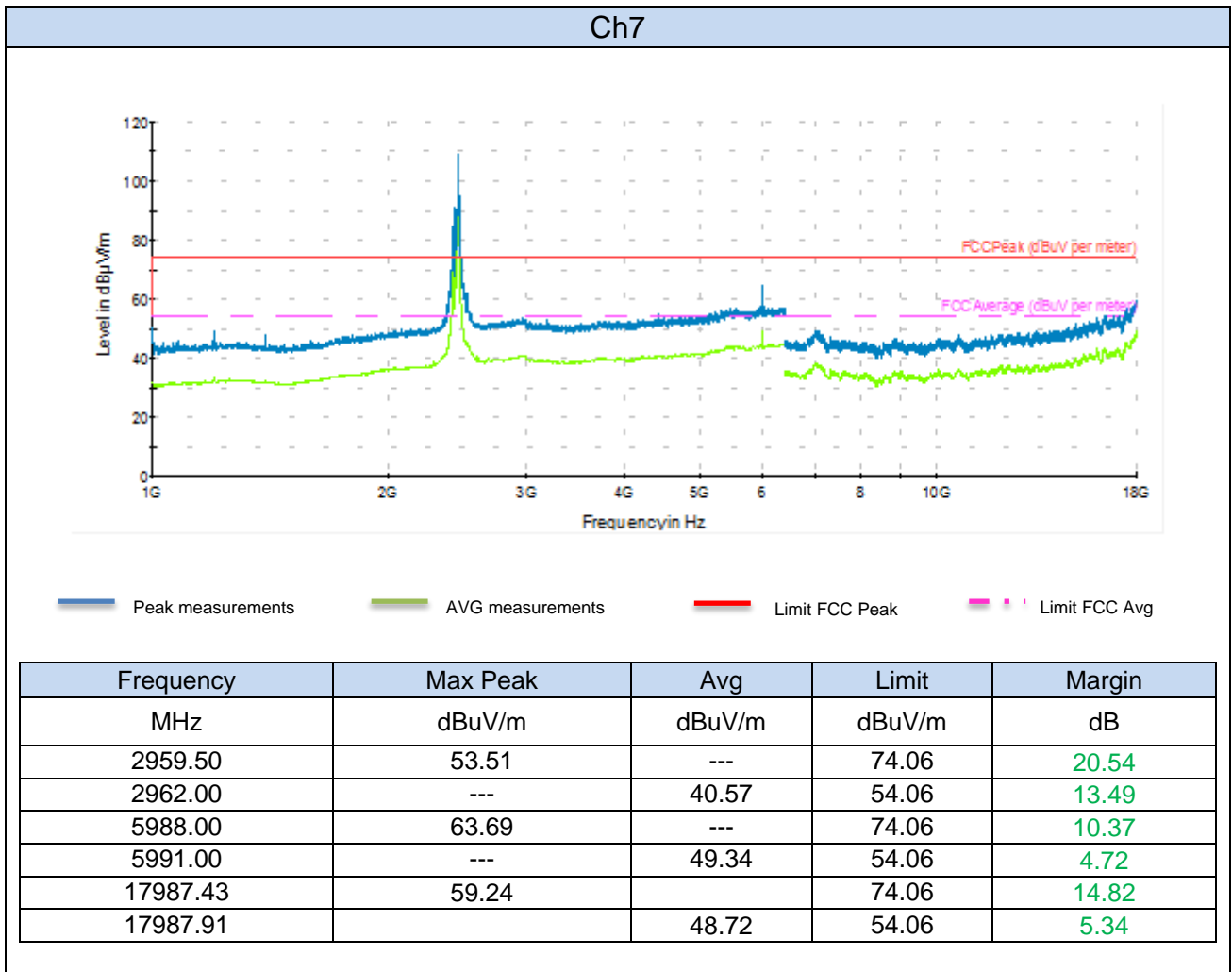

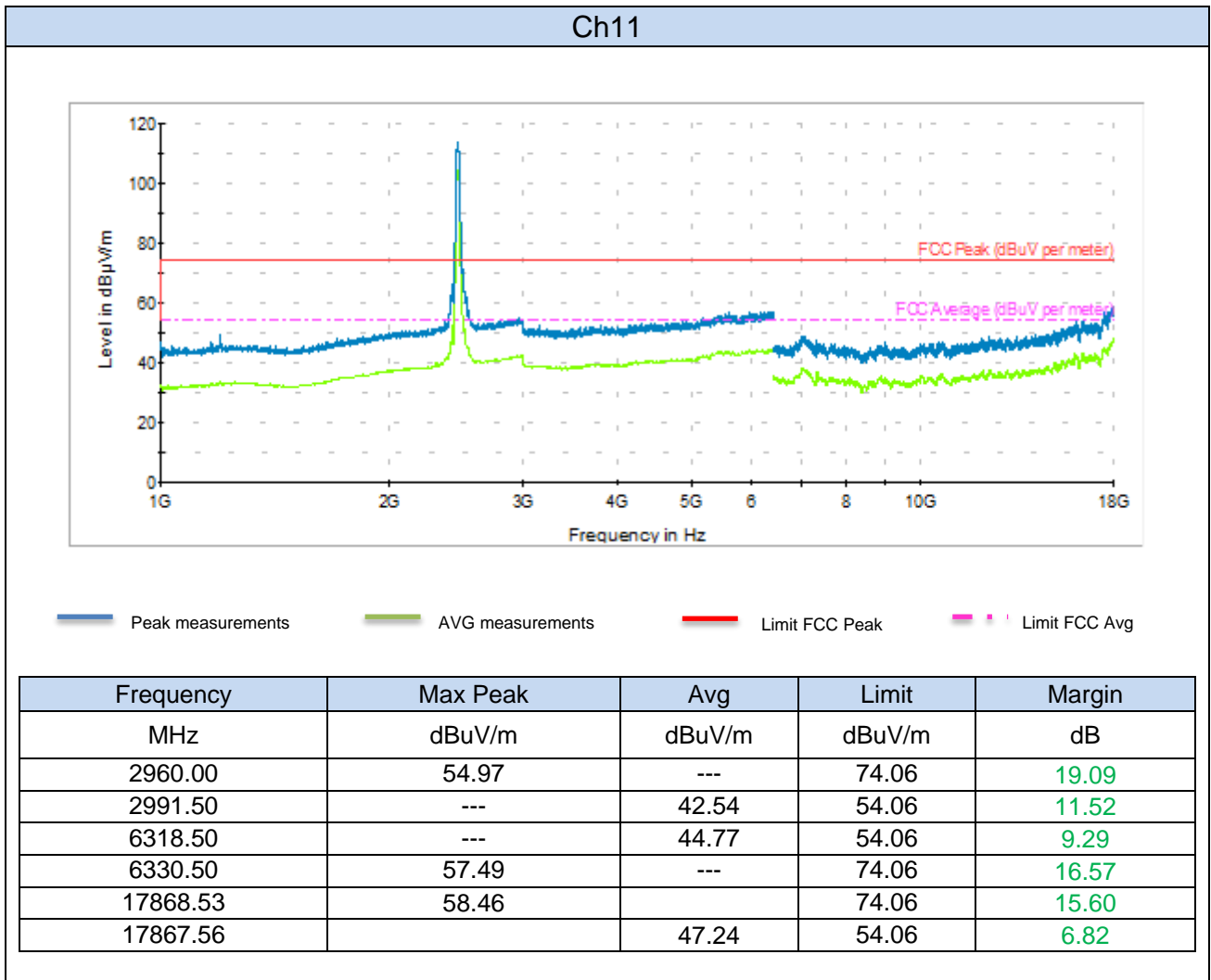

## Radiated Spurious – 1 GHz to 18GHz 802.11n20, HT0, Chain B

Ch1

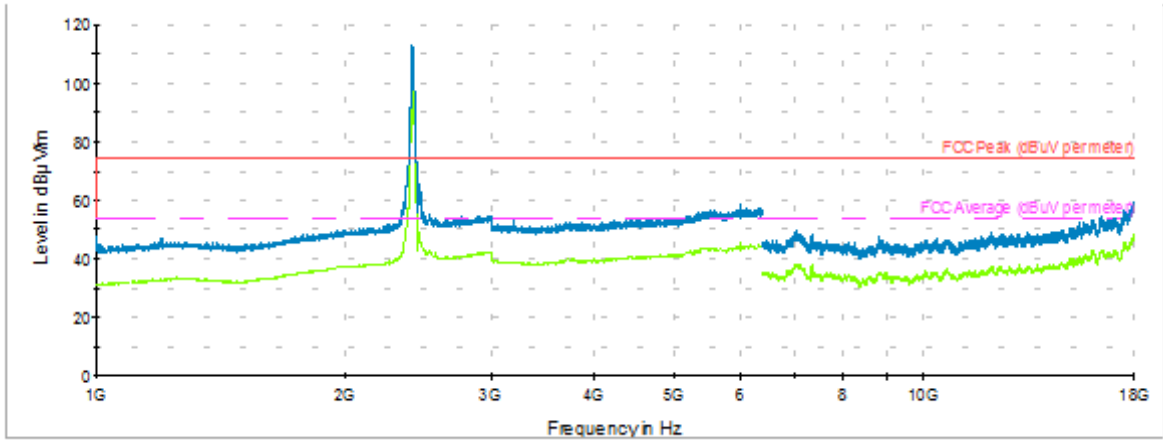

— Peak measurements     
 — AVG measurements     
 — Limit FCC Peak     
 - - - Limit FCC Avg

Frequency	Max Peak	Avg	Limit	Margin
MHz	dBuV/m	dBuV/m	dBuV/m	dB
2908.00	---	41.83	54.06	12.22
2927.50	53.79	---	74.06	20.27
5991.00	---	45.57	54.06	8.49
5995.00	59.14	---	74.06	14.92
17980.18	59.20	---	74.06	14.86
17986.95	---	48.46	54.06	5.60

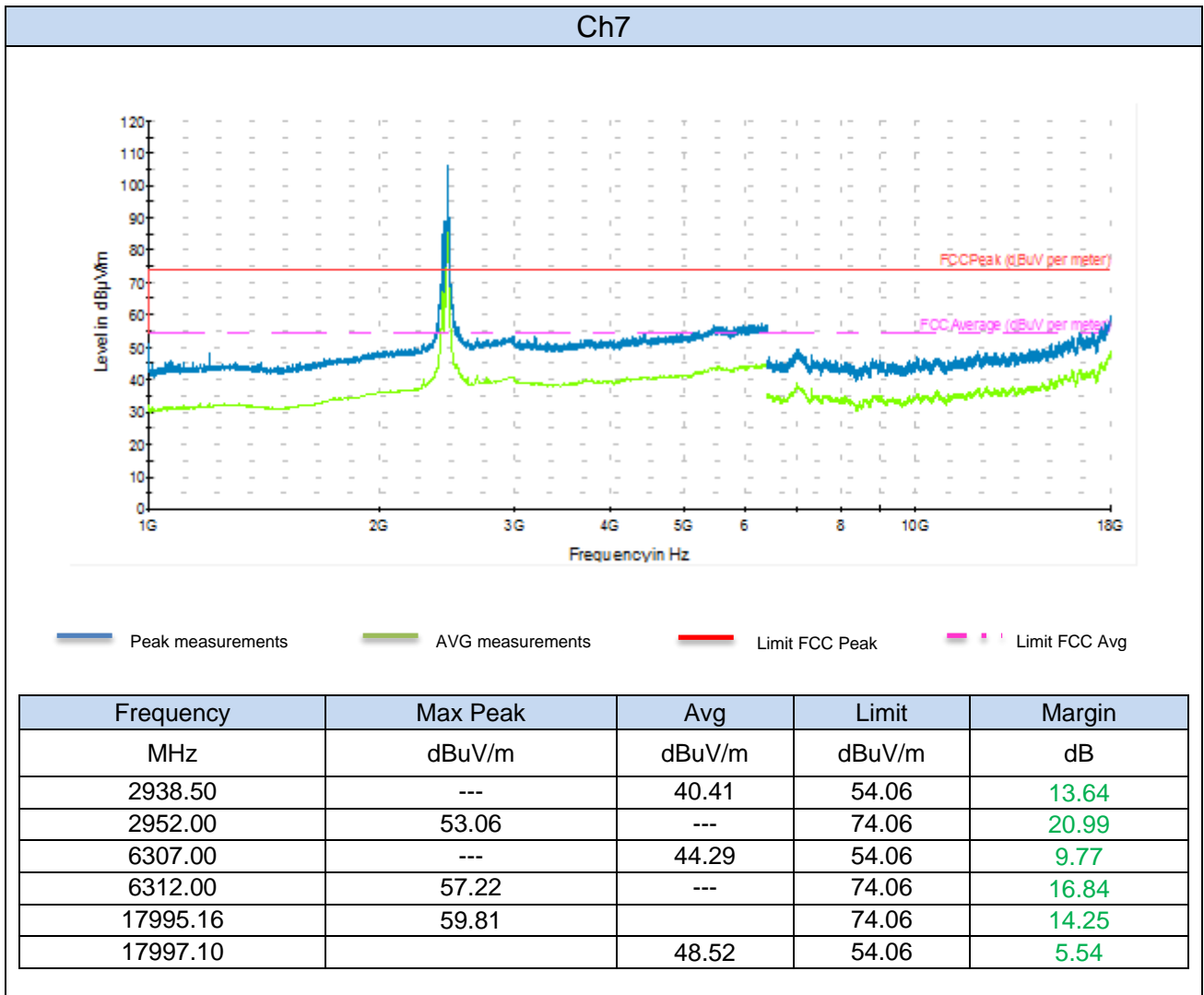

Ch11

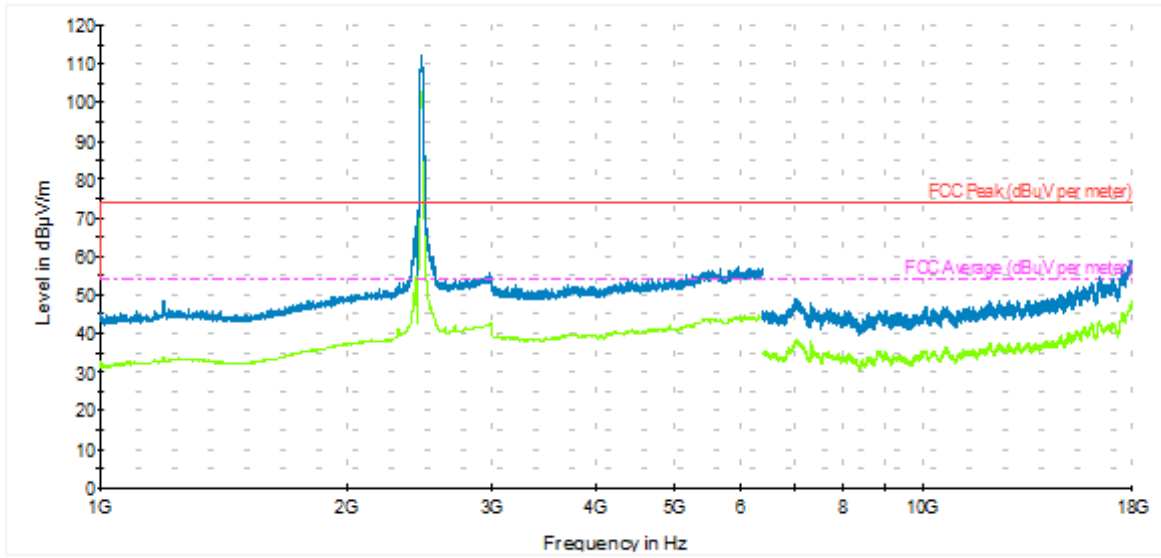

— Peak measurements    
 — AVG measurements    
 — Limit FCC Peak    
 - - - Limit FCC Avg

Frequency	Max Peak	Avg	Limit	Margin
MHz	dBuV/m	dBuV/m	dBuV/m	dB
2921.00	54.34	---	74.06	19.72
2926.50	---	41.97	54.06	12.09
6246.50	---	44.46	54.06	9.60
6323.50	57.06	---	74.06	17.00
17980.66	58.98	---	74.06	15.08
17984.05	---	48.47	54.06	5.59

## Radiated Spurious – 1 GHz to 18GHz 802.11n20, HT0, Chain A+B

### Ch1

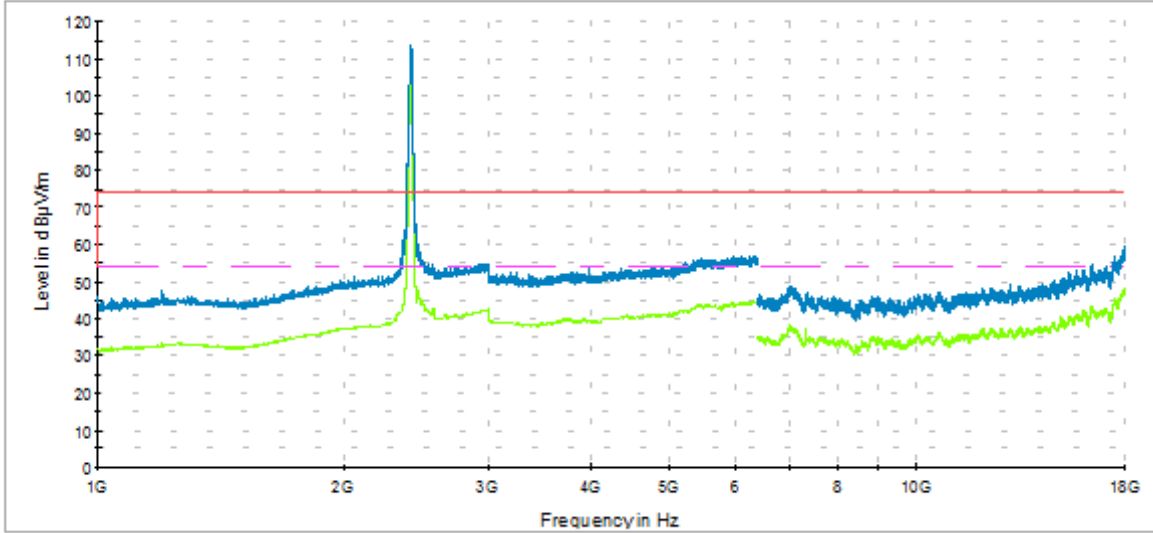

— Peak measurements     
 — AVG measurements     
 — Limit FCC Peak     
 - - - Limit FCC Avg

Frequency	Max Peak	Avg	Limit	Margin
MHz	dBuV/m	dBuV/m	dBuV/m	dB
2968.00	---	42.52	54.06	11.54
2998.50	55.14	---	74.06	18.92
6332.50	---	44.83	54.06	9.22
6337.50	56.85	---	74.06	17.21
17982.60	58.29	---	74.06	15.77
17988.88	---	49.44	54.06	4.62



Ch7

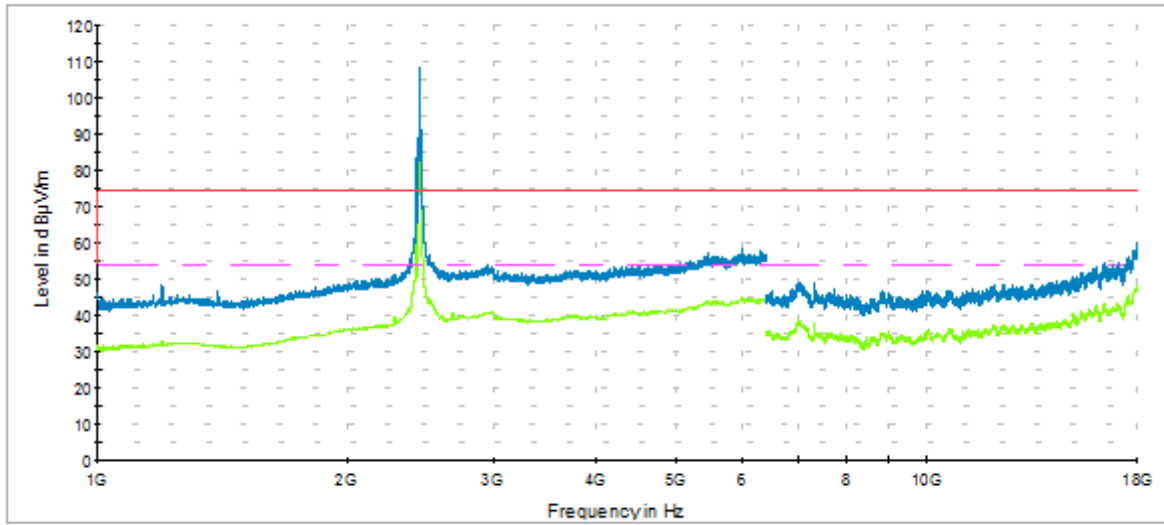

— Peak measurements    
 — AVG measurements    
 — Limit FCC Peak    
 - - - Limit FCC Avg

Frequency	Max Peak	Avg	Limit	Margin
MHz	dBuV/m	dBuV/m	dBuV/m	dB
2956.50	53.80	---	74.06	20.26
2962.50	---	40.57	54.06	13.49
6317.00	---	44.63	54.06	9.43
6320.50	57.91	---	74.06	16.15
17993.71	60.41	---	74.06	13.65
17999.03	---	48.57	54.06	5.49

Ch11

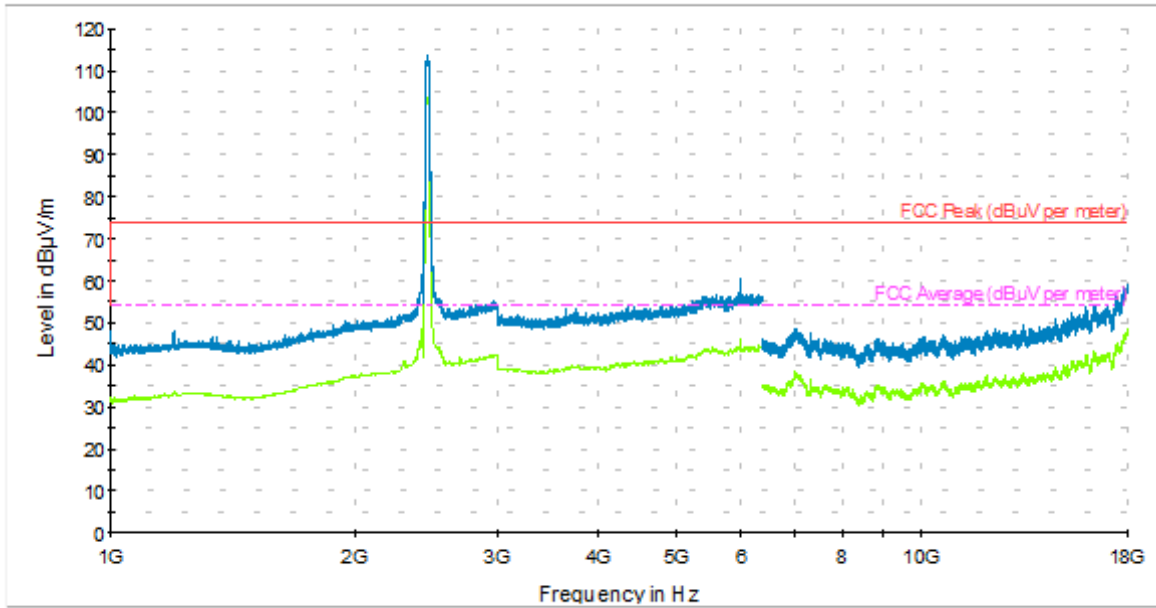

— Peak measurements    
 — AVG measurements    
 — Limit FCC Peak    
 - - - Limit FCC Avg

Frequency	Max Peak	Avg	Limit	Margin
MHz	dBuV/m	dBuV/m	dBuV/m	dB
2975.50	---	42.34	54.06	11.72
2981.00	55.28	---	74.06	18.78
5989.00	60.79	---	74.06	13.27
5996.50	---	46.22	54.06	7.84
17990.81	59.26	---	74.06	14.80
17995.16	---	48.69	54.06	5.37

## Radiated Spurious – 1 GHz to 18GHz 802.11n40, HT0, Chain A

### Ch3F

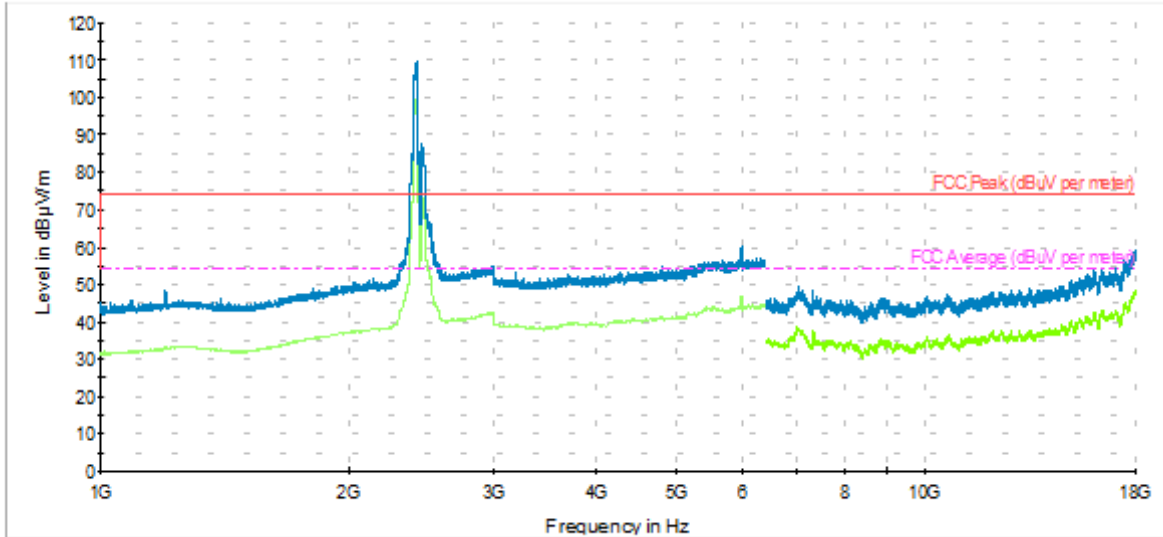

— Peak measurements    
 — AVG measurements    
 — Limit FCC Peak    
 — Limit FCC Avg

Frequency	Max Peak	Avg	Limit	Margin
MHz	dBuV/m	dBuV/m	dBuV/m	dB
2940.00	54.49	---	74.06	19.57
2959.50	---	42.14	54.06	11.92
5992.50	---	46.86	54.06	7.20
5995.50	60.00	---	74.06	14.06
17994.20	59.29	---	74.06	14.77
17996.61	---	48.77	54.06	5.29

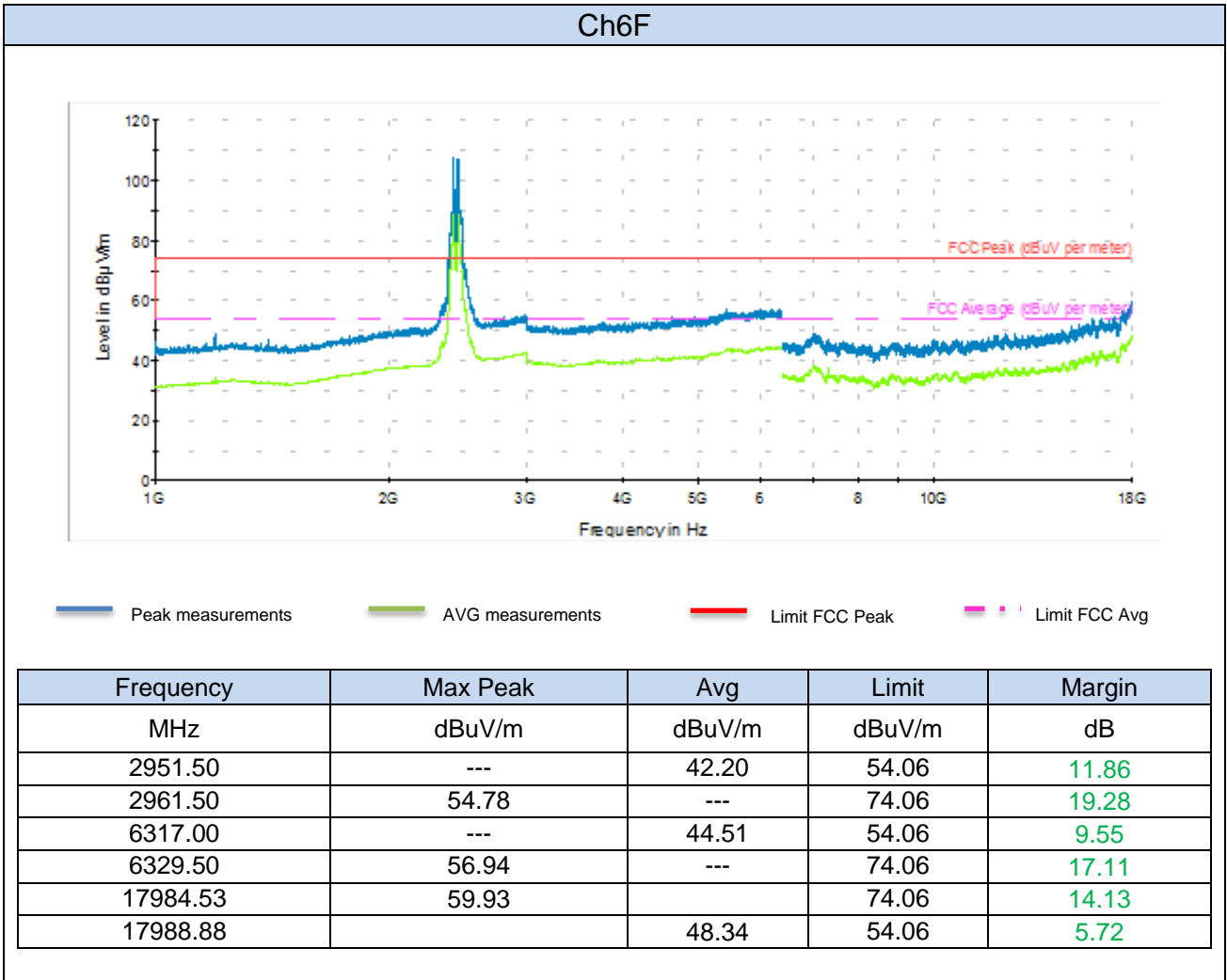

Ch9F

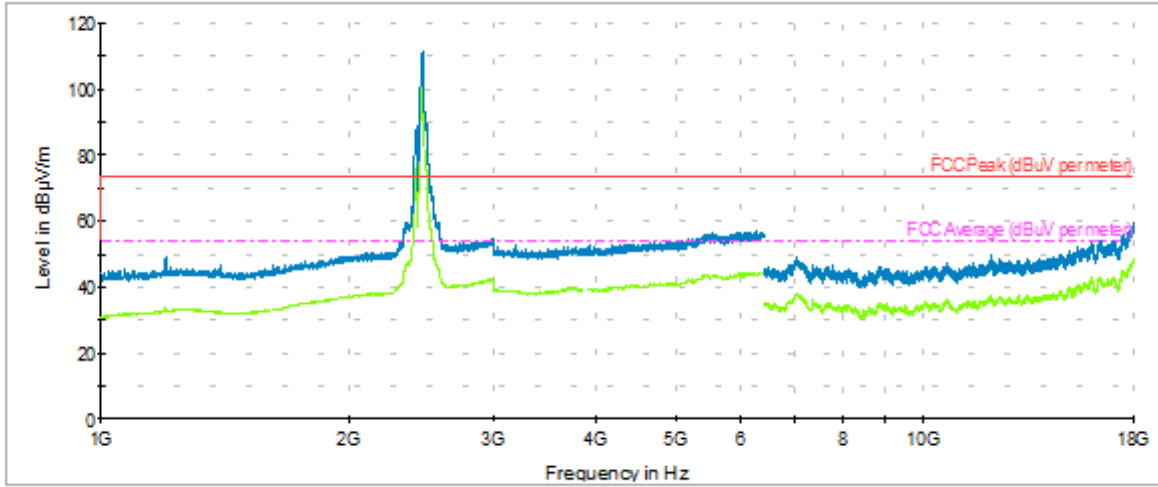

— Peak measurements     
 — AVG measurements     
 — Limit FCC Peak     
 - - - Limit FCC Avg

Frequency	Max Peak	Avg	Limit	Margin
MHz	dBuV/m	dBuV/m	dBuV/m	dB
2944.00	---	42.08	54.06	11.98
2956.00	54.48	---	74.06	19.58
6315.00	---	44.37	54.06	9.69
6346.00	56.90	---	74.06	17.16
17989.85	59.61	---	74.06	14.45
17994.68	---	48.66	54.06	5.40

## Radiated Spurious – 1 GHz to 18GHz 802.11n40, HT0, Chain B

### Ch3F

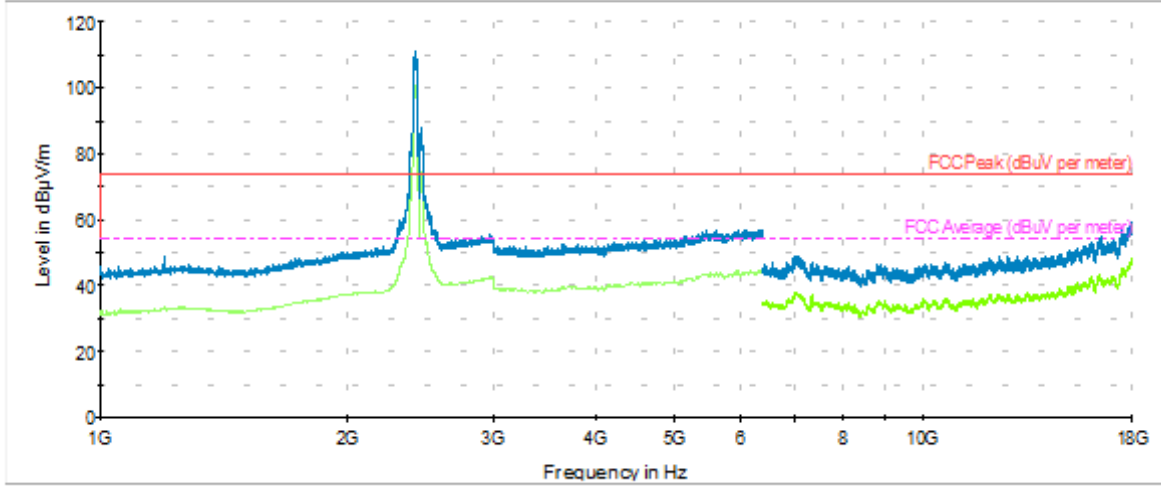

— Peak measurements    
 — AVG measurements    
 — Limit FCC Peak    
 — Limit FCC Avg

Frequency MHz	Max Peak dBuV/m	Avg dBuV/m	Limit dBuV/m	Margin dB
2970.50	---	42.39	54.06	11.67
2976.00	55.63	---	74.06	18.43
6254.00	---	44.33	54.06	9.73
6327.00	57.16	---	74.06	16.90
17955.05	58.27	---	74.06	15.79
17975.83	---	48.29	54.06	5.77

Ch6F

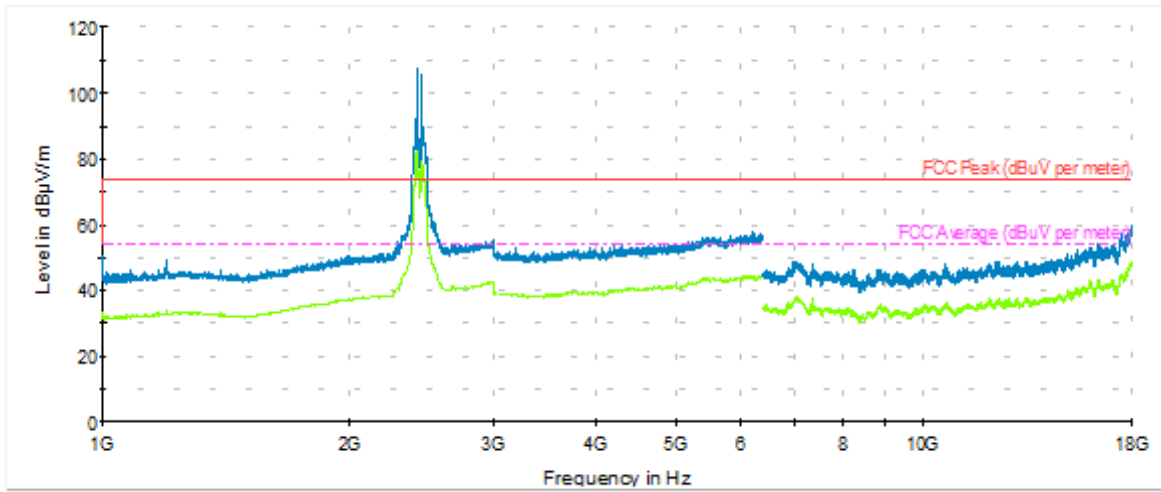

— Peak measurements     
 — AVG measurements     
 — Limit FCC Peak     
 - - - Limit FCC Avg

Frequency	Max Peak	Avg	Limit	Margin
MHz	dBuV/m	dBuV/m	dBuV/m	dB
2942.00	---	42.19	54.06	11.86
2974.50	55.28	---	74.06	18.78
6324.00	---	44.56	54.06	9.50
6332.50	57.32	---	74.06	16.74
17982.11	59.37	---	74.06	14.69
17990.33	---	48.50	54.06	5.56

Ch9F

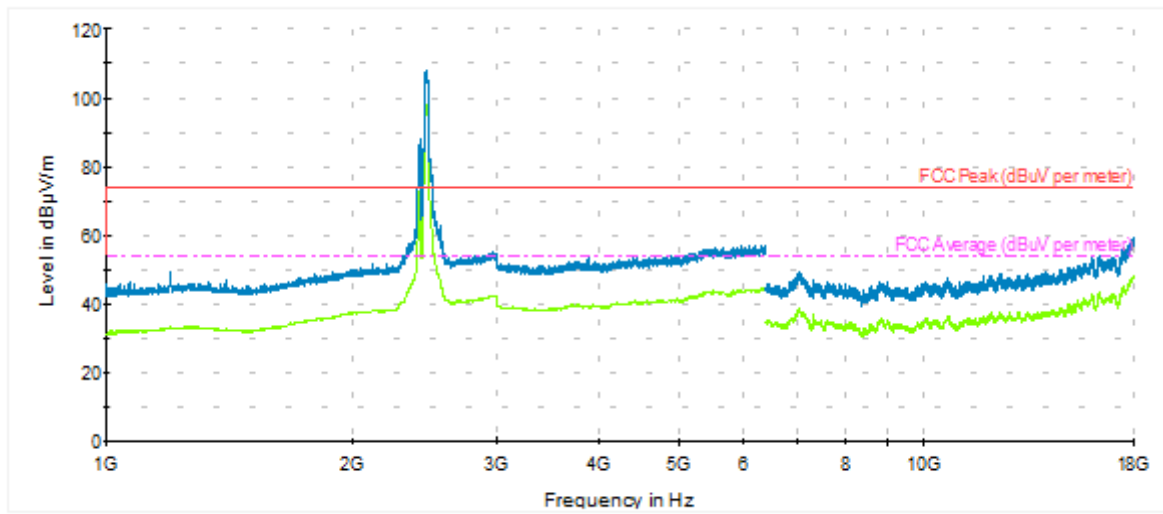

— Peak measurements     
 — AVG measurements     
 — Limit FCC Peak     
 - - - Limit FCC Avg

Frequency	Max Peak	Avg	Limit	Margin
MHz	dBuV/m	dBuV/m	dBuV/m	dB
2962.00	---	42.16	54.06	11.90
2962.00	55.26	---	74.06	18.80
6316.50	---	44.53	54.06	9.53
6319.00	56.81	---	74.06	17.25
17995.65	59.50	---	74.06	14.56
17996.13	---	48.49	54.06	5.57



## Radiated Spurious – 1 GHz to 18GHz 802.11n40, HT0, Chain A+B

### Ch3F

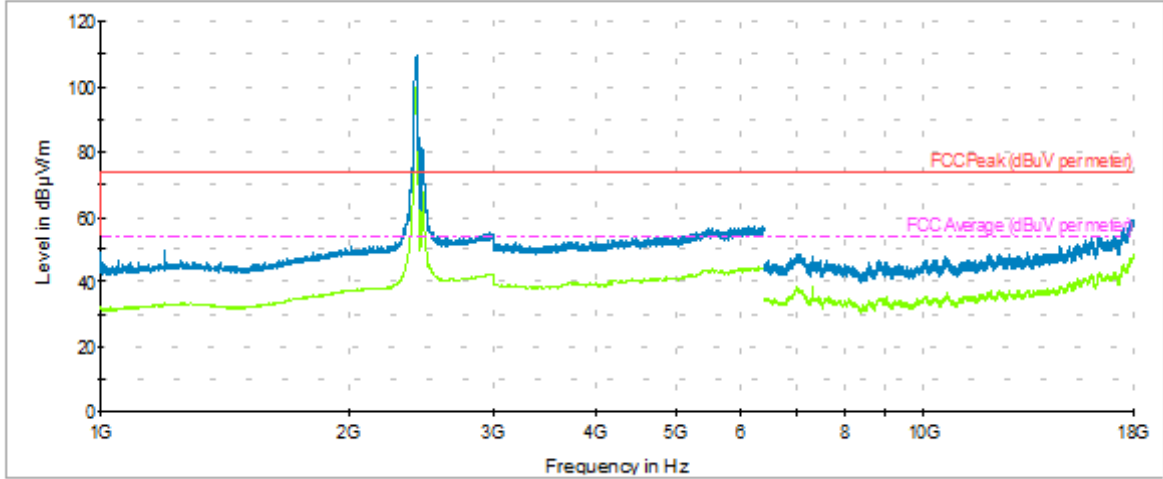

— Peak measurements     
 — AVG measurements     
 — Limit FCC Peak     
 — Limit FCC Avg

Frequency	Max Peak	Avg	Limit	Margin
MHz	dBuV/m	dBuV/m	dBuV/m	dB
2970.50	---	42.59	54.06	11.47
2970.50	55.04	---	74.06	19.02
6317.50	56.54	---	74.06	17.52
6318.50	---	44.54	54.06	9.52
17993.71	59.13	---	74.06	14.93
17992.75	---	48.57	54.06	5.49

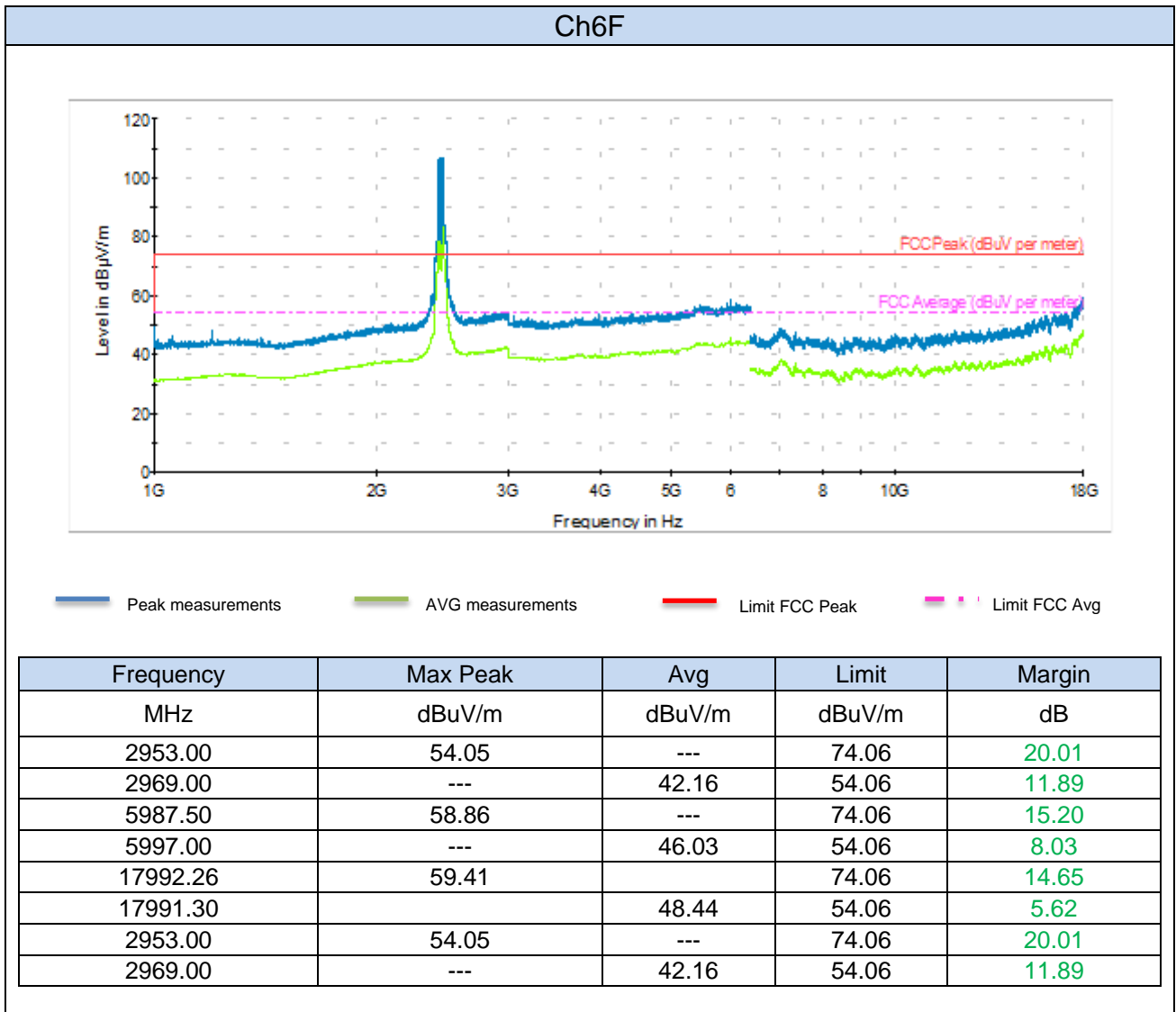

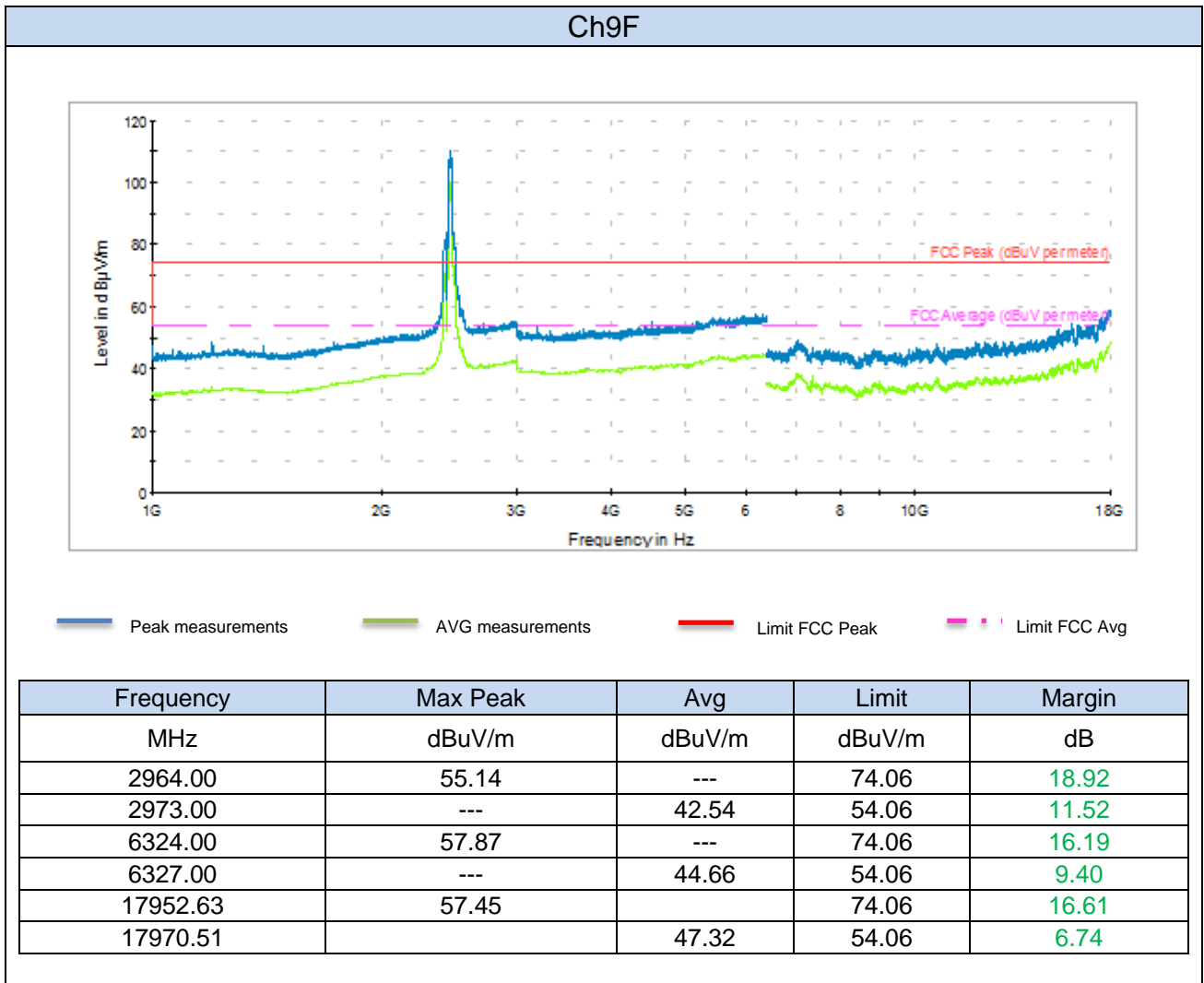

## Radiated Spurious – 18 GHz – 25 GHz

### Radiated Spurious – All Modes

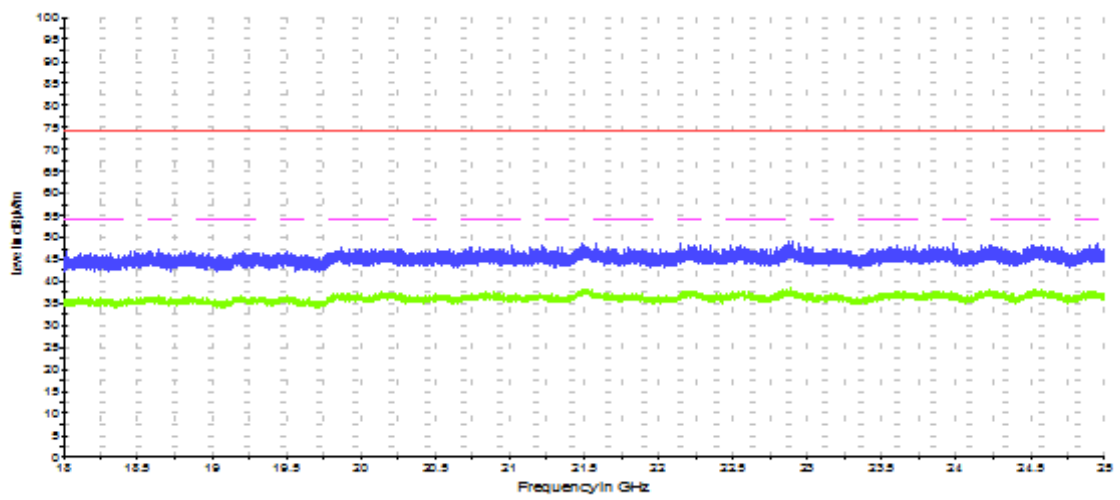

— Peak measurements     
 — AVG measurements     
 — Limit FCC Peak     
 - - - Limit FCC Avg

Frequency MHz	Max Peak dBuV/m	Avg dBuV/m	Limit dBuV/m	Margin dB
21491	48.7	-	74	25.3
21491	-	38.2	54	15.8

Note 1: The spurious signals detected do not depend on either the operating channel or the modulation mode.

# Annex C. Test Results BLE

## C.1 6dB & 99% Bandwidth

### Test limits:

FCC part	RSS part	Limits
15.247 (a) (2)	RSS-247 Clause 5.2 (1)	Systems using digital modulation techniques may operate in the 902-928 MHz, 2400-2483.5 MHz, and 5725-5850 MHz bands. The minimum 6 dB bandwidth shall be at least 500 kHz.

### Test procedure:

The setup below was used to measure the 6dB & 99% Bandwidth. The antenna terminal of the EUT is connected to the spectrum through an attenuator, and the spectrum analyzer reading is compensated to include the RF path loss.

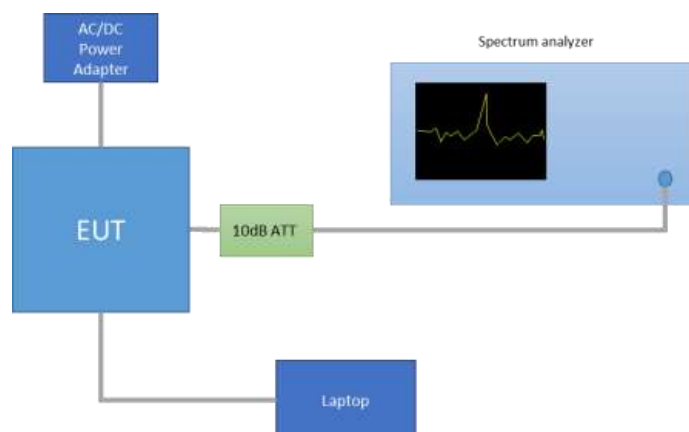

### Results tables:

Mode	Channel	Frequency [MHz]	6dB BW [MHz]	99% BW [MHz]
BLE	0	2402	0.66	1.13
	19	2440	0.66	1.13
	39	2480	0.67	1.13

**Results screenshot:**

**BLE**

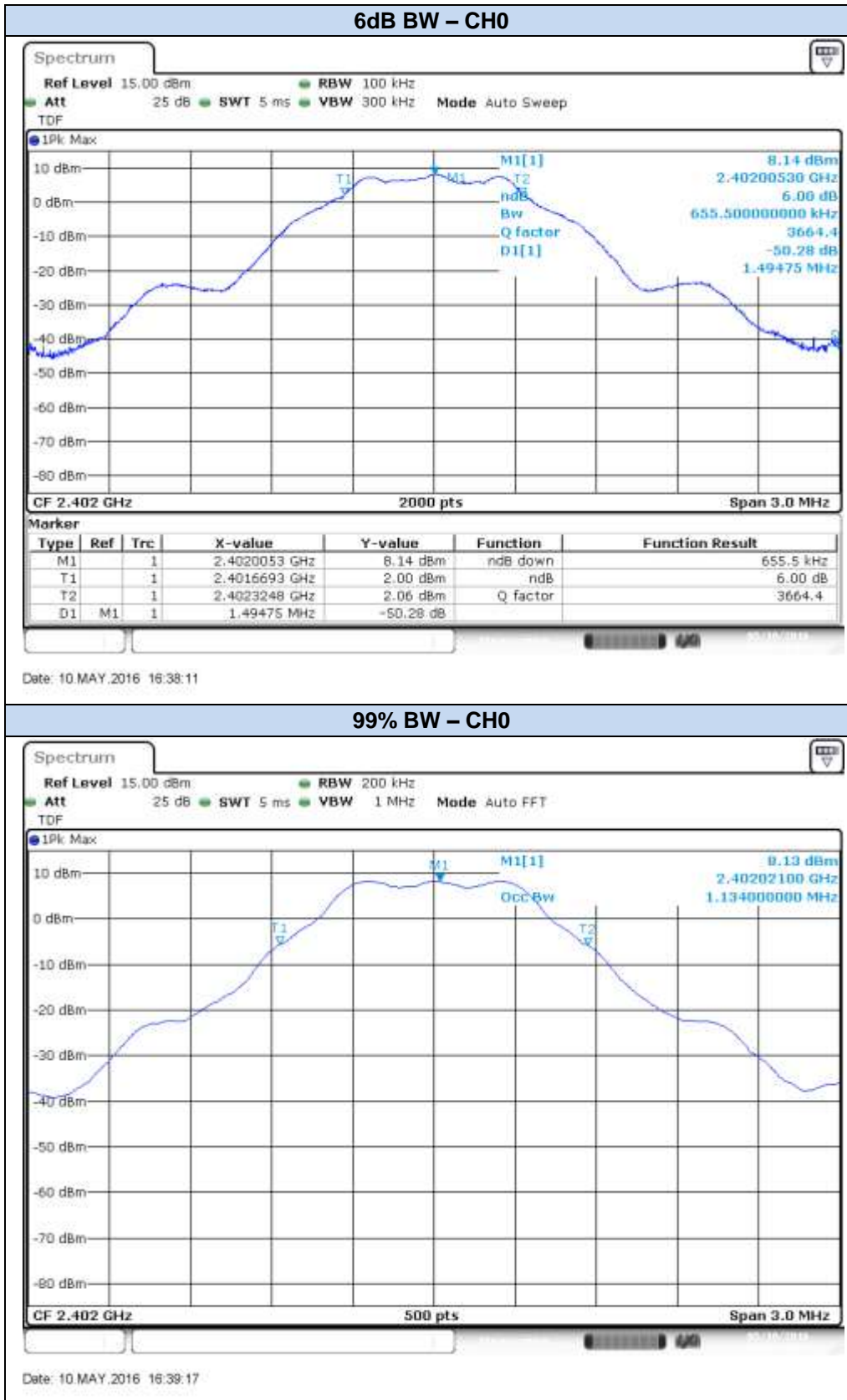

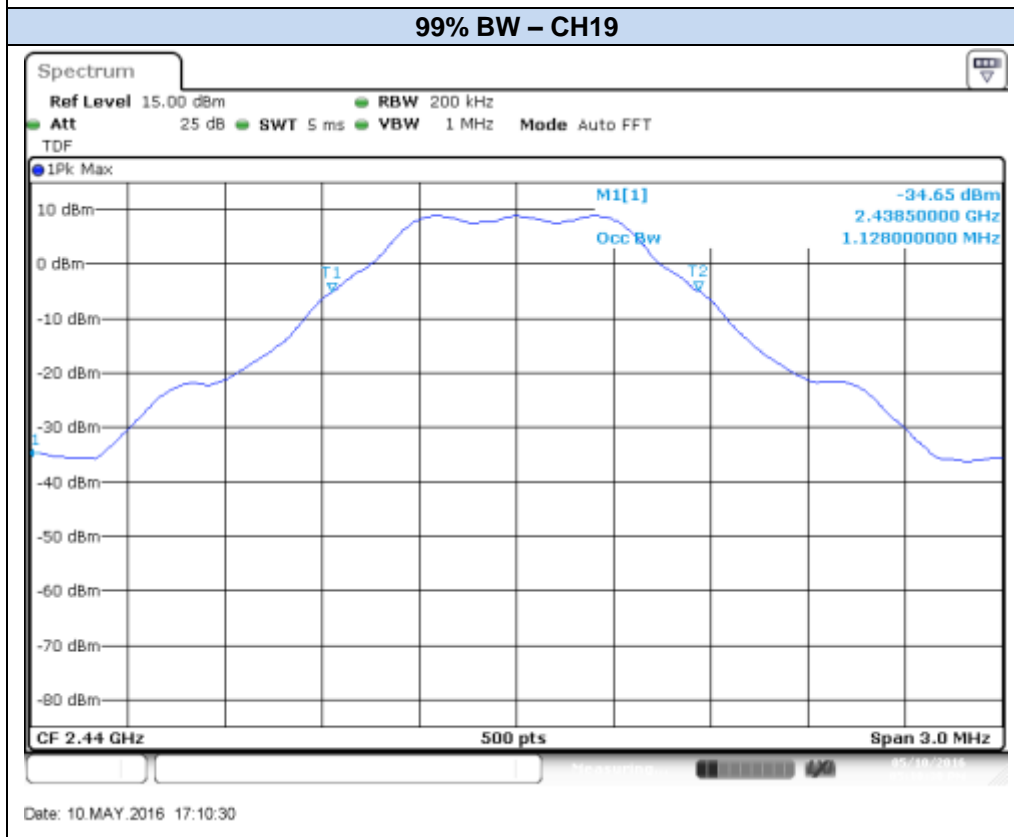
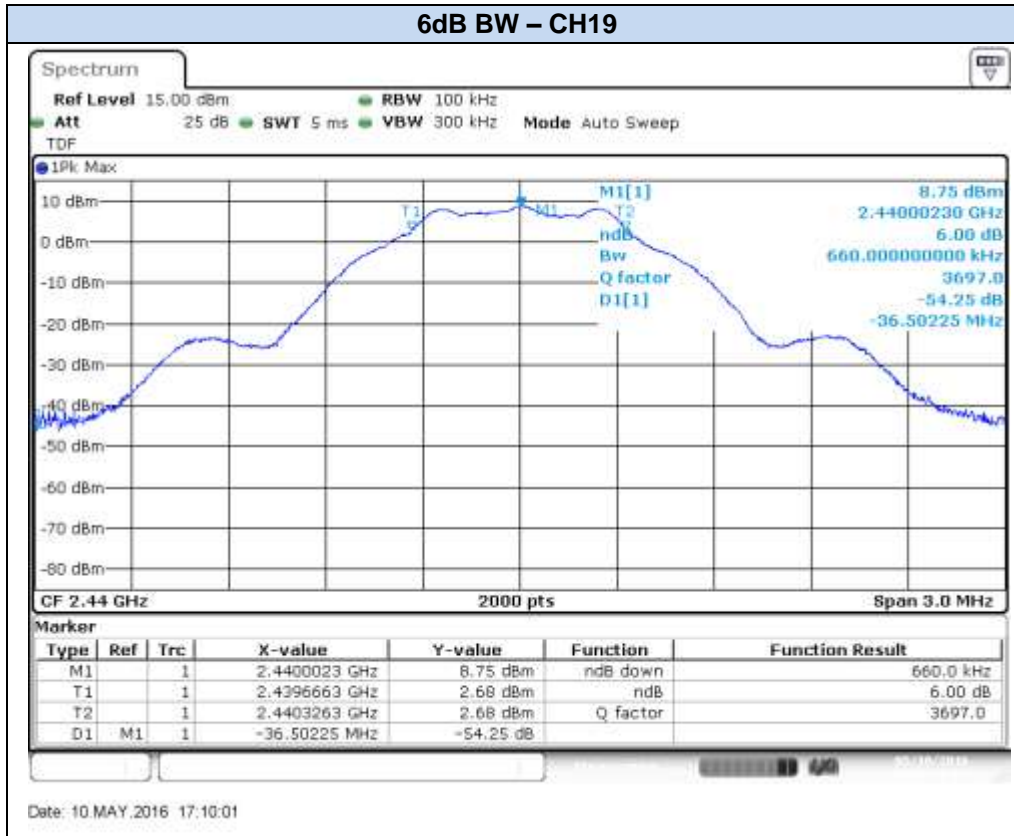

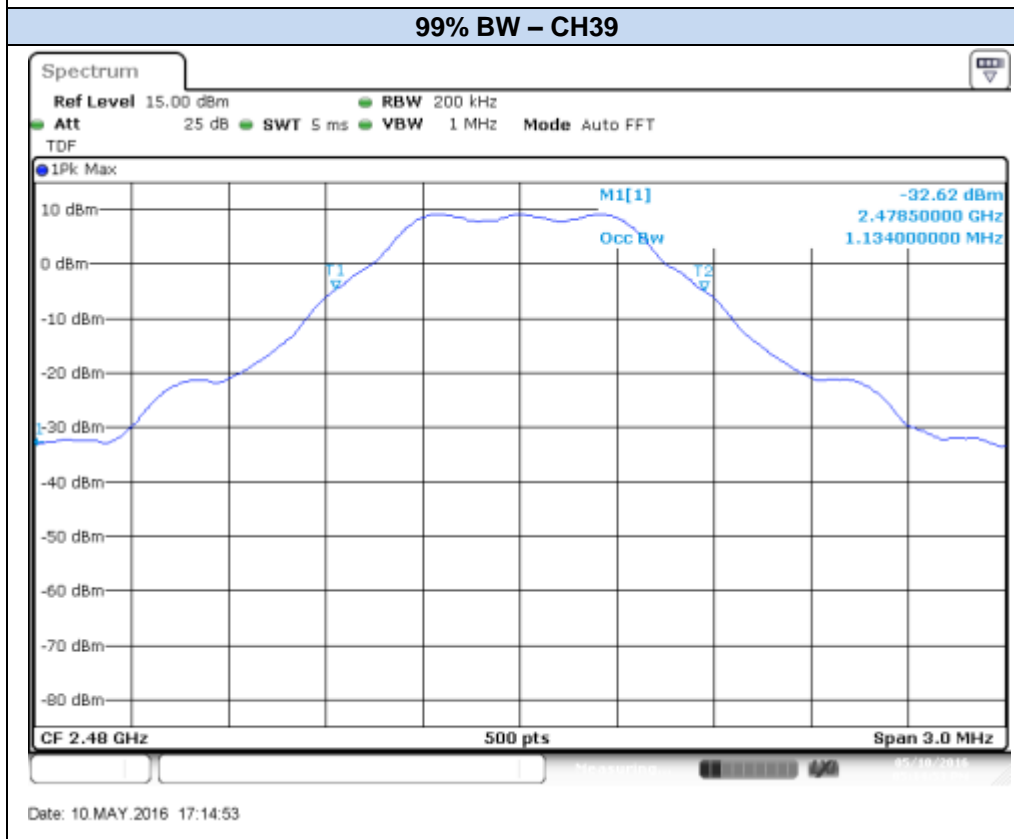
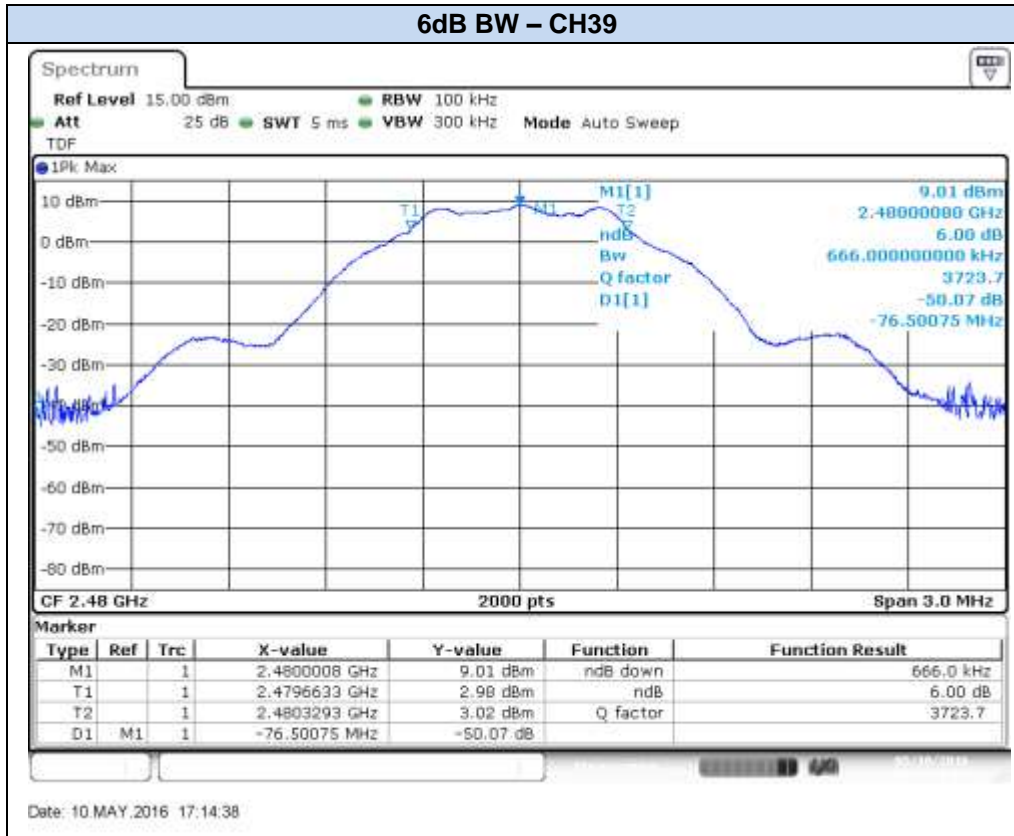



## C.2 Maximum Output Power and antenna gain

### Test limits:

FCC part	RSS part	Limits
15.247 (b) (3)	RSS-247 Clause 5.4 (4)	<p>(b) The maximum peak conducted output power of the intentional radiator shall not exceed the following:</p> <p>(3) For systems using digital modulation in the 902-928 MHz, 2400-2483.5 MHz, and 5725-5850 MHz bands: 1 Watt. As an alternative to a peak power measurement, compliance with the one Watt limit can be based on a measurement of the maximum conducted output power. Maximum Conducted Output Power is defined as the total transmit power delivered to all antennas and antenna elements averaged across all symbols in the signaling alphabet when the transmitter is operating at its maximum power control level. Power must be summed across all antennas and antenna elements. The average must not include any time intervals during which the transmitter is off or is transmitting at a reduced power level.</p> <p>(4) The conducted output power limit specified in paragraph (b) of this section is based on the use of antennas with directional gains that do not exceed 6 dBi.</p>

### Test procedure:

The Maximum peak conducted output power was measured using the  $RBW \geq DTS$  bandwidth method defined in paragraph 9.1.1 of FCC KDB 558074 D01 - Guidance for Performing Compliance Measurements on Digital Transmission Systems (DTS) Operating Under §15.247.

The Maximum conducted average output power was measured using the channel integration method according to Method AVGSA-2, defined in paragraph 9.2.2.4 of FCC KDB 558074 D01 - Guidance for Performing Compliance Measurements on Digital Transmission Systems (DTS) Operating Under §15.247.

The EIRP power (dBm) is calculated by adding the declared maximum antenna gain to the measured conducted power. The declared maximum antenna gain is 3dBi.

The setup below was used to measure the maximum conducted output power. The antenna terminal of the EUT is connected to the spectrum through an attenuator, and the spectrum analyzer reading is compensated to include the RF path loss.

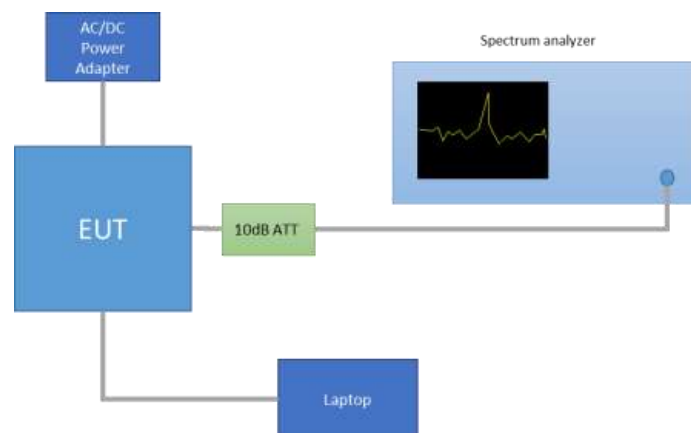

**Results tables:**

Mode	Meas. Duty Cycle [%]	CH	Frequency [MHz]	Peak Power [dBm]		Peak Output Power [mW]
				Measured Conducted Output Power	EIRP	
BLE	63..0	0	2402	8.26	11.26	<b>6.70</b>
		19	2440	8.86	11.86	7.69
		39	2480	9.15	12.15	<b>8.22</b>

Max Value

Min Value

Mode	Meas. Duty Cycle [%]	CH	Frequency [MHz]	Average Output Power* [dBm]			Average Output Power [mW]
				Maximum Conducted Output Power	Maximum Conducted Output Power Duty cycle Compensated	EIRP	
BLE	63.0	0	2402	6.22	8.23	11.23	6.65
		19	2440	6.82	8.83	11.83	7.64
		39	2480	7.12	9.13	12.13	8.18

\* Output Power RMS values are shown for indicative purpose only

**Results screenshot:**

**BLE**

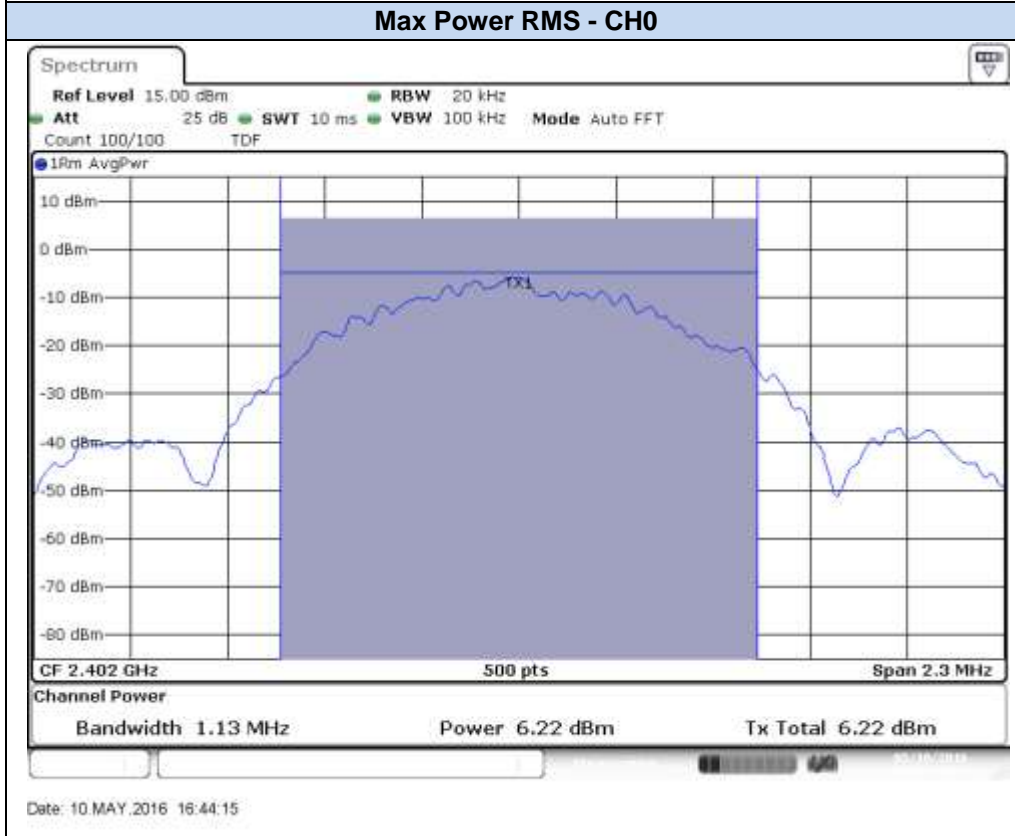
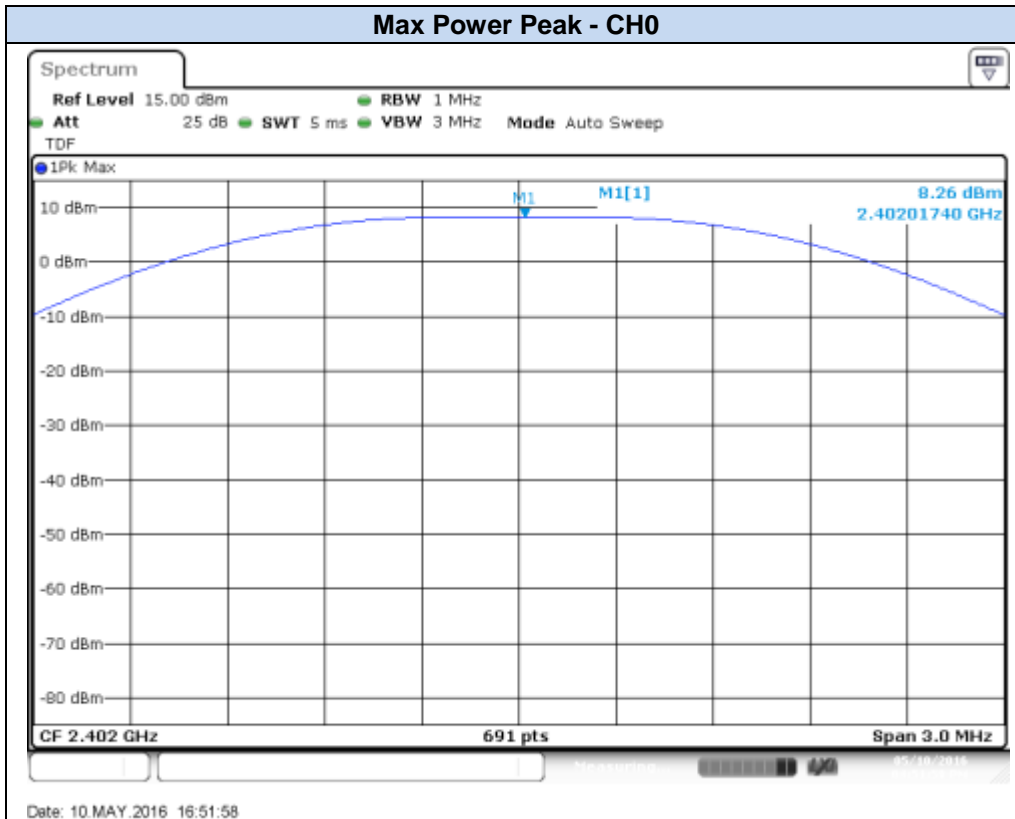

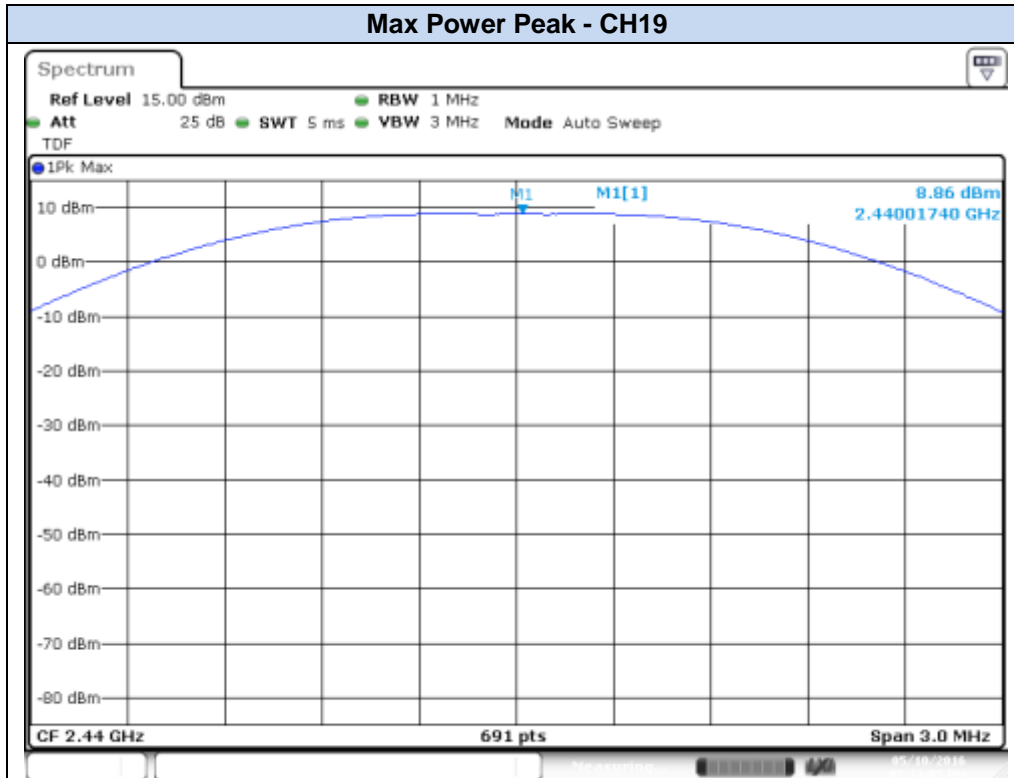

Date: 10 MAY 2016 17:13:05

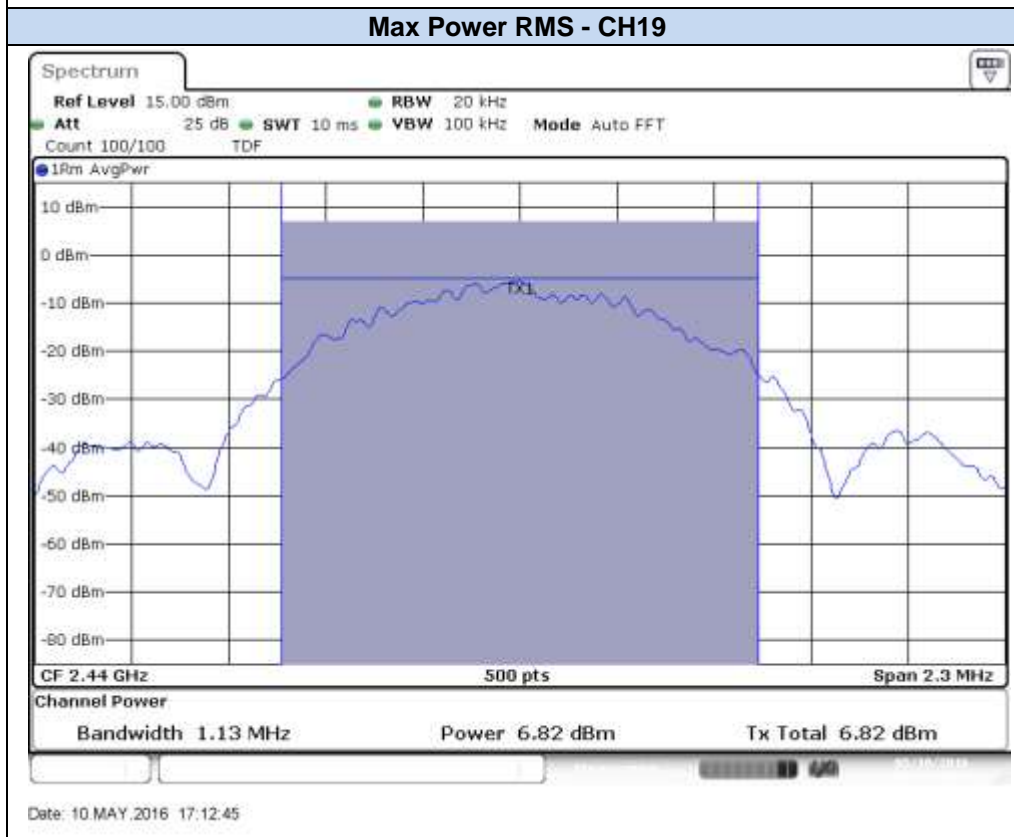

Date: 10 MAY 2016 17:12:45

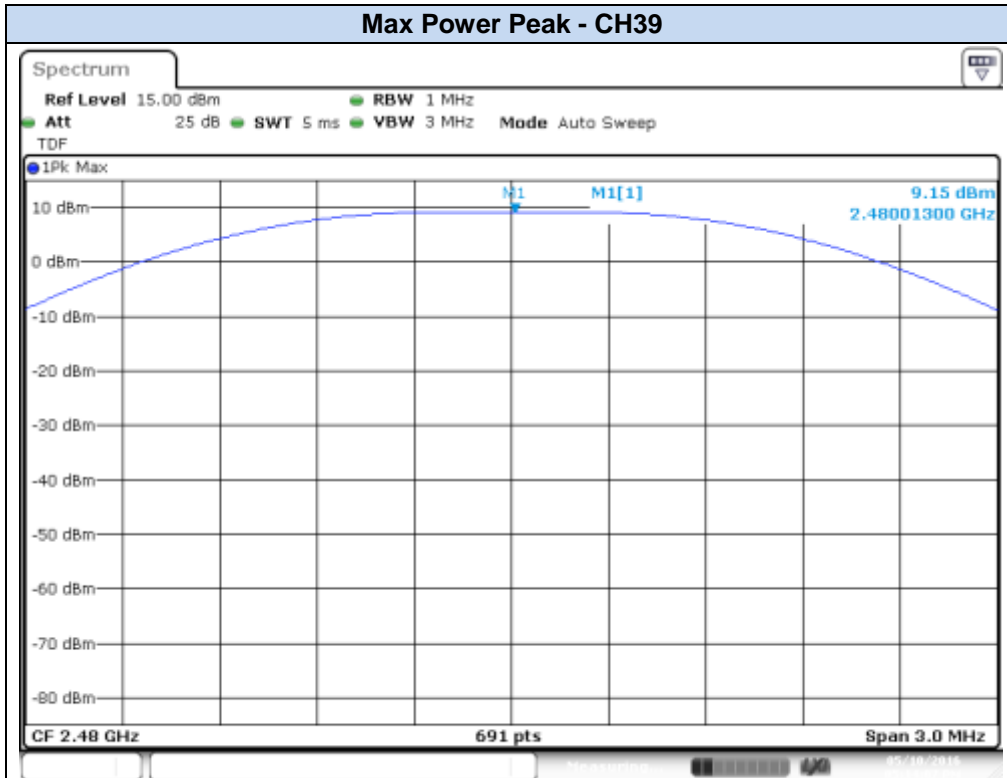

Date: 10.MAY.2016 17:14:07

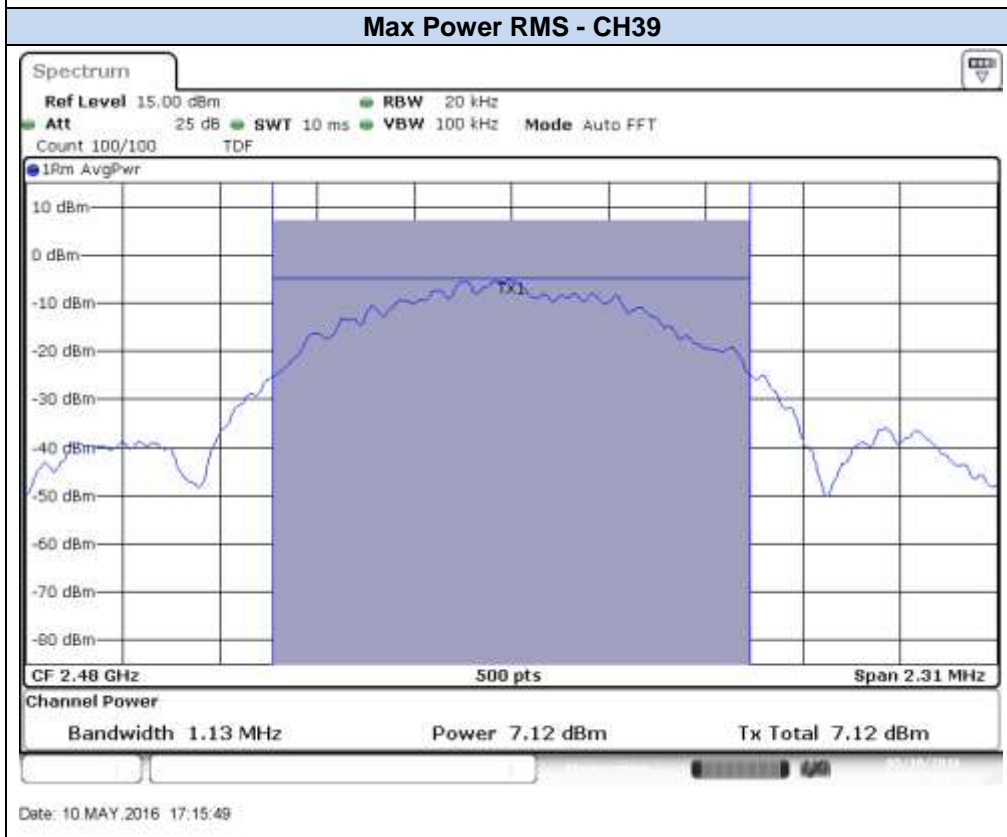

Date: 10.MAY.2016 17:15:49

### C.3 Out-of-band emissions (conducted)

**Test limits:**

FCC part	RSS part	Limits																																
15.247 (d)	RSS-247 Clause 5.5	In any 100 kHz bandwidth outside the frequency band in which the spread spectrum or digitally modulated intentional radiator is operating, the radio frequency power that is produced by the intentional radiator shall be at least 20 dB below that in the 100 kHz bandwidth within the band that contains the highest level of the desired power, based on either an RF conducted or a radiated measurement, provided the transmitter demonstrates compliance with the peak conducted power limits.																																
15.209	RSS-247 Clause 6.2.2 (2)	<p>Radiated emissions which fall in the restricted bands, as defined in §15.205(a), must also comply with the radiated emission limits specified in §15.209(a):</p> <table border="1"> <thead> <tr> <th>Freq Range (MHz)</th> <th>Field Strength (μV/m)</th> <th>Field Strength (dBμV/m)</th> <th>Meas. Distance (m)</th> </tr> </thead> <tbody> <tr> <td>0.009-0.490</td> <td>2400/f(kHz)</td> <td>-</td> <td>300</td> </tr> <tr> <td>0.490-1.705</td> <td>24000/f(kHz)</td> <td>-</td> <td>300</td> </tr> <tr> <td>1.705-30.0</td> <td>30</td> <td>-</td> <td>30</td> </tr> <tr> <td>30-88</td> <td>100</td> <td>40</td> <td>3</td> </tr> <tr> <td>88-216</td> <td>150</td> <td>43.5</td> <td>3</td> </tr> <tr> <td>216-960</td> <td>200</td> <td>46</td> <td>3</td> </tr> <tr> <td>Above 960</td> <td>500</td> <td>54</td> <td>3</td> </tr> </tbody> </table> <p>The emission limits shown in the above table are based on measurements employing CISPR quasi-peak detector except for the frequency bands 9-90 kHz, 110-490 kHz and above 1000 MHz. Radiated emission limits in these three bands are based on measurements employing an average detector.</p> <p>For average radiated emission measurements above 1000 MHz, there is also a limit specified when measuring with peak detector function, corresponding to 20 dB above the indicated values in the table.</p>	Freq Range (MHz)	Field Strength (μV/m)	Field Strength (dBμV/m)	Meas. Distance (m)	0.009-0.490	2400/f(kHz)	-	300	0.490-1.705	24000/f(kHz)	-	300	1.705-30.0	30	-	30	30-88	100	40	3	88-216	150	43.5	3	216-960	200	46	3	Above 960	500	54	3
Freq Range (MHz)	Field Strength (μV/m)	Field Strength (dBμV/m)	Meas. Distance (m)																															
0.009-0.490	2400/f(kHz)	-	300																															
0.490-1.705	24000/f(kHz)	-	300																															
1.705-30.0	30	-	30																															
30-88	100	40	3																															
88-216	150	43.5	3																															
216-960	200	46	3																															
Above 960	500	54	3																															

**Test procedure:**

The setup below was used to measure the out-of-band emissions. The antenna terminal of the EUT is connected to the spectrum through an attenuator, and the spectrum analyzer reading is compensated to include the RF path loss.

In case of Band Edge measurements falling in restricted bands, the declared Antenna Gain is also compensated in the graph. The declared maximum antenna gain is 3dBi.

For Band Edge measurements falling in restricted bands, the following limits in dBm were applied for the average detector after the conversion from the limits detailed above in dBμV/m, according to FCC 47 CFR part 15 - Subpart C – §15.209(a). The limits in dBm for peak detector are 20dB above the indicated values in the table.

§15.209(a)			Converted values	
Freq Range (MHz)	Distance (m)	Field strength (microvolts/meter)	Field strength (dB microvolts/meter)	Power (dBm)
Above 960	3	500	54.0	-41.2

The setup below was used to measure the out-of-band emissions. The antenna terminal of the EUT is connected to the spectrum through an attenuator, and the spectrum analyzer reading is compensated to include the RF path loss.

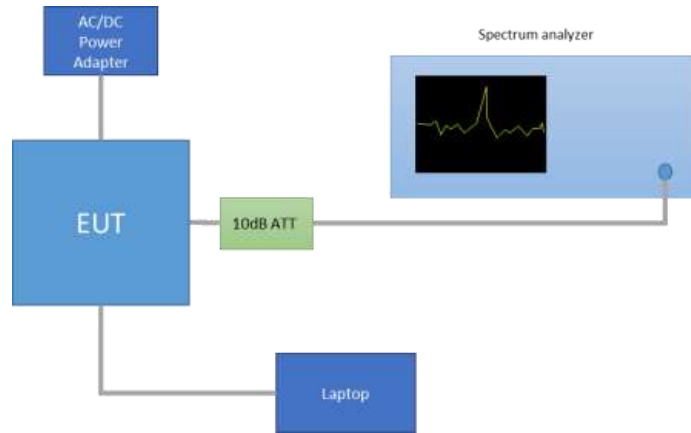

Note: these  $PSD_{Peak}$  values are shown just as a reference for the compliance of the Out-of-band Measurements. Thus the RBW used for these measurements was 100kHz.

Mode	CH	Frequency [MHz]	PSD Peak [dBm]
BLE	0	2402	8.24
	19	2440	8.75
	39	2480	9.02

**Band Edge results Screenshot:**

**BLE**

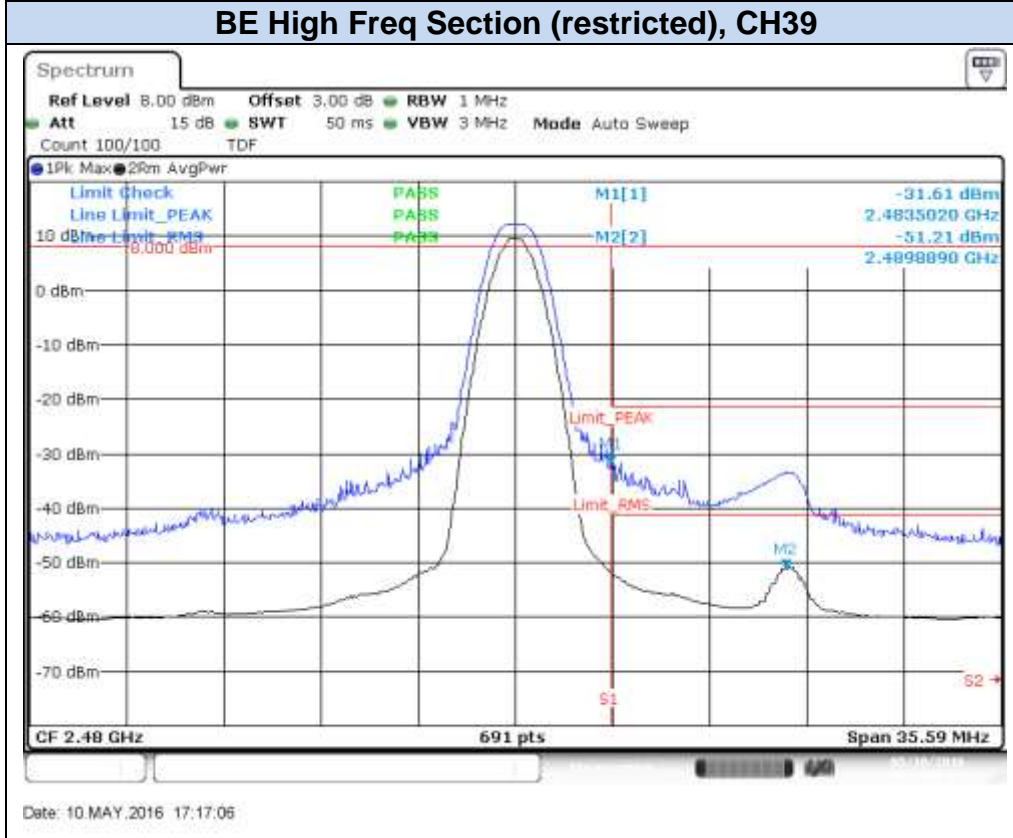
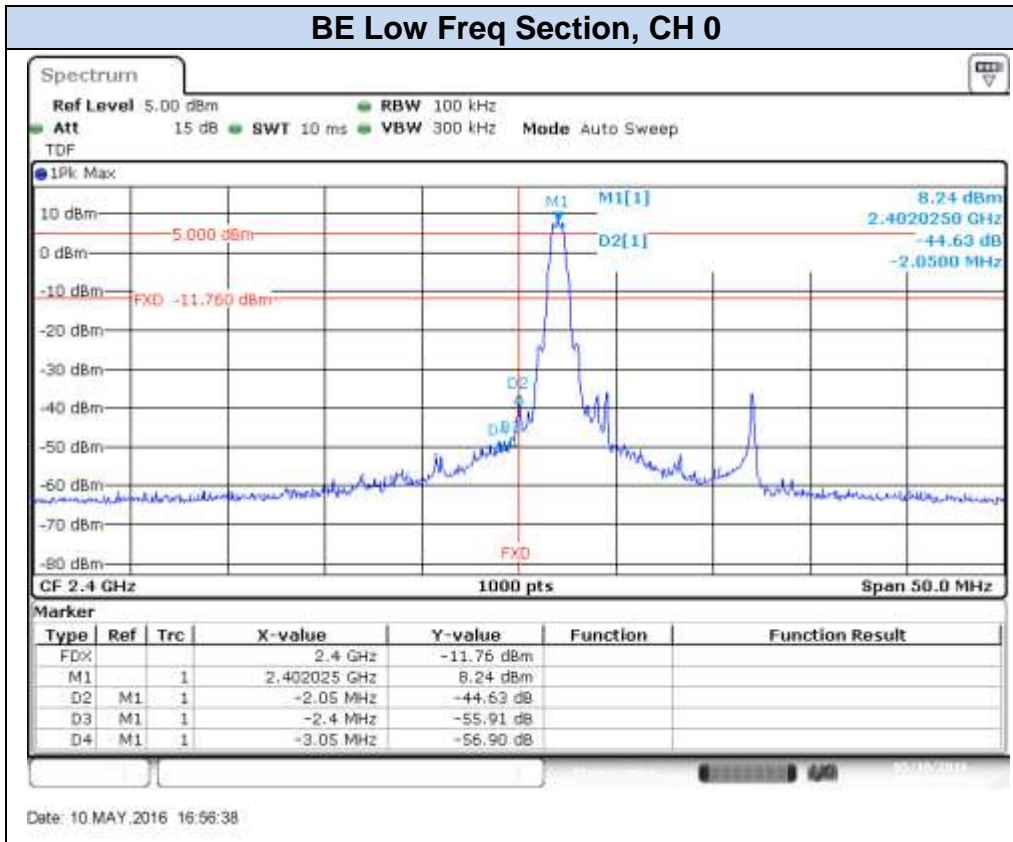



**Spurious results Screenshot:**

**BLE, CH0**

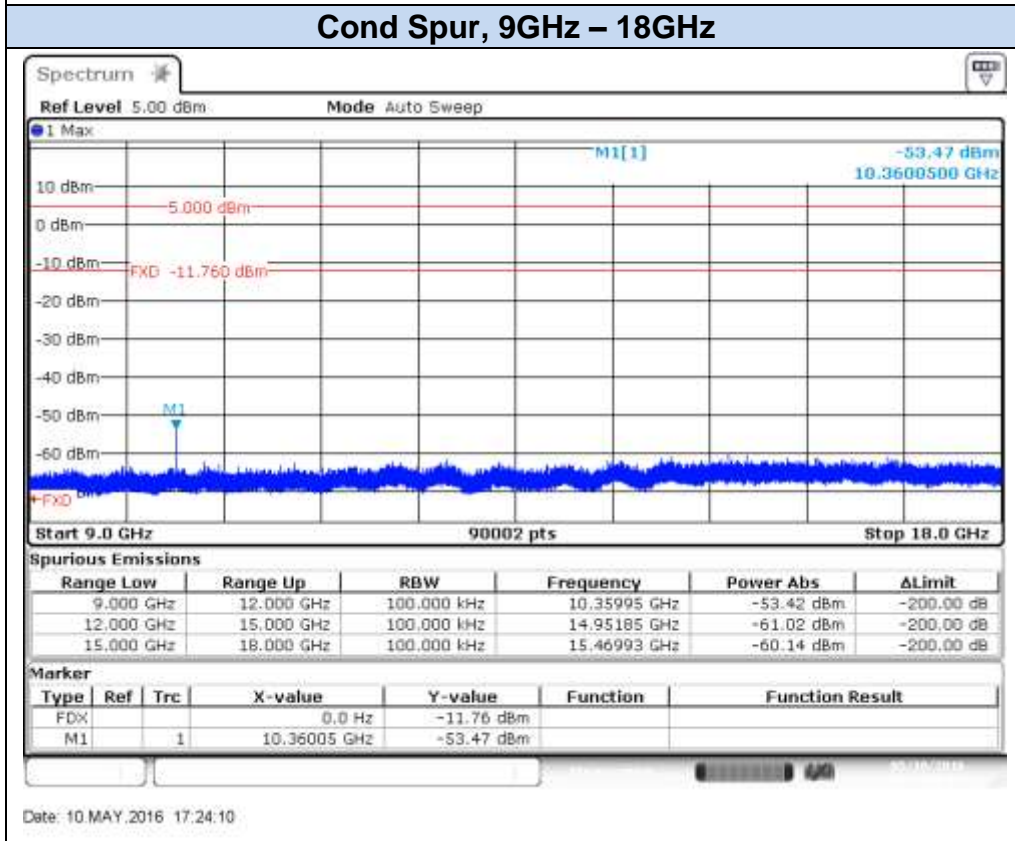
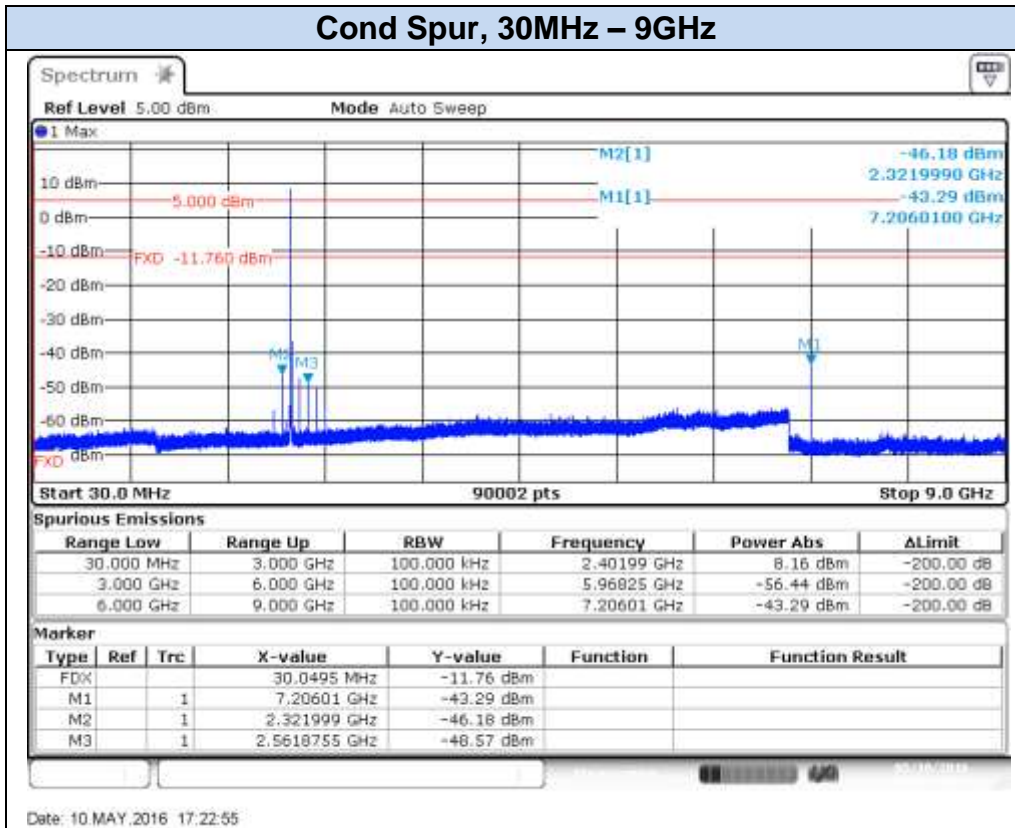

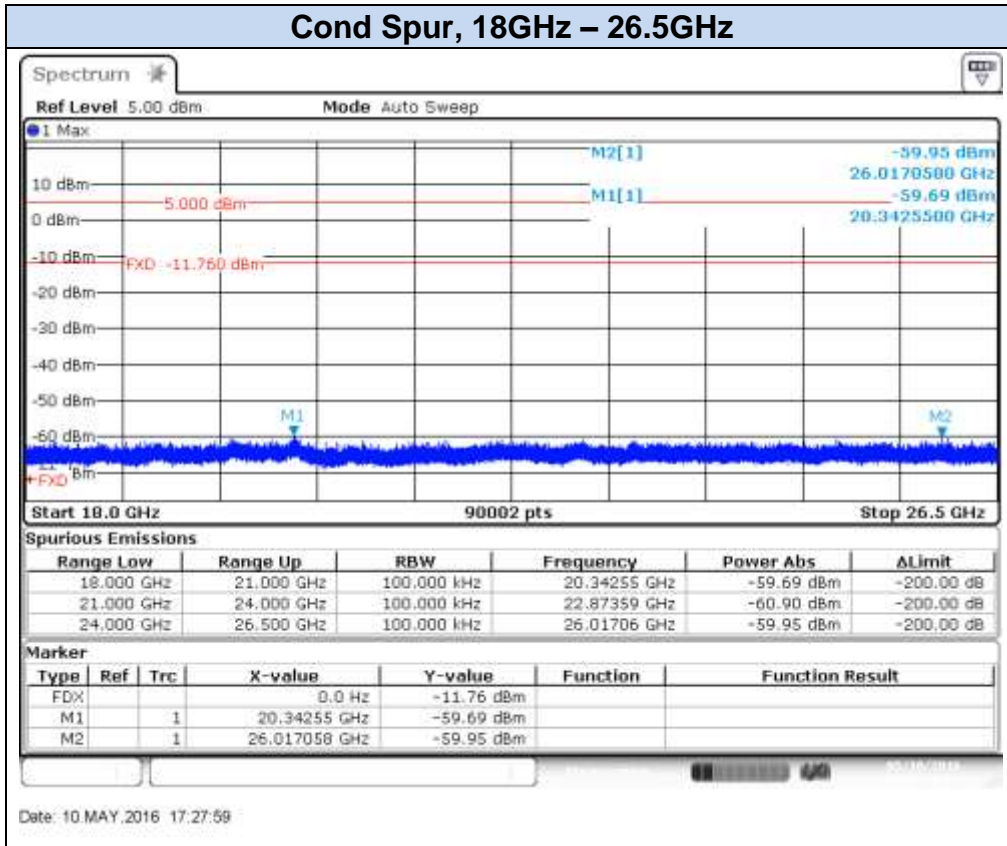

## BLE, CH19

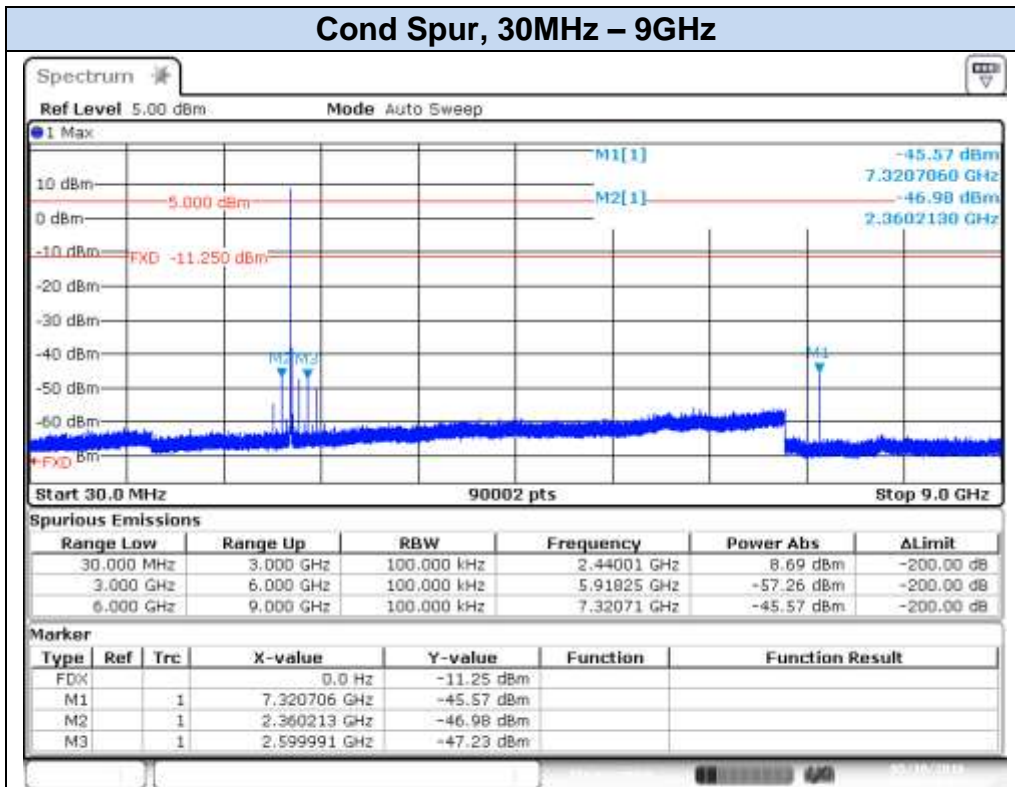

Date: 10.MAY.2016 17:30:26

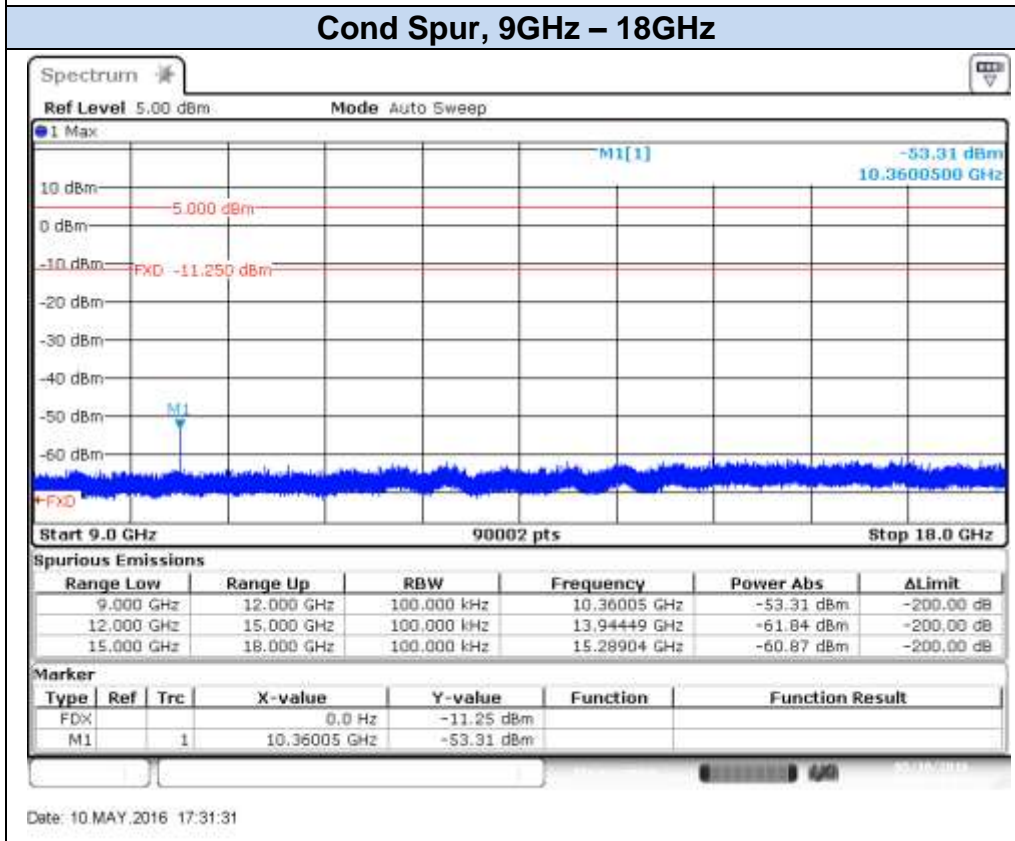

Date: 10.MAY.2016 17:31:31

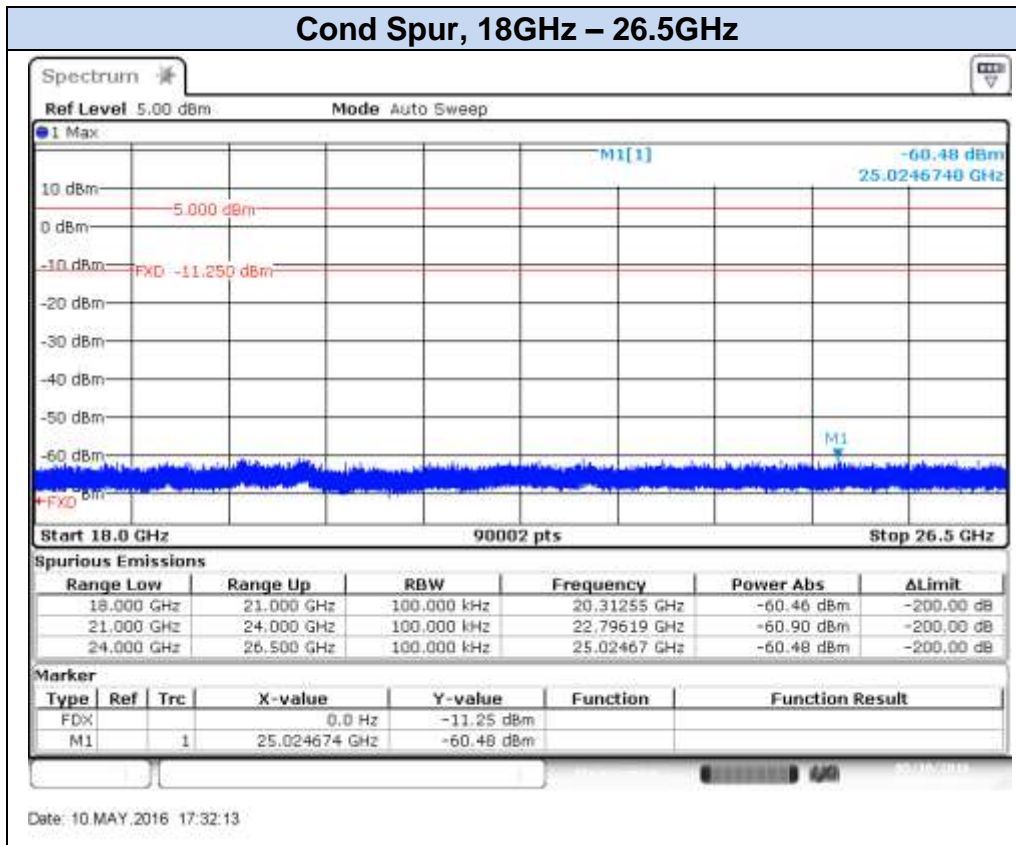

**BLE, CH39**

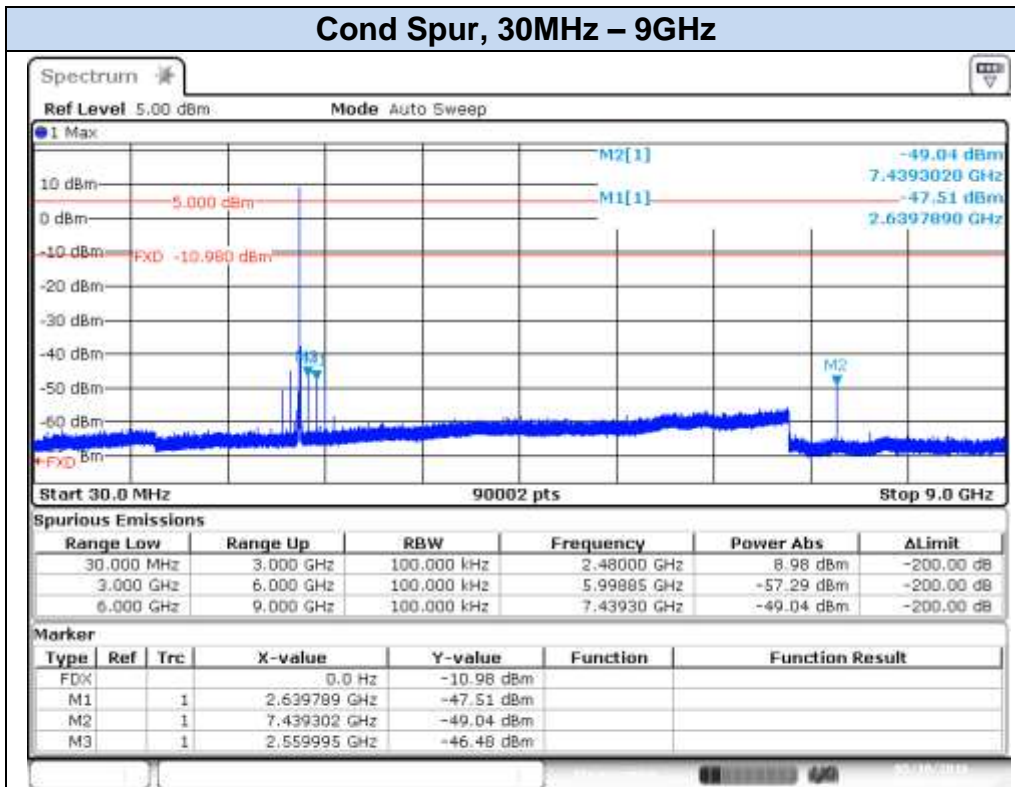

Date: 10.MAY.2016 17:35:54

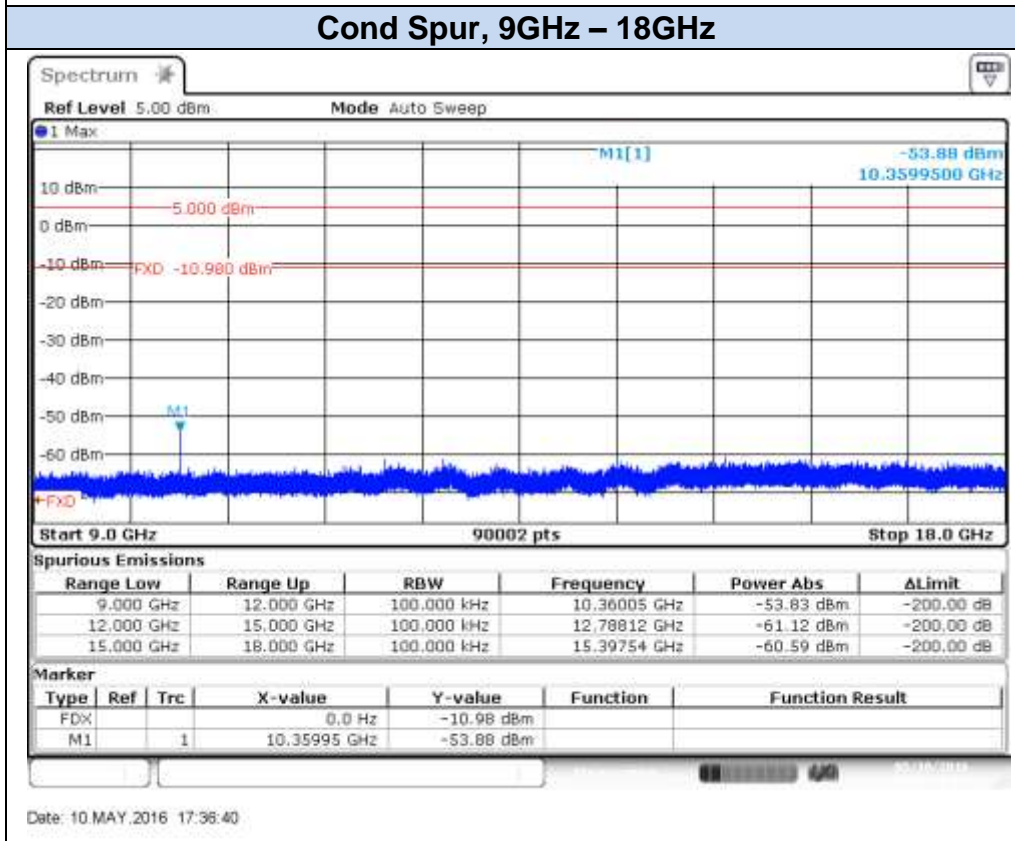

Date: 10.MAY.2016 17:36:40

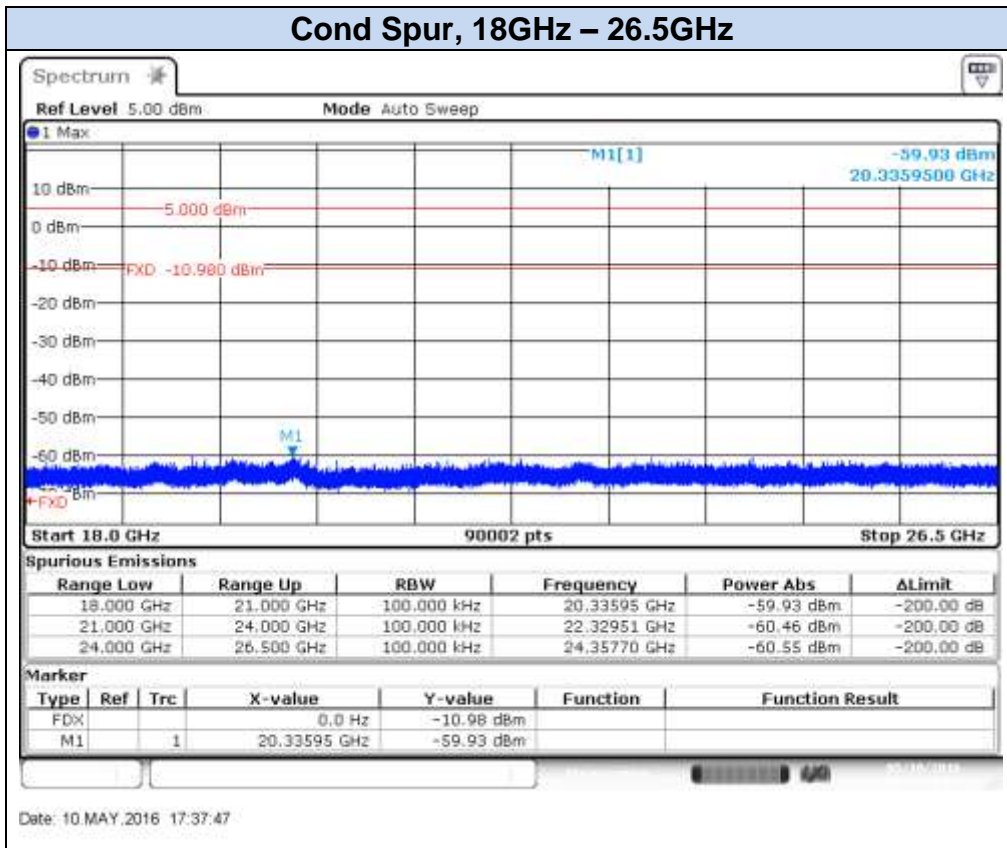

### C.4 Power Spectral Density

**Test limits:**

FCC part	RSS part	Limits
15.247 (e)	RSS-247 Clause 5.2 (2)	For digitally modulated systems, the power spectral density conducted from the intentional radiator to the antenna shall not be greater than 8 dBm in any 3 kHz band during any time interval of continuous transmission. This power spectral density shall be determined in accordance with the provisions of paragraph (b) of this section. The same method of determining the conducted output power shall be used to determine the power spectral density.

**Test procedure:**

The maximum peak power spectral density level of the fundamental emission was measured using the method PKPSD, defined in paragraph 10.2 of FCC KDB 558074 D01 - Guidance for Performing Compliance Measurements on Digital Transmission Systems (DTS) Operating Under §15.247.

The setup below was used to measure the power spectral density. The antenna terminal of the EUT is connected to the spectrum through an attenuator, and the spectrum analyzer reading is compensated to include the RF path loss.

The declared maximum antenna gain is 3dBi.

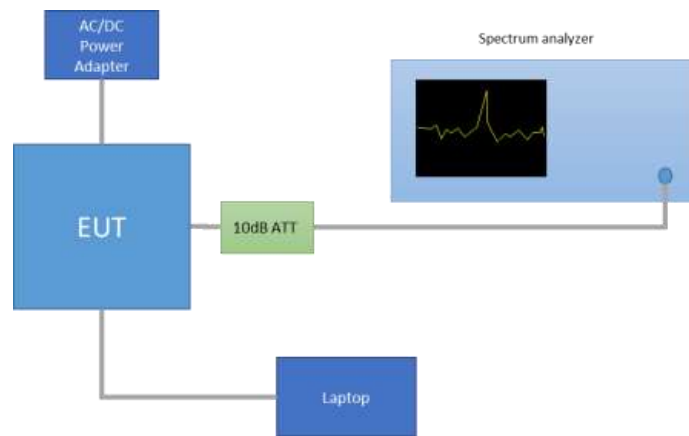

**Results tables:**

Mode	CH	Frequency [MHz]	PSD Peak [dBm]
BLE	0	2402	-7.01
	19	2440	-6.35
	39	2480	-6.06

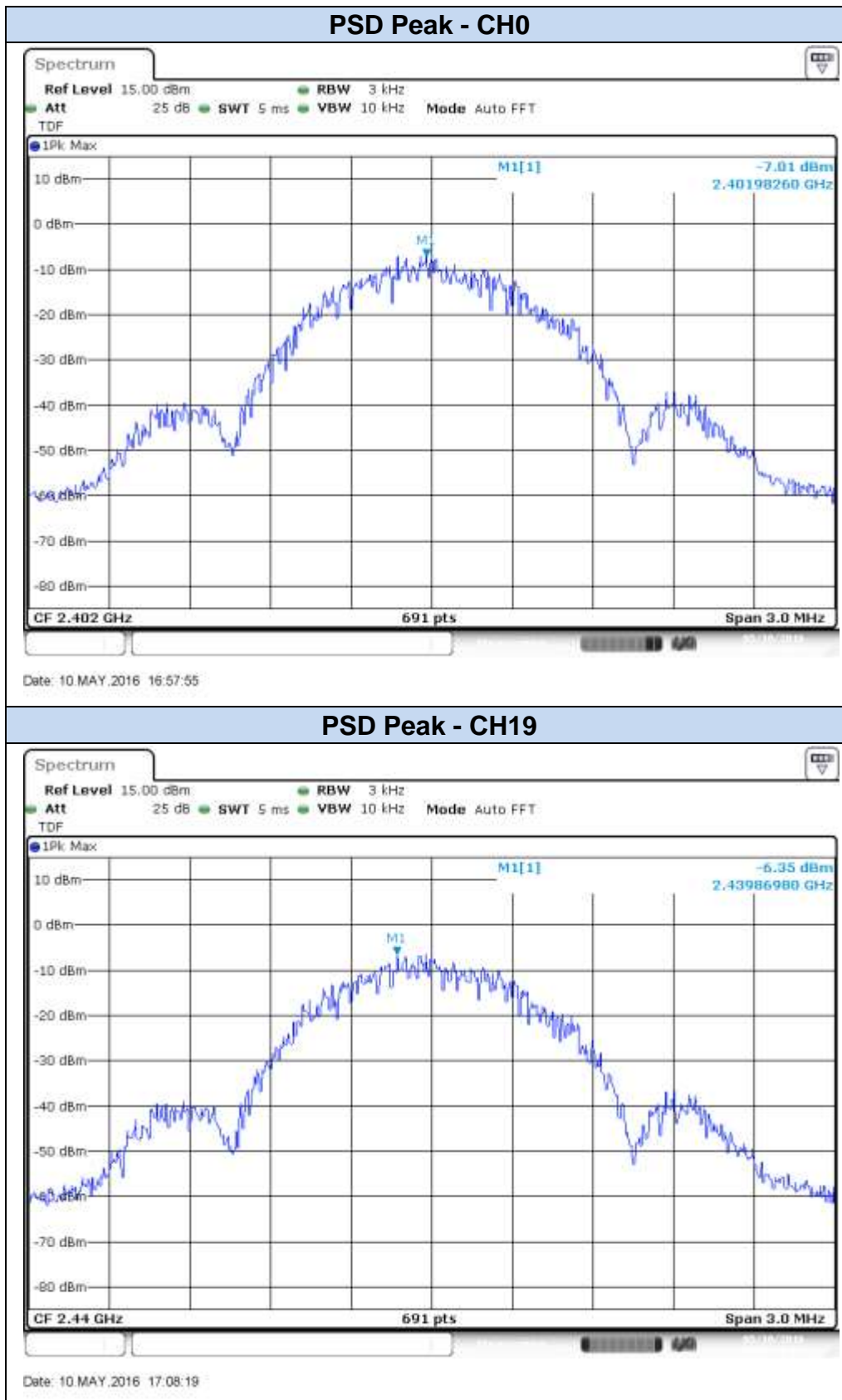
**Results screenshot:****BLE**



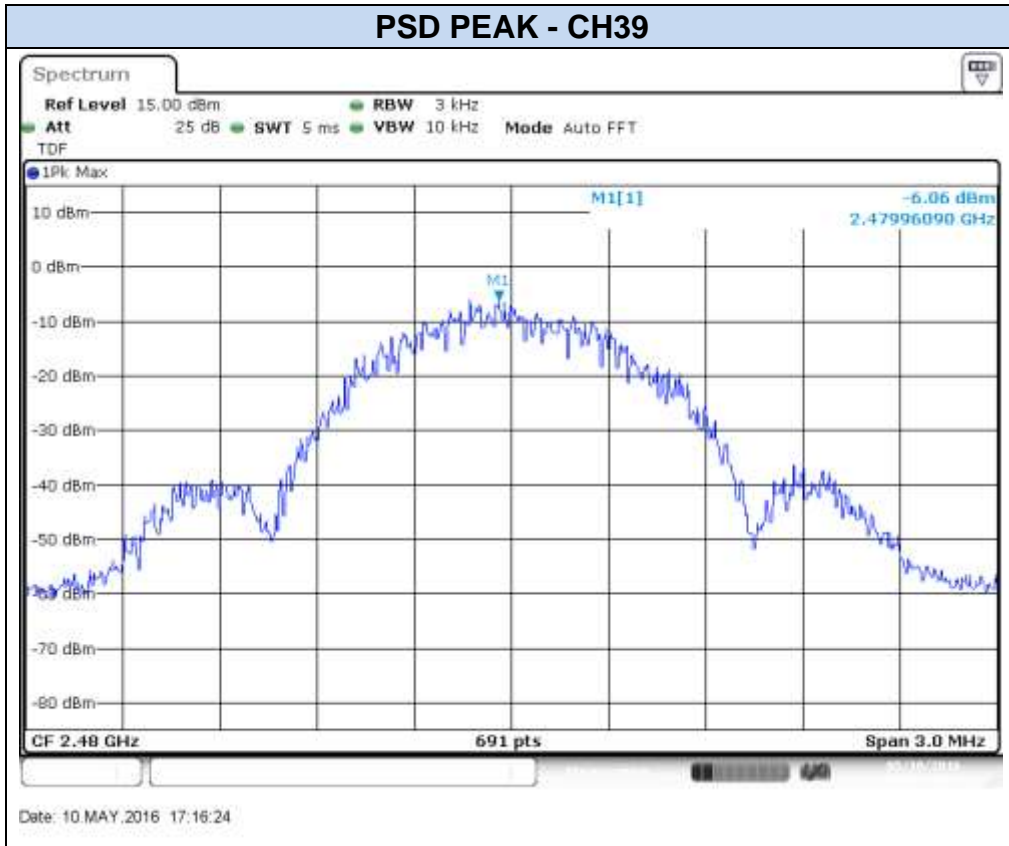

## C.5 Radiated spurious emission

### Standard references:

FCC part	RSS part	Limits			
15.247 (d)	RSS-247 Clause 5.5	Radiated emissions which fall in the restricted bands, as defined in §15.205(a), must also comply with the radiated emission limits specified in §15.209(a):			
		Freq Range (MHz)	Field Strength (μV/m)	Field Strength (dBμV/m)	Meas. Distance (m)
		0.009-0.490	2400/f(kHz)	-	300
		0.490-1.705	24000/f(kHz)	-	300
		1.705-30.0	30	-	30
		30-88	100	40	3
		88-216	150	43.5	3
		216-960	200	46	3
		Above 960	500	54	3
		<p>The emission limits shown in the above table are based on measurements employing CISPR quasi-peak detector except for the frequency bands 9-90 kHz, 110-490 kHz and above 1000 MHz. Radiated emission limits in these three bands are based on measurements employing an average detector.</p> <p>For average radiated emission measurements above 1000 MHz, there is also a limit specified when measuring with peak detector function, corresponding to 20 dB above the indicated values in the table.</p>			

### Test procedure:

The setups below were used to measure the radiated spurious emissions.

Depending of the frequency range and bands being tested, different antennas and filters were used.

The final measurement is done by varying the antenna height from 1 to 4 meters, the EUT azimuth over 360° and for both Vertical and Horizontal polarizations.

The radiated spurious emissions were measured on the worst case configuration selected from the chapter *C.1 6dB & 99% Bandwidth*

### Test limits:

FCC part	RSS part	Limits
15.247 (a) (2)	RSS-247 Clause 5.2 (1)	Systems using digital modulation techniques may operate in the 902-928 MHz, 2400-2483.5 MHz, and 5725-5850 MHz bands. The minimum 6 dB bandwidth shall be at least 500 kHz.

### Test procedure:

The setup below was used to measure the 6dB & 99% Bandwidth. The antenna terminal of the EUT is connected to the spectrum through an attenuator, and the spectrum analyzer reading is compensated to include the RF path loss.

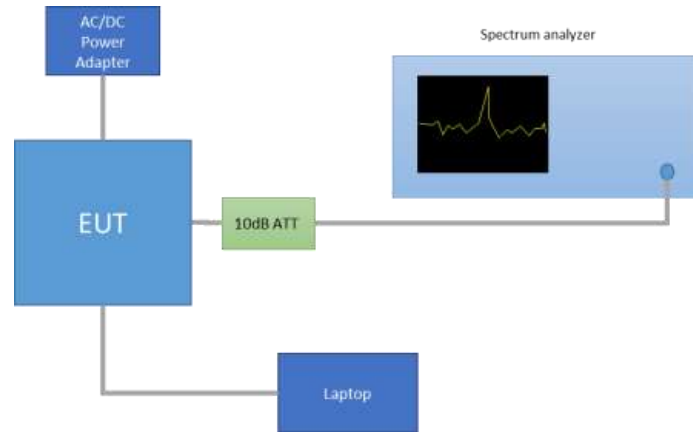
**Results tables:**

Mode	Channel	Frequency [MHz]	6dB BW [MHz]	99% BW [MHz]
BLE	0	2402	0.66	1.13
	19	2440	0.66	1.13
	39	2480	0.67	1.13

**Results screenshot:**

**BLE**

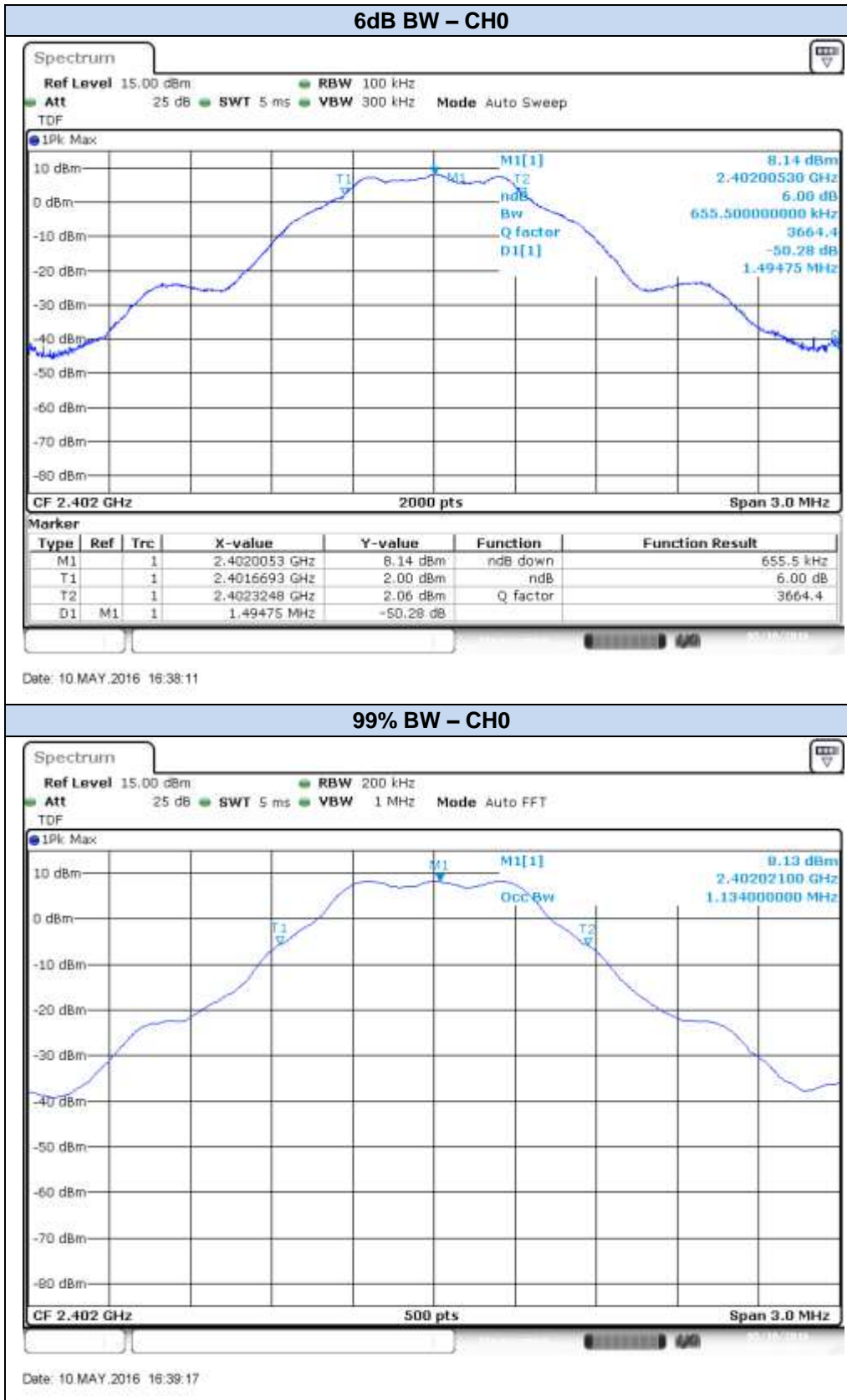

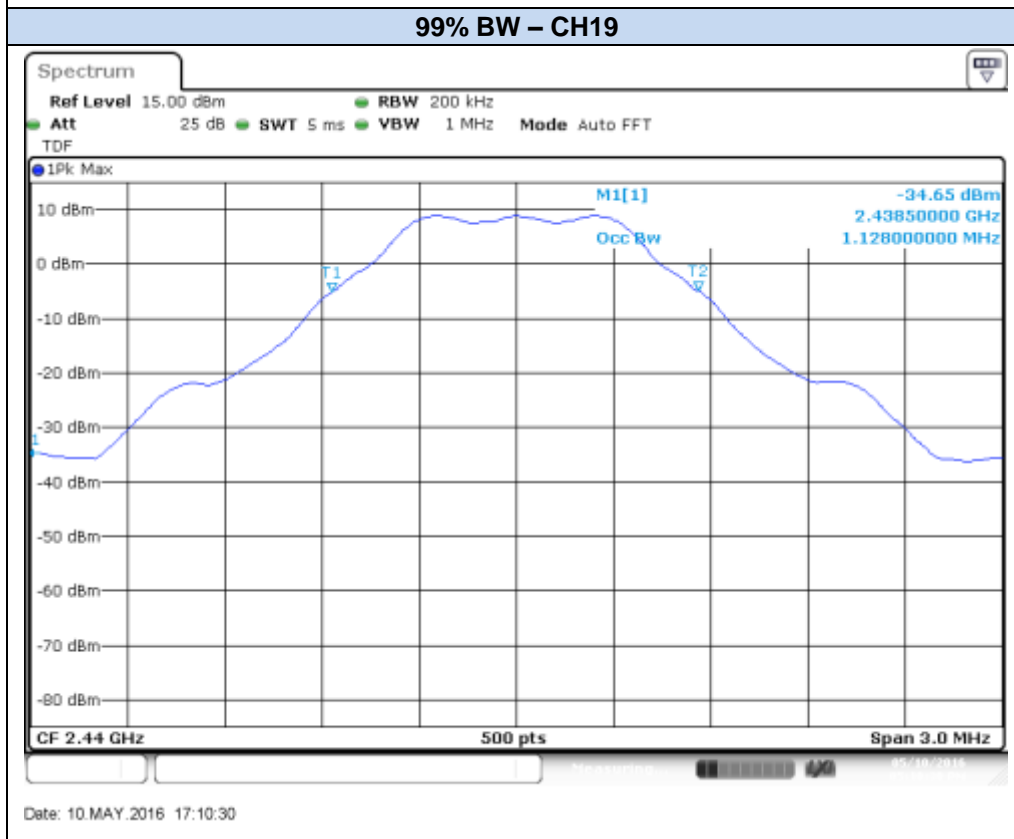
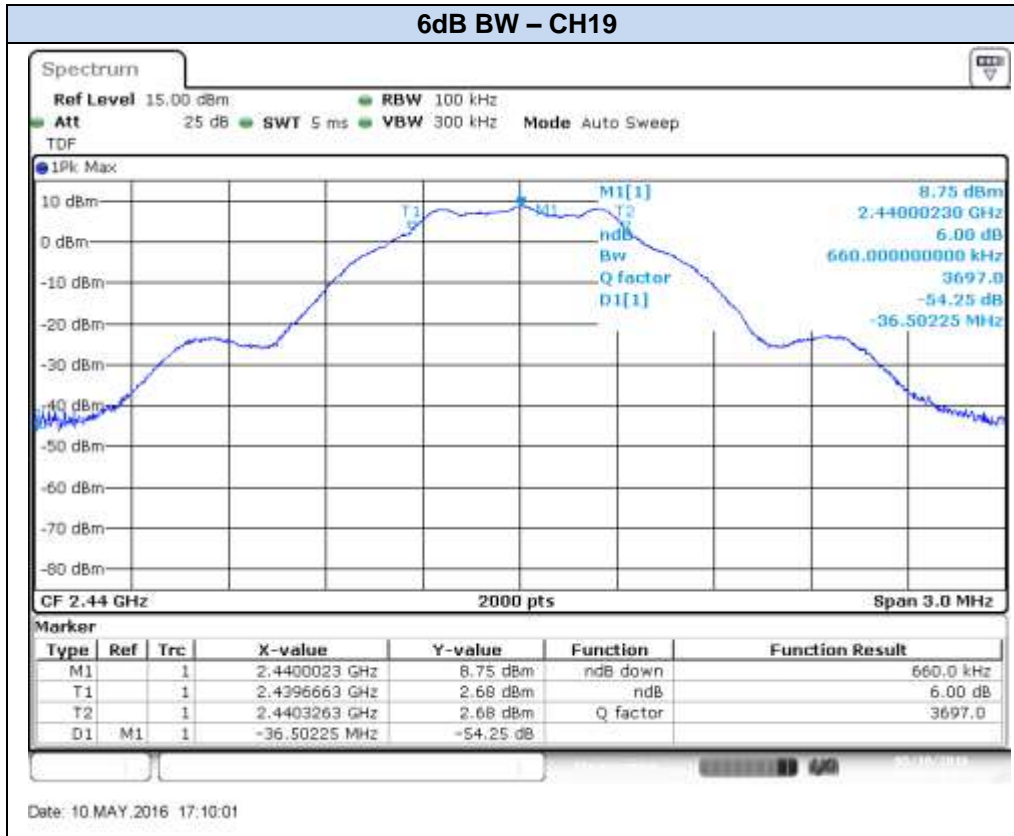

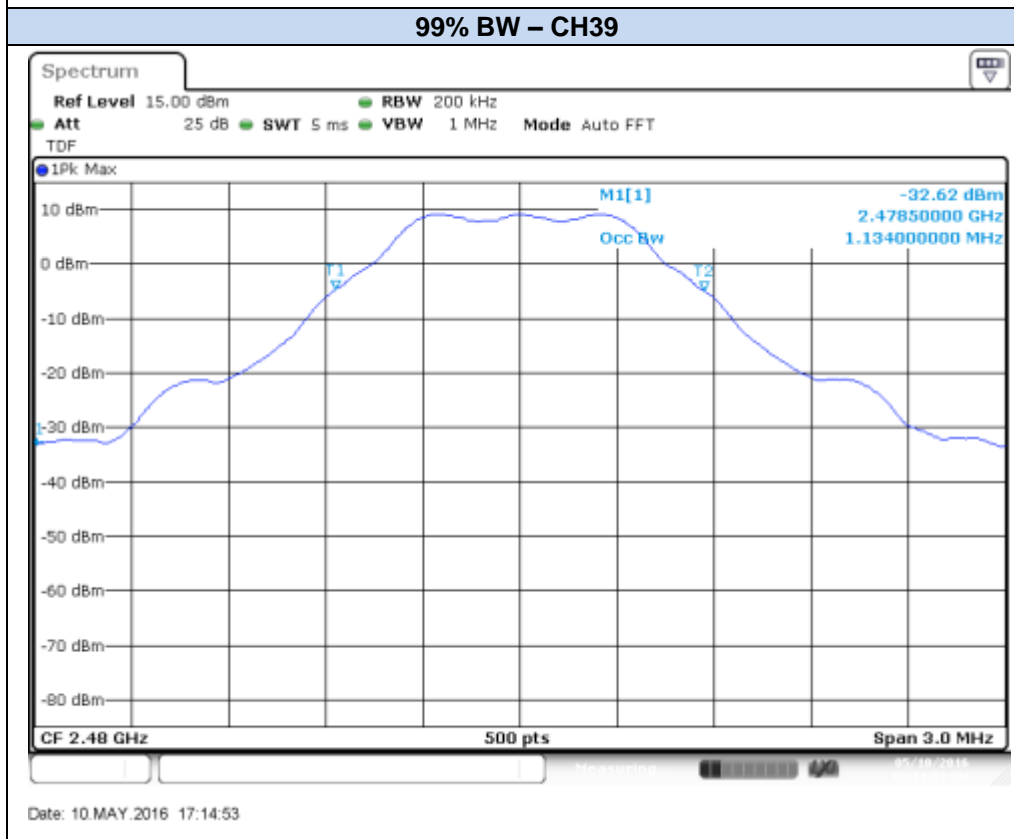
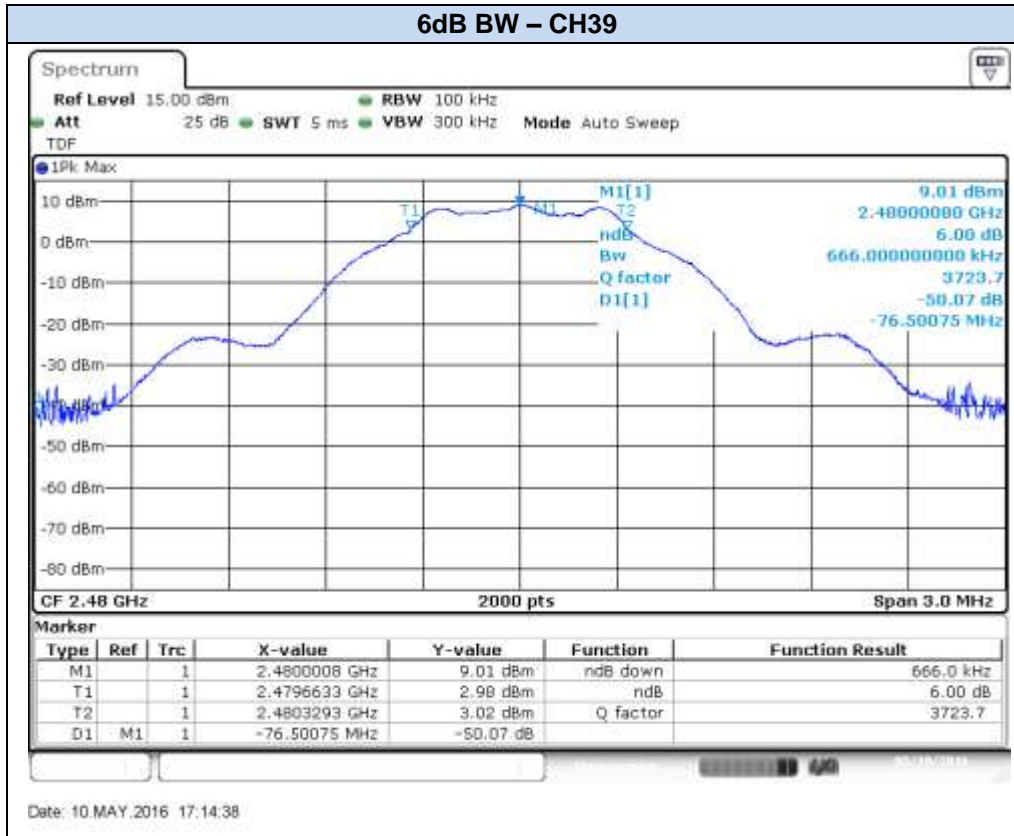

Maximum Output Power and antenna gain and using the lowest, middle and highest channels.

*Radiated Setup < 1GHz*

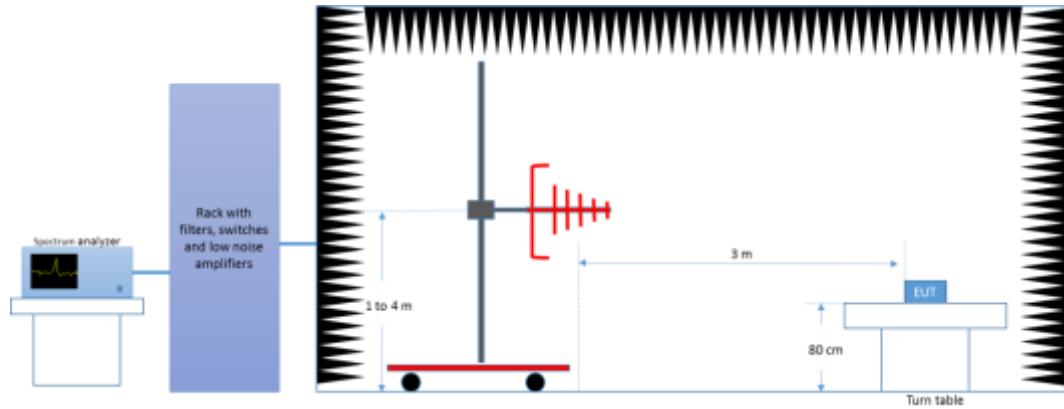

*Radiated Setup 1GHz - 18GHz*

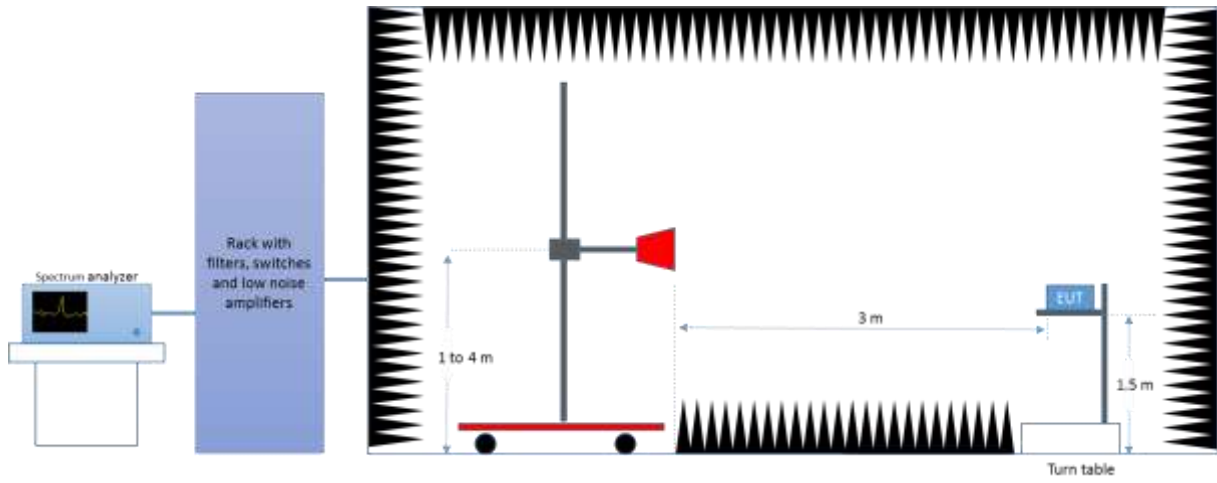

*Radiated Setup > 18GHz*

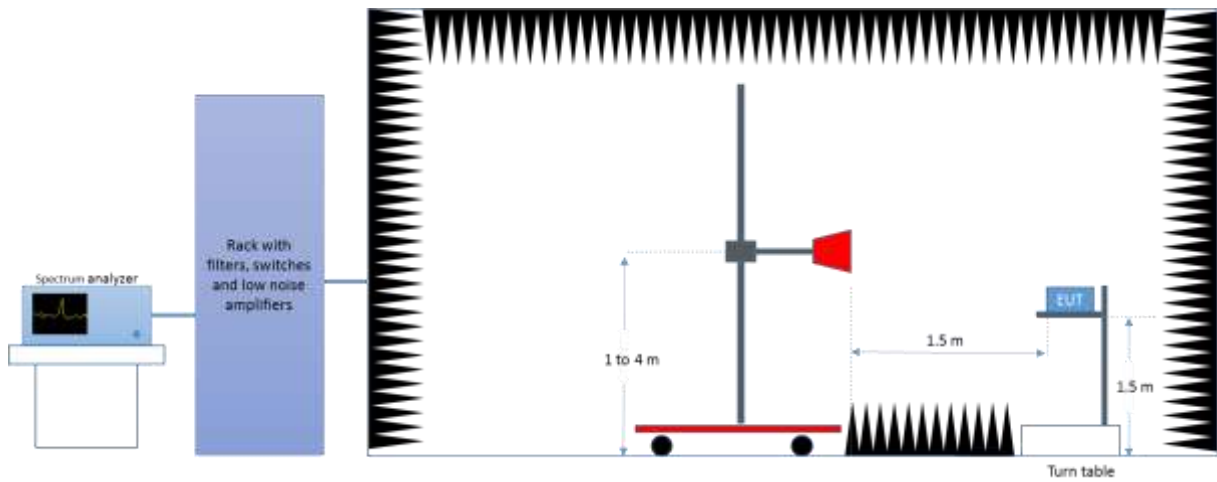



**Test Results:**

**Radiated Spurious – 30MHz – 1GHz**

**Radiated Spurious – All Modes**

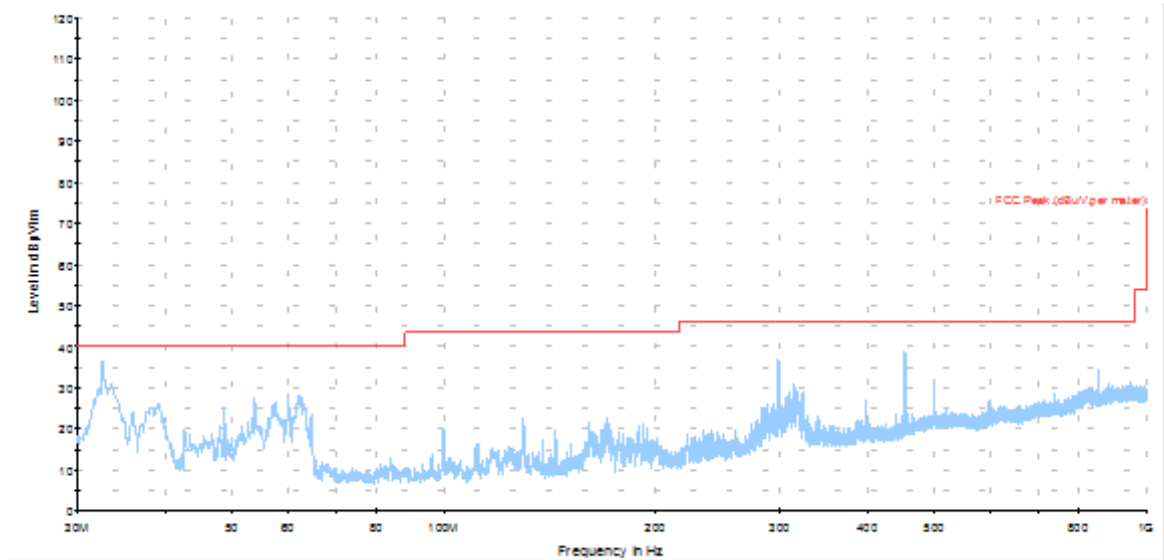

— Peak measurements     
 — AVG measurements     
 — Limit FCC Peak

Frequency	Max Peak	Limit	Margin
MHz	dBuV/m	dBuV/m	dB
32.61	38.81	40	1.19

Note 1: The spurious signals detected do not depend on either the operating channel or the modulation mode.

**1 GHz – 18GHz, BLE**

**Radiated Spurious – CH0**

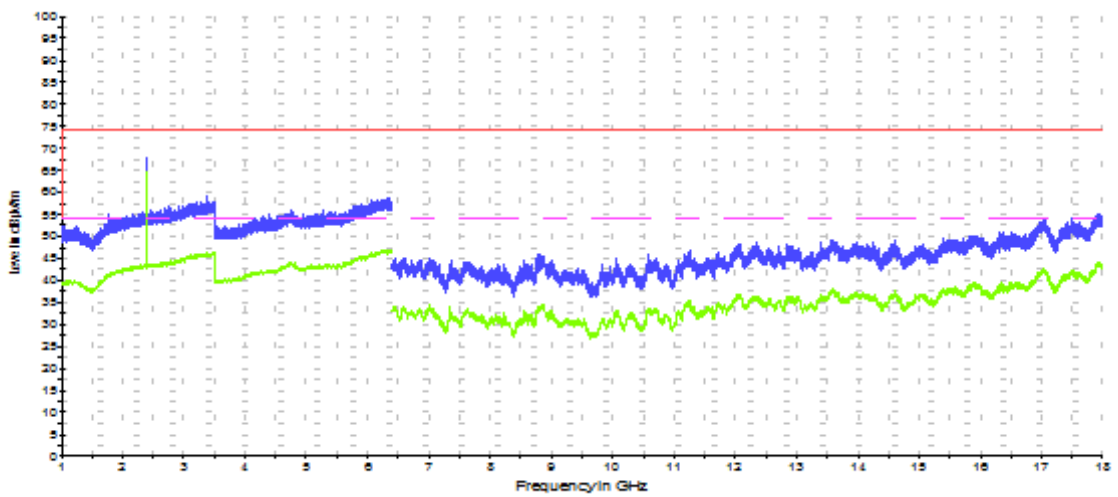

— Peak measurements     
 — AVG measurements     
 — Limit FCC Peak     
 - - - Limit FCC Avg

Frequency	MaxPeak	AvG	Limit	Margin
MHz	dBuV/m	dBuV/m	dBuV/m	dB
6390	58.1	-	74	15.9
6390	-	46.8	54	7.2

### Radiated Spurious – CH19

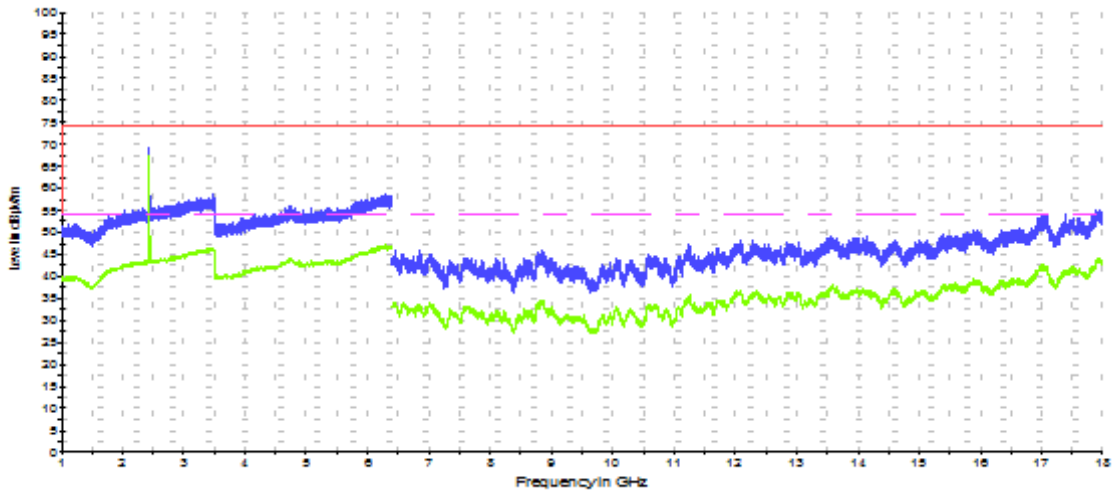

— Peak measurements     
 — AVG measurements     
 — Limit FCC Peak     
 - - - Limit FCC Avg

Frequency	MaxPeak	AvG	Limit	Margin
MHz	dBuV/m	dBuV/m	dBuV/m	dB
6298	58.7	-	74	15.3
6298	-	46.8	54	7.2

### Radiated Spurious – CH39

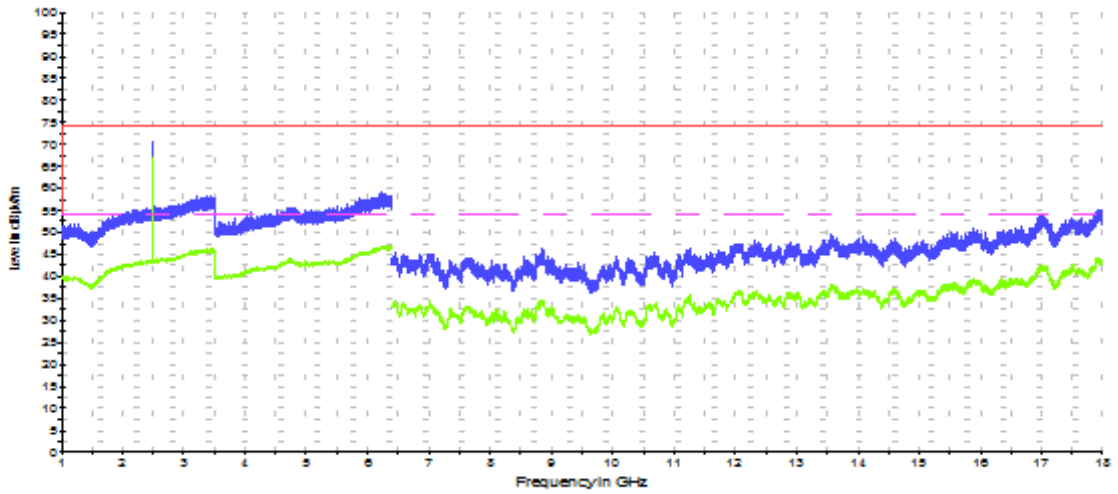

— Peak measurements     
 — AVG measurements     
 — Limit FCC Peak     
 - - - Limit FCC Avg

Frequency	MaxPeak	AvG	Limit	Margin
MHz	dBuV/m	dBuV/m	dBuV/m	dB
6320	58.9	-	74	15.1
6320	-	46.7	54	7.3

## Radiated Spurious – 18 GHz – 25 GHz

### Radiated Spurious – All Modes

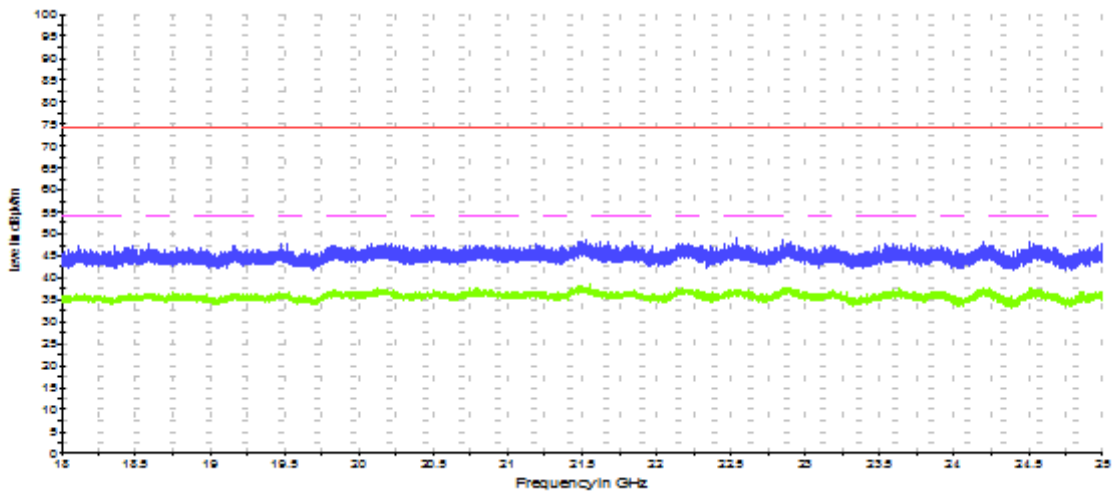

— Peak measurements     
 — AVG measurements     
 — Limit FCC Peak     
 - - - Limit FCC Avg

Frequency	Max Peak	Avg	Limit	Margin
MHz	dBuV/m	dBuV/m	dBuV/m	dB
21487	47.5	-	74	26.5
21487	-	37.8	54	16.2

Note 1: The spurious signals detected do not depend on either the operating channel or the modulation mode.