



TESTING CERT #3478.01



# TEST REPORT

EUT Description	WLAN and BT, 2x2 PCIe M.2 2230 adapter card
Brand Name	Intel® Dual Band Wireless-AC 8265
Model Name	8265NGW
Serial Number	TA#: H93538-003 WF MAC: 34:13:E8:52:E0:3B / 34:13:E8:52:D9:0B / 34:13:E8:52:D8:F7 / 34:13:E8:52:D8:CF BT MAC: 34:13:E8:52:E0:3F / 34:13:E8:52:D9:0F / 34:13:E8:52:D8:FB / 34:13:E8:52:D8:D3 (see section 4)
FCC ID	FCC ID: PD98265NG / PD98265NGU
Antenna type	SkyCross WIMAX/WLAN Reference Antenna
Hardware/Software Version	HW: WsP2230 Cfg12.1MS Test SW: DRTU 1.8.7-02915 Op SW: 19.0.0.3
Date of Sample Receipt	2016-04-01
Date of Test Start/End	2016-04-05 / 2016-05-13
Features	802.11 a/b/g/n/ac Wireless LAN + BDR/EDR 2.1 + BLE 4.2 (see section 5)

Applicant	Intel Mobile Communications
Address	100 Center Point Circle, Suite 200 Columbia, South Carolina 29210 USA
Contact Person	Steven Hackett
Telephone/Fax/ Email	steven.c.hackett@intel.com

Reference Standards	FCC CFR Title 47 Part 15E (see section 1)
---------------------	----------------------------------------------

Test Report number	160321-01.TR01
Revision Control	Rev.00

The test results relate only to the samples tested.  
The test report shall not be reproduced in full, without written approval of the laboratory.

Issued by

Reviewed by

Olivier FARGANT  
(RF Test Lead)

Jose M. FORTES  
(Technical Manager)

Intel Mobile Communications France S.A.S – WRF Lab  
425 rue de Goa – Le Cargo B6 – 06600, Antibes, France  
Tel. +33493001400 / Fax +33493001401

# Table of Contents

---

<b>1. Standards, reference documents and applicable test methods .....</b>	<b>3</b>
<b>2. General conditions, competences and guarantees .....</b>	<b>3</b>
<b>3. Environmental Conditions.....</b>	<b>3</b>
<b>4. Test samples.....</b>	<b>4</b>
<b>5. EUT features .....</b>	<b>4</b>
<b>6. Remarks and comments.....</b>	<b>4</b>
<b>7. Test Verdicts summary.....</b>	<b>5</b>
<b>7.1. 802.11 a/n/ac – U-NII-1.....</b>	<b>5</b>
<b>7.2. 802.11 a/n/ac – U-NII-2A.....</b>	<b>5</b>
<b>7.3. 802.11 a/n/ac – U-NII-2C.....</b>	<b>5</b>
<b>7.4. 802.11 a/n/ac – U-NII-3.....</b>	<b>5</b>
<b>8. Document Revision History .....</b>	<b>5</b>
<b>Annex A. Test &amp; System Description .....</b>	<b>6</b>
A.1 TEST CONDITIONS .....	6
A.2 MEASUREMENT SYSTEM .....	8
A.3 TEST EQUIPMENT LIST.....	10
A.4 MEASUREMENT UNCERTAINTY EVALUATION.....	11
<b>Annex B. Test Results UNII-1 .....</b>	<b>12</b>
B.1 26dB & 99% BANDWIDTH.....	12
B.2 POWER LIMITS. MAXIMUM OUTPUT POWER & MAXIMUM POWER SPECTRAL DENSITY .....	44
B.3 UNDESIRABLE EMISSIONS LIMITS: BAND EDGE (CONDUCTED) .....	62
B.4 RADIATED SPURIOUS EMISSION .....	88
<b>Annex C. Test Results U-NII-2A .....</b>	<b>116</b>
C.1 26dB & 99% BANDWIDTH.....	116
C.2 POWER LIMITS. MAXIMUM OUTPUT POWER & PEAK POWER SPECTRAL DENSITY .....	148
C.3 UNDESIRABLE EMISSIONS LIMITS: BAND EDGE (CONDUCTED) .....	165
C.4 RADIATED SPURIOUS EMISSION .....	185
<b>Annex D. Test Results U-NII-2C .....</b>	<b>213</b>
D.1 26dB & 99% BANDWIDTH.....	213
D.2 POWER LIMITS. MAXIMUM OUTPUT POWER & PEAK POWER SPECTRAL DENSITY .....	265
D.3 UNDESIRABLE EMISSIONS LIMITS: BAND EDGE (CONDUCTED) .....	293
D.4 RADIATED SPURIOUS EMISSION .....	319
<b>Annex E. Test Results U-NII-3.....</b>	<b>356</b>
E.1 6dB & 99% BANDWIDTH.....	356
E.2 POWER LIMITS. MAXIMUM OUTPUT POWER & PEAK POWER SPECTRAL DENSITY .....	401
E.3 UNDESIRABLE EMISSIONS LIMITS: BAND EDGE (CONDUCTED) .....	446
E.4 RADIATED SPURIOUS EMISSION .....	461
<b>Annex E. Photographs.....</b>	<b>489</b>

## 1. Standards, reference documents and applicable test methods

1. FCC 47 CFR part 15 – Subpart E – Unlicensed National Information Infrastructure Devices.
2. FCC 47 CFR part 15 - Subpart C – §15.209 Radiated emission limits; general requirements.
3. FCC OET KDB 789033 D02 General UNII Test Procedures New Rules – Guidelines for compliance testing of Unlicensed National Information Infrastructure (U-NII) Devices.
4. FCC OET KDB 644545 D03 Guidance for IEEE 802.11ac v01 - GUIDANCE FOR IEEE Std 802.11ac™ DEVICES EMISSION TESTING.
5. ANSI C63.10-2013 American National Standard of Procedures for Compliance Testing of Unlicensed Wireless Devices.

## 2. General conditions, competences and guarantees

- ✓ Intel Mobile Communications Wireless RF Lab (Intel WRF Lab) is a testing laboratory accredited by the American Association for Laboratory Accreditation (A2LA).
- ✓ Intel Mobile Communications Wireless RF Lab (Intel WRF Lab) is an Accredited Test Firm listed by the FCC, with Designation Number FR0011.
- ✓ Intel WRF Lab only provides testing services and is committed to providing reliable, unbiased test results and interpretations.
- ✓ Intel WRF Lab is liable to the client for the maintenance of the confidentiality of all information related to the item under test and the results of the test.
- ✓ Intel WRF Lab has developed calibration and proficiency programs for its measurement equipment to ensure correlated and reliable results to its customers.
- ✓ This report is only referred to the item that has undergone the test.
- ✓ This report does not imply an approval of the product by the Certification Bodies or competent Authorities.
- ✓ Complete or partial reproduction of the report cannot be made without written permission of Intel WRF Lab.

## 3. Environmental Conditions

- ✓ At the site where the measurements were performed the following limits were not exceeded during the tests:

Temperature	22°C ± 4°C
Humidity	38% ± 10%

#### 4. Test samples

Sample	Control #	Description	Model	Serial #	Date of reception	Note
#01	160321-01.S02	WiFi/BT Module	8265NGW	WF MAC: 34:13:E8:52:D8:CF, BT MAC: 34:13:E8:52:D8:D3	2016-04-01	Used for conducted tests
	160321-01.S15	WiFi/BT Module	8265NGW	WF MAC: 34:13:E8:52:E0:3B BT MAC: 34:13:E8:52:E0:3F	2016-04-01	
	160107-01.S14	Extender board	PCB00495	ASS00495-01 4950414-064	2016-01-07	
	160107-01.S19	AC/DC Adapter	SPU60-102	08741187 1350	2016-01-07	
	13112601.S05	Laptop	DELL Latitude	27078391477	2014-02-12	
#02	160321-01.S03	WiFi/BT Module	8265NGW	WF MAC: 34:13:E8:52:D9:0B, BT MAC: 34:13:E8:52:D9:0F	2015-04-01	Used for radiated tests (from 30MHz to 1 GHz)
	160107-01.S12	Extender board	PC00495	4955013-034	2016-01-07	
	160107-01.S28	Laptop	Latitude E5440	BJSYN32	2016-01-15	
#03	160321-01.S05	WiFi/BT Module	8265NGW	WF MAC: 34:13:E8:52:D8:F7 BT MAC: 34:13:E8:52:D8:FB	2016-04-01	Used for radiated tests (from 1GHz to 25GHz)
	15060102.S03	Extender board	PCB00495	ASS00495-01 4955013-045	2015-06-12	
	15040201.S15	Laptop	DELL Latitude	21238680926	2015-04-15	

NA: Not Applicable

#### 5. EUT features

These are the detailed bands and modes supported by the Equipment Under Test:

802.11b/g/n	2.4GHz (2400.0 – 2483.5 MHz)
802.11a/n/ac	5.2GHz (5150.0 – 5250.0 MHz) 5.3GHz (5250.0 – 5350.0 MHz) 5.6GHz (5470.0 – 5725.0 MHz) 5.8GHz (5725.0 – 5850.0 MHz)
BDR/EDR 2.1 BLE 4.2	2.4GHz (2400.0 – 2483.5 MHz)

#### 6. Remarks and comments

N/A

## 7. Test Verdicts summary

### 7.1. 802.11 a/n/ac – U-NII-1

FCC part	Test name	Verdict
15.407 (a) (1)	Power Limits. Maximum output power	P
15.407 (a) (1)	Peak power spectral density	P
15.407 (b) (1) 15.209	Undesirable emissions limits: Band Edge (conducted)	P
15.407 (b) (1) 15.209	Undesirable emissions limits (radiated)	P

### 7.2. 802.11 a/n/ac – U-NII-2A

FCC part	Test name	Verdict
15.407 (a) (2)	Power Limits. Maximum output power	P
15.407 (a) (2)	Peak power spectral density	P
15.407 (b) (2) 15.209	Undesirable emissions limits: Band Edge (conducted)	P
15.407 (b) (2) 15.209	Undesirable emissions limits (radiated)	P

### 7.3. 802.11 a/n/ac – U-NII-2C

FCC part	Test name	Verdict
15.407 (a) (2)	Power Limits. Maximum output power	P
15.407 (a) (2)	Peak power spectral density	P
15.407 (b) (3) 15.209	Undesirable emissions limits: Band Edge (conducted)	P
15.407 (b) (3) 15.209	Undesirable emissions limits (radiated)	P

### 7.4. 802.11 a/n/ac – U-NII-3

FCC part	Test name	Verdict
15.407 (a) (2)	Power Limits. Maximum output power	P
15.407 (a) (2)	Peak power spectral density	P
15.407 (b) (3) 15.209	Undesirable emissions limits: Band Edge (conducted)	P
15.407 (b) (3) 15.209	Undesirable emissions limits (radiated)	P

P: Pass  
 F: Fail  
 NM: Not Measured  
 NA: Not Applicable

## 8. Document Revision History

Revision #	Date	Modified by	Details
Rev. 00	2016-05-17	F. Sauvan	First Issue

# Annex A. Test & System Description

## A.1 Test Conditions

For 802.11a mode the EUT can transmit at both CHAIN A and CHAIN B RF outputs individually, but not simultaneously.

For 802.11n20 (20 MHz channel bandwidth), 802.11n40 (40MHz channel bandwidth) and 802.11ac80 (80MHz channel bandwidth) modes the EUT can transmit at both CHAIN A and CHAIN B RF outputs individually, and also simultaneously.

The conducted RF output power at chain A was adjusted according to the client's supplied Target values (see following table) using the Intel DRTU tool and measuring the power by using a spectrum analyzer with the channel integration method according to point II) E) 2) e) (Method SA-2 Alternative) of Guidance 789033 D02.

Measured values for adjustment were within -0.2 dB/+0.3 dB from the declared Target values.

U-NII-1					Conducted Power, Target Value (dBm)		
Mode	BW (MHz)	Data Rate	CH #	Freq. (MHz)	SISO Chain A	SISO Chain B	MIMO at both ports A and B
802.11a	20	6Mbps	36	5180	17.5	18.0	-
			40	5200	20.5	20.5	-
			48	5240	20.5	20.5	-
802.11n	20	HT0 HT8*	36	5180	18.0	17.5	16
			40	5200	20.5	20.0	19
			48	5240	20.5	20.5	19
	40	HT0 HT8*	38F	5190	17.0	17	12
			46F	5230	20.5	20.5	19
802.11ac	80	VHT0	42ac80	5210	13.0	13	10

U-NII-2A					Conducted Power, Target Value (dBm)		
Mode	BW (MHz)	Data Rate	CH #	Freq. (MHz)	SISO Chain A	SISO Chain B	MIMO at both ports A and B
802.11a	20	6Mbps	52	5260	20.5	20.5	-
			56	5280	20.5	20.0	-
			64	5320	17	17.5	-
802.11n	20	HT0 HT8*	52	5260	20.5	20.0	19
			56	5280	20.5	20.0	19
			64	5320	17	17	13
	40	HT0 HT8*	54F	5270	20.5	19.5	19
			62F	5310	13	14	11.5
802.11ac	80	VHT0	58ac80	5290	11.5	12	9

U-NII-2C					Conducted Power, Target Value (dBm)		
Mode	BW (MHz)	Data Rate	CH #	Freq. (MHz)	SISO Chain A	SISO Chain B	MIMO at both ports A and B
802.11a	20	6Mbps	100	5500	17.5	18	-
			120	5600	20.0	20.0	-
			140	5700	18.0	18.5	-
802.11n	20	HT0 HT8*	100	5500	17.5	17.5	16.0
			104	5520	20.0	20.0	18.5
			120	5600	20.0	20.0	19
			132	5660	20.0	20.0	18
			136	5680	20.0	20.0	17.5
			140	5700	17.5	18.0	15.5
			<b>144*</b>	5720	19	19.5	18
	40	HT0 HT8*	102F	5510	18.5	16.0	12.5
			110F	5550	20.5	20.5	18.0
			118F	5590	20.5	20.5	20.0
			126F	5630	20.5	20.5	19.5
134F			5670	19.0	19.0	17.5	
<b>142F*</b>	5670	19.5	20.5	19.5			
802.11ac	80	VHT0	106ac80	5530	12.5	15.5	10.5
			122ac80	5610	19.5	18.0	17
			<b>138ac80*</b>	5690	19.5	20.0	20

U-NII-3					Conducted Power, Target Value (dBm)		
Mode	BW (MHz)	Data Rate	CH #	Freq. (MHz)	SISO Chain A	SISO Chain B	MIMO at both ports A and B
802.11a	20	6Mbps	149	5745	20.0	20.5	20.0
			157	5785	20.5	20.5	20.5
			165	5825	20.5	20.0	19.5
802.11n	20	HT0 HT8*	<b>144*</b>	5720	11.5	12.0	11.0
			149	5745	20.0	20.0	20.0
			157	5785	20.0	20.5	20.5
			165	5825	20.0	20.0	19.5
	40	HT0 HT8*	<b>142F*</b>	5670	7.5	8.0	7.0
			151F	5755	20.5	20.5	18.5
			159F	5795	20.5	20.5	20.5
802.11ac	80	VHT0	<b>138ac80*</b>	5690	3.0	3.0	3.5
			155ac80	5775	18.5	17.5	16.5

\*Overlapped channels between UNII-2C and UNII-3

The following data rates were selected based on preliminary testing that identified those rates as the worst cases for output power and spurious levels at the band edges:

- 802.11a → 6Mbps
- 802.11n20 and 802.11n40 (SISO) → HT0
- 802.11n20 and 802.11n40 (MIMO) → HT8
- 802.11ac80 (SISO) → VHT0
- 802.11ac80 (MIMO) → VHT0

Alternative channels to the lowest and highest channels per band have been also tested for Band Edge compliance.

## A.2 Measurement system

Measurements were performed using the following setups, made in accordance to the general provisions of FCC KDB 789033 D02 General UNII Test Procedures.

The DUT was installed in a test fixture and this test fixture is connected to a laptop computer and AC/DC power adapter. The laptop computer was used to configure the EUT to continuously transmit at a specified output power using all different modes and modulation schemes, using the Intel proprietary tool DRTU.

### Conducted Setup

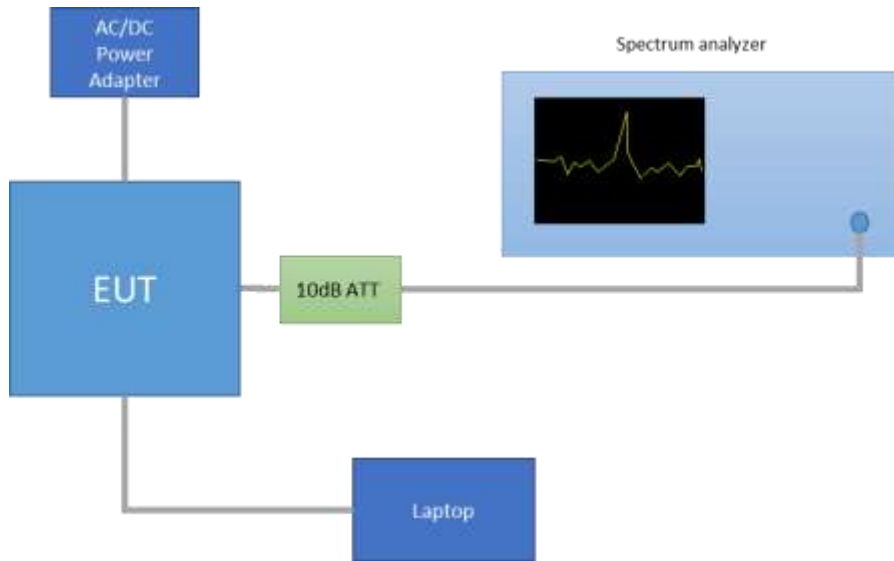

### Radiated Setup < 1GHz

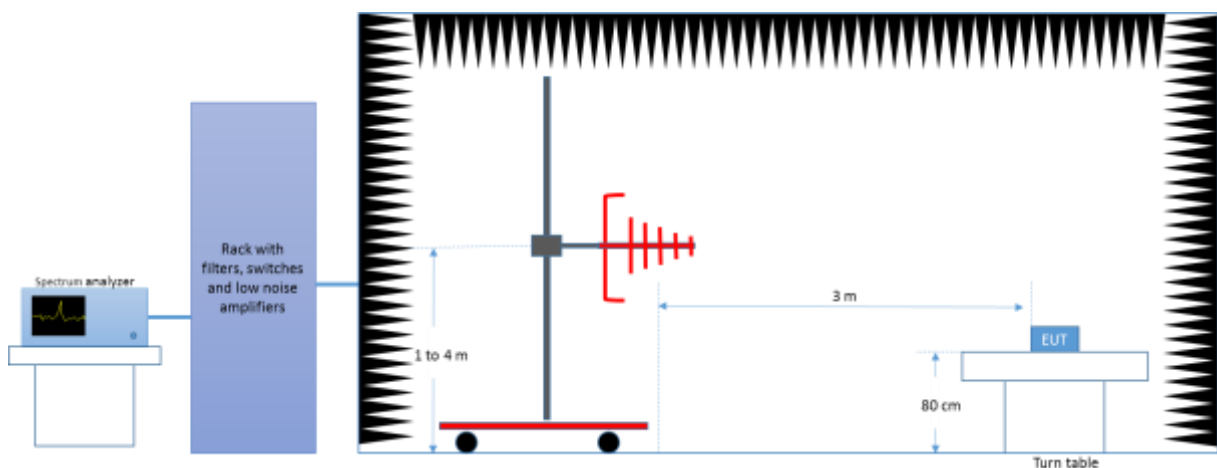



*Radiated Setup 1 GHz - 18 GHz*

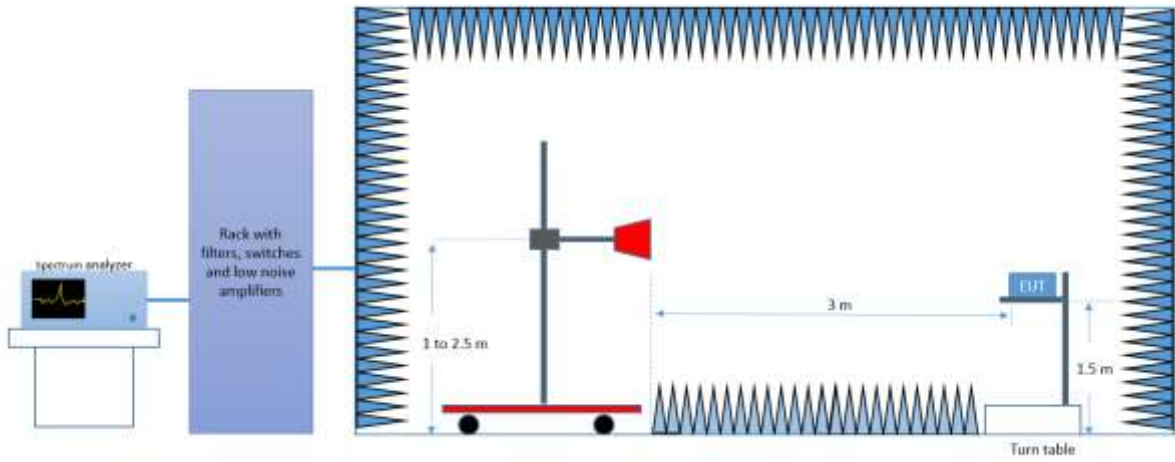

*Radiated Setup 18 GHz - 26.5 GHz*

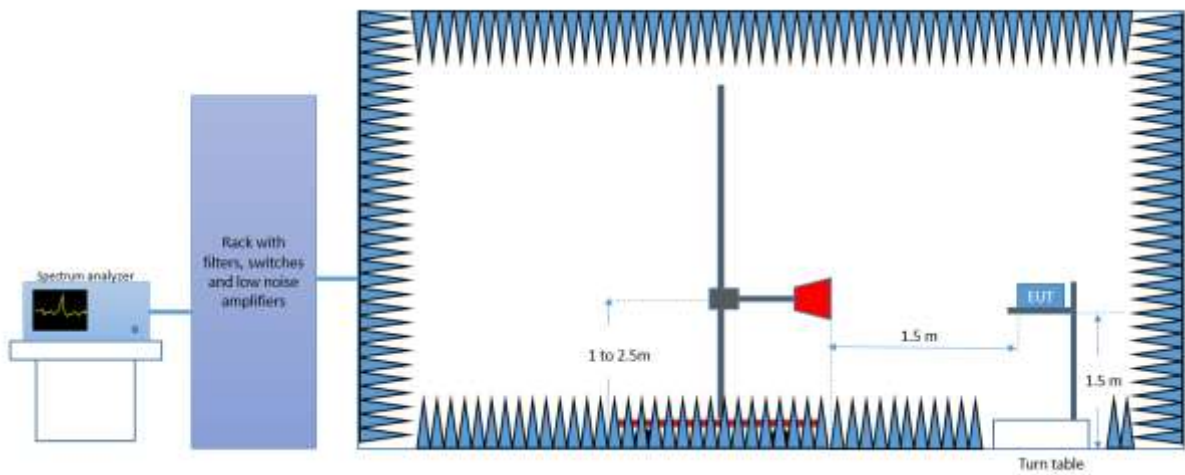

*Radiated Setup > 26.5 GHz*

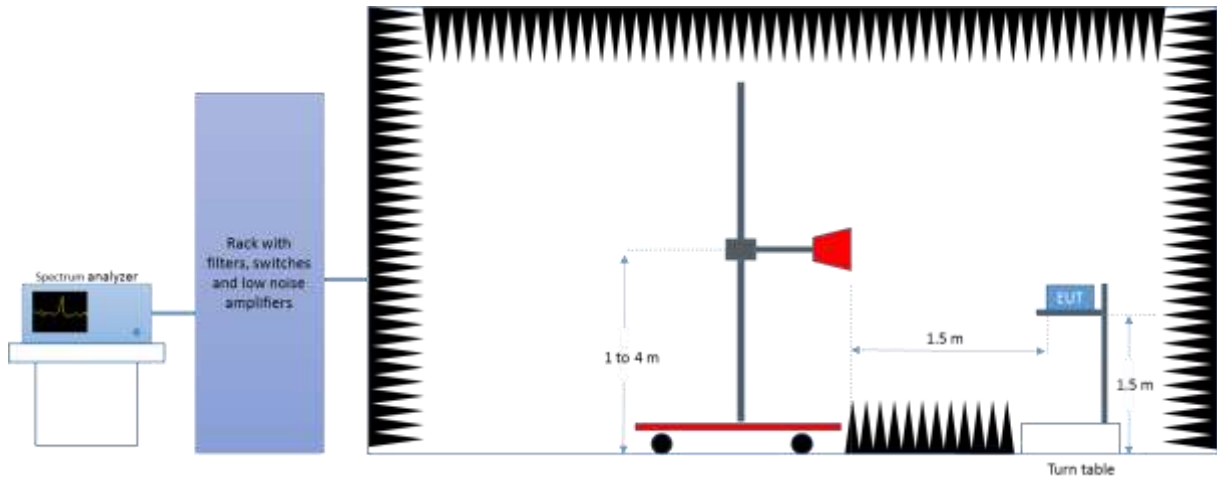

### A.3 Test Equipment List

#### Conducted Setup

ID#	Device	Type/Model	Serial Number	Manufacturer	Cal. Date	Cal. Due Date
0316	Spectrum analyzer	FSV	103309	Rohde & Schwarz	2015-03-20	2017-03-20

#### Radiated Setup

ID#	Device	Type/Model	Serial Number	Manufacturer	Cal. Date	Cal. Due Date
0133	Spectrum analyzer	FSV40	101358	Rohde & Schwarz	2016-04-15	2018-04-15
0258	Spectrum analyzer	FSV30	101318	Rohde & Schwarz	2016-04-27	2018-04-27
0310	Spectrum analyzer	FSV40	101425	Rohde & Schwarz	2015-03-25	2017-03-25
0137	Log antenna 30 MHz – 1 GHz	3142E	00156946	ETS Lindgren	2015-12-11	2017-12-11
0138	Horn antenna 1 GHz – 6.4 GHz	3117	00157734	ETS Lindgren	2016-03-14	2018-03-14
0343	Horn Antenna 6.4 GHz – 18 GHz	3117-PA	00201542	ETS Lindgren	2015-07-16	2017-07-16
0334	Horn Antenna 10 GHz – 40 GHz	3116C	00169308	ETS Lindgren	2015-07-15	2017-07-15
0139	Horn Antenna 18 GHz - 26.5 GHz	114514	00167100	ETS Lindgren	2014-08-14	2016-08-14
0140	Horn Antenna 26.5 GHz - 40 GHz	120722	00169638	ETS Lindgren	2016-03-16	2018-03-16
0135	Semi Anechoic chamber	FACT 3	5720	ETS Lindgren	2016-04-13	2016-05-28
0337	Full Anechoic chamber	RFD_FA_100	5996	ETS Lindgren	2015-09-08	2019-09-08
0329	Measurement Software	EMC32	1300.7027.00 (100401)	Rohde & Schwarz	N/A	N/A
N/A	Measurement Software	EMC32	012109650000013B (009977)	Rohde & Schwarz	N/A	N/A

#### A.4 Measurement Uncertainty Evaluation

The system uncertainty evaluation is shown in the below table:

Measurement type	Uncertainty [ $\pm$ dB]
Conducted Power	$\pm 1.0$
Conducted Spurious Emission	$\pm 2.9$
Radiated tests <1GHz	$\pm 3.8$
Radiated tests 1GHz - 40 GHz	$\pm 4.7$

# Annex B. Test Results UNII-1

## B.1 26dB & 99% Bandwidth

### Test procedure

The setup below was used to measure the 26dB & 99% Bandwidth. The antenna terminal of the EUT is connected to the spectrum analyzer through an attenuator, and the spectrum analyzer reading is compensated to include the RF path loss.

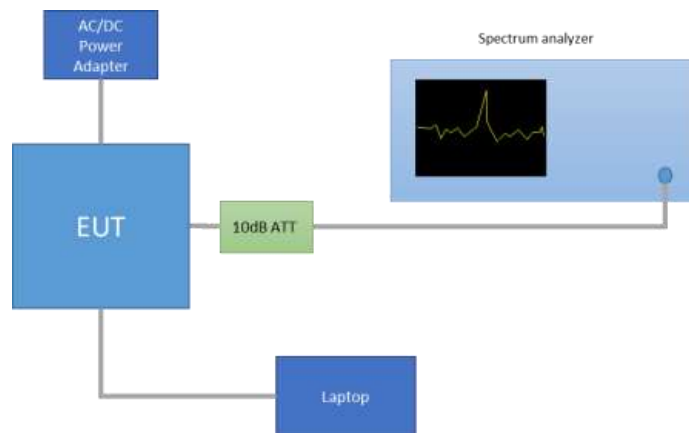

### Results tables

Mode	Rate	Antenna	Channel	Frequency [MHz]	26dB BW [MHz]	99% BW [MHz]
802.11a	6Mbps	SISO CHAIN A	36	5180	23.95	16.64
			40	5200	30.85	18.80
			48	5240	30.35	18.44
		SISO CHAIN B	36	5180	23.75	16.60
			40	5200	<b>31.50</b>	<b>19.08</b>
			48	5240	<b>31.50</b>	19.00
802.11n20	HT0	SISO CHAIN A	36	5180	25.25	17.84
			40	5200	30.35	19.00
			48	5240	31.20	18.92
		SISO CHAIN B	36	5180	24.25	17.72
			40	5200	34.05	19.88
			48	5240	<b>35.75</b>	<b>21.72</b>
802.11n20	HT8	MIMO CHAIN A	36	5180	24.20	17.72
			40	5200	30.85	19.12
			48	5240	28.90	18.36
		MIMO CHAIN B	36	5180	23.35	17.68
			40	5200	27.65	18.20
			48	5240	26.15	18.04

Mode	Rate	Antenna	Channel	Frequency [MHz]	26dB BW [MHz]	99% BW [MHz]
802.11n40	HT0	SISO CHAIN A	38F	5190	45.09	36.40
			46F	5230	50.31	36.80
		SISO CHAIN B	38F	5190	45.09	36.40
			46F	5230	<b>57.06</b>	<b>37.28</b>
	HT8	MIMO CHAIN A	38F	5190	45.99	36.40
			46F	5230	48.60	36.64
		MIMO CHAIN B	38F	5190	43.29	36.08
			46F	5230	44.82	36.24
802.11ac80	VHT0	SISO CHAIN A	42ac80	5210	86.45	<b>75.00</b>
		SISO CHAIN B	42ac80	5210	84.74	<b>75.00</b>
	VHT0	MIMO CHAIN A	42ac80	5210	<b>86.64</b>	<b>75.00</b>
		MIMO CHAIN B	42ac80	5210	85.88	<b>75.00</b>

**Max Value**

**Results screenshot**

**802.11a, 6Mbps – SISO - Chain A**

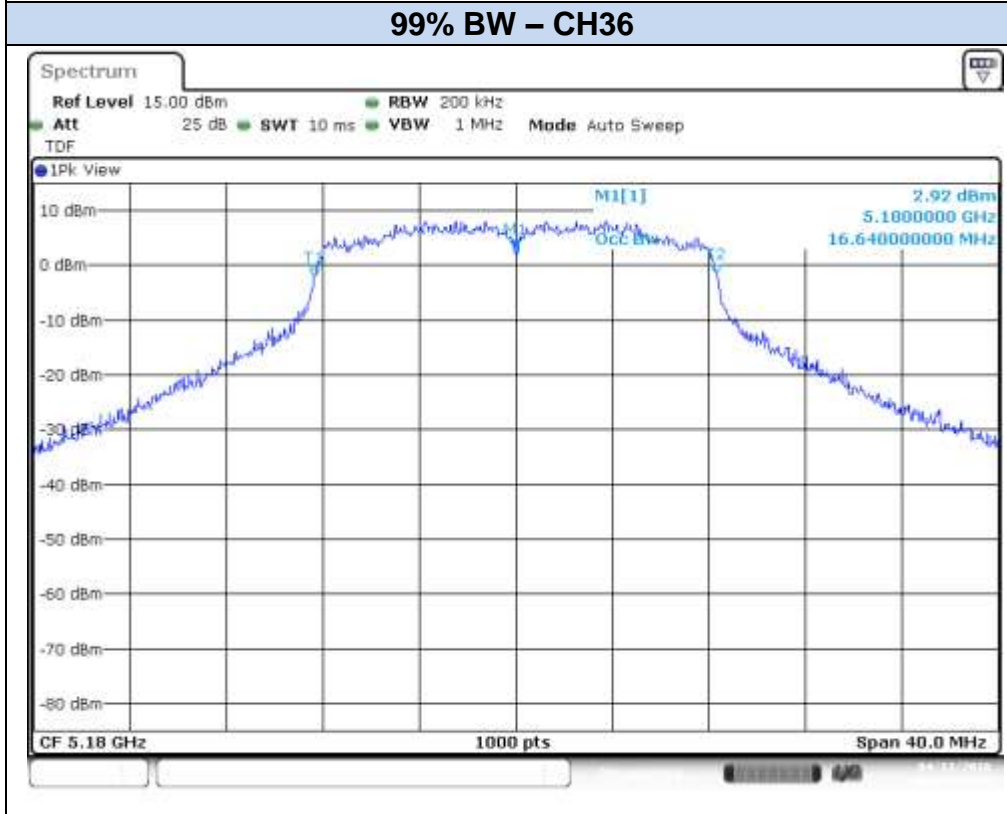
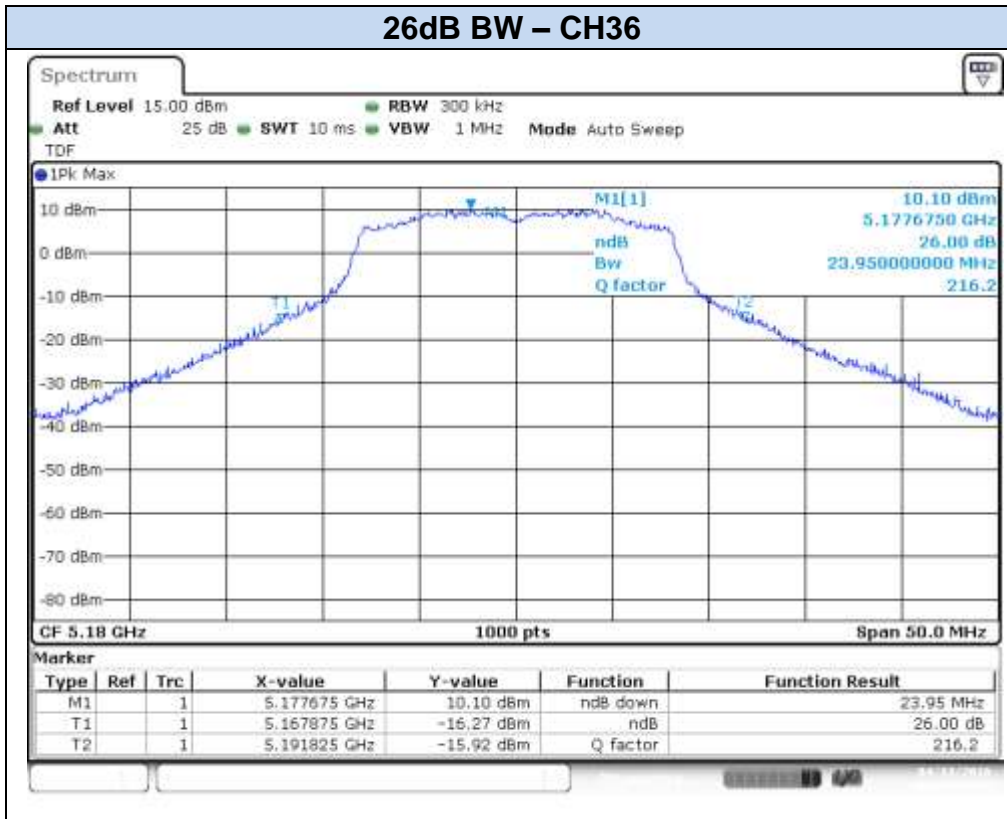

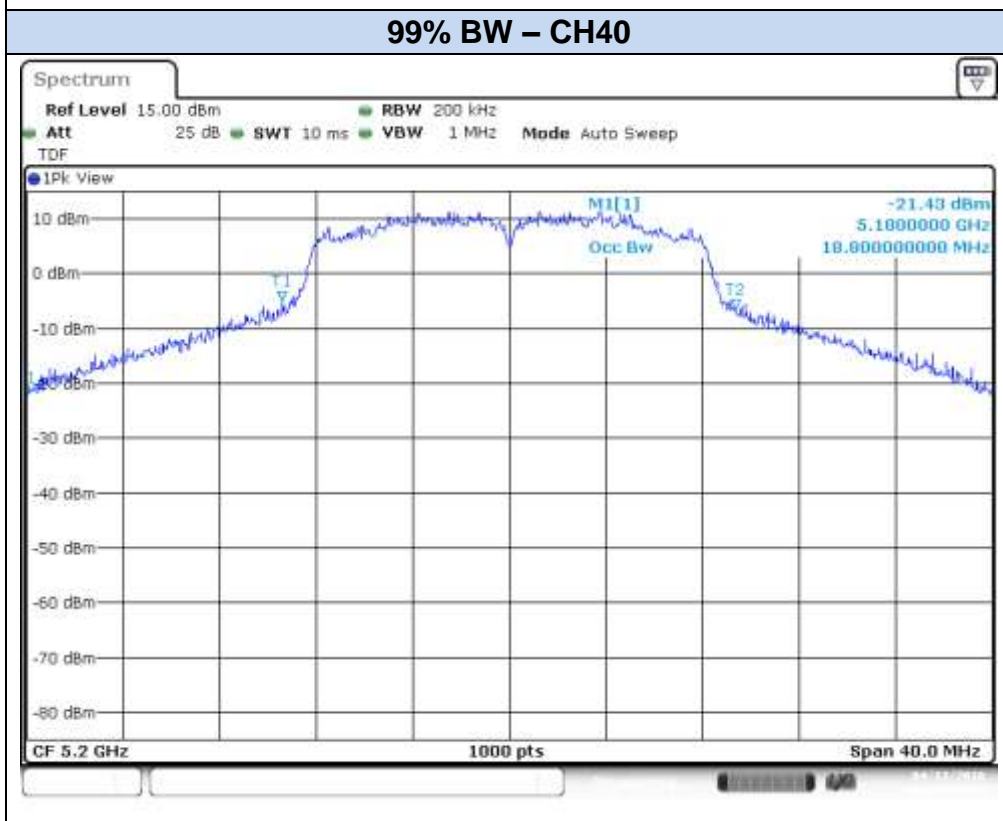
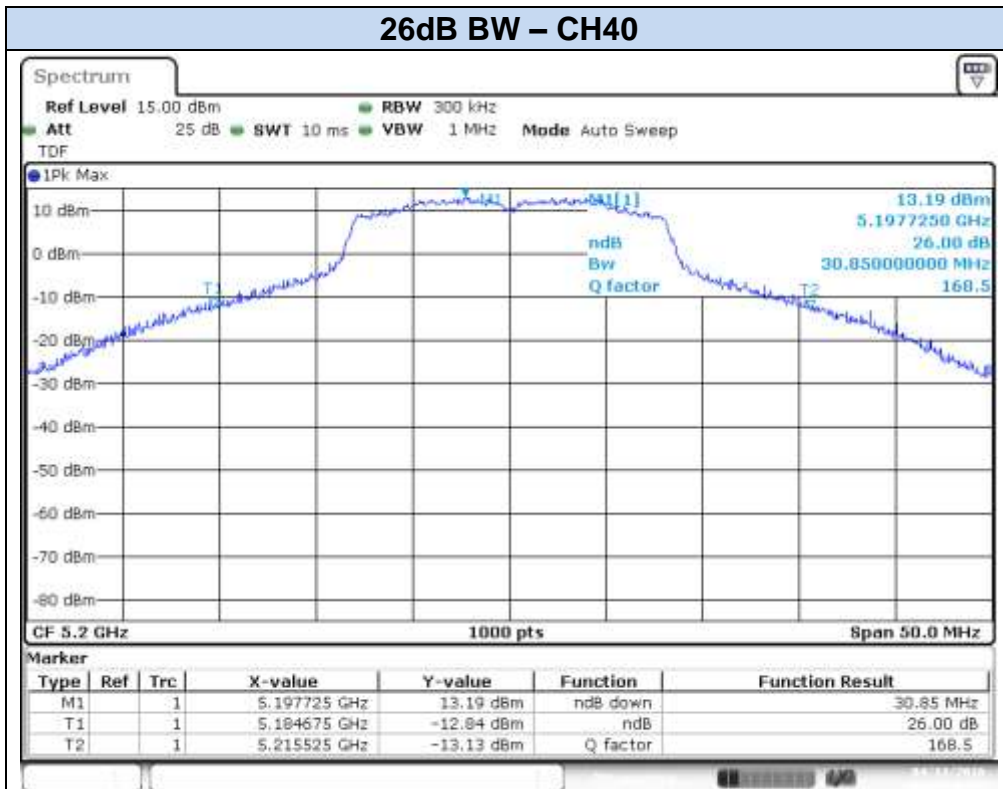

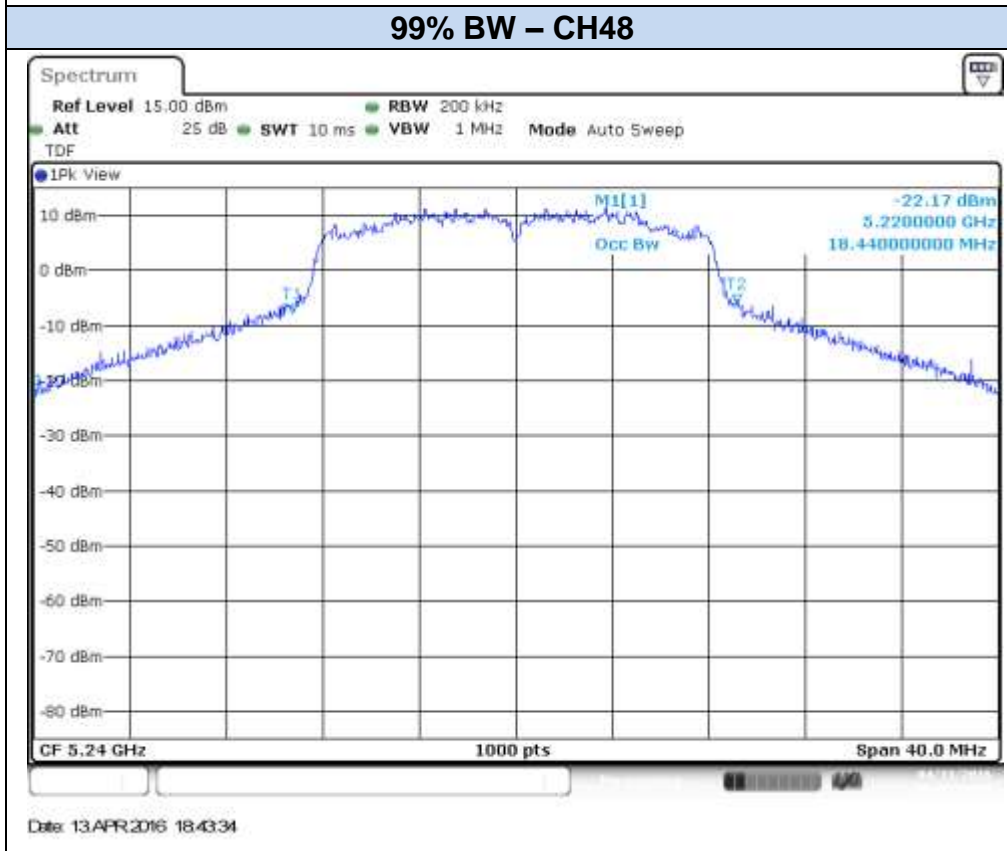
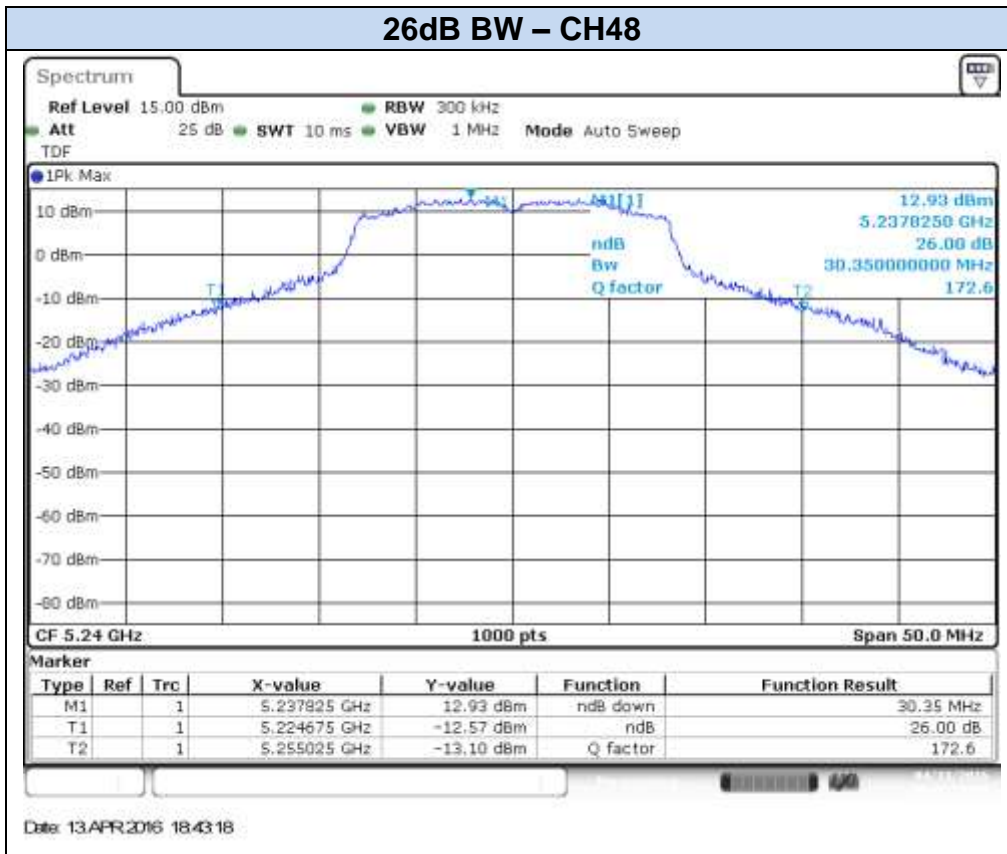



**802.11a, 6Mbps – SISO - Chain B**

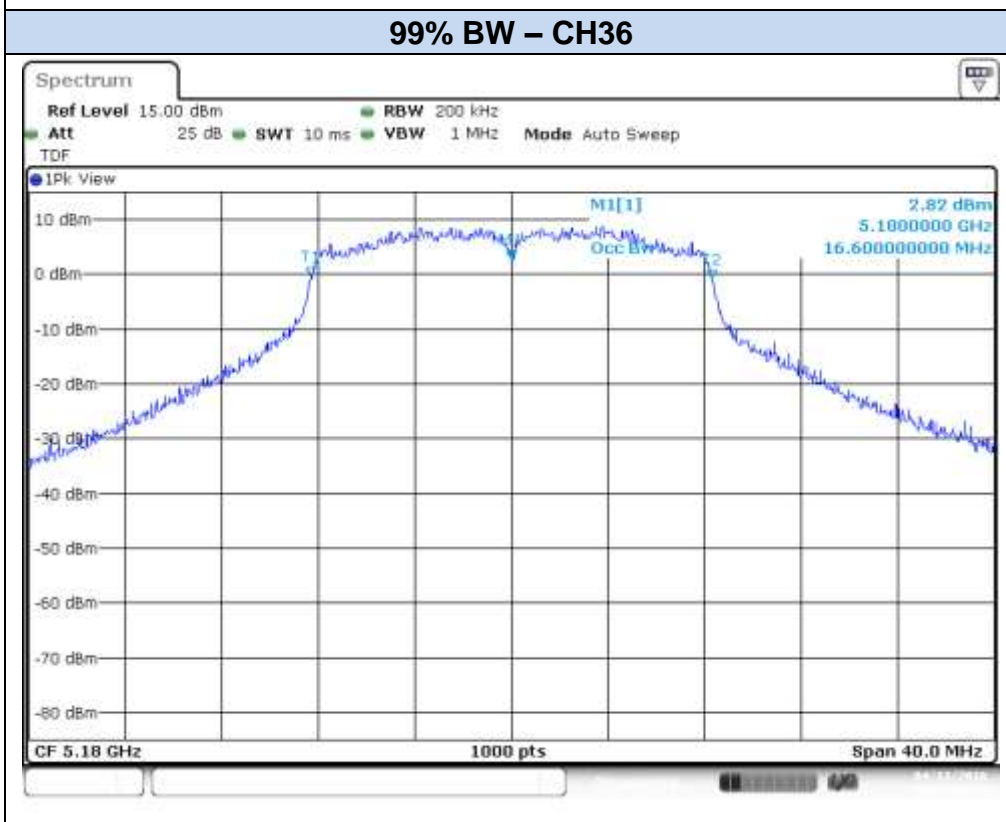
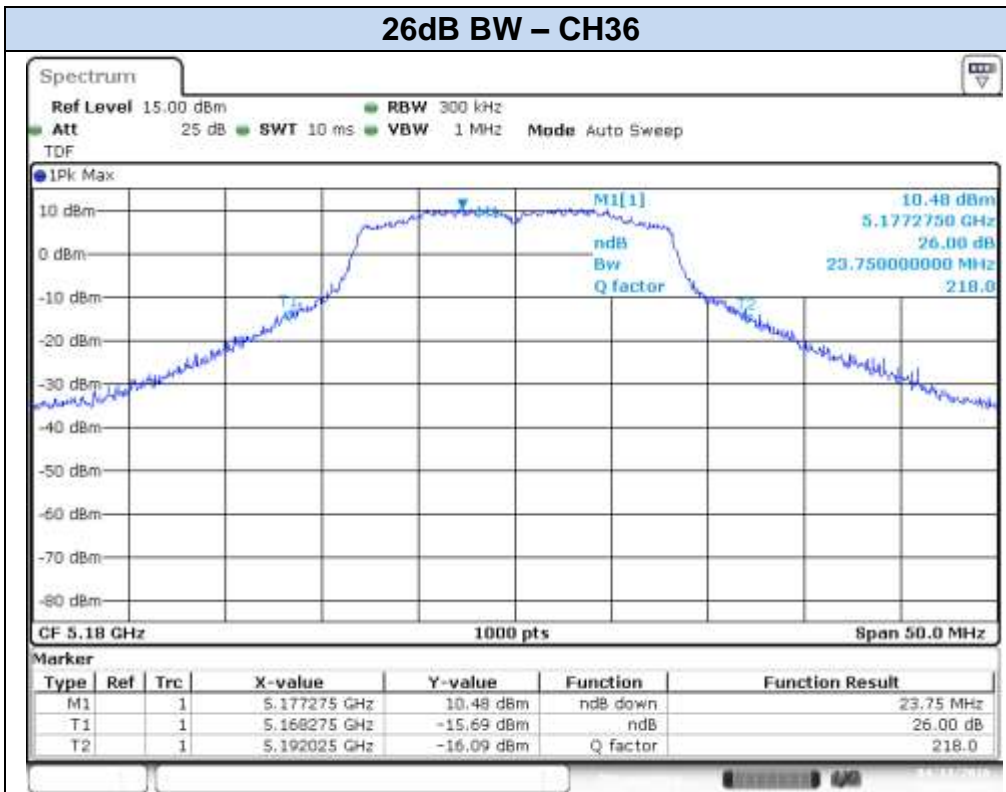

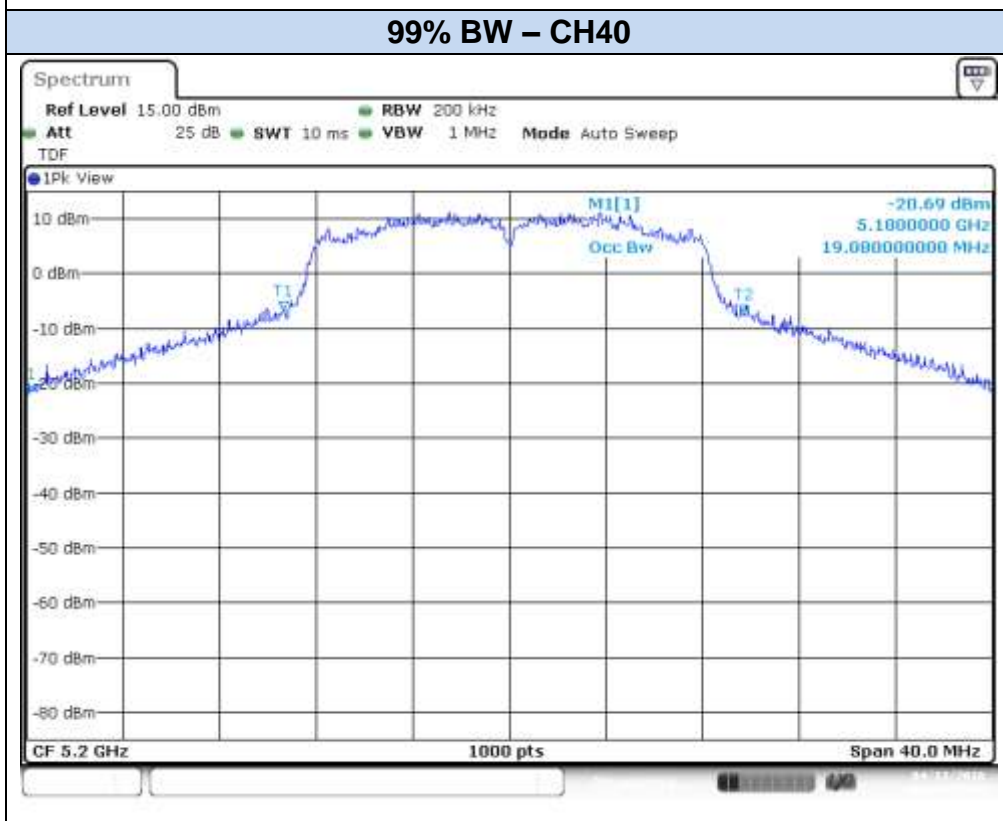
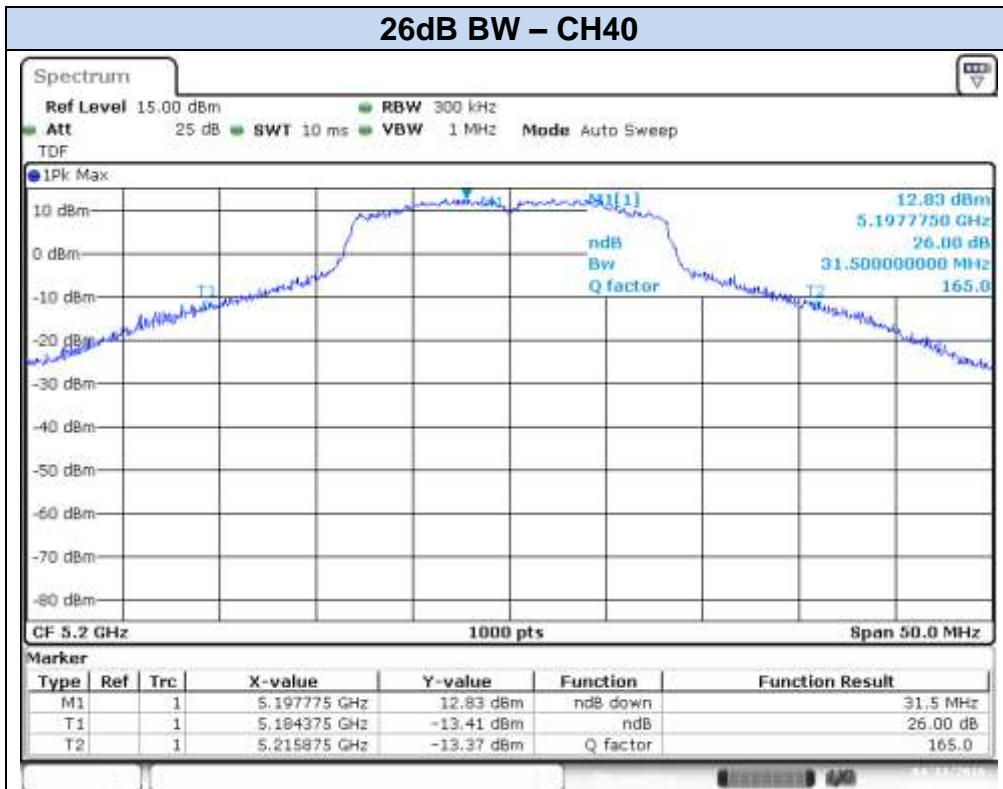

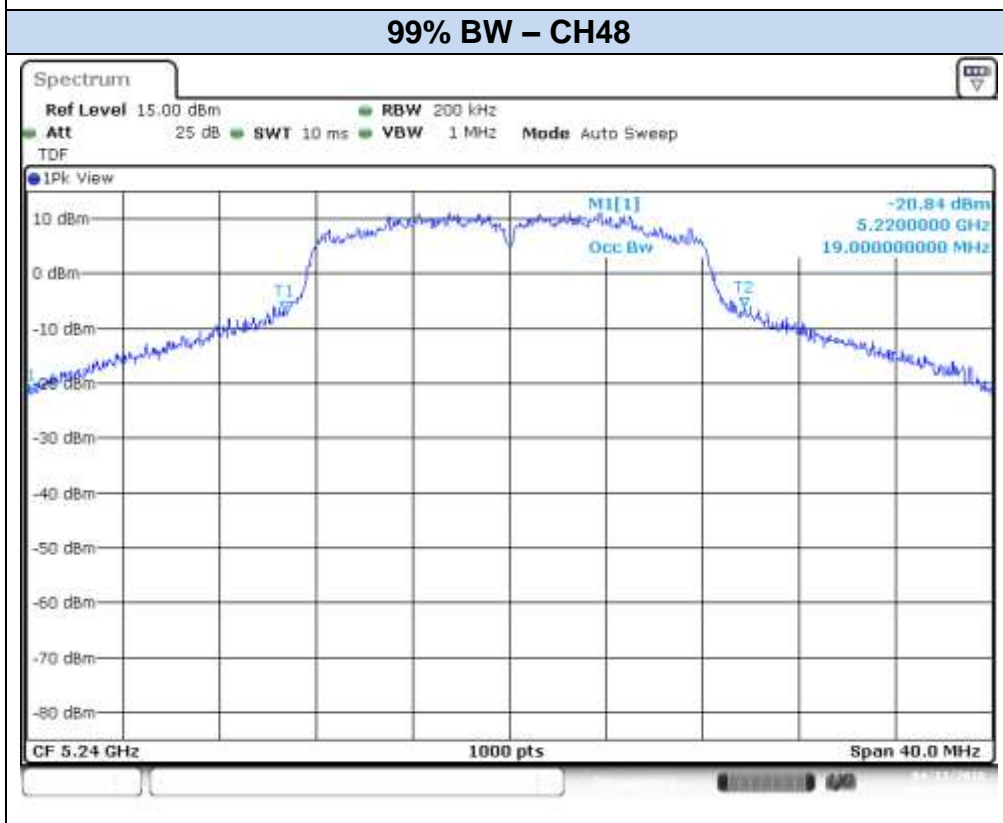
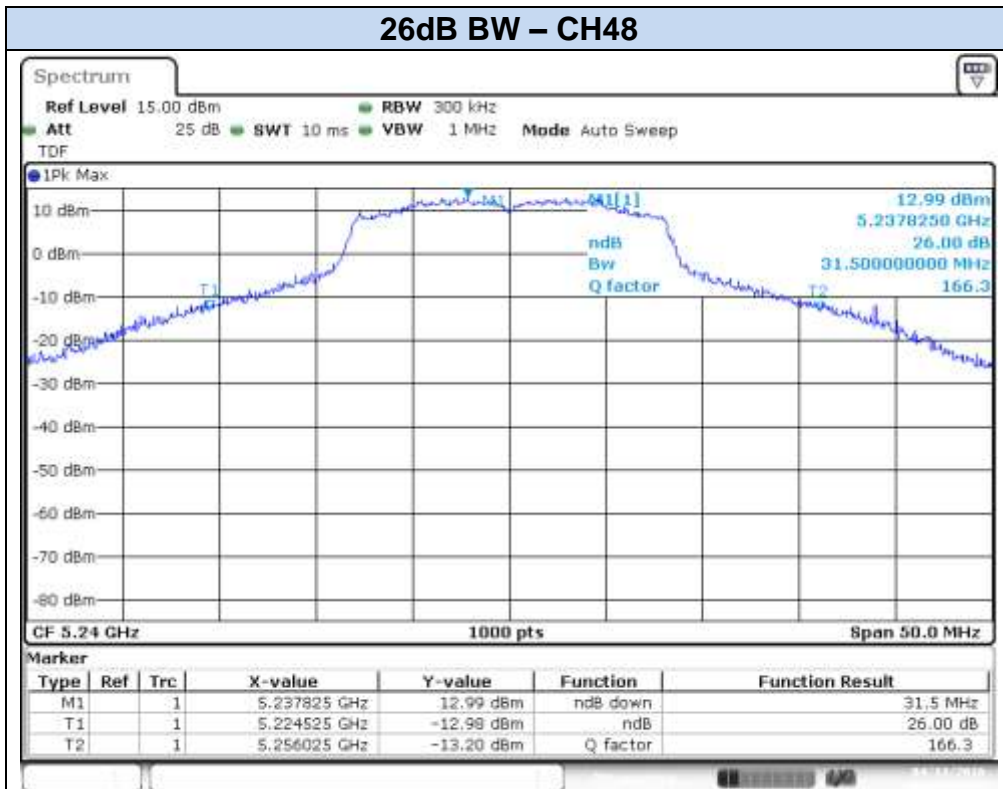

**802.11n20, HT0 – SISO - Chain A**

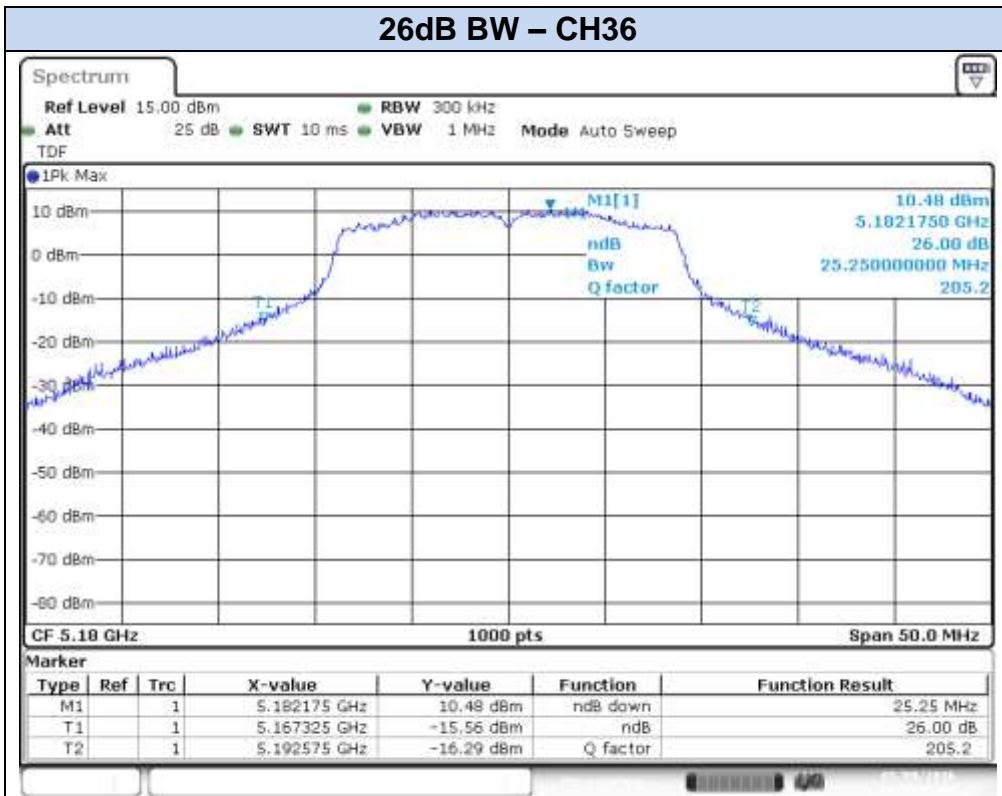

Date: 9.MAY 2016 11:43:55

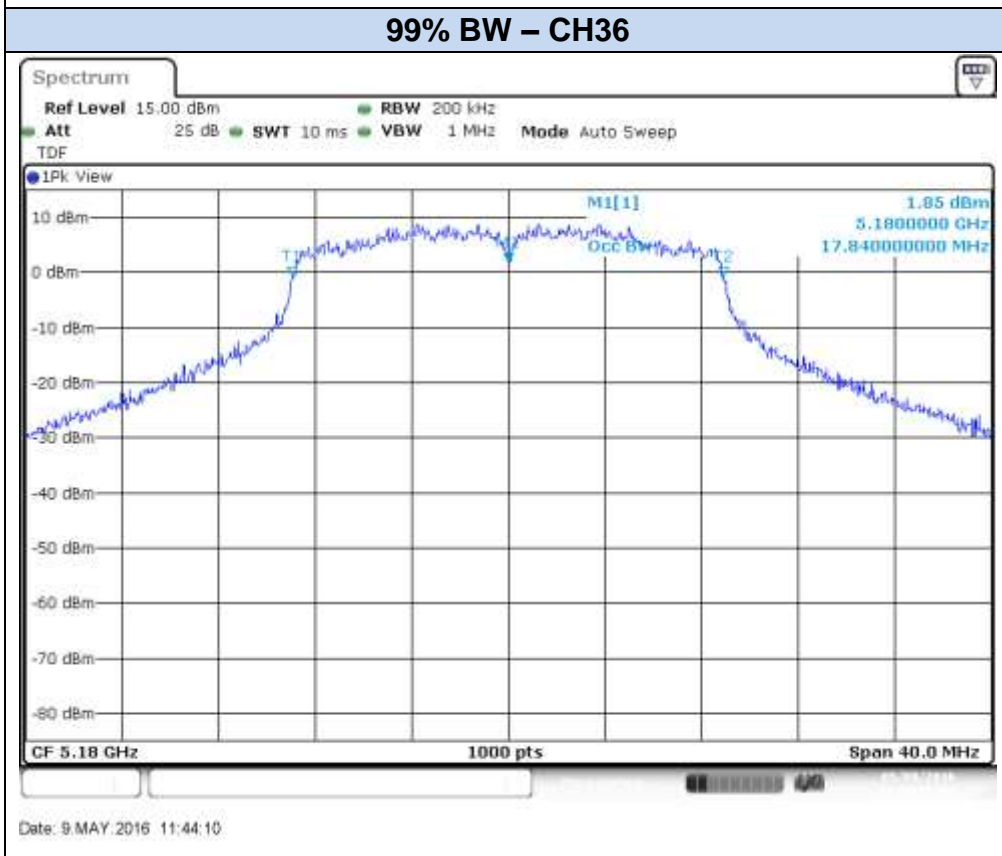

Date: 9.MAY 2016 11:44:10

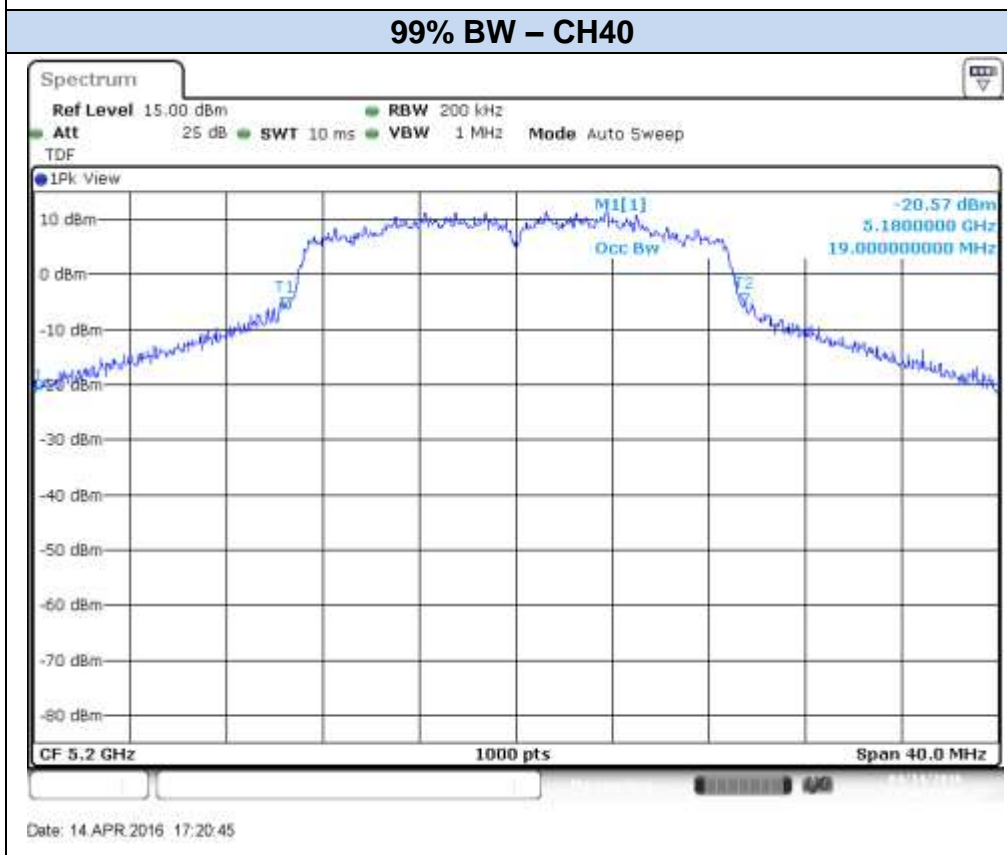
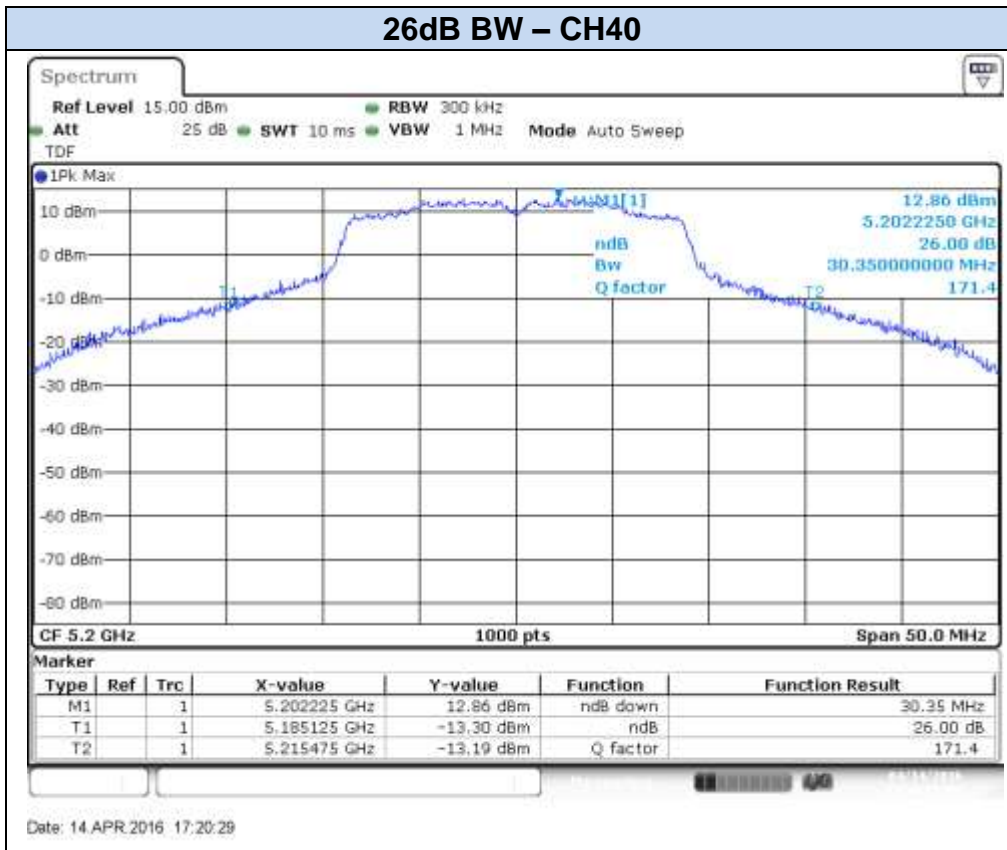

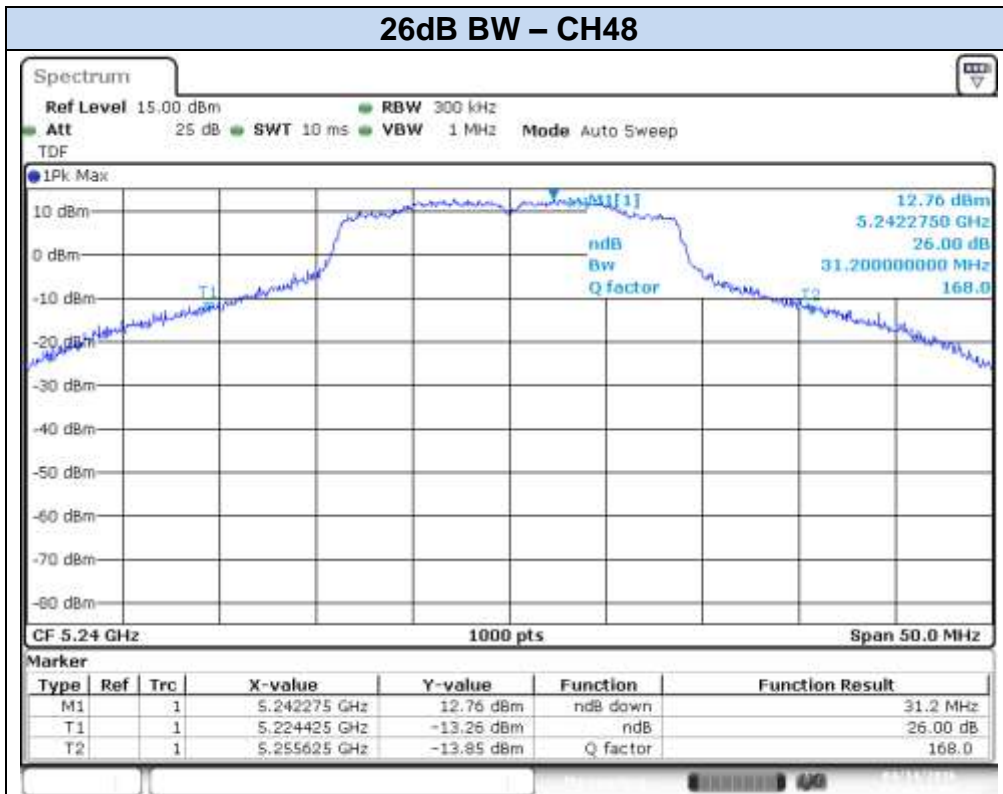

Date: 14.APR.2016 17:23:56

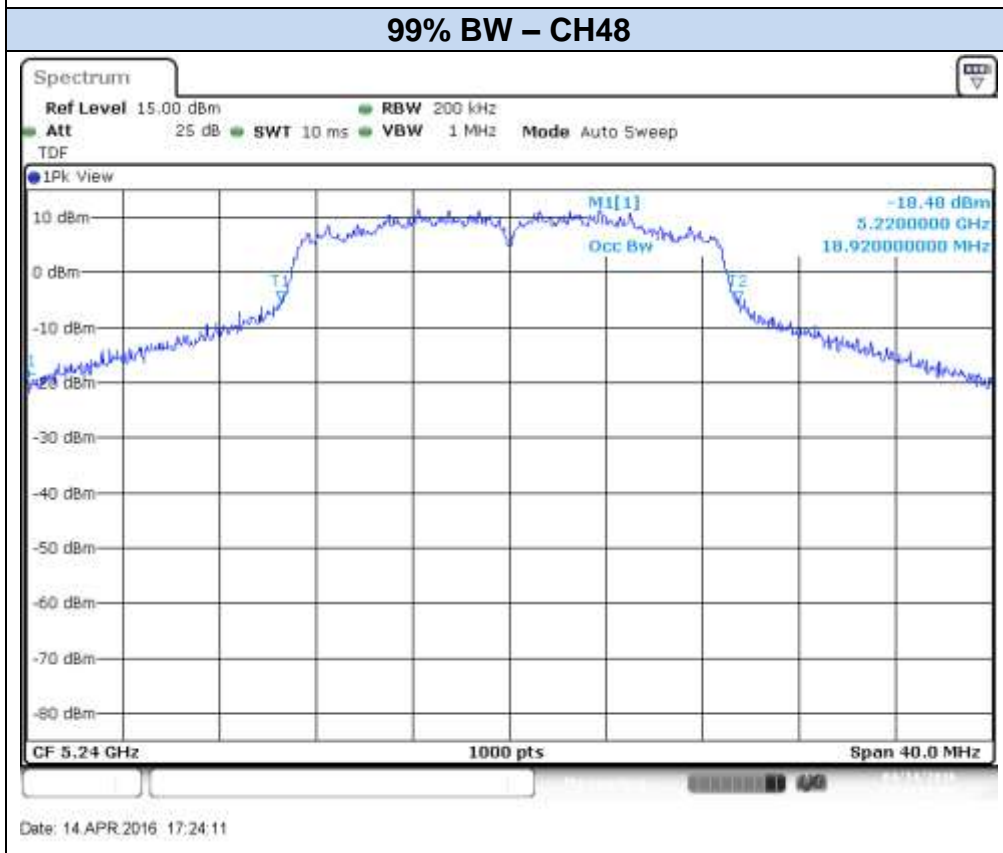

Date: 14.APR.2016 17:24:11

**802.11n20, HT0 – SISO - Chain B**

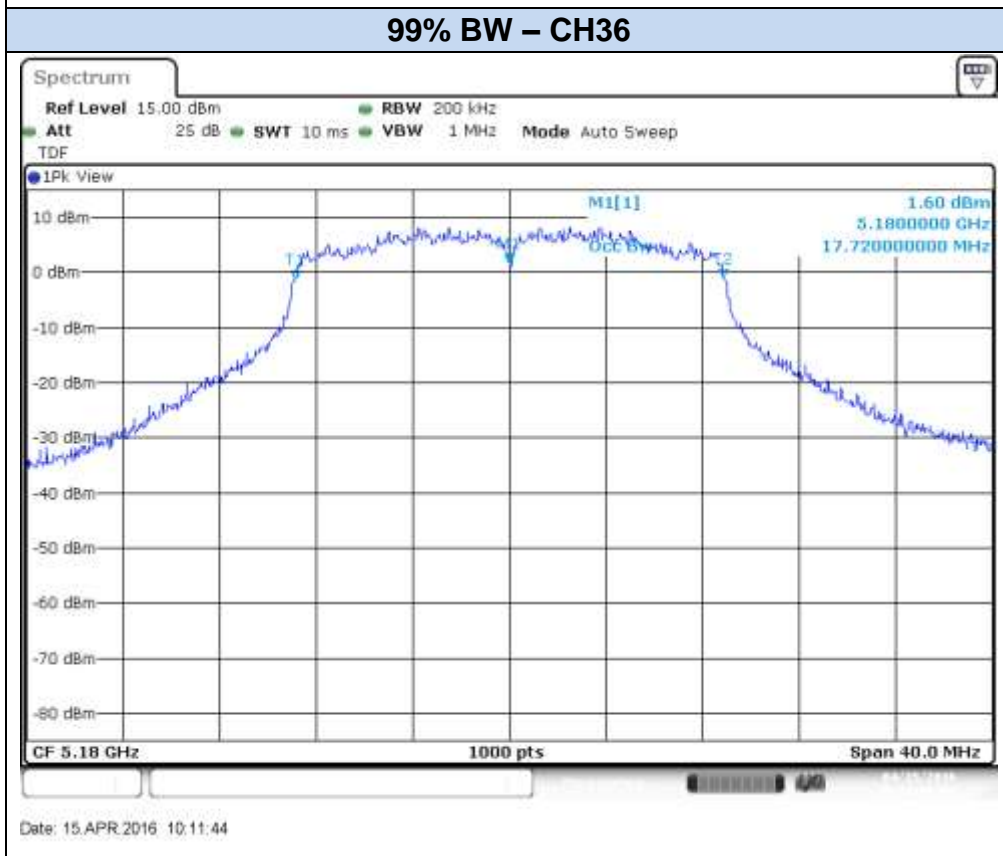
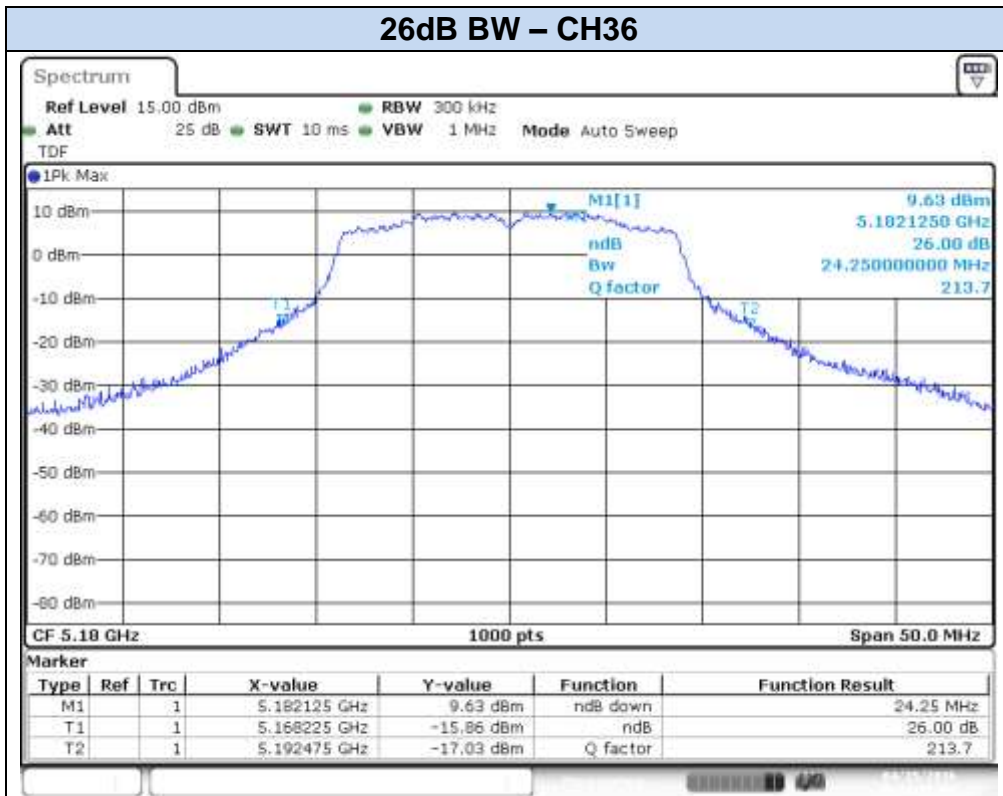

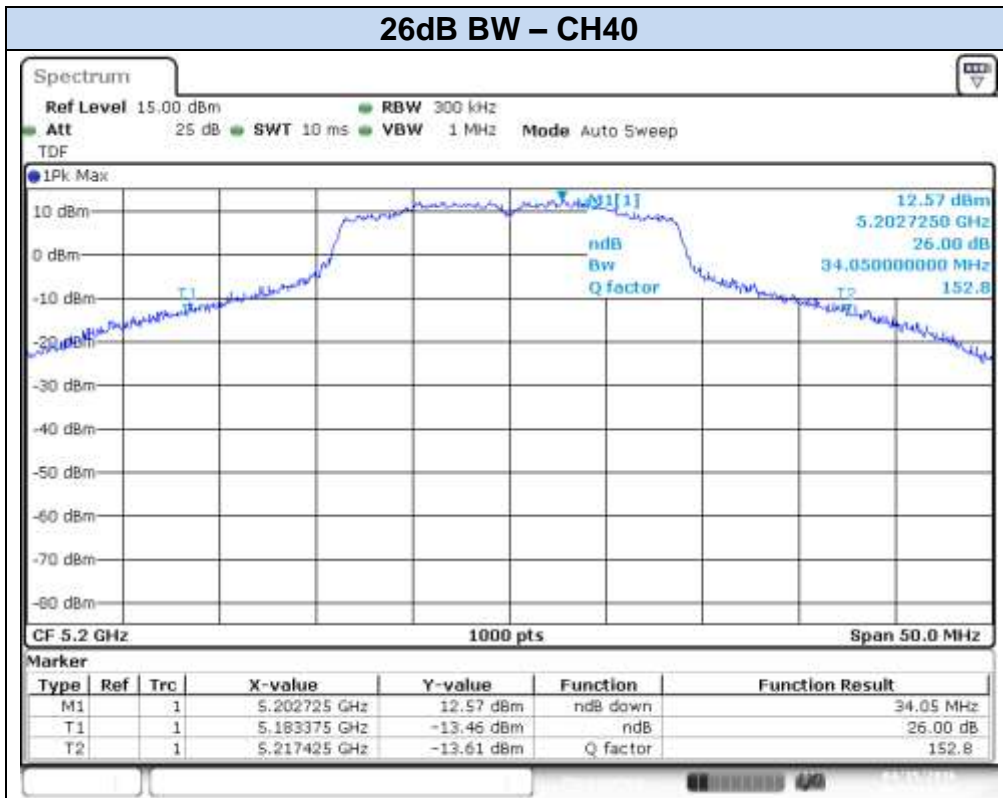

Date: 15.APR.2016 10:35:34

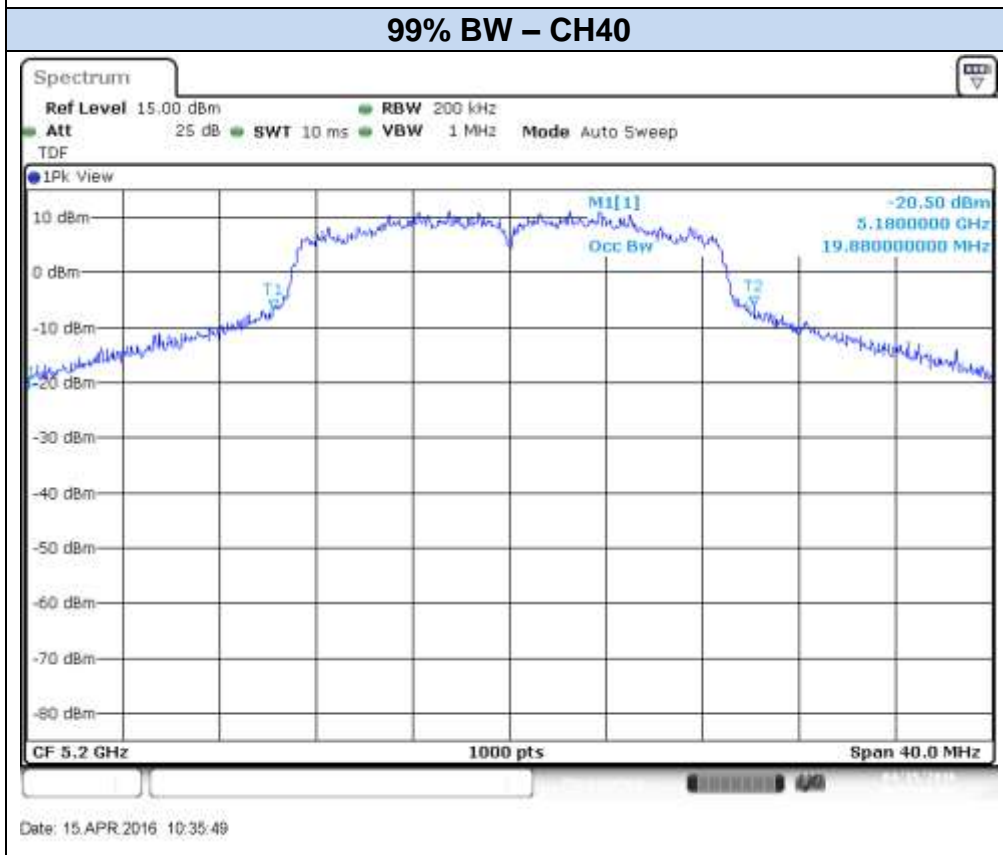

Date: 15.APR.2016 10:35:49



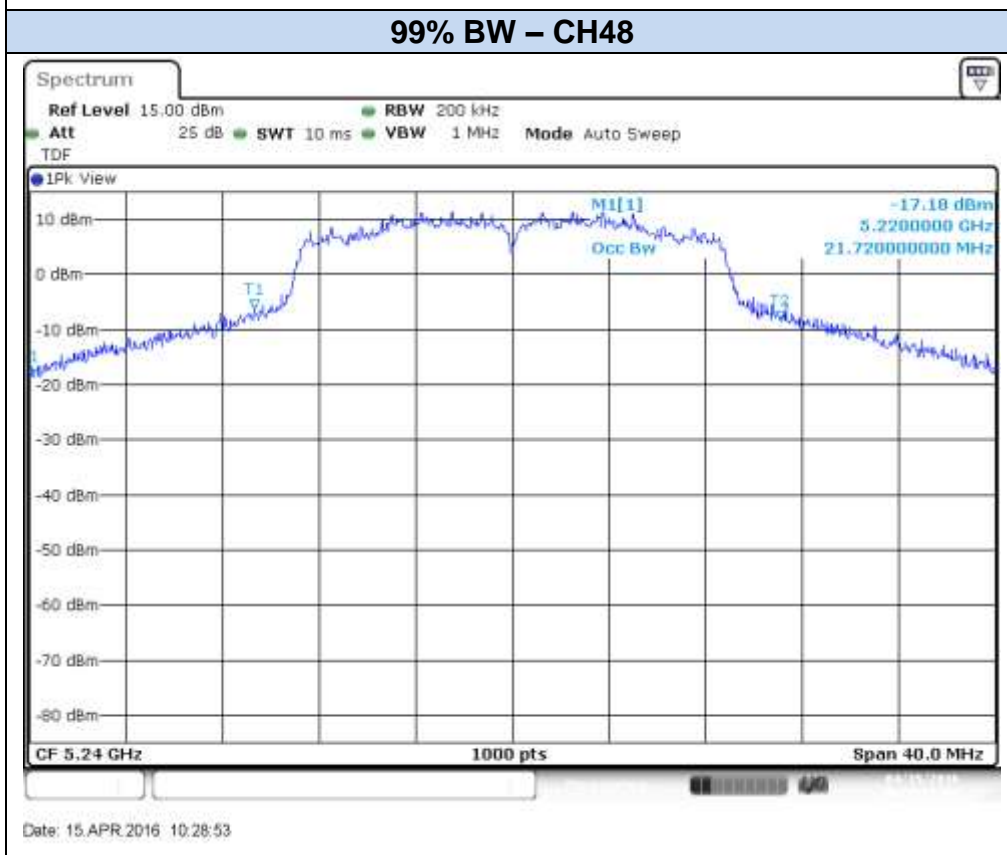
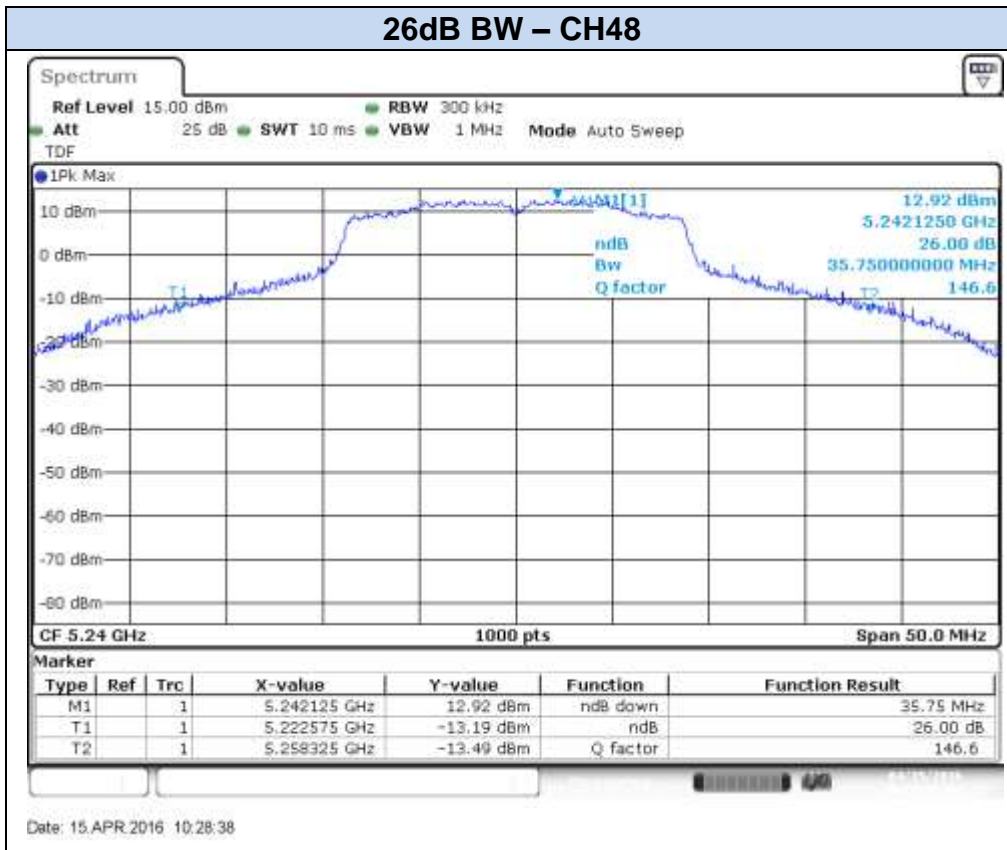

**802.11n20, HT0 – MIMO - Chain A**

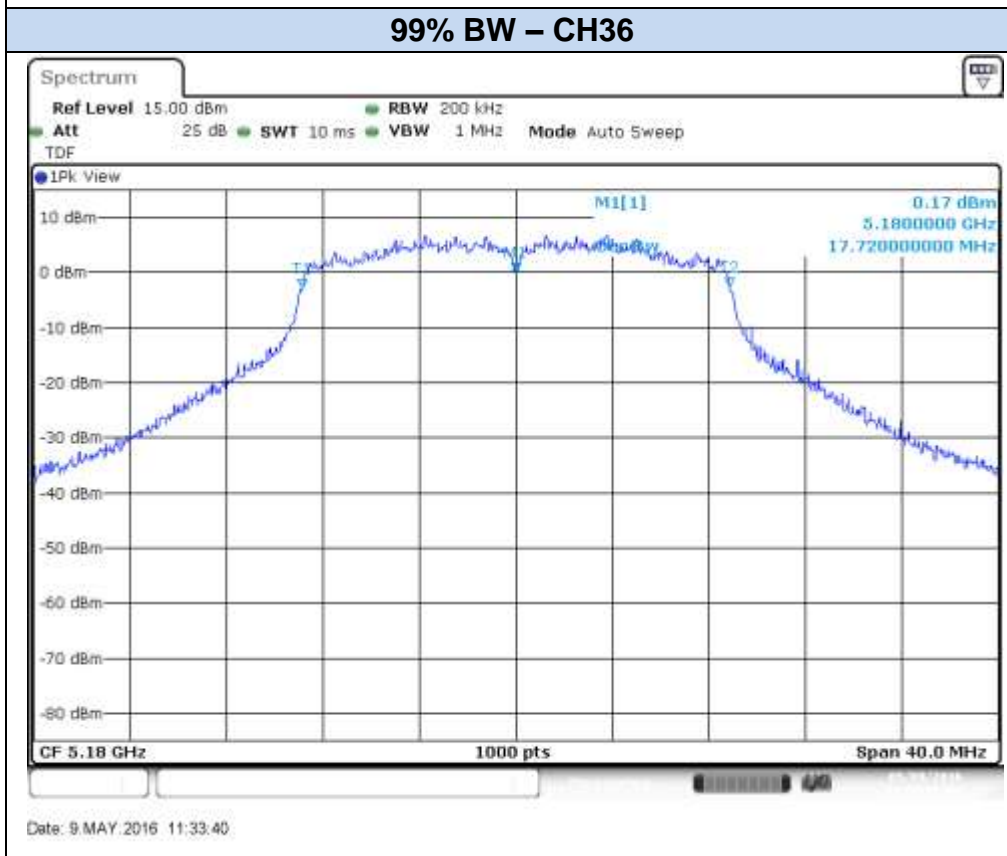
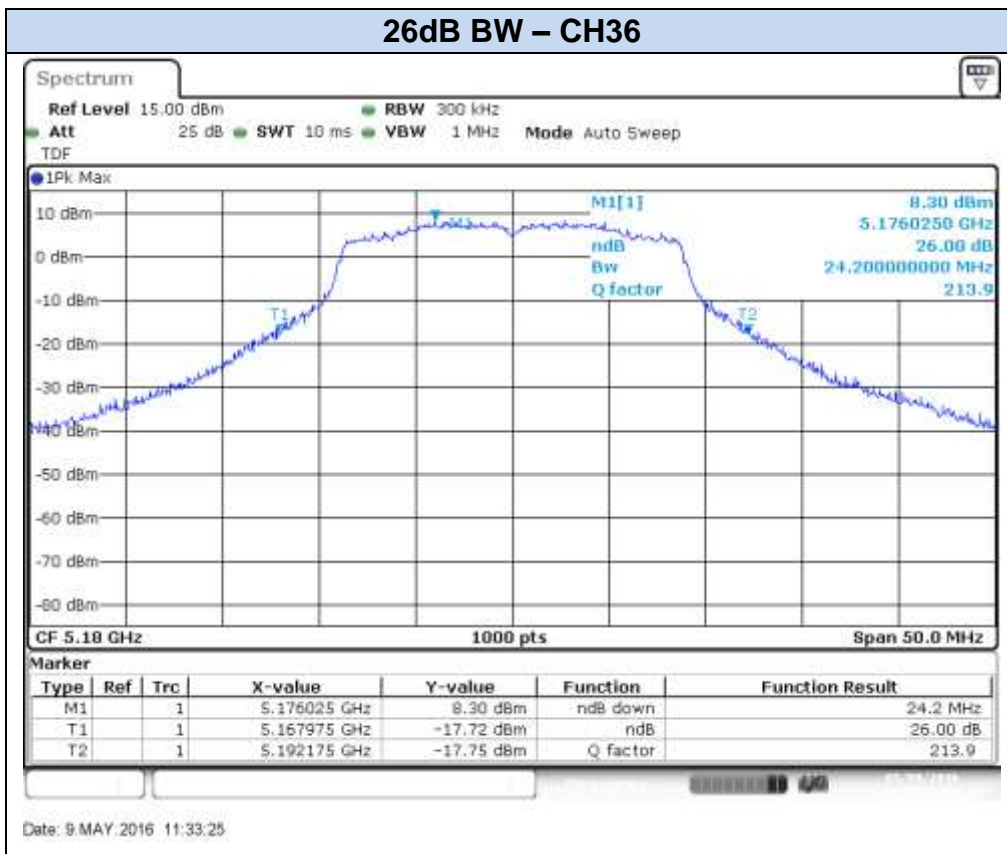

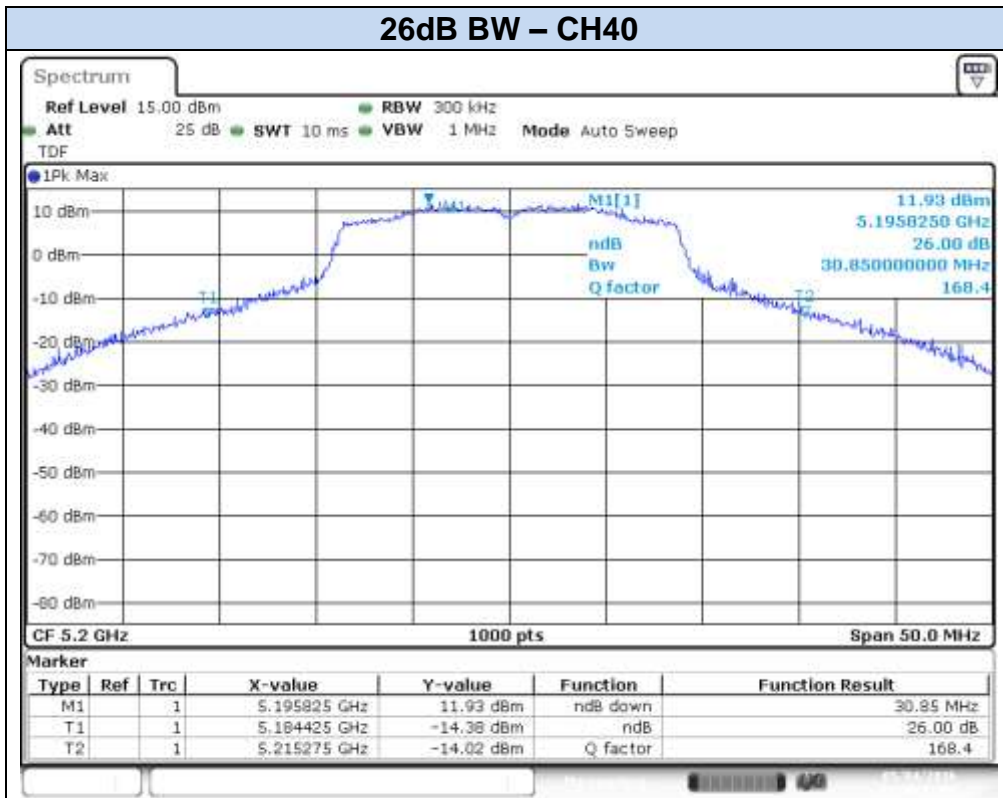

Date: 4.MAY.2016 14:36:43

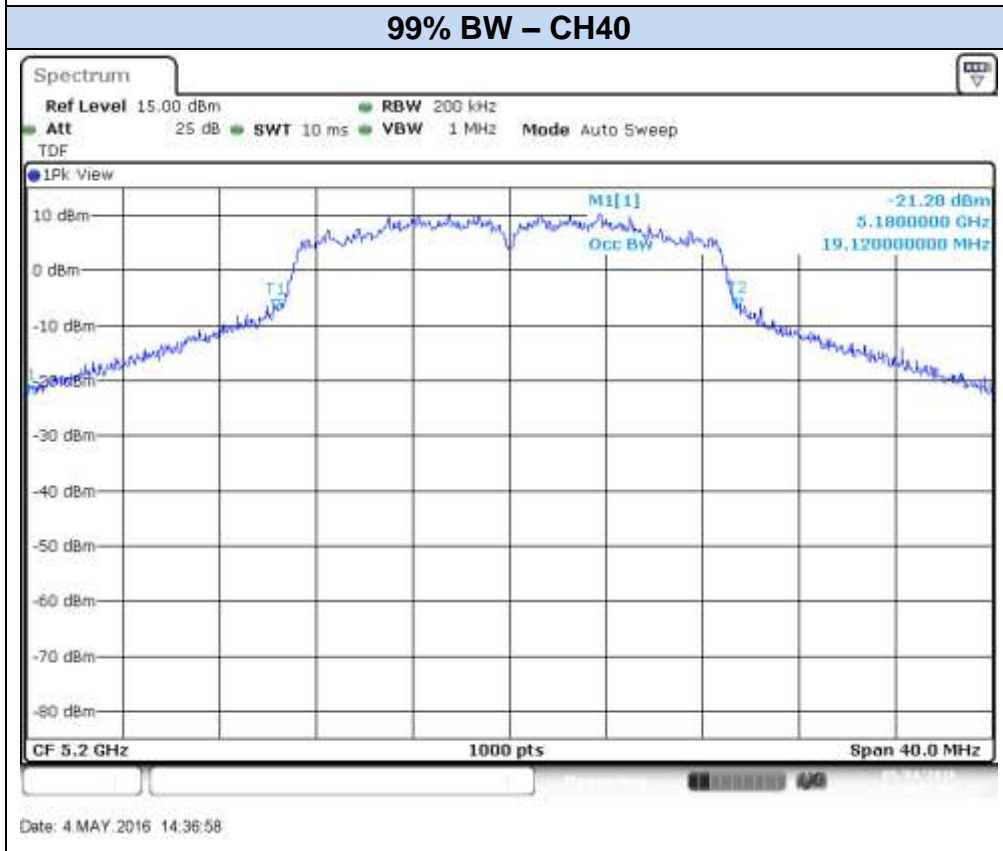

Date: 4.MAY.2016 14:36:58

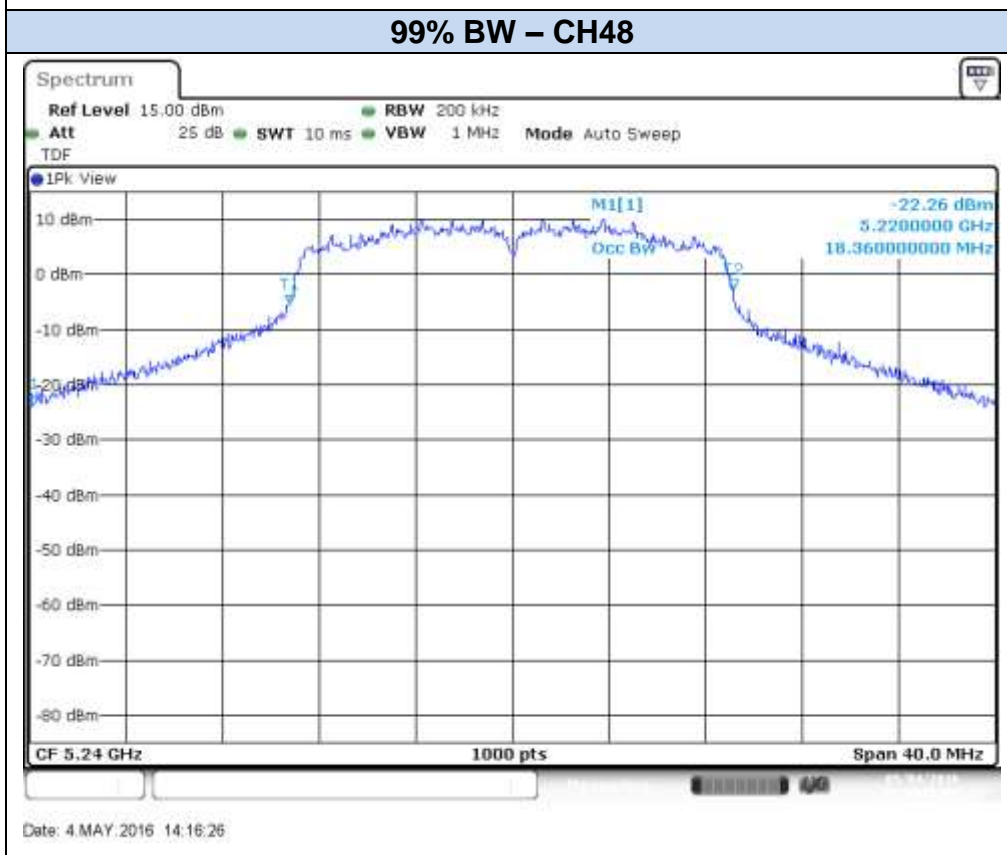
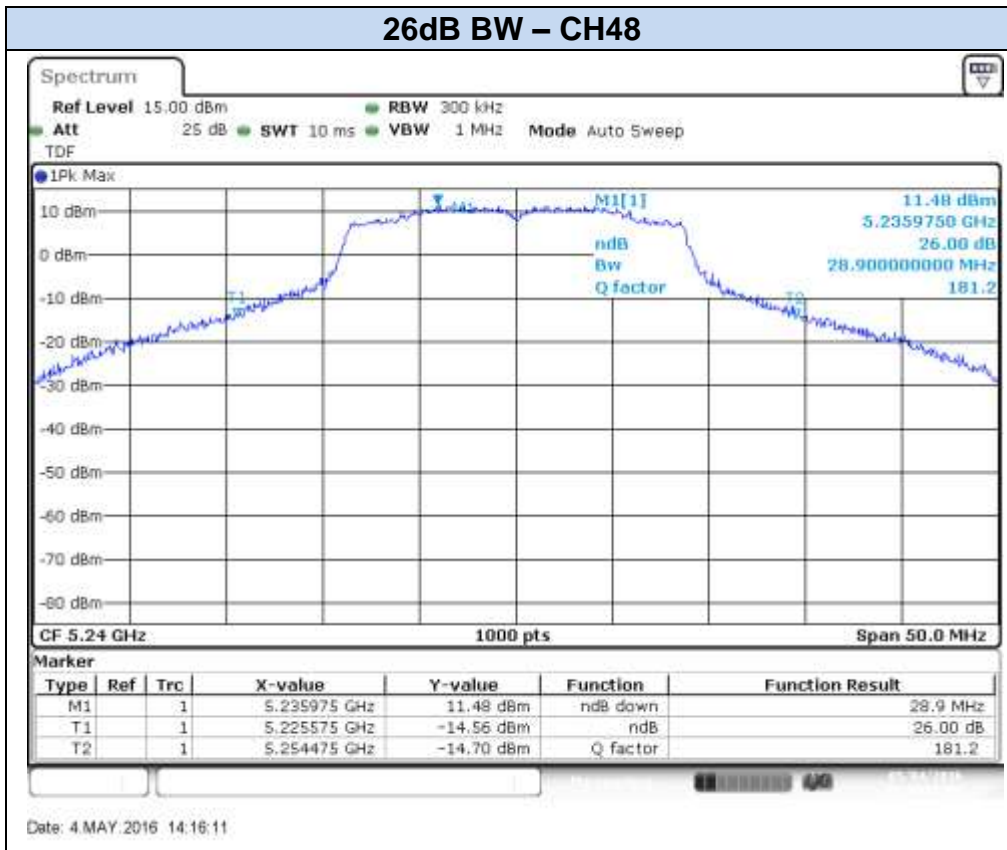

**802.11n20, HT0 – MIMO - Chain B**

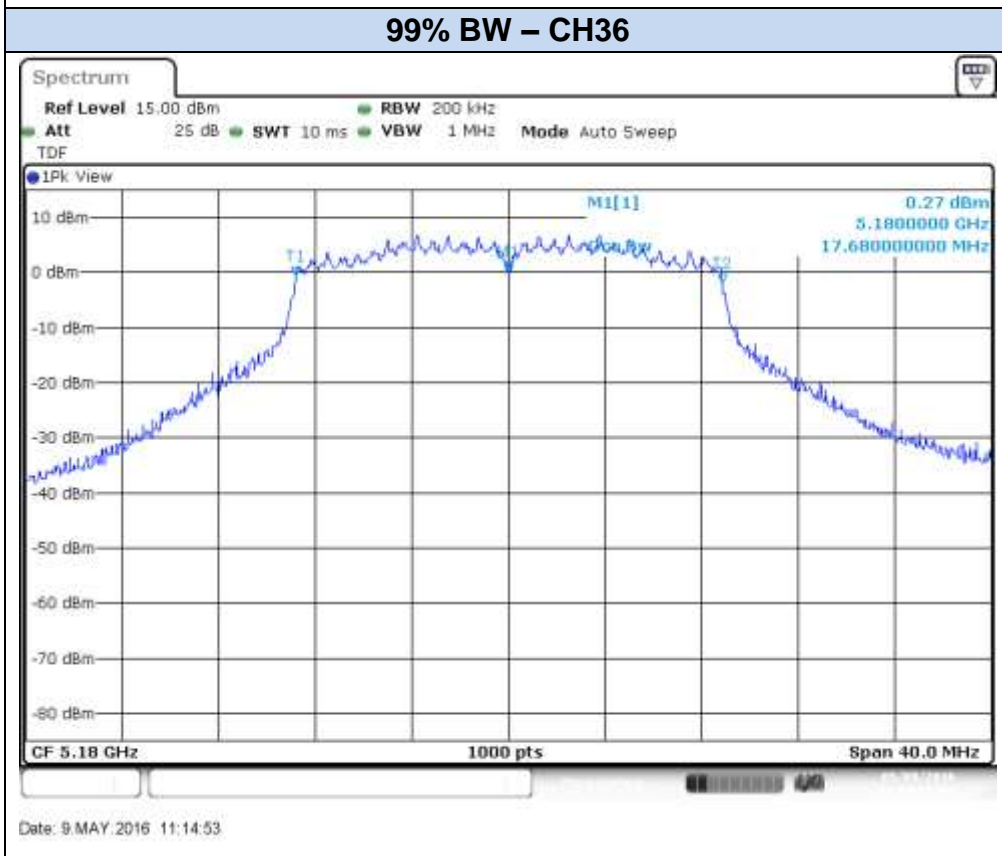
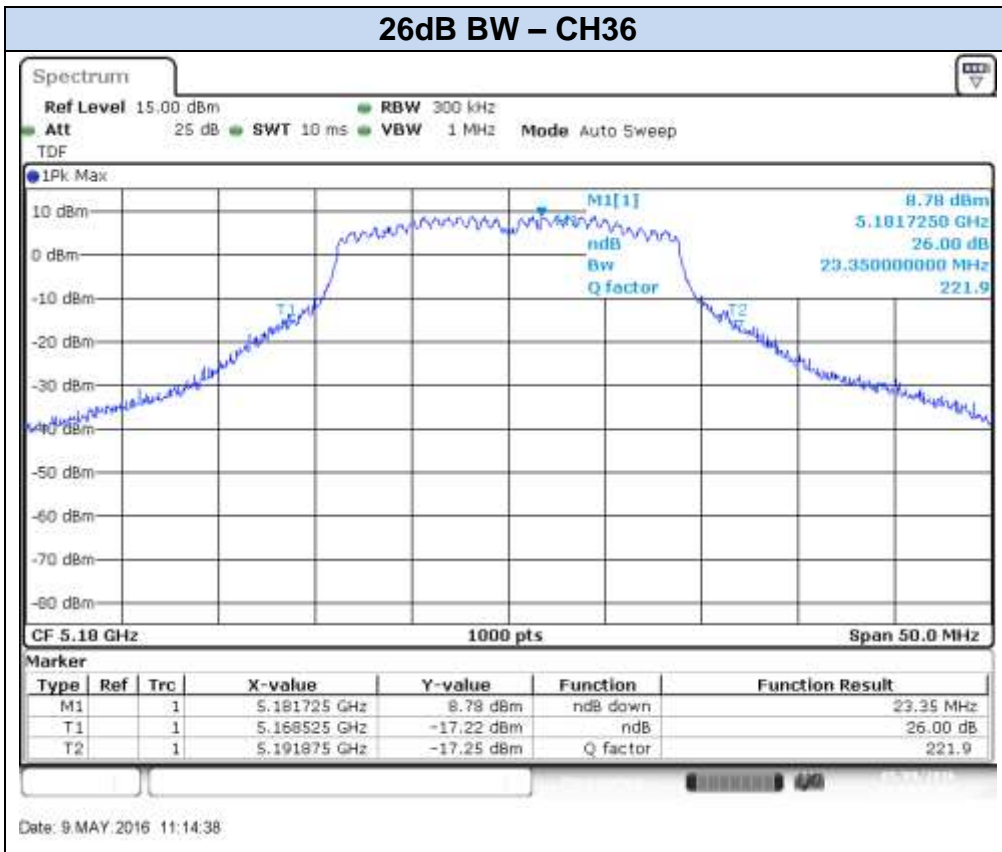

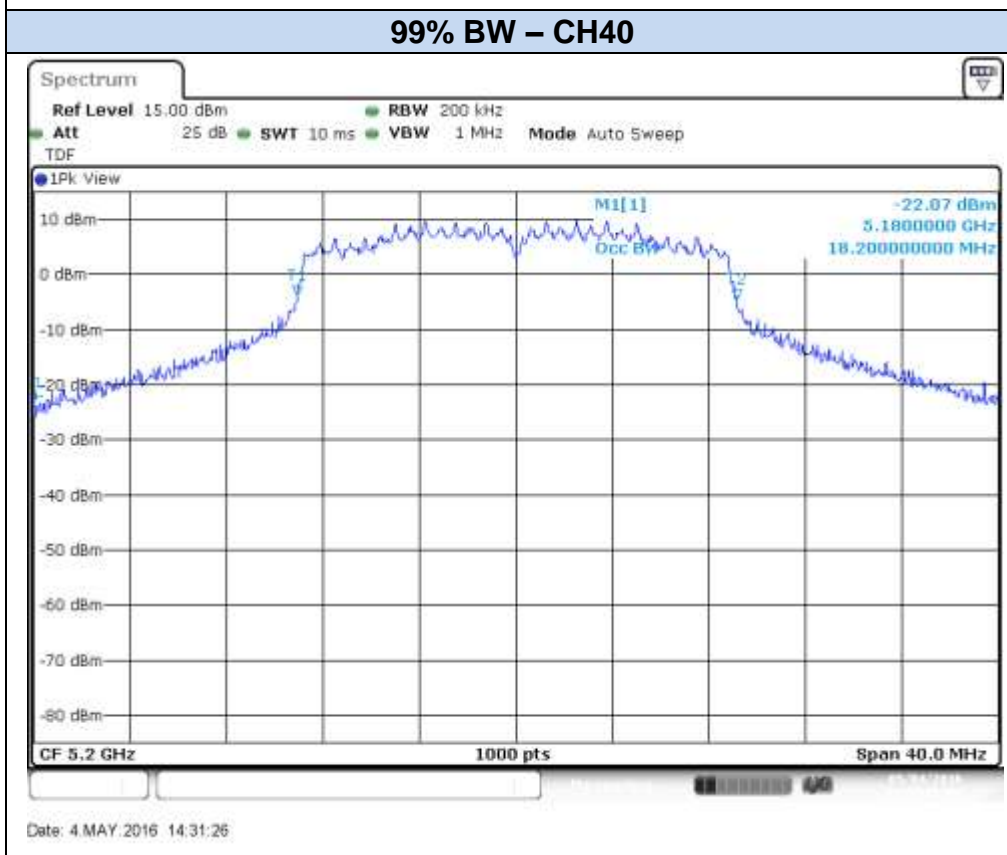
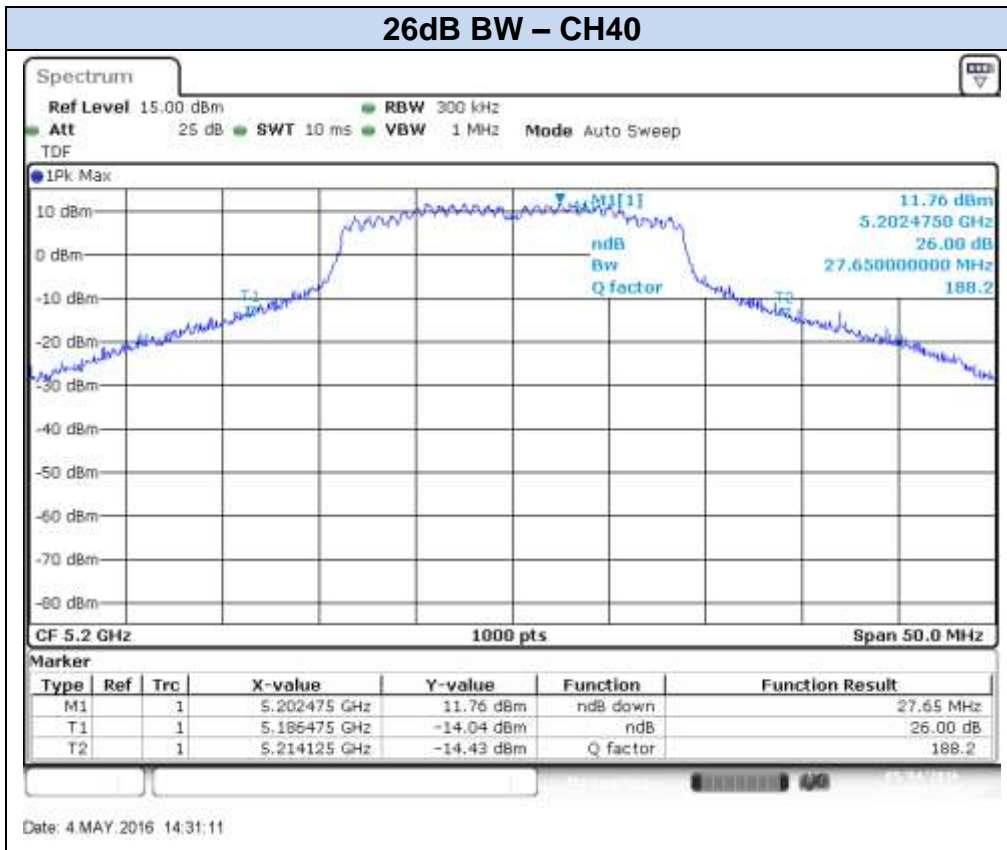

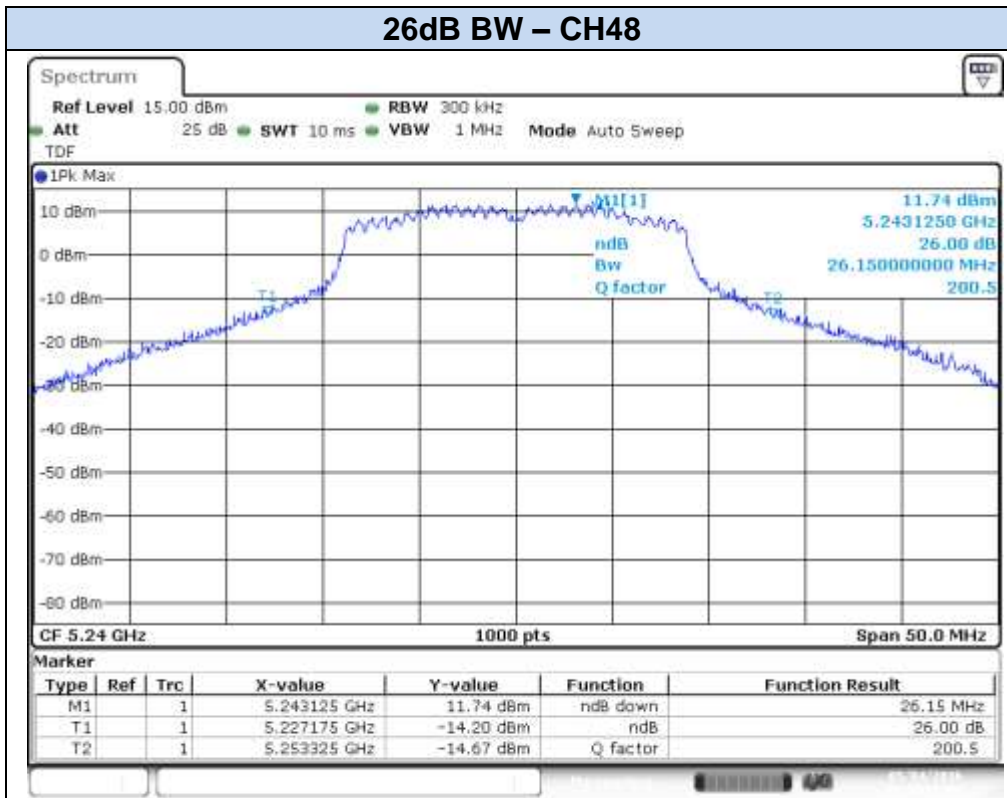

Date: 4.MAY.2016 14:18:53

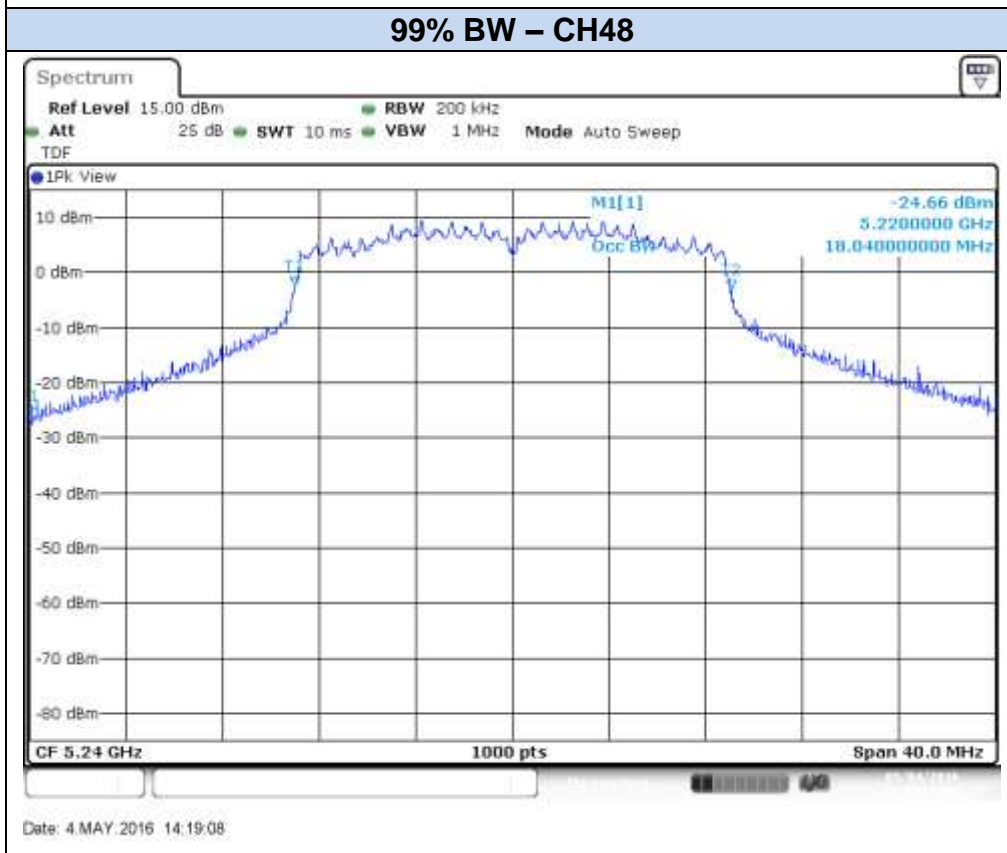

Date: 4.MAY.2016 14:19:08

## 802.11n40, HT0 – SISO - Chain A

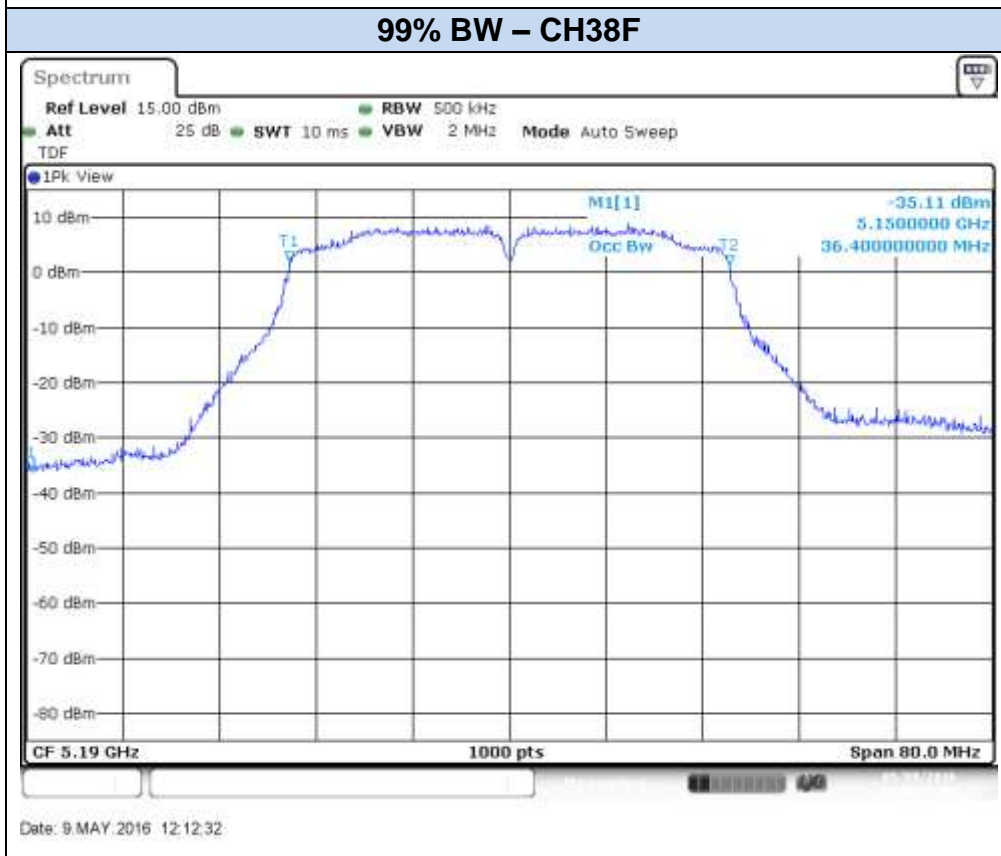
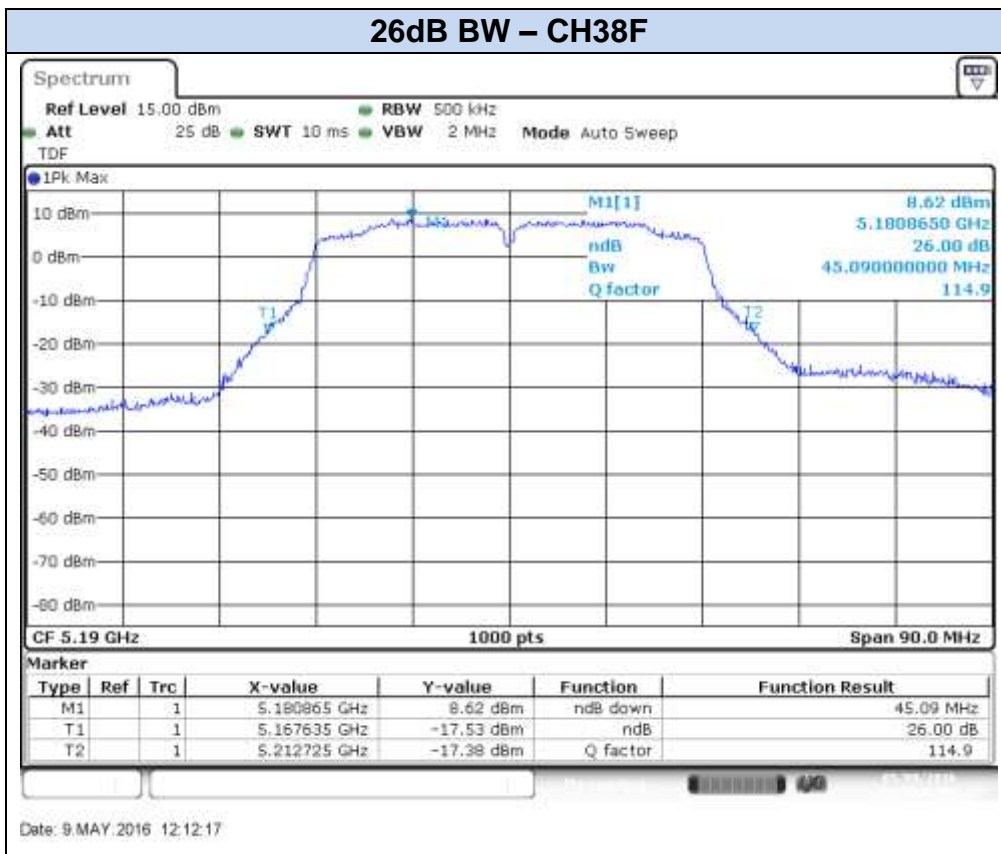



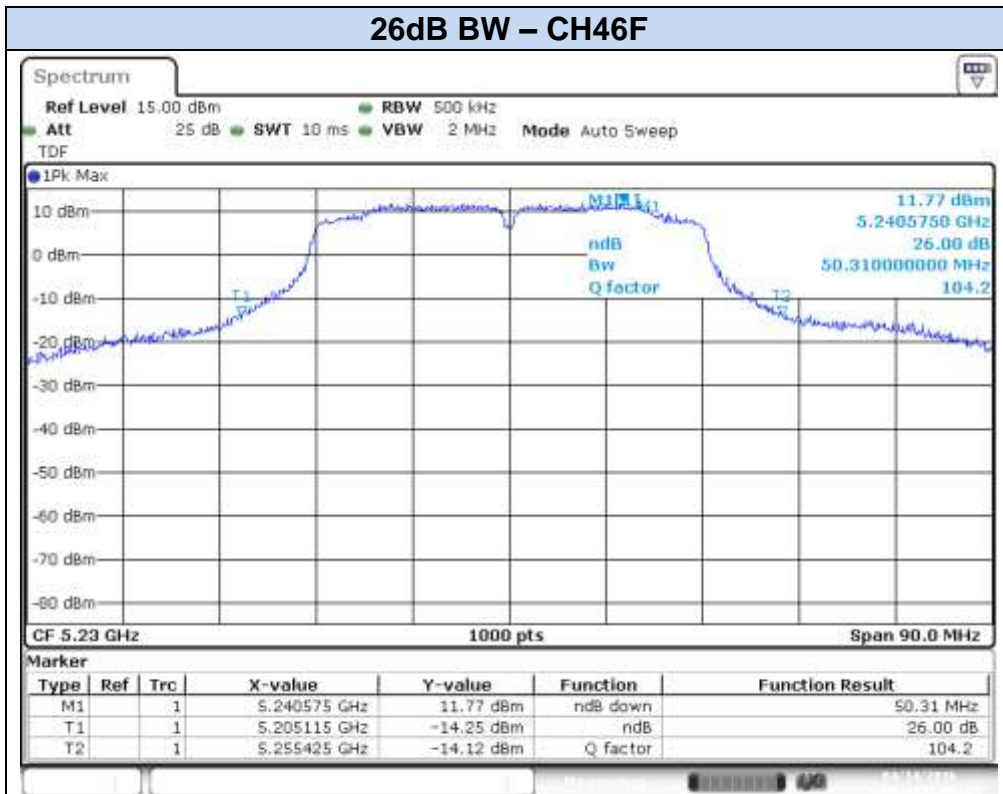

Date: 14.APR.2016 18:11:34

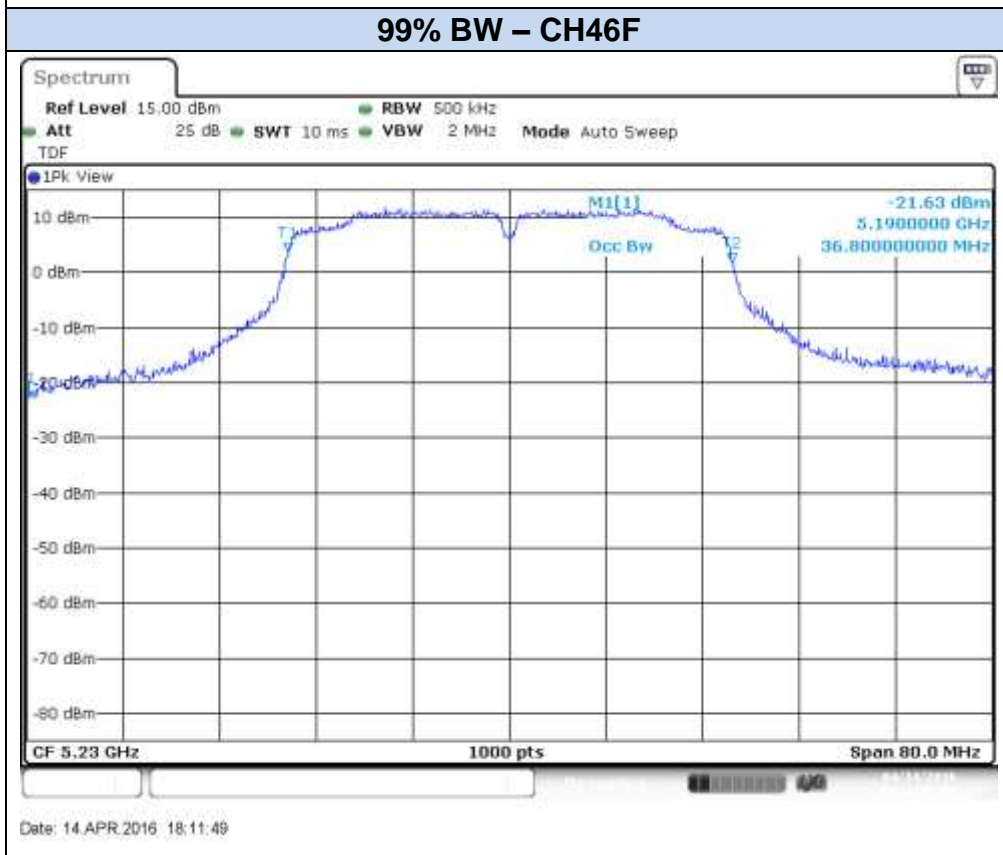

Date: 14.APR.2016 18:11:49

**802.11n40, HT0 – SISO - Chain B**

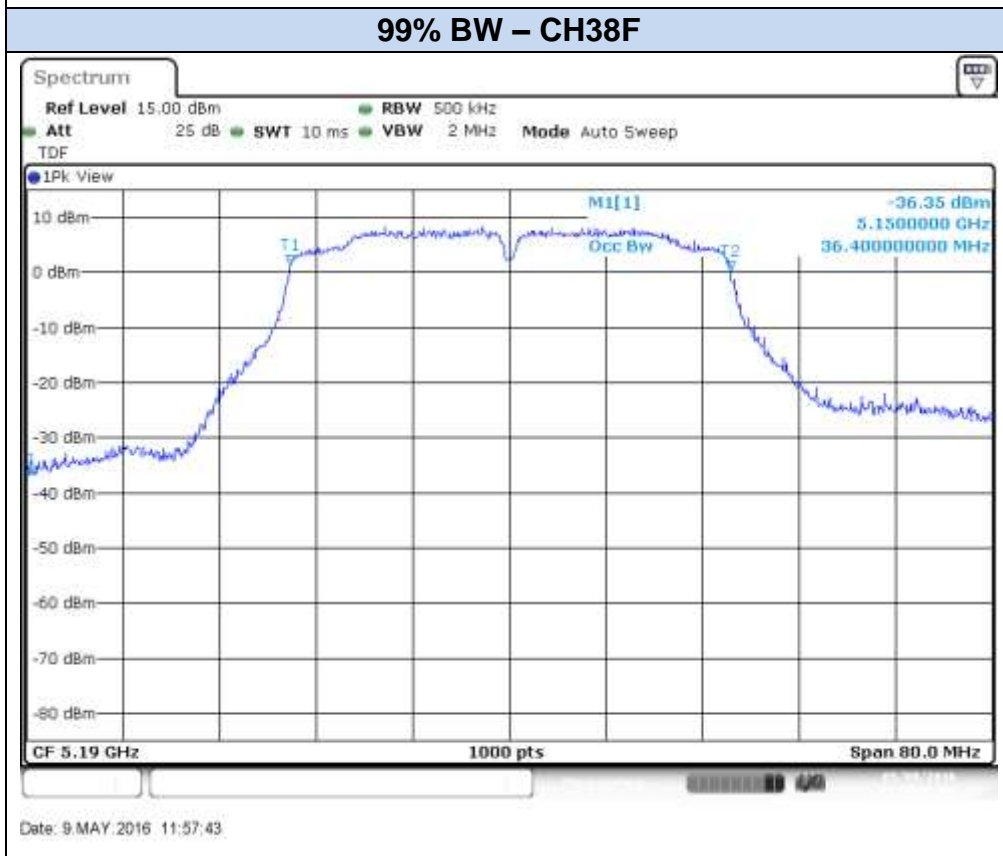
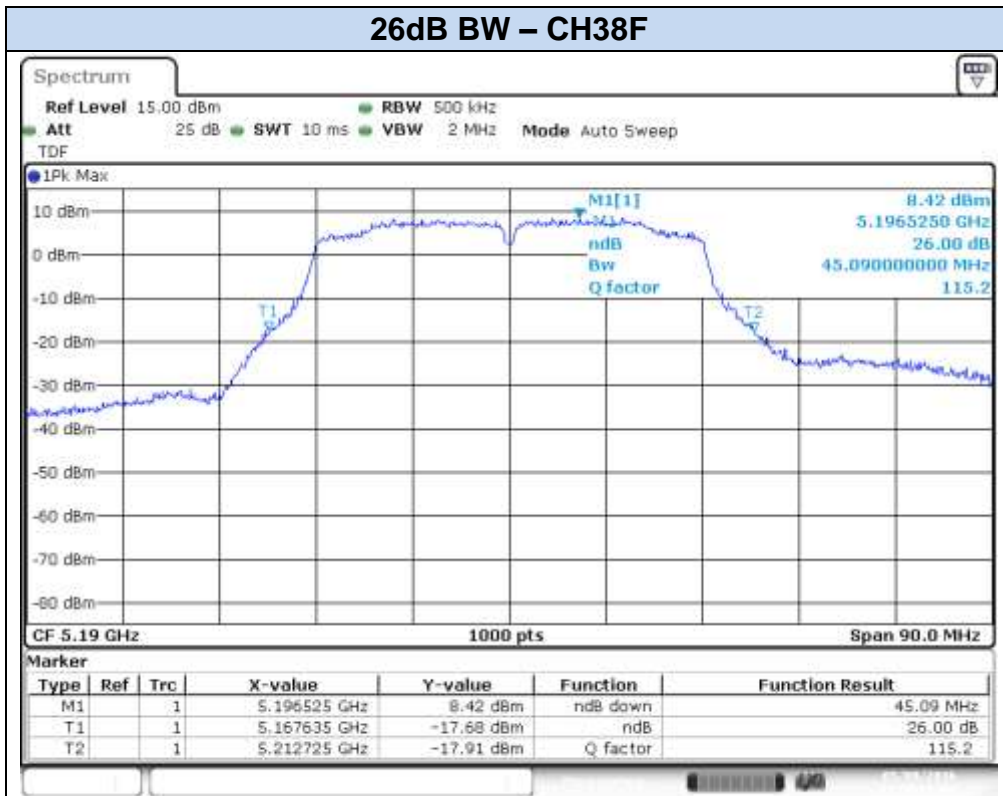

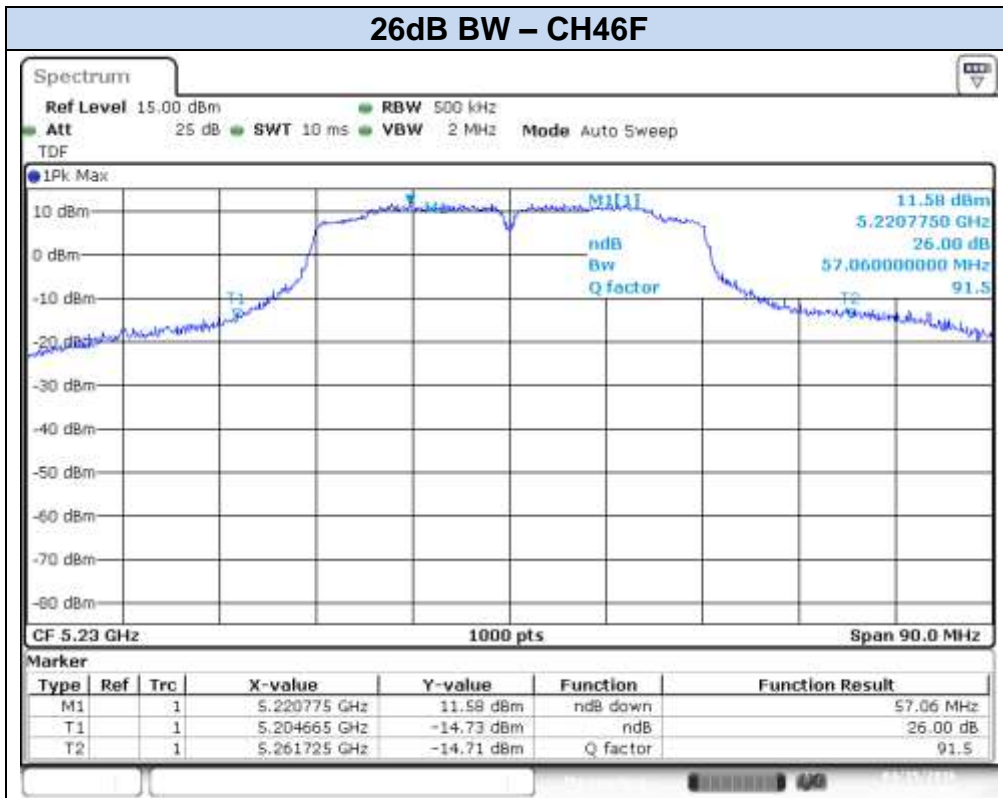

Date: 15.APR.2016 14:48:12

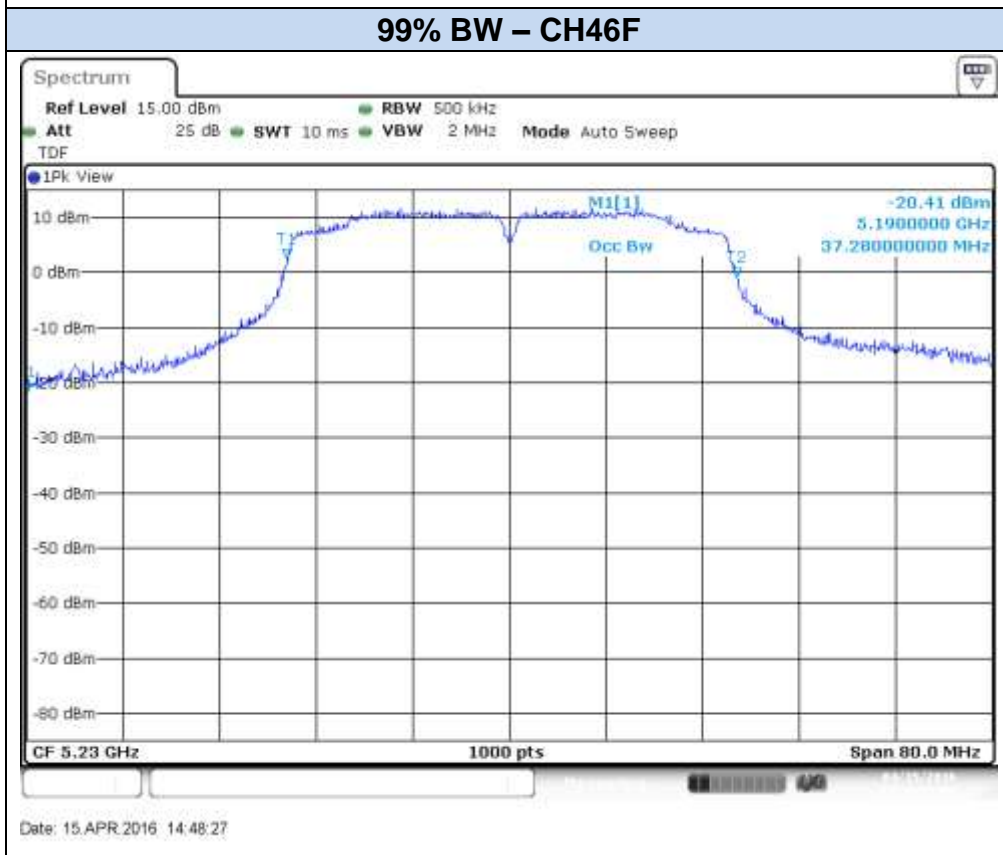

Date: 15.APR.2016 14:48:27

**802.11n40, HT0 – MIMO - Chain A**

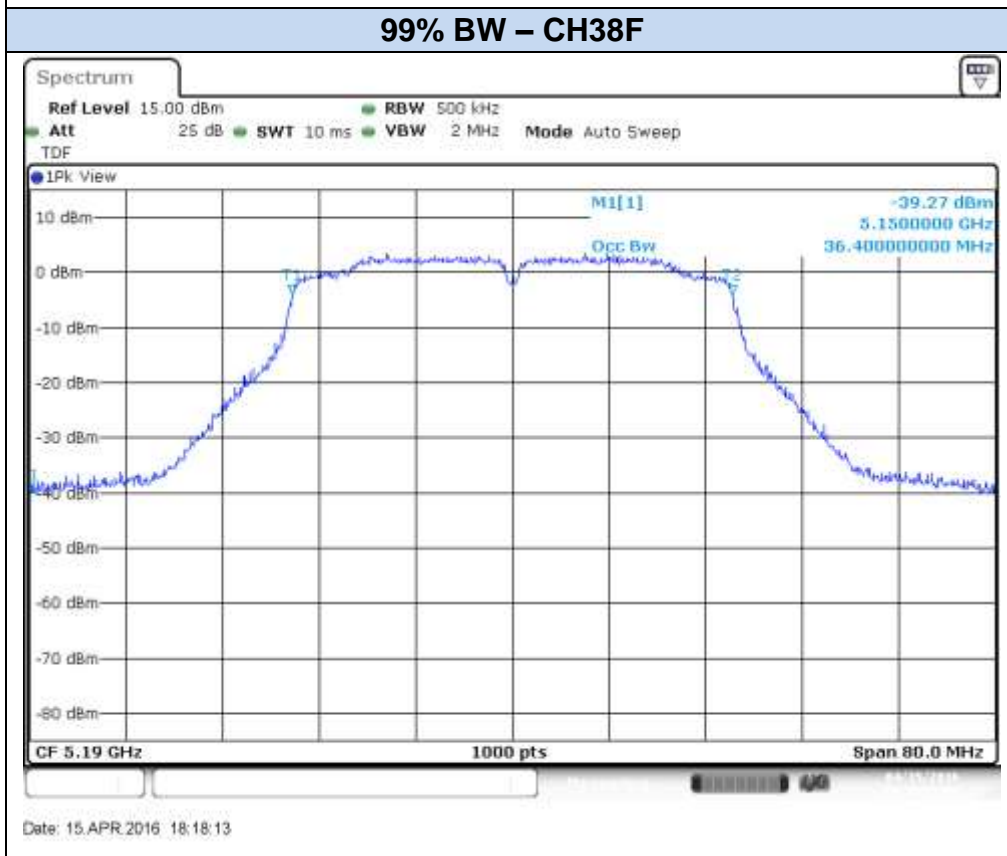
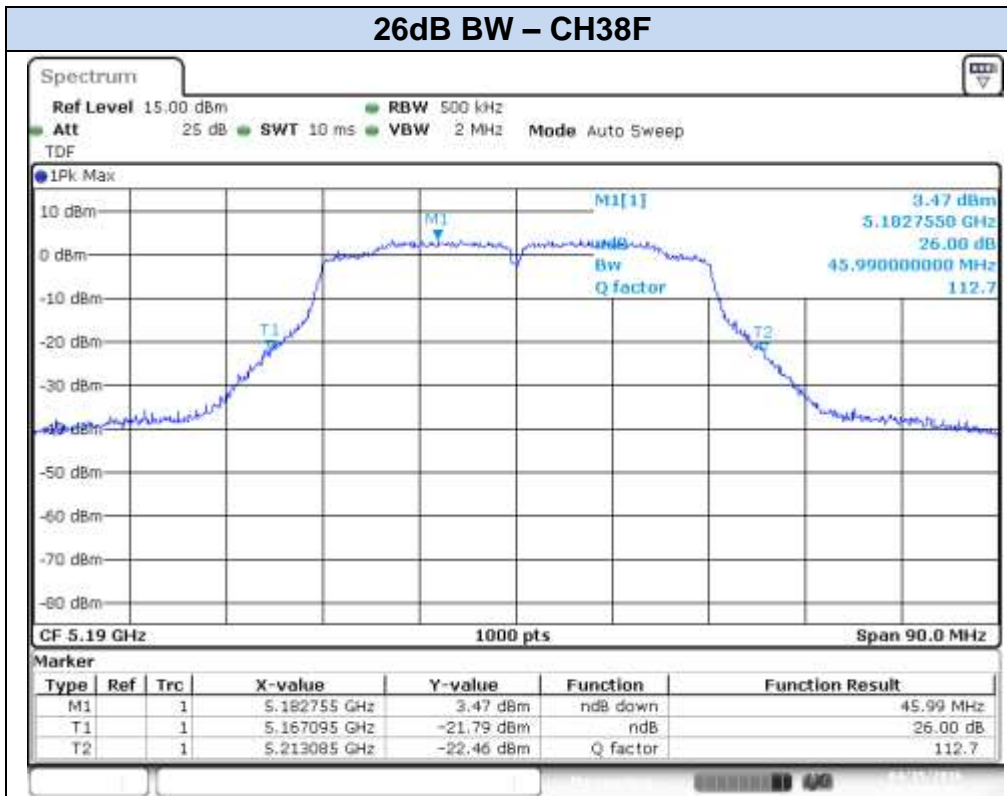

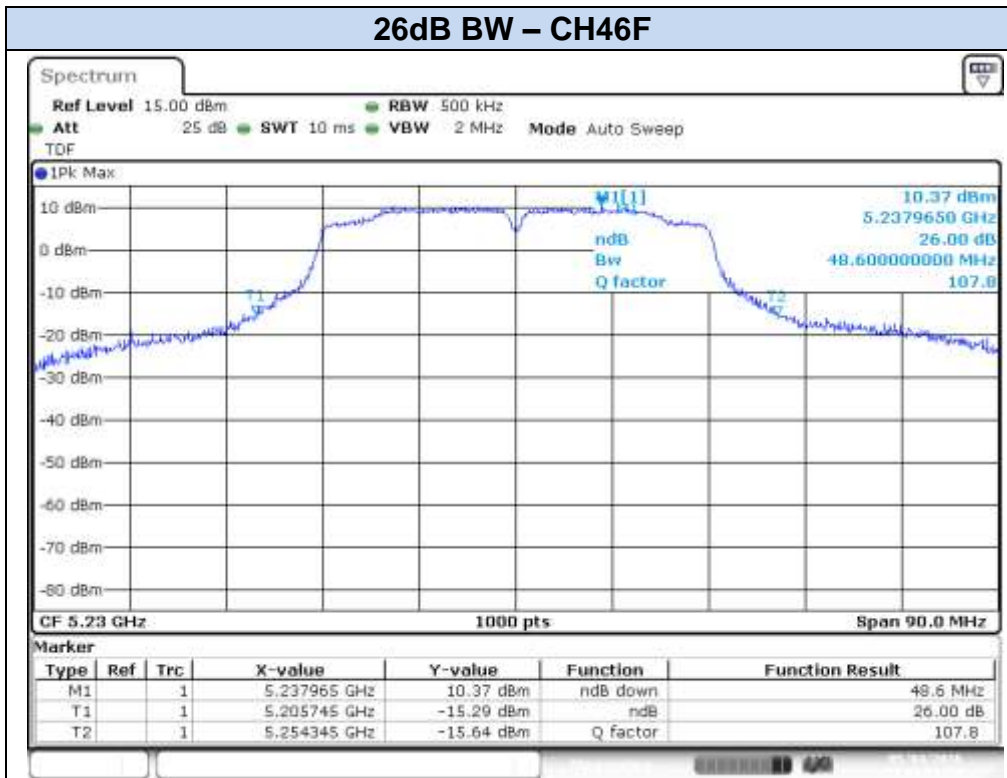

Date: 4.MAY.2016 15:03:21

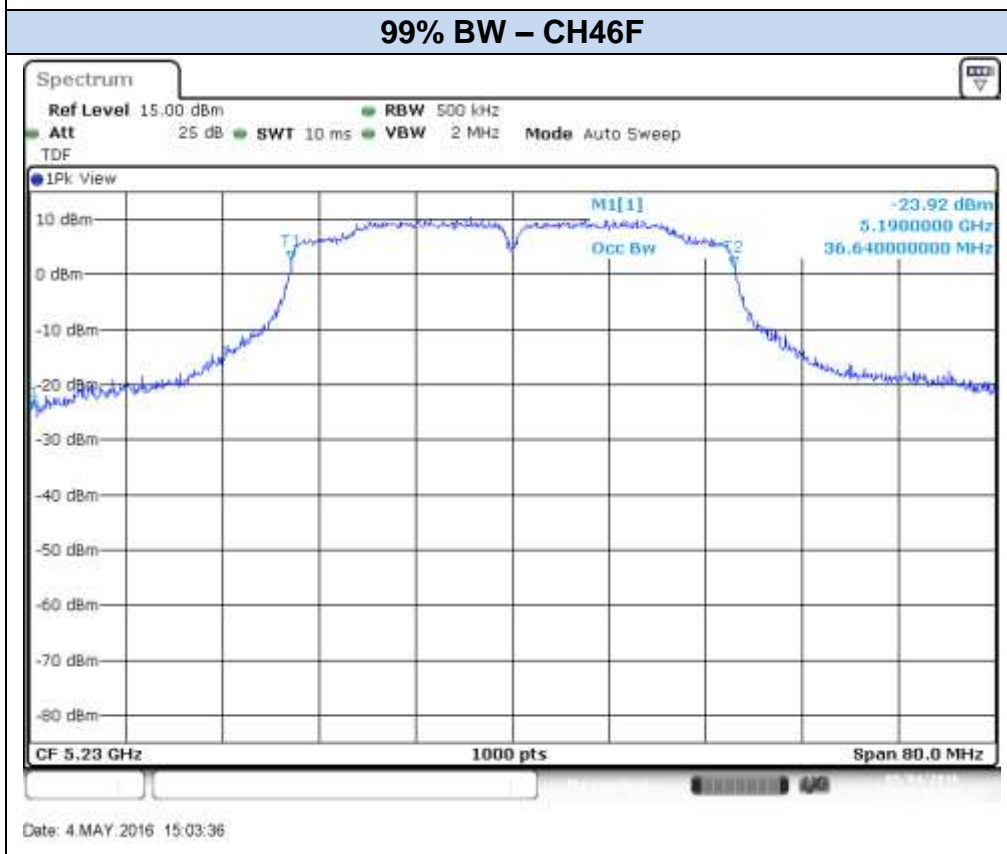

Date: 4.MAY.2016 15:03:36

**802.11n40, HT0 – MIMO - Chain B**

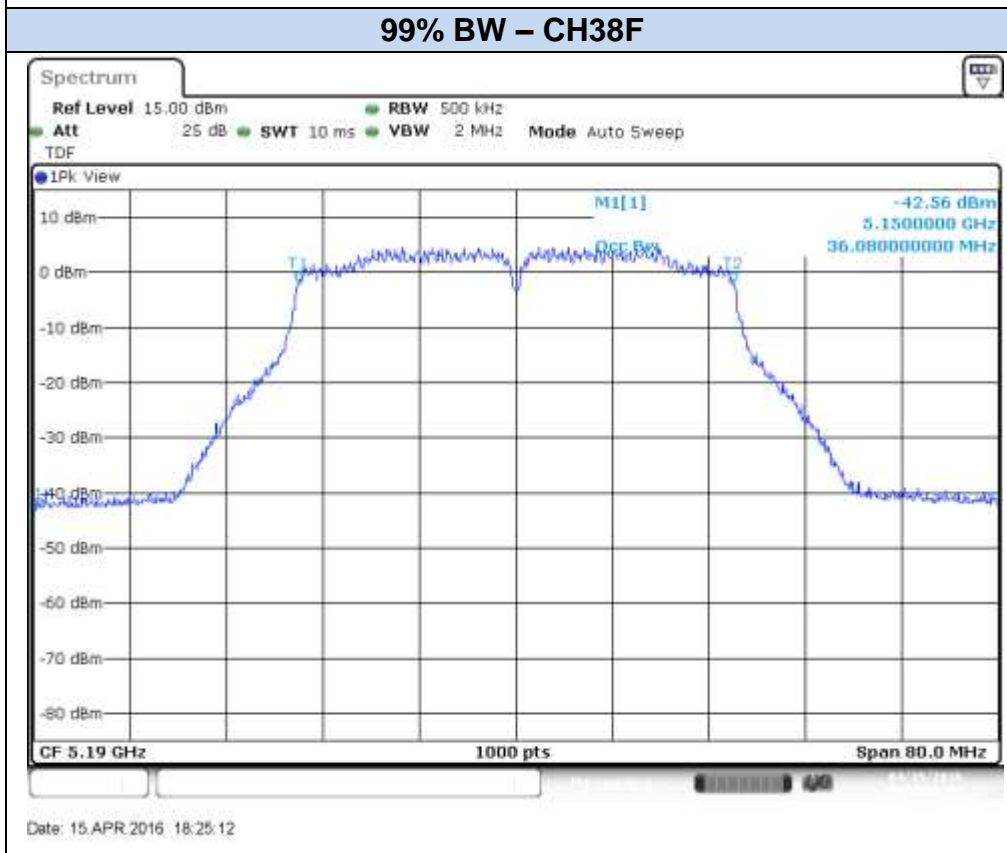
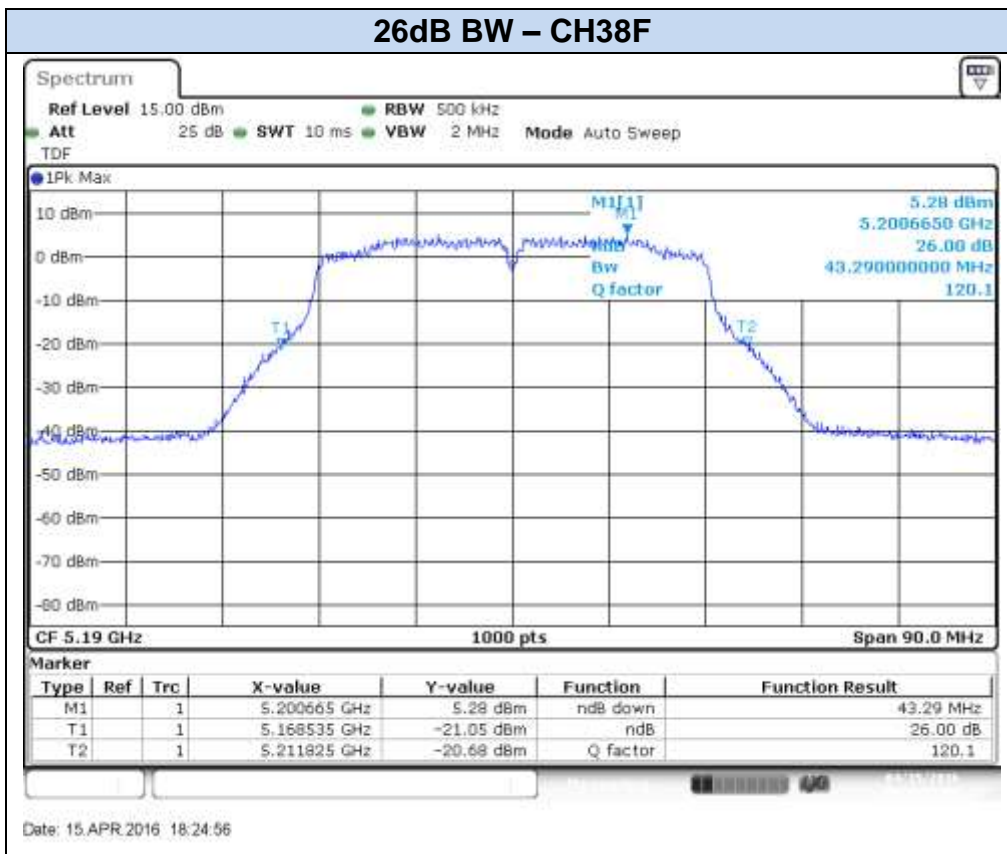

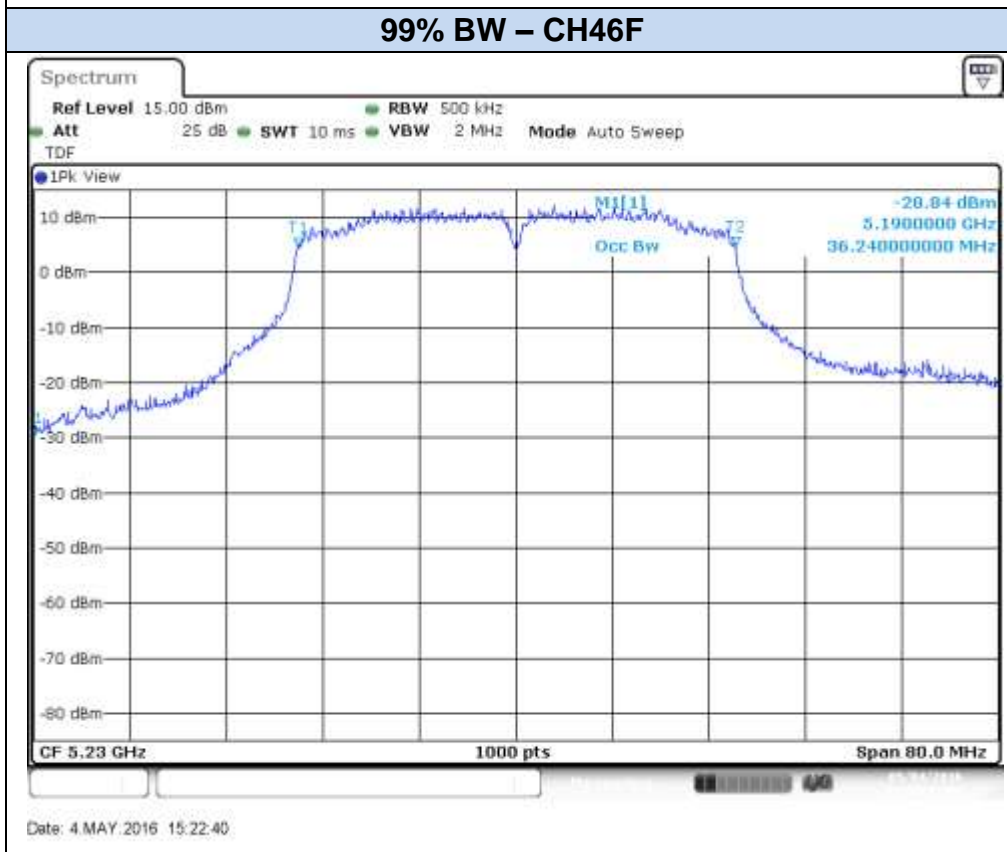
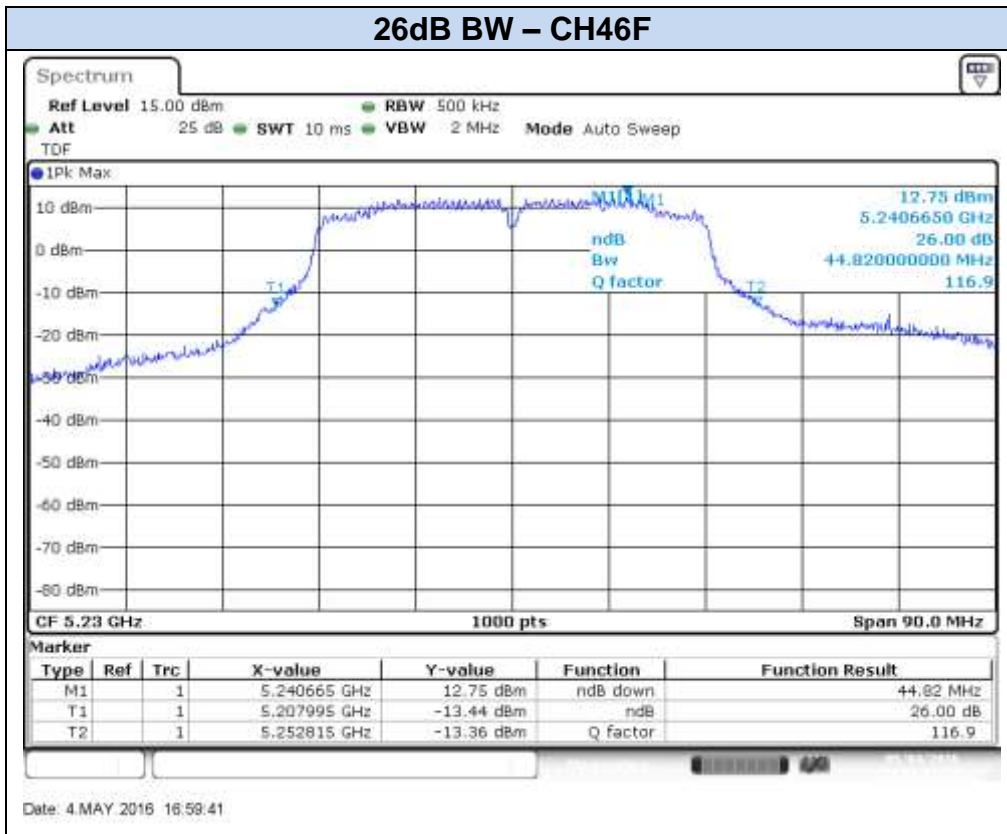

**802.11ac80, VHT0 – SISO - Chain A**

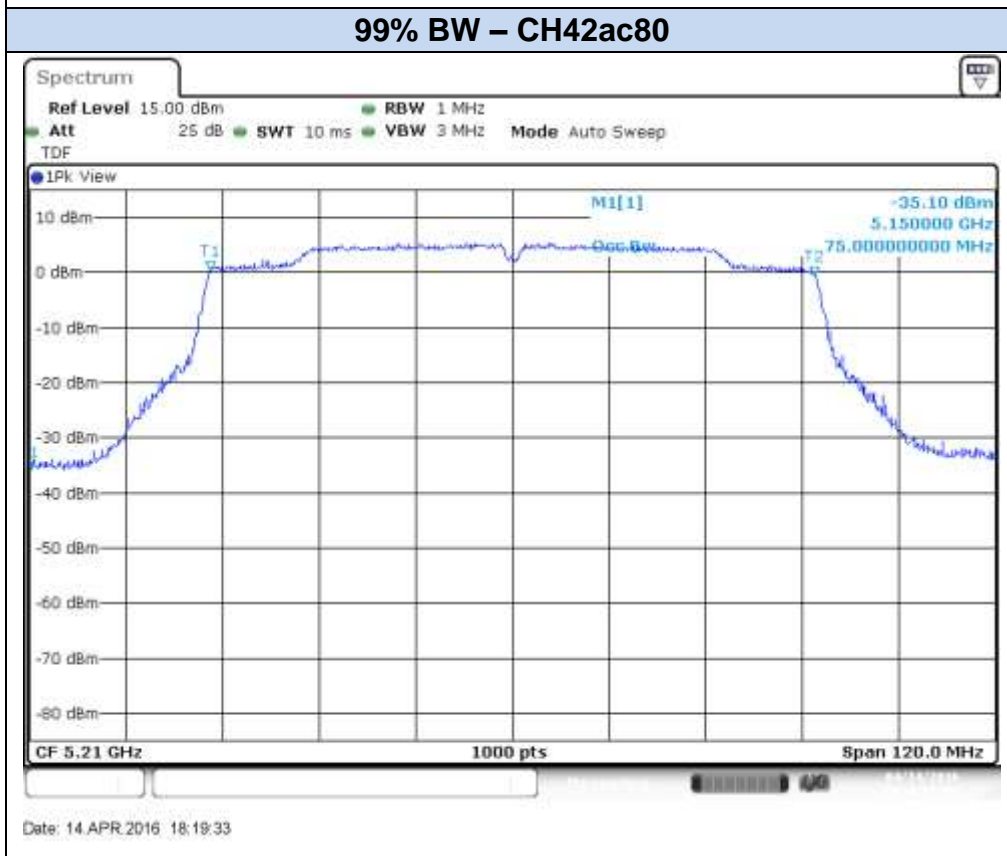
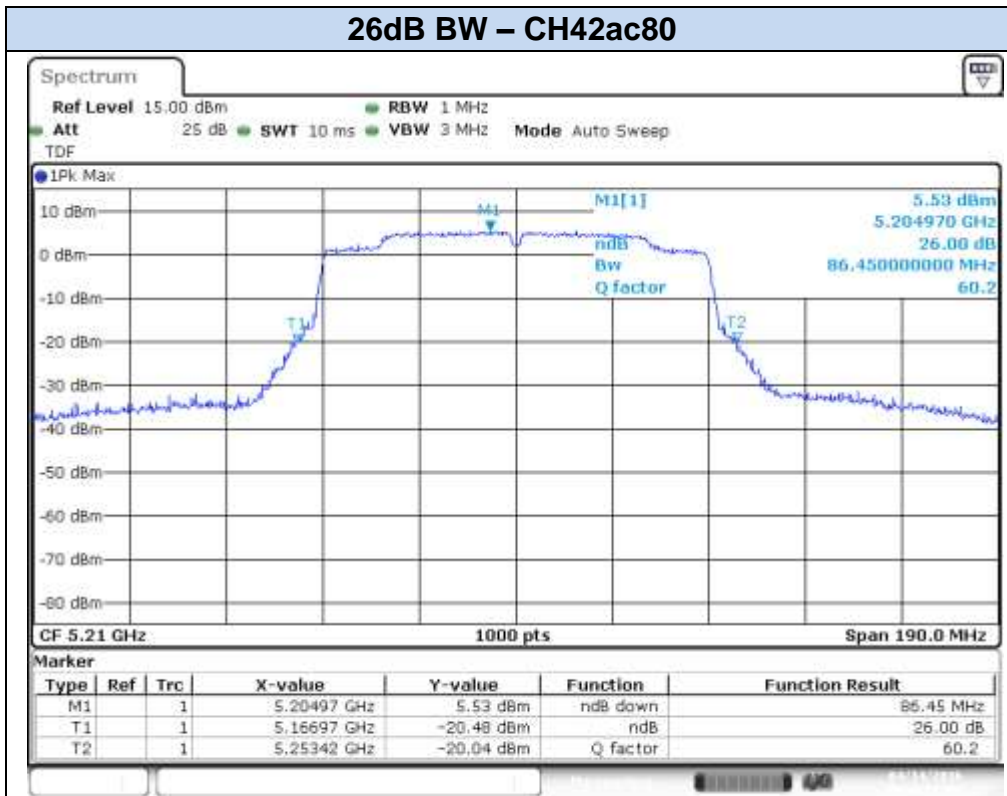



**802.11ac80, VHT0 – SISO - Chain B**

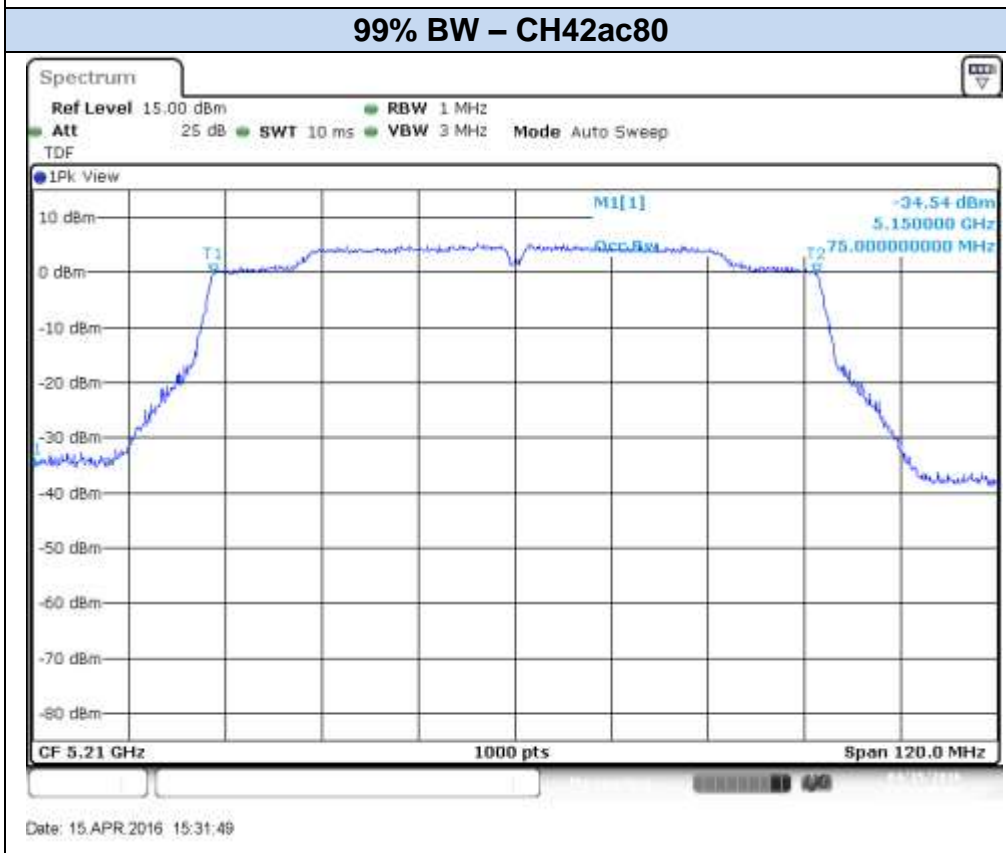
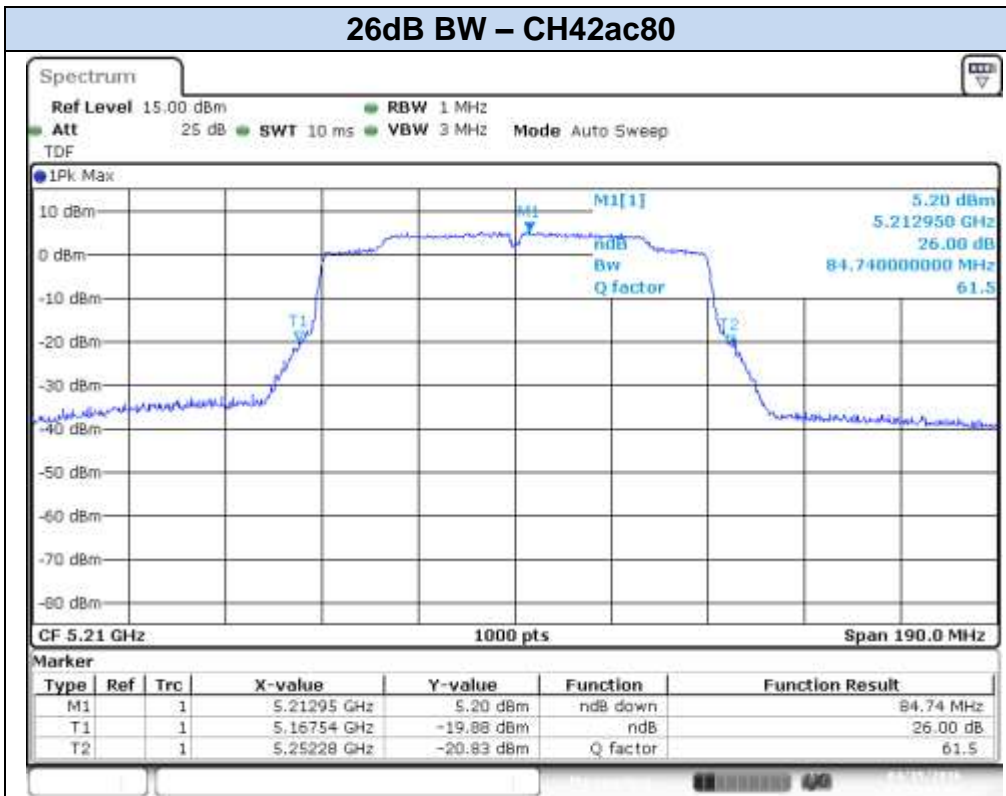

**802.11ac80, VHT0 – MIMO - Chain A**

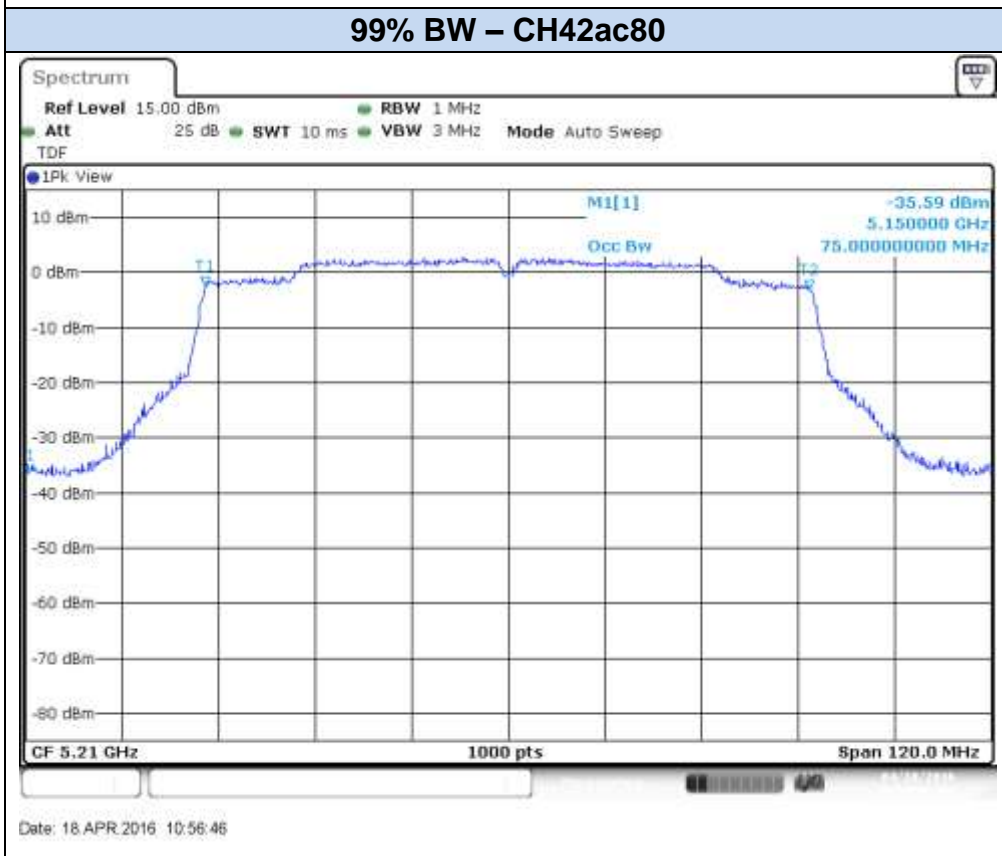
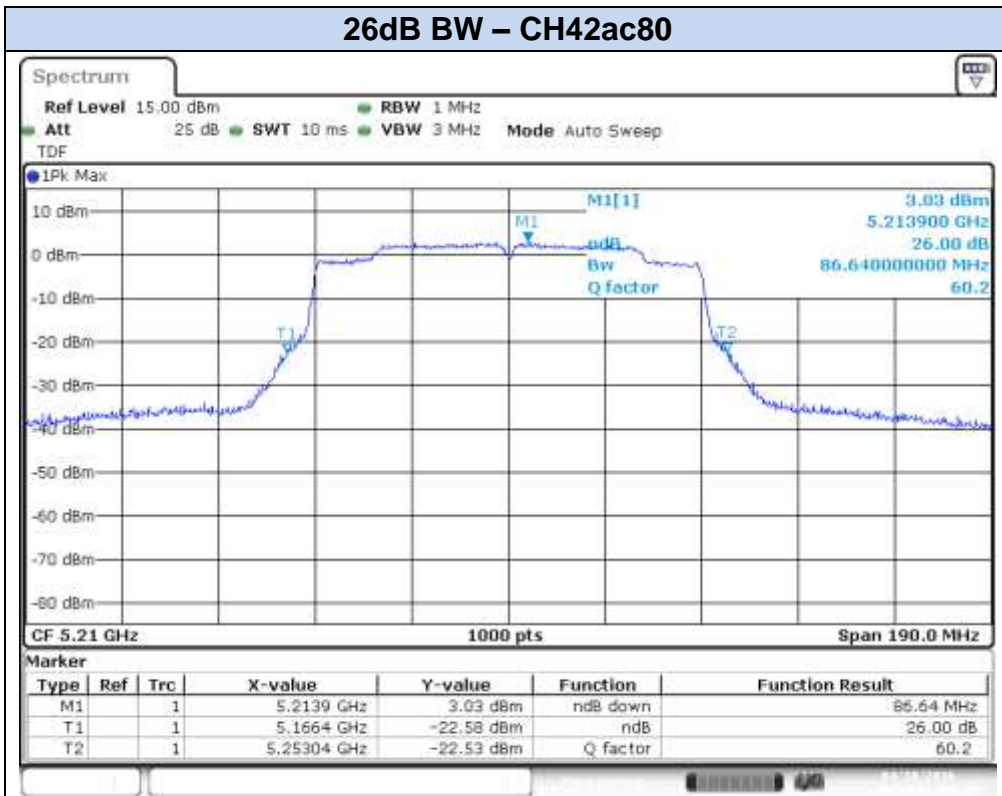

**802.11ac80, VHT0 – MIMO - Chain B**

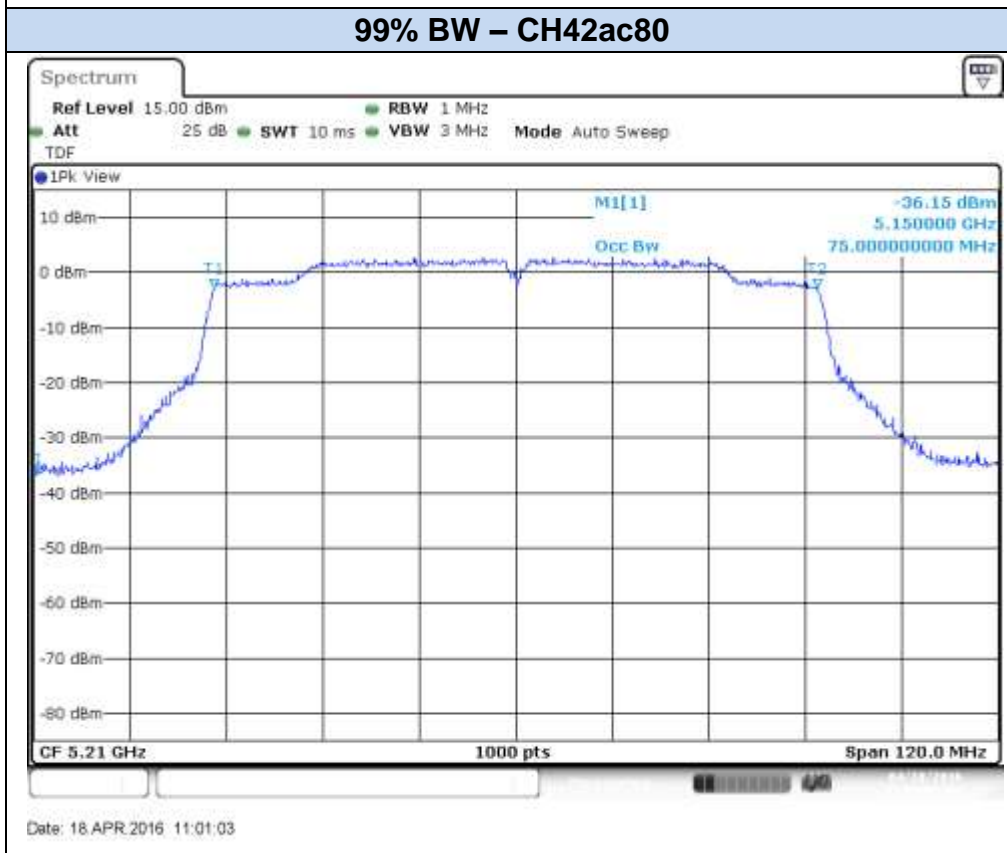
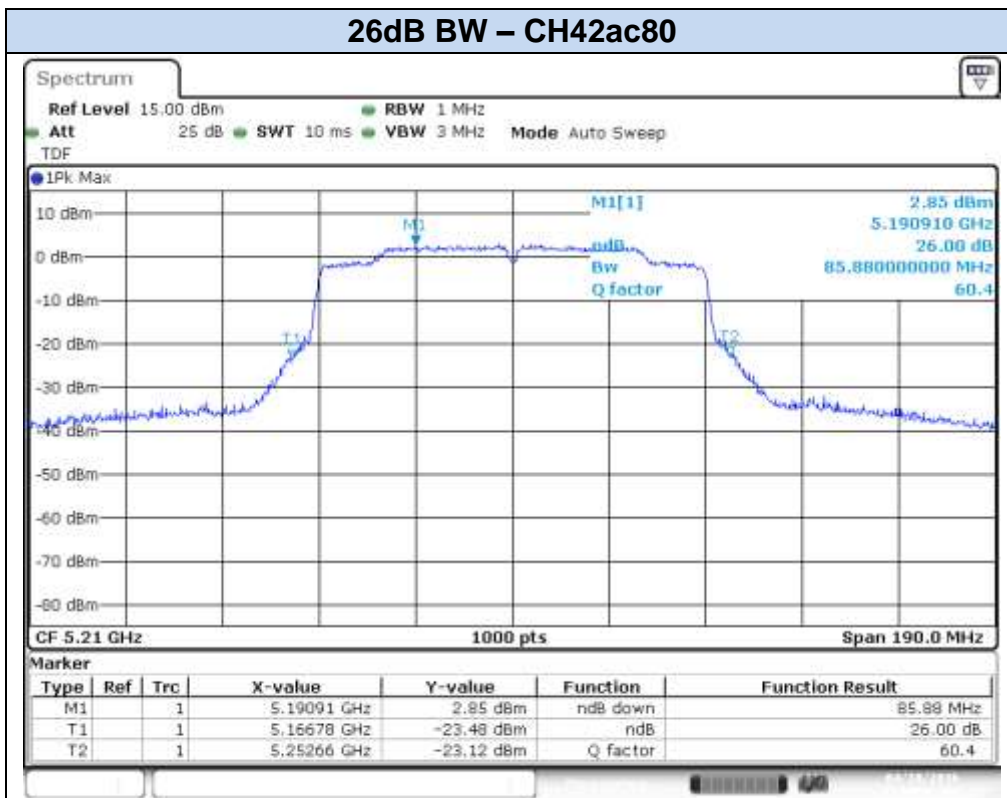

## B.2 Power Limits. Maximum Output power & Maximum power spectral density

### Test limits

FCC part	Limits
15.407 (a) (1) (iv)	For mobile and portable client devices in the 5.15-5.25 GHz band, the maximum conducted output power over the frequency band of operation shall not exceed 250 mW provided the maximum antenna gain does not exceed 6 dBi. In addition, the maximum power spectral density shall not exceed 11 dBm in any 1 megahertz band.

### Test procedure

The Maximum Conducted Output Power was measured using the channel integration method according to point E) 2) e) (Method SA-2 Alternative) of KDB 789033 D02.

The maximum power spectral density (PSD) was measured using the method according to point F) (Method SA-2 Alternative) of KDB 789033 D02.

In the measure-and-sum approach for MIMO mode, the conducted emission level (e.g., transmit power or power in specified bandwidth) is measured at each antenna port. The measured results at the various antenna ports are then summed mathematically in linear power units to determine the total emission level from the device.

The EIRP power (dBm) is calculated by adding the declared maximum antenna gain to the measured conducted power.

The setup below was used to measure the maximum conducted output power and power spectral density. The antenna terminal of the EUT is connected to the spectrum analyser through an attenuator, and the spectrum analyzer reading is compensated to include the RF path loss.

The declared maximum antenna gain is 5dBi.

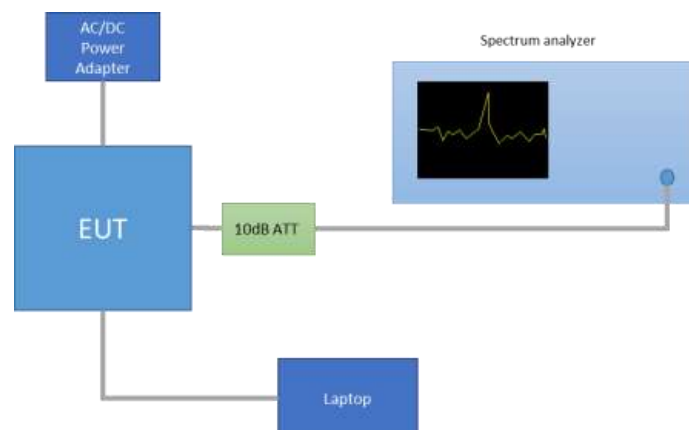

**Results tables**

Mode	Rate	Meas. Duty Cycle [%]	CH	Freq. [MHz]	Antenna	Power [dBm]			PSD Duty cycle Compensated	Power (mW)
						Meas. Cond RMS	Duty cycle Compensated	EIRP		
802.11a	6Mbps	98.0	36	5180	SISO CHAIN A	17.43	17.52	22.52	6.60	56.48
					SISO CHAIN B	17.99	18.08	23.08	7.19	64.25
			40	5200	SISO CHAIN A	20.39	20.48	25.48	9.53	111.66
					SISO CHAIN B	20.21	20.30	25.30	9.36	107.12
			48	5240	SISO CHAIN A	20.37	20.46	25.46	9.49	111.14
					SISO CHAIN B	20.22	20.31	25.31	9.36	107.37
802.11n20	HT0	98.1	36	5180	SISO CHAIN A	17.94	18.02	23.02	6.94	63.44
					SISO CHAIN B	17.41	17.49	22.49	6.45	56.15
			40	5200	SISO CHAIN A	20.35	20.43	25.43	9.32	110.50
					SISO CHAIN B	20.00	20.08	25.08	8.94	101.94
			48	5240	SISO CHAIN A	20.37	20.45	25.45	9.30	111.01
					SISO CHAIN B	20.32	20.40	25.40	9.29	109.74
	HT8	97.6	36	5180	MIMO CHAIN A	15.87	15.97	20.97	4.87	39.57
					MIMO CHAIN B	15.82	15.92	20.92	4.90	39.12
			40	5200	MIMO CHAIN A	19.19	19.29	24.29	8.15	84.99
					MIMO CHAIN B	18.71	18.81	23.81	7.71	76.09
			48	5240	MIMO CHAIN A	19.01	19.11	24.11	7.98	81.54
					MIMO CHAIN B	18.38	18.48	23.48	7.42	70.53
802.11n40	HT0	98.1	38F	5190	SISO CHAIN A	17.02	17.10	22.10	2.62	51.33
					SISO CHAIN B	16.75	16.83	21.83	2.44	48.23
			46F	5230	SISO CHAIN A	20.31	20.39	25.39	5.92	109.48
					SISO CHAIN B	20.18	20.26	25.26	5.79	106.26
	HT8	97.6	38F	5190	MIMO CHAIN A	11.86	11.97	16.97	-2.47	15.72
					MIMO CHAIN B	11.55	11.66	16.66	-2.80	14.64
46F	5230	MIMO CHAIN A	18.72	18.83	23.83	4.36	76.30			
		MIMO CHAIN B	18.73	18.84	23.84	4.41	76.48			
802.11ac80	VHT0	98.1	42ac80	5210	SISO CHAIN A	13.05	13.12	18.12	-4.08	20.53
					SISO CHAIN B	12.81	12.89	17.89	-4.39	19.47
	VHT0	97.5	42ac80	5210	MIMO CHAIN A	10.24	10.35	15.35	-7.06	10.83
					MIMO CHAIN B	9.87	9.98	14.98	-7.30	9.95

Max Value

Min Value

MIMO modes – Combined results					Power [dBm]			
Mode	Rate	Channel	Frequency (MHz)	Antenna	Combined, Duty Cycle compensated	EIRP	Combined PSD	Power (mW)
802.11n20	HT8	36	5180	MIMO CHAIN A + B	18.96	23.96	7.90	<b>78.68</b>
		40	5200		22.07	27.07	10.95	<b>161.08</b>
		48	5240		21.82	26.82	10.72	152.06
802.11n40	HT8	38F	5190		14.82	19.82	0.37	<b>30.36</b>
		46F	5230		21.84	26.84	7.39	<b>152.79</b>
802.11ac80	VHT0	42ac80	5210		13.18	18.18	-4.17	<b>20.78</b>

**Max Value**

**Min Value**

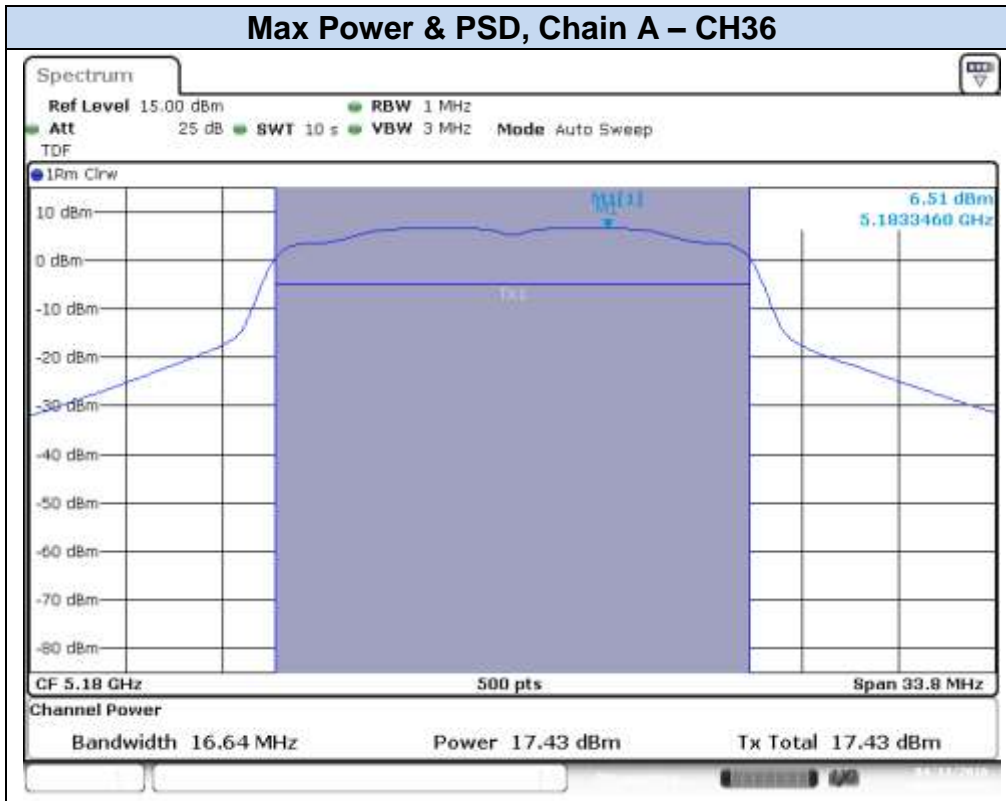
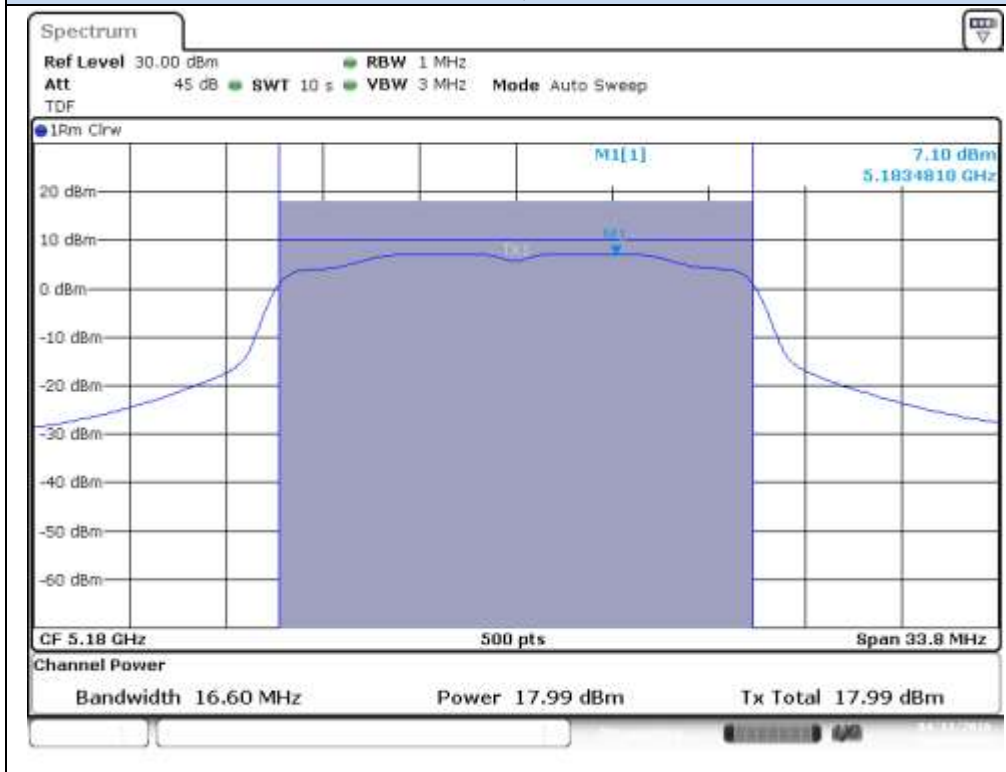
**Results screenshot****802.11a, 6Mbps****Max Power & PSD, Chain B – CH36**

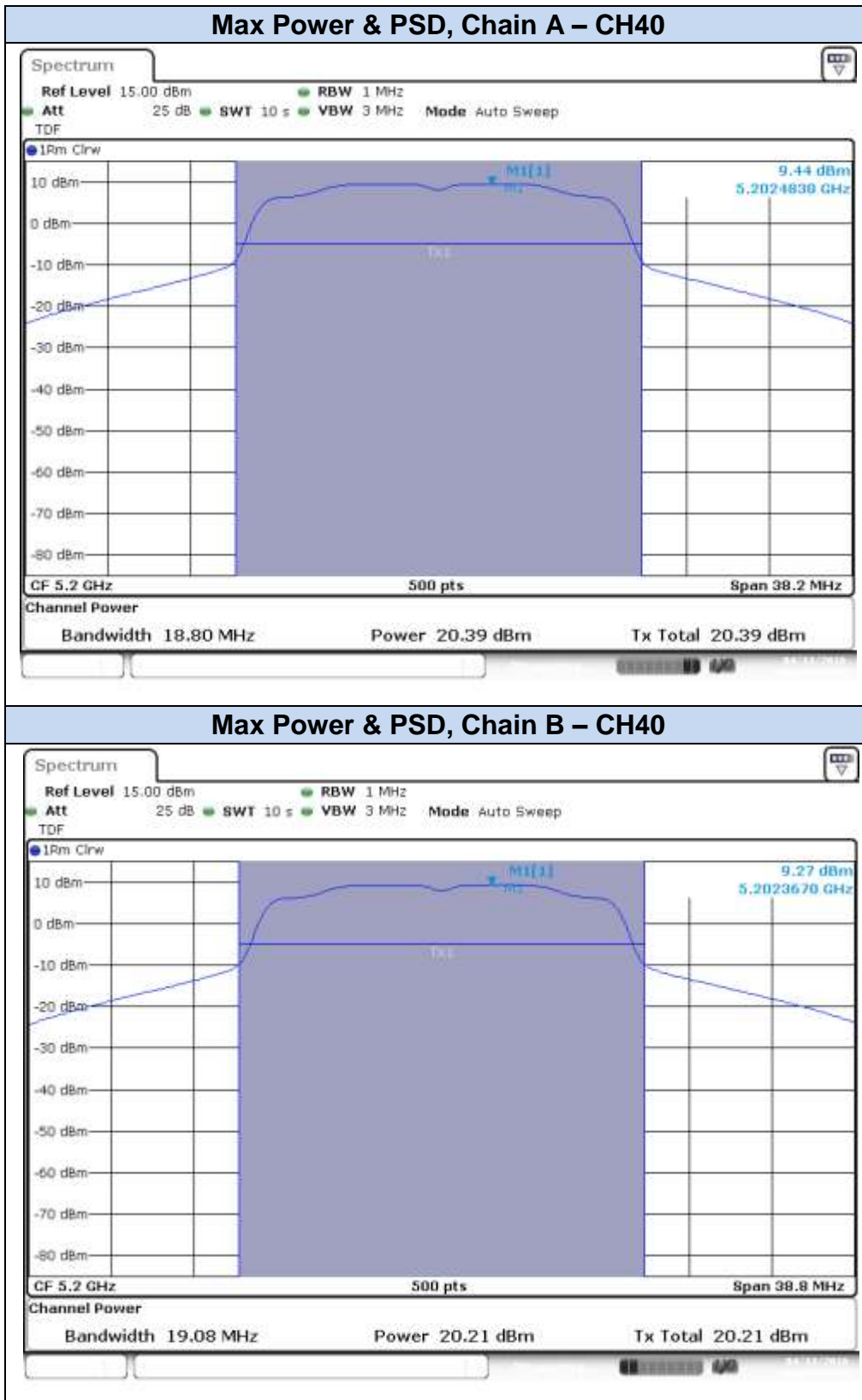



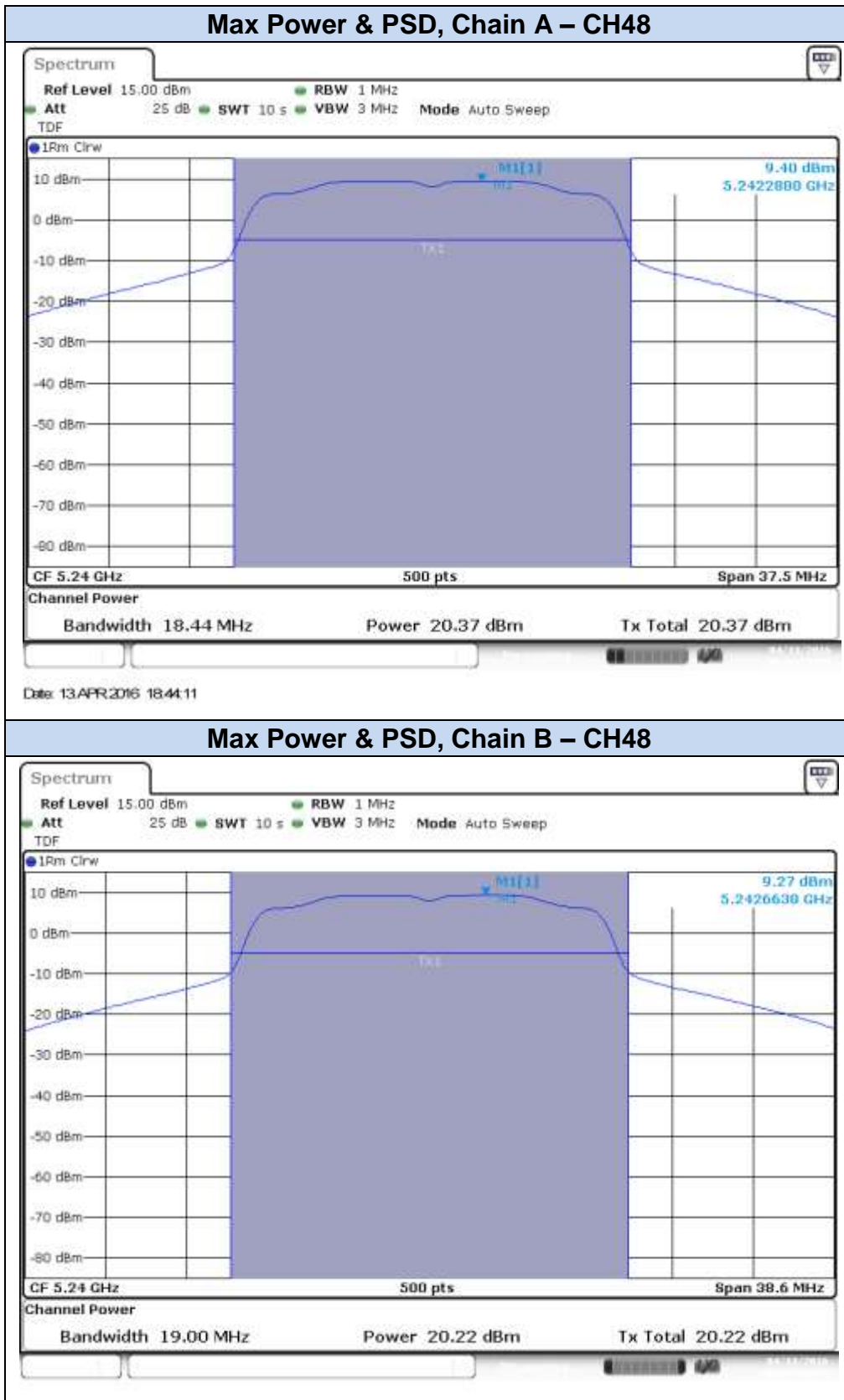

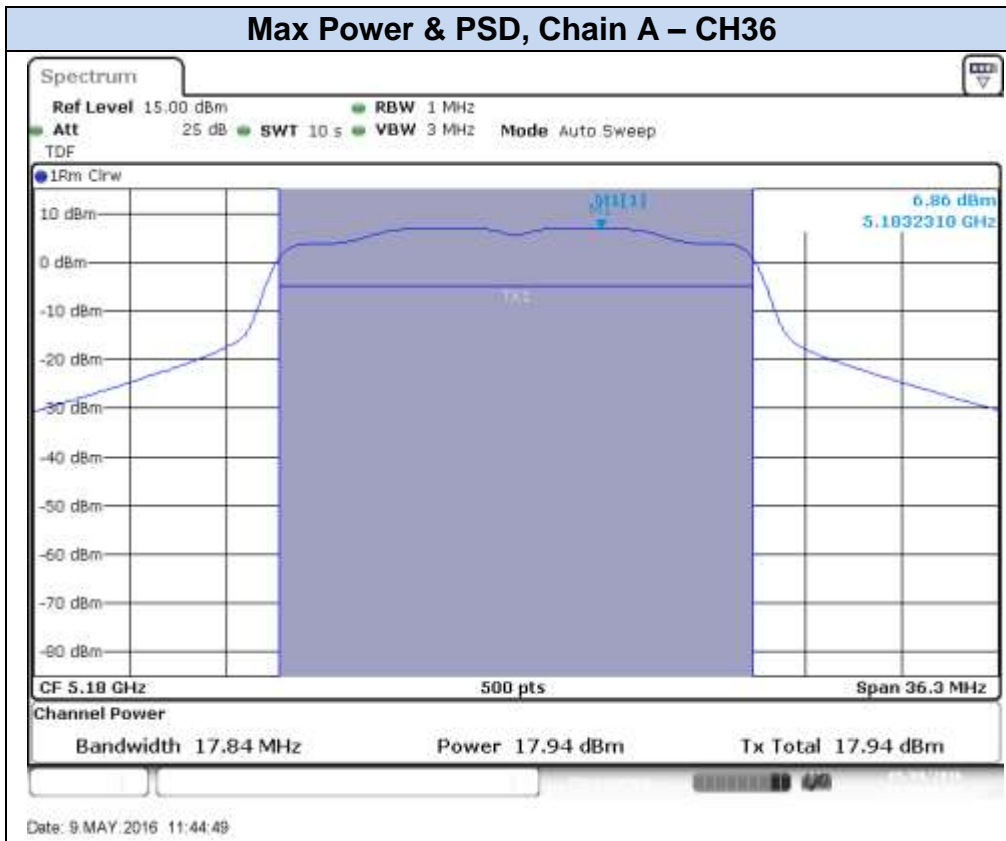
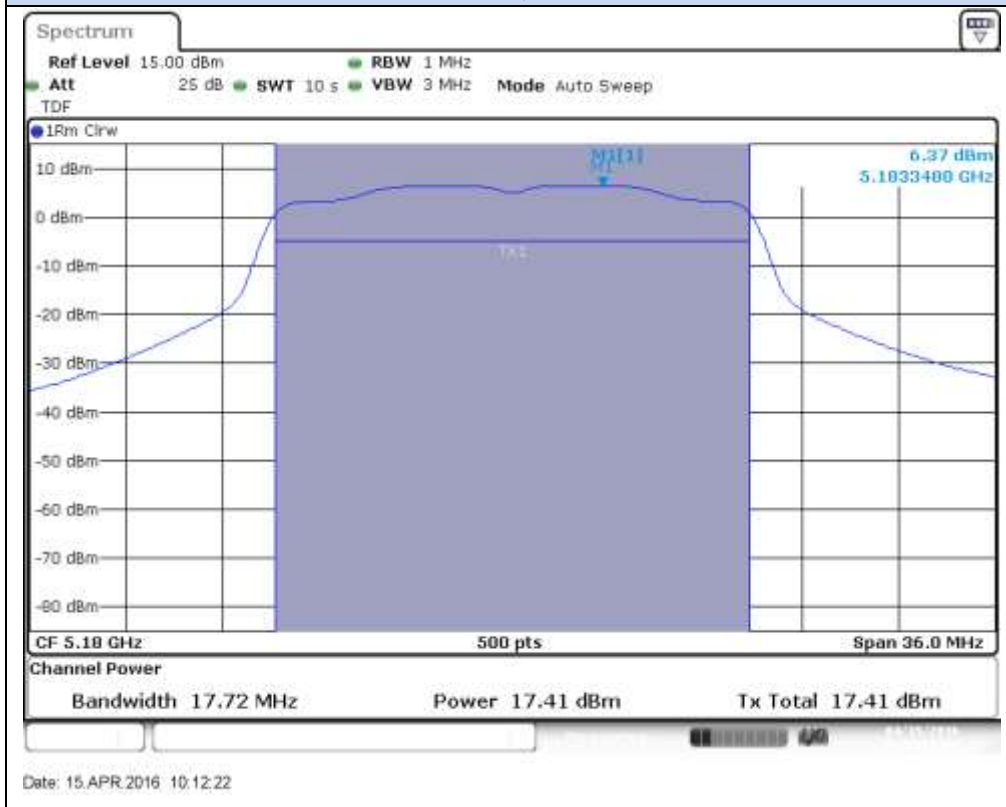
**802.11n20, HT0 (SISO)****Max Power & PSD, Chain A – CH36****Max Power & PSD, Chain B – CH36**

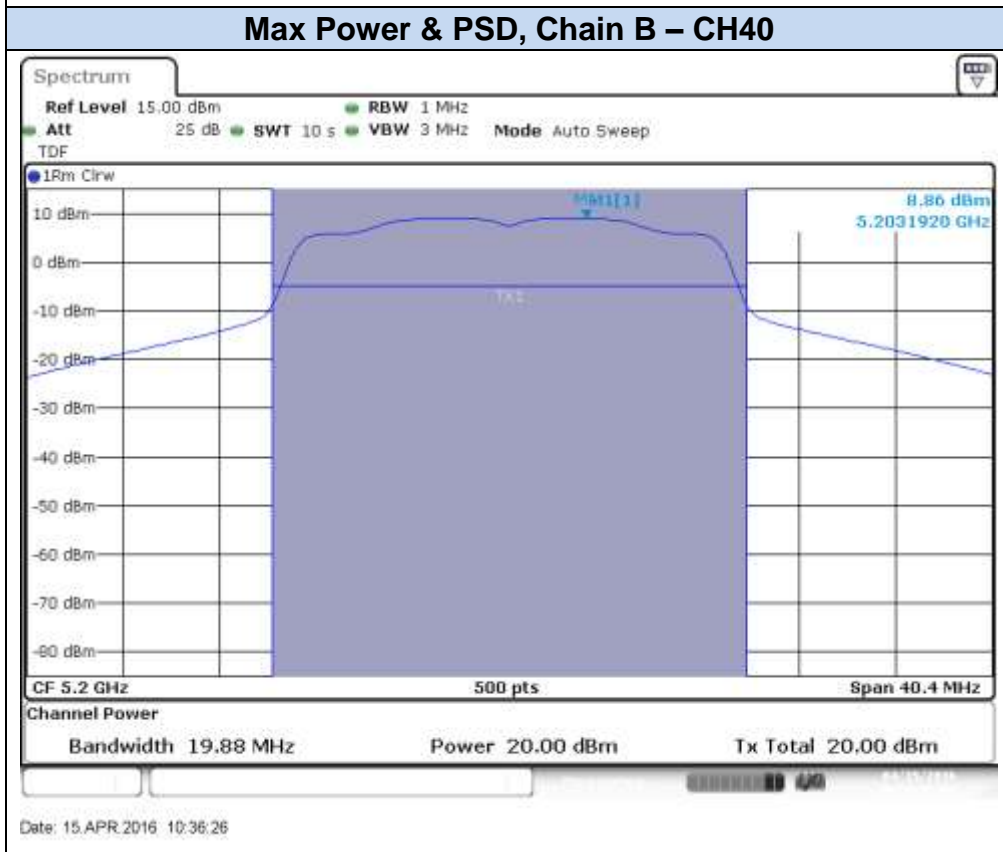
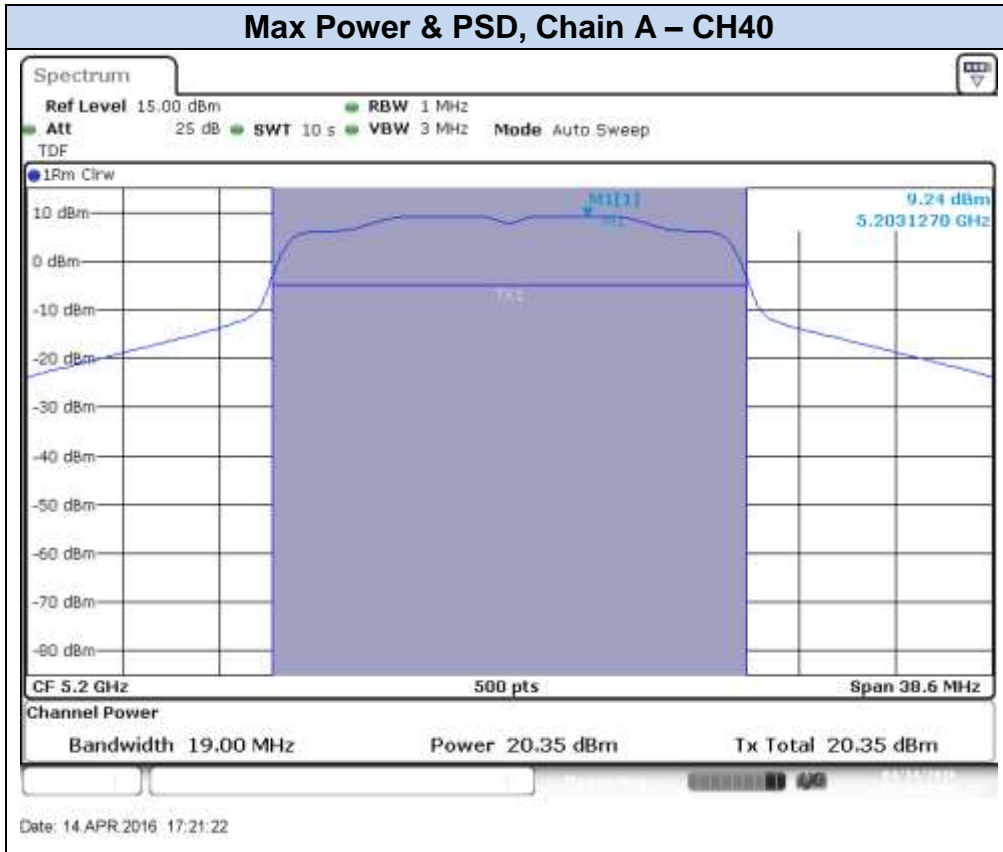

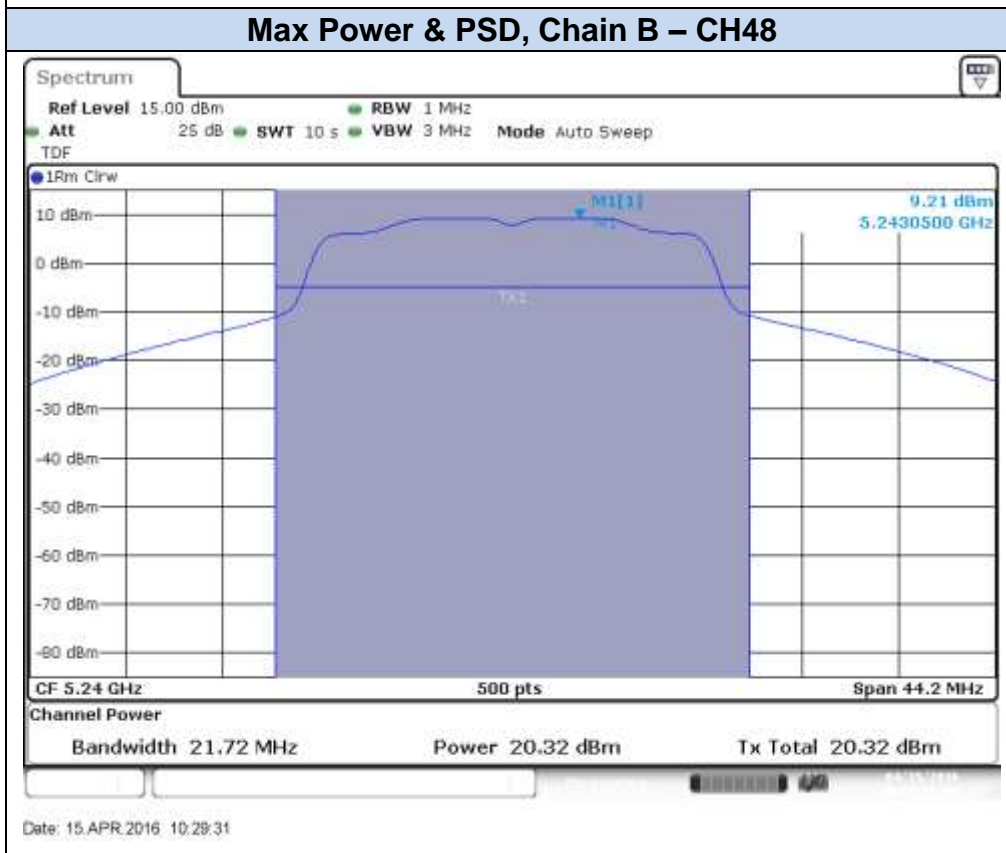
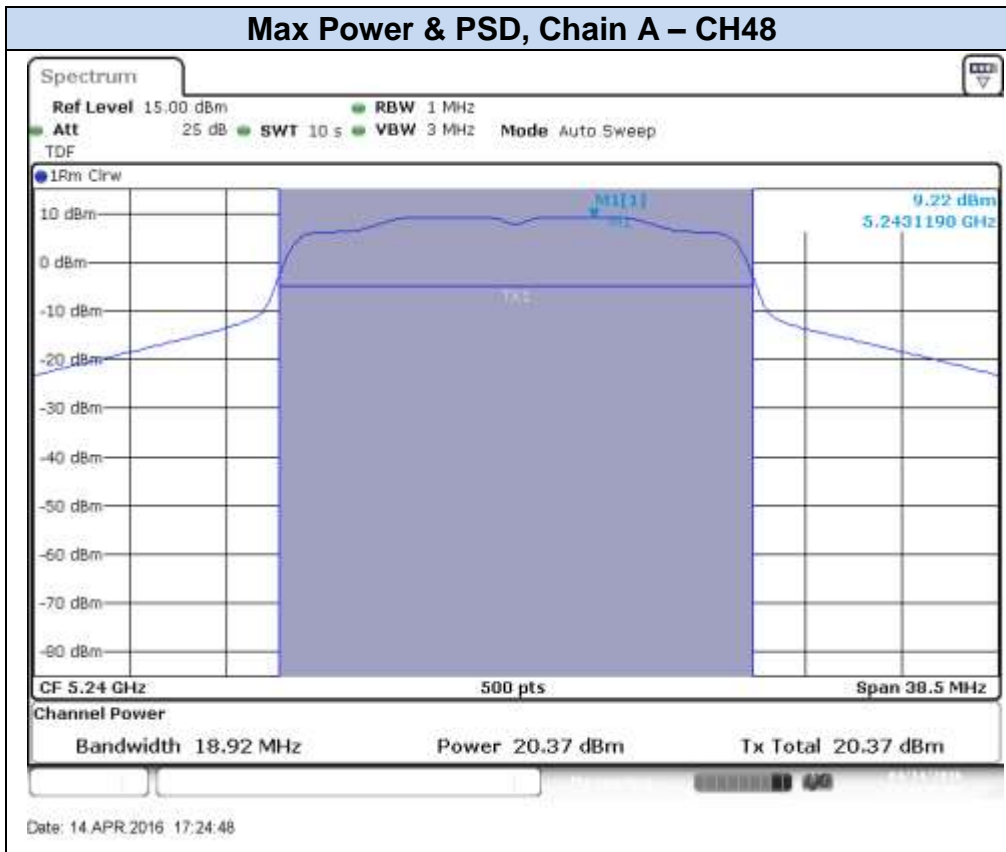

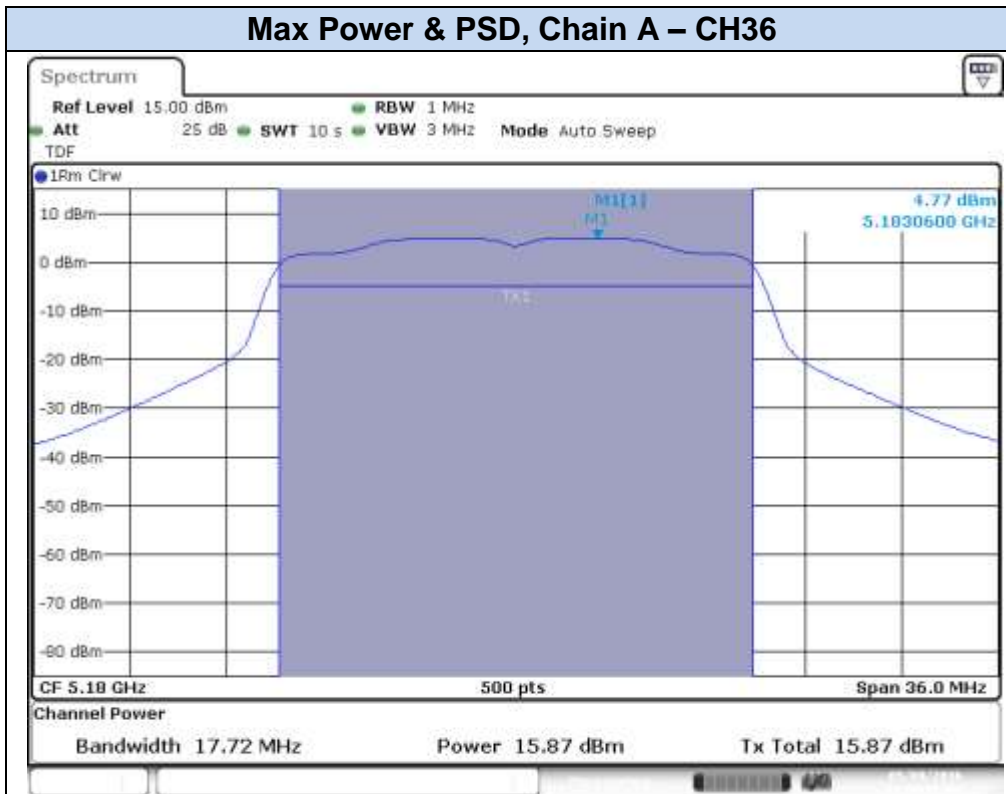
**802.11n20, HT8 (MIMO)**

Date: 9 MAY 2016 11:34:19

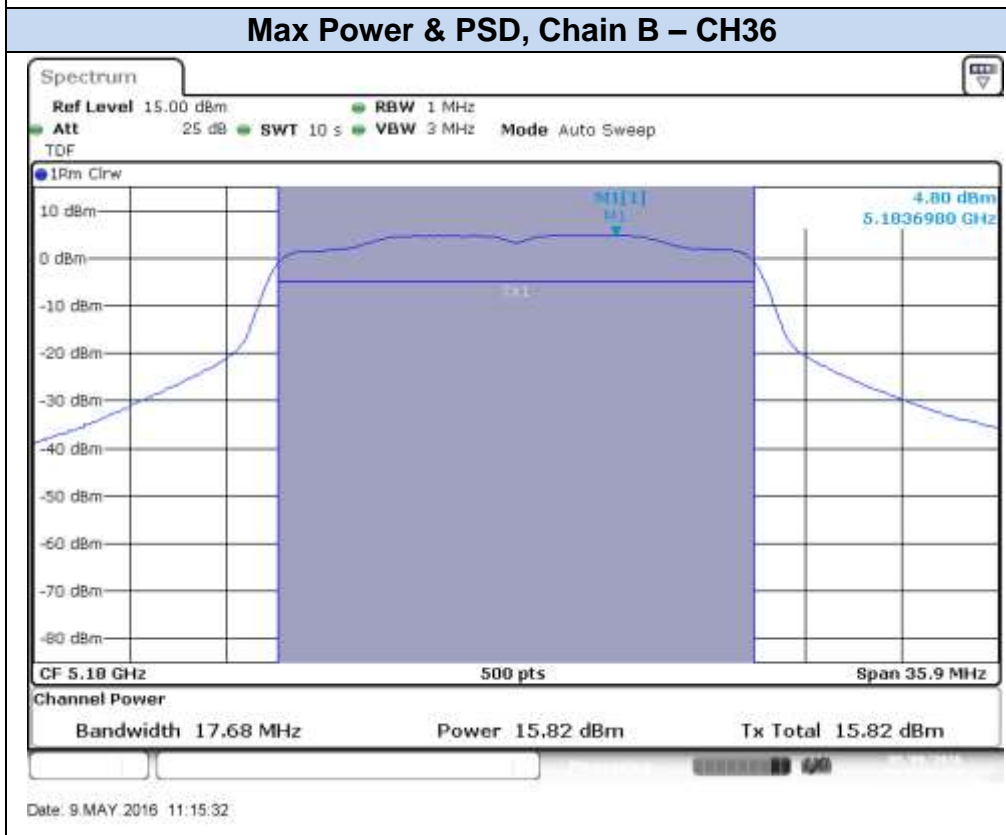

Date: 9 MAY 2016 11:15:32

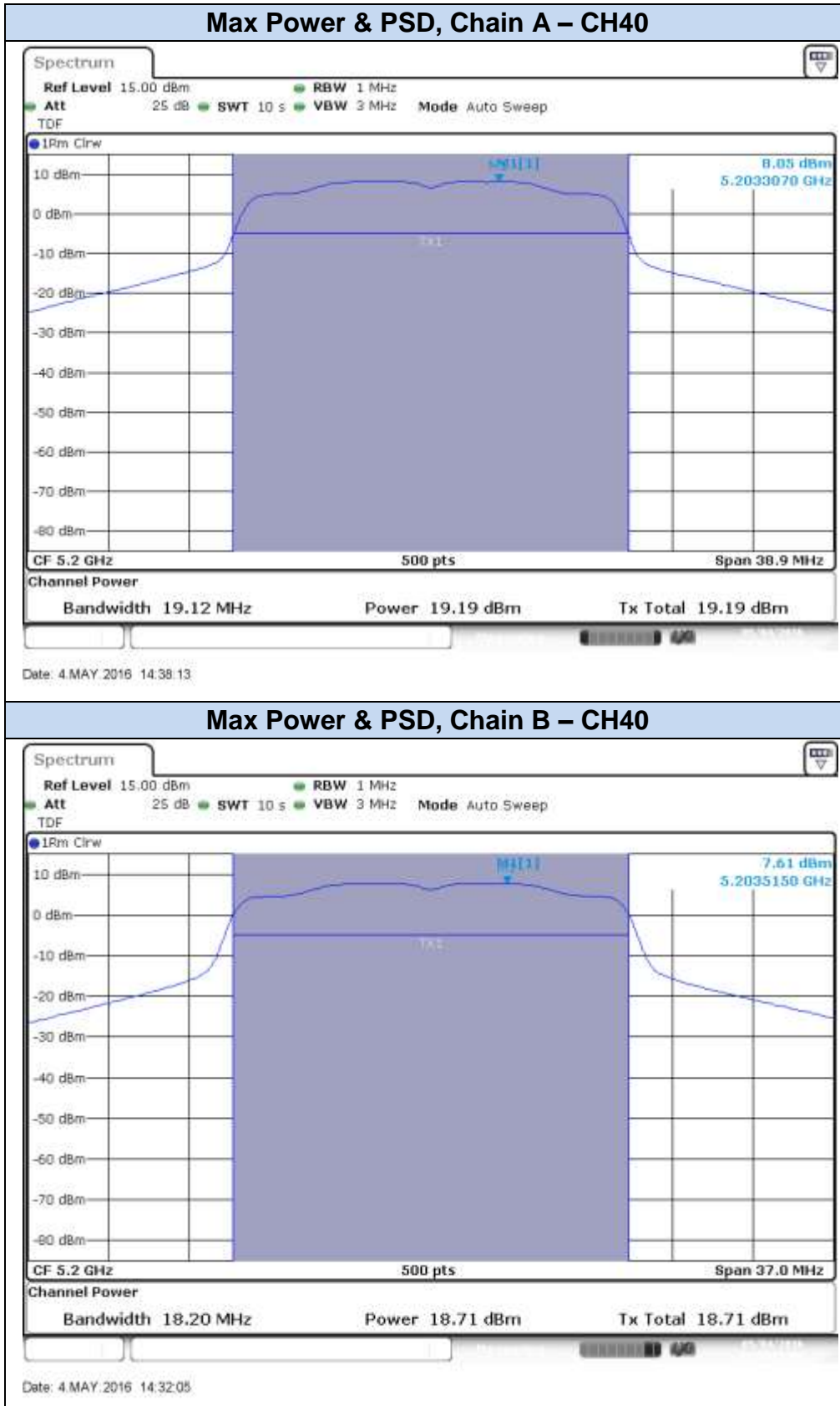

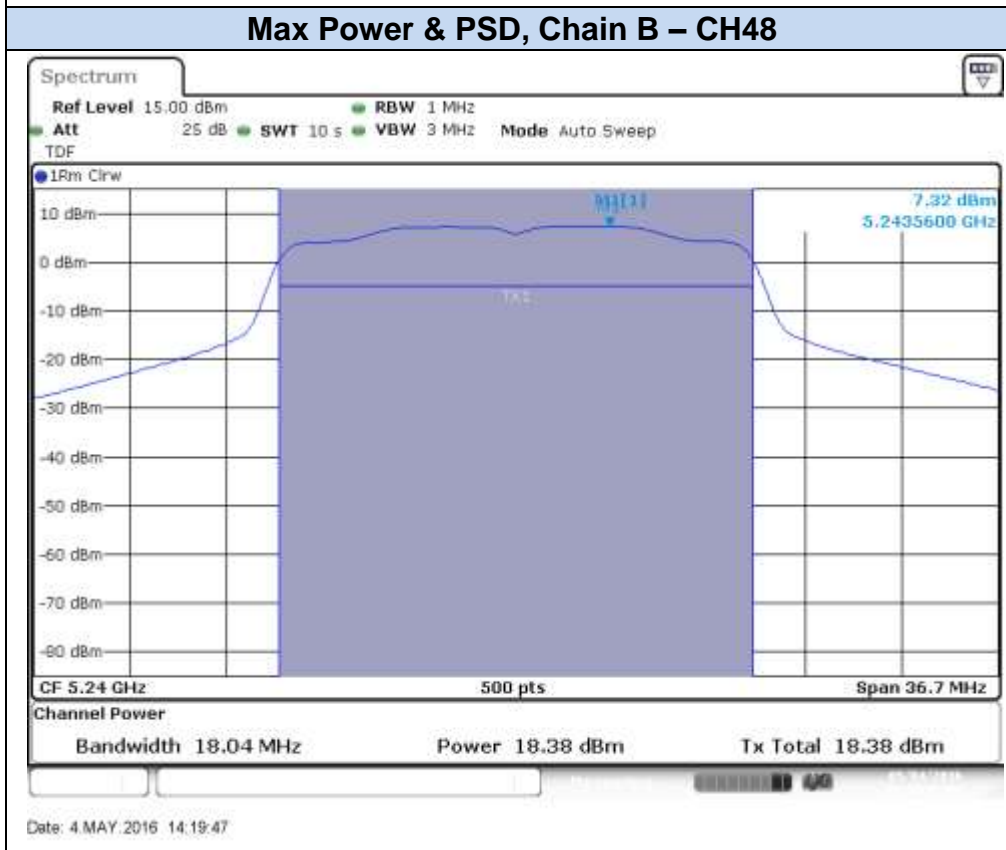
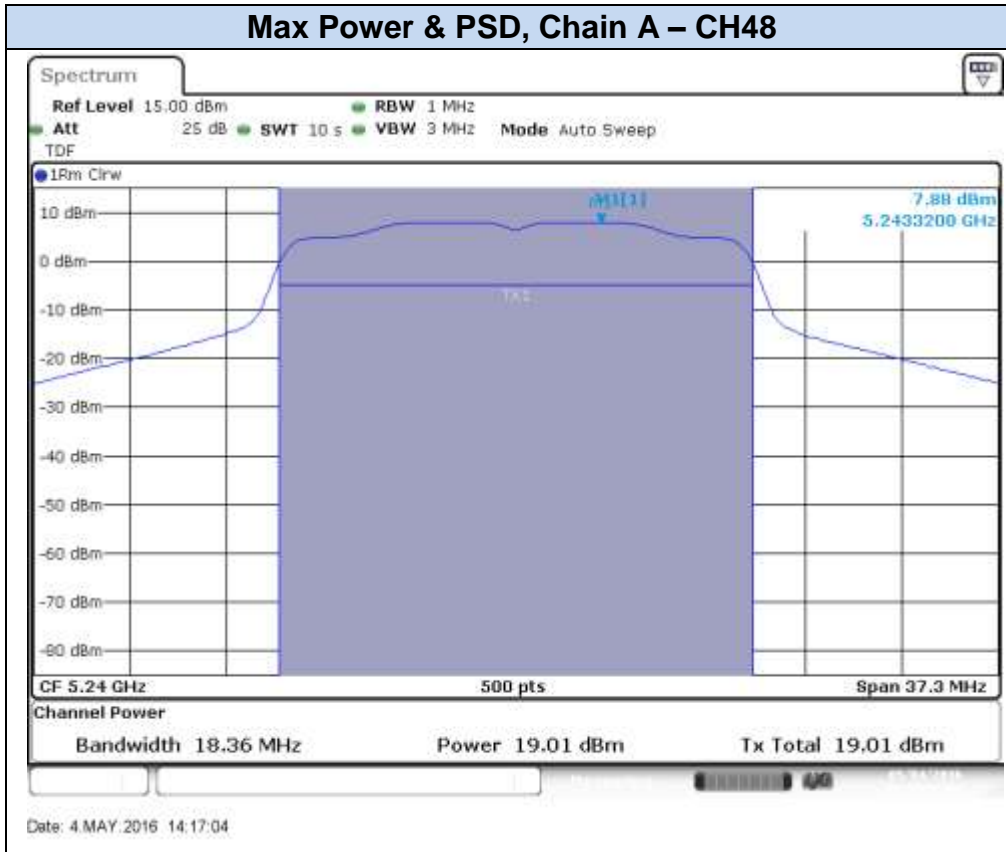

### 802.11n40, HT0 (SISO)

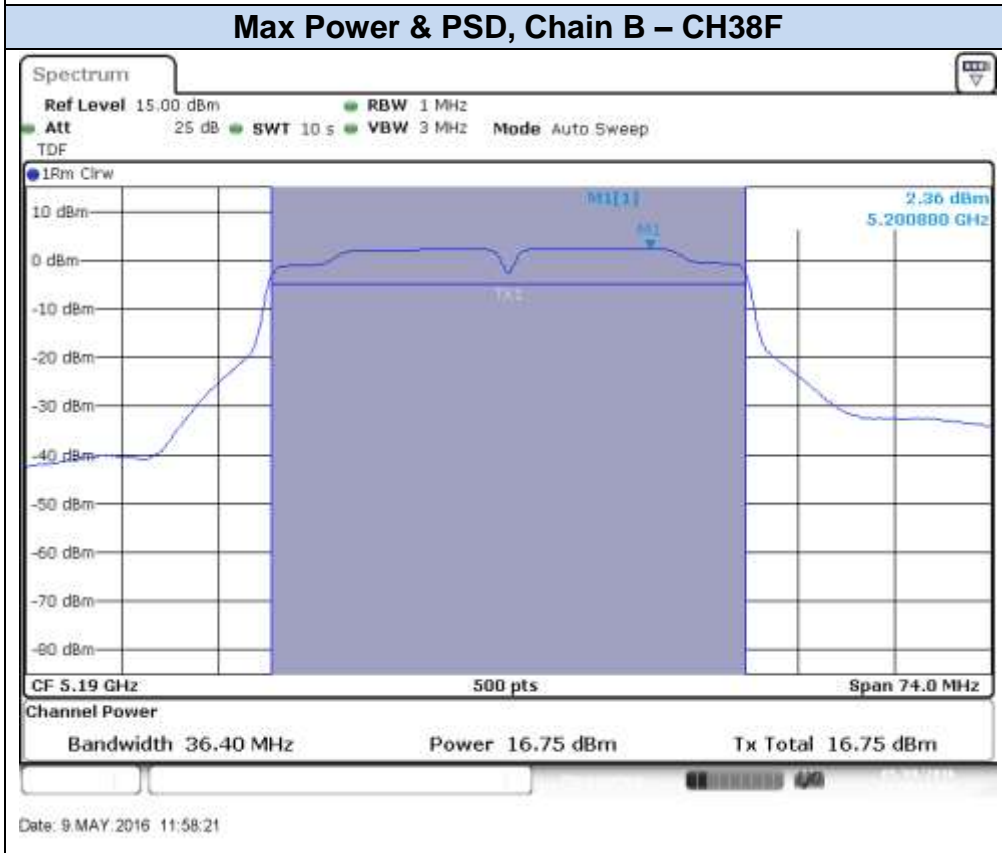
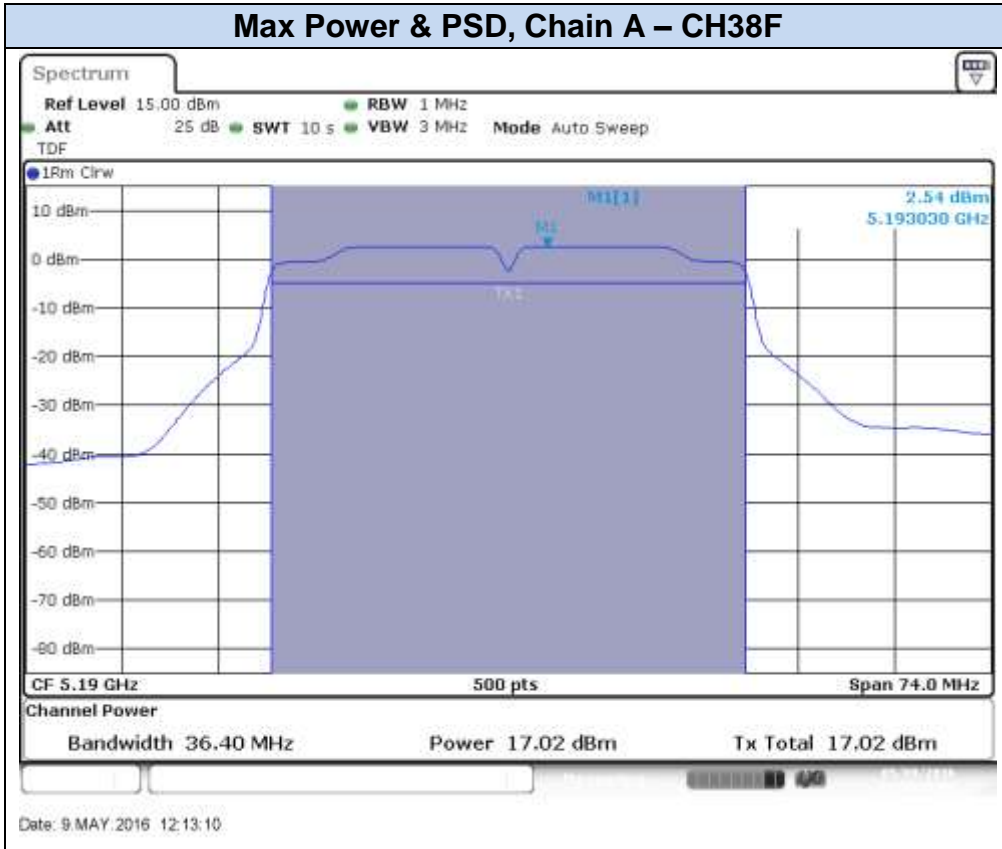



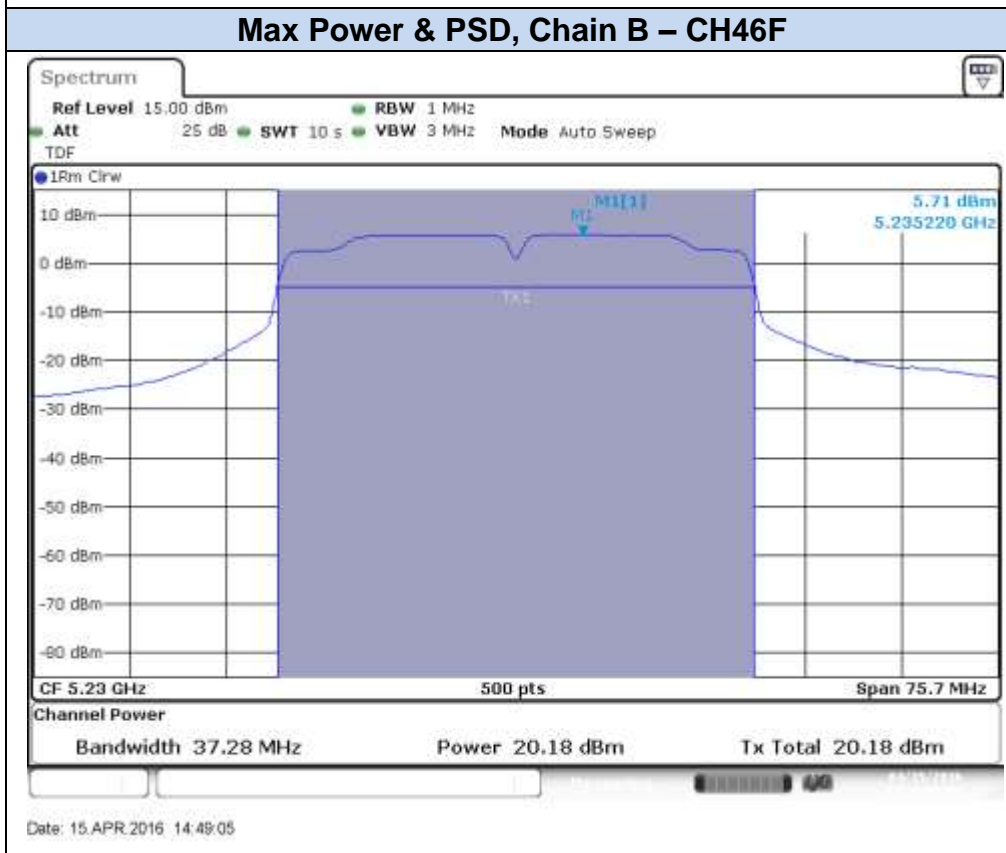
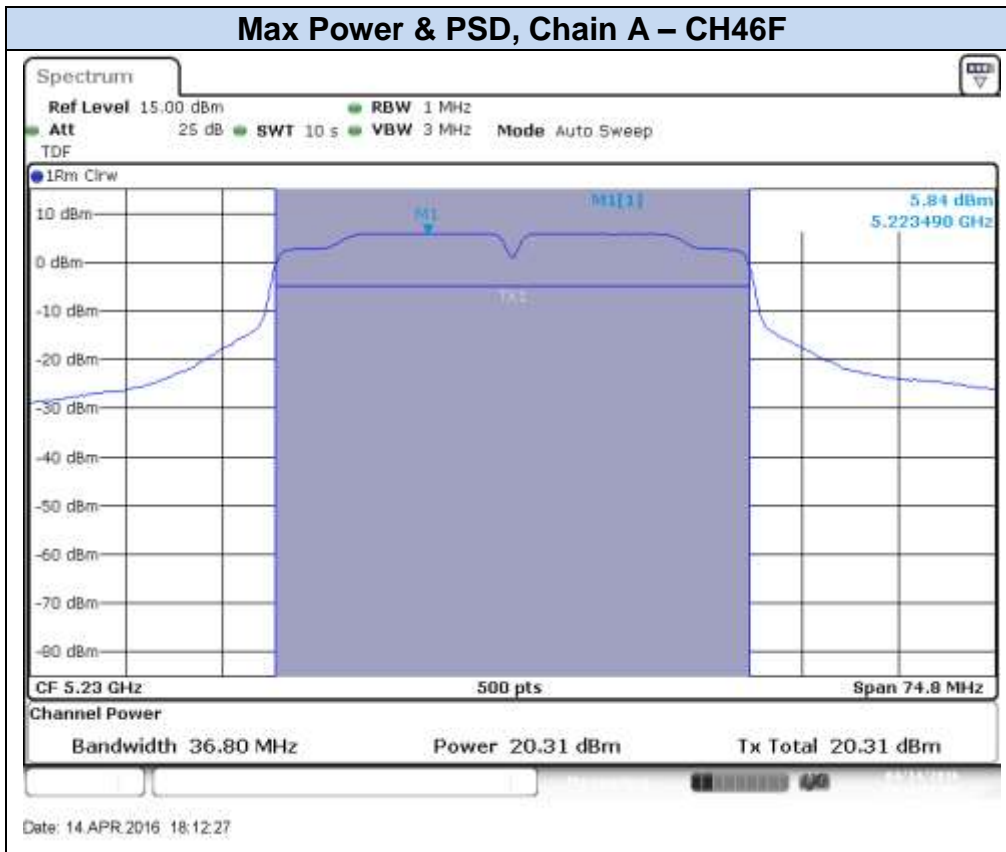

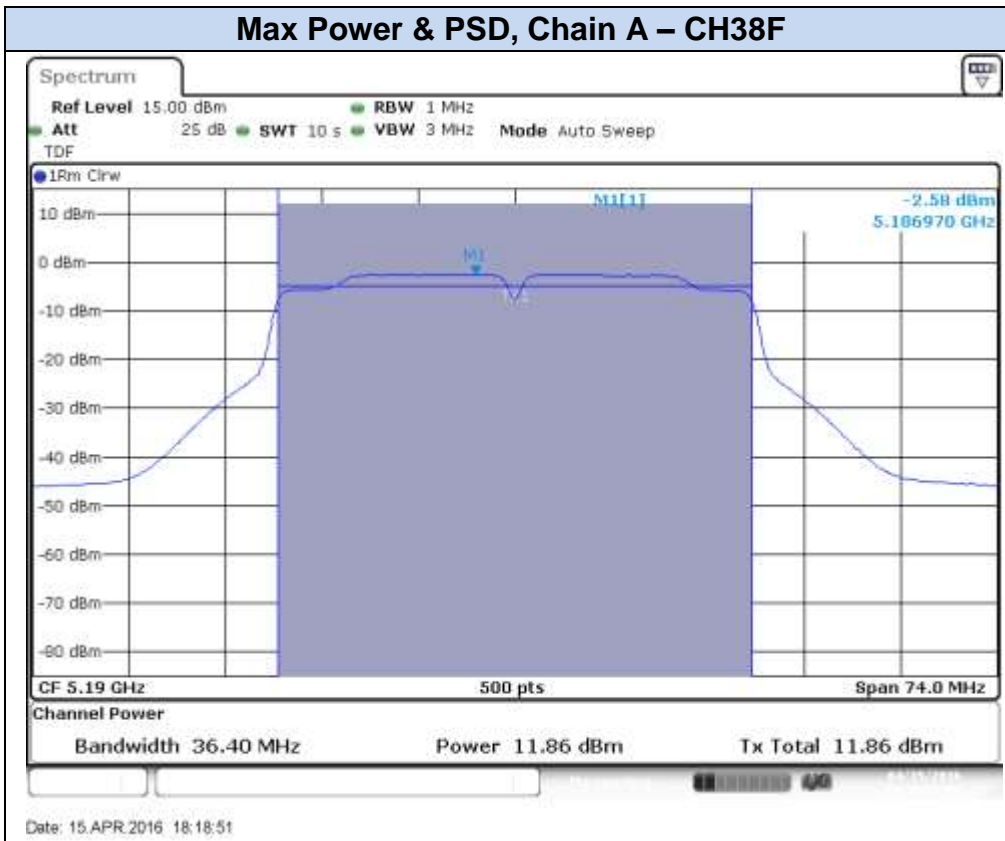
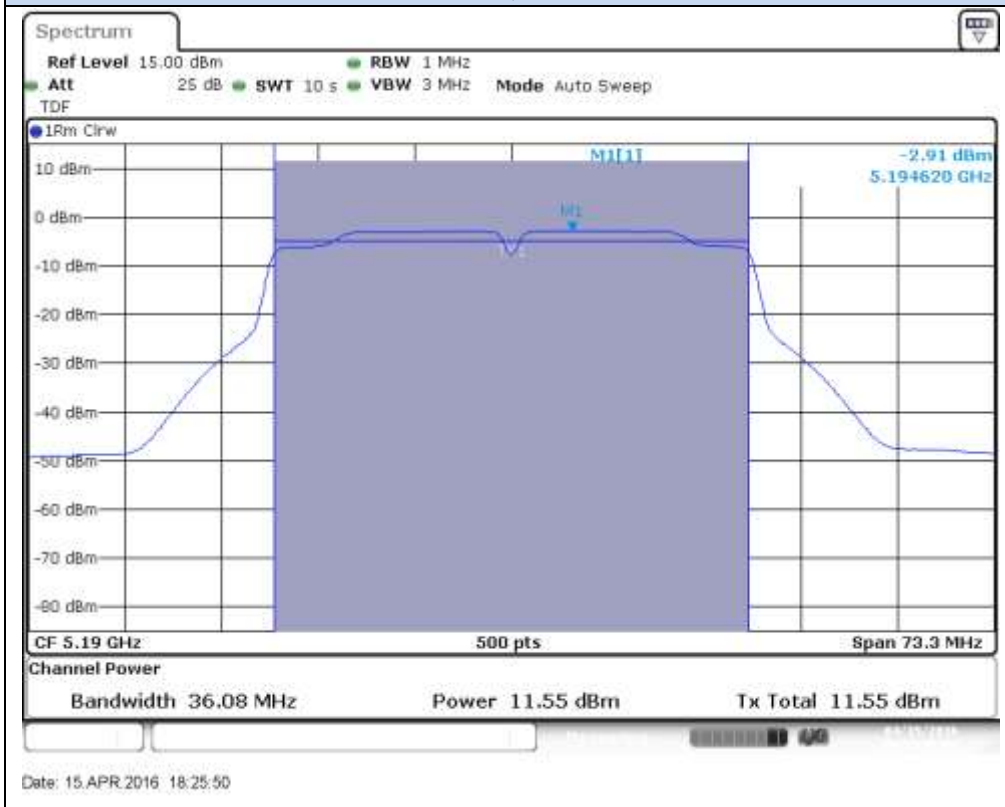
**802.11n40, HT8 (MIMO)****Max Power & PSD, Chain A – CH38F****Max Power & PSD, Chain B – CH38F**

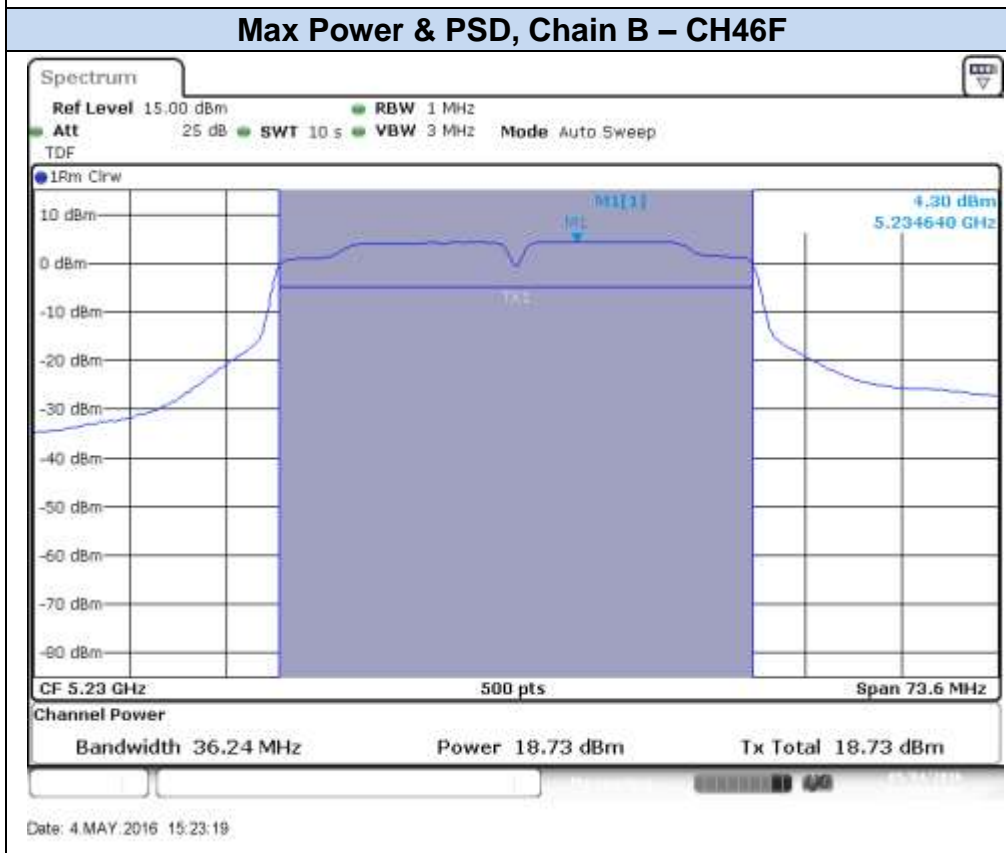
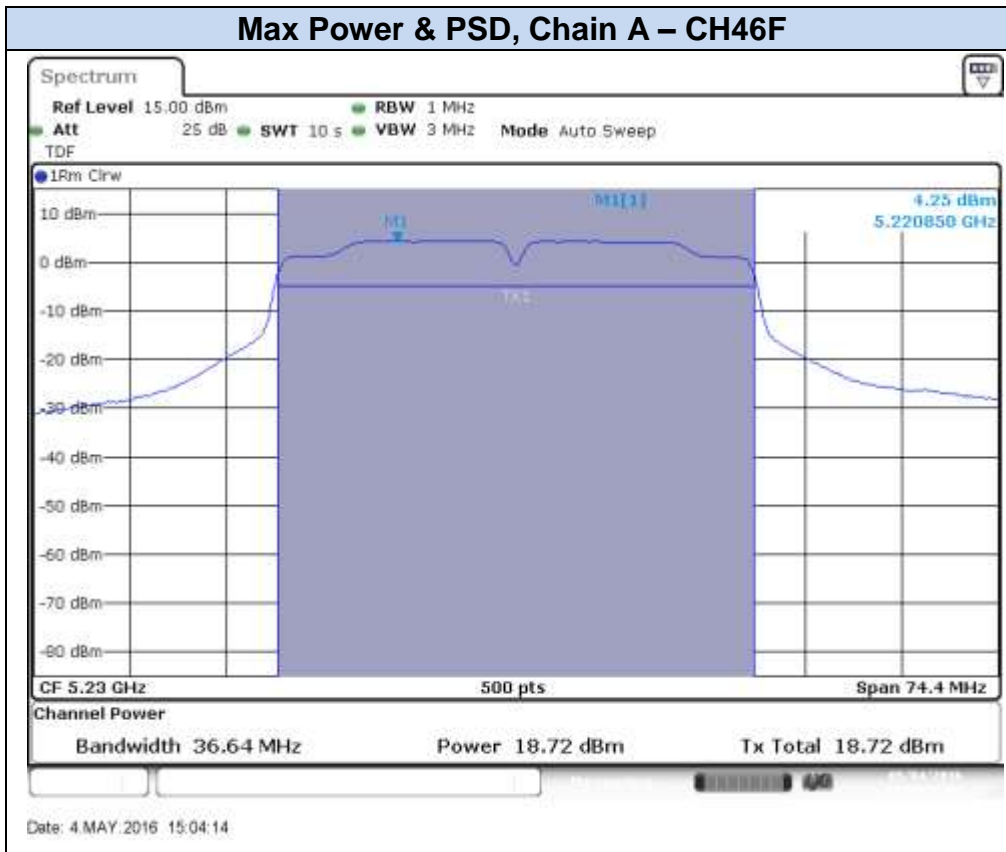

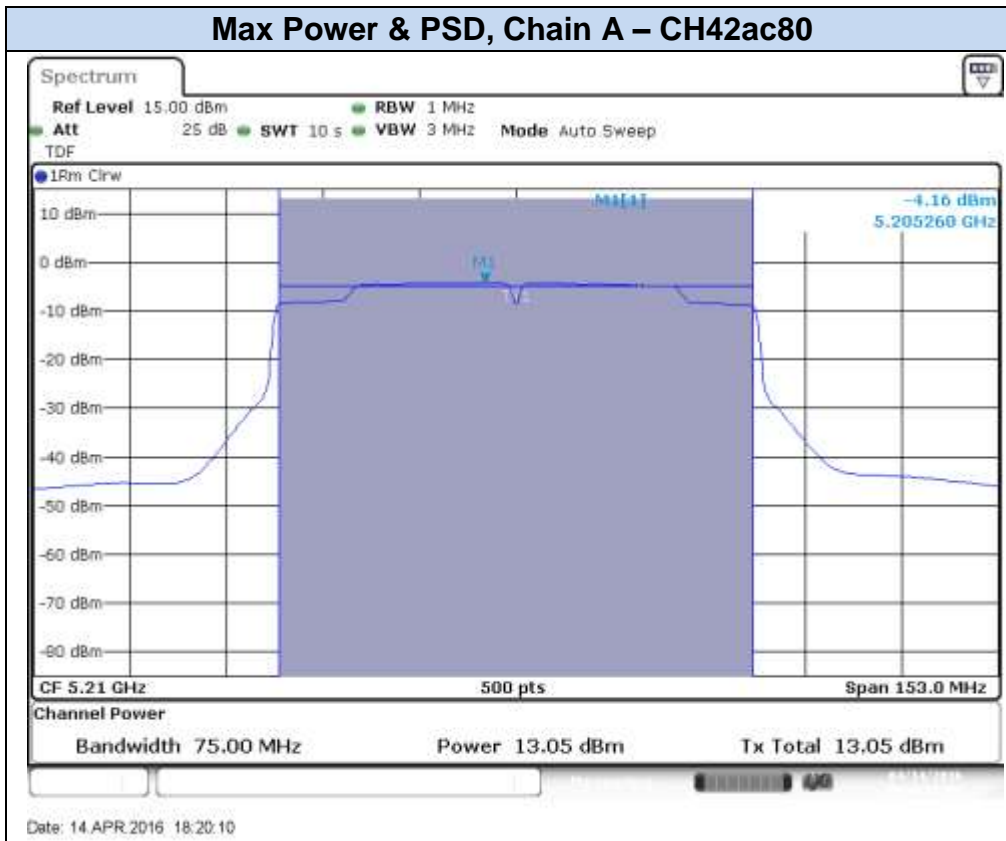
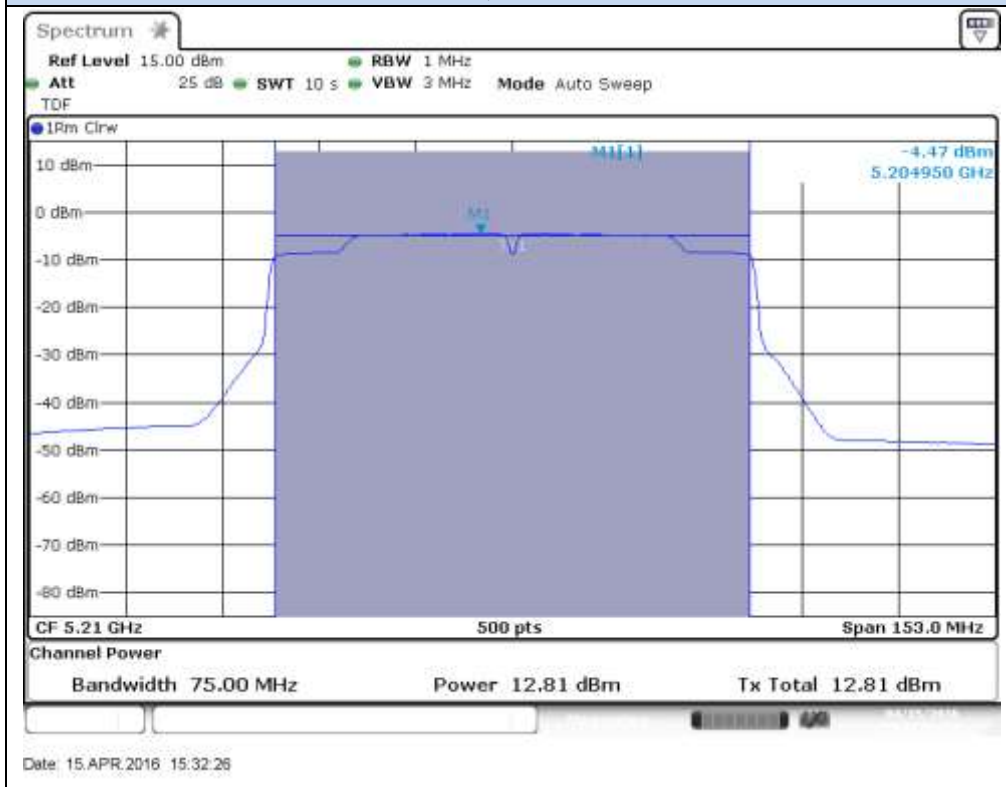
**802.11ac80, VHT0 (SISO)****Max Power & PSD, Chain A – CH42ac80****Max Power & PSD, Chain B – CH42ac80**

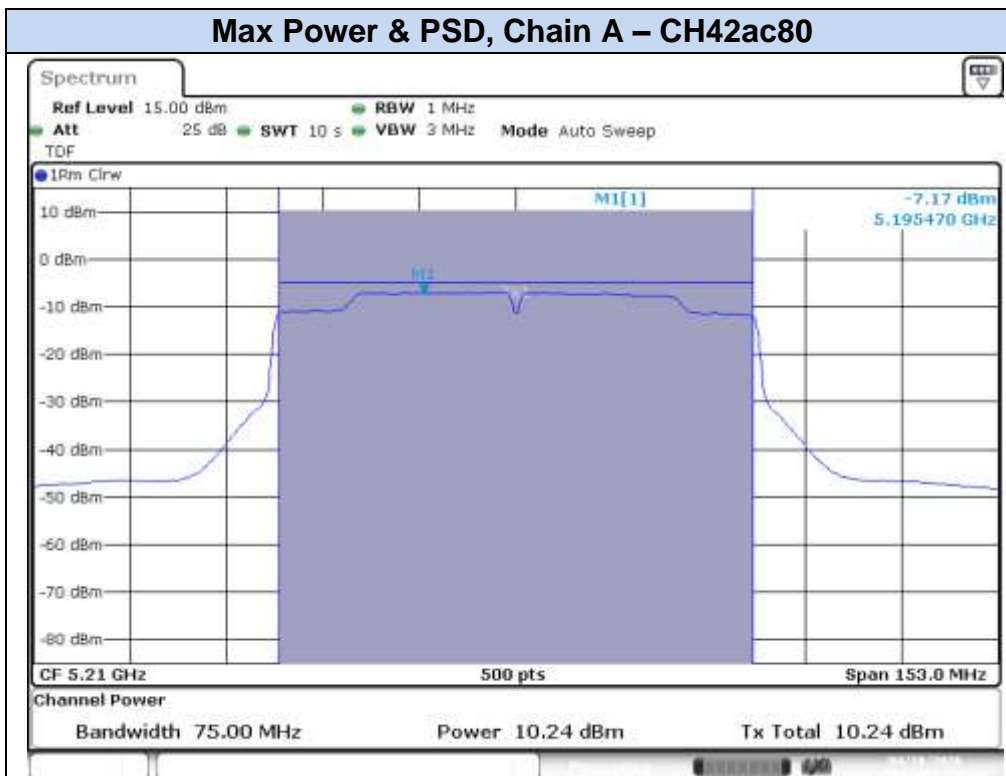
**802.11ac80, VHT0 (MIMO)**

Date: 18 APR.2016 10:57:29

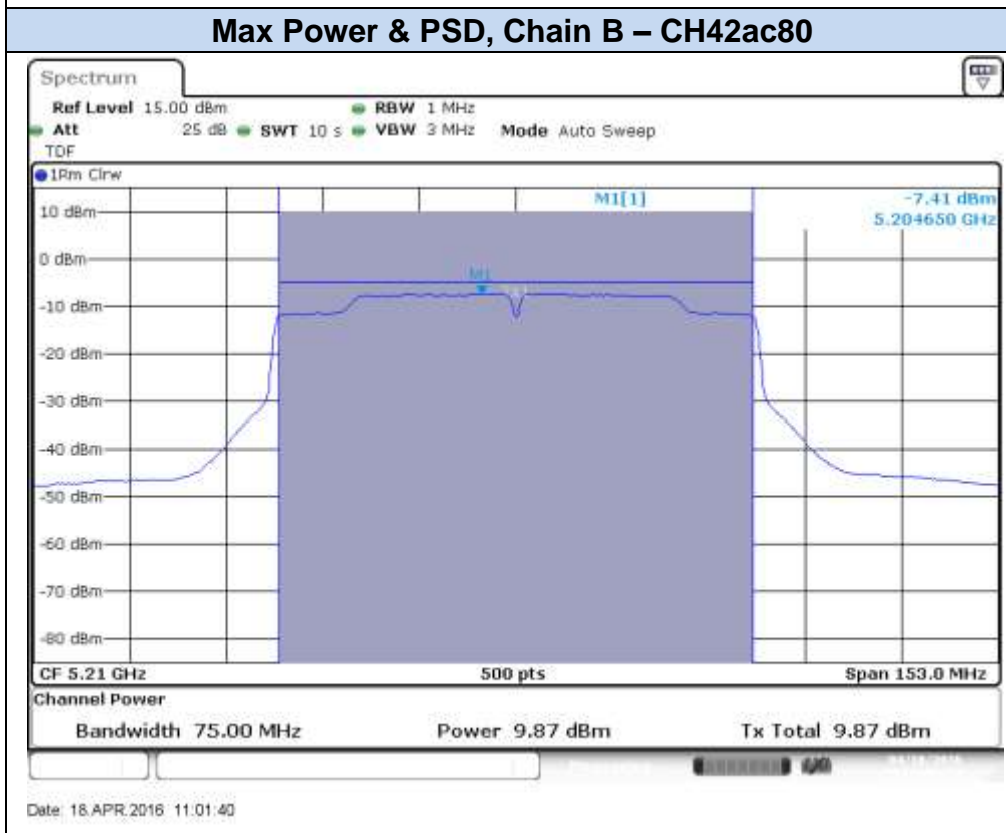

Date: 18 APR.2016 11:01:40

### B.3 Undesirable emissions limits: Band Edge (conducted)

#### Test limits

FCC part	Limits																																
15.407 (b) (1)	For transmitters operating in the 5.15-5.25 GHz band: All emissions outside of the 5.15-5.35 GHz band shall not exceed an e.i.r.p. of -27 dBm/MHz.																																
15.209	<p>Radiated emissions which fall in the restricted bands, as defined in §15.205(a), must also comply with the radiated emission limits specified in §15.209(a):</p> <table border="1"> <thead> <tr> <th>Freq Range (MHz)</th> <th>Field Strength (<math>\mu\text{V/m}</math>)</th> <th>Field Strength (<math>\text{dB}\mu\text{V/m}</math>)</th> <th>Meas. Distance (m)</th> </tr> </thead> <tbody> <tr> <td>0.009-0.490</td> <td>2400/f(kHz)</td> <td>-</td> <td>300</td> </tr> <tr> <td>0.490-1.705</td> <td>24000/f(kHz)</td> <td>-</td> <td>300</td> </tr> <tr> <td>1.705-30.0</td> <td>30</td> <td>-</td> <td>30</td> </tr> <tr> <td>30-88</td> <td>100</td> <td>40</td> <td>3</td> </tr> <tr> <td>88-216</td> <td>150</td> <td>43.5</td> <td>3</td> </tr> <tr> <td>216-960</td> <td>200</td> <td>46</td> <td>3</td> </tr> <tr> <td>Above 960</td> <td>500</td> <td>54</td> <td>3</td> </tr> </tbody> </table> <p>The emission limits shown in the above table are based on measurements employing CISPR quasi-peak detector except for the frequency bands 9-90 kHz, 110-490 kHz and above 1000 MHz. Radiated emission limits in these three bands are based on measurements employing an average detector.</p> <p>For average radiated emission measurements above 1000 MHz, there is also a limit specified when measuring with peak detector function, corresponding to 20 dB above the indicated values in the table.</p>	Freq Range (MHz)	Field Strength ( $\mu\text{V/m}$ )	Field Strength ( $\text{dB}\mu\text{V/m}$ )	Meas. Distance (m)	0.009-0.490	2400/f(kHz)	-	300	0.490-1.705	24000/f(kHz)	-	300	1.705-30.0	30	-	30	30-88	100	40	3	88-216	150	43.5	3	216-960	200	46	3	Above 960	500	54	3
Freq Range (MHz)	Field Strength ( $\mu\text{V/m}$ )	Field Strength ( $\text{dB}\mu\text{V/m}$ )	Meas. Distance (m)																														
0.009-0.490	2400/f(kHz)	-	300																														
0.490-1.705	24000/f(kHz)	-	300																														
1.705-30.0	30	-	30																														
30-88	100	40	3																														
88-216	150	43.5	3																														
216-960	200	46	3																														
Above 960	500	54	3																														

#### Test procedure

The setup below was used to measure undesirable emissions on the Band Edge domain. The antenna terminal of the EUT is connected to the spectrum analyzer through an attenuator, and the spectrum analyzer reading is compensated to include the RF path loss and the declared Antenna Gain.

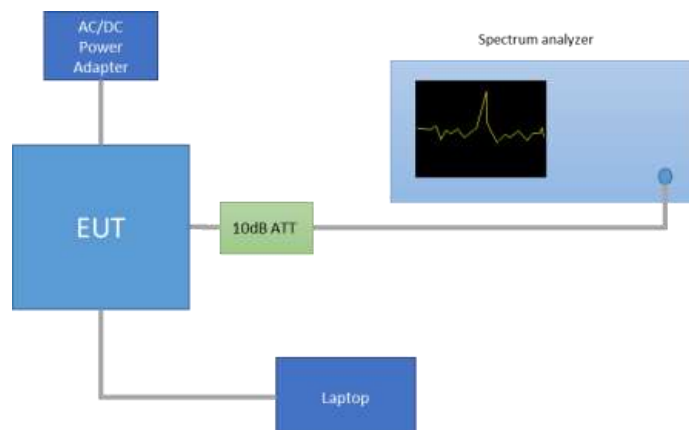

For the BE low RMS, Video Bandwidth Method was used according to section G) 6) (KDB 789033 D02), with the following parameters:

- When the duty cycle is > 98 %, VBW=10Hz
- When the duty cycle is < 98 %, VBW > 1/T, where T is defined in section II.B.1.a

In case of Band Edge measurements falling in restricted bands, the declared Antenna Gain is also compensated in the graph. The declared maximum antenna gain is 5dBi.

For Band Edge measurements falling in restricted bands, the following limits in dBm were applied for the average detector after the conversion from the limits detailed above in dB $\mu$ V/m, according to FCC 47 CFR part 15 - Subpart C – §15.209(a). The limits in dBm for peak detector are 20dB above the indicated values in the table.

§15.209(a)			Converted values	
Freq Range (MHz)	Distance (m)	Field strength (microvolts/meter)	Field strength (dB microvolts/meter)	Power (dBm)
Above 960	3	500	54.0	-41.2

**Results Screenshot**

**802.11a, 6Mbps – Chain A**

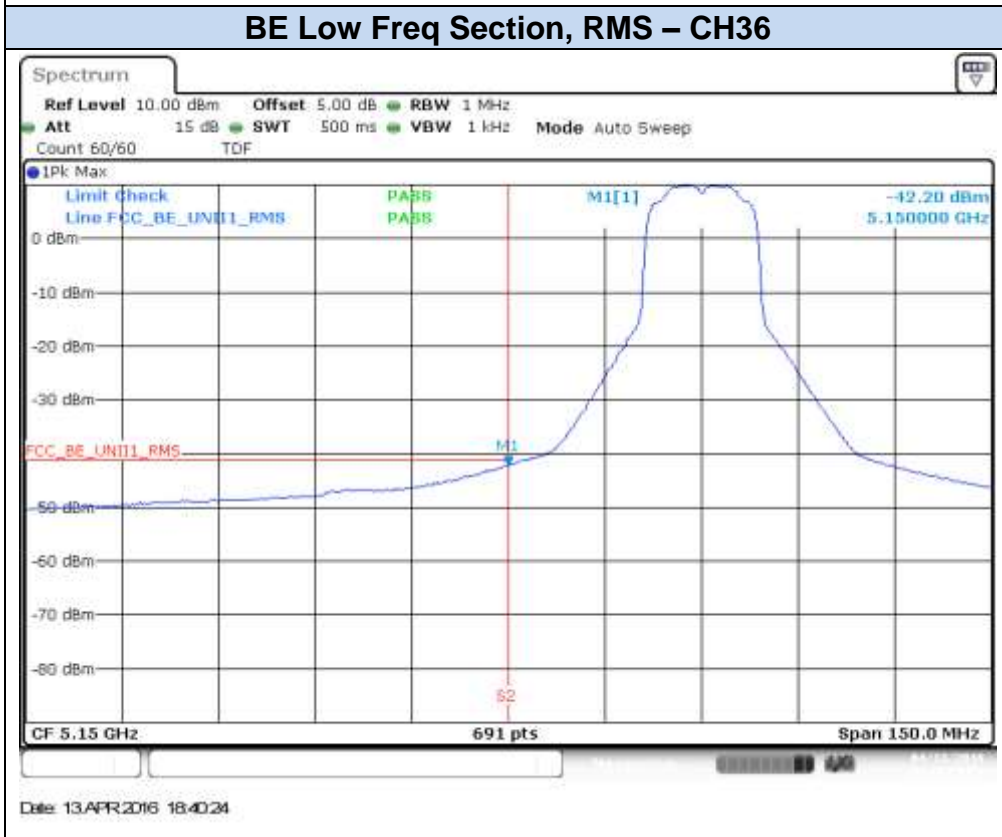
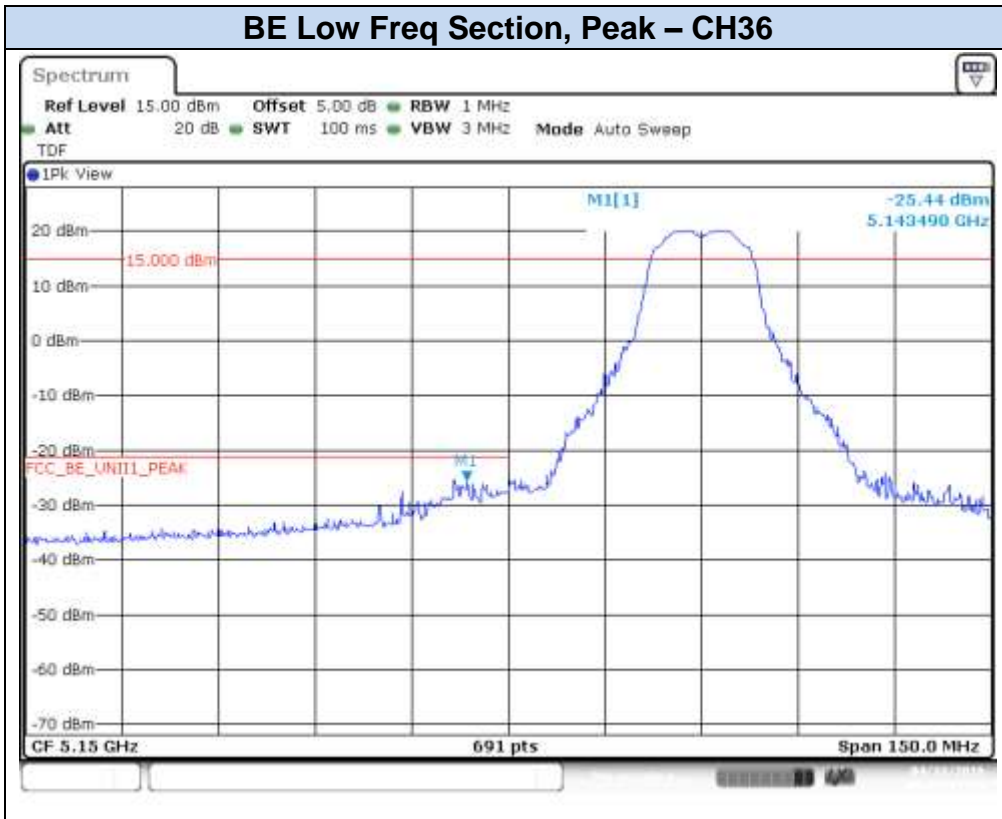



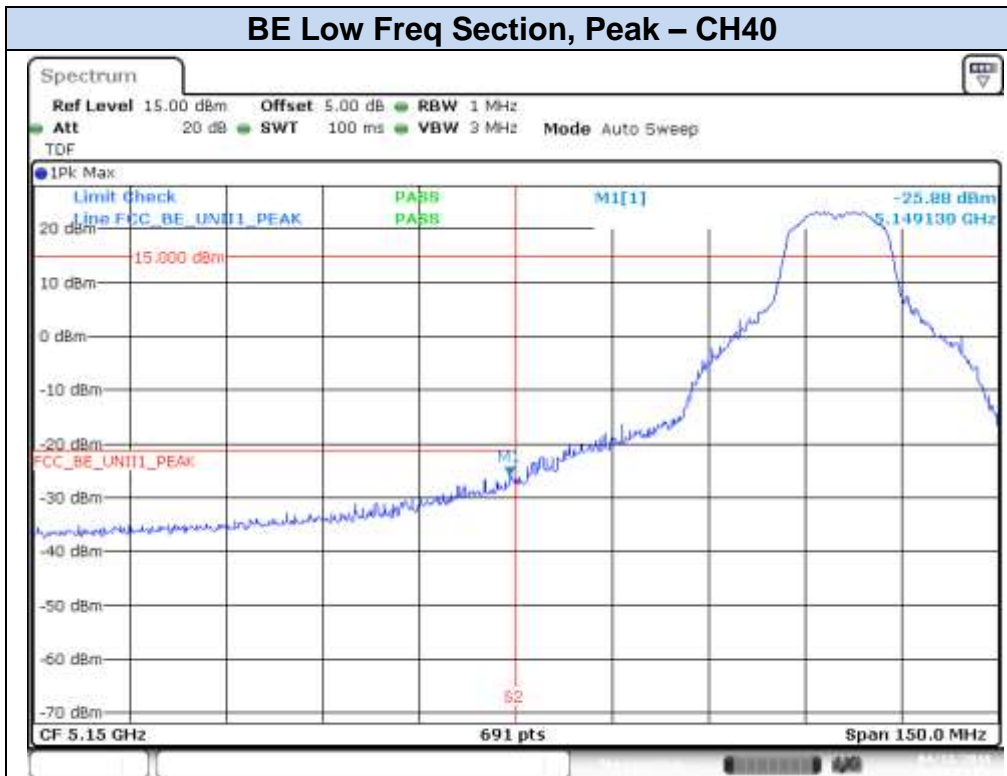

Date 13/4PR/2016 18:32:22

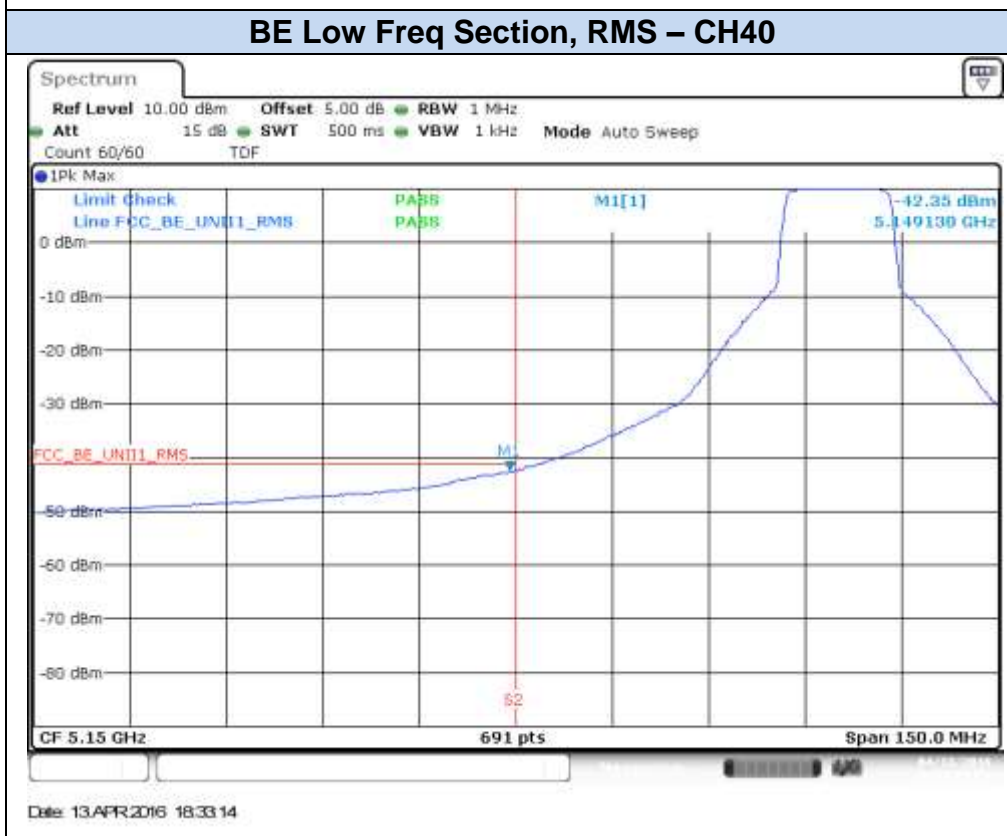

Date 13/4PR/2016 18:33:14

**802.11a, 6Mbps – Chain B**

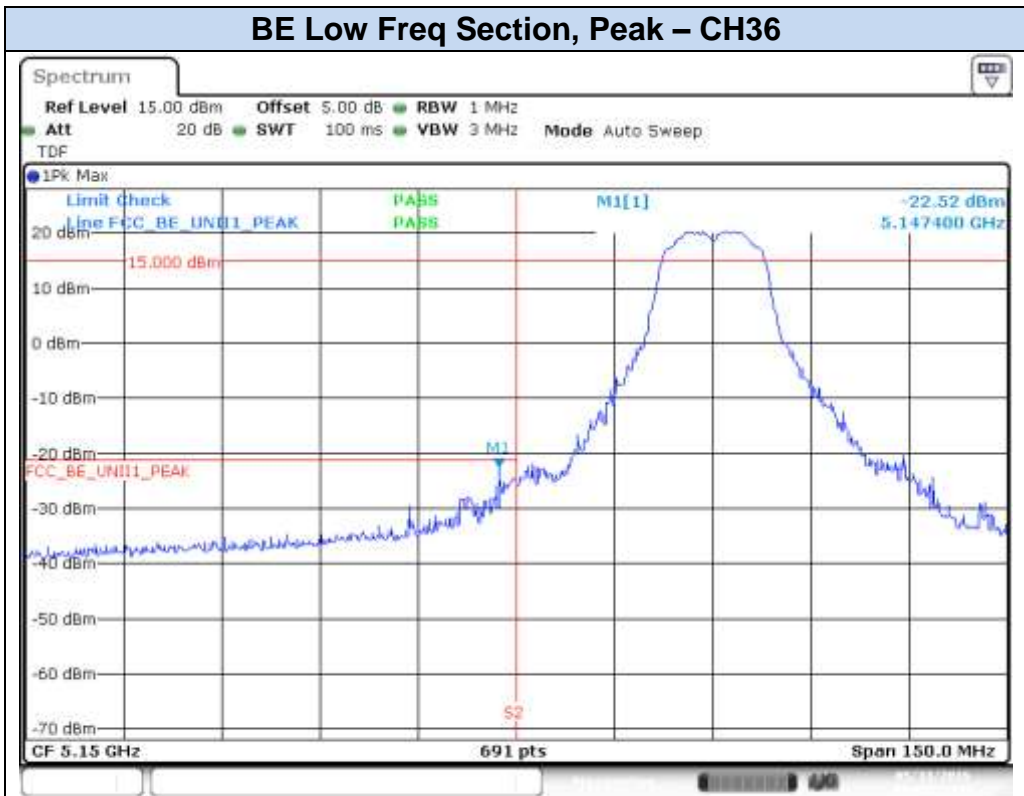

Date: 13.MAY.2016 17:45:24

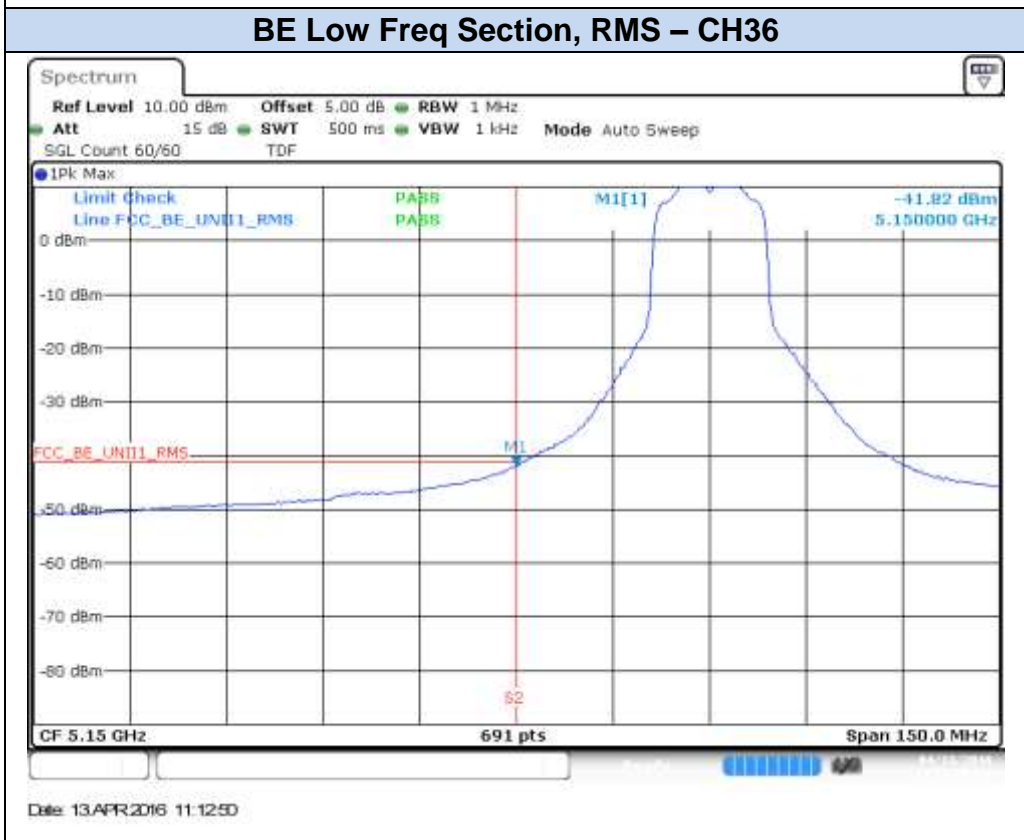

Date: 13.APR.2016 11:12:50

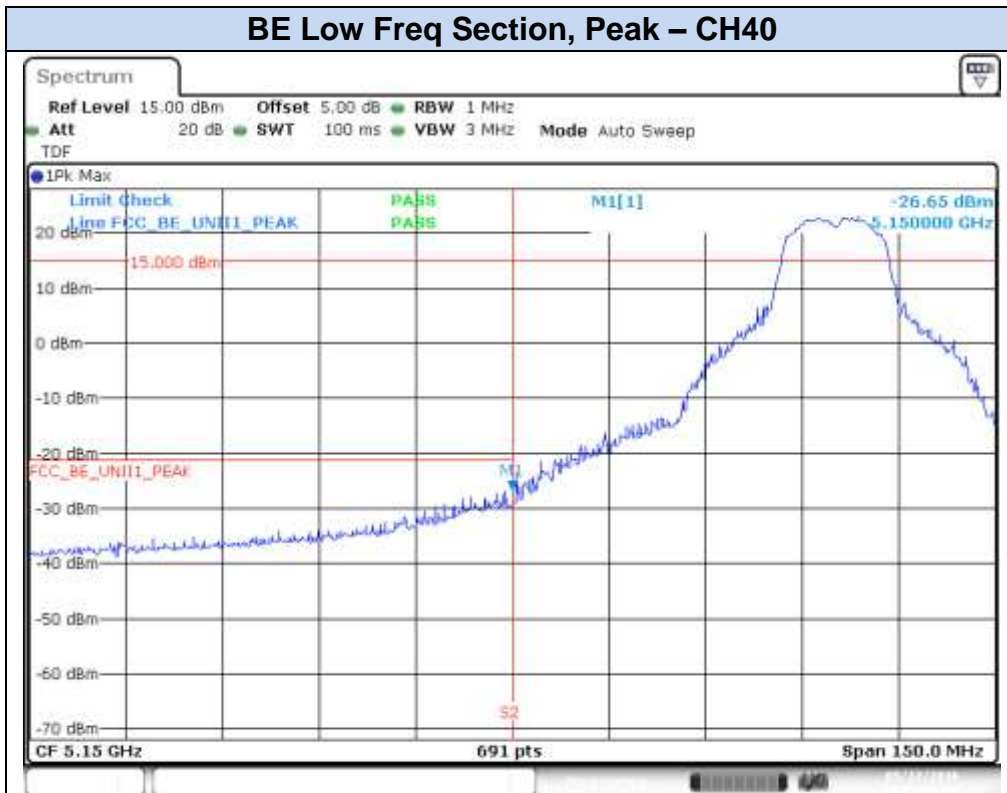

Date: 12 MAY 2016 11:20:42

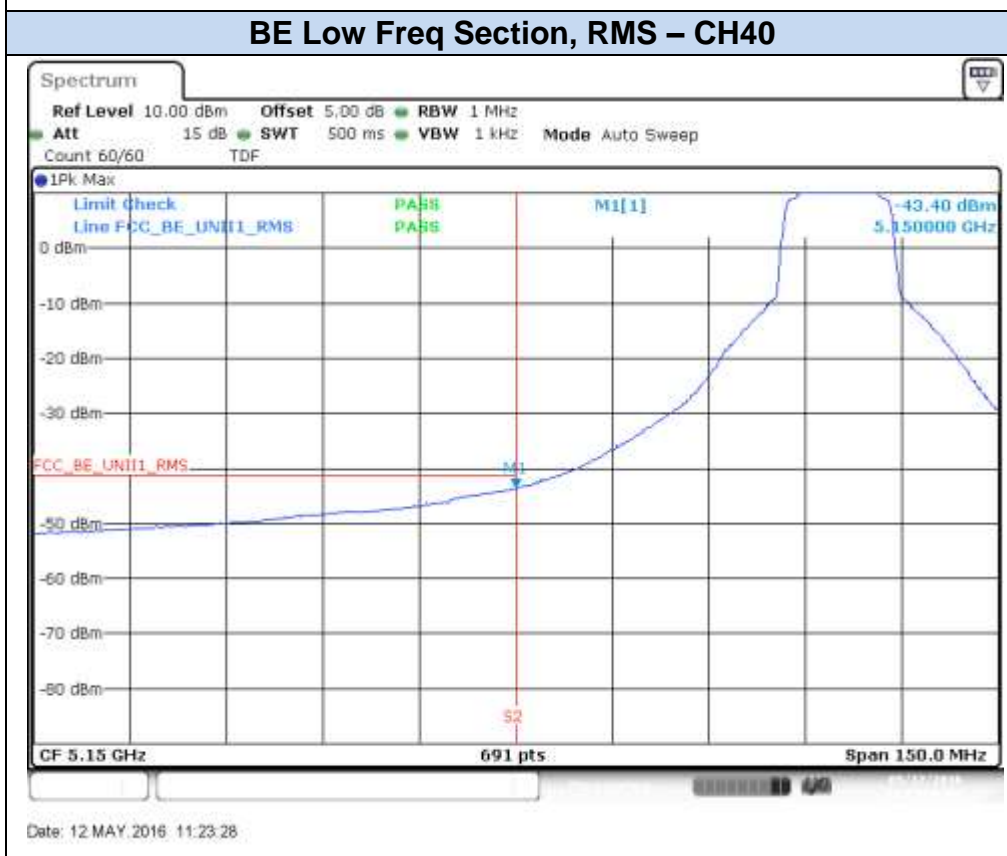

Date: 12 MAY 2016 11:23:28

### 802.11n20, HT0 (SISO) – Chain A

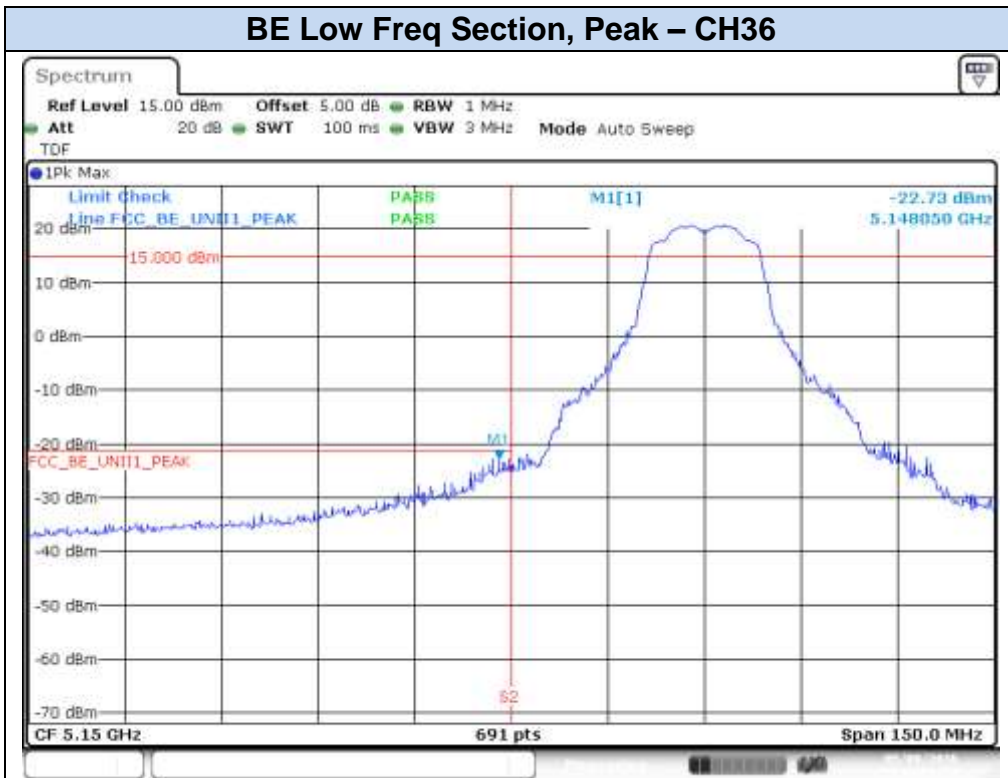

Date: 9.MAY.2016 11:42:02

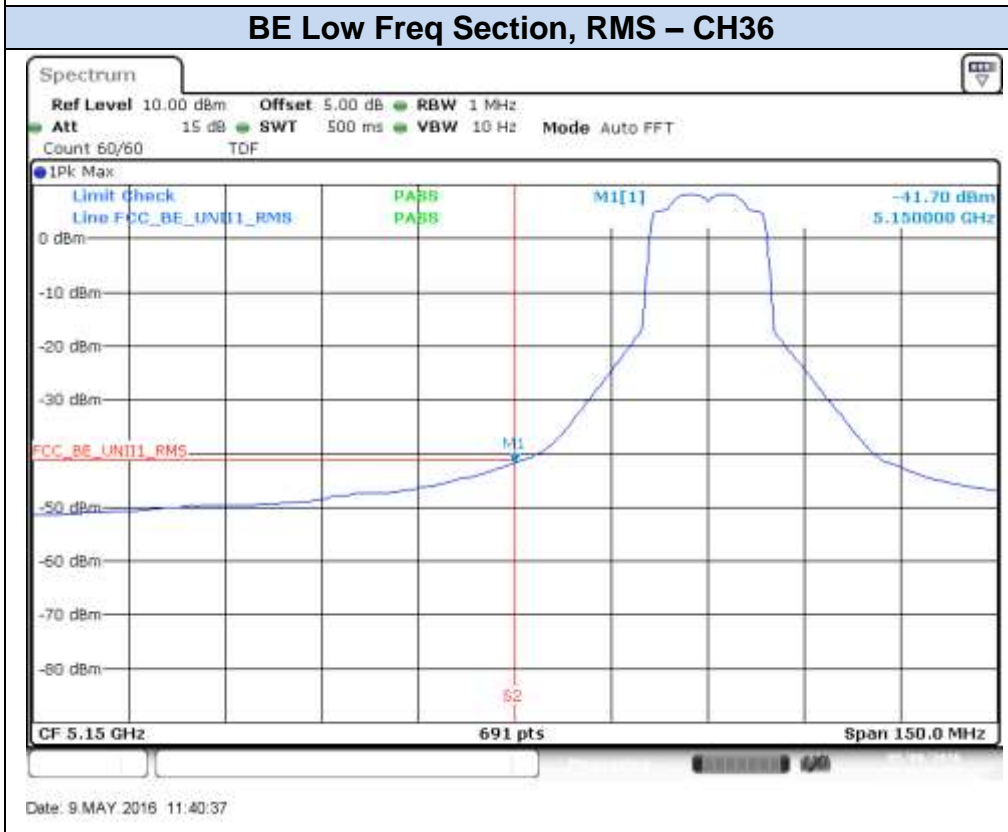

Date: 9.MAY.2016 11:40:37

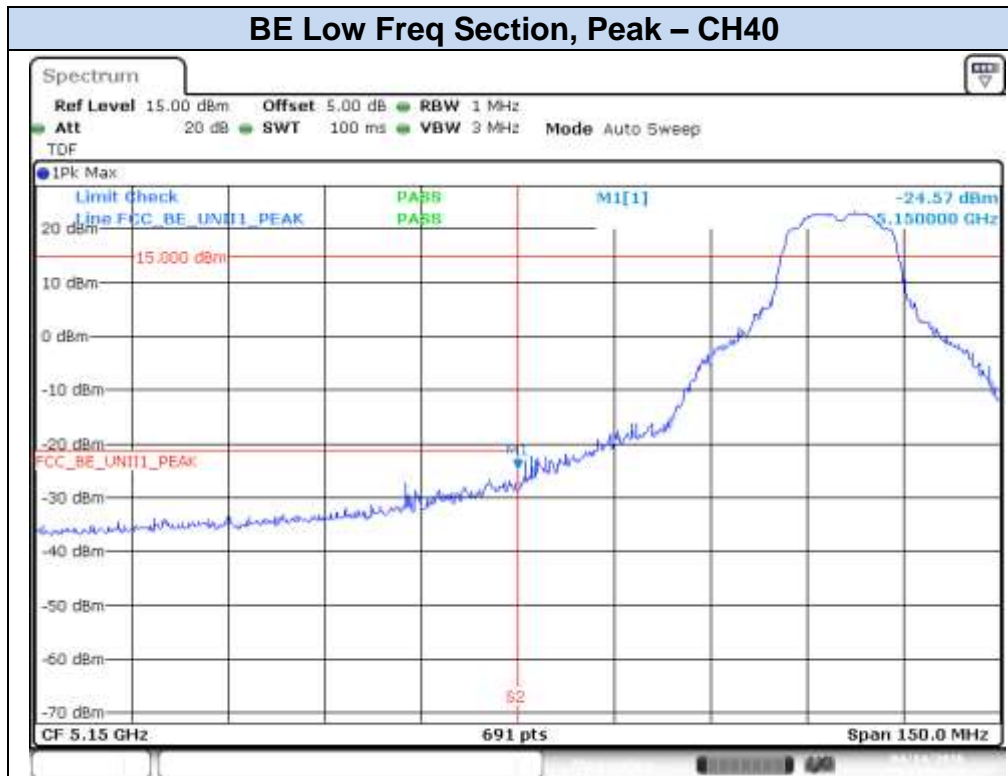

Date: 14.APR.2016 17:22:26

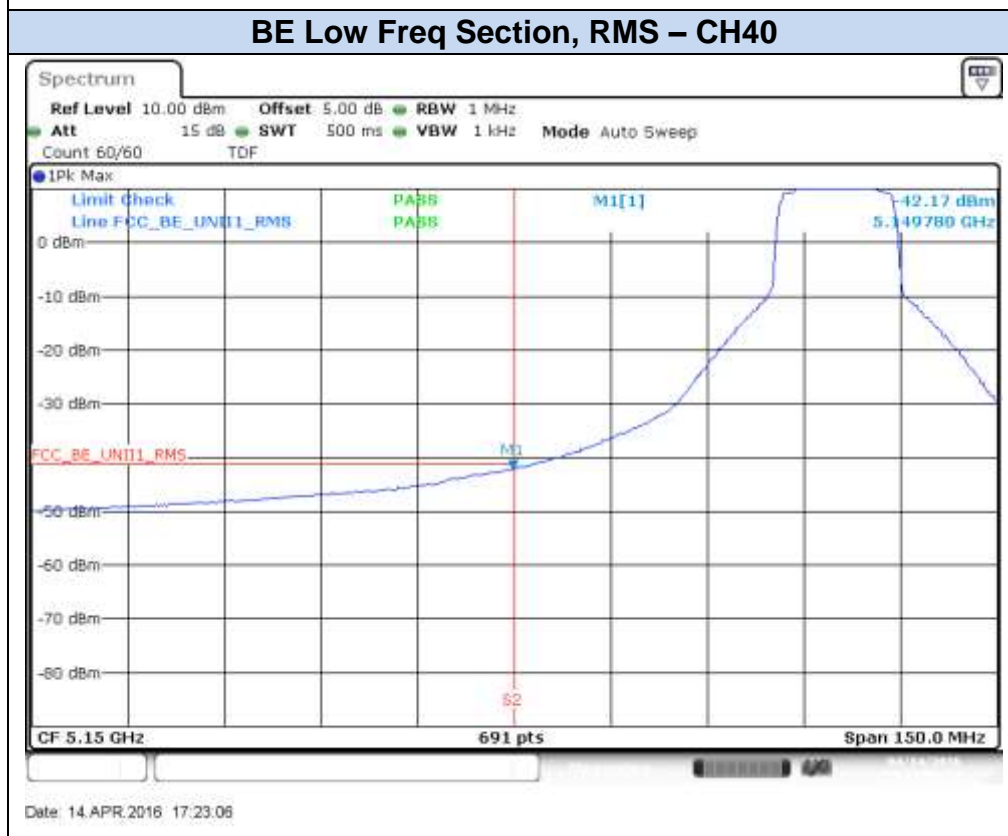

Date: 14.APR.2016 17:23:06

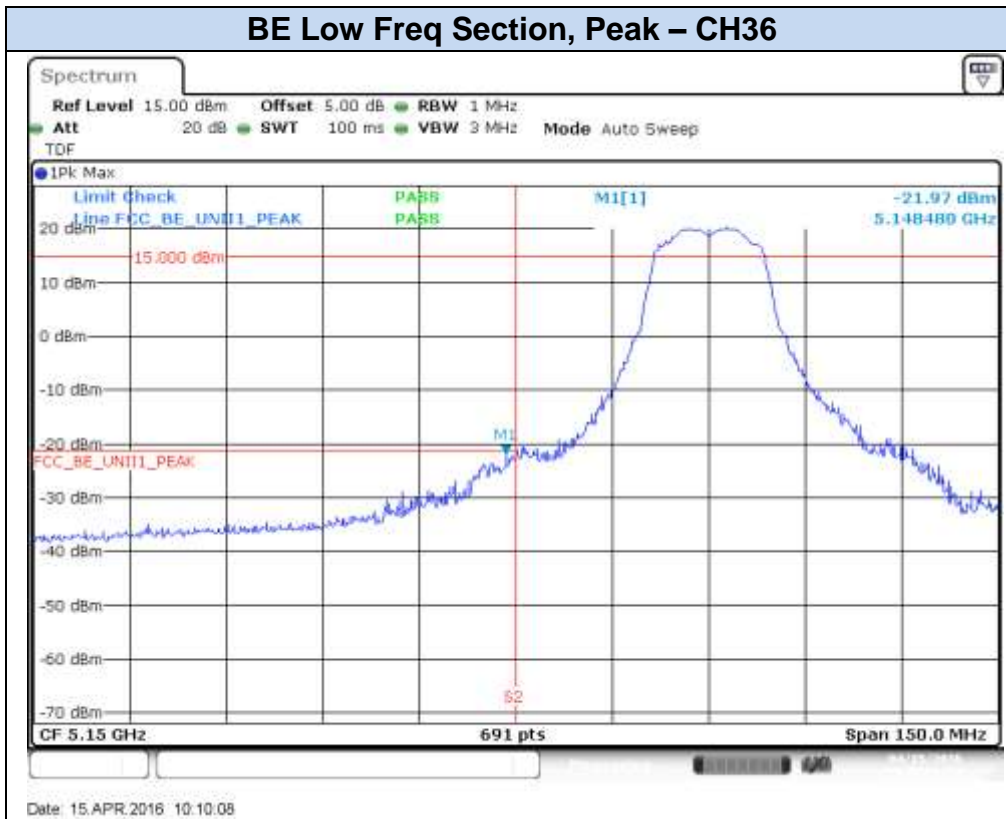
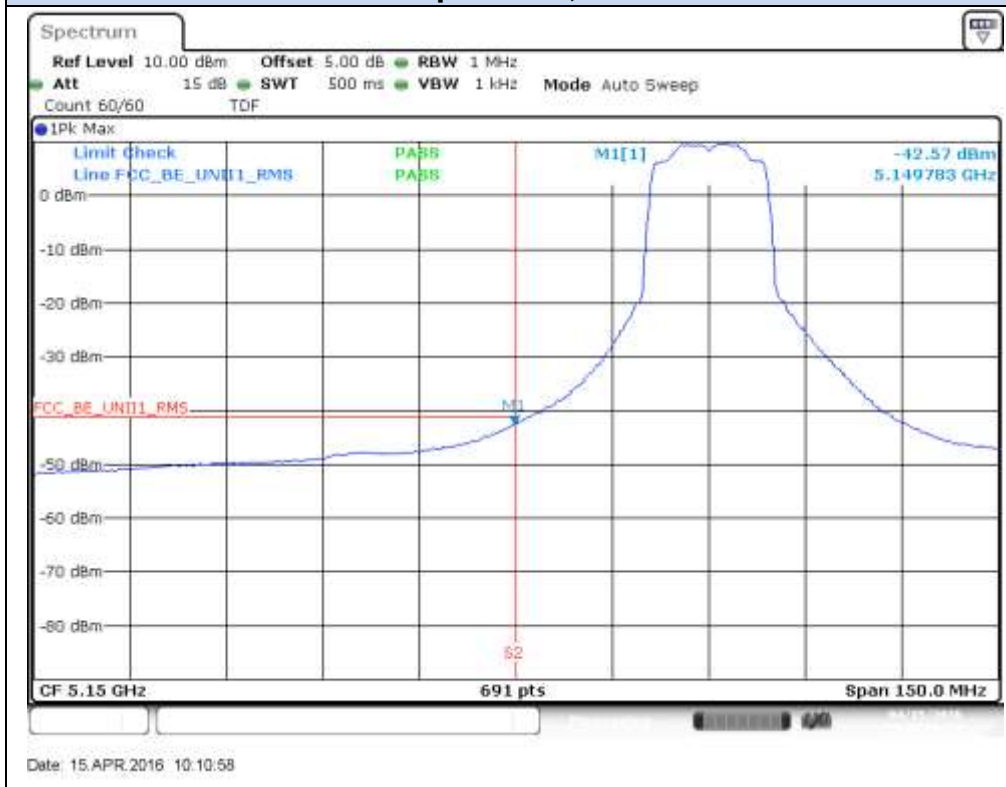
**802.11n20, HT0 (SISO) – Chain B****BE Low Freq Section, Peak – CH36****BE Low Freq Section, RMS – CH36**

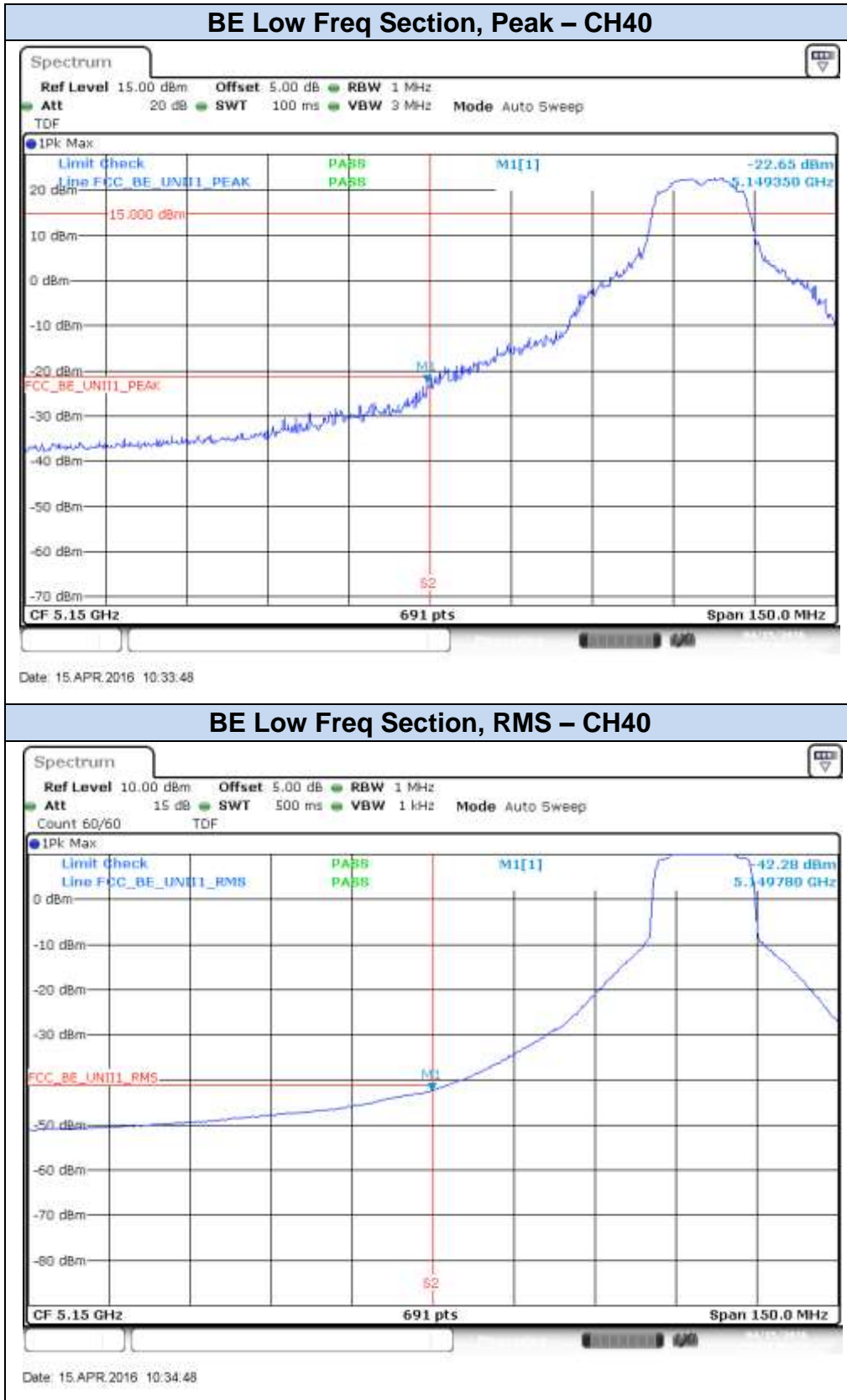

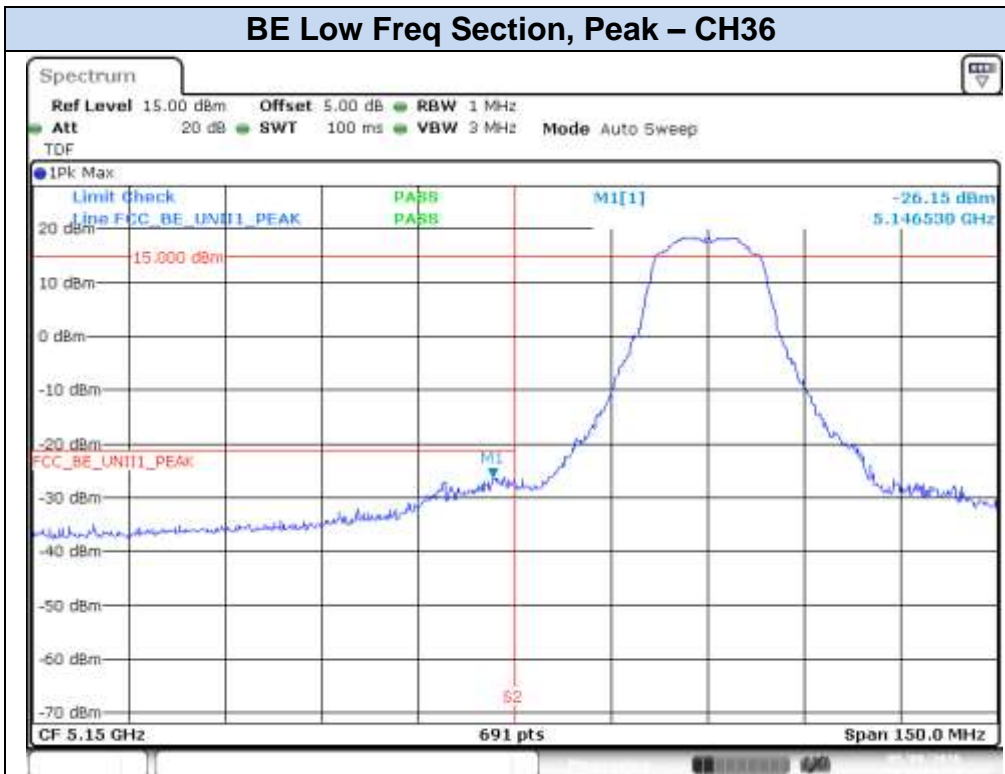
**802.11n20, HT8 (MIMO) – Chain A****BE Low Freq Section, Peak – CH36**

Date: 9 MAY 2016 11:30:19

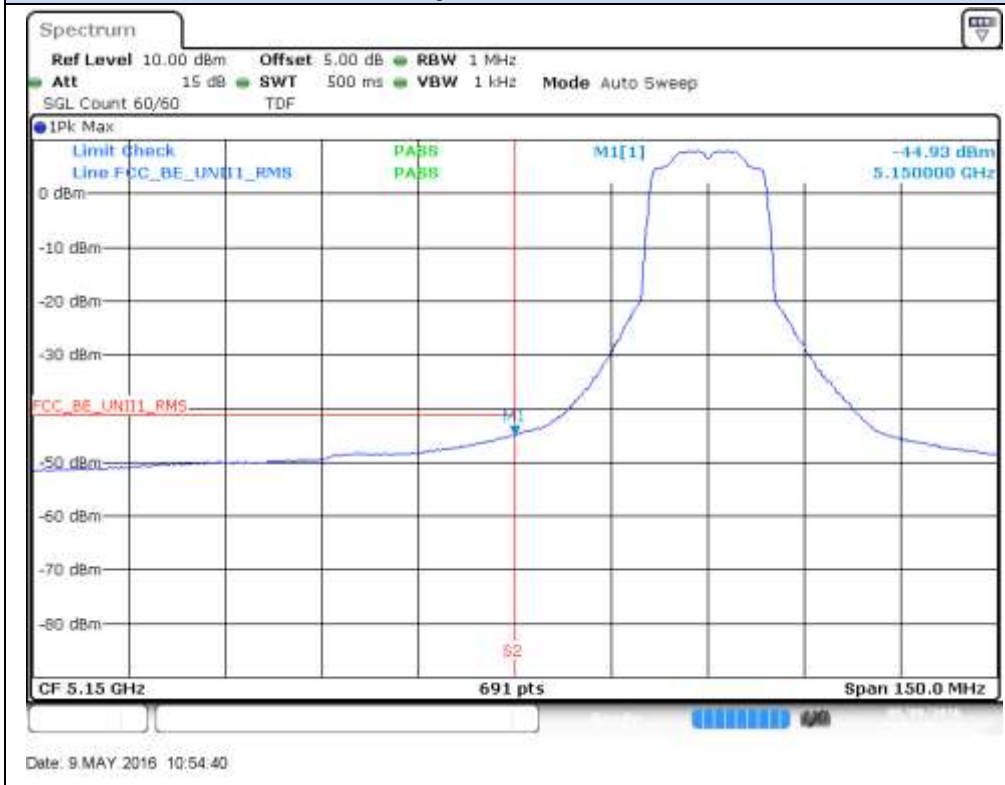
**BE Low Freq Section, RMS – CH36**

Date: 9 MAY 2016 10:54:40



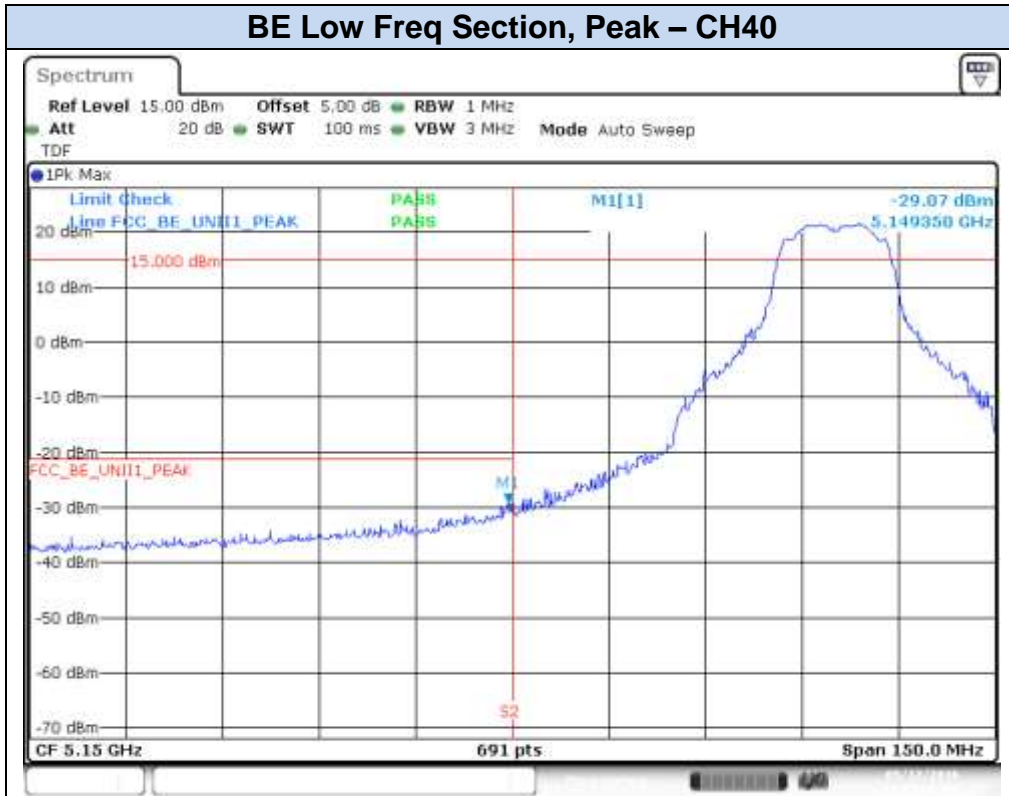

Date: 12 MAY 2016 11:33:23

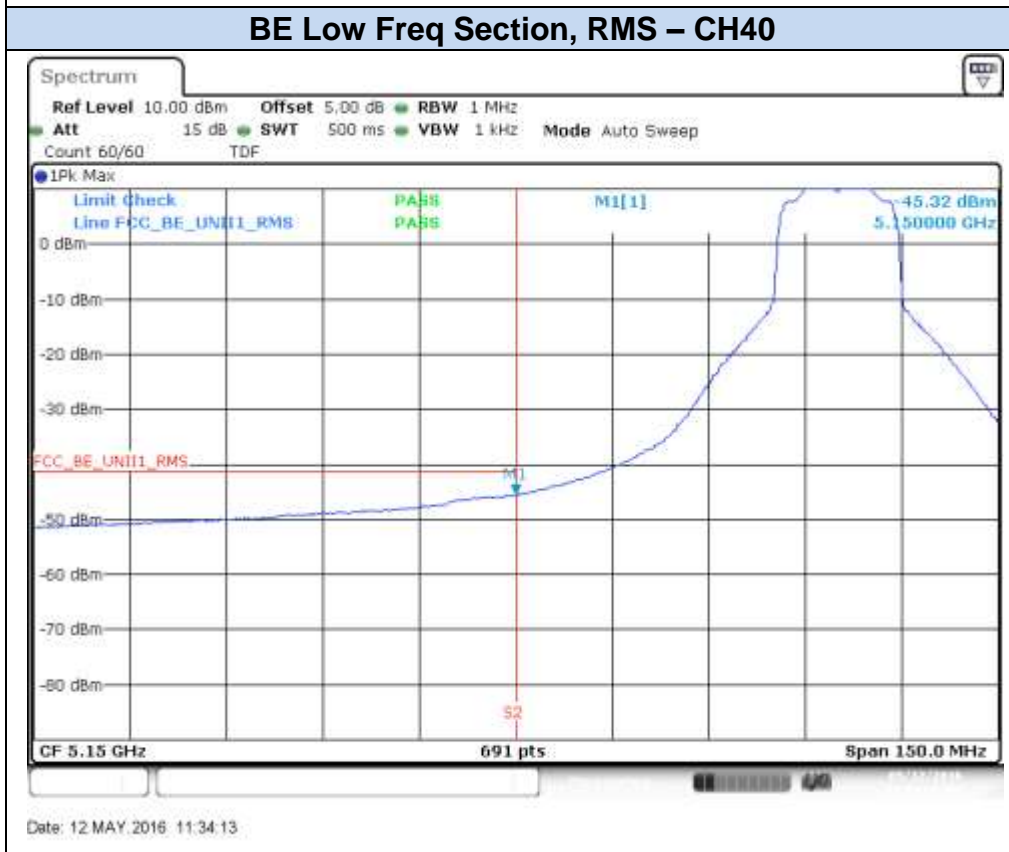

Date: 12 MAY 2016 11:34:13

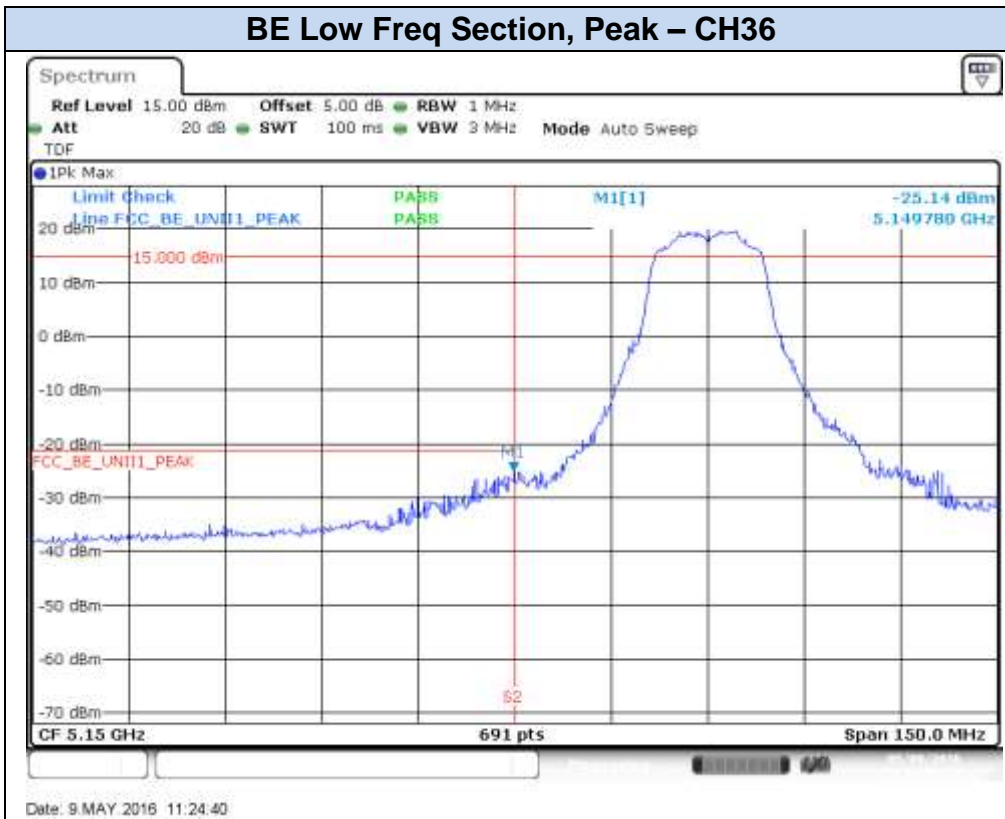
**802.11n20, HT8 (MIMO) – Chain B****BE Low Freq Section, Peak – CH36****BE Low Freq Section, RMS – CH36****BE Low Freq Section, Peak – CH40**

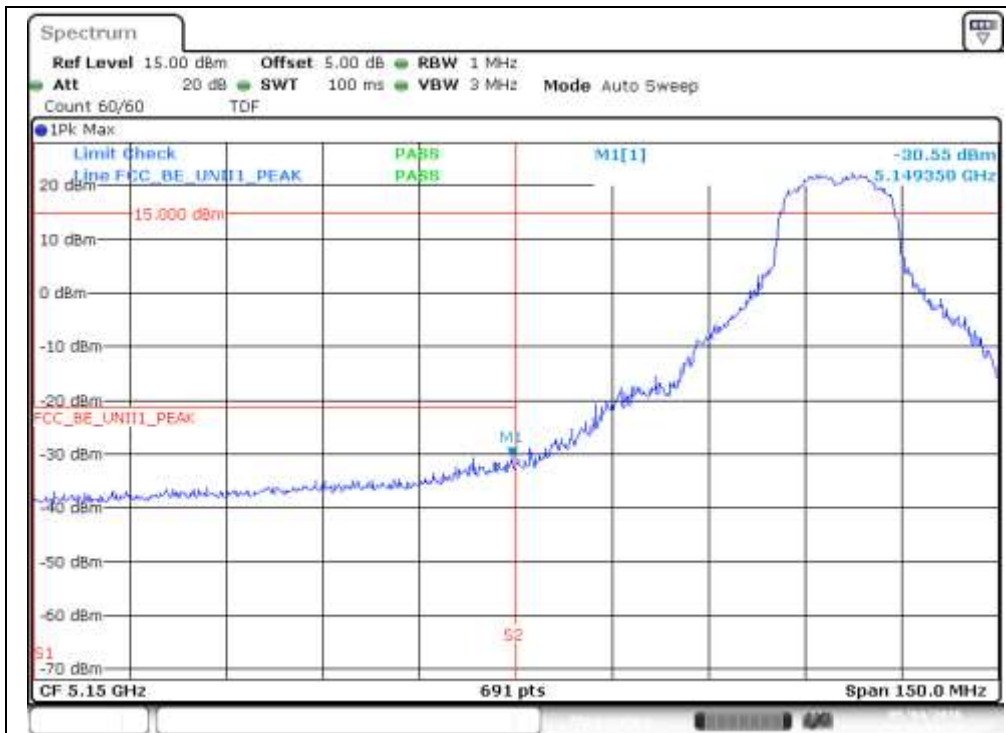

Date: 4 MAY 2016 14:29:39

### BE Low Freq Section, RMS – CH40

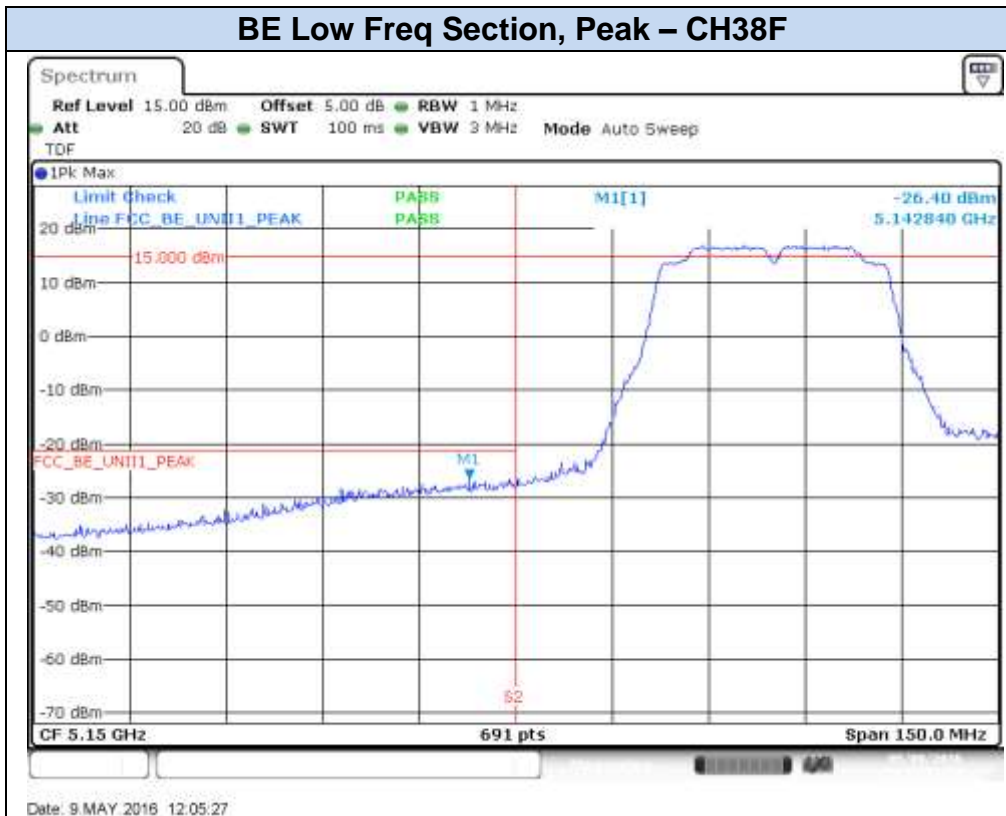

Date: 4 MAY 2016 14:28:13

**802.11n40, HT0 (SISO) – Chain A****BE Low Freq Section, Peak – CH38F****BE Low Freq Section, RMS – CH38F**

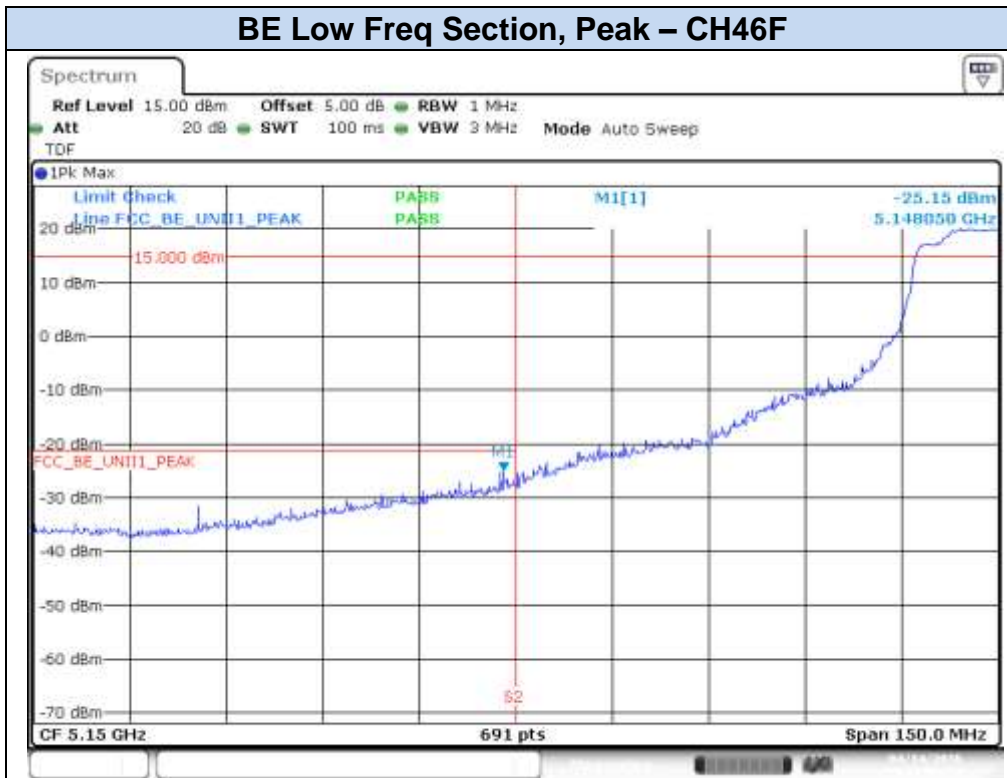

Date: 14.APR.2016 18:10:59

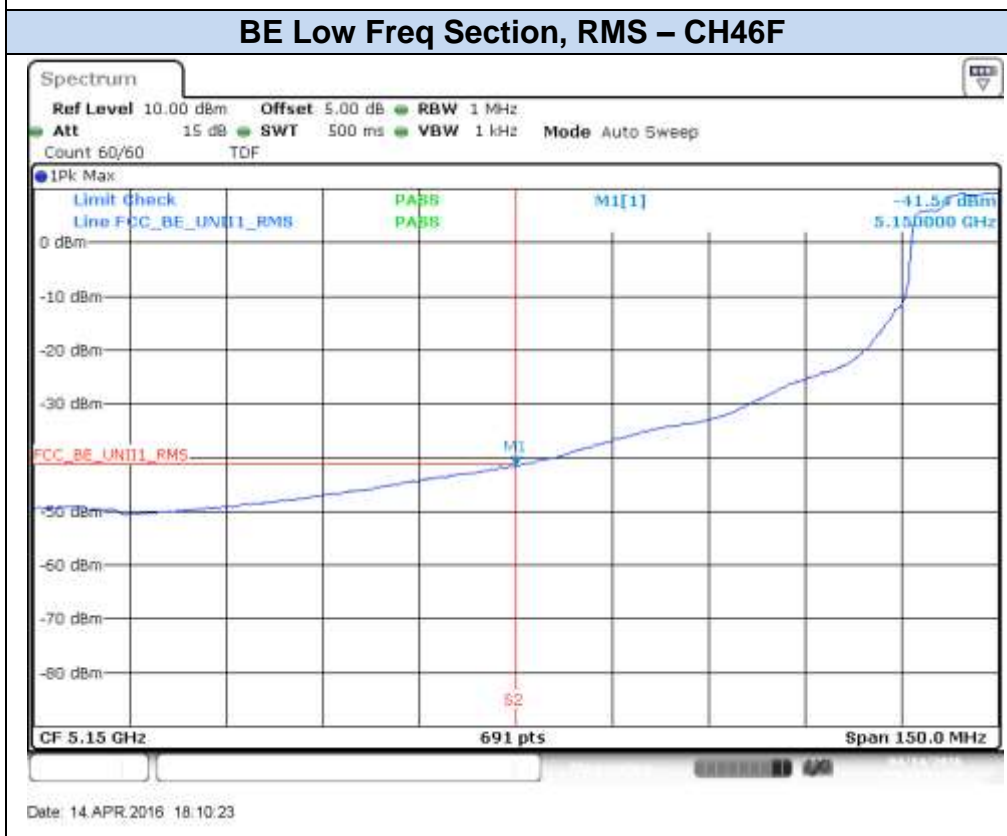

Date: 14.APR.2016 18:10:23

### 802.11n40, HT0 (SISO) – Chain B

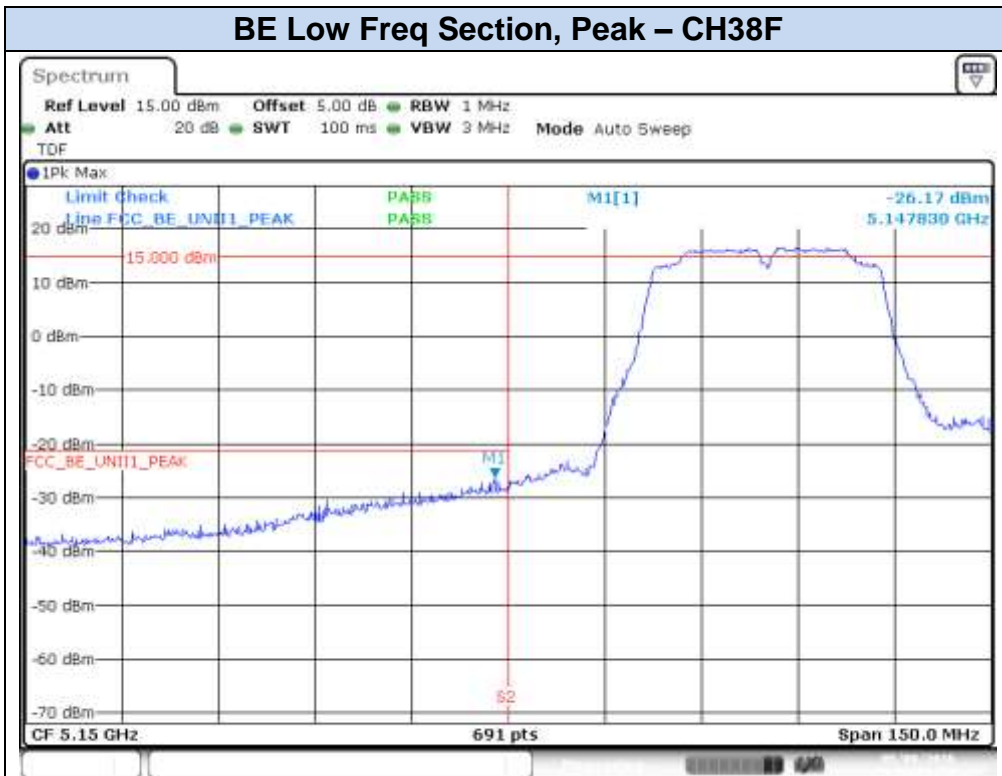

Date: 9 MAY 2016 11:54:20

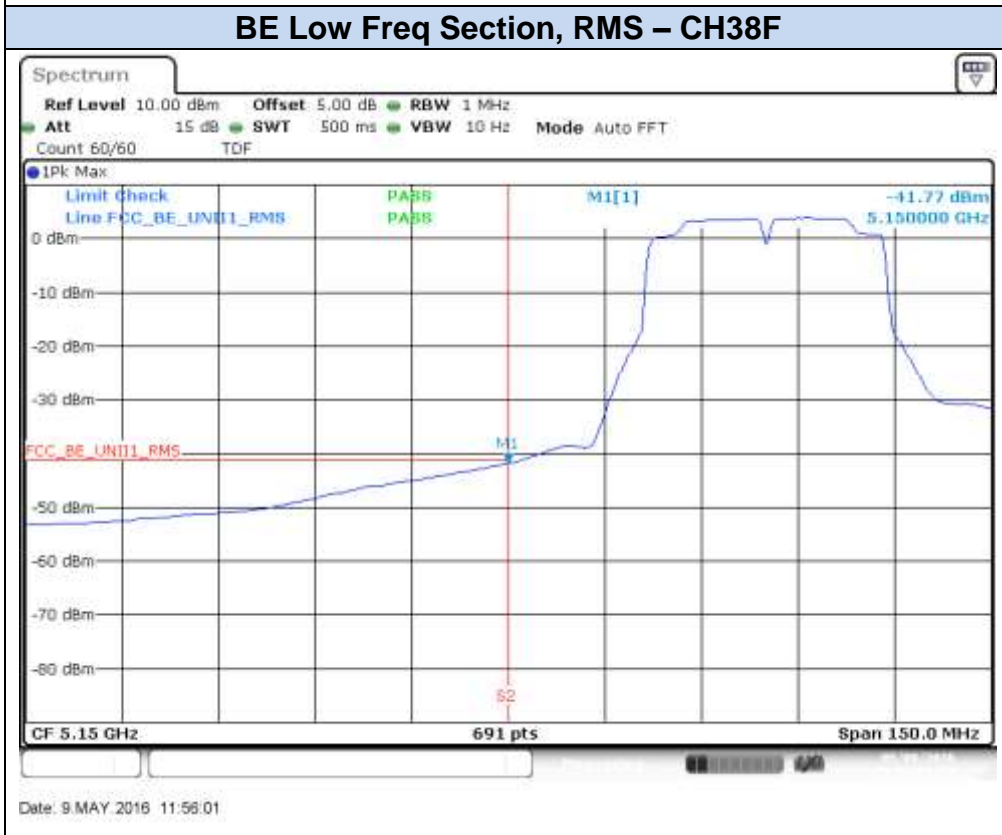

Date: 9 MAY 2016 11:56:01

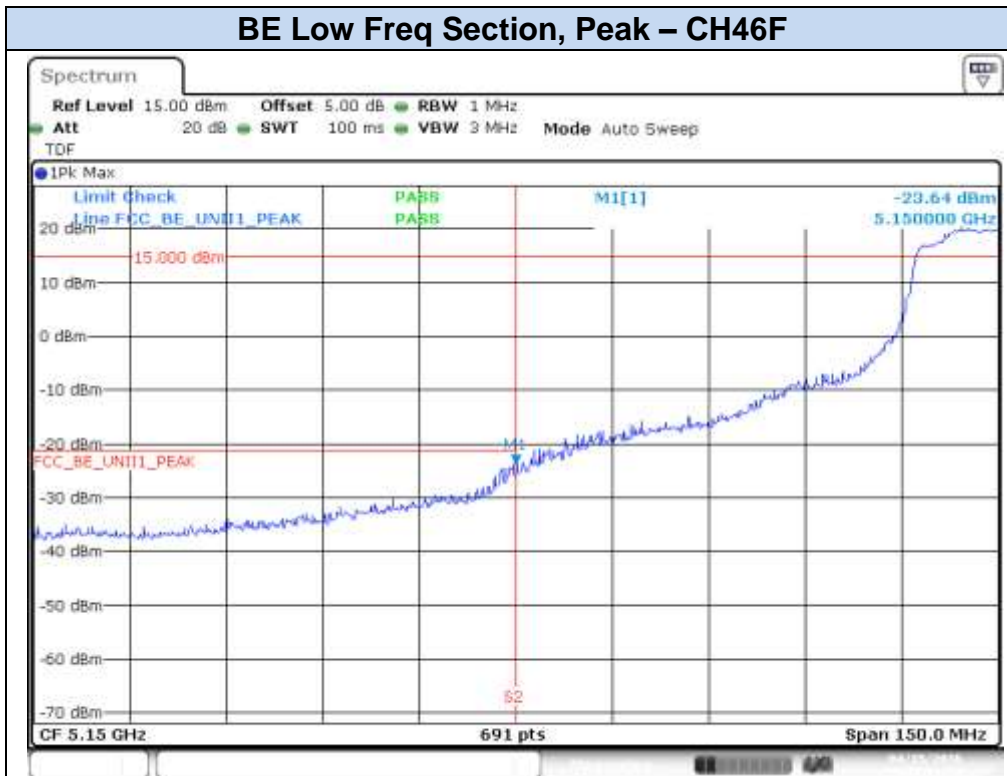

Date: 15.APR.2016 14:45:53

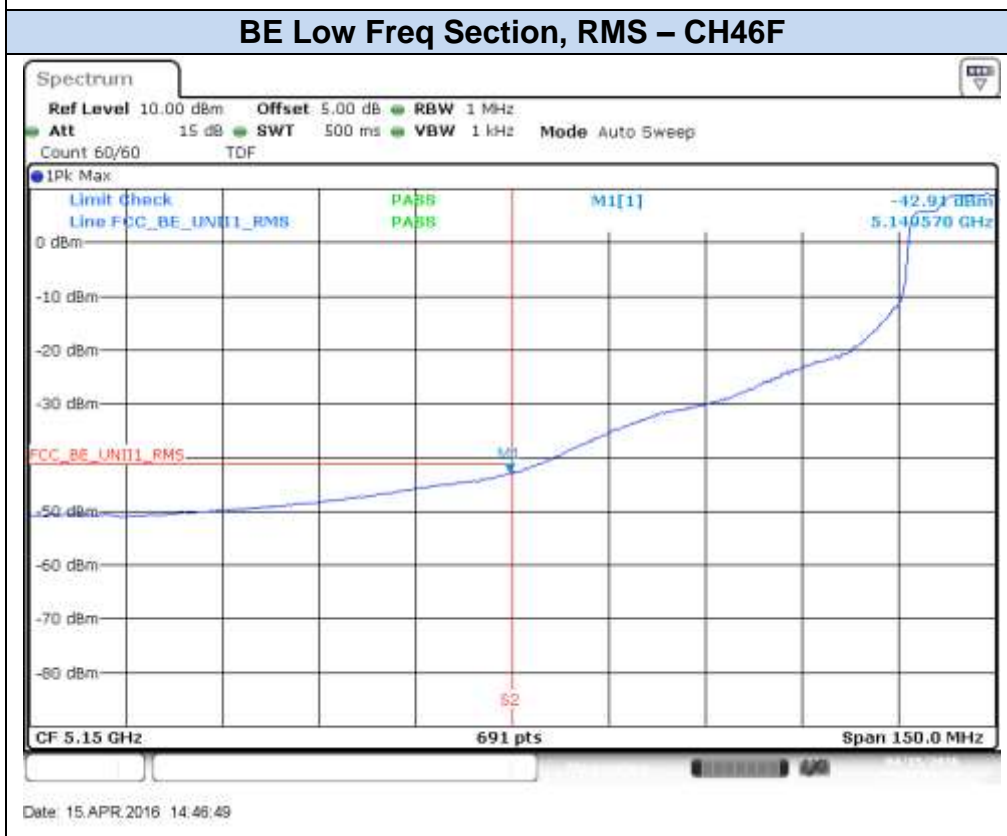

Date: 15.APR.2016 14:46:49

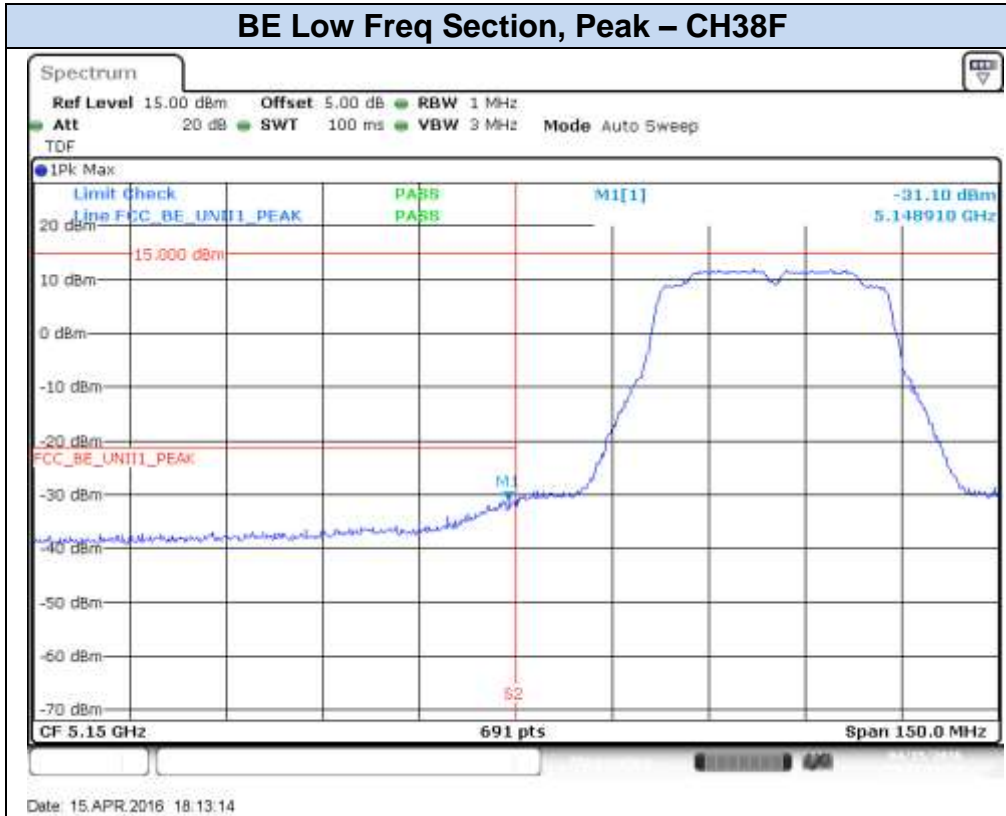
**802.11n40, HT8 (MIMO) – Chain A****BE Low Freq Section, Peak – CH38F****BE Low Freq Section, RMS – CH38F**



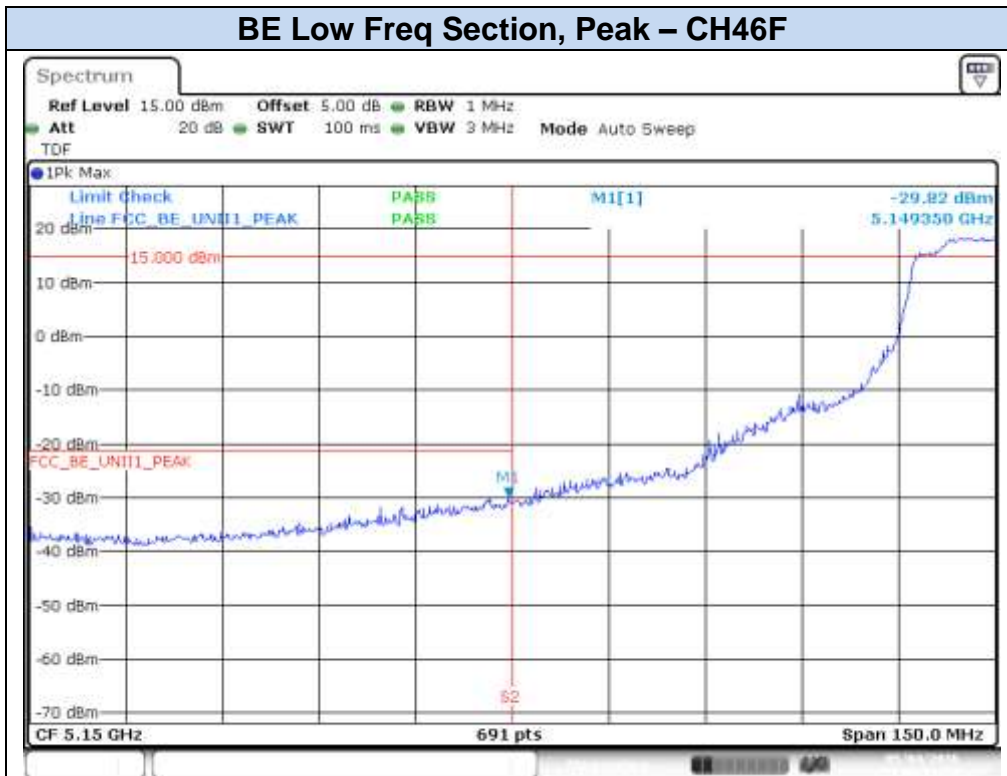

Date: 4 MAY 2016 15:02:17

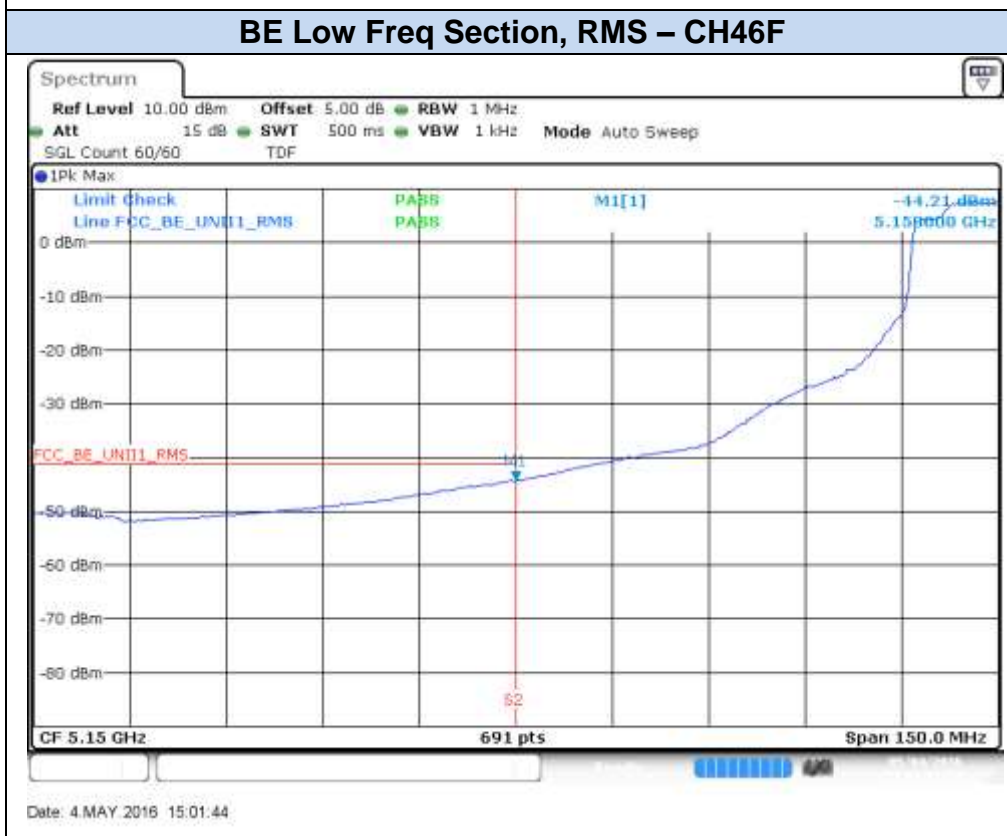

Date: 4 MAY 2016 15:01:44

### 802.11n40, HT8 (MIMO) – Chain B

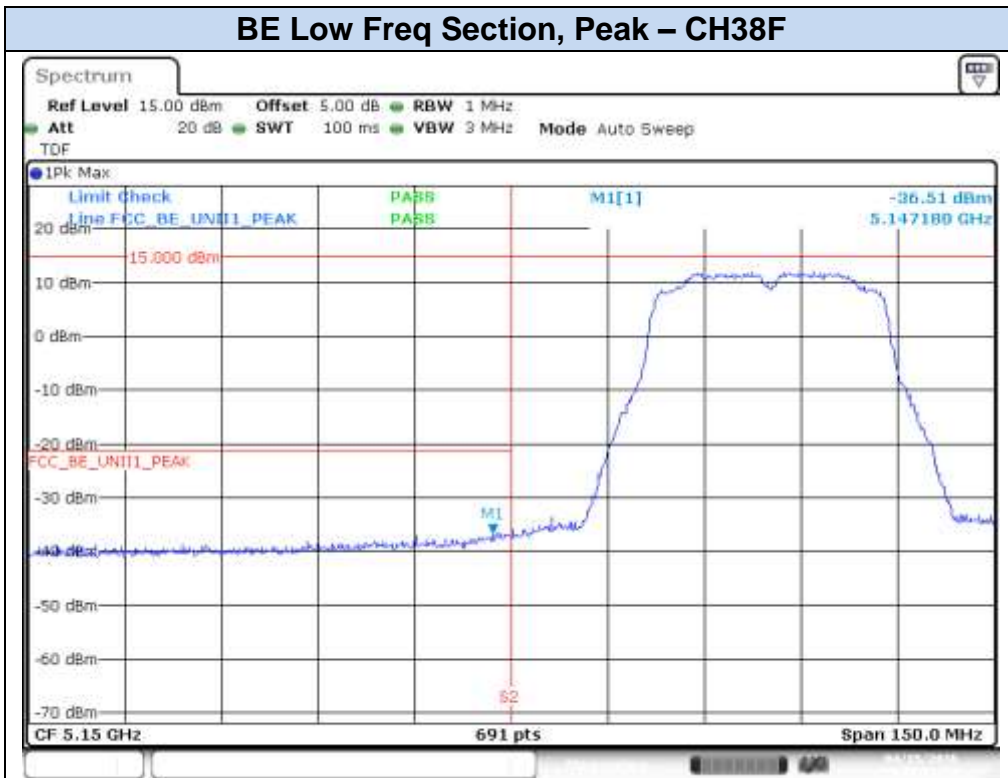

Date: 15.APR.2016 18:19:58

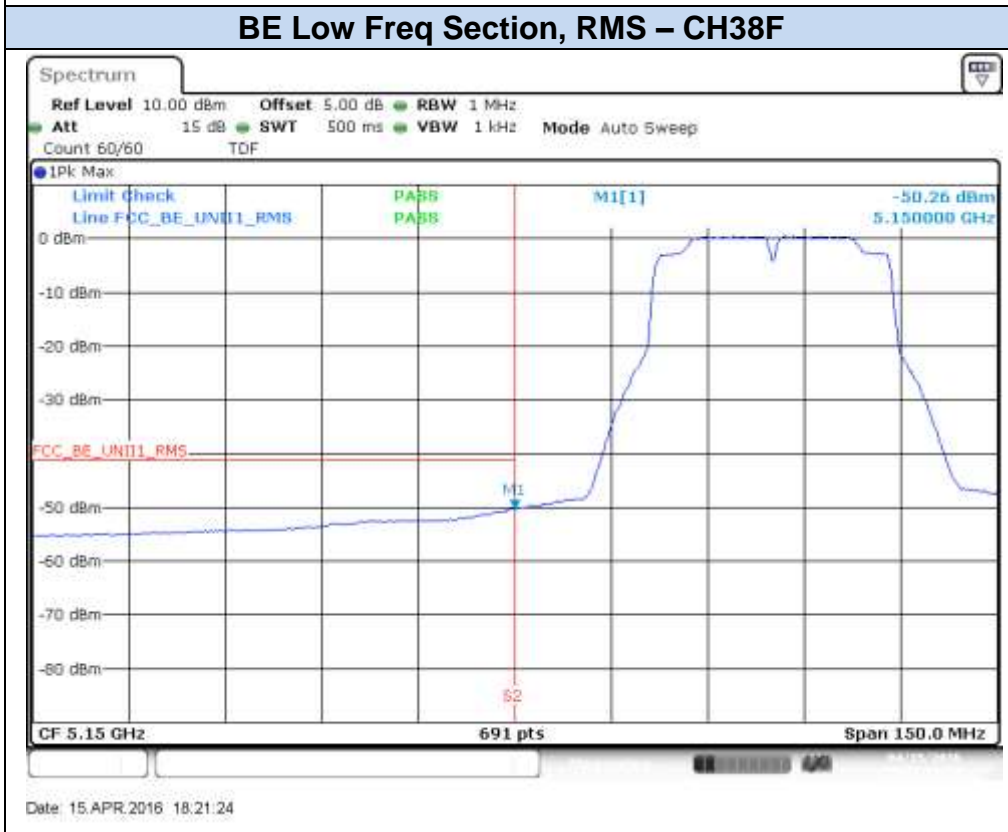

Date: 15.APR.2016 18:21:24

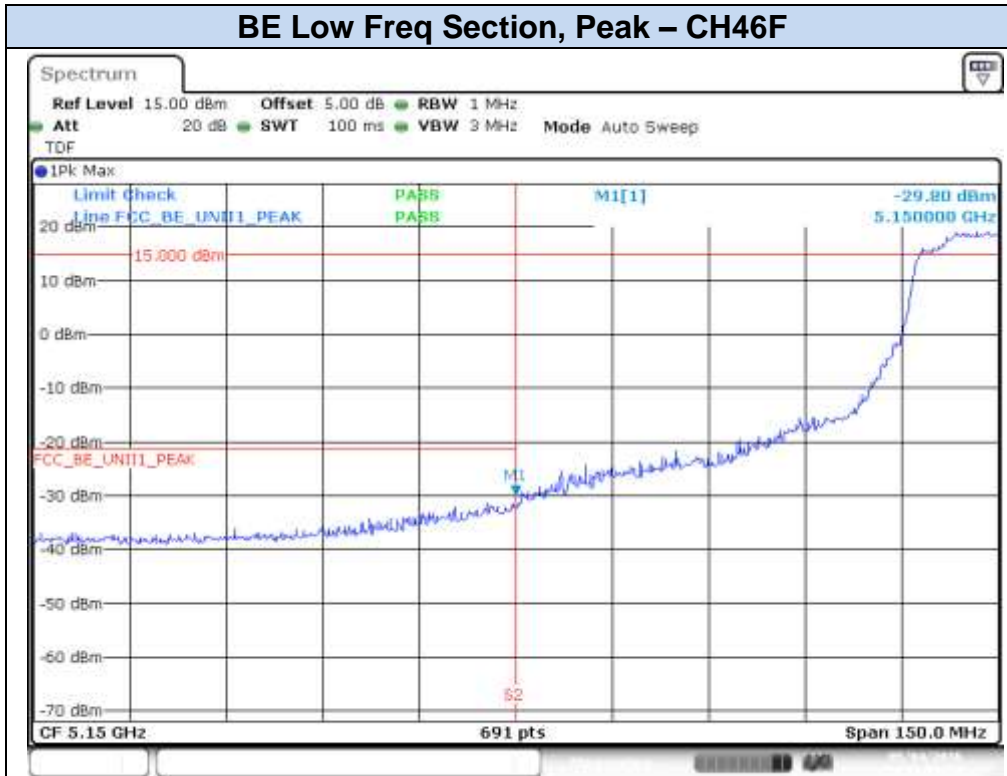

Date: 4 MAY 2016 15:21:54

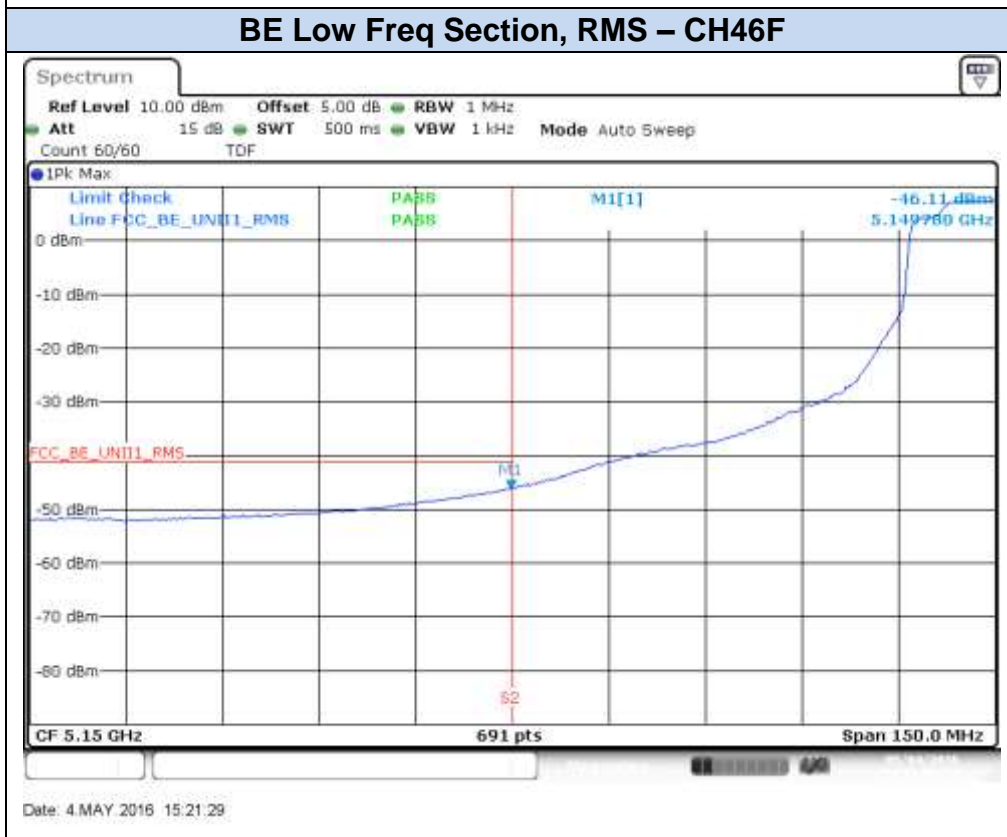

Date: 4 MAY 2016 15:21:29

### 802.11ac80, VHT0 (SISO)- Chain A

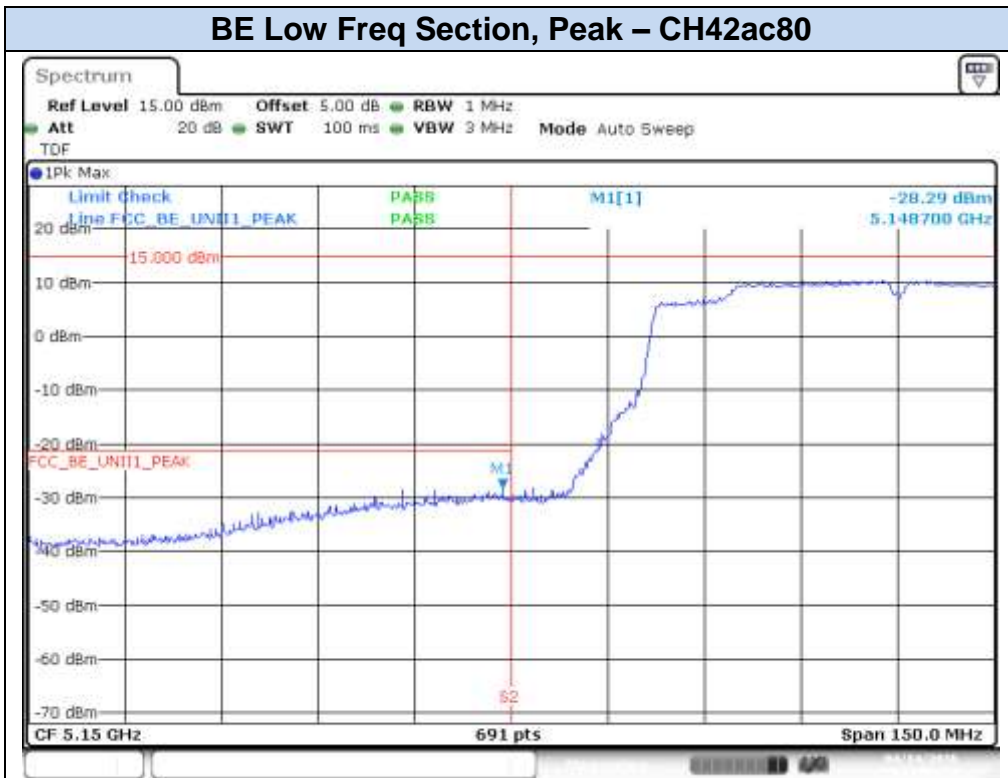

Date: 14.APR.2016 18:18:00

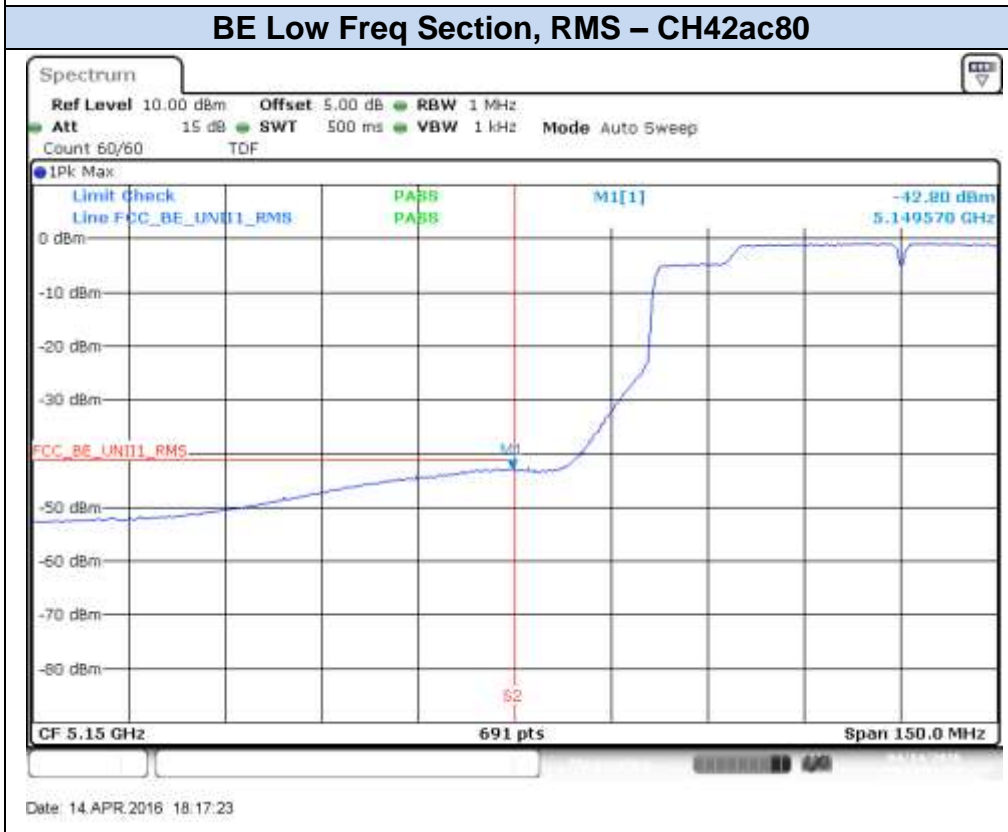

Date: 14.APR.2016 18:17:23

### 802.11ac80, VHT0 (SISO)- Chain B

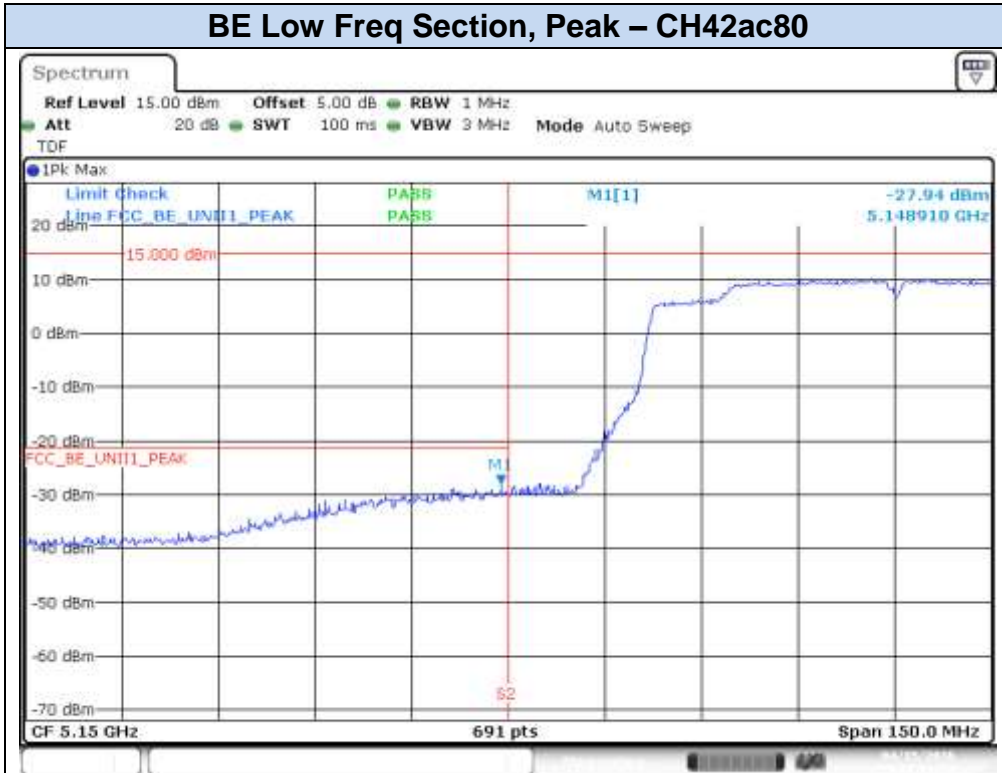

Date: 15.APR.2016 15:14:32

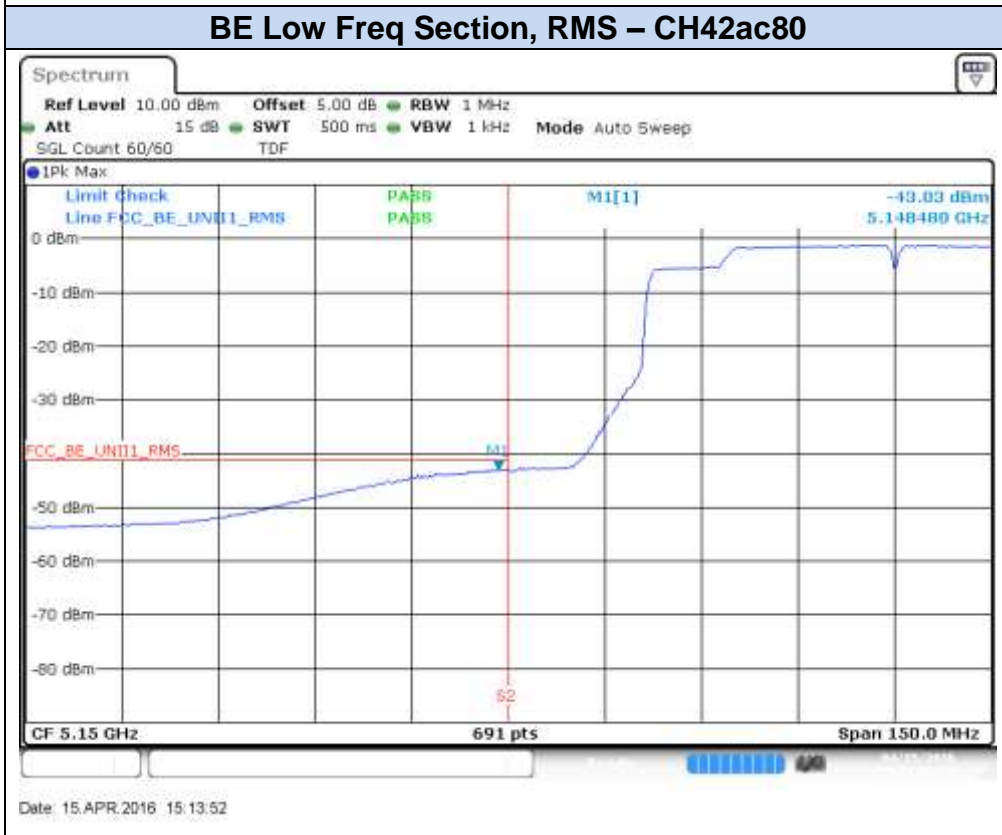

Date: 15.APR.2016 15:13:52

### 802.11ac80, VHT0 (MIMO)- Chain A

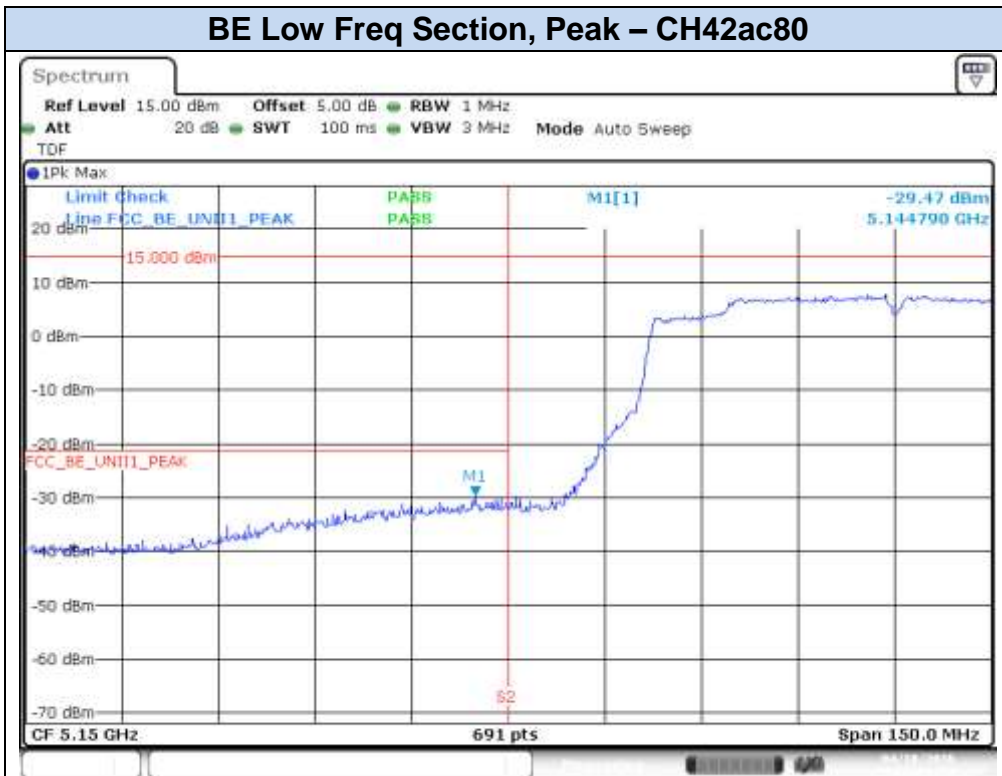

Date: 18.APR.2016 10:55:03

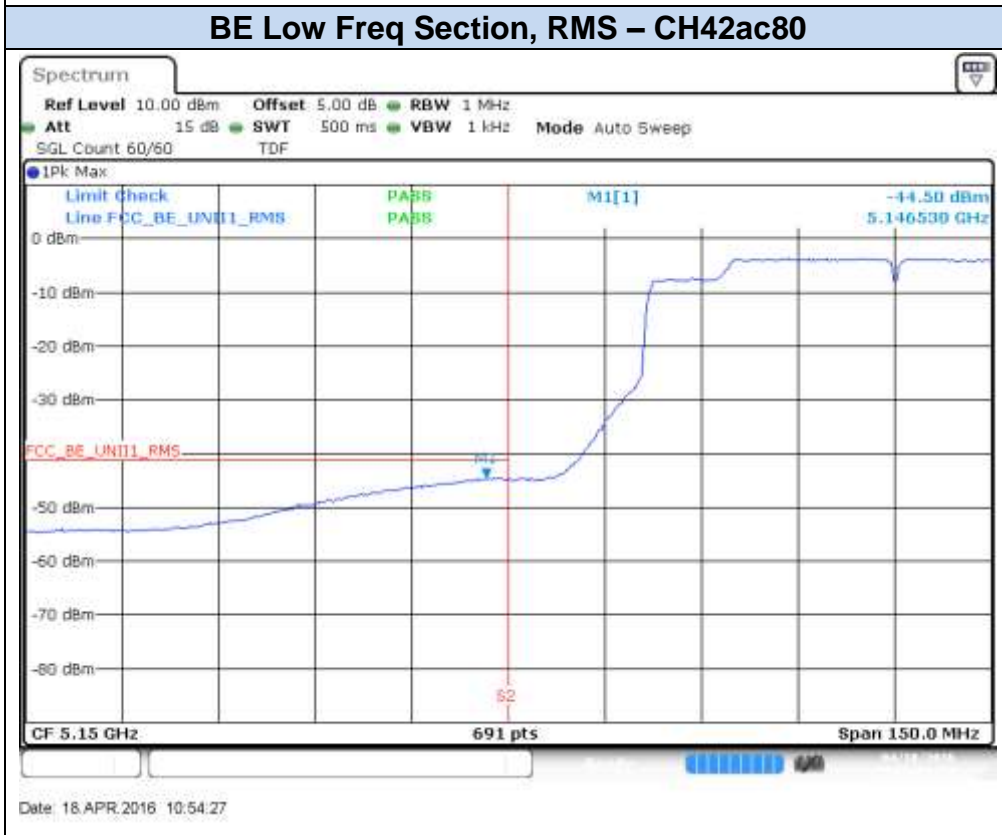

Date: 18.APR.2016 10:54:27

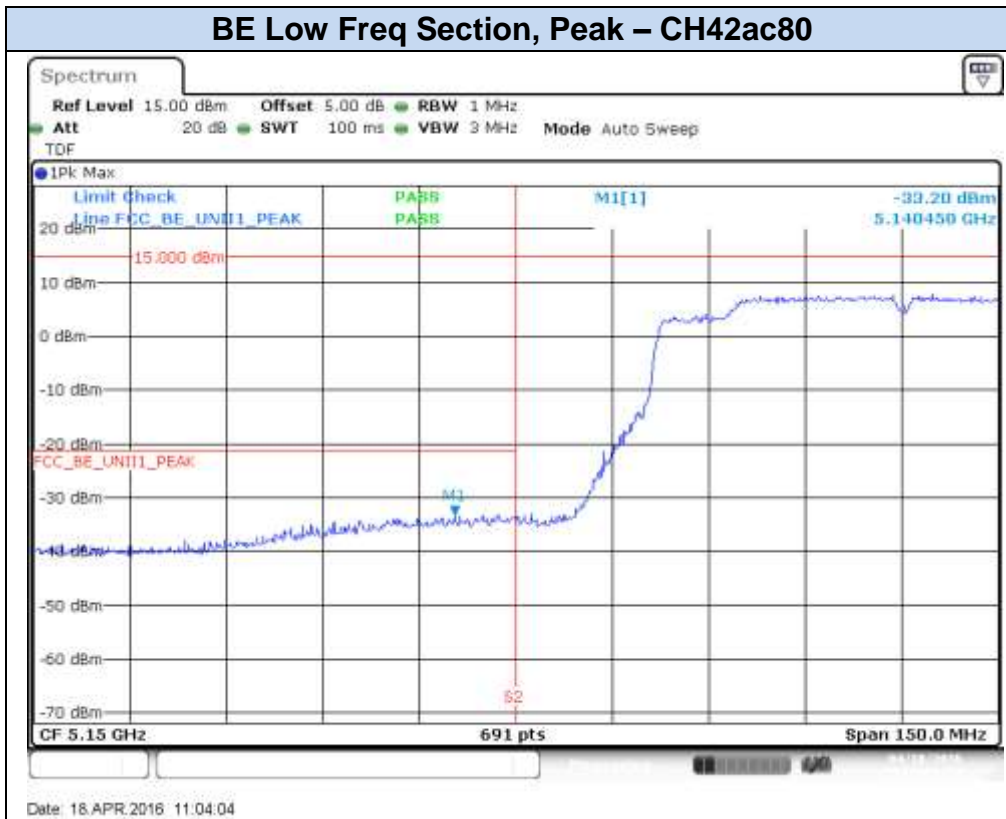
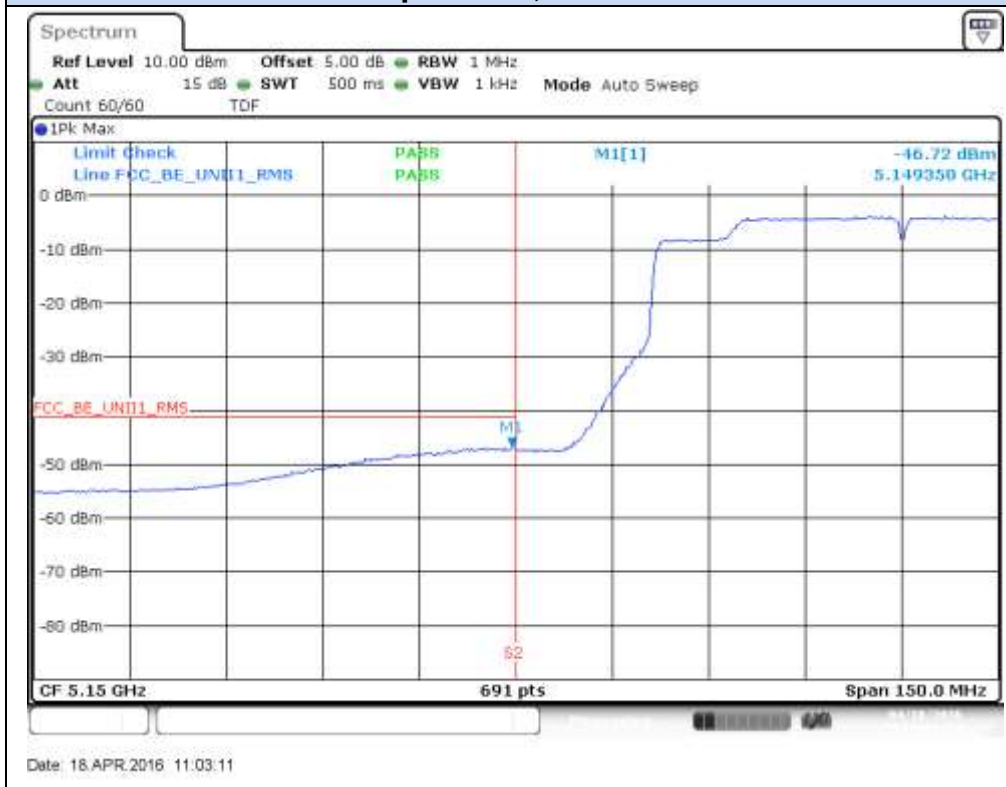
**802.11ac80, VHT0 (MIMO)- Chain B****BE Low Freq Section, Peak – CH42ac80****BE Low Freq Section, RMS – CH42ac80**

## B.4 Radiated spurious emission

### Standard references

FCC part	Limits			
15.247 (d)	Radiated emissions which fall in the restricted bands, as defined in §15.205(a), must also comply with the radiated emission limits specified in §15.209(a):			
	Freq Range (MHz)	Field Strength ( $\mu\text{V/m}$ )	Field Strength ( $\text{dB}\mu\text{V/m}$ )	Meas. Distance (m)
	0.009-0.490	2400/f(kHz)	-	300
	0.490-1.705	24000/f(kHz)	-	300
	1.705-30.0	30	-	30
	30-88	100	40	3
	88-216	150	43.5	3
	216-960	200	46	3
	Above 960	500	54	3
	The emission limits shown in the above table are based on measurements employing CISPR quasi-peak detector except for the frequency bands 9-90 kHz, 110-490 kHz and above 1000 MHz. Radiated emission limits in these three bands are based on measurements employing an average detector. For average radiated emission measurements above 1000 MHz, there is also a limit specified when measuring with peak detector function, corresponding to 20 dB above the indicated values in the table.			

### Test procedure

The setup below was used to measure the radiated spurious emissions.

Depending of the frequency range and bands being tested, different antennas and filters were used.

The final measurement is done by varying the antenna height, the EUT azimuth over 360° and for both Vertical and Horizontal polarizations.

The radiated spurious emission was measured on the worst case configuration selected from the chapter B.2 and using the low, middle and high channel.

#### *Radiated Setup < 1GHz*

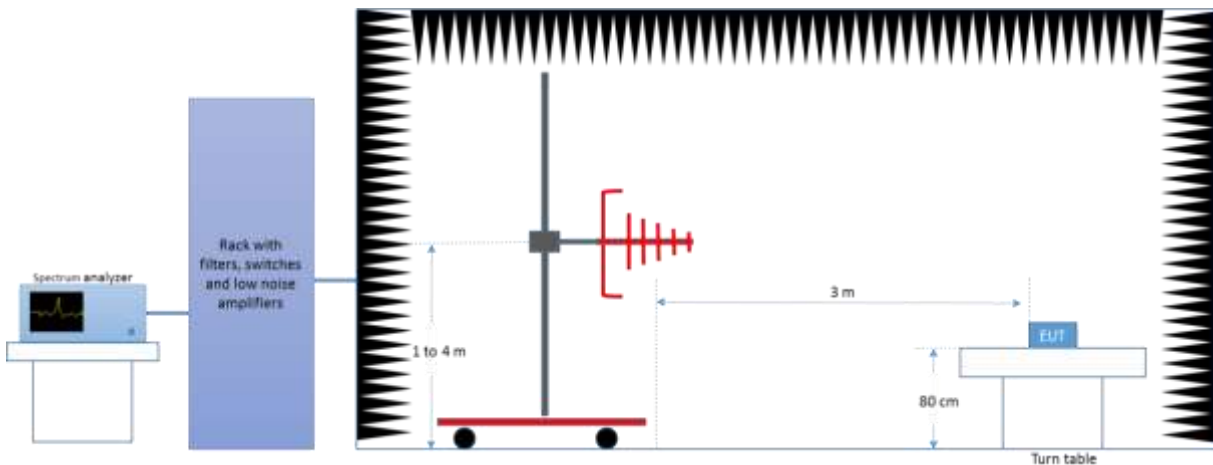



*Radiated Setup 1 GHz - 18 GHz*

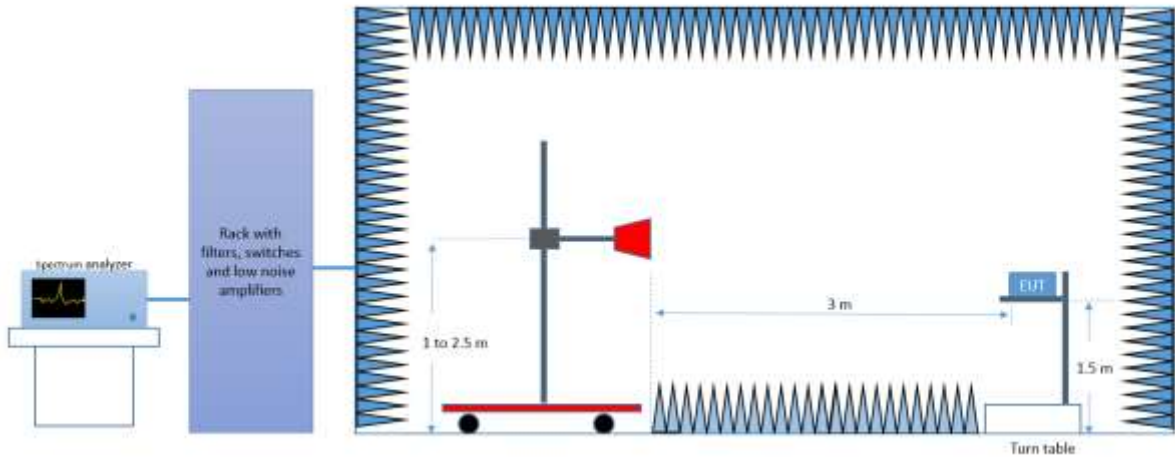

*Radiated Setup 18 GHz - 26.5 GHz*

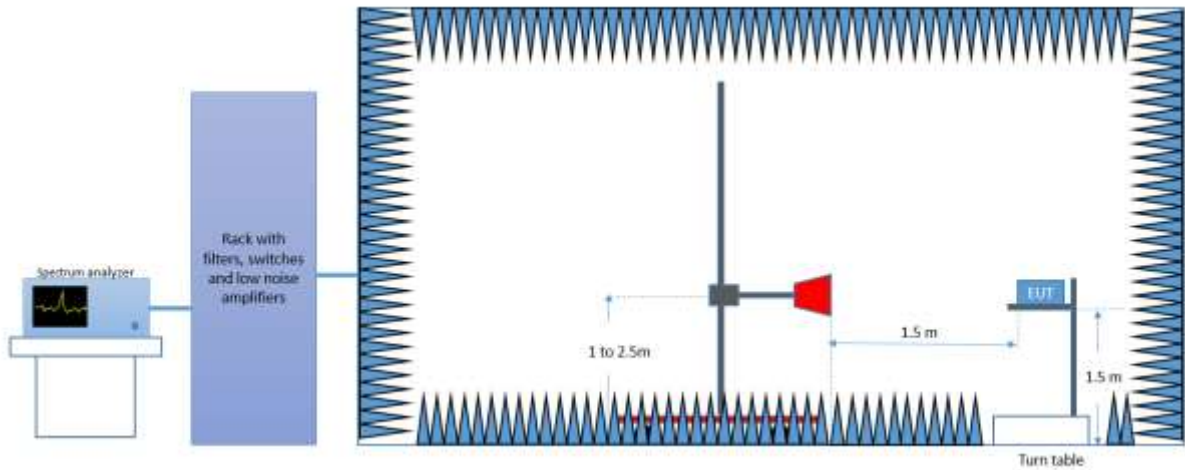

*Radiated Setup > 26.5 GHz*

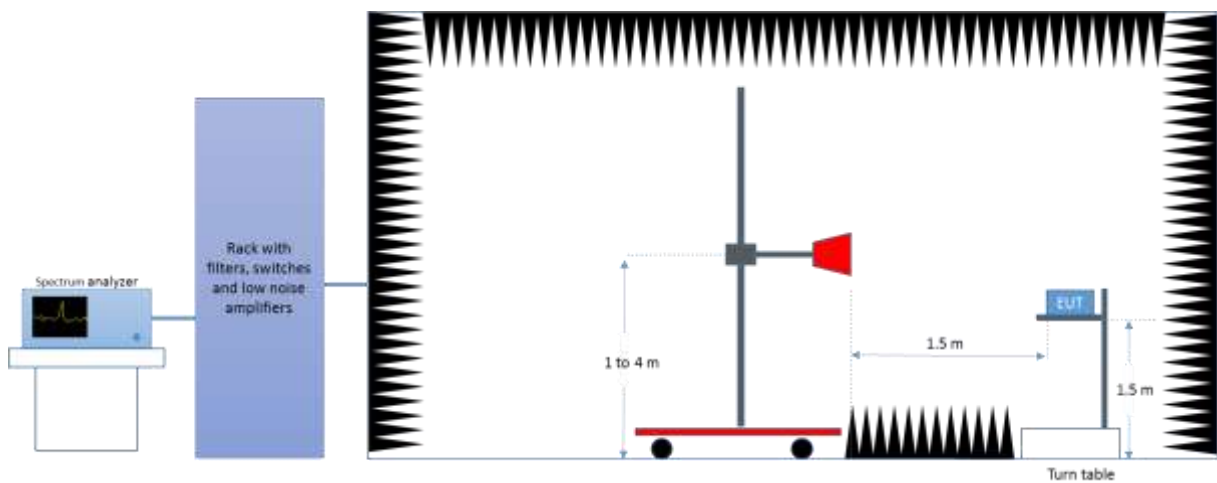

**Test Results**

**30 MHz – 1 GHz**

**Radiated Spurious – All modes**

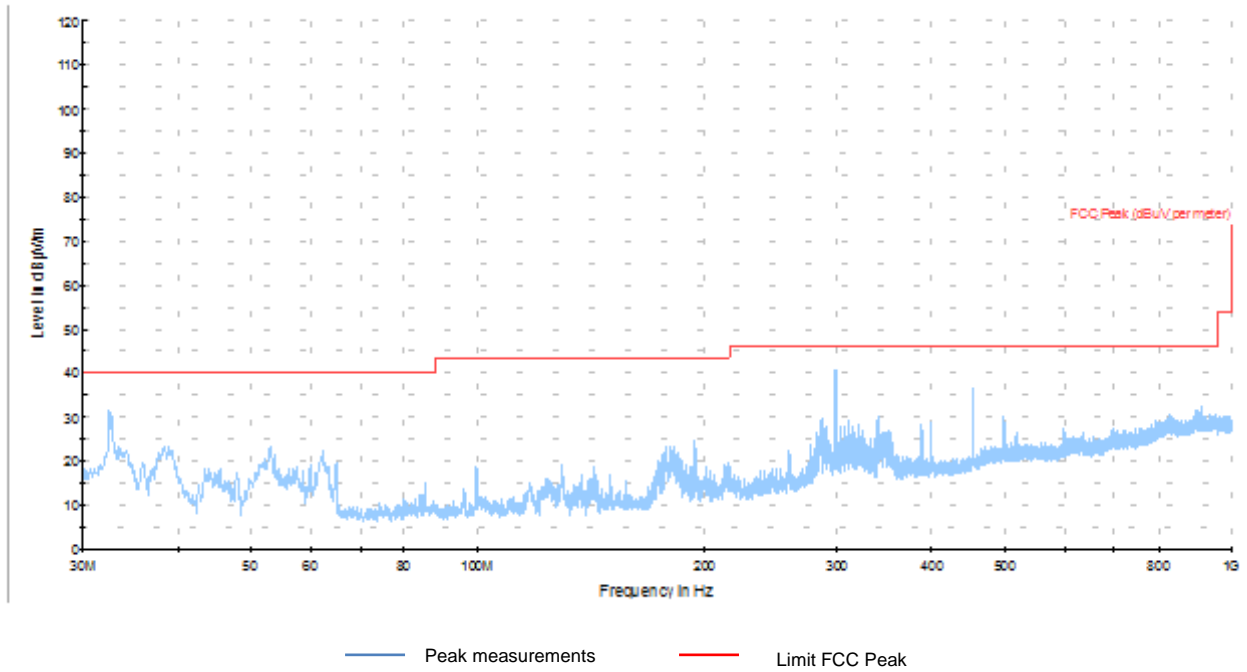

Frequency	MaxPeak	Limit	Margin
MHz	dBm	dBm	dB
298.73	41.05	46	4.95

Note 1: The spurious signals detected do not depend on either the operating channel or the modulation mode.

**1 GHz – 26.5GHz, 802.11a, Chain A**

**Radiated Spurious – CH36**

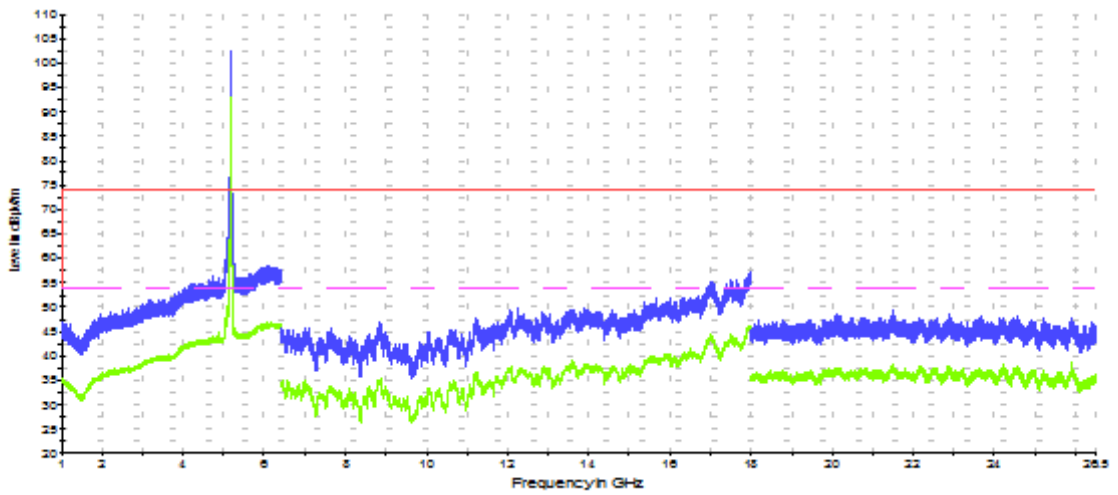

— Peak measurements     
 — AVG measurements     
 — Limit FCC Peak     
 - - - Limit FCC Avg

Frequency	MaxPeak	Avg	Limit	Margin
MHz	dBuV/m	dBuV/m	dBuV/m	dB
6400	57.5	-	74	16.5
6400	-	46.1	54	7.9

### Radiated Spurious – CH40

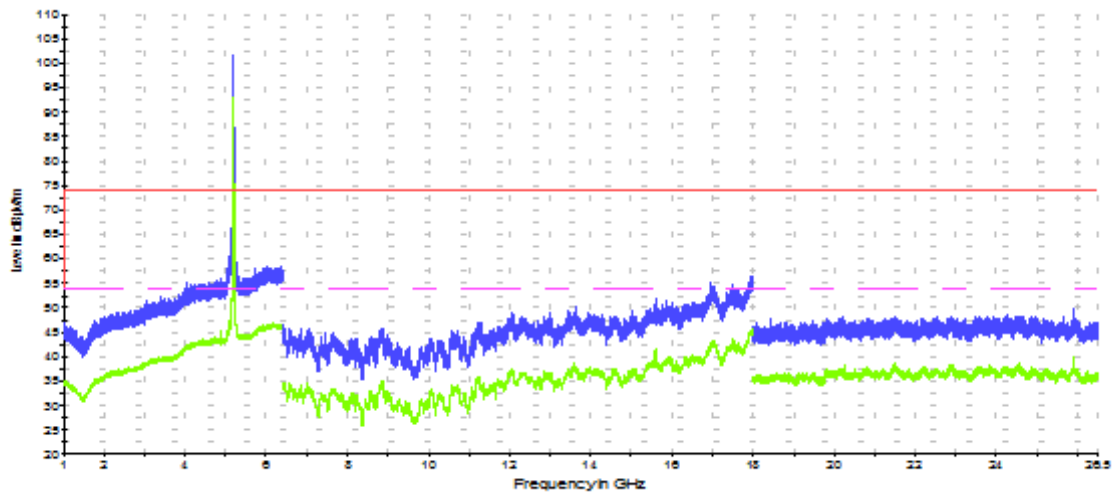

— Peak measurements     
 — AVG measurements     
 — Limit FCC Peak     
 - - - Limit FCC Avg

Frequency	MaxPeak	Avg	Limit	Margin
MHz	dBuV/m	dBuV/m	dBuV/m	dB
6400	58.0	-	74	16
6400	-	46.4	54	7.6

### Radiated Spurious – CH48

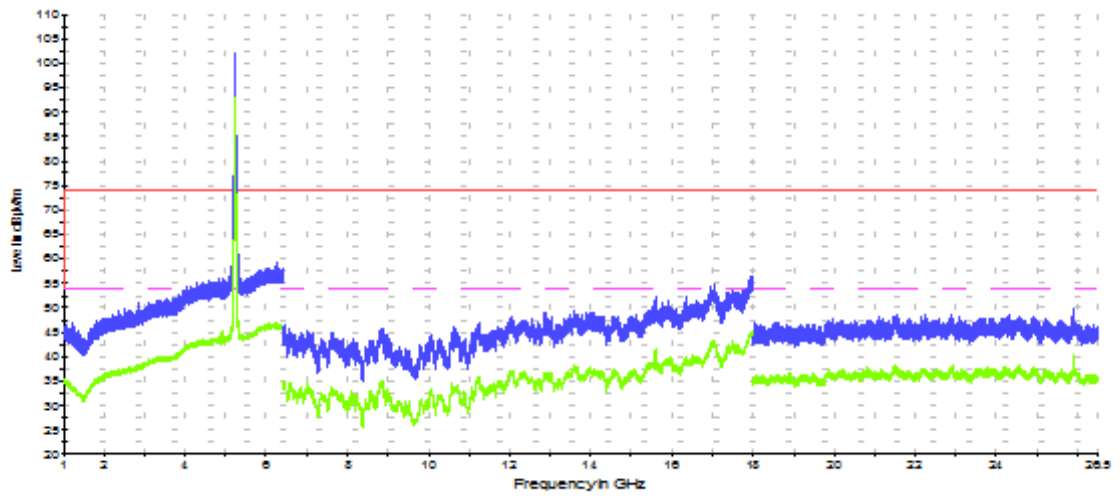

— Peak measurements     
 — AVG measurements     
 — Limit FCC Peak     
 - - - Limit FCC Avg

Frequency	MaxPeak	Avg	Limit	Margin
MHz	dBuV/m	dBuV/m	dBuV/m	dB
6400	57.4	-	74	16.6
6400	-	46.4	54	7.6

**1 GHz – 26.5GHz, 802.11a, Chain B**

**Radiated Spurious – CH36**

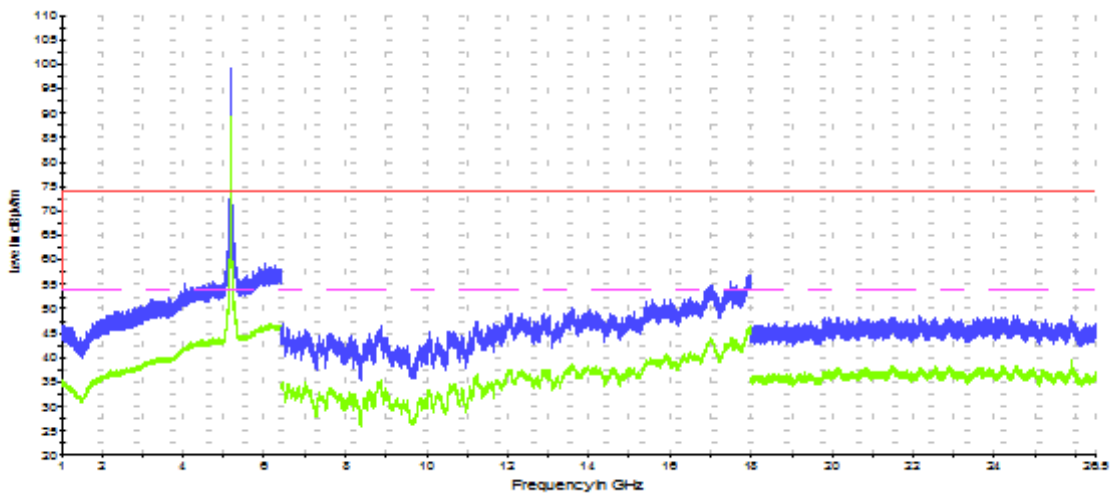

— Peak measurements     
 — AVG measurements     
 — Limit FCC Peak     
 - - - Limit FCC Avg

Frequency	MaxPeak	Avg	Limit	Margin
MHz	dBuV/m	dBuV/m	dBuV/m	dB
6400	58.3	-	74	15.7
6400	-	46.1	54	7.9

### Radiated Spurious – CH40

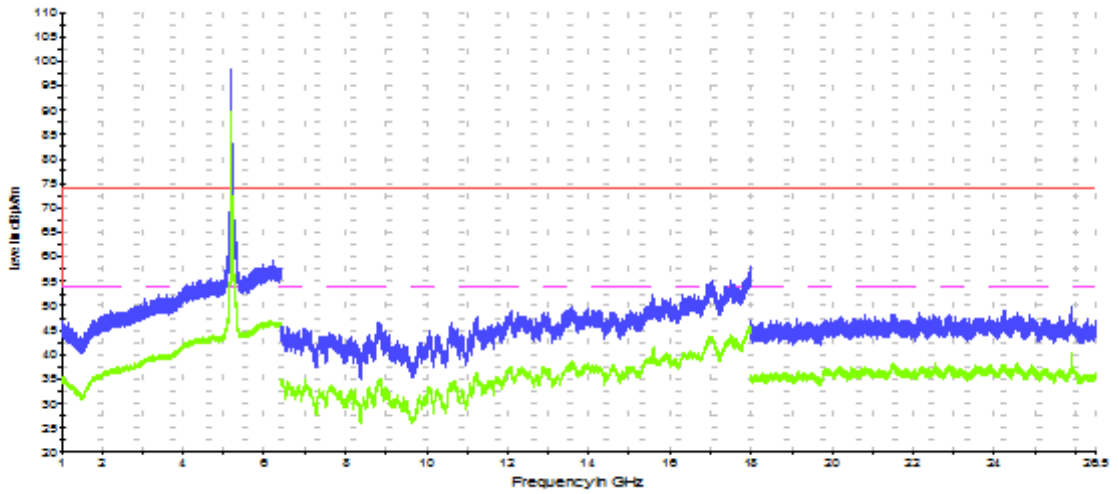

— Peak measurements     
 — AVG measurements     
 — Limit FCC Peak     
 - - - Limit FCC Avg

Frequency	MaxPeak	Avg	Limit	Margin
MHz	dBuV/m	dBuV/m	dBuV/m	dB
6400	57.6	-	74	16.4
6400	-	46.3	54	7.7

### Radiated Spurious – CH48

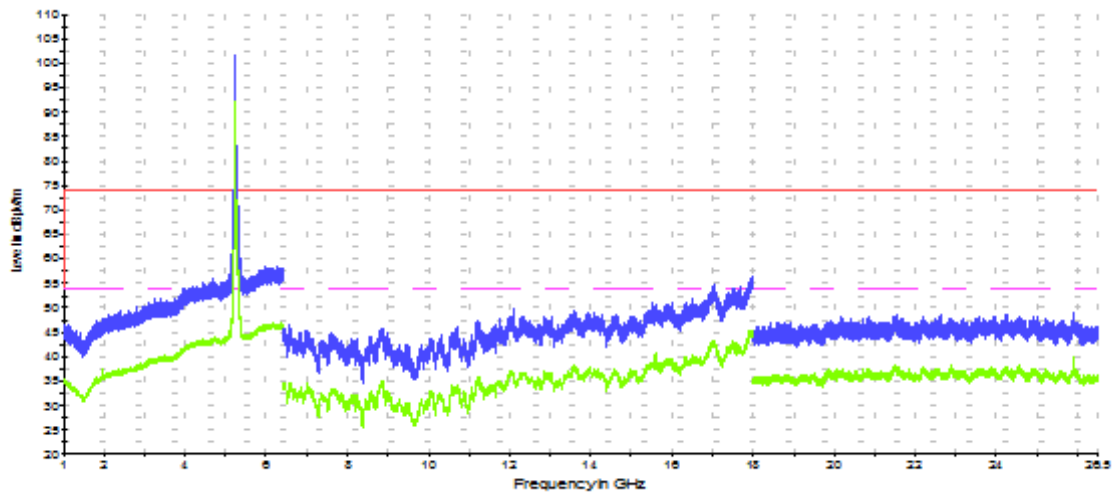

— Peak measurements     
 — AVG measurements     
 — Limit FCC Peak     
 - - - Limit FCC Avg

Frequency	MaxPeak	Avg	Limit	Margin
MHz	dBuV/m	dBuV/m	dBuV/m	dB
6400	58.0	-	74	16
6400	-	47.0	54	7



**1 GHz – 26.5GHz, 802.11n20, Chain A**

**Radiated Spurious – CH36**

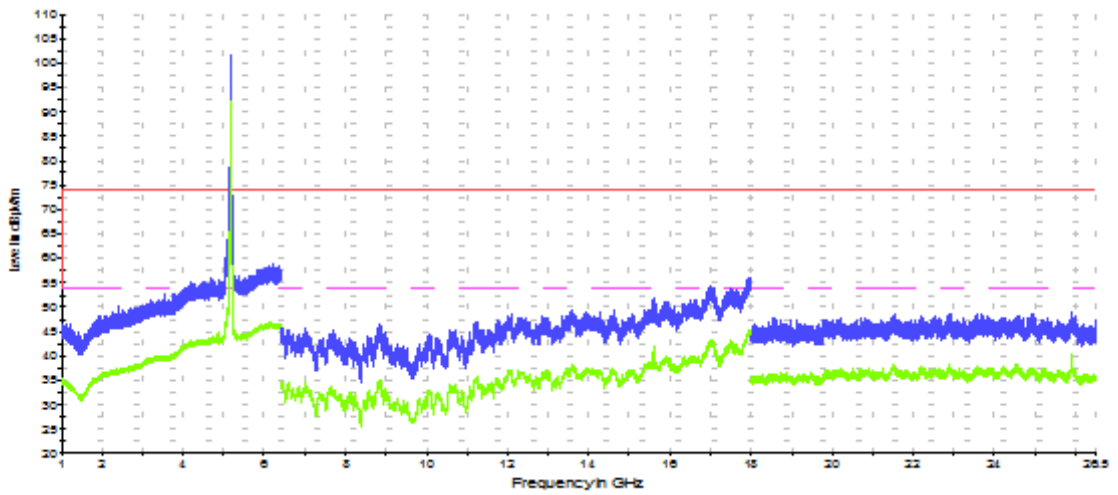

— Peak measurements     
 — AVG measurements     
 — Limit FCC Peak     
 - - - Limit FCC Avg

Frequency	MaxPeak	Avg	Limit	Margin
MHz	dBuV/m	dBuV/m	dBuV/m	dB
6377	58.5	-	74	15.5
6377	-	46.7	54	7.3

### Radiated Spurious – CH40

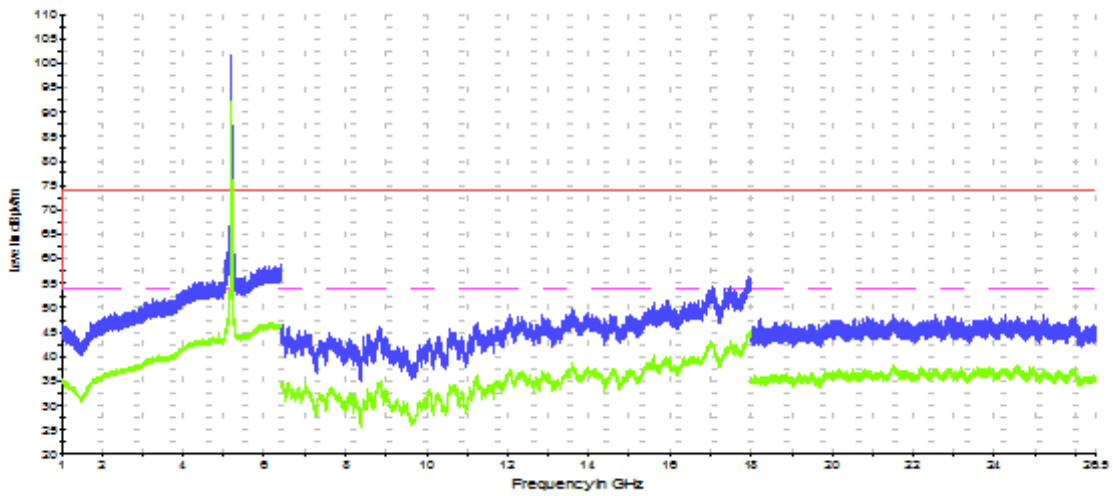

— Peak measurements     
 — AVG measurements     
 — Limit FCC Peak     
 - - - Limit FCC Avg

Frequency	MaxPeak	Avg	Limit	Margin
MHz	dBuV/m	dBuV/m	dBuV/m	dB
6389	58.8	-	74	15.2
6389	-	46.5	54	7.5

### Radiated Spurious – CH48

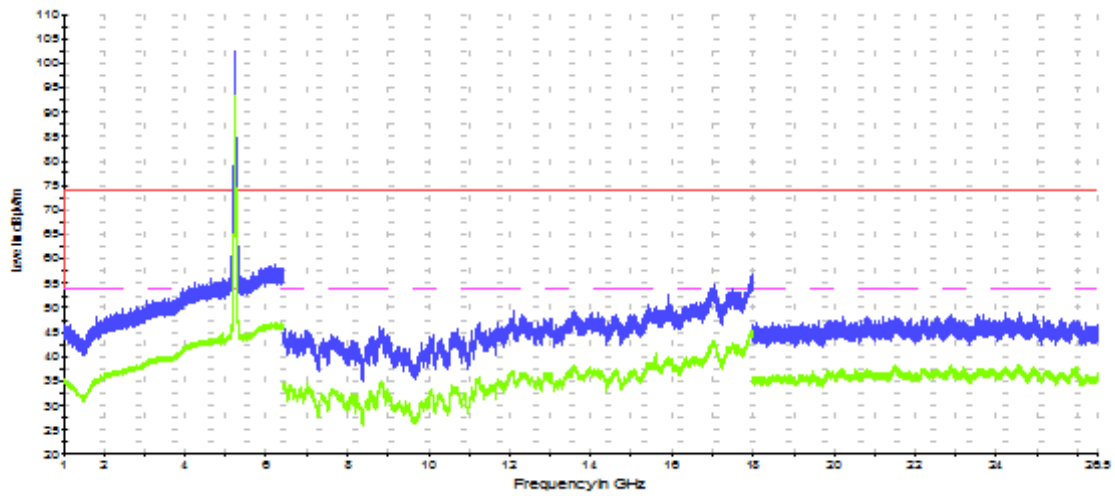

— Peak measurements     
 — AVG measurements     
 — Limit FCC Peak     
 - - - Limit FCC Avg

Frequency	MaxPeak	Avg	Limit	Margin
MHz	dBuV/m	dBuV/m	dBuV/m	dB
6383	58.3	-	74	15.7
6383	-	46.8	54	7.2

**1 GHz – 26.5GHz, 802.11n20, Chain B**

**Radiated Spurious – CH36**

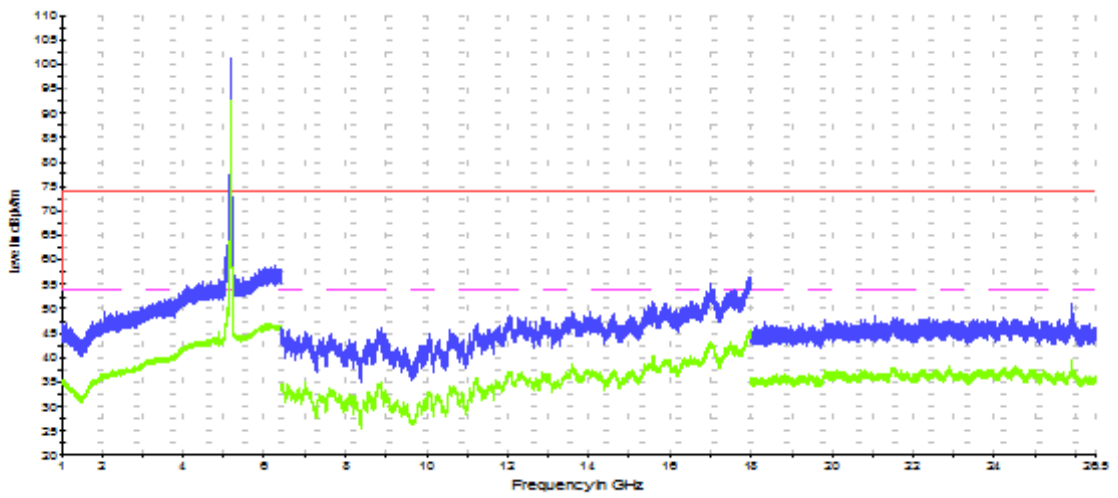

— Peak measurements     
 — AVG measurements     
 — Limit FCC Peak     
 - - - Limit FCC Avg

Frequency	MaxPeak	Avg	Limit	Margin
MHz	dBuV/m	dBuV/m	dBuV/m	dB
6385	58.3	-	74	15.7
6385	-	46.4	54	7.6

### Radiated Spurious – CH40

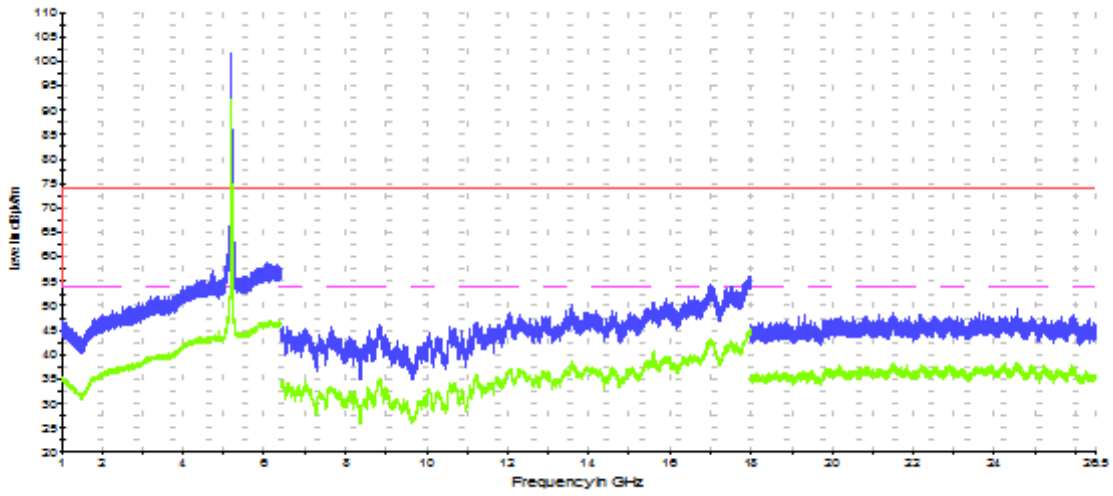

— Peak measurements     
 — AVG measurements     
 — Limit FCC Peak     
 - - - Limit FCC Avg

Frequency	MaxPeak	Avg	Limit	Margin
MHz	dBuV/m	dBuV/m	dBuV/m	dB
6233	59.3	-	74	14.7
6233	-	46.5	54	7.5

### Radiated Spurious – CH48

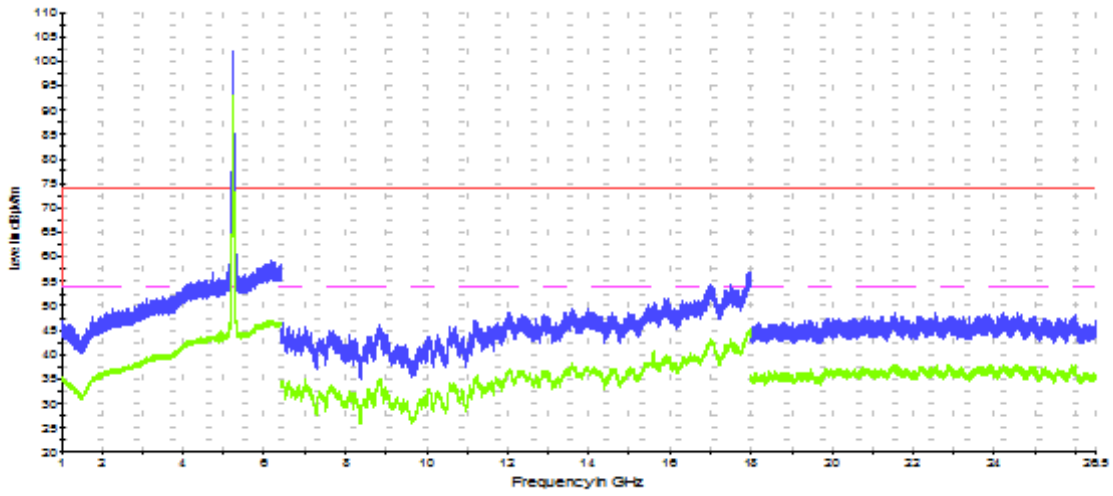

— Peak measurements     
 — AVG measurements     
 — Limit FCC Peak     
 - - - Limit FCC Avg

Frequency	MaxPeak	Avg	Limit	Margin
MHz	dBuV/m	dBuV/m	dBuV/m	dB
6154	59.1	-	74	14.9
6154	-	46.6	54	7.4

**1 GHz – 26.5GHz, 802.11n20, Chain A+B**

**Radiated Spurious – CH36**

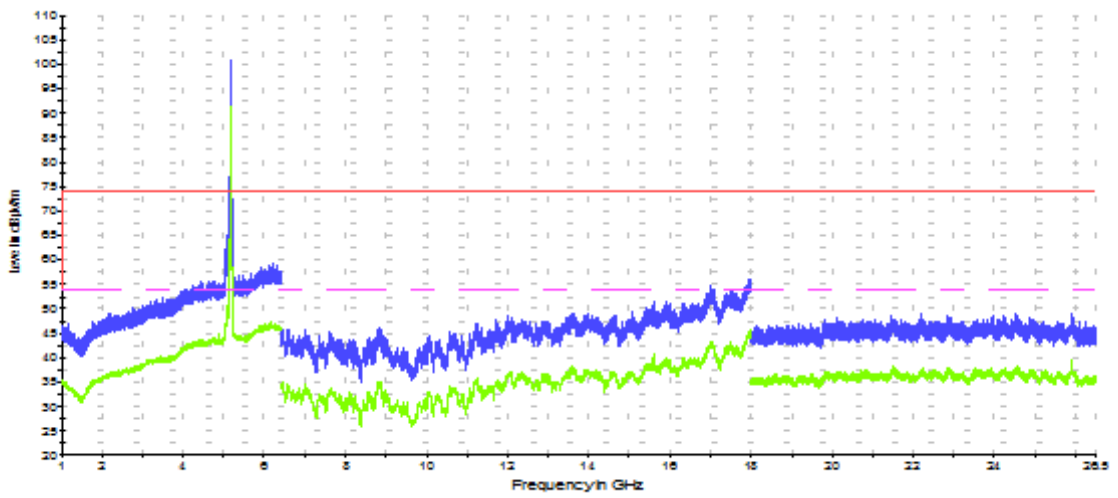

— Peak measurements     
 — AVG measurements     
 — Limit FCC Peak     
 - - - - Limit FCC Avg

Frequency	MaxPeak	Avg	Limit	Margin
MHz	dBuV/m	dBuV/m	dBuV/m	dB
6367	57.9	-	74	16.1
6367	-	46.5	54	7.5

### Radiated Spurious – CH40

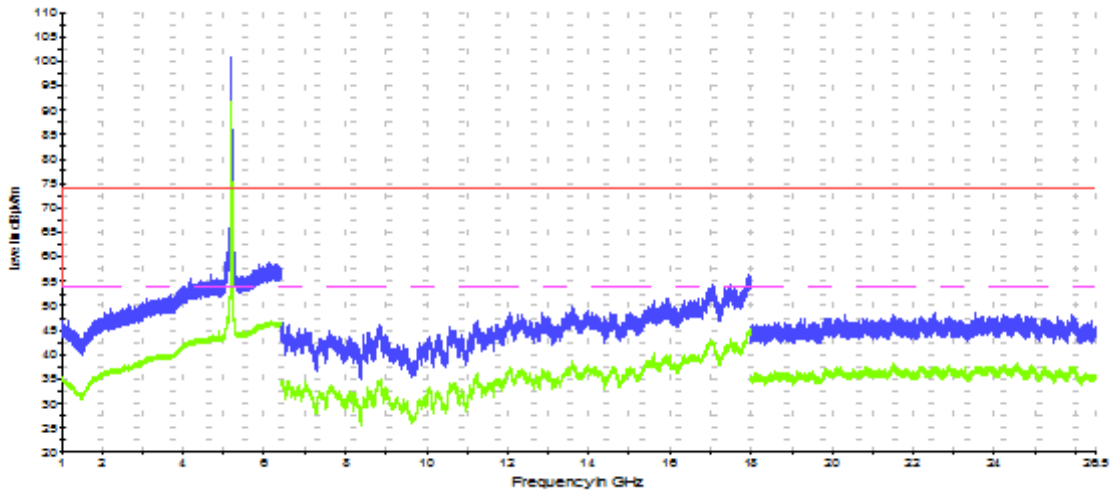

— Peak measurements     
 — AVG measurements     
 — Limit FCC Peak     
 - - - Limit FCC Avg

Frequency	MaxPeak	Avg	Limit	Margin
MHz	dBuV/m	dBuV/m	dBuV/m	dB
6283	58.8	-	74	15.2
6283	-	46.3	54	7.7



### Radiated Spurious – CH48

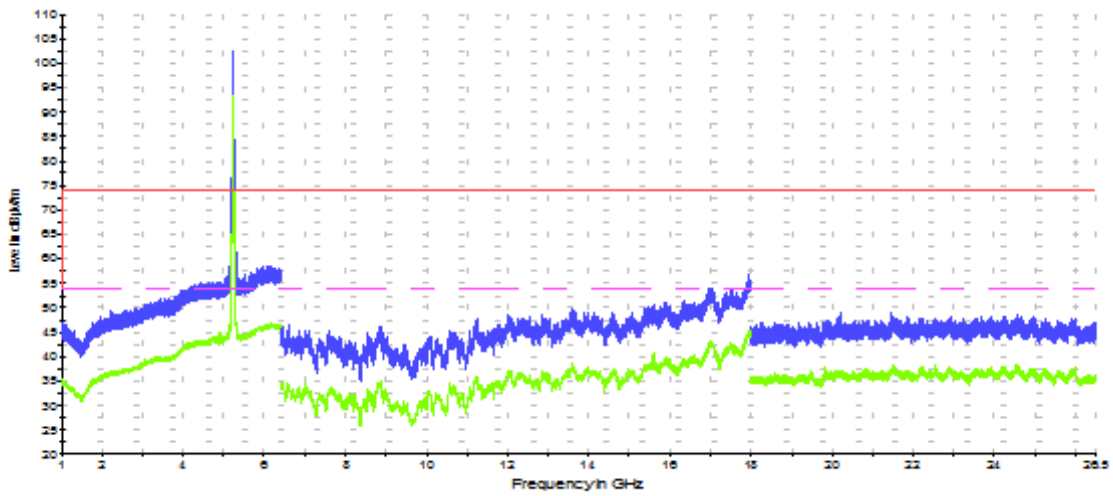

— Peak measurements     
 — AVG measurements     
 — Limit FCC Peak     
 - - - Limit FCC Avg

Frequency	MaxPeak	Avg	Limit	Margin
MHz	dBuV/m	dBuV/m	dBuV/m	dB
6111	58.5	-	74	15.5
6111	-	46.5	54	7.5

**1 GHz – 26.5GHz, 802.11n40, Chain A**

**Radiated Spurious – CH38F**

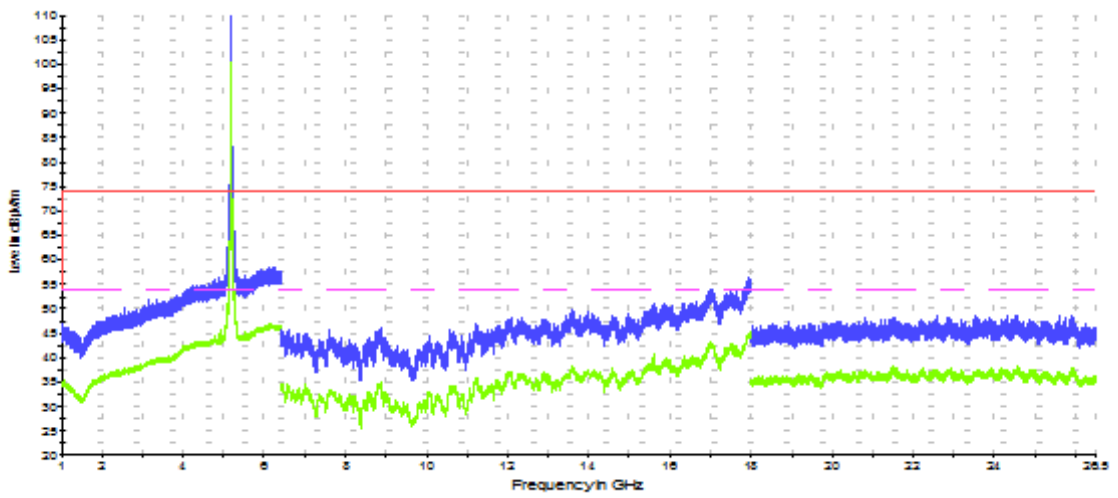

— Peak measurements     
 — AVG measurements     
 — Limit FCC Peak     
 - - - - Limit FCC Avg

Frequency	MaxPeak	Avg	Limit	Margin
MHz	dBuV/m	dBuV/m	dBuV/m	dB
6005	58.4	-	74	15.6
6005	-	46.4	54	7.6

### Radiated Spurious – CH46F

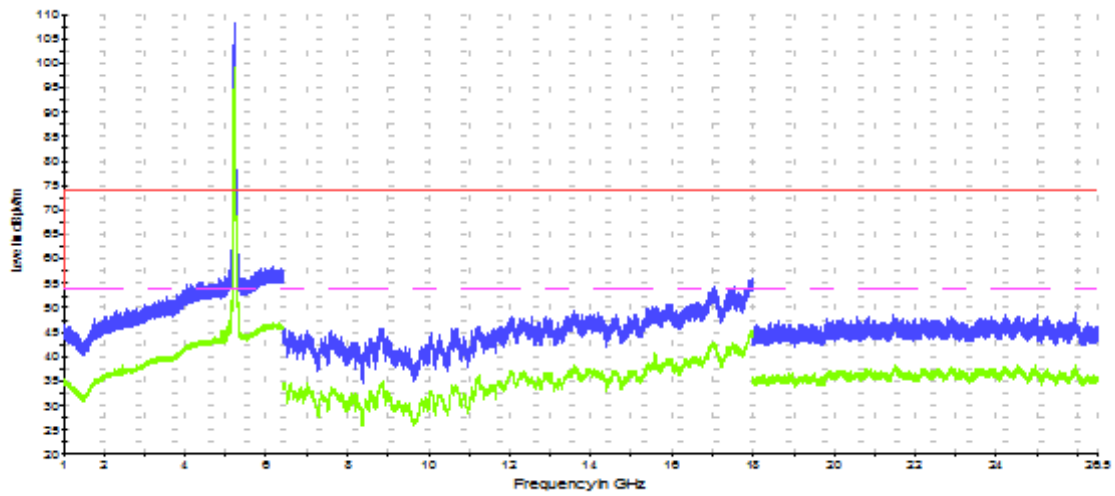

— Peak measurements     
 — AVG measurements     
 — Limit FCC Peak     
 - - - Limit FCC Avg

Frequency	MaxPeak	Avg	Limit	Margin
MHz	dBuV/m	dBuV/m	dBuV/m	dB
6227	58.4	-	74	15.6
6227	-	46.6	54	7.6

**1 GHz – 26.5GHz, 802.11n40, Chain B**

**Radiated Spurious – CH38F**

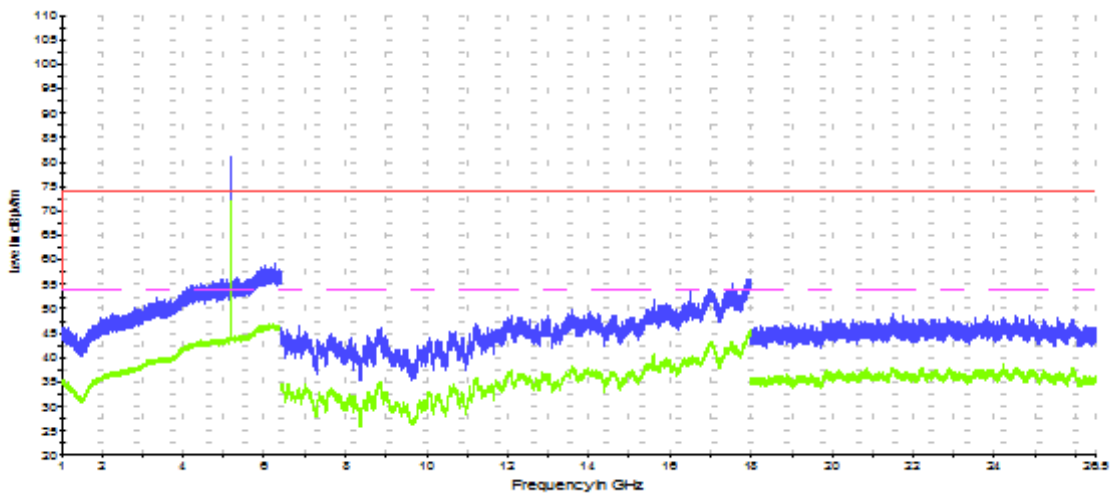

— Peak measurements     
 — AVG measurements     
 — Limit FCC Peak     
 - - - Limit FCC Avg

Frequency	MaxPeak	Avg	Limit	Margin
MHz	dBuV/m	dBuV/m	dBuV/m	dB
6018	58.8	-	74	15.2
6018	-	46.2	54	7.8

### Radiated Spurious – CH46F

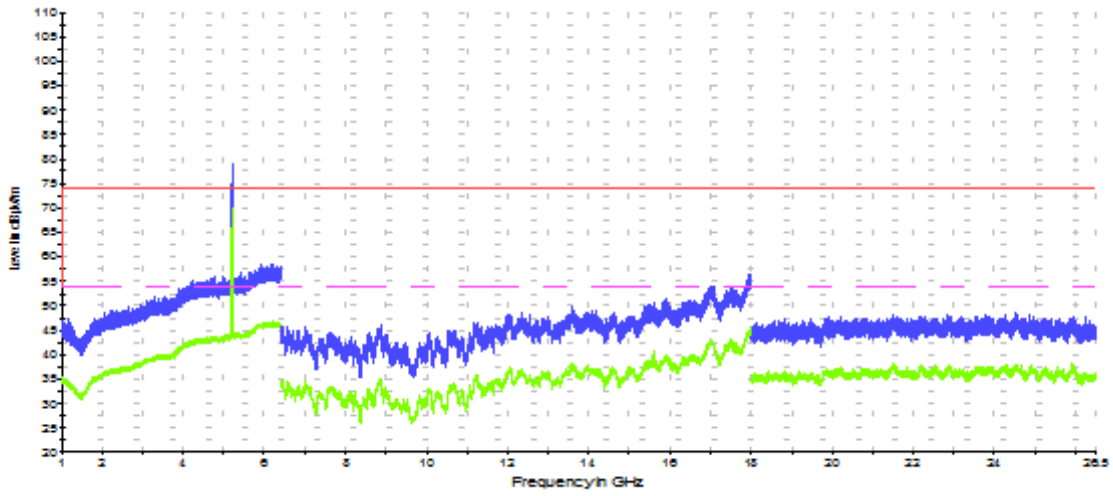

— Peak measurements     
 — AVG measurements     
 — Limit FCC Peak     
 - - - Limit FCC Avg

Frequency	MaxPeak	Avg	Limit	Margin
MHz	dBuV/m	dBuV/m	dBuV/m	dB
6226	58.9	-	74	15.1
6226	-	46.8	54	7.2

**1 GHz – 26.5GHz, 802.11n40, Chain A+B**

**Radiated Spurious – CH38F**

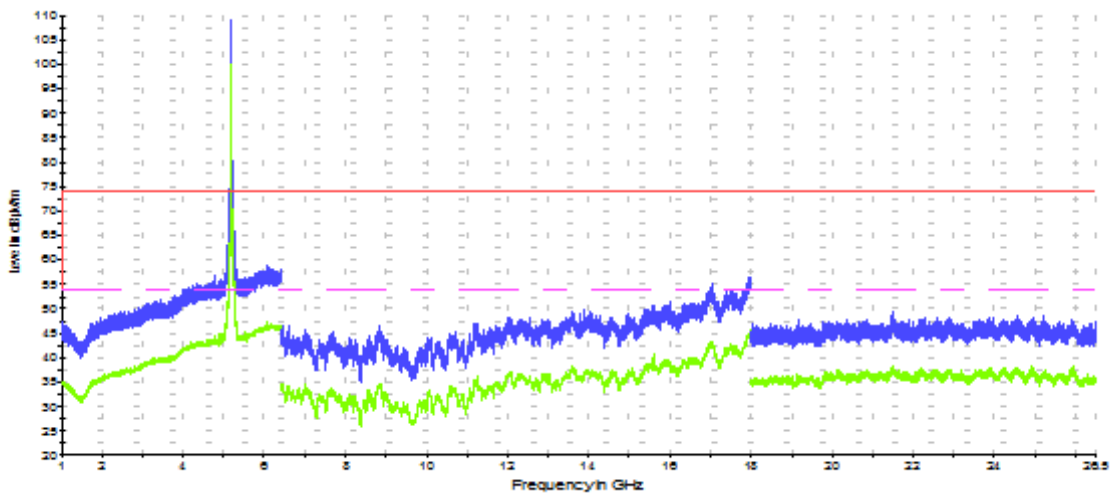

— Peak measurements     
 — AVG measurements     
 — Limit FCC Peak     
 - - - Limit FCC Avg

Frequency	MaxPeak	Avg	Limit	Margin
MHz	dBuV/m	dBuV/m	dBuV/m	dB
6077	58.7	-	74	15.3
6077	-	47.4	54	7.6

### Radiated Spurious – CH46F

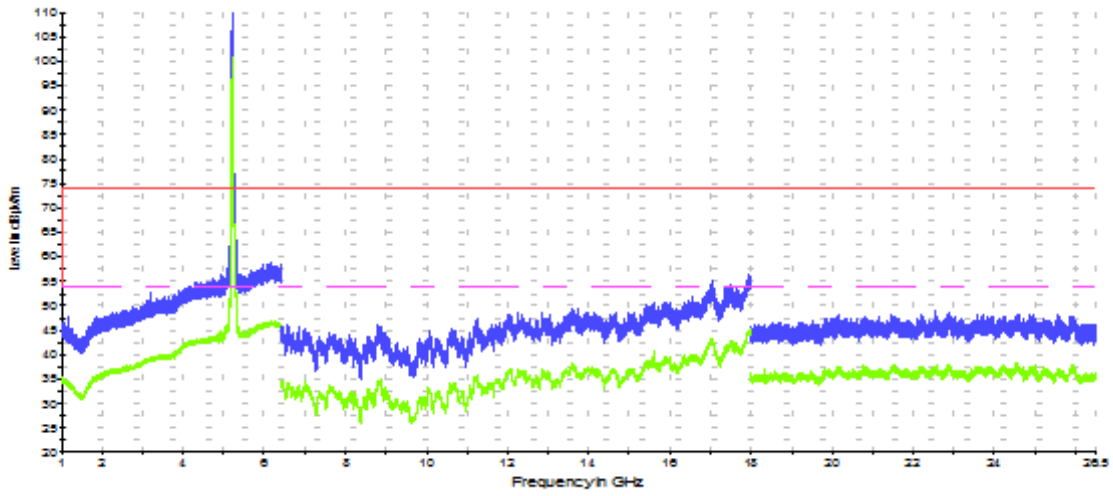

— Peak measurements     
 — AVG measurements     
 — Limit FCC Peak     
 - - - Limit FCC Avg

Frequency	MaxPeak	Avg	Limit	Margin
MHz	dBuV/m	dBuV/m	dBuV/m	dB
5862	59.2	-	74	14.8
5862	-	45.9	54	8.1

**1 GHz – 26.5GHz, 802.11ac80, Chain A**

**Radiated Spurious – CH42ac80**

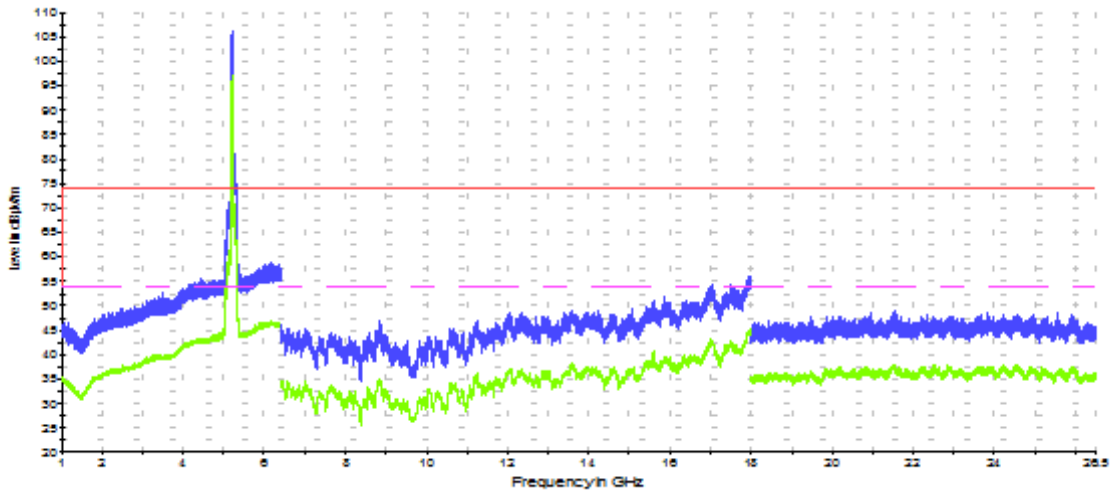

— Peak measurements      — AVG measurements      — Limit FCC Peak      - - - - Limit FCC Avg

Frequency	MaxPeak	Avg	Limit	Margin
MHz	dBuV/m	dBuV/m	dBuV/m	dB
6088	58.4	-	74	15.6
6088	-	46.5	54	7.5



**1 GHz – 26.5GHz, 802.11ac80, Chain B**

**Radiated Spurious – CH42ac80**

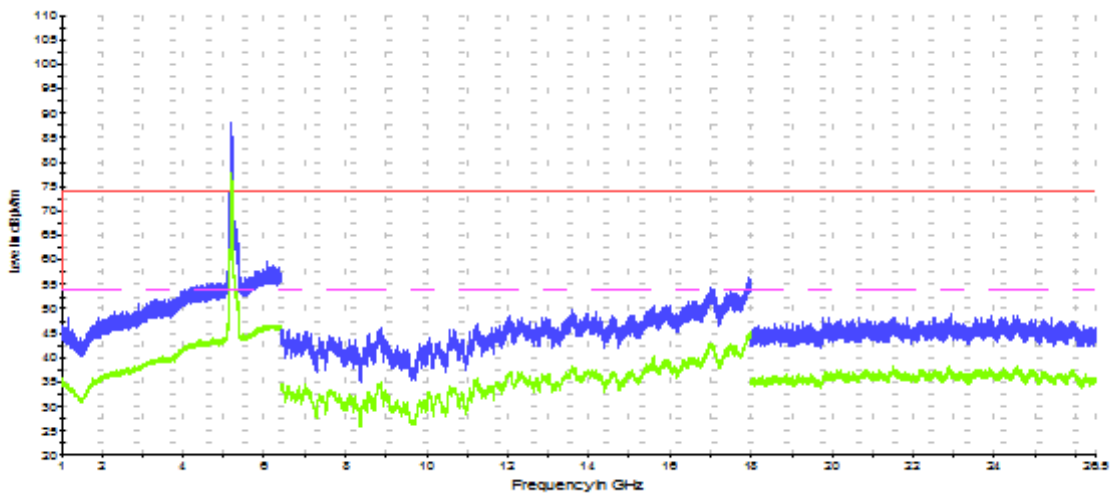

— Peak measurements     
 — AVG measurements     
 — Limit FCC Peak     
 - - - Limit FCC Avg

Frequency	MaxPeak	Avg	Limit	Margin
MHz	dBuV/m	dBuV/m	dBuV/m	dB
6073	59.8	-	74	14.2
6073	-	46.4	54	7.6

**1 GHz – 26.5GHz, 802.11ac80, Chain A+B**

**Radiated Spurious – CH42ac80**

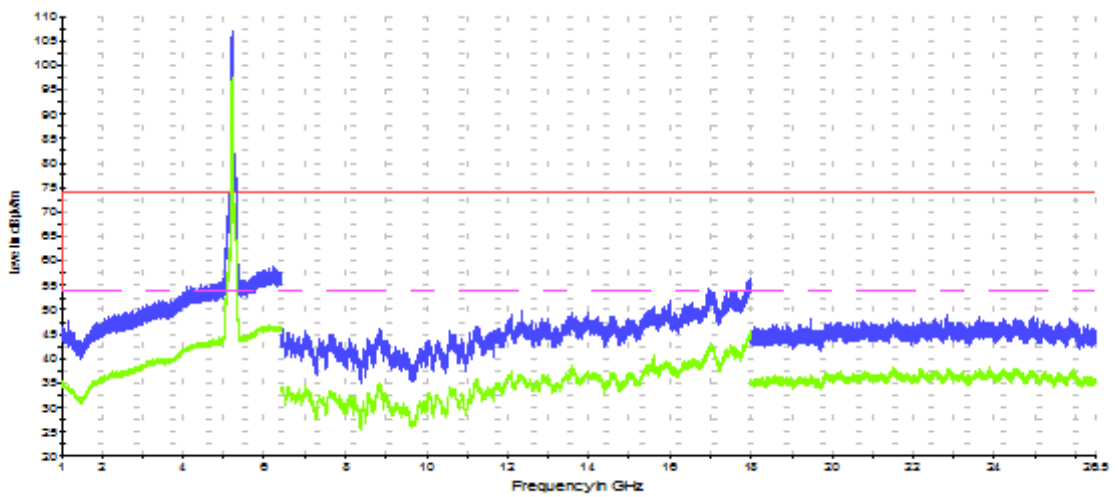

— Peak measurements     
 — AVG measurements     
 — Limit FCC Peak     
 - - - Limit FCC Avg

Frequency	MaxPeak	Avg	Limit	Margin
MHz	dBuV/m	dBuV/m	dBuV/m	dB
6238	58.8	-	74	15.2
6238	-	46.5	54	7.5

**26.5 GHz – 40GHz**

**Radiated Spurious – All modes**

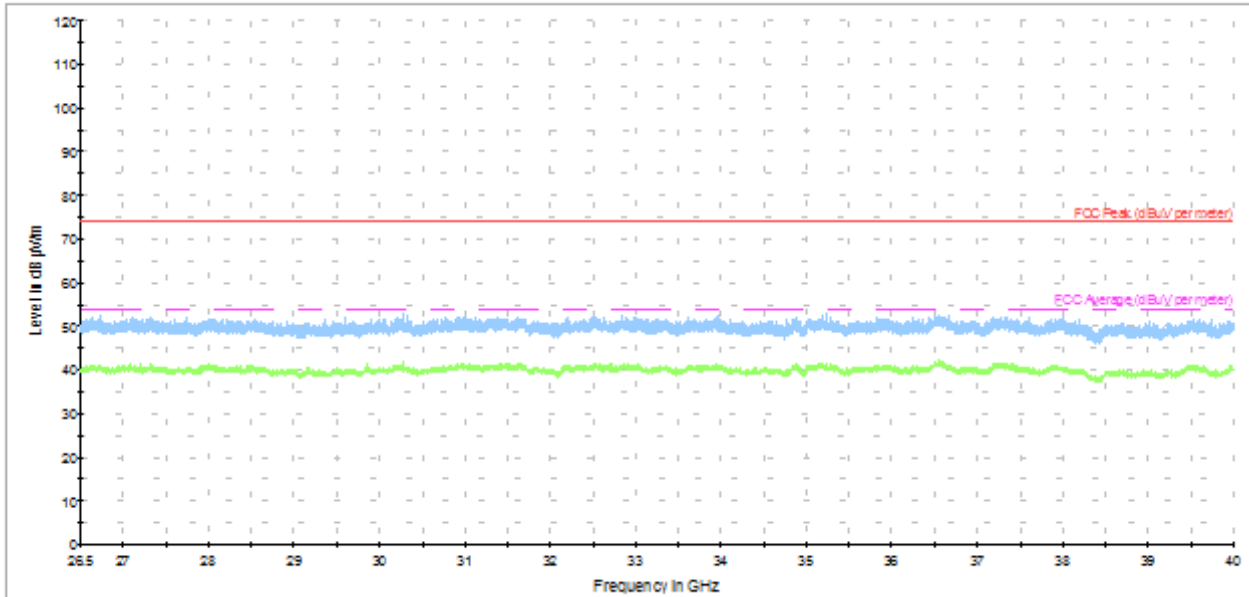

— Peak measurements     
 — AVG measurements     
 — Limit FCC Peak     
 - - - Limit FCC Avg

Frequency	MaxPeak	Avg	Limit	Margin
MHz	dBuV/m	dBuV/m	dBuV/m	dB
39498.80	51.22		74	22.78
39497.12		41.25	54	12.75

Note 1: The spurious signals detected do not depend on either the operating channel or the modulation mode.

# Annex C. Test Results U-NII-2A

---

## C.1 26dB & 99% Bandwidth

### Test procedure:

The setup below was used to measure the 26dB & 99% Bandwidth. The antenna terminal of the EUT is connected to the spectrum through an attenuator, and the spectrum analyzer reading is compensated to include the RF path loss.

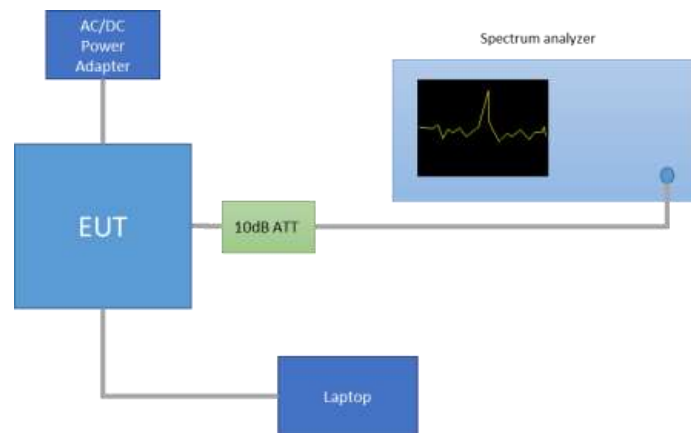

**Results tables:**

Mode	Rate	Antenna	Channel	Frequency [MHz]	26dB BW [MHz]	99% BW [MHz]
802.11a	6Mbps	SISO CHAIN A	52	5260	30.95	18.40
			56	5280	30.40	18.56
			64	5320	24.00	16.64
		SISO CHAIN B	52	5260	32.80	19.80
			56	5280	<b>33.00</b>	<b>19.96</b>
			64	5320	23.75	16.60
802.11n20	HT0	SISO CHAIN A	52	5260	31.50	18.88
			56	5280	31.85	18.96
			64	5320	25.25	17.84
		SISO CHAIN B	52	5260	34.50	<b>20.20</b>
			56	5280	<b>34.75</b>	<b>20.20</b>
			64	5320	23.45	17.68
	HT8	MIMO CHAIN A	52	5260	29.75	18.40
			56	5280	28.65	18.36
			64	5320	24.20	17.76
		MIMO CHAIN B	52	5260	26.90	18.20
			56	5280	27.00	18.08
			64	5320	23.65	17.68
802.11n40	HT0	SISO CHAIN A	54F	5270	48.69	<b>36.88</b>
			62F	5310	45.18	36.32
		SISO CHAIN B	54F	5270	<b>48.78</b>	36.64
			62F	5310	45.27	36.32
	HT8	MIMO CHAIN A	54F	5270	47.79	36.64
			62F	5310	46.08	36.40
		MIMO CHAIN B	54F	5270	45.18	36.16
			62F	5310	43.65	36.08
802.11ac80	VHT0	SISO CHAIN A	58ac80	5290	<b>86.45</b>	<b>75.12</b>
		SISO CHAIN B	58ac80	5290	85.69	75.00
		MIMO CHAIN A	58ac80	5290	86.26	74.88
		MIMO CHAIN B	58ac80	5290	85.12	75.00

**Max Value**

**Results screenshot:**

**802.11a, 6Mbps – Chain A**

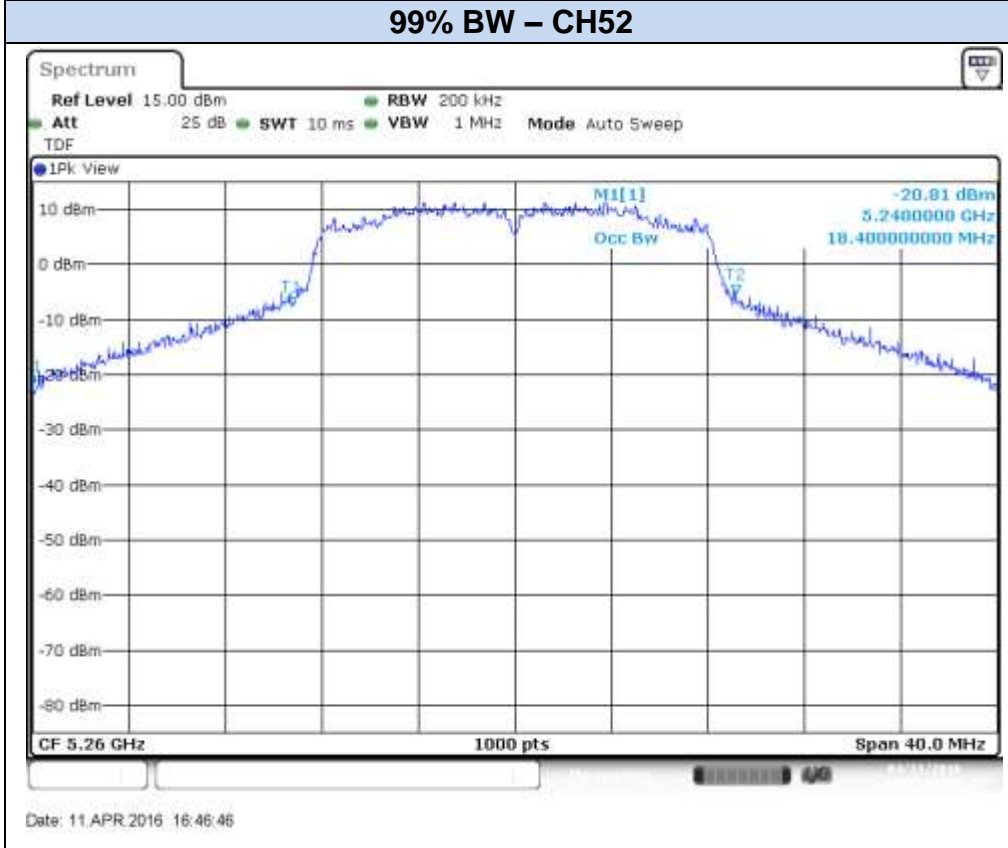
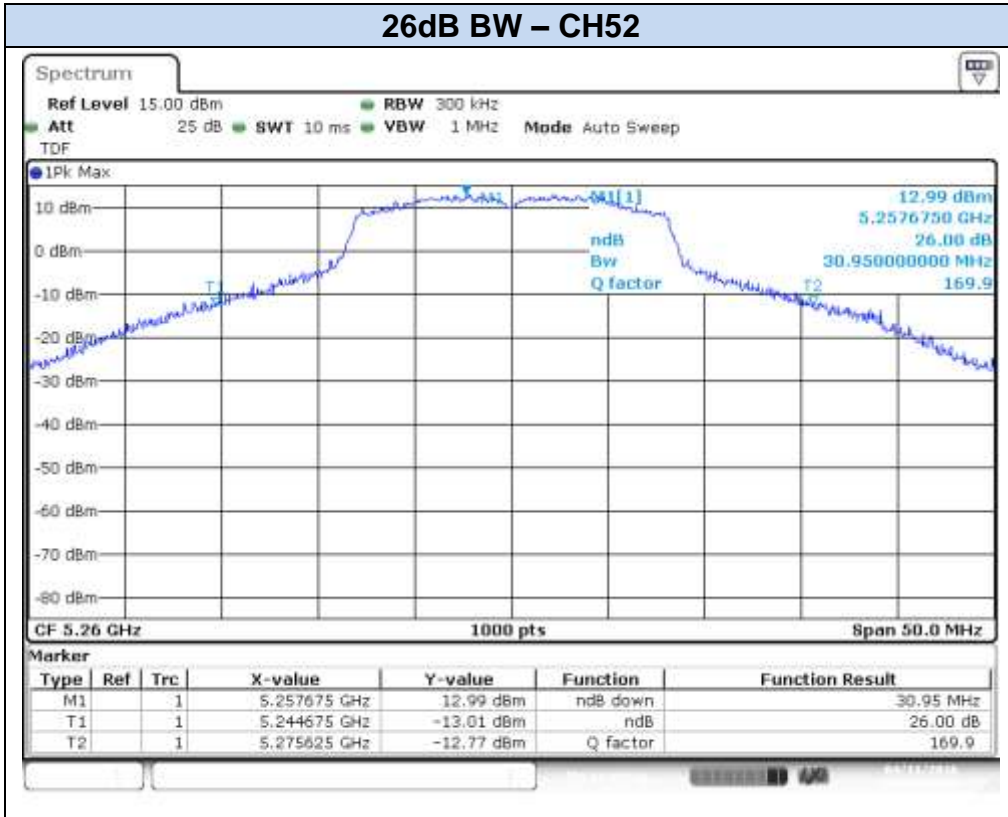

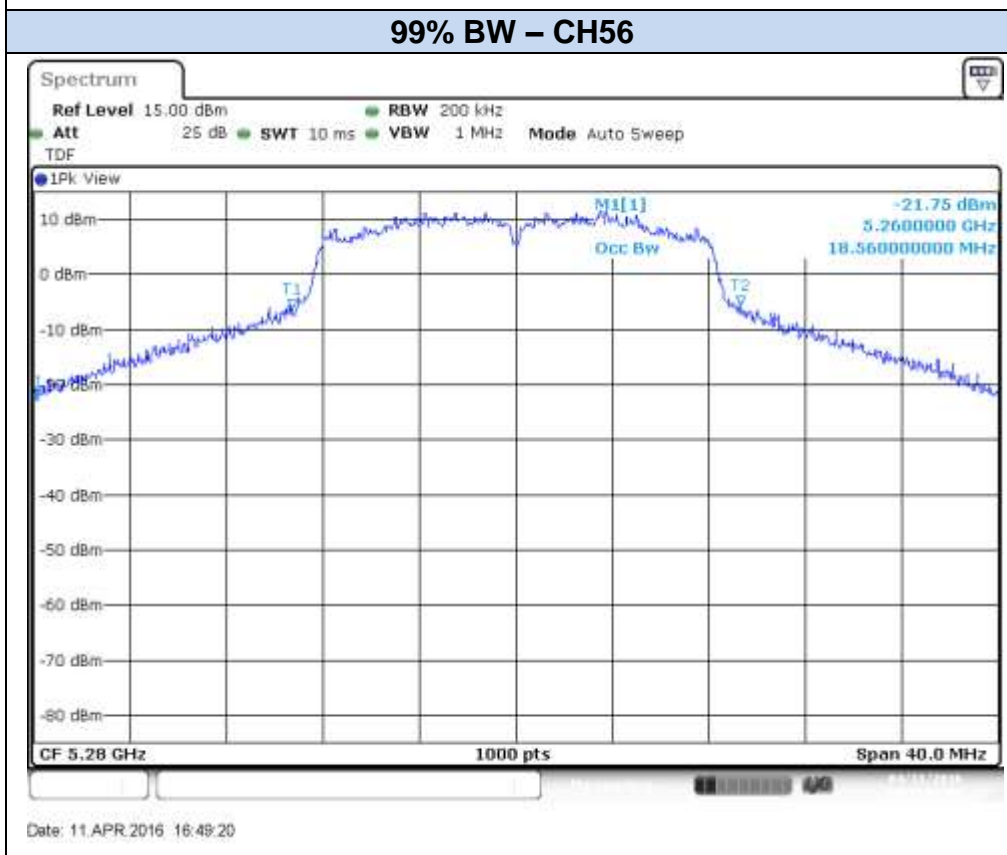
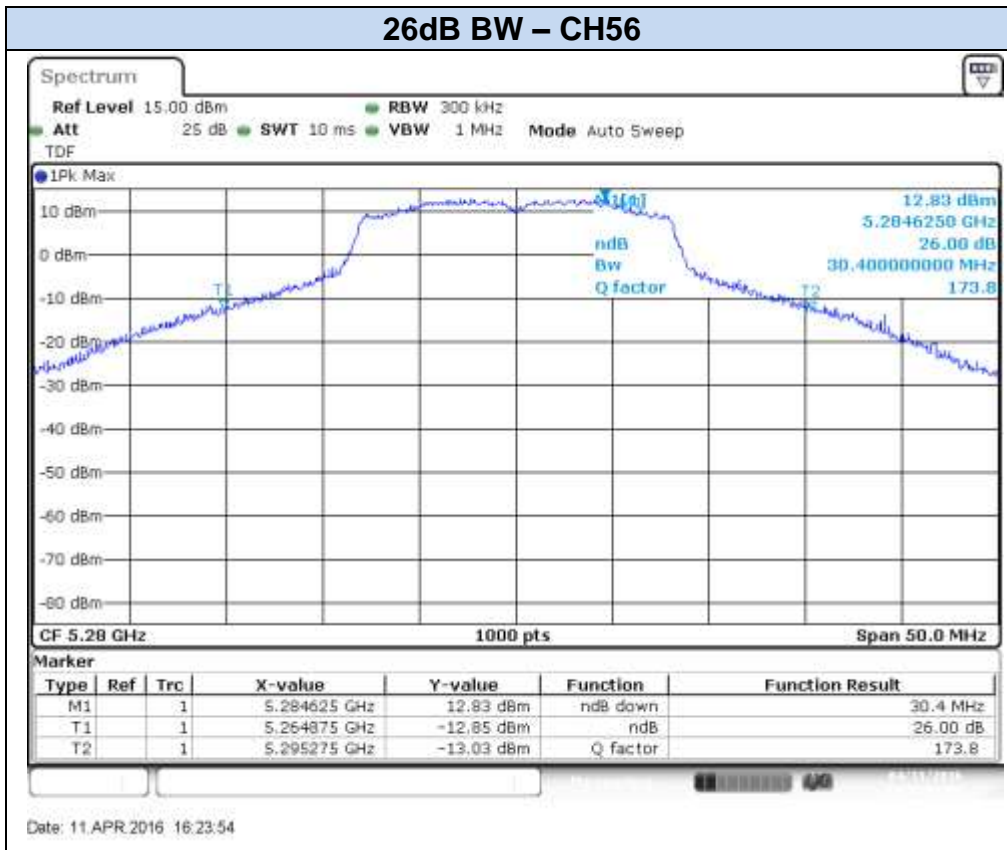

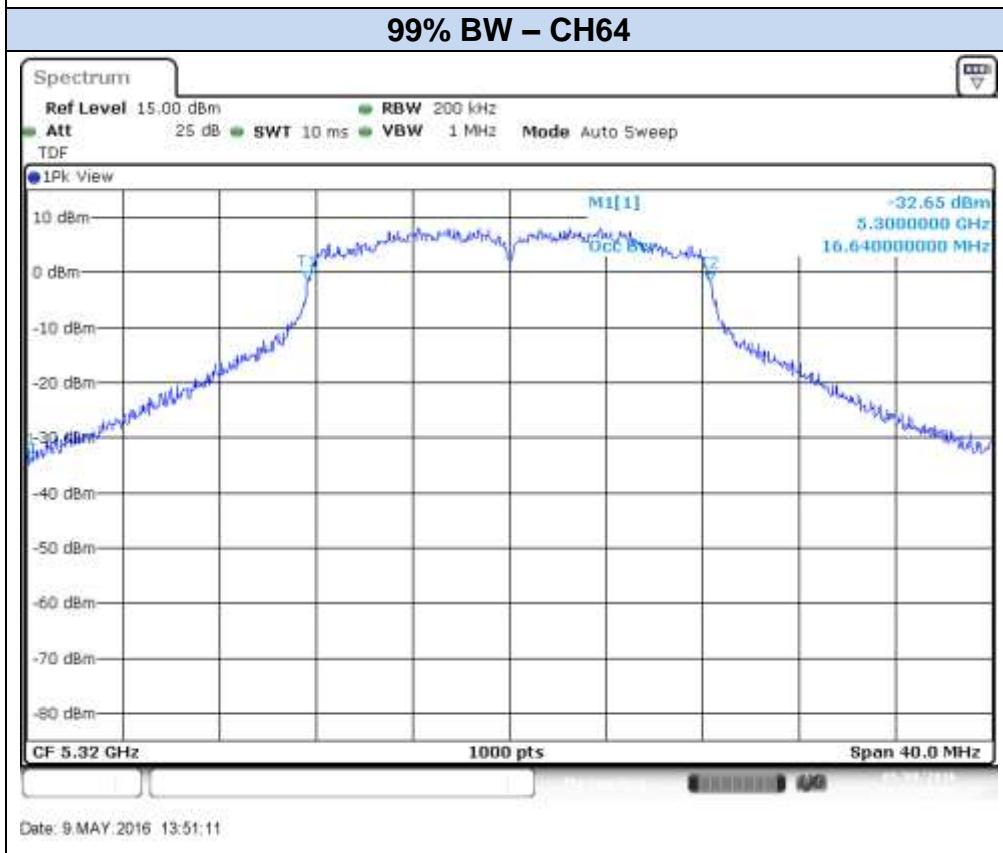
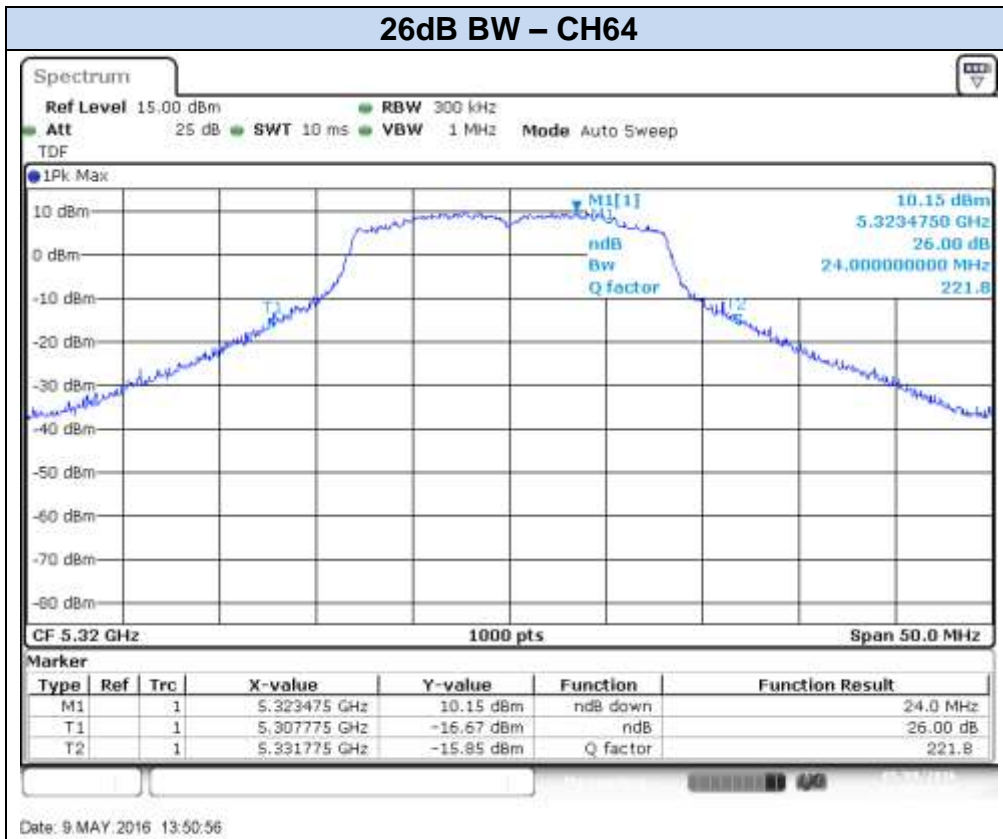



**802.11a, 6Mbps – Chain B**

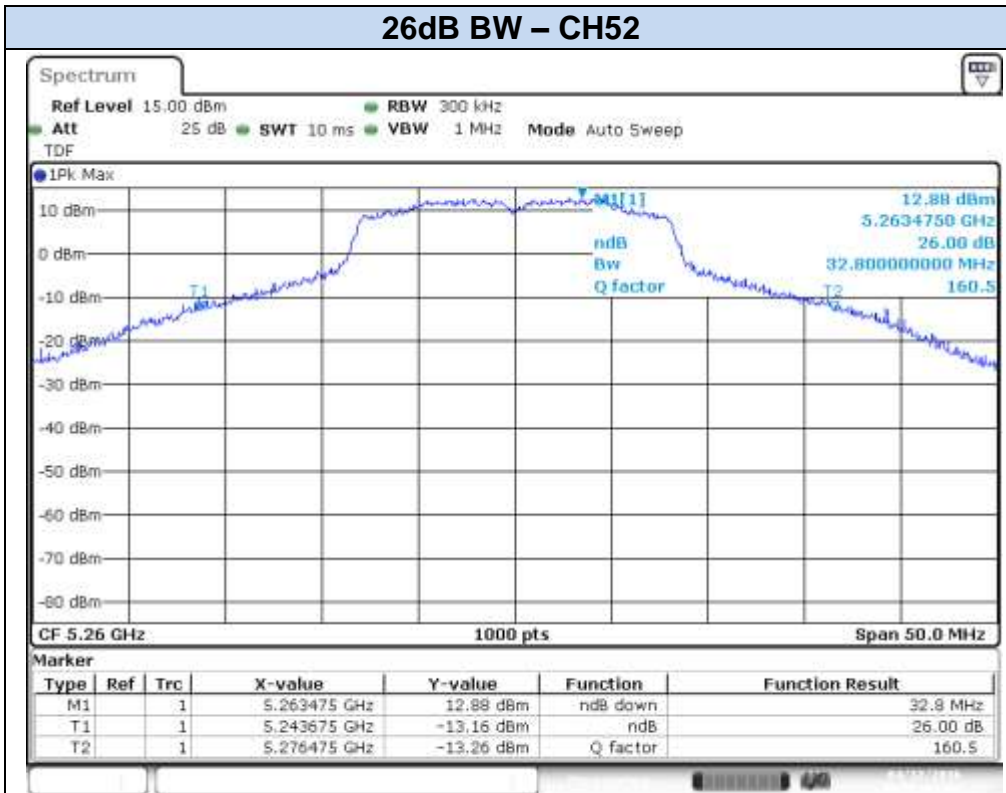

Date: 12 APR 2016 09:50:44

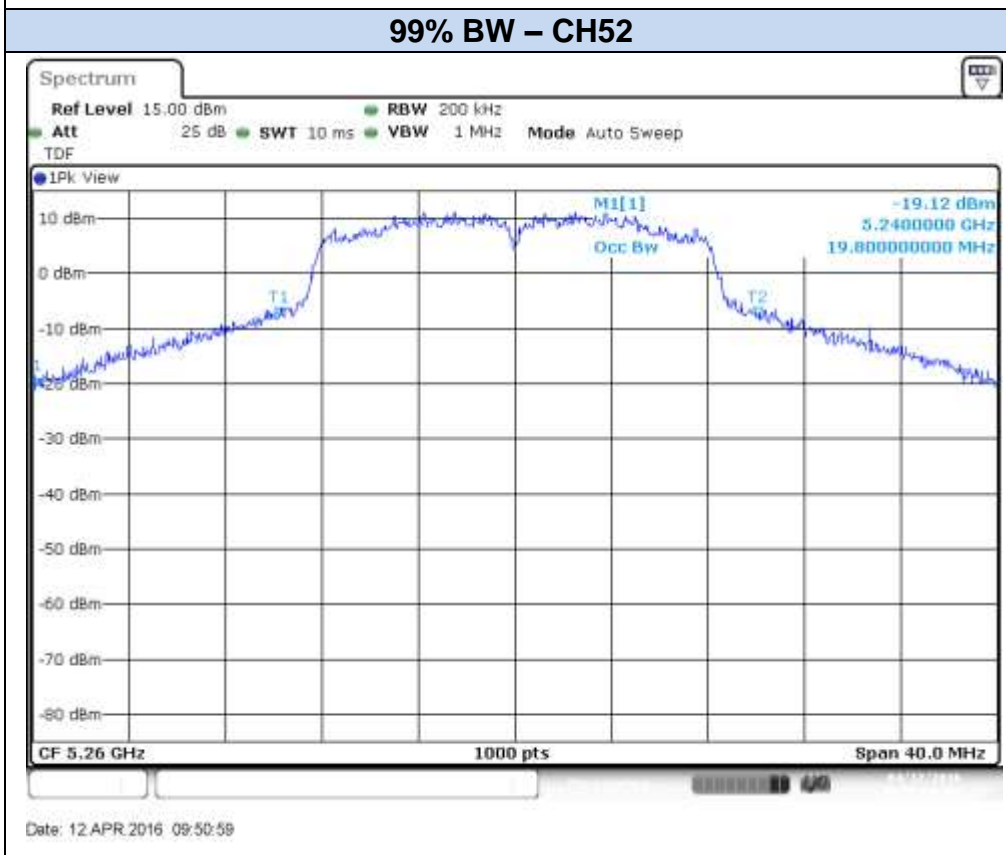

Date: 12 APR 2016 09:50:59