

# ELECTROMAGNETIC EMISSIONS COMPLIANCE REPORT

## INTENTIONAL RADIATOR CERTIFICATION TO FCC PART 15 SUBPART C REQUIREMENT AND INDUSTRY CANADA RSS 210

OF

**Product Name:** Qubeley  
**Brand Name:** Fujitsu  
**Model No.:** Q335  
**Model Difference:** N/A  
**FCC ID:** EJE-WB0092  
**IC:** 337J-WB0092  
**Report No.:** E2/2014/A0049  
**Issue Date:** Nov. 10, 2014  
**FCC Rule Part:** §15.247, Cat: DTS  
**IC Rule Part:** RSS-210 issue 8 :2010, Annex 8  
**Prepared for:** Fujitsu Limited  
4-1-1, Kamikodanaka, Nakahara-ku, Kawasaki-shi, Kanagawa, 211-8588, Japan  
**Prepared by:** SGS Taiwan Ltd.  
Electronics & Communication Laboratory  
No.2, Keji 1st Rd., Guishan Township, Taoyuan County, Taiwan 333



*Note: This report shall not be reproduced except in full, without the written approval of SGS Taiwan Ltd. This document may be altered or revised by SGS Taiwan Ltd. personnel only, and shall be noted in the revision section of the document.*

Unless otherwise stated the results shown in this test report refer only to the sample(s) tested and such sample(s) are retained for 90 days only.

除非另有說明，此報告結果僅對測試之樣品負責，同時此樣品僅保留90天。本報告未經本公司書面許可，不可部份複製。

This document is issued by the Company subject to its General Conditions of Service printed overleaf, available on request or accessible at [www.sgs.com/terms\\_and\\_conditions.htm](http://www.sgs.com/terms_and_conditions.htm) and, for electronic format documents, subject to Terms and Conditions for Electronic Documents at [www.sgs.com/terms\\_e-document.htm](http://www.sgs.com/terms_e-document.htm). Attention is drawn to the limitation of liability, indemnification and jurisdiction issues defined therein. Any holder of this document is advised that information contained hereon reflects the Company's findings at the time of its intervention only and within the limits of Client's instructions, if any. The Company's sole responsibility is to its Client and this document does not exonerate parties to a transaction from exercising all their rights and obligations under the transaction documents. This document cannot be reproduced except in full, without prior written approval of the Company. Any unauthorized alteration, forgery or falsification of the content or appearance of this document is unlawful and offenders may be prosecuted to the fullest extent of the law.

## VERIFICATION OF COMPLIANCE

**Applicant:** Fujitsu Limited  
4-1-1, Kamikodanaka, Nakahara-ku, Kawasaki-shi, Kanagawa, 211-8588,  
Japan

**Product Name:** Qubeley

**Brand Name:** Fujitsu

**Model No.:** Q335

**Model Difference:** N/A

**FCC ID:** EJE-WB0092

**IC:** 337J-WB0092

**File Number:** E2/2014/A0049

**Date of test:** Oct. 07, 2014 ~Nov. 10, 2014

**Date of EUT Received:** Nov. 10, 2014

### We hereby certify that:

The above equipment was tested by SGS Taiwan Ltd. Electronics & Communication Laboratory The test data, data evaluation, test procedures, and equipment configurations shown in this report were made in accordance with the procedures given in ANSI C63.4:2009 and RSS-Gen. issue 3 the energy emitted by the sample EUT tested as described in this report is in compliance with conducted and radiated emission limits of FCC Rules Part 15.247 and IC RSS 210 issue 8: 2010 Annex 8.

The test results of this report relate only to the tested sample identified in this report.

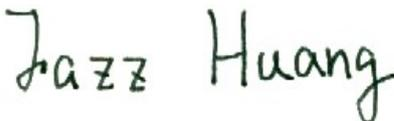
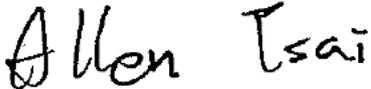
<b>Test By:</b>		<b>Date</b>	Nov. 10, 2014
	<hr/>		<hr/>
	<i>Jazz Huang / Sr. Engineer</i>		
<b>Prepared By:</b>		<b>Date</b>	Nov. 10, 2014
	<hr/>		<hr/>
	<i>Allen Tsai /Engineer</i>		
<b>Approved By:</b>		<b>Date</b>	Nov. 10, 2014
	<hr/>		<hr/>
	<i>Jim Chang / Supervisor</i>		

Unless otherwise stated the results shown in this test report refer only to the sample(s) tested and such sample(s) are retained for 90 days only.

除非另有說明，此報告結果僅對測試之樣品負責，同時此樣品僅保留90天。本報告未經本公司書面許可，不可部份複製。

This document is issued by the Company subject to its General Conditions of Service printed overleaf, available on request or accessible at [www.sgs.com/terms\\_and\\_conditions.htm](http://www.sgs.com/terms_and_conditions.htm) and, for electronic format documents, subject to Terms and Conditions for Electronic Documents at [www.sgs.com/terms\\_e-document.htm](http://www.sgs.com/terms_e-document.htm). Attention is drawn to the limitation of liability, indemnification and jurisdiction issues defined therein. Any holder of this document is advised that information contained hereon reflects the Company's findings at the time of its intervention only and within the limits of Client's instructions, if any. The Company's sole responsibility is to its Client and this document does not exonerate parties to a transaction from exercising all their rights and obligations under the transaction documents. This document cannot be reproduced except in full, without prior written approval of the Company. Any unauthorized alteration, forgery or falsification of the content or appearance of this document is unlawful and offenders may be prosecuted to the fullest extent of the law.

## Version

Version No.	Date	Description
00	Nov. 10, 2014	Initial creation of document

Unless otherwise stated the results shown in this test report refer only to the sample(s) tested and such sample(s) are retained for 90 days only.

除非另有說明，此報告結果僅對測試之樣品負責，同時此樣品僅保留90天。本報告未經本公司書面許可，不可部份複製。

This document is issued by the Company subject to its General Conditions of Service printed overleaf, available on request or accessible at [www.sgs.com/terms\\_and\\_conditions.htm](http://www.sgs.com/terms_and_conditions.htm) and, for electronic format documents, subject to Terms and Conditions for Electronic Documents at [www.sgs.com/terms\\_e-document.htm](http://www.sgs.com/terms_e-document.htm). Attention is drawn to the limitation of liability, indemnification and jurisdiction issues defined therein. Any holder of this document is advised that information contained hereon reflects the Company's findings at the time of its intervention only and within the limits of Client's instructions, if any. The Company's sole responsibility is to its Client and this document does not exonerate parties to a transaction from exercising all their rights and obligations under the transaction documents. This document cannot be reproduced except in full, without prior written approval of the Company. Any unauthorized alteration, forgery or falsification of the content or appearance of this document is unlawful and offenders may be prosecuted to the fullest extent of the law.

## Table of Contents

<b>1</b>	<b>GENERAL INFORMATION.....</b>	<b>6</b>
1.1	Product Description.....	6
1.2	Related Submittal(s) / Grant (s) .....	7
1.3	Test Methodology.....	7
1.4	Test Facility.....	7
1.5	Special Accessories.....	7
1.6	Equipment Modifications.....	7
<b>2</b>	<b>SYSTEM TEST CONFIGURATION.....</b>	<b>8</b>
2.1	EUT Configuration.....	8
2.2	EUT Exercise .....	8
2.3	Test Procedure.....	8
2.4	Configuration of Tested System.....	9
<b>3</b>	<b>SUMMARY OF TEST RESULTS.....</b>	<b>10</b>
<b>4</b>	<b>DESCRIPTION OF TEST MODES.....</b>	<b>10</b>
<b>5</b>	<b>MEASUREMENT UNCERTAINTY .....</b>	<b>11</b>
<b>6</b>	<b>CONDUCTED EMISSION TEST .....</b>	<b>12</b>
6.1	Standard Applicable:.....	12
6.2	Measurement Equipment Used:.....	12
6.3	EUT Setup:.....	13
6.4	Test SET-UP (Block Diagram of Configuration) .....	13
6.5	Measurement Procedure:.....	13
6.6	Measurement Result:.....	13
<b>7</b>	<b>PEAK OUTPUT POWER MEASUREMENT .....</b>	<b>16</b>
7.1	Standard Applicable:.....	16
7.2	Measurement Equipment Used:.....	17
7.3	Test Set-up:.....	17
7.4	Measurement Procedure:.....	18
7.5	Measurement Result:.....	19
<b>8</b>	<b>6dB BANDWIDTH.....</b>	<b>20</b>
8.1	Standard Applicable:.....	20
8.2	Measurement Equipment Used:.....	20
8.3	Test Set-up:.....	20
8.4	Measurement Procedure:.....	20
8.5	Measurement Result:.....	21

Unless otherwise stated the results shown in this test report refer only to the sample(s) tested and such sample(s) are retained for 90 days only.

除非另有說明，此報告結果僅對測試之樣品負責，同時此樣品僅保留90天。本報告未經本公司書面許可，不可部份複製。

This document is issued by the Company subject to its General Conditions of Service printed overleaf, available on request or accessible at [www.sgs.com/terms\\_and\\_conditions.htm](http://www.sgs.com/terms_and_conditions.htm) and, for electronic format documents, subject to Terms and Conditions for Electronic Documents at [www.sgs.com/terms\\_e-document.htm](http://www.sgs.com/terms_e-document.htm). Attention is drawn to the limitation of liability, indemnification and jurisdiction issues defined therein. Any holder of this document is advised that information contained hereon reflects the Company's findings at the time of its intervention only and within the limits of Client's instructions, if any. The Company's sole responsibility is to its Client and this document does not exonerate parties to a transaction from exercising all their rights and obligations under the transaction documents. This document cannot be reproduced except in full, without prior written approval of the Company. Any unauthorized alteration, forgery or falsification of the content or appearance of this document is unlawful and offenders may be prosecuted to the fullest extent of the law.

<b>9</b>	<b>BAND EDGES MEASUREMENT .....</b>	<b>24</b>
9.1	Standard Applicable: .....	24
9.2	Measurement Equipment Used: .....	24
9.3	Test SET-UP:.....	26
9.4	Measurement Procedure:.....	27
9.5	Field Strength Calculation:.....	28
9.6	Measurement Result:.....	28
<b>10</b>	<b>SPURIOUS RADIATED EMISSION TEST .....</b>	<b>32</b>
10.1	Standard Applicable .....	32
10.2	Measurement Equipment Used: .....	33
10.3	Test SET-UP:.....	33
10.4	Measurement Procedure:.....	34
10.5	Field Strength Calculation.....	34
10.6	Measurement Result:.....	34
<b>11</b>	<b>PEAK POWER SPECTRAL DENSITY .....</b>	<b>44</b>
11.1	Standard Applicable: .....	44
11.2	Measurement Equipment Used: .....	44
11.3	Test Set-up:.....	44
11.4	Measurement Procedure: (following the measurement procedure 10.2 of KDB558074):.....	44
11.5	Measurement Result:.....	45
<b>12</b>	<b>ANTENNA REQUIREMENT.....</b>	<b>48</b>
12.1	Standard Applicable: .....	48
12.2	Antenna Connected Construction: .....	48
<b>13</b>	<b>99% BANDWIDTH MEASUREMENT.....</b>	<b>49</b>
13.1	Standard Applicable: .....	49
13.2	Measurement Equipment Used: .....	49
13.3	Test Set-up:.....	49
13.4	Measurement Procedure:.....	49
13.5	Measurement Result:.....	50
	<b>PHOTOGRAPHS OF SET UP.....</b>	<b>52</b>
	<b>PHOTOGRAPHS OF EUT .....</b>	<b>57</b>

Unless otherwise stated the results shown in this test report refer only to the sample(s) tested and such sample(s) are retained for 90 days only.

除非另有說明，此報告結果僅對測試之樣品負責，同時此樣品僅保留90天。本報告未經本公司書面許可，不可部份複製。

This document is issued by the Company subject to its General Conditions of Service printed overleaf, available on request or accessible at [www.sgs.com/terms\\_and\\_conditions.htm](http://www.sgs.com/terms_and_conditions.htm) and, for electronic format documents, subject to Terms and Conditions for Electronic Documents at [www.sgs.com/terms\\_e-document.htm](http://www.sgs.com/terms_e-document.htm). Attention is drawn to the limitation of liability, indemnification and jurisdiction issues defined therein. Any holder of this document is advised that information contained hereon reflects the Company's findings at the time of its intervention only and within the limits of Client's instructions, if any. The Company's sole responsibility is to its Client and this document does not exonerate parties to a transaction from exercising all their rights and obligations under the transaction documents. This document cannot be reproduced except in full, without prior written approval of the Company. Any unauthorized alteration, forgery or falsification of the content or appearance of this document is unlawful and offenders may be prosecuted to the fullest extent of the law.

## 1 GENERAL INFORMATION

### 1.1 Product Description

General:

Product Name:	Qubeley	
Brand Name:	Fujitsu	
Model No.:	Q335	
Model difference:	N/A	
Hardware Version:	D	
Software Version:	3007.6.901.2014	
Data Cable	Model No.: N/A, Supplier: N/A	
Power Supply:	3.8Vdc form Rechargeable Li-ion Battery or 5 Vdc from adapter	
	Battery:	Part No.: FMVNBT37, Supplier: FUJITSU
	Adapter:	Model No.: W12-010N3A, Supplier: CHICONY

### Bluetooth V4.0:

Frequency Range:	2402 – 2480MHz
Bluetooth Version:	V4.0 dual mode + HS (GFSK)
Channel number:	40 channels
Modulation type:	GFSK
Transmit Power:	6.46dBm (Peak)
Antenna Designation:	PIFA Antenna, 0.51dBi, Part No.: DQ614A00013, Supplier: JESS-LINK PRODUCTS CO., LTD
Type of Emission:	1M05F1D

This test report applies for Bluetooth V4.0 function.

Unless otherwise stated the results shown in this test report refer only to the sample(s) tested and such sample(s) are retained for 90 days only.

除非另有說明，此報告結果僅對測試之樣品負責，同時此樣品僅保留90天。本報告未經本公司書面許可，不可部份複製。

This document is issued by the Company subject to its General Conditions of Service printed overleaf, available on request or accessible at [www.sgs.com/terms\\_and\\_conditions.htm](http://www.sgs.com/terms_and_conditions.htm) and, for electronic format documents, subject to Terms and Conditions for Electronic Documents at [www.sgs.com/terms\\_e-document.htm](http://www.sgs.com/terms_e-document.htm). Attention is drawn to the limitation of liability, indemnification and jurisdiction issues defined therein. Any holder of this document is advised that information contained hereon reflects the Company's findings at the time of its intervention only and within the limits of Client's instructions, if any. The Company's sole responsibility is to its Client and this document does not exonerate parties to a transaction from exercising all their rights and obligations under the transaction documents. This document cannot be reproduced except in full, without prior written approval of the Company. Any unauthorized alteration, forgery or falsification of the content or appearance of this document is unlawful and offenders may be prosecuted to the fullest extent of the law.

## 1.2 Related Submittal(s) / Grant (s)

This submittal(s) (test report) is intended for **FCC ID: EJE-WB0092** filing to comply with Section 15.247 of the FCC Part 15, Subpart C Rules. And **IC: 337J-WB0092** filing to comply with Industry Canada RSS-210 issue 8: 2010 Annex 8. The composite system (digital device) is compliance with Subpart B is authorized under a DoC procedure.

## 1.3 Test Methodology

Both conducted and radiated testing was performed according to the procedures in ANSI C63.4:2009 and RSS-Gen: 2010. Radiated testing was performed at an antenna to EUT distance 3 meters.

Tested in accordance with Jun 2014 KDB558074 D01 v03r02 for compliance to FCC 47CFR 15.247 requirements.

## 1.4 Test Facility

The measurement facilities used to collect the 3m Radiated Emission and AC power line conducted data are located on the address of SGS Taiwan Ltd. Electronics & Communication Laboratory No.2, Keji 1st Rd., Guishan Township, Taoyuan County, Taiwan which are constructed and calibrated to meet the FCC requirements in documents ANSI C63.4: 2009. FCC Registration Number: 628985. The address of SGS Taiwan Ltd. Electronics & Communication Laboratory 1F, No.134, Wukung Road New Taipei City TAIWAN 24803, Canada Registration Number: 4620A-5.

The 10 m Open Area Test Sites located on the address of SGS Taiwan Ltd. Electronics & Communication Laboratory No.2, Keji 1st Rd., Guishan Township, Taoyuan County, Taiwan which is constructed and calibrated to meet the CISPR 22/EN 55022 requirements. FCC Registration Number: 455997. The address of SGS Taiwan Ltd. Electronics & Communication Laboratory 1F, No.134, Wukung Road New Taipei City TAIWAN 24803, IC Registration Number: 4620A-6.

## 1.5 Special Accessories

There are no special accessories used while test was conducted.

## 1.6 Equipment Modifications

There was no modification incorporated into the EUT.

Unless otherwise stated the results shown in this test report refer only to the sample(s) tested and such sample(s) are retained for 90 days only.

除非另有說明，此報告結果僅對測試之樣品負責，同時此樣品僅保留90天。本報告未經本公司書面許可，不可部份複製。

This document is issued by the Company subject to its General Conditions of Service printed overleaf, available on request or accessible at [www.sgs.com/terms\\_and\\_conditions.htm](http://www.sgs.com/terms_and_conditions.htm) and, for electronic format documents, subject to Terms and Conditions for Electronic Documents at [www.sgs.com/terms\\_e-document.htm](http://www.sgs.com/terms_e-document.htm). Attention is drawn to the limitation of liability, indemnification and jurisdiction issues defined therein. Any holder of this document is advised that information contained hereon reflects the Company's findings at the time of its intervention only and within the limits of Client's instructions, if any. The Company's sole responsibility is to its Client and this document does not exonerate parties to a transaction from exercising all their rights and obligations under the transaction documents. This document cannot be reproduced except in full, without prior written approval of the Company. Any unauthorized alteration, forgery or falsification of the content or appearance of this document is unlawful and offenders may be prosecuted to the fullest extent of the law.

## 2 SYSTEM TEST CONFIGURATION

### 2.1 EUT Configuration

The EUT configuration for testing is installed on RF field strength measurement to meet the Commissions requirement and operating in a manner which intends to maximize its emission characteristics in a continuous normal application.

### 2.2 EUT Exercise

An engineering test mode (software/firmware) that applicant provided was utilized to manipulate the EUT into transmit, selection of the test channel, and modulation scheme.

### 2.3 Test Procedure

#### 2.3.1 Conducted Emissions

The EUT is a placed on as turn table which is 0.8 m above ground plane. According to the general criterion in Section 7.1 of ANSI C63.4:2009. Conducted emissions from the EUT measured in the frequency range between 0.15 MHz and 30MHz, and the measurement procedure 7.3 in ANSI 63.4:2009 & 6.2.2 is followed to carry out the test. The CISPR Quasi-Peak and Average detector mode is employed according to §15.107

#### 2.3.2 Radiated Emissions

The EUT is a placed on as turn table which is 0.8 m above ground plane. The turn table shall rotate 360 degrees to determine the position of maximum emission level. EUT is set 3m away from the receiving antenna which varied from 1m to 4m to find out the highest emission. And also, each emission was to be maximized by changing the polarization of receiving antenna both horizontal and vertical. In order to find out the max. emission, the relative positions of this hand-held transmitter (EUT) was rotated through three orthogonal axes and measurement procedures for electric field radiated emissions above 1 GHz the EUT measurement is to be made “while keeping the antenna in the ‘cone of radiation’ from that area and pointed at the area both in azimuth and elevation, with polarization oriented for maximum response.” is still within the 3dB illumination BW of the measurement antenna. according to the requirements in Section 8 and 13 and of ANSI C63.4:2009, & Section 6.3, 6.4, 6.5.

Unless otherwise stated the results shown in this test report refer only to the sample(s) tested and such sample(s) are retained for 90 days only.

除非另有說明，此報告結果僅對測試之樣品負責，同時此樣品僅保留90天。本報告未經本公司書面許可，不可部份複製。

This document is issued by the Company subject to its General Conditions of Service printed overleaf, available on request or accessible at [www.sgs.com/terms\\_and\\_conditions.htm](http://www.sgs.com/terms_and_conditions.htm) and, for electronic format documents, subject to Terms and Conditions for Electronic Documents at [www.sgs.com/terms\\_e-document.htm](http://www.sgs.com/terms_e-document.htm). Attention is drawn to the limitation of liability, indemnification and jurisdiction issues defined therein. Any holder of this document is advised that information contained hereon reflects the Company's findings at the time of its intervention only and within the limits of Client's instructions, if any. The Company's sole responsibility is to its Client and this document does not exonerate parties to a transaction from exercising all their rights and obligations under the transaction documents. This document cannot be reproduced except in full, without prior written approval of the Company. Any unauthorized alteration, forgery or falsification of the content or appearance of this document is unlawful and offenders may be prosecuted to the fullest extent of the law.

## 2.4 Configuration of Tested System

**Fig. 2-1 Radiated & Conducted (Antenna Port) & Conduction Emission**

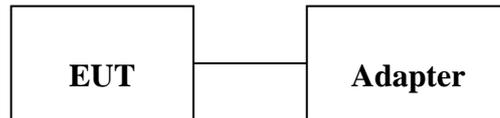

**Table 2-2 Equipment Used in Tested System**

Item	Equipment	Mfr/Brand	Model/Type No.	Series No.	Data Cable	Power Cord
1.	Bluetooth4.0 Test Software	N/A	MP Tool	N/A	N/A	N/A

Unless otherwise stated the results shown in this test report refer only to the sample(s) tested and such sample(s) are retained for 90 days only.

除非另有說明，此報告結果僅對測試之樣品負責，同時此樣品僅保留90天。本報告未經本公司書面許可，不可部份複製。

This document is issued by the Company subject to its General Conditions of Service printed overleaf, available on request or accessible at [www.sgs.com/terms\\_and\\_conditions.htm](http://www.sgs.com/terms_and_conditions.htm) and, for electronic format documents, subject to Terms and Conditions for Electronic Documents at [www.sgs.com/terms\\_e-document.htm](http://www.sgs.com/terms_e-document.htm). Attention is drawn to the limitation of liability, indemnification and jurisdiction issues defined therein. Any holder of this document is advised that information contained hereon reflects the Company's findings at the time of its intervention only and within the limits of Client's instructions, if any. The Company's sole responsibility is to its Client and this document does not exonerate parties to a transaction from exercising all their rights and obligations under the transaction documents. This document cannot be reproduced except in full, without prior written approval of the Company. Any unauthorized alteration, forgery or falsification of the content or appearance of this document is unlawful and offenders may be prosecuted to the fullest extent of the law.

### 3 SUMMARY OF TEST RESULTS

FCC/IC Rules	Description Of Test	Result
§15.207(a) RSS-Gen §7.2.4	AC Power Line Conducted Emission	Compliant
§15.247(b) (3) RSS-210 §A8.4(4)	Peak Output Power	Compliant
§15.247(a)(2) RSS-210 §A8.2(a) RSS-Gen §4.6.2	6dB Bandwidth	Compliant
§15.247(d) RSS-210 §A8.5	100 KHz Bandwidth Of Frequency Band Edges	Compliant
§15.247(d) RSS-210 §A8.5	Spurious Emission	Compliant
§15.247(e) RSS-210 §A8.2(b)	Peak Power Density	Compliant
§15.203 RSS-GEN §7.1.2,	Antenna Requirement	Compliant
RSS-Gen §4.6.1	99% Power Bandwidth	Compliant

### 4 DESCRIPTION OF TEST MODES

The EUT has been tested under operating condition.

Test program used to control the EUT for staying in continuous transmitting and receiving mode is programmed.

Channel low (2402MHz)、 mid (2442MHz) and high (2480MHz) with BT 4.0 mode is chosen for full testing.

The field strength of radiation emission was measured as EUT stand-up position (H mode) and lie down position (E1, E2 mode) for BT 4.0 mode Transmitter for channel Low, Mid and High, the worst case E2 position was reported.

Unless otherwise stated the results shown in this test report refer only to the sample(s) tested and such sample(s) are retained for 90 days only.

除非另有說明，此報告結果僅對測試之樣品負責，同時此樣品僅保留90天。本報告未經本公司書面許可，不可部份複製。

This document is issued by the Company subject to its General Conditions of Service printed overleaf, available on request or accessible at [www.sgs.com/terms\\_and\\_conditions.htm](http://www.sgs.com/terms_and_conditions.htm) and, for electronic format documents, subject to Terms and Conditions for Electronic Documents at [www.sgs.com/terms\\_e-document.htm](http://www.sgs.com/terms_e-document.htm). Attention is drawn to the limitation of liability, indemnification and jurisdiction issues defined therein. Any holder of this document is advised that information contained hereon reflects the Company's findings at the time of its intervention only and within the limits of Client's instructions, if any. The Company's sole responsibility is to its Client and this document does not exonerate parties to a transaction from exercising all their rights and obligations under the transaction documents. This document cannot be reproduced except in full, without prior written approval of the Company. Any unauthorized alteration, forgery or falsification of the content or appearance of this document is unlawful and offenders may be prosecuted to the fullest extent of the law.

## 5 MEASUREMENT UNCERTAINTY

Test Items	Uncertainty
AC Power Line Conducted Emission	+/- 2.586 dB
Peak Output Power	+/- 1.42 dB
6dB Bandwidth	+/- 123.36 Hz
100 KHz Bandwidth Of Frequency Band Edges	+/- 1.55 dB
Peak Power Density	+/- 1.55 dB
99% Power Bandwidth	+/- 123.36 Hz
Temperature	+/- 0.8 °C
Humidity	+/- 4.7 %
DC / AC Power Source	DC= +/- 1%, AC= +/- 0.2%

Radiated Spurious Emission:

Measurement uncertainty (Polarization : <b>Vertical</b> )	30MHz - 180MHz: +/- 3.37dB
	180MHz -417MHz: +/- 3.19dB
	0.417GHz-1GHz: +/- 3.19dB
	1GHz - 18GHz: +/- 4.04dB
	18GHz - 40GHz: +/- 4.04dB

Measurement uncertainty (Polarization : <b>Horizontal</b> )	30MHz - 167MHz: +/- 4.22dB
	167MHz -500MHz: +/- 3.44dB
	0.5GHz-1GHz: +/- 3.39dB
	1GHz - 18GHz: +/- 4.08dB
	18GHz - 40GHz: +/- 4.08dB

This uncertainty represents an expanded uncertainty expressed at approximately the 95% confidence level using a coverage factor of k=2.

Unless otherwise stated the results shown in this test report refer only to the sample(s) tested and such sample(s) are retained for 90 days only.

除非另有說明，此報告結果僅對測試之樣品負責，同時此樣品僅保留90天。本報告未經本公司書面許可，不可部份複製。

This document is issued by the Company subject to its General Conditions of Service printed overleaf, available on request or accessible at [www.sgs.com/terms\\_and\\_conditions.htm](http://www.sgs.com/terms_and_conditions.htm) and, for electronic format documents, subject to Terms and Conditions for Electronic Documents at [www.sgs.com/terms\\_e-document.htm](http://www.sgs.com/terms_e-document.htm). Attention is drawn to the limitation of liability, indemnification and jurisdiction issues defined therein. Any holder of this document is advised that information contained hereon reflects the Company's findings at the time of its intervention only and within the limits of Client's instructions, if any. The Company's sole responsibility is to its Client and this document does not exonerate parties to a transaction from exercising all their rights and obligations under the transaction documents. This document cannot be reproduced except in full, without prior written approval of the Company. Any unauthorized alteration, forgery or falsification of the content or appearance of this document is unlawful and offenders may be prosecuted to the fullest extent of the law.

## 6 CONDUCTED EMISSION TEST

### 6.1 Standard Applicable:

According to §15.207 and RSS-Gen §7.2.4, frequency range within 150KHz to 30MHz shall not exceed the Limit table as below.

Frequency range MHz	Limits dB(uV)	
	Quasi-peak	Average
0.15 to 0.50	66 to 56	56 to 46
0.50 to 5	56	46
5 to 30	60	50

Note

- 1.The lower limit shall apply at the transition frequencies
- 2.The limit decreases linearly with the logarithm of the frequency in the range 0.15 MHz to 0.50 MHz.

### 6.2 Measurement Equipment Used:

SGS Conducted Emission Test Site No.A					
Name of Equipment	Manufacturer	Model	Serial Number	Calibration Date	Calibration Due
EMI Test Receiver	R&S	ESCI 3	101311	2014/6/20	2015/6/19
Coaxial Cables	N/A	N30N30-1042-150cm	N/A	2014/2/7	2015/2/6
LISN	Schwarzbeck	NSLK 8127	8127-648	2014/6/10	2015/6/9
LISN	Rolf-Heine	NNB-2/16Z	99012	2014/3/26	2015/3/25
Test Software	Farad	EZ-EMC	Ver. SGS-03A2	N.C.R.	N.C.R.
EMI Test Receiver	R&S	ESCI 3	101311	2014/6/20	2015/6/19

Unless otherwise stated the results shown in this test report refer only to the sample(s) tested and such sample(s) are retained for 90 days only.

除非另有說明，此報告結果僅對測試之樣品負責，同時此樣品僅保留90天。本報告未經本公司書面許可，不可部份複製。

This document is issued by the Company subject to its General Conditions of Service printed overleaf, available on request or accessible at [www.sgs.com/terms\\_and\\_conditions.htm](http://www.sgs.com/terms_and_conditions.htm) and, for electronic format documents, subject to Terms and Conditions for Electronic Documents at [www.sgs.com/terms\\_e-document.htm](http://www.sgs.com/terms_e-document.htm). Attention is drawn to the limitation of liability, indemnification and jurisdiction issues defined therein. Any holder of this document is advised that information contained hereon reflects the Company's findings at the time of its intervention only and within the limits of Client's instructions, if any. The Company's sole responsibility is to its Client and this document does not exonerate parties to a transaction from exercising all their rights and obligations under the transaction documents. This document cannot be reproduced except in full, without prior written approval of the Company. Any unauthorized alteration, forgery or falsification of the content or appearance of this document is unlawful and offenders may be prosecuted to the fullest extent of the law.

### 6.3 EUT Setup:

1. The conducted emission tests were performed in the test site, using the setup in accordance with the ANSI C63.4:2009.
2. The AC/DC Power adaptor of EUT was plug-in LISN. The EUT was placed flushed with the rear of the table.
3. The LISN was connected with 120Vac/60Hz power source.

### 6.4 Test SET-UP (Block Diagram of Configuration)

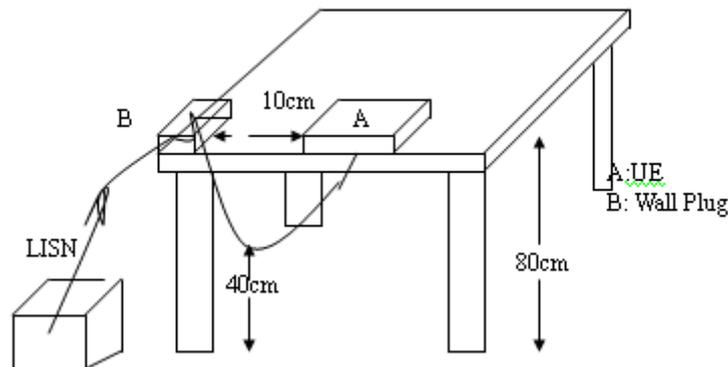

### 6.5 Measurement Procedure:

1. The EUT was placed on a table which is 0.8m above ground plane.
2. Maximum procedure was performed on the six highest emissions to ensure EUT compliance.
3. Repeat above procedures until all phases of power being supplied by given UE are completed

### 6.6 Measurement Result:

The initial step in collecting conducted data is a spectrum analyzer peak scan of the measurement range. Significant peaks are then marked as shown on the following data page, and these signals are then quasi-peaked.

Note: Refer to next page for measurement data and plots.

Note2: The \* reveals the worst-case results that closet to the limit.

Unless otherwise stated the results shown in this test report refer only to the sample(s) tested and such sample(s) are retained for 90 days only.

除非另有說明，此報告結果僅對測試之樣品負責，同時此樣品僅保留90天。本報告未經本公司書面許可，不可部份複製。

This document is issued by the Company subject to its General Conditions of Service printed overleaf, available on request or accessible at [www.sgs.com/terms\\_and\\_conditions.htm](http://www.sgs.com/terms_and_conditions.htm) and, for electronic format documents, subject to Terms and Conditions for Electronic Documents at [www.sgs.com/terms\\_e-document.htm](http://www.sgs.com/terms_e-document.htm). Attention is drawn to the limitation of liability, indemnification and jurisdiction issues defined therein. Any holder of this document is advised that information contained hereon reflects the Company's findings at the time of its intervention only and within the limits of Client's instructions, if any. The Company's sole responsibility is to its Client and this document does not exonerate parties to a transaction from exercising all their rights and obligations under the transaction documents. This document cannot be reproduced except in full, without prior written approval of the Company. Any unauthorized alteration, forgery or falsification of the content or appearance of this document is unlawful and offenders may be prosecuted to the fullest extent of the law.

### AC POWER LINE CONDUCTED EMISSION TEST DATA

Operation Mode:	Operation mode		Test Date:	Oct. 27, 2014	
Temperature:	24	Humidity:	60 %	Test By:	Tai
Model No.:	Q335		Phase:	L1	

80.0 dBuV

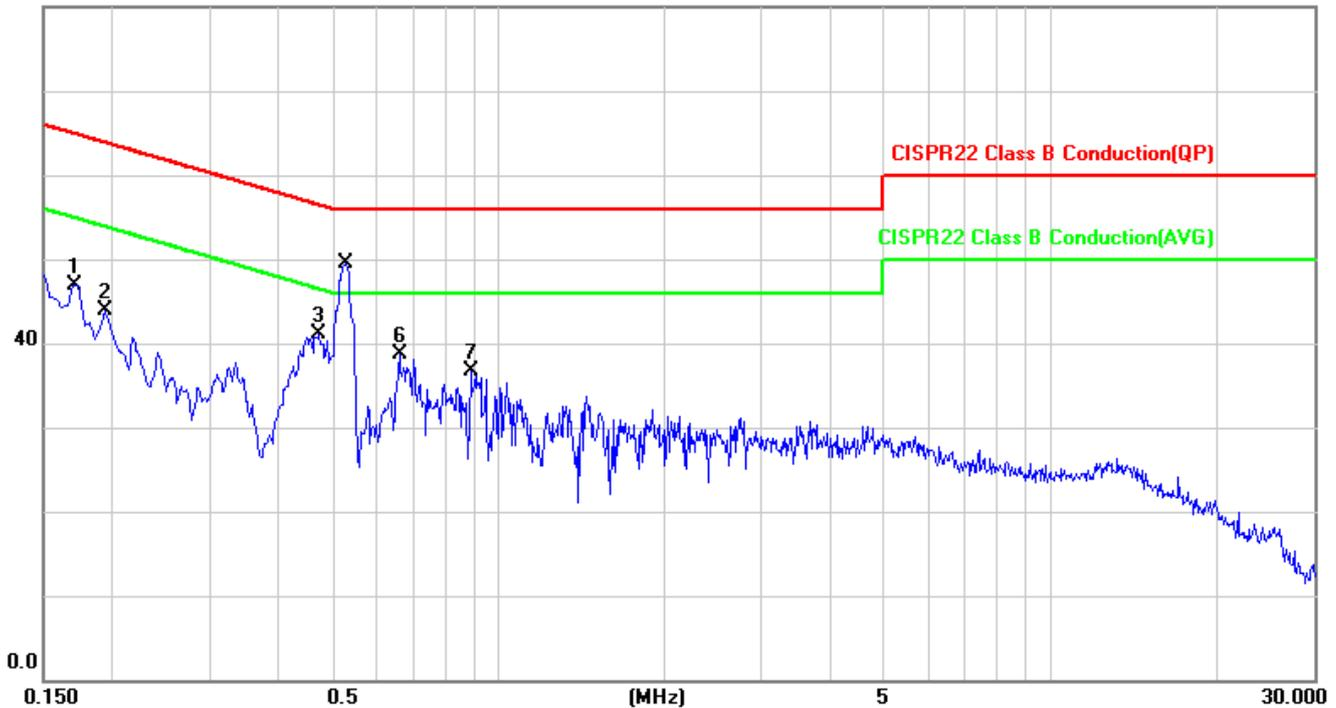

No.	Mk.	Freq. (MHz)	Reading (dBuV)	Factor (dB)	Measurement (dBuV)	Limit (dBuV)	Over (dB)	Detector	Comment
1		0.1700	46.81	0.13	46.94	64.96	-18.02	peak	
2		0.1940	43.75	0.13	43.88	63.86	-19.98	peak	
3		0.4740	40.90	0.13	41.03	56.44	-15.41	peak	
4		0.5300	48.10	0.13	48.23	56.00	-7.77	QP	
5	*	0.5300	39.10	0.13	39.23	46.00	-6.77	AVG	
6		0.6620	38.55	0.13	38.68	56.00	-17.32	peak	
7		0.8940	36.59	0.13	36.72	56.00	-19.28	peak	

Unless otherwise stated the results shown in this test report refer only to the sample(s) tested and such sample(s) are retained for 90 days only.

除非另有說明，此報告結果僅對測試之樣品負責，同時此樣品僅保留90天。本報告未經本公司書面許可，不可部份複製。

This document is issued by the Company subject to its General Conditions of Service printed overleaf, available on request or accessible at [www.sgs.com/terms\\_and\\_conditions.htm](http://www.sgs.com/terms_and_conditions.htm) and, for electronic format documents, subject to Terms and Conditions for Electronic Documents at [www.sgs.com/terms\\_e-document.htm](http://www.sgs.com/terms_e-document.htm). Attention is drawn to the limitation of liability, indemnification and jurisdiction issues defined therein. Any holder of this document is advised that information contained hereon reflects the Company's findings at the time of its intervention only and within the limits of Client's instructions, if any. The Company's sole responsibility is to its Client and this document does not exonerate parties to a transaction from exercising all their rights and obligations under the transaction documents. This document cannot be reproduced except in full, without prior written approval of the Company. Any unauthorized alteration, forgery or falsification of the content or appearance of this document is unlawful and offenders may be prosecuted to the fullest extent of the law.

Operation Mode:	Operation mode		Test Date:	Oct. 27, 2014	
Temperature:	24	Humidity:	60 %	Test By:	Tai
Model No.:	Q335		Phase:	N	

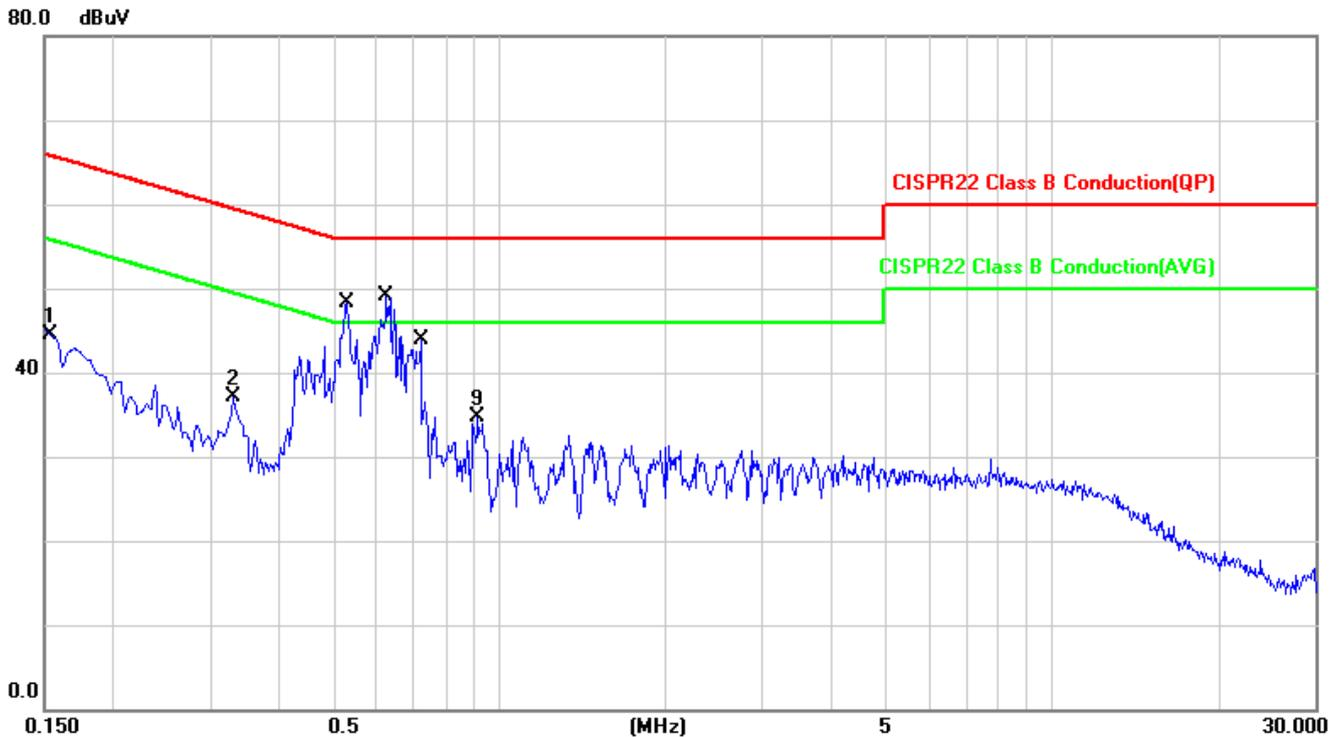

No.	Mk.	Freq. (MHz)	Reading (dBuV)	Factor (dB)	Measurement (dBuV)	Limit (dBuV)	Over (dB)	Detector	Comment
1		0.1540	44.28	0.13	44.41	65.78	-21.37	peak	
2		0.3300	36.90	0.13	37.03	59.45	-22.42	peak	
3		0.5300	45.30	0.13	45.43	56.00	-10.57	QP	
4	*	0.5300	39.60	0.13	39.73	46.00	-6.27	AVG	
5		0.6260	42.10	0.13	42.23	56.00	-13.77	QP	
6		0.6260	34.40	0.13	34.53	46.00	-11.47	AVG	
7		0.7220	36.00	0.13	36.13	56.00	-19.87	QP	
8		0.7220	27.90	0.13	28.03	46.00	-17.97	AVG	
9		0.9140	34.63	0.13	34.76	56.00	-21.24	peak	

Unless otherwise stated the results shown in this test report refer only to the sample(s) tested and such sample(s) are retained for 90 days only.

除非另有說明，此報告結果僅對測試之樣品負責，同時此樣品僅保留90天。本報告未經本公司書面許可，不可部份複製。

This document is issued by the Company subject to its General Conditions of Service printed overleaf, available on request or accessible at [www.sgs.com/terms\\_and\\_conditions.htm](http://www.sgs.com/terms_and_conditions.htm) and, for electronic format documents, subject to Terms and Conditions for Electronic Documents at [www.sgs.com/terms\\_e-document.htm](http://www.sgs.com/terms_e-document.htm). Attention is drawn to the limitation of liability, indemnification and jurisdiction issues defined therein. Any holder of this document is advised that information contained hereon reflects the Company's findings at the time of its intervention only and within the limits of Client's instructions, if any. The Company's sole responsibility is to its Client and this document does not exonerate parties to a transaction from exercising all their rights and obligations under the transaction documents. This document cannot be reproduced except in full, without prior written approval of the Company. Any unauthorized alteration, forgery or falsification of the content or appearance of this document is unlawful and offenders may be prosecuted to the fullest extent of the law.

## 7 PEAK OUTPUT POWER MEASUREMENT

### 7.1 Standard Applicable:

According to §15.247 (b)

(3) For systems using digital modulation in the 902-928 MHz, and 2400-2483.5 MHz

bands: 1 Watt. As an alternative to a peak power measurement, compliance with the one Watt limit can be based on a measurement of the maximum conducted output power. Maximum Conducted Output Power is defined as the total transmit power delivered to all antennas and antenna elements averaged across all symbols in the signaling alphabet when the transmitter is operating at its maximum power control level. Power must be summed across all antennas and antenna elements. The average must not include any time intervals during which the transmitter is off or is transmitting at a reduced power level. If multiple modes of operation are possible (e.g., alternative modulation methods), the maximum conducted output power is the highest total transmit power occurring in any mode.

(4) The conducted output power limit specified in paragraph (b) of this section is based on the use of antennas with directional gains that do not exceed 6 dBi. Except as shown in paragraph (c) of this section, if transmitting antennas of directional gain greater than 6 dBi are used, the conducted output power from the intentional radiator shall be reduced below the stated values in paragraphs (b)(1), (b)(2), and (b)(3) of this section, as appropriate, by the amount in dB that the directional gain of the antenna exceeds 6 dBi.

According to RSS-210 issue 8, §A8.4(4), for systems employing digital modulation techniques operating in the bands 902-928 MHz, 2400-2483.5 MHz and 5725-5850 MHz, the maximum peak conducted output power shall not exceed 1 W. Except as provided in Section A8.4 (5), the e.i.r.p. shall not exceed 4 W.

As an alternative to a peak power measurement, compliance can be based on a measurement of the maximum conducted output power. The maximum conducted output power is the total transmit power delivered to all antennas and antenna elements, averaged across all symbols in the signaling alphabet when the transmitter is operating at its maximum power control level. Power must be summed across all antennas and antenna elements. The average must not include any time intervals during which the transmitter is off or transmitting at a reduced power level. If multiple modes of operation are implemented, the maximum conducted output power is the highest total transmit power occurring in any mode.

Unless otherwise stated the results shown in this test report refer only to the sample(s) tested and such sample(s) are retained for 90 days only.

除非另有說明，此報告結果僅對測試之樣品負責，同時此樣品僅保留90天。本報告未經本公司書面許可，不可部份複製。

This document is issued by the Company subject to its General Conditions of Service printed overleaf, available on request or accessible at [www.sgs.com/terms\\_and\\_conditions.htm](http://www.sgs.com/terms_and_conditions.htm) and, for electronic format documents, subject to Terms and Conditions for Electronic Documents at [www.sgs.com/terms\\_e-document.htm](http://www.sgs.com/terms_e-document.htm). Attention is drawn to the limitation of liability, indemnification and jurisdiction issues defined therein. Any holder of this document is advised that information contained hereon reflects the Company's findings at the time of its intervention only and within the limits of Client's instructions, if any. The Company's sole responsibility is to its Client and this document does not exonerate parties to a transaction from exercising all their rights and obligations under the transaction documents. This document cannot be reproduced except in full, without prior written approval of the Company. Any unauthorized alteration, forgery or falsification of the content or appearance of this document is unlawful and offenders may be prosecuted to the fullest extent of the law.

### 7.2 Measurement Equipment Used:

SGS Conducted Room(ALL)					
Name of Equipment	Manufacturer	Model	Serial Number	Calibration Date	Calibration Due
Power Meter	Anritsu	ML2496A	1326001	2014/6/20	2015/6/19
Power Sensor	Anritsu	MA2411B	1315048	2014/6/20	2015/6/19
Power Sensor	Anritsu	MA2411B	1315049	2014/6/20	2015/6/19
Spectrum Analyzer	Agilent	N9010A	MY53400256	2014/10/15	2015/10/14
DC Block	PASTERNAK	PE8210	5	2014/1/6	2015/1/5
Coaxial Cable 80cm	WOKEN	00100A1F1A185C	1	2014/1/6	2015/1/5

### 7.3 Test Set-up:

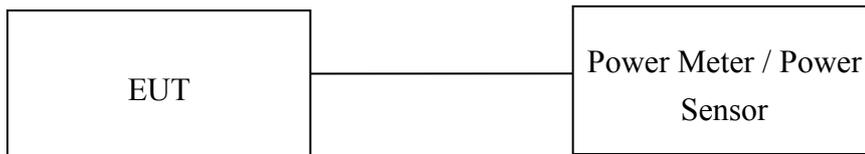

Unless otherwise stated the results shown in this test report refer only to the sample(s) tested and such sample(s) are retained for 90 days only.

除非另有說明，此報告結果僅對測試之樣品負責，同時此樣品僅保留90天。本報告未經本公司書面許可，不可部份複製。

This document is issued by the Company subject to its General Conditions of Service printed overleaf, available on request or accessible at [www.sgs.com/terms\\_and\\_conditions.htm](http://www.sgs.com/terms_and_conditions.htm) and, for electronic format documents, subject to Terms and Conditions for Electronic Documents at [www.sgs.com/terms\\_e-document.htm](http://www.sgs.com/terms_e-document.htm). Attention is drawn to the limitation of liability, indemnification and jurisdiction issues defined therein. Any holder of this document is advised that information contained hereon reflects the Company's findings at the time of its intervention only and within the limits of Client's instructions, if any. The Company's sole responsibility is to its Client and this document does not exonerate parties to a transaction from exercising all their rights and obligations under the transaction documents. This document cannot be reproduced except in full, without prior written approval of the Company. Any unauthorized alteration, forgery or falsification of the content or appearance of this document is unlawful and offenders may be prosecuted to the fullest extent of the law.

#### 7.4 Measurement Procedure:

1. Place the EUT on the table and set it in transmitting mode.
2. Remove the antenna from the EUT and then connect a low loss RF cable from the antenna port to the power meter or spectrum. (**Peak power setting on Spectrum:** Channel power function, RBW = 1MHz, VBW = 3MHz, Span: 30/60MHz, Detector =peak, Sweep = Auto. Setting on spectrum is adjusted based on the mandatory procedure in 9.1.2 of the KDB558074). Power Meter is used as the auxiliary test equipment to conduct the output power measurement. 9.1.3 in KDB558074 is followed.  
(**Avg. power setting on Spectrum:** Channel power function, RBW = 1MHz, VBW = 3MHz, Span: 30/60MHz, Detector =Avg., Trace avg =100, Sweep = Auto, Setting on spectrum is adjusted based on the mandatory procedure in 9.2.2.4 of the KDB558074). Power Meter is used as the auxiliary test equipment to conduct the output power measurement. 9.2.3, option 3 in KDB558074 is followed.
3. Record the max. Reading as observed from Spectrum or Power Meter.
4. Repeat above procedures until all test default channel measured was complete.

#### Duty Factor:

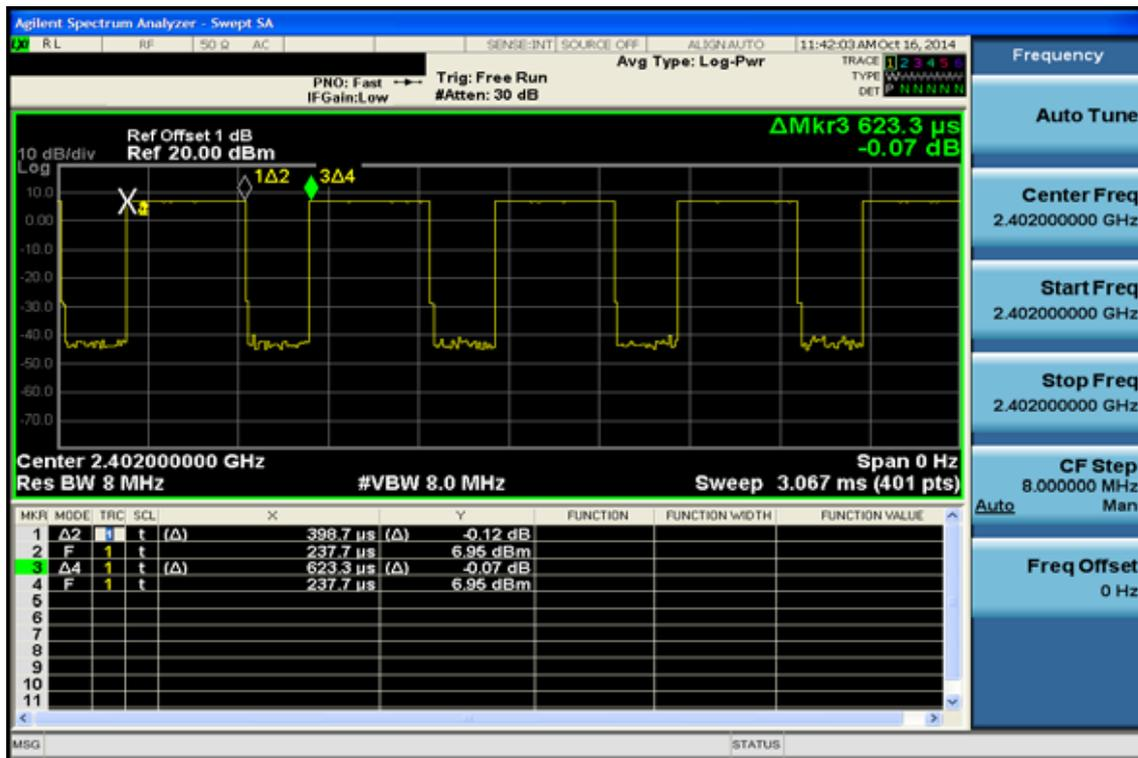

Unless otherwise stated the results shown in this test report refer only to the sample(s) tested and such sample(s) are retained for 90 days only.

除非另有說明，此報告結果僅對測試之樣品負責，同時此樣品僅保留90天。本報告未經本公司書面許可，不可部份複製。

This document is issued by the Company subject to its General Conditions of Service printed overleaf, available on request or accessible at [www.sgs.com/terms\\_and\\_conditions.htm](http://www.sgs.com/terms_and_conditions.htm) and, for electronic format documents, subject to Terms and Conditions for Electronic Documents at [www.sgs.com/terms\\_e-document.htm](http://www.sgs.com/terms_e-document.htm). Attention is drawn to the limitation of liability, indemnification and jurisdiction issues defined therein. Any holder of this document is advised that information contained hereon reflects the Company's findings at the time of its intervention only and within the limits of Client's instructions, if any. The Company's sole responsibility is to its Client and this document does not exonerate parties to a transaction from exercising all their rights and obligations under the transaction documents. This document cannot be reproduced except in full, without prior written approval of the Company. Any unauthorized alteration, forgery or falsification of the content or appearance of this document is unlawful and offenders may be prosecuted to the fullest extent of the law.

## 7.5 Measurement Result:

### BT4.0 mode:

CH	Frequency (MHz)	Peak Power Output(dBm)	Required Limit
0	2402	6.46	1 Watt = 30 dBm
20	2442	6	1 Watt = 30 dBm
39	2480	3.1	1 Watt = 30 dBm

CH	Frequency (MHz)	Average Power Output(dBm)	Required Limit
0	2402	5.96	1 Watt = 30 dBm
20	2442	5.5	1 Watt = 30 dBm
39	2480	2.57	1 Watt = 30 dBm

*\*Note: Measured by power meter, cable loss as 1dB that offsets on the power meter in Peak*

*\*Note: Measured by power meter, as cable loss+ Duty cycle factor that offsets on the power meter*

Unless otherwise stated the results shown in this test report refer only to the sample(s) tested and such sample(s) are retained for 90 days only.

除非另有說明，此報告結果僅對測試之樣品負責，同時此樣品僅保留90天。本報告未經本公司書面許可，不可部份複製。

This document is issued by the Company subject to its General Conditions of Service printed overleaf, available on request or accessible at [www.sgs.com/terms\\_and\\_conditions.htm](http://www.sgs.com/terms_and_conditions.htm) and, for electronic format documents, subject to Terms and Conditions for Electronic Documents at [www.sgs.com/terms\\_e-document.htm](http://www.sgs.com/terms_e-document.htm). Attention is drawn to the limitation of liability, indemnification and jurisdiction issues defined therein. Any holder of this document is advised that information contained hereon reflects the Company's findings at the time of its intervention only and within the limits of Client's instructions, if any. The Company's sole responsibility is to its Client and this document does not exonerate parties to a transaction from exercising all their rights and obligations under the transaction documents. This document cannot be reproduced except in full, without prior written approval of the Company. Any unauthorized alteration, forgery or falsification of the content or appearance of this document is unlawful and offenders may be prosecuted to the fullest extent of the law.

## 8 6dB BANDWIDTH

### 8.1 Standard Applicable:

According to §15.247(a)(2), Systems using digital modulation techniques may operate in the 902 - 928 MHz, 2400 - 2483.5 MHz, bands. The minimum 6 dB bandwidth shall be at least 500kHz.

According to RSS 210 issue 8: 2010 Annex 8.2. Systems employing digital modulation techniques (which includes direct sequence) can now be certified under RSS-210 provided they comply with the following requirements: The minimum 6 dB bandwidth shall be at least 500 kHz.

### 8.2 Measurement Equipment Used:

Refer to section 7.2 for details.

### 8.3 Test Set-up:

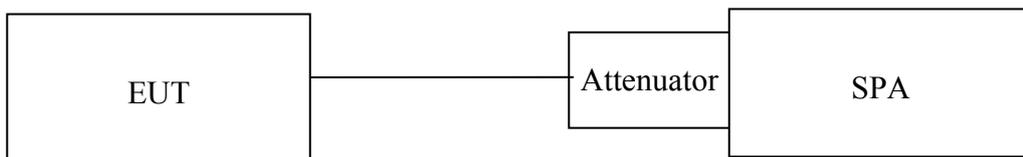

### 8.4 Measurement Procedure:

1. Place the EUT on the table and set it in transmitting mode.
2. Remove the antenna from the EUT and then connect a low loss RF cable from the antenna port to the spectrum analyzer.
3. Set the spectrum analyzer as RBW = 100 kHz, VBW = 3\*RBW, Span = 5MHz, Detector=Peak, Sweep=auto, the setting on spectrum is adjusted based on the procedure as guide in 8.1 option 1 of KDB558074.
4. Mark the peak frequency and -6dB (upper and lower) frequency.
5. Repeat above procedures until all test default channel measured were complete.

Unless otherwise stated the results shown in this test report refer only to the sample(s) tested and such sample(s) are retained for 90 days only.

除非另有說明，此報告結果僅對測試之樣品負責，同時此樣品僅保留90天。本報告未經本公司書面許可，不可部份複製。

This document is issued by the Company subject to its General Conditions of Service printed overleaf, available on request or accessible at [www.sgs.com/terms\\_and\\_conditions.htm](http://www.sgs.com/terms_and_conditions.htm) and, for electronic format documents, subject to Terms and Conditions for Electronic Documents at [www.sgs.com/terms\\_e-document.htm](http://www.sgs.com/terms_e-document.htm). Attention is drawn to the limitation of liability, indemnification and jurisdiction issues defined therein. Any holder of this document is advised that information contained hereon reflects the Company's findings at the time of its intervention only and within the limits of Client's instructions, if any. The Company's sole responsibility is to its Client and this document does not exonerate parties to a transaction from exercising all their rights and obligations under the transaction documents. This document cannot be reproduced except in full, without prior written approval of the Company. Any unauthorized alteration, forgery or falsification of the content or appearance of this document is unlawful and offenders may be prosecuted to the fullest extent of the law.

## 8.5 Measurement Result:

### BT4.0 mode

Frequency (MHz)	Bandwidth (kHz)	Bandwidth (kHz)	Result
2402	714.2	> 500	PASS
2442	715.4	> 500	PASS
2480	722.8	> 500	PASS

\* *Cable loss as 1dB that offsets on the spectrum.*

*Note: Refer to next page for plots.*

Unless otherwise stated the results shown in this test report refer only to the sample(s) tested and such sample(s) are retained for 90 days only.

除非另有說明，此報告結果僅對測試之樣品負責，同時此樣品僅保留90天。本報告未經本公司書面許可，不可部份複製。

This document is issued by the Company subject to its General Conditions of Service printed overleaf, available on request or accessible at [www.sgs.com/terms\\_and\\_conditions.htm](http://www.sgs.com/terms_and_conditions.htm) and, for electronic format documents, subject to Terms and Conditions for Electronic Documents at [www.sgs.com/terms\\_e-document.htm](http://www.sgs.com/terms_e-document.htm). Attention is drawn to the limitation of liability, indemnification and jurisdiction issues defined therein. Any holder of this document is advised that information contained hereon reflects the Company's findings at the time of its intervention only and within the limits of Client's instructions, if any. The Company's sole responsibility is to its Client and this document does not exonerate parties to a transaction from exercising all their rights and obligations under the transaction documents. This document cannot be reproduced except in full, without prior written approval of the Company. Any unauthorized alteration, forgery or falsification of the content or appearance of this document is unlawful and offenders may be prosecuted to the fullest extent of the law.

**BT4.0 mode**  
**6dB Band Width Test Data CH-Low**

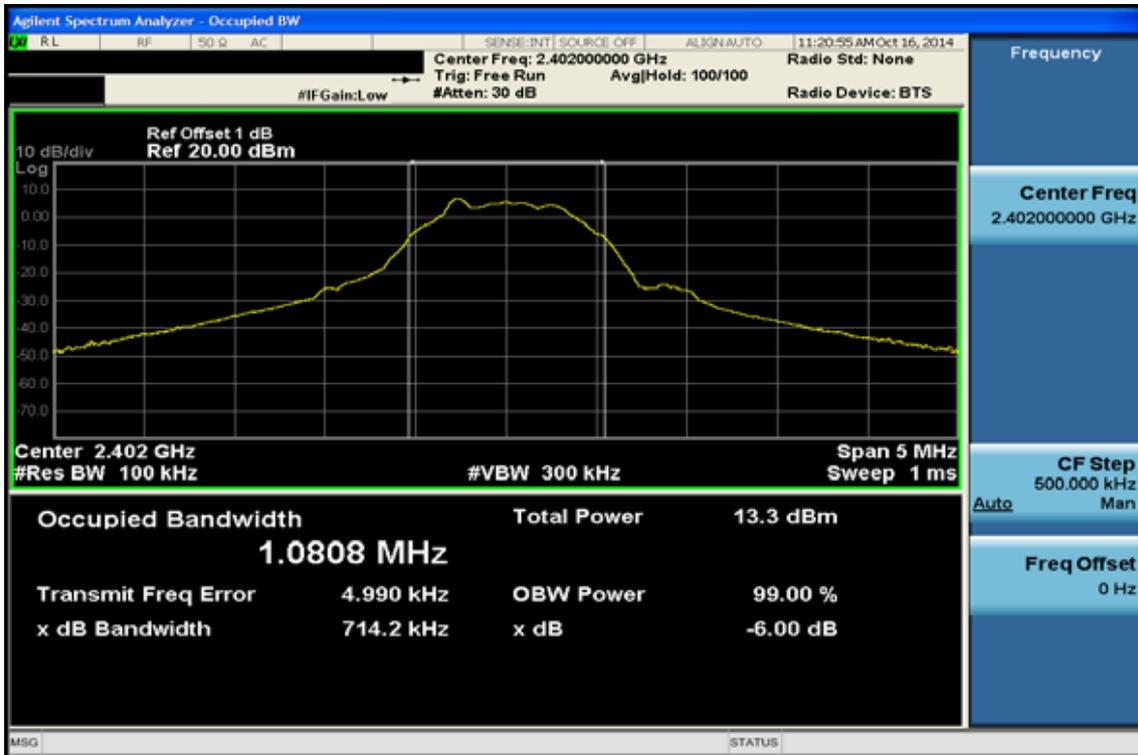

**6dB Band Width Test Data CH-Mid**

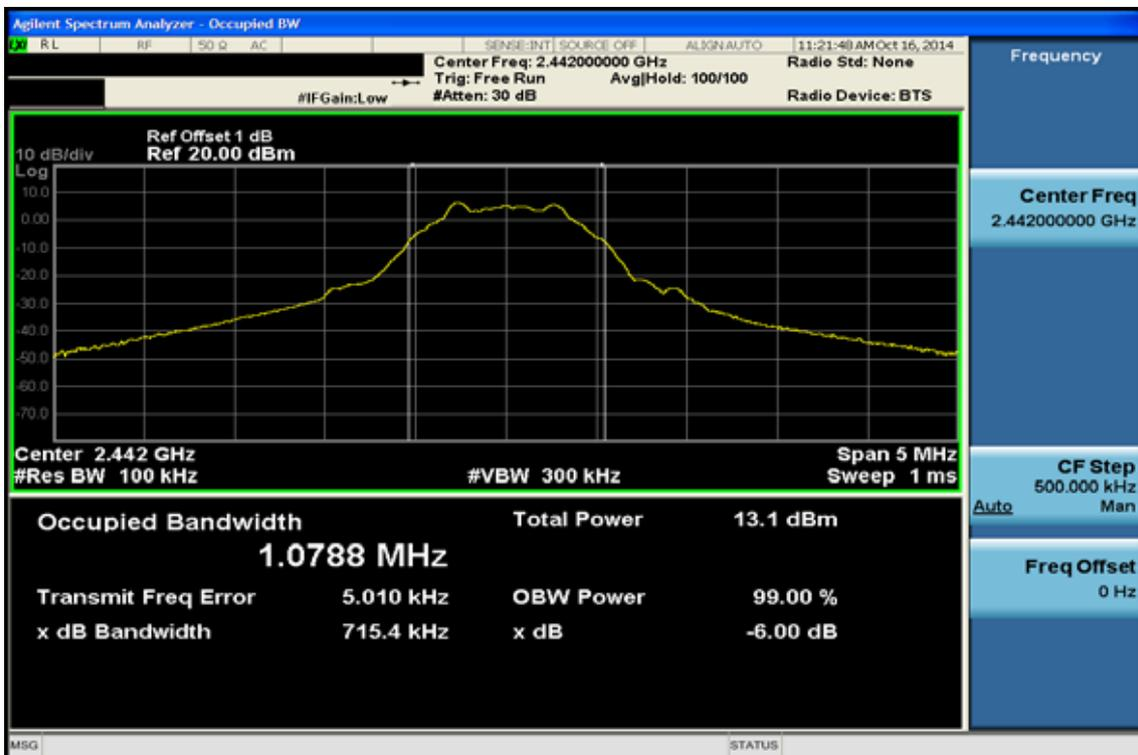

Unless otherwise stated the results shown in this test report refer only to the sample(s) tested and such sample(s) are retained for 90 days only.

除非另有說明，此報告結果僅對測試之樣品負責，同時此樣品僅保留90天。本報告未經本公司書面許可，不可部份複製。

This document is issued by the Company subject to its General Conditions of Service printed overleaf, available on request or accessible at [www.sgs.com/terms\\_and\\_conditions.htm](http://www.sgs.com/terms_and_conditions.htm) and, for electronic format documents, subject to Terms and Conditions for Electronic Documents at [www.sgs.com/terms\\_e-document.htm](http://www.sgs.com/terms_e-document.htm). Attention is drawn to the limitation of liability, indemnification and jurisdiction issues defined therein. Any holder of this document is advised that information contained hereon reflects the Company's findings at the time of its intervention only and within the limits of Client's instructions, if any. The Company's sole responsibility is to its Client and this document does not exonerate parties to a transaction from exercising all their rights and obligations under the transaction documents. This document cannot be reproduced except in full, without prior written approval of the Company. Any unauthorized alteration, forgery or falsification of the content or appearance of this document is unlawful and offenders may be prosecuted to the fullest extent of the law.

### 6dB Band Width Test Data CH-High

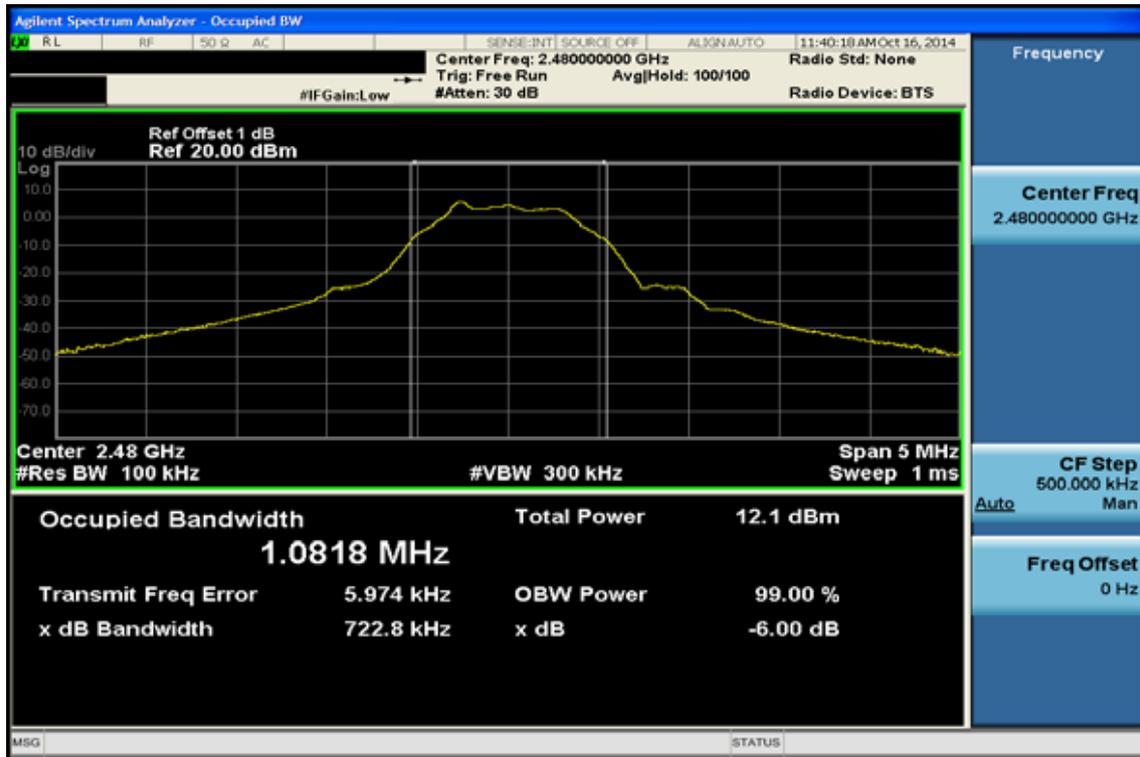

Unless otherwise stated the results shown in this test report refer only to the sample(s) tested and such sample(s) are retained for 90 days only.

除非另有說明，此報告結果僅對測試之樣品負責，同時此樣品僅保留90天。本報告未經本公司書面許可，不可部份複製。

This document is issued by the Company subject to its General Conditions of Service printed overleaf, available on request or accessible at [www.sgs.com/terms\\_and\\_conditions.htm](http://www.sgs.com/terms_and_conditions.htm) and, for electronic format documents, subject to Terms and Conditions for Electronic Documents at [www.sgs.com/terms\\_e-document.htm](http://www.sgs.com/terms_e-document.htm). Attention is drawn to the limitation of liability, indemnification and jurisdiction issues defined therein. Any holder of this document is advised that information contained hereon reflects the Company's findings at the time of its intervention only and within the limits of Client's instructions, if any. The Company's sole responsibility is to its Client and this document does not exonerate parties to a transaction from exercising all their rights and obligations under the transaction documents. This document cannot be reproduced except in full, without prior written approval of the Company. Any unauthorized alteration, forgery or falsification of the content or appearance of this document is unlawful and offenders may be prosecuted to the fullest extent of the law.

## 9 BAND EDGES MEASUREMENT

### 9.1 Standard Applicable:

According to §15.247(c), in any 100 kHz bandwidth outside the frequency bands in which the spread spectrum intentional radiator is operating, the radio frequency power that is produced by the intentional radiator shall be at least 20dB below that in the 100kHz bandwidth within the band that contains the highest level of the desired power, In addition, radiated emissions which fall in the restricted bands, as defined in §15.205(a), must also comply with the radiated emission limits specified in 15.209(a).

According to RSS-Gen §7.2.5 and RSS-210 issue 8, §A8.5, In any 100 kHz bandwidth outside the frequency band in which the spread spectrum or digitally modulated device is operating, the radio frequency power that is produced shall be at least 20 dB below that in the 100 kHz bandwidth within the band that contains the highest level of the desired power, based on either an RF conducted or a radiated measurement, provided the transmitter demonstrates compliance with the peak conducted power limits. If the transmitter complies with the conducted power limits based on the use of RMS averaging over a time interval, as permitted under section A8.4(4), the attenuation required shall be 30 dB instead of 20 dB. Attenuation below the general limits specified in Tables 5 and 6 is not required. In addition, radiated emissions which fall in the restricted bands of Table 3 must also comply with the radiated emission limits specified in Tables 5 and 6.

### 9.2 Measurement Equipment Used:

#### 9.2.1 Conducted Emission at antenna port:

Refer to section 7.2 for details.

Unless otherwise stated the results shown in this test report refer only to the sample(s) tested and such sample(s) are retained for 90 days only.

除非另有說明，此報告結果僅對測試之樣品負責，同時此樣品僅保留90天。本報告未經本公司書面許可，不可部份複製。

This document is issued by the Company subject to its General Conditions of Service printed overleaf, available on request or accessible at [www.sgs.com/terms\\_and\\_conditions.htm](http://www.sgs.com/terms_and_conditions.htm) and, for electronic format documents, subject to Terms and Conditions for Electronic Documents at [www.sgs.com/terms\\_e-document.htm](http://www.sgs.com/terms_e-document.htm). Attention is drawn to the limitation of liability, indemnification and jurisdiction issues defined therein. Any holder of this document is advised that information contained hereon reflects the Company's findings at the time of its intervention only and within the limits of Client's instructions, if any. The Company's sole responsibility is to its Client and this document does not exonerate parties to a transaction from exercising all their rights and obligations under the transaction documents. This document cannot be reproduced except in full, without prior written approval of the Company. Any unauthorized alteration, forgery or falsification of the content or appearance of this document is unlawful and offenders may be prosecuted to the fullest extent of the law.

9.2.2 Radiated emission:

SGS SAC Chamber No.C (FCC/IC/NCC)					
Name of Equipment	Manufacturer	Model	Serial Number	Calibration Date	Calibration Due
EMI Test Receiver	R&S	ESU 40	100363	2014/04/12	2015/04/11
Loop Antenna	ETS-Lindgren	6502	00143303	2014/01/16	2015/01/15
Broadband Antenna	TESEQ	CBL 6112D	35240	2014/01/17	2015/01/16
Horn Antenna	ETS-Lindgren	3117	00143272	2014/01/27	2015/01/26
Horn Antenna	Schwarzbeck	BBHA9170	BBHA9170-184	2014/01/23	2015/01/22
Horn Antenna	ETS-Lindgren	3160-09	00117911	2014/01/22	2015/01/21
Horn Antenna	ETS-Lindgren	3160-10	00117783	2014/01/22	2015/01/21
Pre Amplifier	R&S	SCU-18	10204	2014/03/26	2015/03/25
Pre Amplifier	R&S	SCU-26	100780	2014/03/26	2015/03/25
Pre Amplifier	R&S	SCU-40	100356	2014/03/26	2015/03/25
Pre Amplifier	EMC Instruments	EMC330	980096	2014/03/26	2015/03/25
Pre Amplifier	EMC Instruments	EMC184045	980135	2014/01/24	2015/01/23
Coaxial Cable	Huber+Suhner	RG 214/U	W21.03	2014/03/26	2015/03/25
Coaxial Cable	Huber+Suhner	RG 214/U	W22.03	2014/03/26	2015/03/25
Coaxial Cable	Huber+Suhner	SUCCOFLEX 104	MY17413/4	2014/03/26	2015/03/25
Coaxial Cable	Huber+Suhner	SUCCOFLEX 104	MY17404/4	2014/03/26	2015/03/25
Coaxial Cable	Huber+Suhner	SUCCOFLEX 104	MY17394/4	2014/03/26	2015/03/25
Coaxial Cable	Huber+Suhner	SUCCOFLEX 104	MY17386/4	2014/03/26	2015/03/25
Coaxial Cable	Huber+Suhner	SUCCOFLEX 104	MY17388/4	2014/03/26	2015/03/25
Attenuator	WOKEN	218FS-10	HY-151	2014/01/06	2015/01/05
Communication Tester	R&S	CMW500	131121	2014/01/16	2015/01/15
Communication Tester	Anritsu	MT8820C	6201107337	2014/04/23	2015/04/22
Controller	MF	MF-7802	N/A	N.C.R.	N.C.R.
Antenna Master	MF	N/A	N/A	N.C.R.	N.C.R.
Turn Table	MF	N/A	N/A	N.C.R.	N.C.R.
Site NSA	SGS	966 Chamber C	SAC-C	2014/03/05	2015/03/04
Site VSWR	SGS	966 Chamber C	SAC-C	2014/04/10	2015/04/09
Test Software	World-Pallas	Dr. E	V 3.0 Lite	N.C.R.	N.C.R.

Unless otherwise stated the results shown in this test report refer only to the sample(s) tested and such sample(s) are retained for 90 days only.

除非另有說明，此報告結果僅對測試之樣品負責，同時此樣品僅保留90天。本報告未經本公司書面許可，不可部份複製。

This document is issued by the Company subject to its General Conditions of Service printed overleaf, available on request or accessible at [www.sgs.com/terms\\_and\\_conditions.htm](http://www.sgs.com/terms_and_conditions.htm) and, for electronic format documents, subject to Terms and Conditions for Electronic Documents at [www.sgs.com/terms\\_e-document.htm](http://www.sgs.com/terms_e-document.htm). Attention is drawn to the limitation of liability, indemnification and jurisdiction issues defined therein. Any holder of this document is advised that information contained hereon reflects the Company's findings at the time of its intervention only and within the limits of Client's instructions, if any. The Company's sole responsibility is to its Client and this document does not exonerate parties to a transaction from exercising all their rights and obligations under the transaction documents. This document cannot be reproduced except in full, without prior written approval of the Company. Any unauthorized alteration, forgery or falsification of the content or appearance of this document is unlawful and offenders may be prosecuted to the fullest extent of the law.

### 9.3 Test SET-UP:

#### 9.3.1 Conducted Emission at antenna port:

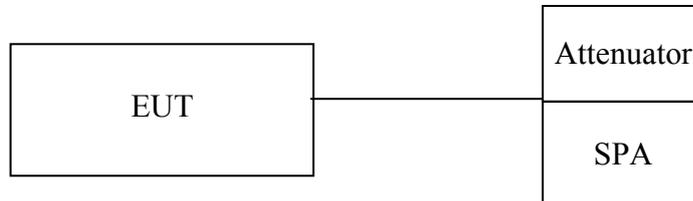

#### 9.3.2 Radiated emission:

##### (A) Radiated Emission Test Set-Up, Frequency Below 1000MHz

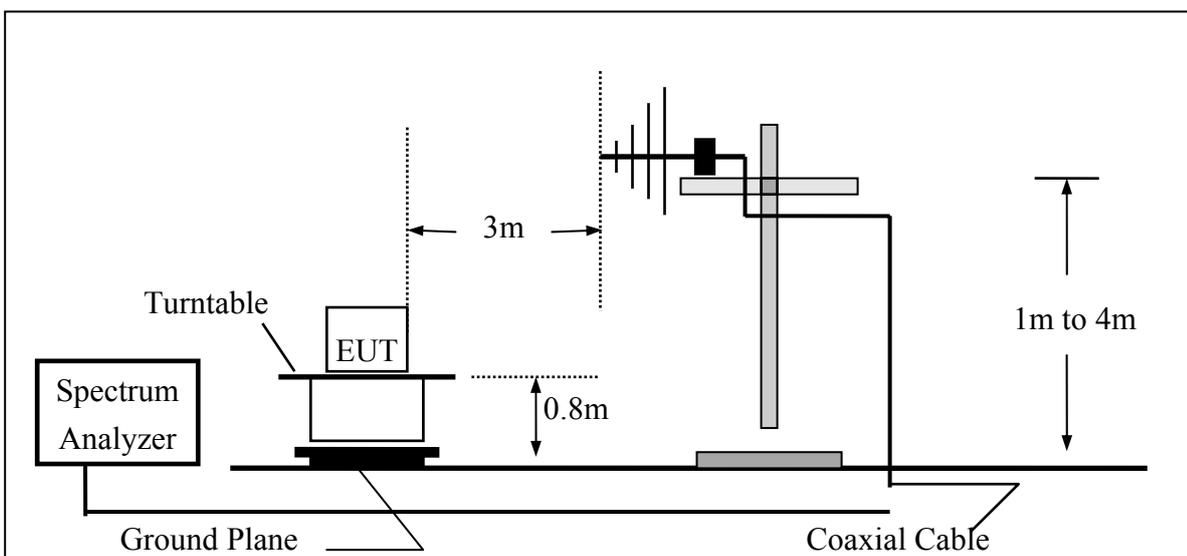

##### (B) Radiated Emission Test Set-UP Frequency Over 1 GHz

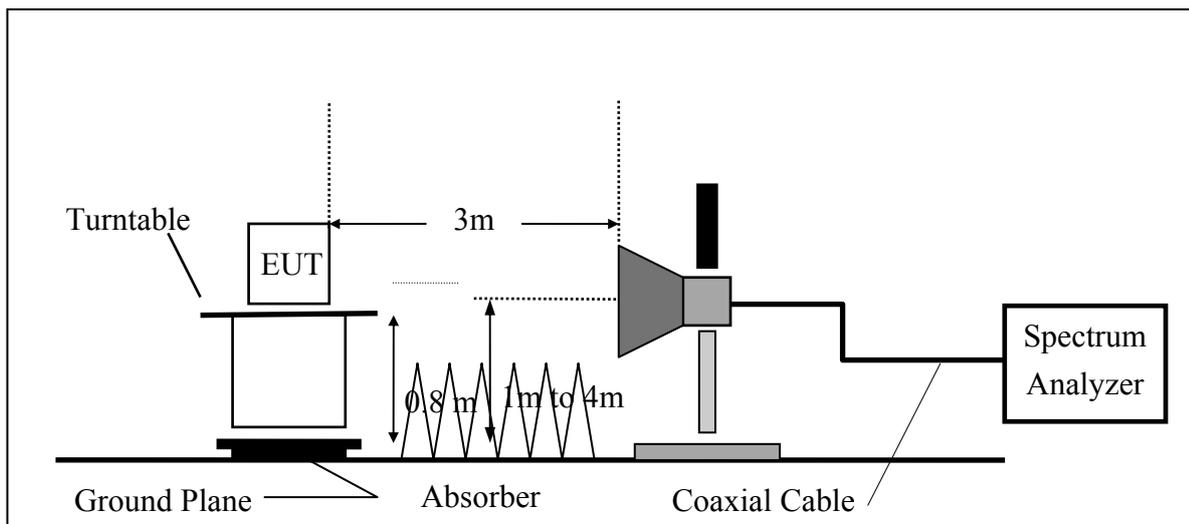

Unless otherwise stated the results shown in this test report refer only to the sample(s) tested and such sample(s) are retained for 90 days only.

除非另有說明，此報告結果僅對測試之樣品負責，同時此樣品僅保留90天。本報告未經本公司書面許可，不可部份複製。

This document is issued by the Company subject to its General Conditions of Service printed overleaf, available on request or accessible at [www.sgs.com/terms\\_and\\_conditions.htm](http://www.sgs.com/terms_and_conditions.htm) and, for electronic format documents, subject to Terms and Conditions for Electronic Documents at [www.sgs.com/terms\\_e-document.htm](http://www.sgs.com/terms_e-document.htm). Attention is drawn to the limitation of liability, indemnification and jurisdiction issues defined therein. Any holder of this document is advised that information contained hereon reflects the Company's findings at the time of its intervention only and within the limits of Client's instructions, if any. The Company's sole responsibility is to its Client and this document does not exonerate parties to a transaction from exercising all their rights and obligations under the transaction documents. This document cannot be reproduced except in full, without prior written approval of the Company. Any unauthorized alteration, forgery or falsification of the content or appearance of this document is unlawful and offenders may be prosecuted to the fullest extent of the law.

#### 9.4 Measurement Procedure:

Unwanted Emissions into Non-Restricted Frequency Bands, Measurement Procedure followed by 11.1 of KDB558074 D01

1. Place the EUT on the table and set it in transmitting mode.
2. Remove the antenna from the EUT and then connect a low loss RF cable from the antenna port to the spectrum analyzer.
3. Set start to edge frequency, and stop frequency of spectrum analyzer so as to encompass the spectrum to be examined.
4. Set the spectrum analyzer as RBW, VBW=300KHz, Detector = Peak, Sweep = auto
5. Mark the highest reading of the emission as the reference level measurement.
6. Set DL as the limit = reading on marker 1 – 20dBm
7. Marker on frequency, 2.3999GHz and 2.4836GHz, and examine shall 100 KHz immediately outside the authorized (2400~2483.5) be attenuated by 20dB at least relative to the maximum emission of power.
8. Repeat above procedures until all default test channel (low, middle, and high) was complete.

Unwanted Emission falling into Restricted Frequency Bands, Measurement Procedure followed by 12.1 of KDB558074 D01:

1. The EUT was placed on a turn table which is 0.8m above ground plane.
2. The turn table shall rotate 360 degrees to determine the position of maximum emission level.
3. EUT is set 3m away from the receiving antenna which varied from 1m to 4m to find out the highest emissions.
4. When measurement procedures for electric field radiated emissions above 1 GHz the EUT measurement is to be made “while keeping the antenna in the ‘cone of radiation’ from that area and pointed at the area both in azimuth and elevation, with polarization oriented for maximum response.” is still within the 3dB illumination BW of the measurement antenna.
5. Maximum procedure was performed on the six highest emissions to ensure EUT compliance.
6. And also, each emission was to be maximized by changing the polarization of receiving antenna both horizontal and vertical.
7. On spectrum, following 8.1.2, and RBW = 1MHz, VBW = 3MHz, & Marker 2390MHz, and 2483.5MHz (Peak Measurement). Average Measurement: following 8.2 with the modification span to 1MHz, & RBW = 1MHz, VBW = 3MHz and peak marker function to obtain the highest reading on 2390, and 2483.5MHz.

Repeat above procedures until all default test channel (low, middle, and high) was complete

Unless otherwise stated the results shown in this test report refer only to the sample(s) tested and such sample(s) are retained for 90 days only.

除非另有說明，此報告結果僅對測試之樣品負責，同時此樣品僅保留90天。本報告未經本公司書面許可，不可部份複製。

This document is issued by the Company subject to its General Conditions of Service printed overleaf, available on request or accessible at [www.sgs.com/terms\\_and\\_conditions.htm](http://www.sgs.com/terms_and_conditions.htm) and, for electronic format documents, subject to Terms and Conditions for Electronic Documents at [www.sgs.com/terms\\_e-document.htm](http://www.sgs.com/terms_e-document.htm). Attention is drawn to the limitation of liability, indemnification and jurisdiction issues defined therein. Any holder of this document is advised that information contained hereon reflects the Company's findings at the time of its intervention only and within the limits of Client's instructions, if any. The Company's sole responsibility is to its Client and this document does not exonerate parties to a transaction from exercising all their rights and obligations under the transaction documents. This document cannot be reproduced except in full, without prior written approval of the Company. Any unauthorized alteration, forgery or falsification of the content or appearance of this document is unlawful and offenders may be prosecuted to the fullest extent of the law.

## 9.5 Field Strength Calculation:

The field strength is calculated by adding the Antenna Factor and Cable Factor and subtracting the Amplifier Gain and Duty Cycle Correction Factor (if any) from the measured reading. The basic equation with a sample calculation is as follows:

$$FS = RA + AF + CL - AG$$

Where	FS = Field Strength	CL = Cable Attenuation Factor (Cable Loss)
	RA = Reading Amplitude	AG = Amplifier Gain
	AF = Antenna Factor	

## 9.6 Measurement Result:

Note: Refer to next page spectrum analyzer data chart and tabular data sheets.

Unless otherwise stated the results shown in this test report refer only to the sample(s) tested and such sample(s) are retained for 90 days only.

除非另有說明，此報告結果僅對測試之樣品負責，同時此樣品僅保留90天。本報告未經本公司書面許可，不可部份複製。

This document is issued by the Company subject to its General Conditions of Service printed overleaf, available on request or accessible at [www.sgs.com/terms\\_and\\_conditions.htm](http://www.sgs.com/terms_and_conditions.htm) and, for electronic format documents, subject to Terms and Conditions for Electronic Documents at [www.sgs.com/terms\\_e-document.htm](http://www.sgs.com/terms_e-document.htm). Attention is drawn to the limitation of liability, indemnification and jurisdiction issues defined therein. Any holder of this document is advised that information contained hereon reflects the Company's findings at the time of its intervention only and within the limits of Client's instructions, if any. The Company's sole responsibility is to its Client and this document does not exonerate parties to a transaction from exercising all their rights and obligations under the transaction documents. This document cannot be reproduced except in full, without prior written approval of the Company. Any unauthorized alteration, forgery or falsification of the content or appearance of this document is unlawful and offenders may be prosecuted to the fullest extent of the law.

BT4.0 mode  
Band Edges Test Data CH-Low

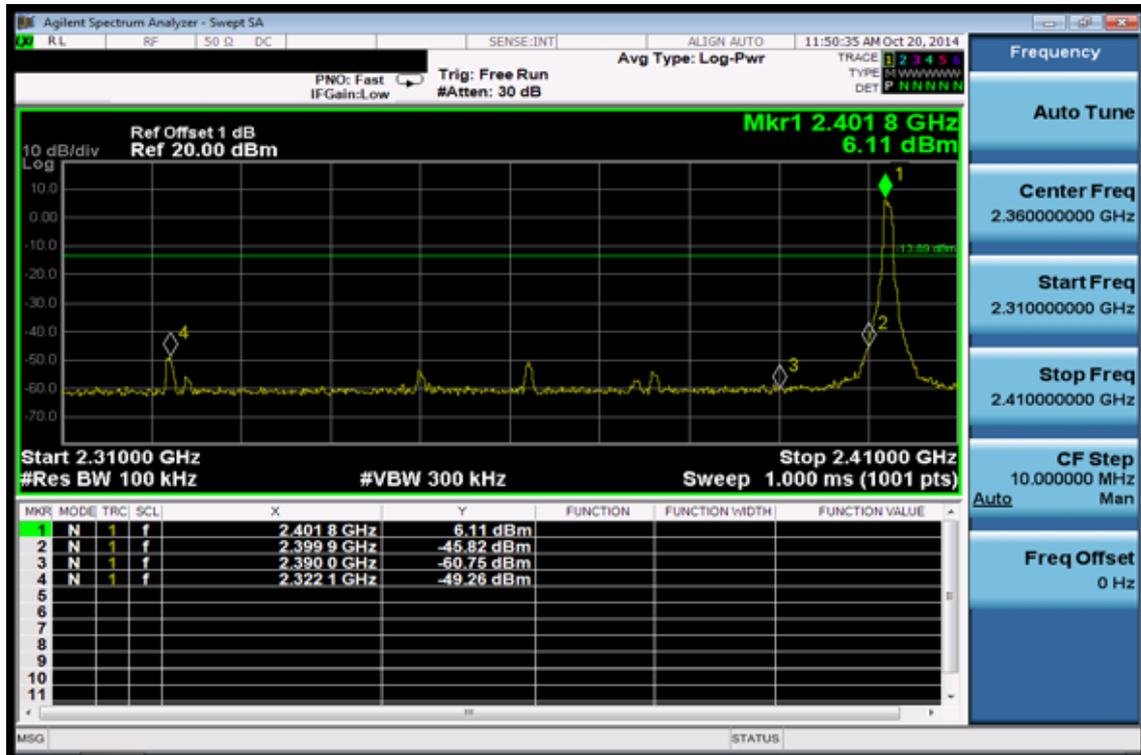

Band Edges Test Data CH-High



Unless otherwise stated the results shown in this test report refer only to the sample(s) tested and such sample(s) are retained for 90 days only.

除非另有說明，此報告結果僅對測試之樣品負責，同時此樣品僅保留90天。本報告未經本公司書面許可，不可部份複製。

This document is issued by the Company subject to its General Conditions of Service printed overleaf, available on request or accessible at [www.sgs.com/terms\\_and\\_conditions.htm](http://www.sgs.com/terms_and_conditions.htm) and, for electronic format documents, subject to Terms and Conditions for Electronic Documents at [www.sgs.com/terms\\_e-document.htm](http://www.sgs.com/terms_e-document.htm). Attention is drawn to the limitation of liability, indemnification and jurisdiction issues defined therein. Any holder of this document is advised that information contained hereon reflects the Company's findings at the time of its intervention only and within the limits of Client's instructions, if any. The Company's sole responsibility is to its Client and this document does not exonerate parties to a transaction from exercising all their rights and obligations under the transaction documents. This document cannot be reproduced except in full, without prior written approval of the Company. Any unauthorized alteration, forgery or falsification of the content or appearance of this document is unlawful and offenders may be prosecuted to the fullest extent of the law.

**Radiated Emission: BT4.0 mode:**

Operation Band	:BT4.0	Test Date	:2014-10-29
Fundamental Frequency	:2402 MHz	Temp./Humi.	:25.5deg_C/53RH
Operation Mode	:BANDEDGE LOW	Engineer	:Jerry
EUT Pol.	:E2 Plane	Measurement Antenna Pol.	:VERTICAL

Actual FS(dBμV/m) = SPA. Reading level(dBμV) + Factor(dB)

Factor(dB) = Antenna Factor(dBμV/m) + Cable Loss(dB) – Pre\_Amplifier Gain(dB)

Note : “F” : denotes Fundamental Frequency. ; “H” : denotes Harmonic Frequency.

“E” : denotes Band Edge Frequency. ; “S” : denotes Spurious Frequency.

“---“ : denotes Noise Floor.

The trace on RE(radiation emission) plot is as colored blue, and the detection manner we’ve employed is peak detector.

Freq.	Detector	Note	Spectrum	Factor	Actual	Limit	Margin
MHz	PK/QP/AV	F/H/E/S	Reading Level	dB	FS	@3m	dB
MHz	PK/QP/AV	F/H/E/S	dBμV	dB	dBμV/m	dBμV/m	dB
2390.00	Peak	E	43.75	6.03	49.78	74.00	-24.22
2390.00	Average	E	32.31	6.03	38.34	54.00	-15.66

Operation Band	:BT4.0	Test Date	:2014-10-29
Fundamental Frequency	:2402 MHz	Temp./Humi.	:25.5deg_C/53RH
Operation Mode	:BANDEDGE LOW	Engineer	:Jerry
EUT Pol.	:E2 Plane	Measurement Antenna Pol.	:HORIZONTAL

Actual FS(dBμV/m) = SPA. Reading level(dBμV) + Factor(dB)

Factor(dB) = Antenna Factor(dBμV/m) + Cable Loss(dB) – Pre\_Amplifier Gain(dB)

Note : “F” : denotes Fundamental Frequency. ; “H” : denotes Harmonic Frequency.

“E” : denotes Band Edge Frequency. ; “S” : denotes Spurious Frequency.

“---“ : denotes Noise Floor.

The trace on RE(radiation emission) plot is as colored blue, and the detection manner we’ve employed is peak detector.

Freq.	Detector	Note	Spectrum	Factor	Actual	Limit	Margin
MHz	PK/QP/AV	F/H/E/S	Reading Level	dB	FS	@3m	dB
MHz	PK/QP/AV	F/H/E/S	dBμV	dB	dBμV/m	dBμV/m	dB
2390.00	Peak	E	43.59	6.03	49.62	74.00	-24.38
2390.00	Average	E	32.41	6.03	38.44	54.00	-15.56

Unless otherwise stated the results shown in this test report refer only to the sample(s) tested and such sample(s) are retained for 90 days only.

除非另有說明，此報告結果僅對測試之樣品負責，同時此樣品僅保留90天。本報告未經本公司書面許可，不可部份複製。

This document is issued by the Company subject to its General Conditions of Service printed overleaf, available on request or accessible at [www.sgs.com/terms\\_and\\_conditions.htm](http://www.sgs.com/terms_and_conditions.htm) and, for electronic format documents, subject to Terms and Conditions for Electronic Documents at [www.sgs.com/terms\\_e-document.htm](http://www.sgs.com/terms_e-document.htm). Attention is drawn to the limitation of liability, indemnification and jurisdiction issues defined therein. Any holder of this document is advised that information contained hereon reflects the Company's findings at the time of its intervention only and within the limits of Client's instructions, if any. The Company's sole responsibility is to its Client and this document does not exonerate parties to a transaction from exercising all their rights and obligations under the transaction documents. This document cannot be reproduced except in full, without prior written approval of the Company. Any unauthorized alteration, forgery or falsification of the content or appearance of this document is unlawful and offenders may be prosecuted to the fullest extent of the law.

Operation Band :BT4.0 Test Date :2014-10-29  
Fundamental Frequency :2480 MHz Temp./Humi. :25.5deg\_C/53RH  
Operation Mode :BANDEDGE HIGH Engineer :Jerry  
EUT Pol. :E2 Plane Measurement Antenna Pol. :VERTICAL

Actual FS(dBμV/m) = SPA. Reading level(dBμV) + Factor(dB)

Factor(dB) = Antenna Factor(dBμV/m) + Cable Loss(dB) – Pre\_Amplifier Gain(dB)

Note : “F” : denotes Fundamental Frequency. ; “H” : denotes Harmonic Frequency.

“E” : denotes Band Edge Frequency. ; “S” : denotes Spurious Frequency.

“---“ : denotes Noise Floor.

The trace on RE(radiation emission) plot is as colored blue, and the detection manner we've employed is peak detector.

Freq.	Detector	Note	Spectrum	Factor	Actual	Limit	Margin
	Mode		Reading Level		FS	@3m	
MHz	PK/QP/AV	F/H/E/S	dBμV	dB	dBμV/m	dBμV/m	dB
2483.50	Peak	E	48.79	6.33	55.13	74.00	-18.87
2483.50	Average	E	42.37	6.33	48.70	54.00	-5.30

Operation Band :BT4.0 Test Date :2014-10-29  
Fundamental Frequency :2480 MHz Temp./Humi. :25.5deg\_C/53RH  
Operation Mode :BANDEDGE HIGH Engineer :Jerry  
EUT Pol. :E2 Plane Measurement Antenna Pol. :HORIZONTAL

Actual FS(dBμV/m) = SPA. Reading level(dBμV) + Factor(dB)

Factor(dB) = Antenna Factor(dBμV/m) + Cable Loss(dB) – Pre\_Amplifier Gain(dB)

Note : “F” : denotes Fundamental Frequency. ; “H” : denotes Harmonic Frequency.

“E” : denotes Band Edge Frequency. ; “S” : denotes Spurious Frequency.

“---“ : denotes Noise Floor.

The trace on RE(radiation emission) plot is as colored blue, and the detection manner we've employed is peak detector.

Freq.	Detector	Note	Spectrum	Factor	Actual	Limit	Margin
	Mode		Reading Level		FS	@3m	
MHz	PK/QP/AV	F/H/E/S	dBμV	dB	dBμV/m	dBμV/m	dB
2483.50	Peak	E	52.38	6.33	58.72	74.00	-15.28
2483.50	Average	E	46.85	6.33	53.18	54.00	-0.82

Unless otherwise stated the results shown in this test report refer only to the sample(s) tested and such sample(s) are retained for 90 days only.

除非另有說明，此報告結果僅對測試之樣品負責，同時此樣品僅保留90天。本報告未經本公司書面許可，不可部份複製。

This document is issued by the Company subject to its General Conditions of Service printed overleaf, available on request or accessible at [www.sgs.com/terms\\_and\\_conditions.htm](http://www.sgs.com/terms_and_conditions.htm) and, for electronic format documents, subject to Terms and Conditions for Electronic Documents at [www.sgs.com/terms\\_e-document.htm](http://www.sgs.com/terms_e-document.htm). Attention is drawn to the limitation of liability, indemnification and jurisdiction issues defined therein. Any holder of this document is advised that information contained hereon reflects the Company's findings at the time of its intervention only and within the limits of Client's instructions, if any. The Company's sole responsibility is to its Client and this document does not exonerate parties to a transaction from exercising all their rights and obligations under the transaction documents. This document cannot be reproduced except in full, without prior written approval of the Company. Any unauthorized alteration, forgery or falsification of the content or appearance of this document is unlawful and offenders may be prosecuted to the fullest extent of the law.

## 10 SPURIOUS RADIATED EMISSION TEST

### 10.1 Standard Applicable

According to §15.247(d),

Emission at antenna port:

In any 100 kHz bandwidth outside the frequency band in which the spread spectrum or digitally modulated intentional radiator is operating, the radio frequency power that is produced by the intentional radiator shall be at least 20 dB below that in the 100 kHz bandwidth within the band that contains the highest level of the desired power, based on either an RF conducted or a radiated measurement, provided the transmitter demonstrates compliance with the peak conducted power limits. If the transmitter complies with the conducted power limits based on the use of RMS averaging over a time interval, as permitted under paragraph (b)(3) of this section, the attenuation required under this paragraph shall be 30 dB instead of 20 dB.

#### Radiated Spurious Emission

Attenuation below the general limits specified in § 15.209(a) is not required. In addition, radiated emissions which fall in the restricted bands, as defined in § 15.205(a), must also comply with the radiated emission limits specified in § 15.209(a) (see § 15.205(c)).

And according to §15.33(a) (1), for an intentional radiator operates below 10GHz, the frequency range of measurements: to the tenth harmonic of the highest fundamental frequency or to 40GHz, whichever is lower.

According to RSS-Gen §7.2.5 and RSS-210 issue 8,§A8.5, In any 100 kHz bandwidth outside the frequency band in which the spread spectrum or digitally modulated device is operating, the radio frequency power that is produced shall be at least 20 dB below that in the 100 kHz bandwidth within the band that contains the highest level of the desired power, based on either an RF conducted or a radiated measurement, provided the transmitter demonstrates compliance with the peak conducted power limits. If the transmitter complies with the conducted power limits based on the use of RMS averaging over a time interval, as permitted under section A8.4(4), the attenuation required shall be 30 dB instead of 20 dB. Attenuation below the general limits specified in Tables 5 and 6 is not required. In addition, radiated emissions which fall in the restricted bands of Table 3 must also comply with the radiated emission limits specified in Tables 5 and 6 of RSS-GEN.

Unless otherwise stated the results shown in this test report refer only to the sample(s) tested and such sample(s) are retained for 90 days only.

除非另有說明，此報告結果僅對測試之樣品負責，同時此樣品僅保留90天。本報告未經本公司書面許可，不可部份複製。

This document is issued by the Company subject to its General Conditions of Service printed overleaf, available on request or accessible at [www.sgs.com/terms\\_and\\_conditions.htm](http://www.sgs.com/terms_and_conditions.htm) and, for electronic format documents, subject to Terms and Conditions for Electronic Documents at [www.sgs.com/terms\\_e-document.htm](http://www.sgs.com/terms_e-document.htm). Attention is drawn to the limitation of liability, indemnification and jurisdiction issues defined therein. Any holder of this document is advised that information contained hereon reflects the Company's findings at the time of its intervention only and within the limits of Client's instructions, if any. The Company's sole responsibility is to its Client and this document does not exonerate parties to a transaction from exercising all their rights and obligations under the transaction documents. This document cannot be reproduced except in full, without prior written approval of the Company. Any unauthorized alteration, forgery or falsification of the content or appearance of this document is unlawful and offenders may be prosecuted to the fullest extent of the law.

## 10.2 Measurement Equipment Used:

### 10.2.1 Conducted Emission at antenna port:

Refer to section 7.2 for details.

### 10.2.2 Radiated emission:

Refer to section 9.2.2 for details.

## 10.3 Test SET-UP:

### 10.3.1 Conducted Emission at antenna port:

Refer to section 8.3 for details.

### 10.3.2 Radiated emission:

Refer to section 9.3.2 for details.

Unless otherwise stated the results shown in this test report refer only to the sample(s) tested and such sample(s) are retained for 90 days only.

除非另有說明，此報告結果僅對測試之樣品負責，同時此樣品僅保留90天。本報告未經本公司書面許可，不可部份複製。

This document is issued by the Company subject to its General Conditions of Service printed overleaf, available on request or accessible at [www.sgs.com/terms\\_and\\_conditions.htm](http://www.sgs.com/terms_and_conditions.htm) and, for electronic format documents, subject to Terms and Conditions for Electronic Documents at [www.sgs.com/terms\\_e-document.htm](http://www.sgs.com/terms_e-document.htm). Attention is drawn to the limitation of liability, indemnification and jurisdiction issues defined therein. Any holder of this document is advised that information contained hereon reflects the Company's findings at the time of its intervention only and within the limits of Client's instructions, if any. The Company's sole responsibility is to its Client and this document does not exonerate parties to a transaction from exercising all their rights and obligations under the transaction documents. This document cannot be reproduced except in full, without prior written approval of the Company. Any unauthorized alteration, forgery or falsification of the content or appearance of this document is unlawful and offenders may be prosecuted to the fullest extent of the law.

## 10.4 Measurement Procedure:

### Radiated Emission:

1. The EUT was placed on a turn table which is 0.8m above ground plane.
2. The turn table shall rotate 360 degrees to determine the position of maximum emission level.
3. EUT is set 3m away from the receiving antenna which varied from 1m to 4m to find out the highest emissions.
4. When measurement procedures for electric field radiated emissions above 1 GHz the EUT measurement is to be made “while keeping the antenna in the ‘cone of radiation’ from that area and pointed at the area both in azimuth and elevation, with polarization oriented for maximum response.” is still within the 3dB illumination BW of the measurement antenna.
5. Maximum procedure was performed on the six highest emissions to ensure EUT compliance.
6. And also, each emission was to be maximized by changing the polarization of receiving antenna both horizontal and vertical. On spectrum, change spectrum mode in linear display mode, and reduce VBW = 10Hz if average reading is measured.
7. Repeat above procedures until all default test channel measured were complete.

### Conducted Emission:

1. To connect Antenna Port of EUT to Spectrum.
2. Set RBW = 100K & VBW = 300K on Spectrum.
3. Sweep the frequency to determine spurious emission as seen on spectrum from span of 30 to 3G, 3G to 8G, 8G to 13G, 13G to 18G and 18G to 26.5GHz, 18G to 40GHz (applicable if operation mode is 5GHz)
4. Via Software, combine 5 spans of frequency range into one plot
5. Repeat above procedures until all default test channel measured were complete.

## 10.5 Field Strength Calculation

The field strength is calculated by adding the Antenna Factor and Cable Factor and subtracting the Amplifier Gain and Duty Cycle Correction Factor (if any) from the measured reading. The basic equation with a sample calculation is as follows:

$$FS = RA + AF + CL - AG$$

Where	FS = Field Strength	CL = Cable Attenuation Factor (Cable Loss)
	RA = Reading Amplitude	AG = Amplifier Gain
	AF = Antenna Factor	

## 10.6 Measurement Result:

Note: Refer to next page spectrum analyzer data chart and tabular data sheets.

Unless otherwise stated the results shown in this test report refer only to the sample(s) tested and such sample(s) are retained for 90 days only.

除非另有說明，此報告結果僅對測試之樣品負責，同時此樣品僅保留90天。本報告未經本公司書面許可，不可部份複製。

This document is issued by the Company subject to its General Conditions of Service printed overleaf, available on request or accessible at [www.sgs.com/terms\\_and\\_conditions.htm](http://www.sgs.com/terms_and_conditions.htm) and, for electronic format documents, subject to Terms and Conditions for Electronic Documents at [www.sgs.com/terms\\_e-document.htm](http://www.sgs.com/terms_e-document.htm). Attention is drawn to the limitation of liability, indemnification and jurisdiction issues defined therein. Any holder of this document is advised that information contained hereon reflects the Company's findings at the time of its intervention only and within the limits of Client's instructions, if any. The Company's sole responsibility is to its Client and this document does not exonerate parties to a transaction from exercising all their rights and obligations under the transaction documents. This document cannot be reproduced except in full, without prior written approval of the Company. Any unauthorized alteration, forgery or falsification of the content or appearance of this document is unlawful and offenders may be prosecuted to the fullest extent of the law.

### Conducted Spurious Emission Measurement Result (BT4.0 mode) Ch Low 30MHz – 3GHz

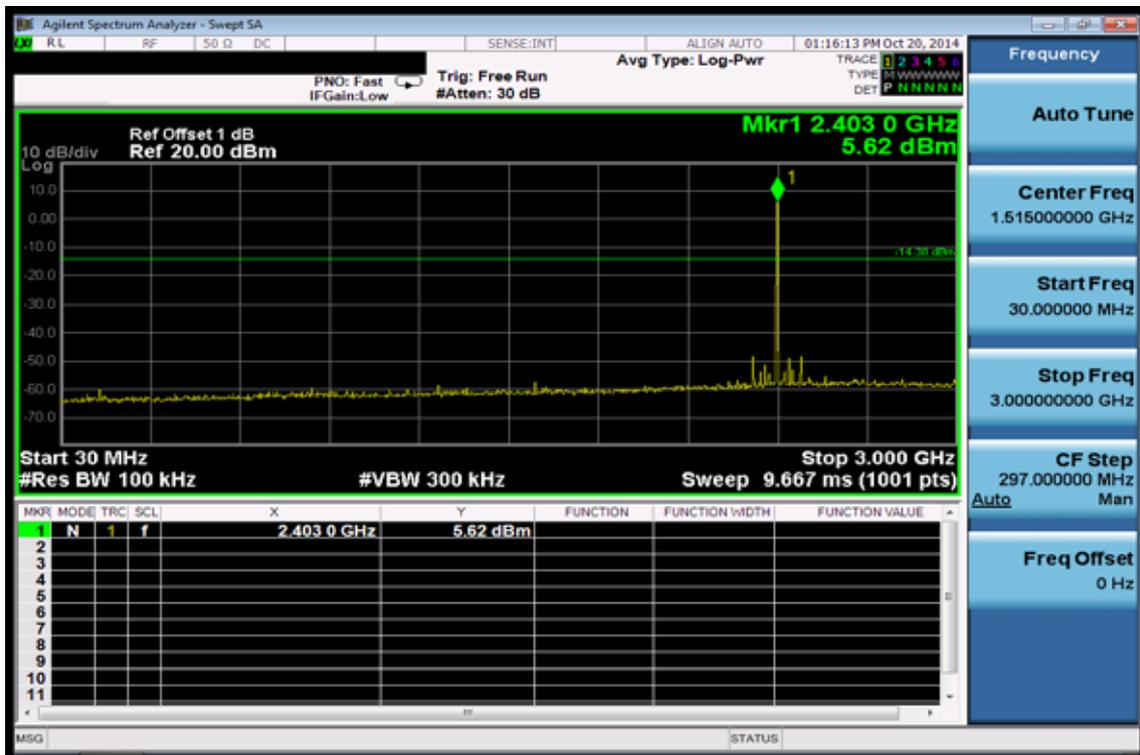

### Ch Low 3GHz – 26.5GHz

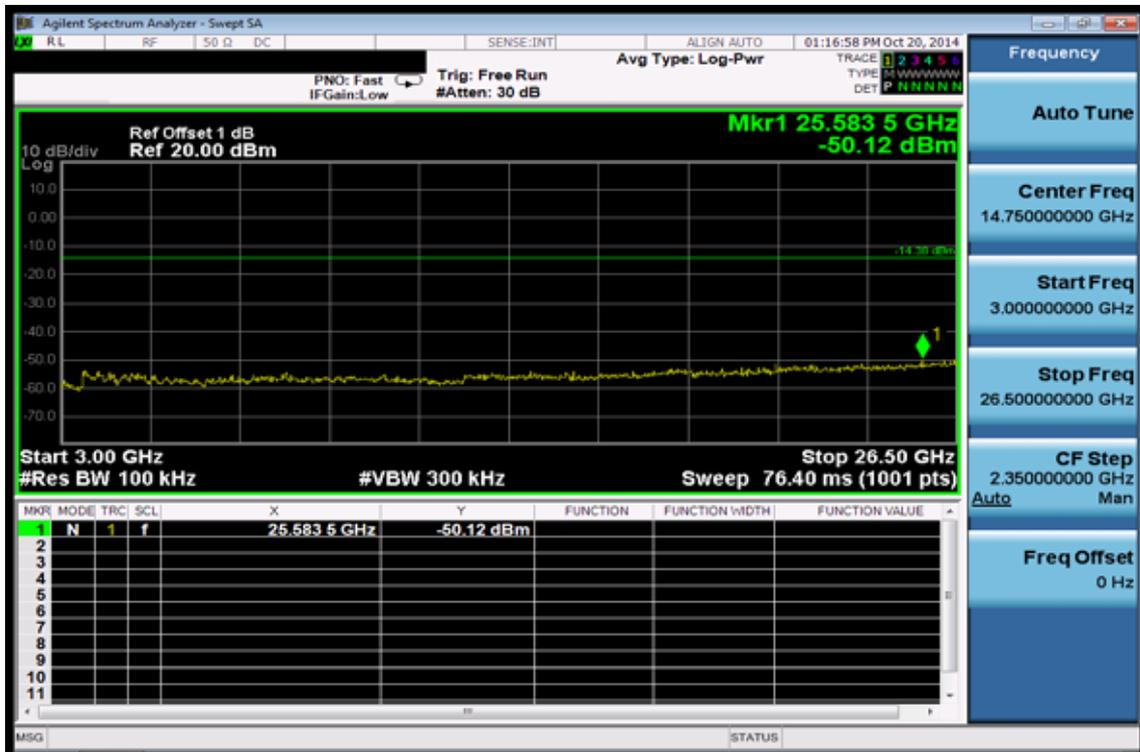

Unless otherwise stated the results shown in this test report refer only to the sample(s) tested and such sample(s) are retained for 90 days only.

除非另有說明，此報告結果僅對測試之樣品負責，同時此樣品僅保留90天。本報告未經本公司書面許可，不可部份複製。

This document is issued by the Company subject to its General Conditions of Service printed overleaf, available on request or accessible at [www.sgs.com/terms\\_and\\_conditions.htm](http://www.sgs.com/terms_and_conditions.htm) and, for electronic format documents, subject to Terms and Conditions for Electronic Documents at [www.sgs.com/terms\\_e-document.htm](http://www.sgs.com/terms_e-document.htm). Attention is drawn to the limitation of liability, indemnification and jurisdiction issues defined therein. Any holder of this document is advised that information contained hereon reflects the Company's findings at the time of its intervention only and within the limits of Client's instructions, if any. The Company's sole responsibility is to its Client and this document does not exonerate parties to a transaction from exercising all their rights and obligations under the transaction documents. This document cannot be reproduced except in full, without prior written approval of the Company. Any unauthorized alteration, forgery or falsification of the content or appearance of this document is unlawful and offenders may be prosecuted to the fullest extent of the law.

### Ch Mid 30MHz – 3GHz

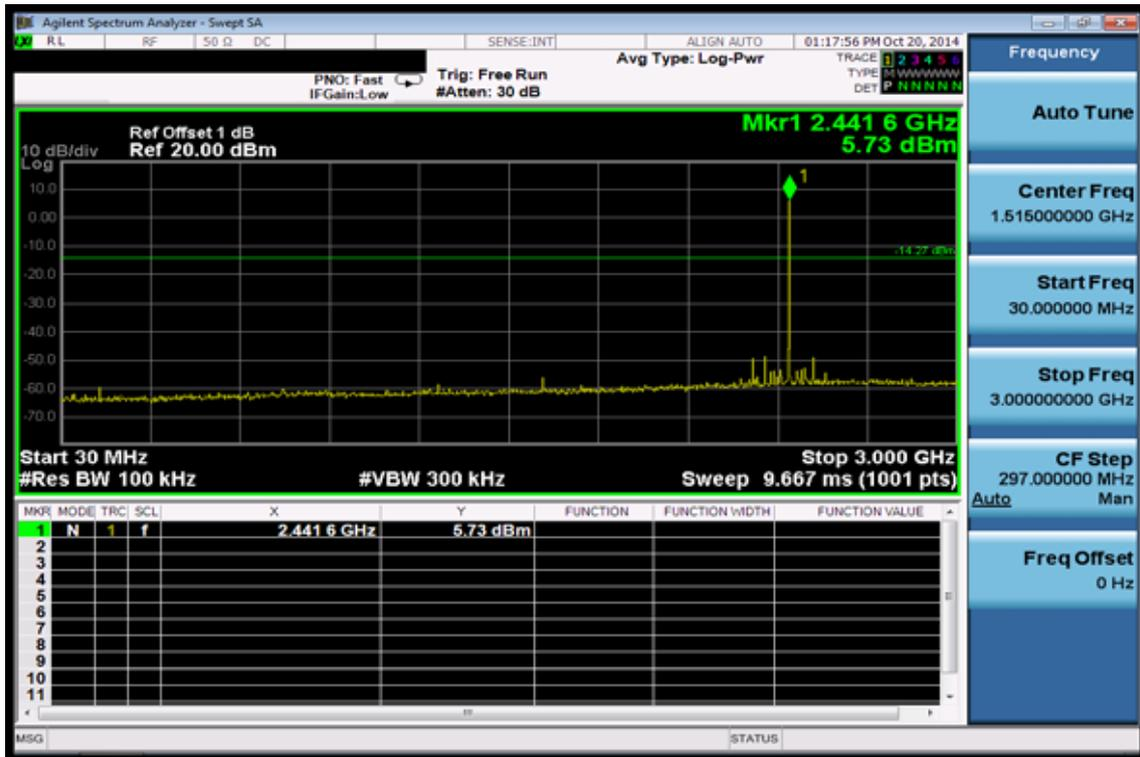

### Ch Mid 3GHz – 26.5GHz

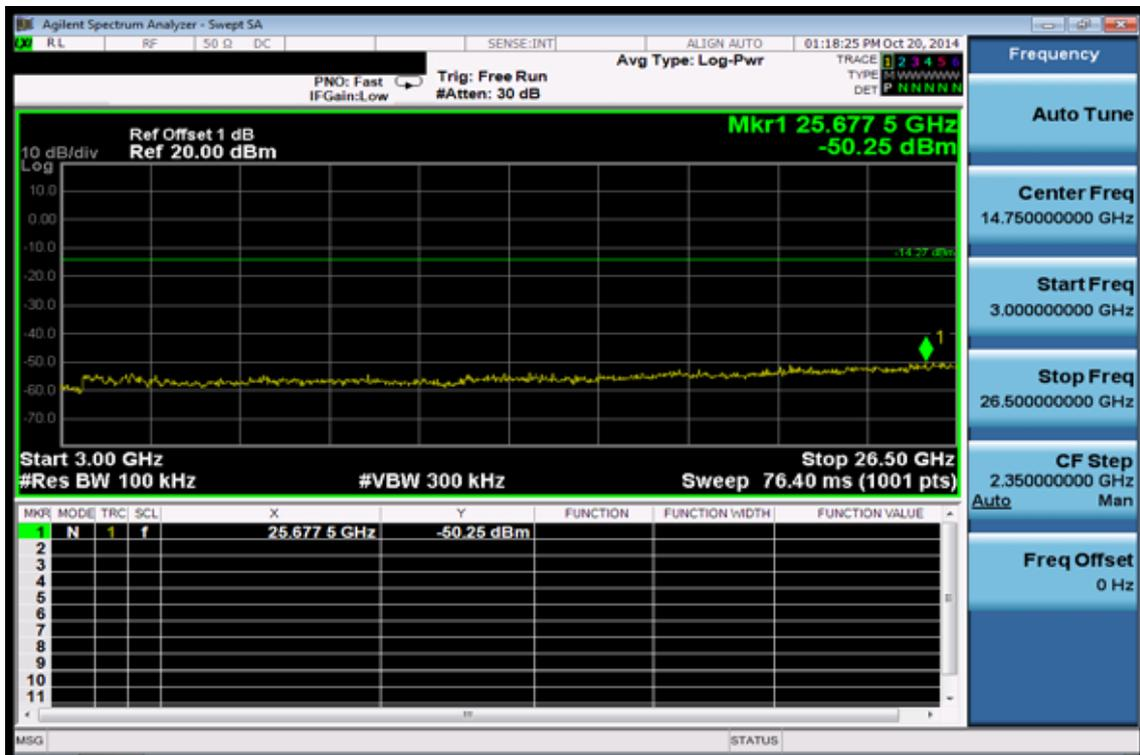

Unless otherwise stated the results shown in this test report refer only to the sample(s) tested and such sample(s) are retained for 90 days only.

除非另有說明，此報告結果僅對測試之樣品負責，同時此樣品僅保留90天。本報告未經本公司書面許可，不可部份複製。

This document is issued by the Company subject to its General Conditions of Service printed overleaf, available on request or accessible at [www.sgs.com/terms\\_and\\_conditions.htm](http://www.sgs.com/terms_and_conditions.htm) and, for electronic format documents, subject to Terms and Conditions for Electronic Documents at [www.sgs.com/terms\\_e-document.htm](http://www.sgs.com/terms_e-document.htm). Attention is drawn to the limitation of liability, indemnification and jurisdiction issues defined therein. Any holder of this document is advised that information contained hereon reflects the Company's findings at the time of its intervention only and within the limits of Client's instructions, if any. The Company's sole responsibility is to its Client and this document does not exonerate parties to a transaction from exercising all their rights and obligations under the transaction documents. This document cannot be reproduced except in full, without prior written approval of the Company. Any unauthorized alteration, forgery or falsification of the content or appearance of this document is unlawful and offenders may be prosecuted to the fullest extent of the law.

### Ch High 30MHz – 3GHz

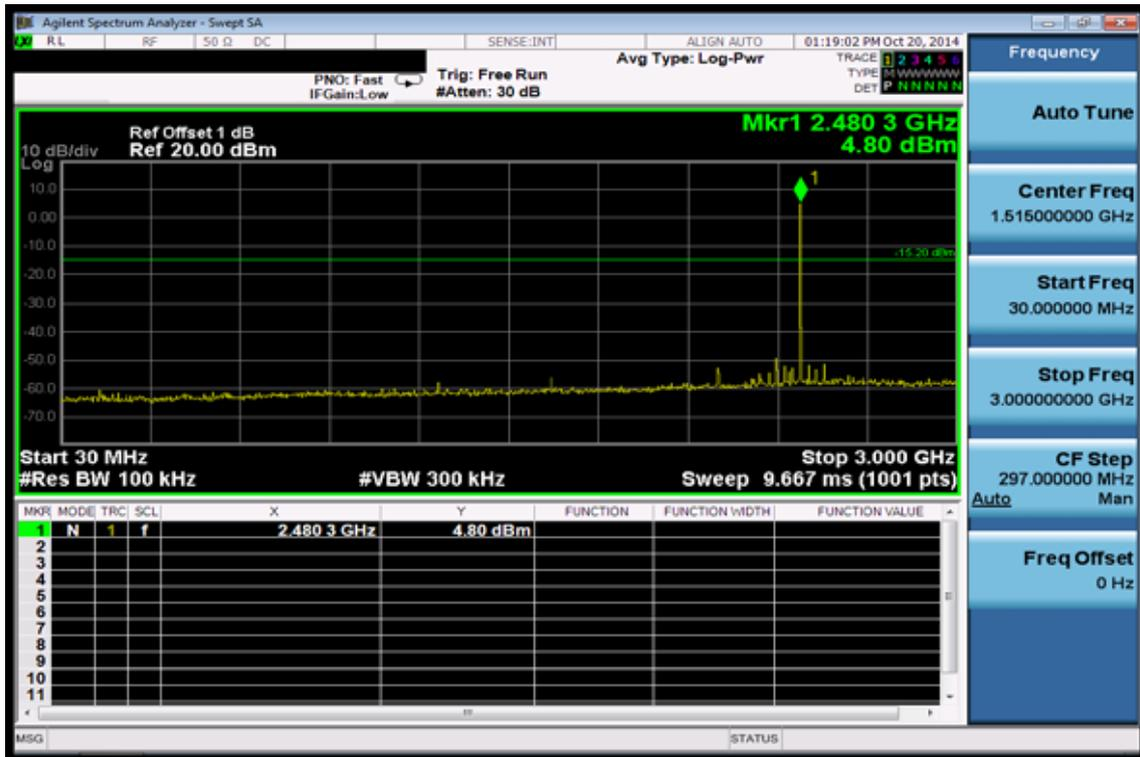

### Ch High 3GHz – 26.5GHz

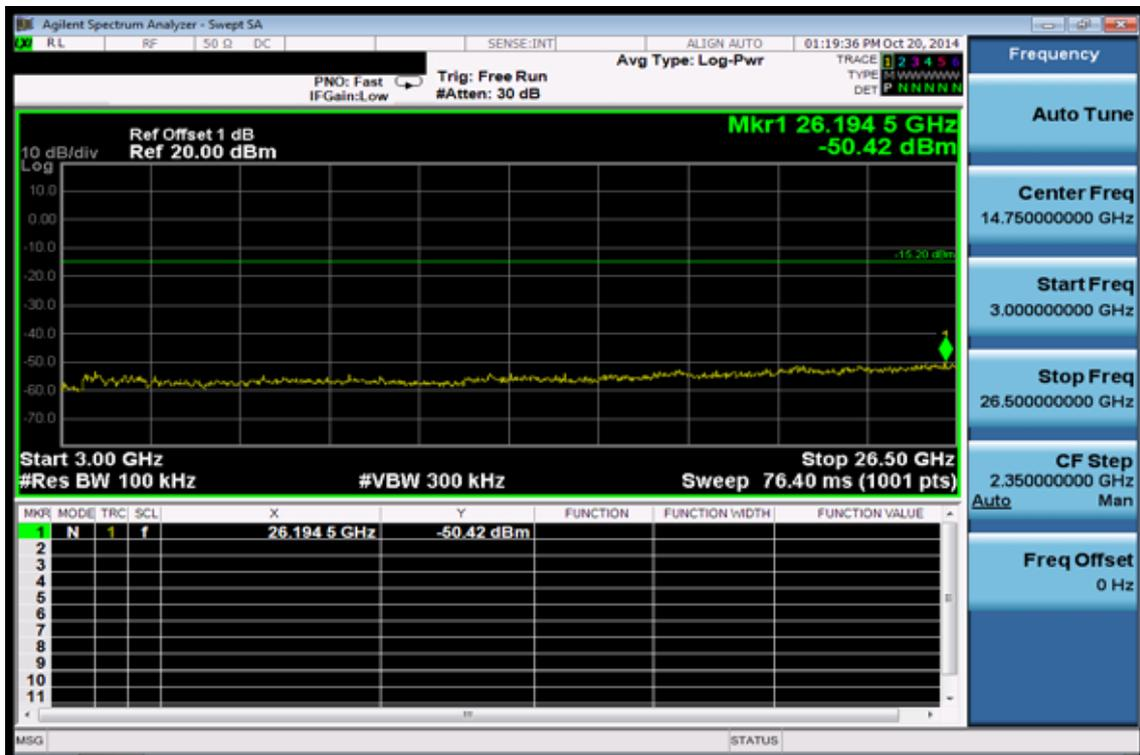

Unless otherwise stated the results shown in this test report refer only to the sample(s) tested and such sample(s) are retained for 90 days only.

除非另有說明，此報告結果僅對測試之樣品負責，同時此樣品僅保留90天。本報告未經本公司書面許可，不可部份複製。

This document is issued by the Company subject to its General Conditions of Service printed overleaf, available on request or accessible at [www.sgs.com/terms\\_and\\_conditions.htm](http://www.sgs.com/terms_and_conditions.htm) and, for electronic format documents, subject to Terms and Conditions for Electronic Documents at [www.sgs.com/terms\\_e-document.htm](http://www.sgs.com/terms_e-document.htm). Attention is drawn to the limitation of liability, indemnification and jurisdiction issues defined therein. Any holder of this document is advised that information contained hereon reflects the Company's findings at the time of its intervention only and within the limits of Client's instructions, if any. The Company's sole responsibility is to its Client and this document does not exonerate parties to a transaction from exercising all their rights and obligations under the transaction documents. This document cannot be reproduced except in full, without prior written approval of the Company. Any unauthorized alteration, forgery or falsification of the content or appearance of this document is unlawful and offenders may be prosecuted to the fullest extent of the law.

### Radiated Spurious Emission Measurement Result (BT4.0 mode)

Operation Band	:BT4.0	Test Date	:2014-10-27
Fundamental Frequency	:2402 MHz	Temp./Humi.	:25.5deg_C/53RH
Operation Mode	:TX LOW	Engineer	:Tai
EUT Pol.	:E2 Plane	Measurement Antenna Pol.	:VERTICAL

Actual FS(dB $\mu$ V/m) = SPA. Reading level(dB $\mu$ V) + Factor(dB)

Factor(dB) = Antenna Factor(dB $\mu$ V/m) + Cable Loss(dB) – Pre\_Amplifier Gain(dB)

Note : “F” : denotes Fundamental Frequency. ; “H” : denotes Harmonic Frequency.

“E” : denotes Band Edge Frequency. ; “S” : denotes Spurious Frequency.

“---” : denotes Noise Floor.

Freq. MHz	Detector Mode PK/QP/AV	Note F/H/E/S	Spectrum Reading Level dB $\mu$ V	Factor dB	Actual FS dB $\mu$ V/m	Limit @3m dB $\mu$ V/m	Margin dB
42.61	Peak	S	59.37	-21.78	37.59	40.00	-2.41
52.31	Peak	S	52.10	-26.03	26.07	40.00	-13.93
89.17	Peak	S	45.12	-25.11	20.02	43.50	-23.48
419.94	Peak	S	35.83	-14.97	20.86	46.00	-25.14
630.43	Peak	S	37.80	-11.69	26.10	46.00	-19.90
840.92	Peak	S	34.88	-8.89	26.00	46.00	-20.00
4804.00	Peak	H	42.65	-0.06	42.59	74.00	-31.41
4804.00	Average	H	29.15	-0.06	29.09	54.00	-24.91
7206.00	Peak	H	---				
9608.00	Peak	H	---				
12010.00	Peak	H	---				
14412.00	Peak	H	---				
16814.00	Peak	H	---				
19216.00	Peak	H	---				
21618.00	Peak	H	---				
24020.00	Peak	H	---				

Unless otherwise stated the results shown in this test report refer only to the sample(s) tested and such sample(s) are retained for 90 days only.

除非另有說明，此報告結果僅對測試之樣品負責，同時此樣品僅保留90天。本報告未經本公司書面許可，不可部份複製。

This document is issued by the Company subject to its General Conditions of Service printed overleaf, available on request or accessible at [www.sgs.com/terms\\_and\\_conditions.htm](http://www.sgs.com/terms_and_conditions.htm) and, for electronic format documents, subject to Terms and Conditions for Electronic Documents at [www.sgs.com/terms\\_e-document.htm](http://www.sgs.com/terms_e-document.htm). Attention is drawn to the limitation of liability, indemnification and jurisdiction issues defined therein. Any holder of this document is advised that information contained hereon reflects the Company's findings at the time of its intervention only and within the limits of Client's instructions, if any. The Company's sole responsibility is to its Client and this document does not exonerate parties to a transaction from exercising all their rights and obligations under the transaction documents. This document cannot be reproduced except in full, without prior written approval of the Company. Any unauthorized alteration, forgery or falsification of the content or appearance of this document is unlawful and offenders may be prosecuted to the fullest extent of the law.

Operation Band	:BT4.0	Test Date	:2014-10-27
Fundamental Frequency	:2402 MHz	Temp./Humi.	:25.5deg_C/53RH
Operation Mode	:TX LOW	Engineer	:Tai
EUT Pol.	:E2 Plane	Measurement Antenna Pol.	:HORIZONTAL

Actual FS(dBμV/m) = SPA. Reading level(dBμV) + Factor(dB)

Factor(dB) = Antenna Factor(dBμV/m) + Cable Loss(dB) – Pre\_Amplifier Gain(dB)

Note : “F” : denotes Fundamental Frequency. ; “H” : denotes Harmonic Frequency.

“E” : denotes Band Edge Frequency. ; “S” : denotes Spurious Frequency.

“---” : denotes Noise Floor.

Freq.	Detector	Note	Spectrum	Factor	Actual	Limit	Margin
MHz	PK/QP/AV	F/H/E/S	Reading Level	dB	FS	@3m	dB
			dBμV		dBμV/m	dBμV/m	
54.25	Peak	S	50.60	-26.45	24.15	40.00	-15.85
61.04	Peak	S	45.89	-27.69	18.20	40.00	-21.80
127.97	Peak	S	42.69	-21.27	21.42	43.50	-22.08
419.94	Peak	S	39.21	-14.97	24.24	46.00	-21.76
630.43	Peak	S	35.82	-11.69	24.12	46.00	-21.88
840.92	Peak	S	36.12	-8.89	27.23	46.00	-18.77
4804.00	Peak	H	42.68	-0.06	42.62	74.00	-31.38
4804.00	Average	H	29.13	-0.06	29.07	54.00	-24.93
7206.00	Peak	H	---				
9608.00	Peak	H	---				
12010.00	Peak	H	---				
14412.00	Peak	H	---				
16814.00	Peak	H	---				
19216.00	Peak	H	---				
21618.00	Peak	H	---				
24020.00	Peak	H	---				

Unless otherwise stated the results shown in this test report refer only to the sample(s) tested and such sample(s) are retained for 90 days only.

除非另有說明，此報告結果僅對測試之樣品負責，同時此樣品僅保留90天。本報告未經本公司書面許可，不可部份複製。

This document is issued by the Company subject to its General Conditions of Service printed overleaf, available on request or accessible at [www.sgs.com/terms\\_and\\_conditions.htm](http://www.sgs.com/terms_and_conditions.htm) and, for electronic format documents, subject to Terms and Conditions for Electronic Documents at [www.sgs.com/terms\\_e-document.htm](http://www.sgs.com/terms_e-document.htm). Attention is drawn to the limitation of liability, indemnification and jurisdiction issues defined therein. Any holder of this document is advised that information contained hereon reflects the Company's findings at the time of its intervention only and within the limits of Client's instructions, if any. The Company's sole responsibility is to its Client and this document does not exonerate parties to a transaction from exercising all their rights and obligations under the transaction documents. This document cannot be reproduced except in full, without prior written approval of the Company. Any unauthorized alteration, forgery or falsification of the content or appearance of this document is unlawful and offenders may be prosecuted to the fullest extent of the law.

Operation Band	:BT4.0	Test Date	:2014-10-27
Fundamental Frequency	:2442 MHz	Temp./Humi.	:25.5deg_C/53RH
Operation Mode	:TX MID	Engineer	:Tai
EUT Pol.	:E2 Plane	Measurement Antenna Pol.	:VERTICAL

Actual FS(dBμV/m) = SPA. Reading level(dBμV) + Factor(dB)

Factor(dB) = Antenna Factor(dBμV/m) + Cable Loss(dB) – Pre\_Amplifier Gain(dB)

Note : “F” : denotes Fundamental Frequency. ; “H” : denotes Harmonic Frequency.

“E” : denotes Band Edge Frequency. ; “S” : denotes Spurious Frequency.

“---” : denotes Noise Floor.

Freq.	Detector	Note	Spectrum	Factor	Actual	Limit	Margin
MHz	PK/QP/AV	F/H/E/S	Reading Level	dB	FS	@3m	dB
			dBμV		dBμV/m	dBμV/m	
48.43	Peak	S	42.25	-24.72	17.53	40.00	-22.47
60.07	Peak	S	46.28	-27.70	18.58	40.00	-21.42
419.94	Peak	S	35.18	-14.97	20.21	46.00	-25.79
578.05	Peak	S	35.31	-12.11	23.20	46.00	-22.80
630.43	Peak	S	37.48	-11.69	25.79	46.00	-20.21
840.92	Peak	S	35.10	-8.89	26.22	46.00	-19.78
4884.00	Peak	H	41.43	0.06	41.48	74.00	-32.52
4884.00	Average	H	28.48	0.06	28.54	54.00	-25.46
7326.00	Peak	H	---				
9768.00	Peak	H	---				
12210.00	Peak	H	---				
14652.00	Peak	H	---				
17094.00	Peak	H	---				
19536.00	Peak	H	---				
21978.00	Peak	H	---				
24420.00	Peak	H	---				

Unless otherwise stated the results shown in this test report refer only to the sample(s) tested and such sample(s) are retained for 90 days only.

除非另有說明，此報告結果僅對測試之樣品負責，同時此樣品僅保留90天。本報告未經本公司書面許可，不可部份複製。

This document is issued by the Company subject to its General Conditions of Service printed overleaf, available on request or accessible at [www.sgs.com/terms\\_and\\_conditions.htm](http://www.sgs.com/terms_and_conditions.htm) and, for electronic format documents, subject to Terms and Conditions for Electronic Documents at [www.sgs.com/terms\\_e-document.htm](http://www.sgs.com/terms_e-document.htm). Attention is drawn to the limitation of liability, indemnification and jurisdiction issues defined therein. Any holder of this document is advised that information contained hereon reflects the Company's findings at the time of its intervention only and within the limits of Client's instructions, if any. The Company's sole responsibility is to its Client and this document does not exonerate parties to a transaction from exercising all their rights and obligations under the transaction documents. This document cannot be reproduced except in full, without prior written approval of the Company. Any unauthorized alteration, forgery or falsification of the content or appearance of this document is unlawful and offenders may be prosecuted to the fullest extent of the law.

Operation Band	:BT4.0	Test Date	:2014-10-27
Fundamental Frequency	:2442 MHz	Temp./Humi.	:25.5deg_C/53RH
Operation Mode	:TX MID	Engineer	:Tai
EUT Pol.	:E2 Plan	Measurement Antenna Pol.	:HORIZONTAL

Actual FS(dBμV/m) = SPA. Reading level(dBμV) + Factor(dB)

Factor(dB) = Antenna Factor(dBμV/m) + Cable Loss(dB) – Pre\_Amplifier Gain(dB)

Note : “F” : denotes Fundamental Frequency. ; “H” : denotes Harmonic Frequency.

“E” : denotes Band Edge Frequency. ; “S” : denotes Spurious Frequency.

“---” : denotes Noise Floor.

Freq. MHz	Detector Mode PK/QP/AV	Note F/H/E/S	Spectrum Reading Level dBμV	Factor dB	Actual FS dBμV/m	Limit @3m dBμV/m	Margin dB
419.94	Peak	S	39.12	-14.97	24.15	46.00	-21.85
472.32	Peak	S	33.77	-14.16	19.61	46.00	-26.39
578.05	Peak	S	35.08	-12.11	22.97	46.00	-23.03
630.43	Peak	S	36.51	-11.69	24.82	46.00	-21.18
667.29	Peak	S	34.25	-11.71	22.55	46.00	-23.45
840.92	Peak	S	35.09	-8.89	26.20	46.00	-19.80
4884.00	Peak	H	41.20	0.06	41.26	74.00	-32.74
4884.00	Average	H	28.46	0.06	28.52	54.00	-25.48
7326.00	Peak	H	---				
9768.00	Peak	H	---				
12210.00	Peak	H	---				
14652.00	Peak	H	---				
17094.00	Peak	H	---				
19536.00	Peak	H	---				
21978.00	Peak	H	---				
24420.00	Peak	H	---				

Unless otherwise stated the results shown in this test report refer only to the sample(s) tested and such sample(s) are retained for 90 days only.

除非另有說明，此報告結果僅對測試之樣品負責，同時此樣品僅保留90天。本報告未經本公司書面許可，不可部份複製。

This document is issued by the Company subject to its General Conditions of Service printed overleaf, available on request or accessible at [www.sgs.com/terms\\_and\\_conditions.htm](http://www.sgs.com/terms_and_conditions.htm) and, for electronic format documents, subject to Terms and Conditions for Electronic Documents at [www.sgs.com/terms\\_e-document.htm](http://www.sgs.com/terms_e-document.htm). Attention is drawn to the limitation of liability, indemnification and jurisdiction issues defined therein. Any holder of this document is advised that information contained hereon reflects the Company's findings at the time of its intervention only and within the limits of Client's instructions, if any. The Company's sole responsibility is to its Client and this document does not exonerate parties to a transaction from exercising all their rights and obligations under the transaction documents. This document cannot be reproduced except in full, without prior written approval of the Company. Any unauthorized alteration, forgery or falsification of the content or appearance of this document is unlawful and offenders may be prosecuted to the fullest extent of the law.

Operation Band	:BT4.0	Test Date	:2014-10-27
Fundamental Frequency	:2480 MHz	Temp./Humi.	:25.5deg_C/53RH
Operation Mode	:TX HIGH	Engineer	:Tai
EUT Pol.	:E2 Plane	Measurement Antenna Pol.	:VERTICAL

Actual FS(dBμV/m) = SPA. Reading level(dBμV) + Factor(dB)

Factor(dB) = Antenna Factor(dBμV/m) + Cable Loss(dB) – Pre\_Amplifier Gain(dB)

Note : “F” : denotes Fundamental Frequency. ; “H” : denotes Harmonic Frequency.

“E” : denotes Band Edge Frequency. ; “S” : denotes Spurious Frequency.

“---” : denotes Noise Floor.

Freq. MHz	Detector Mode PK/QP/AV	Note F/H/E/S	Spectrum Reading Level dBμV	Factor dB	Actual FS dBμV/m	Limit @3m dBμV/m	Margin dB
64.92	Peak	S	47.86	-27.65	20.20	40.00	-19.80
419.94	Peak	S	35.09	-14.97	20.12	46.00	-25.88
578.05	Peak	S	33.48	-12.11	21.37	46.00	-24.63
630.43	Peak	S	37.44	-11.69	25.74	46.00	-20.26
667.29	Peak	S	33.73	-11.71	22.02	46.00	-23.98
840.92	Peak	S	35.61	-8.89	26.73	46.00	-19.27
4960.00	Peak	H	41.60	0.28	41.88	74.00	-32.12
4960.00	Average	H	28.56	0.28	28.84	54.00	-25.16
7440.00	Peak	H	---				
9920.00	Peak	H	---				
12400.00	Peak	H	---				
14880.00	Peak	H	---				
17360.00	Peak	H	---				
19840.00	Peak	H	---				
22320.00	Peak	H	---				
24800.00	Peak	H	---				

Unless otherwise stated the results shown in this test report refer only to the sample(s) tested and such sample(s) are retained for 90 days only.

除非另有說明，此報告結果僅對測試之樣品負責，同時此樣品僅保留90天。本報告未經本公司書面許可，不可部份複製。

This document is issued by the Company subject to its General Conditions of Service printed overleaf, available on request or accessible at [www.sgs.com/terms\\_and\\_conditions.htm](http://www.sgs.com/terms_and_conditions.htm) and, for electronic format documents, subject to Terms and Conditions for Electronic Documents at [www.sgs.com/terms\\_e-document.htm](http://www.sgs.com/terms_e-document.htm). Attention is drawn to the limitation of liability, indemnification and jurisdiction issues defined therein. Any holder of this document is advised that information contained hereon reflects the Company's findings at the time of its intervention only and within the limits of Client's instructions, if any. The Company's sole responsibility is to its Client and this document does not exonerate parties to a transaction from exercising all their rights and obligations under the transaction documents. This document cannot be reproduced except in full, without prior written approval of the Company. Any unauthorized alteration, forgery or falsification of the content or appearance of this document is unlawful and offenders may be prosecuted to the fullest extent of the law.

Operation Band	:BT4.0	Test Date	:2014-10-27
Fundamental Frequency	:2480 MHz	Temp./Humi.	:25.5deg_C/53RH
Operation Mode	:TX HIGH	Engineer	:Tai
EUT Pol.	:E2 Plane	Measurement Antenna Pol.	:HORIZONTAL

Actual FS(dBμV/m) = SPA. Reading level(dBμV) + Factor(dB)

Factor(dB) = Antenna Factor(dBμV/m) + Cable Loss(dB) – Pre\_Amplifier Gain(dB)

Note : “F” : denotes Fundamental Frequency. ; “H” : denotes Harmonic Frequency.

“E” : denotes Band Edge Frequency. ; “S” : denotes Spurious Frequency.

“---” : denotes Noise Floor.

Freq.	Detector	Note	Spectrum	Factor	Actual	Limit	Margin
MHz	PK/QP/AV	F/H/E/S	Reading Level	dB	FS	@3m	dB
			dBμV		dBμV/m	dBμV/m	
44.55	Peak	S	46.55	-22.69	23.85	40.00	-16.15
419.94	Peak	S	38.83	-14.97	23.87	46.00	-22.13
543.13	Peak	S	34.58	-12.82	21.76	46.00	-24.24
578.05	Peak	S	36.31	-12.11	24.20	46.00	-21.80
630.43	Peak	S	36.66	-11.69	24.97	46.00	-21.03
840.92	Peak	S	34.93	-8.89	26.04	46.00	-19.96
4960.00	Peak	H	41.91	0.28	42.19	74.00	-31.81
4960.00	Average	H	28.45	0.28	28.73	54.00	-25.27
7440.00	Peak	H	---				
9920.00	Peak	H	---				
12400.00	Peak	H	---				
14880.00	Peak	H	---				
17360.00	Peak	H	---				
19840.00	Peak	H	---				
22320.00	Peak	H	---				
24800.00	Peak	H	---				

Unless otherwise stated the results shown in this test report refer only to the sample(s) tested and such sample(s) are retained for 90 days only.

除非另有說明，此報告結果僅對測試之樣品負責，同時此樣品僅保留90天。本報告未經本公司書面許可，不可部份複製。

This document is issued by the Company subject to its General Conditions of Service printed overleaf, available on request or accessible at [www.sgs.com/terms\\_and\\_conditions.htm](http://www.sgs.com/terms_and_conditions.htm) and, for electronic format documents, subject to Terms and Conditions for Electronic Documents at [www.sgs.com/terms\\_e-document.htm](http://www.sgs.com/terms_e-document.htm). Attention is drawn to the limitation of liability, indemnification and jurisdiction issues defined therein. Any holder of this document is advised that information contained hereon reflects the Company's findings at the time of its intervention only and within the limits of Client's instructions, if any. The Company's sole responsibility is to its Client and this document does not exonerate parties to a transaction from exercising all their rights and obligations under the transaction documents. This document cannot be reproduced except in full, without prior written approval of the Company. Any unauthorized alteration, forgery or falsification of the content or appearance of this document is unlawful and offenders may be prosecuted to the fullest extent of the law.

## 11 PEAK POWER SPECTRAL DENSITY

### 11.1 Standard Applicable:

According to §15.247(e) For digitally modulated systems, the power spectral density conducted from the intentional radiator to the antenna shall not be greater than 8 dBm in any 3 kHz band during any time interval of continuous transmission. This power spectral density shall be determined in accordance with the provisions of paragraph (b) of this section. The same method of determining the conducted output power shall be used to determine the power spectral density.

According to RSS-210 issue 8, §A8.2(b) The transmitter power spectral density (into the antenna) shall not be greater than 8 dBm in any 3 kHz band during any time interval of continuous transmission.

### 11.2 Measurement Equipment Used:

Refer to section 7.2 for details.

### 11.3 Test Set-up:

Refer to section 8.3 for details.

### 11.4 Measurement Procedure: (following the measurement procedure 10.2 of KDB558074):

1. Set analyzer center frequency to DTS channel center frequency.
2. Set the span to 1.5 times the DTS channel bandwidth.
3. Set the RBW  $\geq$  3 kHz.
4. Set the VBW  $\geq$  3 x RBW.
5. Detector = peak.
6. Sweep time = auto couple.
7. Trace mode = max hold.
8. Allow trace to fully stabilize.
9. Use the peak marker function to determine the maximum amplitude level.
10. If measured value exceeds limit, reduce RBW (no less than 3 kHz) and repeat.

Unless otherwise stated the results shown in this test report refer only to the sample(s) tested and such sample(s) are retained for 90 days only.

除非另有說明，此報告結果僅對測試之樣品負責，同時此樣品僅保留90天。本報告未經本公司書面許可，不可部份複製。

This document is issued by the Company subject to its General Conditions of Service printed overleaf, available on request or accessible at [www.sgs.com/terms\\_and\\_conditions.htm](http://www.sgs.com/terms_and_conditions.htm) and, for electronic format documents, subject to Terms and Conditions for Electronic Documents at [www.sgs.com/terms\\_e-document.htm](http://www.sgs.com/terms_e-document.htm). Attention is drawn to the limitation of liability, indemnification and jurisdiction issues defined therein. Any holder of this document is advised that information contained hereon reflects the Company's findings at the time of its intervention only and within the limits of Client's instructions, if any. The Company's sole responsibility is to its Client and this document does not exonerate parties to a transaction from exercising all their rights and obligations under the transaction documents. This document cannot be reproduced except in full, without prior written approval of the Company. Any unauthorized alteration, forgery or falsification of the content or appearance of this document is unlawful and offenders may be prosecuted to the fullest extent of the law.

## 11.5 Measurement Result:

### BT4.0 mode

Frequency MHz	RF Power Density	Maximum Limit	Result
	Reading (dBm)	(dBm)	
2402	-10.76	8	PASS
2442	-11.20	8	PASS
2480	-14.13	8	PASS

**NOTE: cable loss as 1dB that offsets in the spectrum**

*Note: Refer to next page for plots.*

Unless otherwise stated the results shown in this test report refer only to the sample(s) tested and such sample(s) are retained for 90 days only.

除非另有說明，此報告結果僅對測試之樣品負責，同時此樣品僅保留90天。本報告未經本公司書面許可，不可部份複製。

This document is issued by the Company subject to its General Conditions of Service printed overleaf, available on request or accessible at [www.sgs.com/terms\\_and\\_conditions.htm](http://www.sgs.com/terms_and_conditions.htm) and, for electronic format documents, subject to Terms and Conditions for Electronic Documents at [www.sgs.com/terms\\_e-document.htm](http://www.sgs.com/terms_e-document.htm). Attention is drawn to the limitation of liability, indemnification and jurisdiction issues defined therein. Any holder of this document is advised that information contained hereon reflects the Company's findings at the time of its intervention only and within the limits of Client's instructions, if any. The Company's sole responsibility is to its Client and this document does not exonerate parties to a transaction from exercising all their rights and obligations under the transaction documents. This document cannot be reproduced except in full, without prior written approval of the Company. Any unauthorized alteration, forgery or falsification of the content or appearance of this document is unlawful and offenders may be prosecuted to the fullest extent of the law.

**BT4.0 mode**  
**Power Spectral Density Test Plot (CH-Low)**

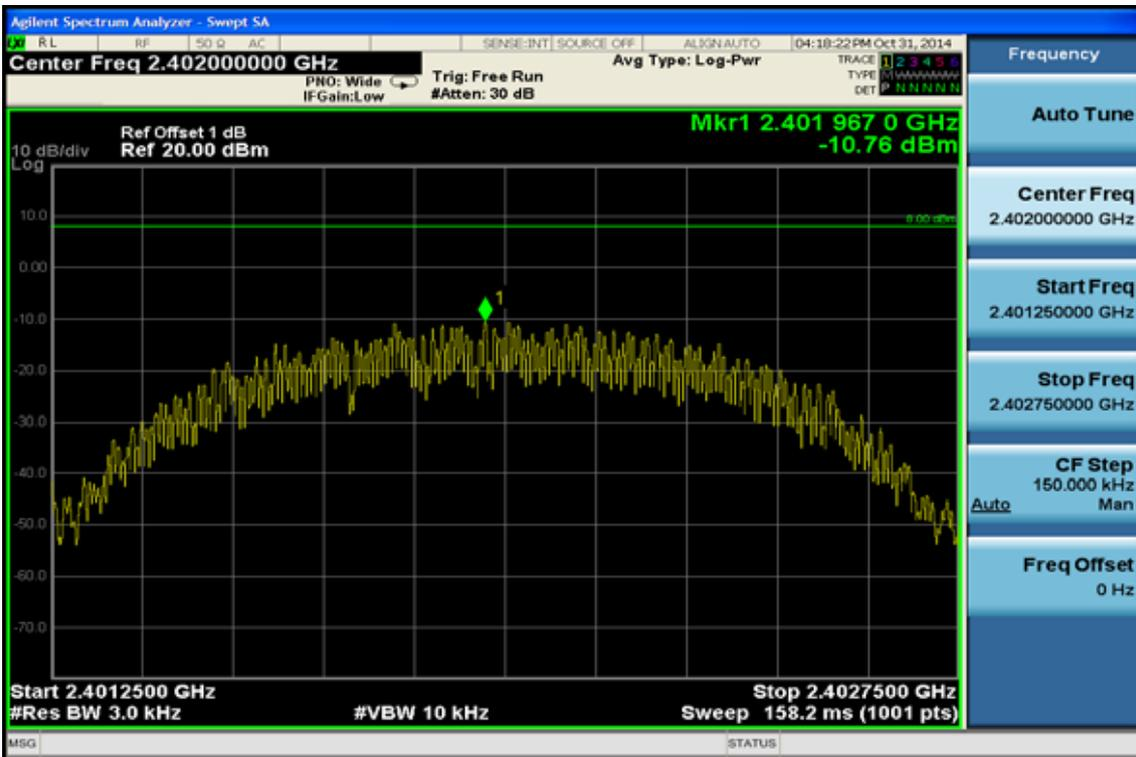

**Power Spectral Density Test Plot (CH-Mid)**

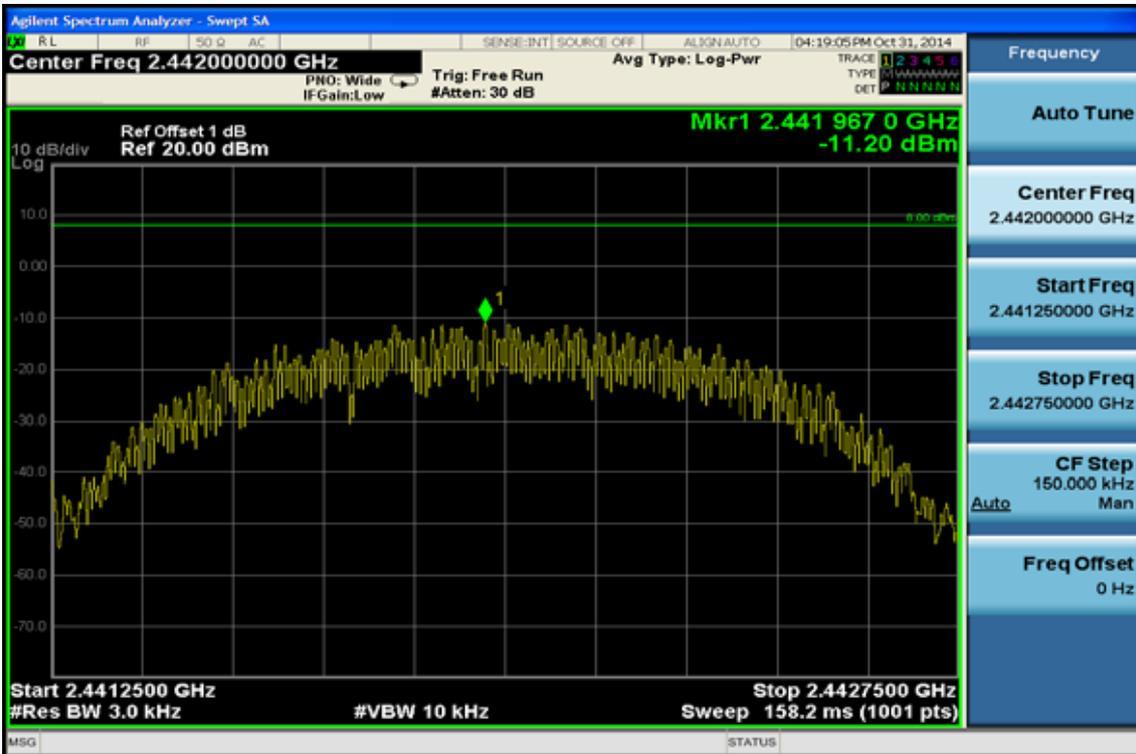

Unless otherwise stated the results shown in this test report refer only to the sample(s) tested and such sample(s) are retained for 90 days only.

除非另有說明，此報告結果僅對測試之樣品負責，同時此樣品僅保留90天。本報告未經本公司書面許可，不可部份複製。

This document is issued by the Company subject to its General Conditions of Service printed overleaf, available on request or accessible at [www.sgs.com/terms\\_and\\_conditions.htm](http://www.sgs.com/terms_and_conditions.htm) and, for electronic format documents, subject to Terms and Conditions for Electronic Documents at [www.sgs.com/terms\\_e-document.htm](http://www.sgs.com/terms_e-document.htm). Attention is drawn to the limitation of liability, indemnification and jurisdiction issues defined therein. Any holder of this document is advised that information contained hereon reflects the Company's findings at the time of its intervention only and within the limits of Client's instructions, if any. The Company's sole responsibility is to its Client and this document does not exonerate parties to a transaction from exercising all their rights and obligations under the transaction documents. This document cannot be reproduced except in full, without prior written approval of the Company. Any unauthorized alteration, forgery or falsification of the content or appearance of this document is unlawful and offenders may be prosecuted to the fullest extent of the law.

### Power Spectral Density Test Plot (CH-High)

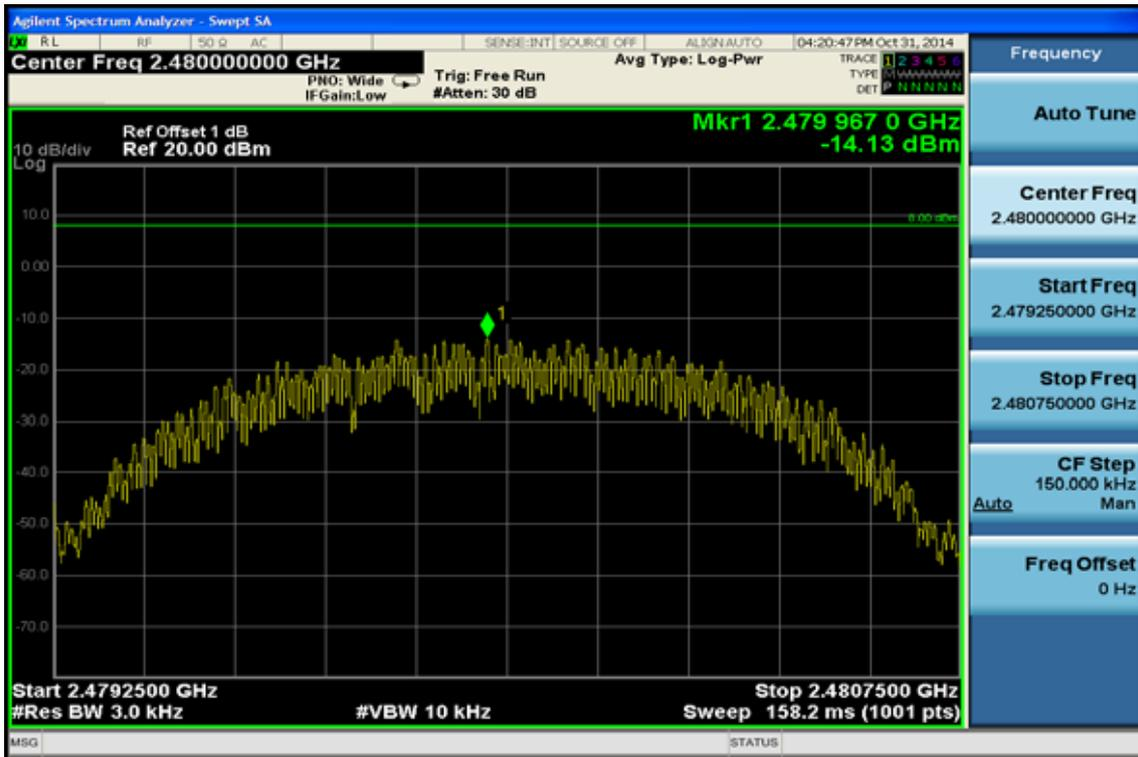

Unless otherwise stated the results shown in this test report refer only to the sample(s) tested and such sample(s) are retained for 90 days only.

除非另有說明，此報告結果僅對測試之樣品負責，同時此樣品僅保留90天。本報告未經本公司書面許可，不可部份複製。

This document is issued by the Company subject to its General Conditions of Service printed overleaf, available on request or accessible at [www.sgs.com/terms\\_and\\_conditions.htm](http://www.sgs.com/terms_and_conditions.htm) and, for electronic format documents, subject to Terms and Conditions for Electronic Documents at [www.sgs.com/terms\\_e-document.htm](http://www.sgs.com/terms_e-document.htm). Attention is drawn to the limitation of liability, indemnification and jurisdiction issues defined therein. Any holder of this document is advised that information contained hereon reflects the Company's findings at the time of its intervention only and within the limits of Client's instructions, if any. The Company's sole responsibility is to its Client and this document does not exonerate parties to a transaction from exercising all their rights and obligations under the transaction documents. This document cannot be reproduced except in full, without prior written approval of the Company. Any unauthorized alteration, forgery or falsification of the content or appearance of this document is unlawful and offenders may be prosecuted to the fullest extent of the law.

## 12 ANTENNA REQUIREMENT

### 12.1 Standard Applicable:

For intentional device, according to §15.203, an intentional radiator shall be designed to ensure that no antenna other than furnished by the responsible party shall be used with the device.

According to RSS-GEN 7.1.2, a transmitter can only be sold or operated with antennas with which it was certified. A transmitter may be certified with multiple antenna types. An antenna type comprises antennas having similar in-band and out-of-band radiation patterns. Testing shall be performed using the highest-gain antenna of each combination of transmitter and antenna type for which certification is being sought, with the transmitter output power set at the maximum level. Any antenna of the same type and having equal or lesser gain as an antenna that had been successfully tested for certification with the transmitter, will also be considered certified with the transmitter, and may be used and marketed with the transmitter. The manufacturer shall include with the application for certification a list of acceptable antenna types to be used with the transmitter.

When a measurement at the antenna connector is used to determine RF output power, the effective gain of the device's antenna shall be stated, based on measurement or on data from the antenna manufacturer. Any antenna gain in excess of 6 dBi (6 dB above isotropic gain) shall be added to the measured RF output power before using the power limits specified in RSS-210 or RSS-310 for devices of RF output powers of 10 milliwatts or less. For devices of output powers greater than 10 milliwatts, except devices subject to RSS-210 Annex 8 (Frequency Hopping and Digital Modulation Systems Operating in the 902-928 MHz, 2400-2483.5 MHz, and 5725-5850 MHz Bands) or RSS-210 Annex 9 (Local Area Network Devices), the total antenna gain shall be added to the measured RF output power before using the specified power limits. For devices subject to RSS-210 Annex 8 or Annex 9, the antenna gain shall not be added.

### 12.2 Antenna Connected Construction:

The directional gains of antenna used for transmitting is -0.53dBi, and the antenna connector is designed with unique type RF connector and no consideration of replacement. Please see EUT photo and antenna spec. for details.

Unless otherwise stated the results shown in this test report refer only to the sample(s) tested and such sample(s) are retained for 90 days only.

除非另有說明，此報告結果僅對測試之樣品負責，同時此樣品僅保留90天。本報告未經本公司書面許可，不可部份複製。

This document is issued by the Company subject to its General Conditions of Service printed overleaf, available on request or accessible at [www.sgs.com/terms\\_and\\_conditions.htm](http://www.sgs.com/terms_and_conditions.htm) and, for electronic format documents, subject to Terms and Conditions for Electronic Documents at [www.sgs.com/terms\\_e-document.htm](http://www.sgs.com/terms_e-document.htm). Attention is drawn to the limitation of liability, indemnification and jurisdiction issues defined therein. Any holder of this document is advised that information contained hereon reflects the Company's findings at the time of its intervention only and within the limits of Client's instructions, if any. The Company's sole responsibility is to its Client and this document does not exonerate parties to a transaction from exercising all their rights and obligations under the transaction documents. This document cannot be reproduced except in full, without prior written approval of the Company. Any unauthorized alteration, forgery or falsification of the content or appearance of this document is unlawful and offenders may be prosecuted to the fullest extent of the law.

## 13 99% BANDWIDTH MEASUREMENT

### 13.1 Standard Applicable:

RSS-Gen §4.6.1, the transmitter shall be operated at its maximum carrier power measured under normal test conditions. The span of the analyzer shall be set to capture all products of the modulation process, including the emission skirts. The resolution bandwidth shall be set to as close to 1% of the selected span as is possible without being below 1%. The video bandwidth shall be set to 3 times the resolution bandwidth. Video averaging is not permitted. Where practical, a sampling detector shall be used since a peak or, peak hold, may produce a wider bandwidth than actual.

The trace data points are recovered and are directly summed in linear terms. The recovered amplitude data points, beginning at the lowest frequency, are placed in a running sum until 0.5% of the total is reached and that frequency recorded. The process is repeated for the highest frequency data points. This frequency is recorded.

The span between the two recorded frequencies is the occupied bandwidth.

### 13.2 Measurement Equipment Used:

Refer to section 7.2 for details.

### 13.3 Test Set-up:

Refer to section 8.3 for details.

### 13.4 Measurement Procedure:

1. Place the EUT on the table and set it in transmitting mode.
2. Remove the antenna from the EUT and then connect a low loss RF cable from the antenna port to the spectrum analyzer.
3. Set the spectrum analyzer as RBW=1% of the Span, VBW = 3 times RBW, Span= 2MHz.
4. Turn on the 99% bandwidth function, max reading.
5. Repeat above procedures until all frequency measured were complete.

**NOTE: cable loss as 1dB that offsets in the spectrum**

Unless otherwise stated the results shown in this test report refer only to the sample(s) tested and such sample(s) are retained for 90 days only.

除非另有說明，此報告結果僅對測試之樣品負責，同時此樣品僅保留90天。本報告未經本公司書面許可，不可部份複製。

This document is issued by the Company subject to its General Conditions of Service printed overleaf, available on request or accessible at [www.sgs.com/terms\\_and\\_conditions.htm](http://www.sgs.com/terms_and_conditions.htm) and, for electronic format documents, subject to Terms and Conditions for Electronic Documents at [www.sgs.com/terms\\_e-document.htm](http://www.sgs.com/terms_e-document.htm). Attention is drawn to the limitation of liability, indemnification and jurisdiction issues defined therein. Any holder of this document is advised that information contained hereon reflects the Company's findings at the time of its intervention only and within the limits of Client's instructions, if any. The Company's sole responsibility is to its Client and this document does not exonerate parties to a transaction from exercising all their rights and obligations under the transaction documents. This document cannot be reproduced except in full, without prior written approval of the Company. Any unauthorized alteration, forgery or falsification of the content or appearance of this document is unlawful and offenders may be prosecuted to the fullest extent of the law.

### 13.5 Measurement Result:

#### BT4.0 mode

Frequency MHz	99%Bandwidth (MHz)
2402	1.0380
2442	1.0403
2480	1.0456

#### BT4.0 mode 99% Band Width Test Data CH-Low

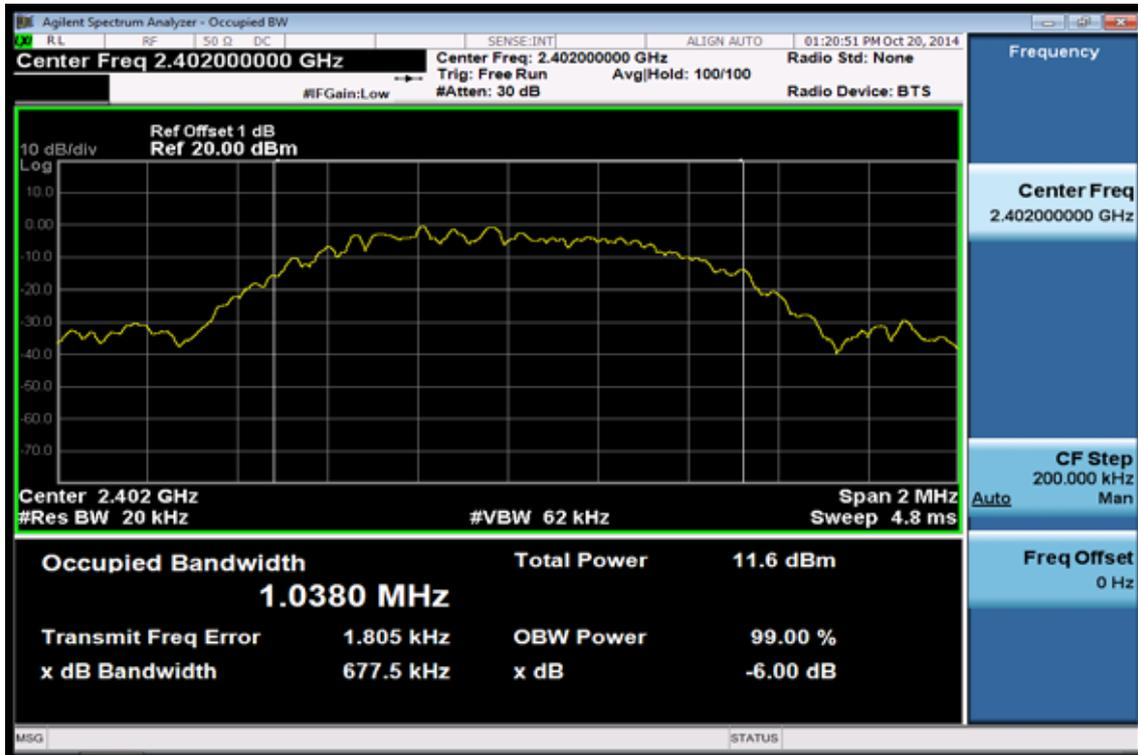

Unless otherwise stated the results shown in this test report refer only to the sample(s) tested and such sample(s) are retained for 90 days only.

除非另有說明，此報告結果僅對測試之樣品負責，同時此樣品僅保留90天。本報告未經本公司書面許可，不可部份複製。

This document is issued by the Company subject to its General Conditions of Service printed overleaf, available on request or accessible at [www.sgs.com/terms\\_and\\_conditions.htm](http://www.sgs.com/terms_and_conditions.htm) and, for electronic format documents, subject to Terms and Conditions for Electronic Documents at [www.sgs.com/terms\\_e-document.htm](http://www.sgs.com/terms_e-document.htm). Attention is drawn to the limitation of liability, indemnification and jurisdiction issues defined therein. Any holder of this document is advised that information contained hereon reflects the Company's findings at the time of its intervention only and within the limits of Client's instructions, if any. The Company's sole responsibility is to its Client and this document does not exonerate parties to a transaction from exercising all their rights and obligations under the transaction documents. This document cannot be reproduced except in full, without prior written approval of the Company. Any unauthorized alteration, forgery or falsification of the content or appearance of this document is unlawful and offenders may be prosecuted to the fullest extent of the law.

### 99% Band Width Test Data CH-Mid

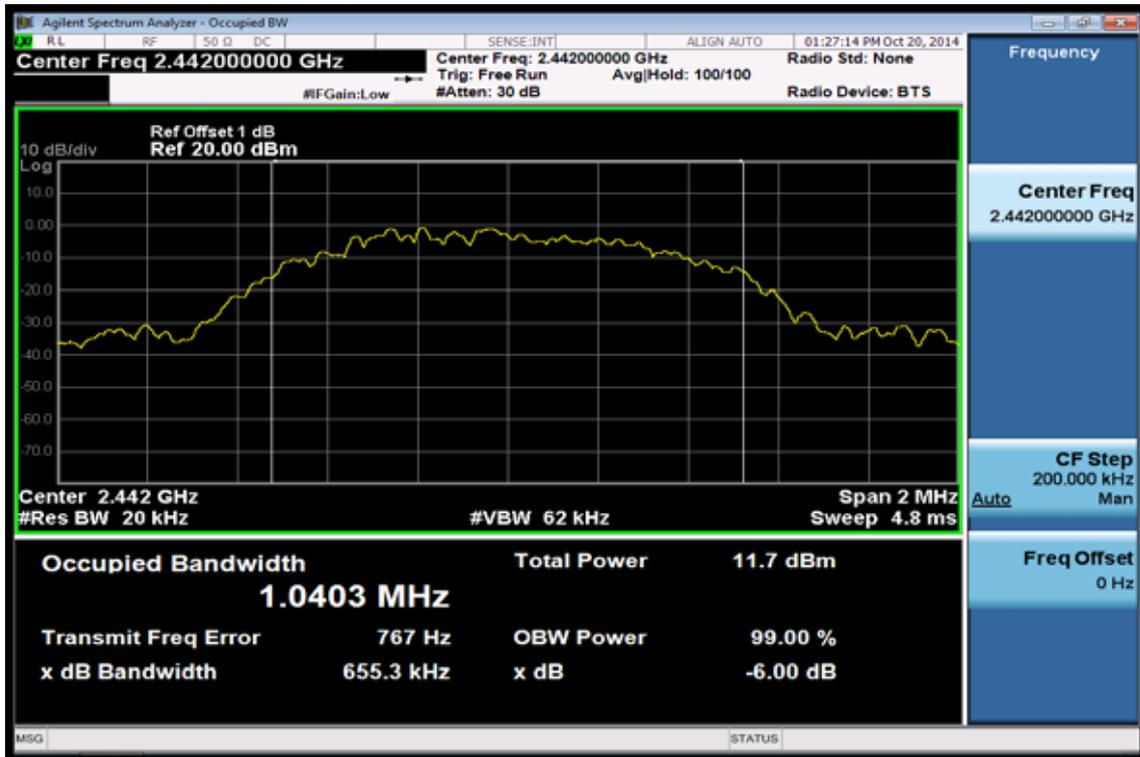

### 99% Band Width Test Data CH-High

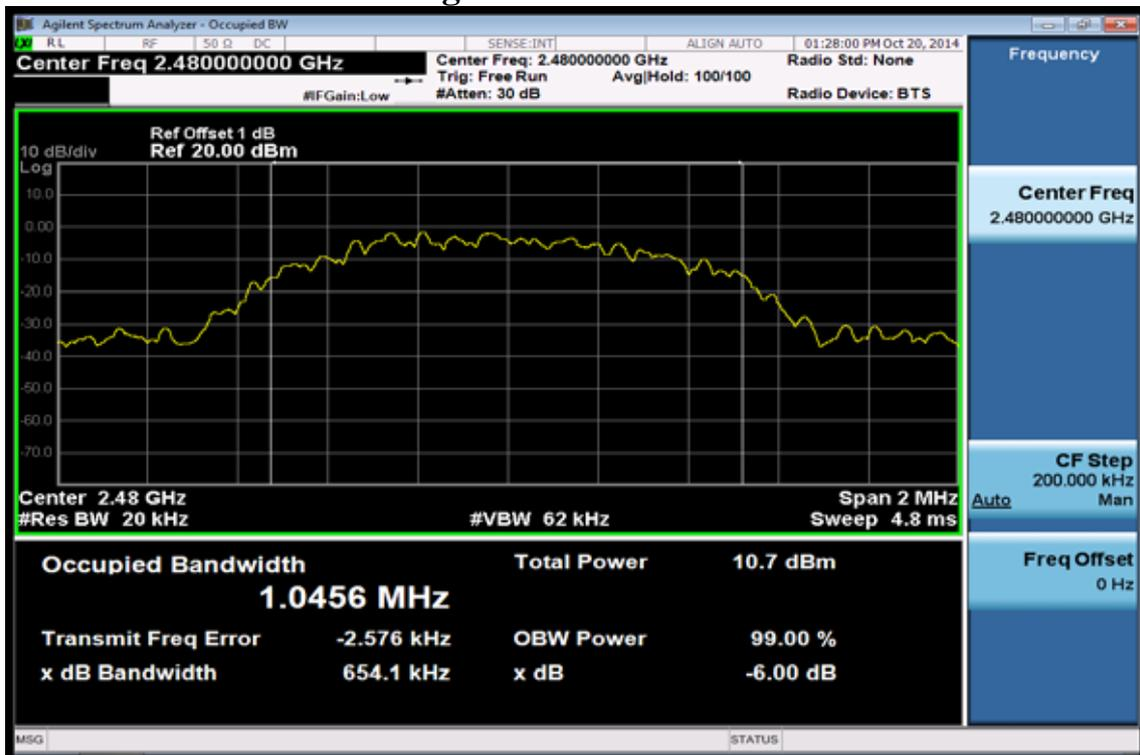

~ End of Report ~

Unless otherwise stated the results shown in this test report refer only to the sample(s) tested and such sample(s) are retained for 90 days only.

除非另有說明，此報告結果僅對測試之樣品負責，同時此樣品僅保留90天。本報告未經本公司書面許可，不可部份複製。

This document is issued by the Company subject to its General Conditions of Service printed overleaf, available on request or accessible at [www.sgs.com/terms\\_and\\_conditions.htm](http://www.sgs.com/terms_and_conditions.htm) and, for electronic format documents, subject to Terms and Conditions for Electronic Documents at [www.sgs.com/terms\\_e-document.htm](http://www.sgs.com/terms_e-document.htm). Attention is drawn to the limitation of liability, indemnification and jurisdiction issues defined therein. Any holder of this document is advised that information contained hereon reflects the Company's findings at the time of its intervention only and within the limits of Client's instructions, if any. The Company's sole responsibility is to its Client and this document does not exonerate parties to a transaction from exercising all their rights and obligations under the transaction documents. This document cannot be reproduced except in full, without prior written approval of the Company. Any unauthorized alteration, forgery or falsification of the content or appearance of this document is unlawful and offenders may be prosecuted to the fullest extent of the law.