

TEST REPORT

Report No. : 5183F
Date : 17th January 2006
Applicant : TAIYO YUDEN CO.,LTD.
8-1 Sakae-cho, Takasaki-shi, Gunma, 370-8522 Japan.
EUT : Bluetooth Module
FCC ID : RYYEYTF3CSFT
Model No. : EYTF3CSFT
Serial No. : 31
Receipt date of tested sample : 15th December 2005
Date of measurement : 20th, 21st December 2005 (Radiated Emission)
16th December 2005, 6th January 2006 (Conducted Emission)
10th, 11th January 2006 (AC Powerline Conducted Emission)
Test location : TAIYO YUDEN CO.,LTD., EMC Center
5607-2, Nakamuroda, Haruna-machi,
Gunma-Gun, Gunma, 370-3347, Japan.
Applied standard : FCC 47 CFR Part 15 Subpart C Section 15.247, (10-1-04 Edition)
Procedure : ANSI C63.4-2003
Test results: PASS



Approved by : 
Manager / Kenzo Furuta

Reviewed by : 
Chief Engineer / Takeshi Matsumura

Tested by : 
Test Engineer / Shin Itakura

Table of Contents

1	TEST REPORT	4
2	GENERAL INFORMATION	4
2.1	PRODUCT DESCRIPTION	4
2.2	SUMMARY OF TEST AND INSPECTION RESULT	5
2.3	TEST METHODOLOGY	5
2.4	TEST FACILITY	5
3	SYSTEM TEST CONFIGURATION	6
3.1	JUSTIFICATION	6
3.2	OPERATING MODES	7
3.3	LIST OF ACCESSORIES	8
3.4	INTERFACE CABLES	8
3.5	SPECIAL TEST CONDITION	9
3.6	EQUIPMENT MODIFICATIONS	9
3.7	CONFIGURATION OF TESTED SYSTEM	10
4	ANTENNA REQUIREMENT	11
5	AC POWERLINE CONDUCTED EMISSION TEST	12
5.1	TEST SETUP	12
5.2	TEST INSTRUMENTATION	12
5.3	CONDUCTED EMISSION CALCULATION	13
5.4	TEST RESULTS	14
5.4.1	Transmitting mode	14
5.4.2	Receiving mode	17
6	RADIATED EMISSION TEST	20
6.1	TEST SETUP	20
6.2	RADIATED EMISSION CALCULATION	21
6.3	TEST RESULTS	22
6.3.1	Transmitting mode	22
6.3.2	Receiving mode	31
7	20DB BANDWIDTH	40
7.1	TEST SETUP	40
7.2	TEST INSTRUMENT	40
7.3	TEST RESULTS	40
8	CARRIER FREQUENCY SEPARATION	41
8.1	TEST SETUP	41
8.2	TEST INSTRUMENT	41
8.3	TEST RESULTS	41
9	NUMBER OF HOPPING FREQUENCY	43
9.1	TEST SETUP	43
9.2	TEST INSTRUMENT	43
9.3	TEST RESULTS	43
10	DWELL TIME	45
10.1	TEST SETUP	45
10.2	TEST INSTRUMENT	45
10.3	TEST RESULTS	45
11	MAXIMUM PEAK OUTPUT POWER	49
11.1	TEST SETUP	49

11.2	TEST INSTRUMENT	49
11.3	TEST RESULTS	49
12	BAND EDGE COMPLIANCE.....	50
12.1	TEST SETUP	50
12.2	TEST INSTRUMENT	50
12.3	TEST RESULTS	50
13	SPURIOUS RF CONDUCTED EMISSION	54
13.1	TEST SETUP	54
13.2	TEST INSTRUMENT	54
13.3	TEST RESULTS	54
14	EIRP CALCULATION FROM PEAK POWER.....	64
15	PHOTOS OF TESTED EUT	65
16	PHOTOS OF TEST SETUP	66
16.1	PHOTOS OF RADIATED MEASUREMENT	66
16.2	PHOTOS OF CONDUCTED MEASUREMENT.....	68
APPENDIX 1.....		69
APPENDIX 2.....		71

1 Test report

- (1) This report summarizes the result of a single investigation and test result relate only to tested sample.
- (2) The report shall not be reproduced except in full without the written approval of the Taiyo Yuden Co.,Ltd.
- (3) This test report must not be used by the client to claim product endorsement by any government agency.

2 General Information

2.1 Product Description

EUT	: Bluetooth Module
Model No.	: EYTF3CSFT
Serial No.	: 31
FCC ID	: RYYEYTF3CSFT
Production stage	: Pre-Production
Summary of EUT	: 2.4GHz Bluetooth module
Modulation	: GFSK, $\pi/4$ DQPSK, 8DPSK
Power supply	: DC 3.3V
Weight	: 2.3g
Dimensions of EUT	: W26mm × D23mm × H2.65mm
Max antenna gain	: 3.27dBi
The clock frequencies used in this EUT:	
	1.MHz (IF-TX mode)
	1.5MHz (IF-RX mode)
	Fvco (1200.25 to 1239.25MHz[RX],1201 to 1240MHz[TX])
	X' tal (16 MHz)

EUT is attached to PC provided and it is a wireless applications to communicate with other Bluetooth devices.

This is operated within the bands 2400 – 2483.5MHz frequency hopping intentional radiators that comply with FCC15.247. It provides 79 channels. And it adopts an AFH function to prevent interference with other wireless applications. Refer to APPENDIX 1.

EUT operates in the unlicensed 2.4 GHz ISM (Industrial Scientific Medical) band. A frequency hop transceiver is applied to combat interference and fading.

Two modulation modes are defined. A mandatory mode, called Basic Rate, uses a shaped, binary FM modulation to minimize transceiver complexity (GFSK). An optional mode, called Enhanced Data Rate, uses PSK modulation and has two variants: $\pi/4$ -DQPSK and 8DPSK. The symbol rate for all modulation schemes is 1 Ms/s. The gross air data rate is 1 Mbps for Basic Rate, 2 Mbps for Enhanced Data Rate using $\pi/4$ -DQPSK and 3 Mbps for Enhanced Data Rate using 8DPSK.

2.2 Summary of Test and Inspection Result

No.	Item	Test Procedure	Specification	Remarks	Deviation	Worst Margin	Results
1	AC Powerline Conducted Emission	ANSI C63.4:2003	FCC 15.207	-	N/A	4.4dB Transmittingmode:2402MHz 0.200MHz VA (AV) and Transmittingmode:2441MHz 0.200MHz VA (AV)	Pass
2	Carrier Frequency Separation	ANSI C63.4:2003 Public Notice DA00-705	FCC 15.247(a)(1)	Conducted	N/A	-	Pass
3	Number of Hoping Frequency		FCC 15.247(a)(1)(iii)		N/A	-	Pass
4	Dwell time		FCC 15.247(a)(1)(iii)		N/A	-	Pass
5	Maximum peak Output Power		FCC 15.247(b)(1)		N/A	-	Pass
6	Band Edge Compliance		FCC 15.247(c)		N/A	-	Pass
7	Spurious RF Conducted Emission		FCC 15.247(c)		N/A	-	Pass
8	Radiated Emission		FCC 15.247(c)		Radiated	N/A	4.2dB Transmitting mode:2480MHz Direction:ZX Vertical (AV) 4959.608MHz

2.3 Test Methodology

Interference measurements were made in accordance with ANSI C63.4-2003 Methods of Measurement of Radio-Noise Emissions from Low-Voltage Electrical and Electronic Equipment in the Range of 9 kHz to 40 GHz.

2.4 Test Facility

1. FCC 47CFR, Part 15, Section 15.247 regulation test were performed on the shielded room, and radiated interference field strength test was performed on the 10 meter semi-anechoic chamber located at Taiyo Yuden Co.,Ltd. EMC Center, 5607-2 Nakamuroda Haruna-Machi Gunma-Gun Gunma, 370-3347 Japan.
2. This Laboratory is accredited under the National Voluntary Laboratory Accreditation Program (NVLAP) by United States Department of Commerce, National Institute of Standard and Technology (NIST) for satisfactory compliance with criteria established in Title 15, Part 285 Code of Federal Regulations.
3. These criteria encompass the requirements of ISO/IEC 17025:1999 and the relevant requirements of ISO 9002:1994 as suppliers of calibration or test results. Accreditation awarded for specific services, listed on the Scope of Accreditation for: ELECTROMAGNETIC COMPATIBILITY AND TELECOMMUNICATIONS FCC. (NVLAP LAB CODE: 200607-0). Refer the certificate of the accreditation to Appendix 2.

3 System Test Configuration

3.1 Justification

1. Emission tests were performed with no deviation from the ANSI C63.4-2003 and FCC 47CFR, Part 15, Section 15.247 regulation tests were performed with no deviation from the FCC Public Notice DA00-705 released March 30, 2000.
2. The system was configured for testing a typical fashion. (as a customer would normally use it.)
3. Radiate testing in the range of 1 GHz to 25 GHz was investigated with the spectrum (peak detector function) under the FCC regulation section 15.209 (e) and 15.35 (b). The test performed at an antenna to EUT distance of 1 meter. The level of any unwanted emissions from EUT did not exceed the level of the fundamental emission (Compliance with 15.209 (c)). And test result found to be compliance with FCC regulation section 15.209 (a) Radiated emission limits (500 micro-volts/meter). Data is presented for the "worst case" measurements, that E.U.T was normal operated.
4. Radiate testing in the range of 30 MHz to 1000 MHz was performed at an antenna to EUT distance of 3 meters under the 15.209 (e) and 15.31(f)(1).
5. All tests were performed with the representative channel operation as follows.
 - a. Lowest frequency channel : CH0 2402MHz
 - b. Middle frequency channel : CH39 2441MHz
 - c. Highest frequency channel : CH78 2480MHz

3.2 Operating modes

Mode	Explanation of the mode	
Transmitting mode	GFSK	Signal pattern : PRBS9 Signal packet type : DH1,DH3,DH5(for Dwell time test) DH5 (for other test)
	$\pi/4$ DQPSK	Signal pattern : PRBS9 Signal packet type : 2-DH5
	8DPSK	Signal pattern : PRBS9 Signal packet type : 3-DH5
Receiving mode	RX continuous	

DH1	Description : A 1 slot, Data High rate, ACL type packet. Supports a data payload of 0 to 27 bytes with CRC, no FEC, and fully transmits within one consecutive 625 microsecond transmission slots.
DH3	Description : A 3 slot, Data High rate, ACL type packet. Supports a data payload of 0 to 183 bytes with CRC, no FEC, and fully transmits within three consecutive 625 microsecond transmission slots.
DH5	Description : A 5 slot, Data High rate, ACL type packet. Supports a data payload of 0 to 339 bytes with CRC, no FEC, and fully transmits within five consecutive 625 microsecond transmission slots.
2-DH5	This packet is similar to the DH5 packet except that the payload is modulated using $\pi/4$ -DQPSK. The 2-DH5 packet has between 2 and 681 information bytes (including the 2-byte payload header) plus a 16-bit CRC code. The 2-DH5 packet may occupy up to five time slots.
3-DH5	This packet is similar to the DH5 packet except that the payload is modulated using 8DPSK. The 3-DH5 packet has between 2 and 1023 information bytes (including the 2-byte payload header) plus a 16-bit CRC code. The 3-DH5 packet may occupy up to five time slots.
PRBS9	A periodic Pseudo Random Bit Sequence. $2^9 - 1$

3.3 List of accessories

	Product name	M/N	S/N	Manufacturer	Notes	FCC ID / DoC
a	Supporting equipment	-	31	TAIYO YUDEN Co.,Ltd	-	N/A
b	Personal Computer	PP04S	CN-0Y0119-36521-467-2020	DELL	-	FCC ID: QDS-BRCM1007
c	AC Adapter for PC	PA-1650-05D	-	DELL	-	N/A
d	Regulated DC power supply	PA18-1.2	2110071	KENWOOD	-	N/A
e	Modem	V.32bis	14E231907	DIREX	-	FCC ID: FCZ5D3144FX
f	Printer	PIXUS 550i	-	CANON	-	DoC
g	Personal Computer	Lifebook E8110	X145A880005P	FUJITSU LIMITED	-	N/A *1
h	AC Adapter for PC	SEB100P2-19.0	-	FUJITSU LIMITED	-	N/A
i	AC Adapter for Modem	PAD-105	-	NEC	-	N/A

*1 This PC is intended to equip EUT internally. Therefore, this PC was chosen as one of representative equipments that equip EUT.

3.4 Interface cables

	Cable Type	M/N	Connection	Ferrite core	Shielded	Material of connector	Length	Treatment for the extra length
1	Flexible Flat cable	-	a↔EUT (Radiated, Conducted) g↔EUT (AC Powerline Conducted Emission)	No	No	Plastic	0.17m	-
2	USB cable	-	EUT↔3 (Radiated) EUT↔b (Conducted)	No	Yes	Metal	0.95m	-
3	USB cable	-	2↔b	Yes	Yes	Metal	3.10m	-
4	RS232C cable	-	g↔e	No	Yes	Metal	1.55m	Fold back and forth in the center
5	Parallel cable	-	g↔f	No	Yes	Metal	1.38m	-
6	DC cable	-	b↔c	Yes	Yes	Metal	0.90m	-
7	AC cable	-	c↔AC	No	No	Plastic	1.75m	-
8	DC cable	-	e↔i	No	Yes	Metal	1.87m	-
9	AC cable	-	f↔AC	No	No	Plastic	2.00m	-
10	DC cable	-	g↔h	No	Yes	Metal	1.77m	Fold back and forth in the center
11	AC cable	-	h↔AC	No	No	Plastic	1.90m	Fold back and forth in the center
12	AC cable	-	d↔AC	No	No	Plastic	1.95m	-
13	DC cable	-	a↔14 (Radiated) a↔d (Conducted)	No	No	Plastic	0.50m	-
14	DC cable	-	13↔d	Yes	No	Plastic	0.92m	-

3.5 Special Test Condition

Nothing

3.6 Equipment Modifications

No modification has been carried out by the test laboratory.

3.7 Configuration of Tested System

Operation within the bands 2400-2483.5MHz

Radiated Emission Test

These numbers and the marks in the picture are corresponding to the numbers and the marks in Tables shown at the Section 3.3 and 3.4.

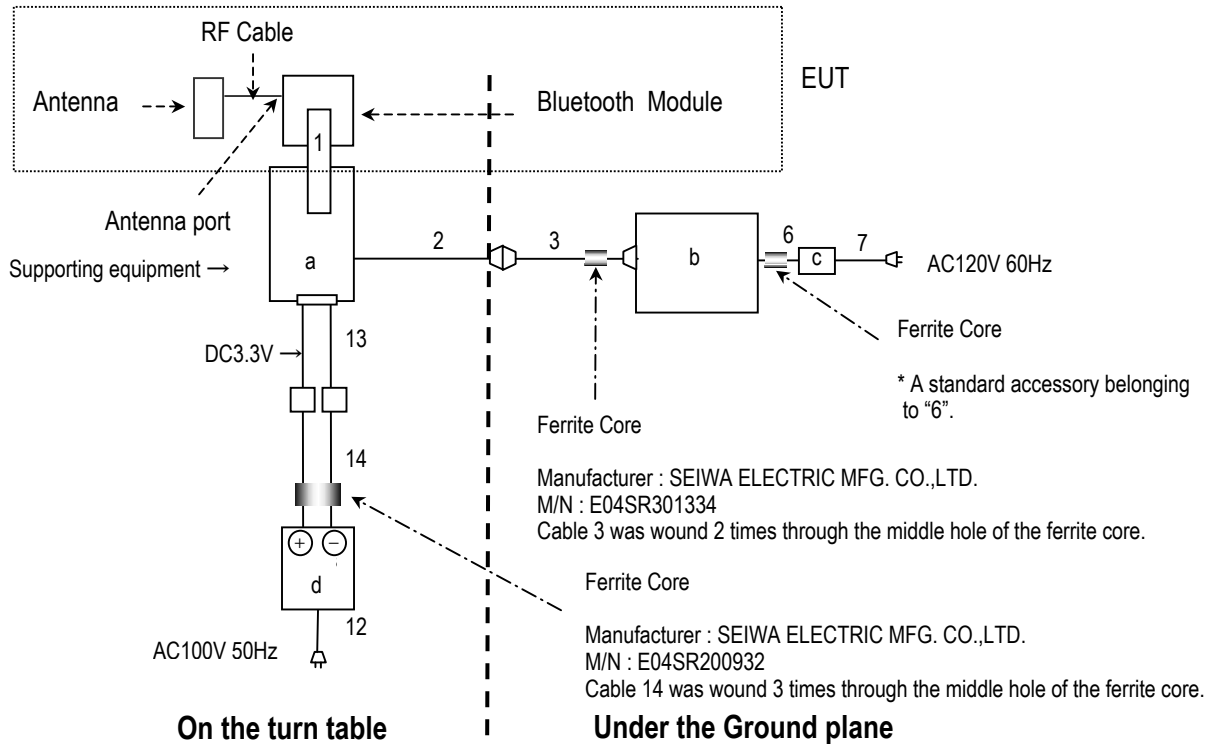

Conducted Emission Test

These numbers and the marks in the picture are corresponding to the numbers and the marks in Tables shown at the Section 3.3 and 3.4.

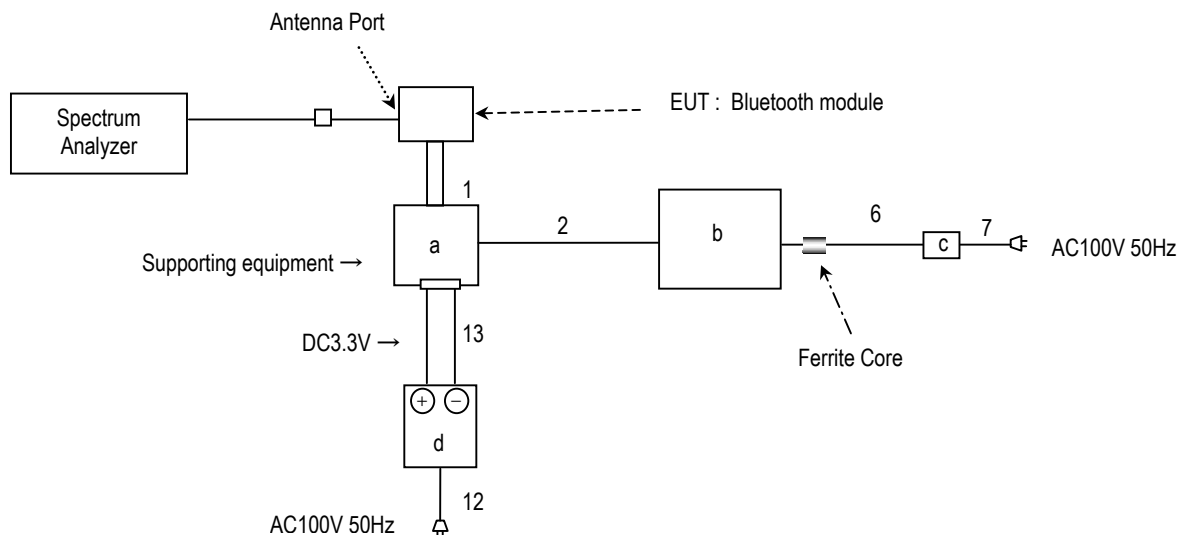

AC Power line Conducted Emission Test

These numbers and the marks in the picture are corresponding to the numbers and the marks in Tables shown at the Section 3.3 and 3.4.

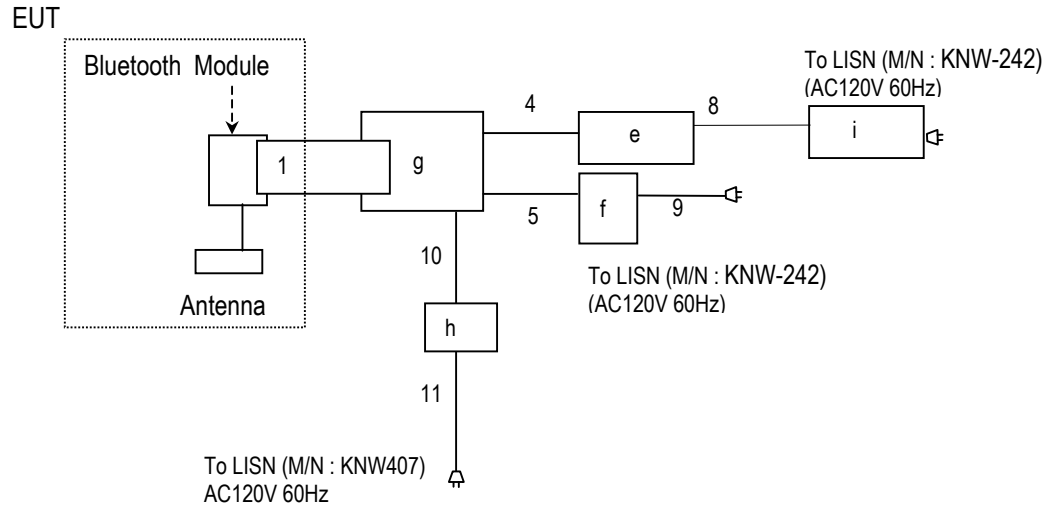

4 Antenna Requirement

An antenna that uses an unique coupling to the intentional radiator was provided with EUT from manufacturer. The antenna is connected to the antenna port of the module through the RF cable that is 0.05m long. Connector type at the antenna port is U.FL-R-SMT-1 model supplied only from Hirose ELECTRIC CO.,LTD. Therefore, it found to be compliance with FCC regulation section 15.203 .

Antenna Data
 Manufacturer: FUJITSU LIMITED
 Model No.: CP115428-01
 Antenna Size : W35mm × D13mm

Refer to Section 15 of this REPORT.

5 AC Powerline Conducted Emission Test

5.1 Test Setup

Conducted emission measurements were performed from 150kHz to 30 MHz.

The test setup was made according to ANSI STD C63.4-2003 clause 7 in the Shielded room.

The rear of non-conductive wooden table top was placed 0.4 m from a vertical metal reference plane that one of the wall.

Rears of the peripherals were all aligned and flush with rear of non-conductive wooden tabletop.

The height of this table was 0.8 m and 1.5 m wide x 1.0 m deep size.

The spacing between the each equipment was 10 cm.

Connection of the Handy printer connected EUT to the artificial mains network (LISN) was required.

The distance between the closet surface of the EUT and the closet surface of the artificial mains network (LISN) was 0.8 m.

Connection of the all other equipment to the second artificial mains network (LISN) was required. The distance between the peripherals and the closet surface of the second artificial mains network (LISN) was minimum 0.8 m.

The second artificial mains network is terminated with 50 ohm terminator. Where a mains flexible cord is provided by the manufacture this is 2.0 m long and excess cable was folded back and forth as far as possible to 0.8 m so as to from a bundle not exceeding 0.4 m in length. Interconnecting cables of table top equipment that hang closer than 0.4 m to the floor ground plane were folded back and forth forming a bundle 30 to 40 cm long, hanging approximately in the middle between ground plane and table.

The measurement has been conducted with both neutral (VA) and line (VB) power supply polarization.

The highest voltage emission has been recorded.

For further description of the configuration refer to the photographs of this report.

Detector Mode: Quasi-Peak and Average

Bandwidth: 10kHz

5.2 Test Instrumentation

Facility/ Equipment	Manufacturer	Model No.	Serial No.	Calibration Date	Next Calibration Due	Note
Shielded room	TDK Co.,Ltd	DA-06912	-	-	-	-
EMI Test Receiver	R&S	ESHS 10	100005	10 th .8.2005.	9 th .8.2006.	-
LISN	KYORITSU ELECTRICAL WORK	KNW-407	8-680-1	19 th .3.2004.	18 th .3.2006.	for PC to connect EUT
		KNW-242	8-818-8	19 th .3.2004.	18 th .3.2006.	for peripherals other than PC
Cable	SUHNER	RG223	CE-1	27 th .4.2005	26 th .4.2006.	-
		RG223	CE-2	27 th .4.2005	26 th .4.2006.	-
		RG2214	CE-3	27 th .4.2005	26 th .4.2006.	-
Attenuator	KYORITSU	KPD-602	5K325	27 th .4.2005	26 th .4.2006.	-
Pulse Limiter	Agilent Technologies	11867A	1387	27 th .4.2005	26 th .4.2006.	-
RF Selector	TDK Co.,Ltd	NS4900	0302-009	27 th .4.2005	26 th .4.2006.	-
50 Ω terminator	Agilent Technologies	HP11593A	No.1	19 th .3.2004	18 th .3.2006.	-
Software	TOYO Corporation	EP5/CE Ver.2.0	0208085	-	-	-

5.3 Conducted Emission Calculation

The basic equation with a sample calculation is as follows:

$$\begin{aligned} \text{c.f.} &= \text{CF} + \text{AL} \\ \text{CE} &= \text{RA} + \text{c.f.} \end{aligned}$$

Where

- c.f. = Correction Factor (dB)
- CE = Conducted Emission (Emission Level - Result) (dB μ V)
- RA = Receiver Amplitude (Reading Level) (dB μ V)
- CF = Cable Attenuation Loss (dB)
- AL = Attenuator Loss (dB)

Assume a receiver reading of 37.5 dB μ V is obtained. The Factor of 3.5dB is added, giving a terminal voltage of 41.0 dB μ V. The 41.0 dB μ V value was mathematically converted to its corresponding level in μ V.

$$\text{CE} = 37.5 + 3.5 = 41.0 \text{ dB } \mu \text{ V}$$

Level in μ V = Common Antilogarithm : $10^{(41.0/20)} = 112.2 \mu \text{ V}$

5.4 Test Results

AC Power conducted emission was measured in all test modes; GFSK Modulation, $\pi/4$ DQPSK Modulation, 8DPSK Modulation.

The results show the worst case.

5.4.1 Transmitting mode

AC Powerline Conducted Emission 2402MHz

Serial No. : 31
 Power : AC 120V 60Hz
 Mode : Transmitting mode (GFSK Modulation)
 Temperature : 22°C
 Humidity : 51%

VA

Frequency [MHz]	Meter Reading [dB(μV)]		Factor [dB]	Conducted Emission [dB(μV)]		Limits [dB(μV)]		Margin [dB]	
	QP	AV		QP	AV	QP	AV	QP	AV
0.150	50.6	32.0	3.5	54.1	35.5	66.0	56.0	11.9	20.5
0.200	52.7	45.8	3.4	56.1	49.2	63.6	53.6	7.5	4.4
0.323	42.1	32.9	3.3	45.4	36.2	59.6	49.6	14.2	13.4
0.408	43.9	35.6	3.3	47.2	38.9	57.7	47.7	10.5	8.8
0.974	34.0	20.4	3.3	37.3	23.7	56.0	46.0	18.7	22.3

VB

Frequency [MHz]	Meter Reading [dB(μV)]		Factor [dB]	Conducted Emission [dB(μV)]		Limits [dB(μV)]		Margin [dB]	
	QP	AV		QP	AV	QP	AV	QP	AV
0.152	55.4	38.1	3.4	58.8	41.5	65.9	55.9	7.1	14.4
0.200	52.7	45.7	3.3	56.0	49.0	63.6	53.6	7.6	4.6
0.321	45.0	33.3	3.3	48.3	36.6	59.7	49.7	11.4	13.1
0.431	45.1	33.5	3.3	48.4	36.8	57.2	47.2	8.8	10.4
0.546	38.5	27.6	3.3	41.8	30.9	56.0	46.0	14.2	15.1
0.973	35.1	21.3	3.3	38.4	24.6	56.0	46.0	17.6	21.4
1.531	34.8	23.0	3.3	38.1	26.3	56.0	46.0	17.9	19.7

Conducted Emission 2441MHz

Serial No. : 31
 Power : AC 120V 60Hz
 Mode : Transmitting mode (GFSK Modulation)
 Temperature : 22°C
 Humidity : 51%

VA

Frequency [MHz]	Meter Reading [dB(μV)]		Factor [dB]	Conducted Emission [dB(μV)]		Limits [dB(μV)]		Margin [dB]	
	QP	AV		QP	AV	QP	AV	QP	AV
0.151	50.5	31.8	3.5	54.0	35.3	65.9	55.9	11.9	20.6
0.200	52.7	45.8	3.4	56.1	49.2	63.6	53.6	7.5	4.4
0.303	43.7	36.4	3.3	47.0	39.7	60.2	50.2	13.2	10.5
0.408	44.1	35.8	3.3	47.4	39.1	57.7	47.7	10.3	8.6

VB

Frequency [MHz]	Meter Reading [dB(μV)]		Factor [dB]	Conducted Emission [dB(μV)]		Limits [dB(μV)]		Margin [dB]	
	QP	AV		QP	AV	QP	AV	QP	AV
0.154	55.4	39.1	3.4	58.8	42.5	65.8	55.8	7.0	13.3
0.200	52.6	45.7	3.3	55.9	49.0	63.6	53.6	7.7	4.6
0.318	45.6	34.5	3.3	48.9	37.8	59.8	49.8	10.9	12.0
0.432	45.1	33.5	3.3	48.4	36.8	57.2	47.2	8.8	10.4
0.972	35.4	21.4	3.3	38.7	24.7	56.0	46.0	17.3	21.3

Conducted Emission 2480MHz

Serial No. : 31
 Power : AC 120V 60Hz
 Mode : Transmitting mode (GFSK Modulation)
 Temperature : 22°C
 Humidity : 51%

VA

Frequency [MHz]	Meter Reading [dB(μV)]		Factor [dB]	Conducted Emission [dB(μV)]		Limits [dB(μV)]		Margin [dB]	
	QP	AV		QP	AV	QP	AV	QP	AV
0.152	50.4	31.7	3.5	53.9	35.2	65.9	55.9	12.0	20.7
0.201	52.7	45.6	3.4	56.1	49.0	63.6	53.6	7.5	4.6
0.302	43.8	36.4	3.3	47.1	39.7	60.2	50.2	13.1	10.5
0.423	43.1	32.3	3.3	46.4	35.6	57.4	47.4	11.0	11.8

VB

Frequency [MHz]	Meter Reading [dB(μV)]		Factor [dB]	Conducted Emission [dB(μV)]		Limits [dB(μV)]		Margin [dB]	
	QP	AV		QP	AV	QP	AV	QP	AV
0.150	55.2	38.7	3.4	58.6	42.1	66.0	56.0	7.4	13.9
0.200	52.6	45.7	3.3	55.9	49.0	63.6	53.6	7.7	4.6
0.319	45.3	34.5	3.3	48.6	37.8	59.7	49.7	11.1	11.9
0.434	45.0	33.6	3.3	48.3	36.9	57.2	47.2	8.9	10.3
0.972	35.2	21.4	3.3	38.5	24.7	56.0	46.0	17.5	21.3

5.4.2 Receiving mode

AC Powerline Conducted Emission 2402MHz

Serial No. : 31
 Power : AC 120V 60Hz
 Mode : Receiving mode
 Temperature : 21°C
 Humidity : 60%

VA

Frequency [MHz]	Meter Reading [dB(μV)]		Factor [dB]	Conducted Emission [dB(μV)]		Limits [dB(μV)]		Margin [dB]	
	QP	AV		QP	AV	QP	AV	QP	AV
0.150	50.5	32.2	3.5	54.0	35.7	66.0	56.0	12.0	20.3
0.201	52.5	45.5	3.4	55.9	48.9	63.6	53.6	7.7	4.7
0.310	42.3	35.9	3.3	45.6	39.2	60.0	50.0	14.4	10.8
0.409	43.3	35.1	3.3	46.6	38.4	57.7	47.7	11.1	9.3
0.908	31.1	20.4	3.3	34.4	23.7	56.0	46.0	21.6	22.3

VB

Frequency [MHz]	Meter Reading [dB(μV)]		Factor [dB]	Conducted Emission [dB(μV)]		Limits [dB(μV)]		Margin [dB]	
	QP	AV		QP	AV	QP	AV	QP	AV
0.152	55.4	37.0	3.4	58.8	40.4	65.9	55.9	7.1	15.5
0.200	52.7	45.6	3.3	56.0	48.9	63.6	53.6	7.6	4.7
0.318	45.2	33.8	3.3	48.5	37.1	59.8	49.8	11.3	12.7
0.408	43.4	35.2	3.3	46.7	38.5	57.7	47.7	11.0	9.2
0.511	36.8	27.6	3.3	40.1	30.9	56.0	46.0	15.9	15.1

Conducted Emission 2441MHz

Serial No. : 31
 Power : AC 120V 60Hz
 Mode : Receiving mode
 Temperature : 21°C
 Humidity : 60%

VA

Frequency [MHz]	Meter Reading [dB(μV)]		Factor [dB]	Conducted Emission [dB(μV)]		Limits [dB(μV)]		Margin [dB]	
	QP	AV		QP	AV	QP	AV	QP	AV
0.151	50.0	31.4	3.5	53.5	34.9	65.9	55.9	12.4	21.0
0.200	52.5	45.5	3.4	55.9	48.9	63.6	53.6	7.7	4.7
0.308	42.5	36.0	3.3	45.8	39.3	60.0	50.0	14.2	10.7
0.412	43.3	35.1	3.3	46.6	38.4	57.6	47.6	11.0	9.2
0.836	33.5	17.1	3.3	36.8	20.4	56.0	46.0	19.2	25.6
1.530	34.4	22.3	3.4	37.8	25.7	56.0	46.0	18.2	20.3

VB

Frequency [MHz]	Meter Reading [dB(μV)]		Factor [dB]	Conducted Emission [dB(μV)]		Limits [dB(μV)]		Margin [dB]	
	QP	AV		QP	AV	QP	AV	QP	AV
0.161	55.4	39.2	3.4	58.8	42.6	65.4	55.4	6.6	12.8
0.200	52.7	45.8	3.3	56.0	49.1	63.6	53.6	7.6	4.5
0.320	44.6	34.0	3.3	47.9	37.3	59.7	49.7	11.8	12.4
0.408	43.8	35.6	3.3	47.1	38.9	57.7	47.7	10.6	8.8
0.982	33.3	21.5	3.3	36.6	24.8	56.0	46.0	19.4	21.2

Conducted Emission 2480MHz

Serial No. : 31
 Power : AC 120V 60Hz
 Mode : Receiving mode
 Temperature : 21°C
 Humidity : 60%

VA

Frequency [MHz]	Meter Reading [dB(μV)]		Factor [dB]	Conducted Emission [dB(μV)]		Limits [dB(μV)]		Margin [dB]	
	QP	AV		QP	AV	QP	AV	QP	AV
0.151	50.2	31.7	3.5	53.7	35.2	65.9	55.9	12.2	20.7
0.200	52.5	45.5	3.4	55.9	48.9	63.6	53.6	7.7	4.7
0.309	42.8	36.2	3.3	46.1	39.5	60.0	50.0	13.9	10.5
0.409	43.6	35.3	3.3	46.9	38.6	57.7	47.7	10.8	9.1
0.840	33.7	17.1	3.3	37.0	20.4	56.0	46.0	19.0	25.6
1.462	32.3	14.8	3.3	35.6	18.1	56.0	46.0	20.4	27.9

VB

Frequency [MHz]	Meter Reading [dB(μV)]		Factor [dB]	Conducted Emission [dB(μV)]		Limits [dB(μV)]		Margin [dB]	
	QP	AV		QP	AV	QP	AV	QP	AV
0.153	55.2	39.0	3.4	58.6	42.4	65.8	55.8	7.2	13.4
0.201	52.7	45.8	3.3	56.0	49.1	63.6	53.6	7.6	4.5
0.319	45.2	34.8	3.3	48.5	38.1	59.7	49.7	11.2	11.6
0.410	43.7	34.2	3.3	47.0	37.5	57.6	47.6	10.6	10.1

6 Radiated Emission Test

6.1 Test Setup

The test setup was made according to ANSI STD C63.4-2003 clause 8 on the 10 meter semi-anechoic chamber, which allows a 3 or 1 m distance measurement. EUT was placed on non-conductive table (foam polystyrene). The height of this table was 0.8 m. The measurement has been conducted with both horizontal and vertical antenna polarization. The turntable has been fully rotated. The highest radiation of the equipment has been recorded. For further description of the configuration refer to the pictures of this report.

Distance between equipment and antenna : 3m (30MHz to 18GHz)
: 1m (18GHz to 25GHz)

Spectrum Analyzer Setting

30~1000MHz	Detector : Quasi-Peak Bandwidth : 120kHz
1~25GHz	Detector : Peak and Average Bandwidth : 1MHz

Axial Direction

See Section 15.

Test Instrumentation

Facility/ Equipment	Manufacturer	Model No.	Serial No.	Frequency Range	Calibration Date	Next Calibration Due
10m anechoic chamber	TDK Co.,Ltd	DA-06912	-	-	14 th -18 th .3.2005.	13 th .3.2006.
EMI Test Receiver	R&S	ESCS 30	100148	30-1000MHz	11 th .8.2005.	10 th .8.2006.
Spectrum Analyzer	Agilent Technologies	8563E	3416A02230	30-1000MHz	5 th .4.2005.	4 th .4.2006.
Amplifier		E4446A	US42070181	1-40GHz	14 th .11.2005.	13 th .11.2006.
		8449B	3008A00571	1-26.5GHz	1 st .3.2005.	28 th .2.2006.
		8447D	2944A06812	30-1000MHz	5 th .4.2005.	5 th .4.2006.
RF Selector	TDK Co.,Ltd	NS4900	0302-010	-	6 th .4.2005.	5 th .4.2006.
RF Cable	SUHNER	RG214	RG 1	30-1000MHz	6 th .4.2005.	5 th .4.2006.
		RG214	RG 3	30-1000MHz	6 th .4.2005.	5 th .4.2006.
		RG214	RG 8	30-1000MHz	6 th .4.2005.	5 th .4.2006.
		RG214	RG 5	30-1000MHz	6 th .4.2005.	5 th .4.2006.
		RG214	RG 6	30-1000MHz	6 th .4.2005.	5 th .4.2006.
		SUCOFLEX 106	SU1	1-18GHz	1 st .3.2005.	28 th .2.2006.
	SUCOFLEX 104	SU4	1-18GHz	1 st .3.2005.	28 th .2.2006.	
	HP	85381C	No.3	18-25GHz	28 th .6.2005.	27 th .6.2006.
85381C		No.5	18-25GHz	28 th .6.2005.	27 th .6.2006.	
Attenuator	KYORITSU	KPD-602	220142	30-1000MHz	6 th .4.2005.	5 th .4.2006.
Antenna	Schwarzbeck	BBA9106	No.4	30-300MHz	1 st .3.2005.	28 th .2.2006.
		UHALP9108-A	160	300-1000MHz	1 st .3.2005.	28 th .2.2006.
	EMCO	3115	9403-4232	1-18GHz	1 st .4.2005.	31 st .3.2007.
		3116	9311-2227	18-40GHz	1 st .4.2005.	31 st .3.2007.
Software	TOYO Corporation	EP5/RE Ver.2.0	0208086	-	-	-

6.2 Radiated Emission Calculation

The field strength is calculated by adding the Antenna Factor and Cable Loss, and subtracting the Amplifier Gain (if any) from the measured reading. The basic equation with a sample calculation is as follows:

$$\begin{aligned} \text{c.f.} &= \text{AF} + \text{CF} + \text{AL} - \text{AG} - \text{DF} \\ \text{RE} &= \text{RA} + \text{c.f.} \end{aligned}$$

Where

- c.f. = Correction Factor (dB/m)
- RE = Radiated Emission (Emission Level - Result) (dBuV/m)
- RA = Receiver Amplitude (Reading Level) (dBuV)
- AF = Antenna Factor (dB/m)
- CF = Cable Attenuation Loss (dB)
- AG = Amplifier Gain (dB)
- AL = Attenuator Loss (dB)
- DF = Distance Factor
- Distance between equipment and antenna:3m = 0(dB)
- Distance between equipment and antenna:1m = 9.5(dB)

Assume a receiver reading of 41.3 dB μ V is obtained. The Correction Factor of -1.1 dB/m is added, giving a Radiated Emission of 40.2 dB μ V/m. The 40.2 dB μ V/m value was mathematically converted to its corresponding level in μ V/m.

$$\text{RE} = 41.3 + (-1.1) = 40.2 \text{ dB } \mu \text{ V/m}$$

$$\text{Level in } \mu \text{ V/m} = \text{Common Antilogarithm} : 10^{(40.2/20)} = 102.3 \mu \text{ V/m}$$

6.3 Test Results

Radiated emission was measured in all test modes; GFSK Modulation, $\pi/4$ DQPSK Modulation, 8DPSK Modulation.
The results show the worst case.

6.3.1 Transmitting mode

Spurious Emission (Radiated) 2402MHz

Serial No. : 31
Power : DC 3.3V
Mode : Transmitting mode (GFSK Modulation)
Temperature : 20°C
Humidity : 33 %

Axial Direction : XY-Plane

Frequency [MHz]	Antenna Polarization	Meter Reading [dB(μ V)]		Factor [dB/m]	Emission Level [dB(μ V/m)]		Limits [dB(μ V/m)]	Margin [dB]	
		Average	Peak		Average	Peak		Average	Peak
1601.975	Horizontal	-	59.4	-12.3	-	47.1	74.0	-	26.9
		57.1	-		44.8	-	54.0	9.2	-
2380.850	Horizontal	-	46.3	-8.1	-	38.2	74.0	-	35.8
		39.4	-		31.3	-	54.0	22.7	-
3000.000	Horizontal	-	47.9	-6.0	-	41.9	74.0	-	32.1
		34.2	-		28.2	-	54.0	25.8	-
3204.125	Horizontal	-	50.1	-4.6	-	45.5	74.0	-	28.5
		42.3	-		37.7	-	54.0	16.3	-
4803.725	Horizontal	-	56.7	-0.5	-	56.2	74.0	-	17.8
		49.4	-		48.9	-	54.0	5.1	-
4803.892	Vertical	-	55.8	-0.5	-	55.3	74.0	-	18.7
		48.6	-		48.1	-	54.0	5.9	-
7203.800	Horizontal	-	44.6	3.5	-	48.1	74.0	-	25.9
		32.5	-		36.0	-	54.0	18.0	-

Axial Direction : YZ-Plane

Frequency [MHz]	Antenna Polarization	Meter Reading [dB(μ V)]		Factor [dB/m]	Emission Level [dB(μ V/m)]		Limits [dB(μ V/m)]	Margin [dB]	
		Average	Peak		Average	Peak		Average	Peak
1063.430	Vertical	-	56.3	-13.7	-	42.6	74.0	-	31.4
		41.5	-		27.8	-		54.0	26.2
1601.792	Horizontal	-	56.7	-12.3	-	44.4	74.0	-	29.6
		53.8	-		41.5	-		54.0	12.5
2356.670	Horizontal	-	48.9	-8.2	-	40.7	74.0	-	33.3
		35.2	-		27.0	-		54.0	27.0
3204.208	Vertical	-	46.8	-4.6	-	42.2	74.0	-	31.8
		34.1	-		29.5	-		54.0	24.9
4804.067	Vertical	-	54.2	-0.5	-	53.7	74.0	-	20.3
		47.4	-		46.9	-		54.0	7.1
4804.192	Horizontal	-	53.9	-0.5	-	53.4	74.0	-	20.6
		47.0	-		46.5	-		54.0	7.5
7203.800	Horizontal	-	44.6	3.5	-	48.1	74.0	-	25.9
		32.5	-		36.0	-		54.0	18.0

Axial Direction : ZX-Plane

Frequency [MHz]	Antenna Polarization	Meter Reading [dB(μ V)]		Factor [dB/m]	Emission Level [dB(μ V/m)]		Limits [dB(μ V/m)]	Margin [dB]	
		Average	Peak		Average	Peak		Average	Peak
1065.530	Horizontal	-	53.4	-13.6	-	39.8	74.0	-	34.2
		40.0	-		26.4	-		54.0	27.6
1601.917	Horizontal	-	63.5	-12.3	-	51.2	74.0	-	22.8
		62.0	-		49.7	-		54.0	4.3
1601.984	Vertical	-	60.1	-12.3	-	47.8	74.0	-	26.2
		57.8	-		45.5	-		54.0	8.5
2386.250	Vertical	-	50.0	-8.1	-	41.9	74.0	-	32.1
		40.7	-		32.6	-		54.0	21.4
3204.230	Vertical	-	48.2	-4.6	-	43.6	74.0	-	30.4
		37.2	-		32.6	-		54.0	21.4
4804.150	Horizontal	-	55.6	-0.5	-	55.1	74.0	-	18.9
		48.4	-		47.9	-		54.0	6.1
7203.800	Horizontal	-	44.6	3.5	-	48.1	74.0	-	25.9
		32.5	-		36.0	-		54.0	18.0

Spurious Emission (Radiated) 2441MHz

Serial No. : 31
 Power : DC 3.3V
 Mode : Transmitting mode (GFSK Modulation)
 Temperature : 20°C
 Humidity : 33 %

Axial Direction : XY-Plane

Frequency [MHz]	Antenna Polarization	Meter Reading [dB(μV)]		Factor [dB/m]	Emission Level [dB(μV/m)]		Limits [dB(μV/m)]	Margin [dB]	
		Average	Peak		Average	Peak		Average	Peak
1065.800	Vertical	-	56.7	-13.6	-	43.1	74.0	-	31.0
		41.0	-		27.4	-		54.0	26.6
1627.984	Horizontal	-	58.4	-12.2	-	46.2	74.0	-	27.8
		55.7	-		43.5	-		54.0	10.5
2484.500	Vertical	-	49.5	-7.8	-	41.7	74.0	-	32.3
		36.5	-		28.7	-		54.0	25.3
3256.683	Horizontal	-	44.6	-4.5	-	40.1	74.0	-	33.9
		35.4	-		30.9	-		54.0	23.1
4881.784	Horizontal	-	55.3	-0.4	-	54.9	74.0	-	19.1
		48.1	-		47.7	-		54.0	6.3
4882.067	Vertical	-	54.5	-0.4	-	54.1	74.0	-	19.9
		47.6	-		47.2	-		54.0	6.8
7323.017	Horizontal	-	45.6	3.6	-	49.2	74.0	-	24.8
		32.6	--		36.2	-		54.0	17.8

Axial Direction : YZ-Plane

Frequency [MHz]	Antenna Polarization	Meter Reading [dB(μ V)]		Factor [dB/m]	Emission Level [dB(μ V/m)]		Limits [dB(μ V/m)]	Margin [dB]	
		Average	Peak		Average	Peak		Average	Peak
1065.520	Vertical	-	55.2	-13.6	-	41.6	74.0	-	32.4
		40.1	-		26.5	-		54.0	27.5
1628.100	Horizontal	-	60.5	-12.2	-	48.3	74.0	-	25.7
		58.3	-		46.1	-		54.0	7.9
1627.983	Vertical	-	57.2	-12.2	-	45.0	74.0	-	29.0
		53.4	-		41.2	-		54.0	12.8
2484.500	Vertical	-	49.5	-7.8	-	41.7	74.0	-	32.3
		36.5	-		28.7	-		54.0	25.3
3307.958	Horizontal	-	49.5	-4.5	-	45.0	74.0	-	29.0
		38.2	-		33.7	-		54.0	20.3
4881.658	Vertical	-	53.7	-0.4	-	53.3	74.0	-	20.7
		46.2	-		45.8	-		54.0	8.2
7323.017	Horizontal	-	45.6	3.6	-	49.2	74.0	-	24.8
		32.6	--		36.2	-		54.0	17.8

Axial Direction : ZX-Plane

Frequency [MHz]	Antenna Polarization	Meter Reading [dB(μ V)]		Factor [dB/m]	Emission Level [dB(μ V/m)]		Limits [dB(μ V/m)]	Margin [dB]	
		Average	Peak		Average	Peak		Average	Peak
1065.270	Vertical	-	54.6	-13.6	-	41.0	74.0	-	33.0
		40.3	-		26.7	-		54.0	27.3
1628.008	Horizontal	-	61.3	-12.2	-	49.1	74.0	-	24.9
		59.3	-		47.1	-		54.0	6.9
2484.500	Vertical	-	49.5	-7.8	-	41.7	74.0	-	32.3
		36.5	-		28.7	-		54.0	25.3
3307.958	Horizontal	-	49.5	-4.5	-	45.0	74.0	-	29.0
		38.2	-		33.7	-		54.0	20.3
4881.608	Vertical	-	55.2	-0.4	-	54.8	74.0	-	19.2
		48.1	-		47.7	-		54.0	6.3
4882.242	Horizontal	-	54.7	-0.4	-	54.3	74.0	-	19.7
		47.8	-		47.4	-		54.0	6.6
7323.017	Horizontal	-	45.6	3.6	-	49.2	74.0	-	24.8
		32.6	--		36.2	-		54.0	17.8

Spurious Emission (Radiated) 2480MHz

Serial No. : 31
 Power : DC 3.3V
 Mode : Transmitting mode (GFSK Modulation)
 Temperature : 20°C
 Humidity : 33 %

Axial Direction : XY-Plane

Frequency [MHz]	Antenna Polarization	Meter Reading [dB(μV)]		Factor [dB/m]	Emission Level [dB(μV/m)]		Limits [dB(μV/m)]	Margin [dB]	
		Average	Peak		Average	Peak		Average	Peak
1654.009	Horizontal	-	60.0	-12.1	-	47.9	74.0	-	26.1
		57.5	-		45.4	-		54.0	8.6
2483.540	Horizontal	-	56.6	-7.8	-	48.8	74.0	-	25.2
		45.7	-		37.9	-		54.0	16.1
3000.000	Horizontal	-	47.9	-6.0	-	41.9	74.0	-	32.1
		34.2	-		28.2	-		54.0	25.8
3307.853	Horizontal	-	49.0	-4.5	-	44.5	74.0	-	29.5
		36.7	-		32.2	-		54.0	21.8
4959.858	Horizontal	-	53.1	-0.4	-	53.1	74.0	-	21.3
		45.8	-		45.8	-		54.0	8.6
4959.942	Vertical	-	52.9	-0.4	-	52.5	74.0	-	21.5
		46.9	-		46.5	-		54.0	7.5
7441.650	Horizontal	-	44.7	3.6	-	48.3	74.0	-	25.7
		33.2	-		36.8	-		54.0	17.2

Axial Direction : YZ-Plane

Frequency [MHz]	Antenna Polarization	Meter Reading [dB(μ V)]		Factor [dB/m]	Emission Level [dB(μ V/m)]		Limits [dB(μ V/m)]	Margin [dB]	
		Average	Peak		Average	Peak		Average	Peak
1065.770	Vertical	-	58.0	-13.6	-	44.4	74.0	-	29.6
		42.6	-		29.0	-		54.0	25.0
1654.108	Horizontal	-	60.3	-12.1	-	48.2	74.0	-	25.8
		58.5	-		46.4	-		54.0	7.6
2483.510	Horizontal	-	64.2	-7.8	-	56.4	74.0	-	17.7
		52.6	-		44.8	-		54.0	9.2
3256.683	Horizontal	-	44.6	-4.5	-	40.1	74.0	-	33.9
		35.4	-		30.9	-		54.0	23.1
4959.850	Vertical	-	54.1	-0.4	-	53.7	74.0	-	20.3
		47.2	-		46.8	-		54.0	7.2
7441.650	Horizontal	-	44.7	3.6	-	48.3	74.0	-	25.7
		33.2	-		36.8	-		54.0	17.2

Axial Direction : ZX-Plane

Frequency [MHz]	Antenna Polarization	Meter Reading [dB(μ V)]		Factor [dB/m]	Emission Level [dB(μ V/m)]		Limits [dB(μ V/m)]	Margin [dB]	
		Average	Peak		Average	Peak		Average	Peak
1065.750	Horizontal	-	54.6	-13.6	-	41.0	74.0	-	33.0
		40.2	-		26.6	-		54.0	27.4
1653.875	Horizontal	-	60.2	-12.1	-	48.1	74.0	-	25.9
		58.4	-		46.3	-		54.0	7.7
2483.580	Vertical	-	64.3	-7.8	-	56.5	74.0	-	17.5
		52.6	-		44.8	-		54.0	9.2
3307.958	Horizontal	-	49.5	-4.5	-	45.0	74.0	-	29.0
		38.2	-		33.7	-		54.0	20.3
4959.550	Horizontal	-	53.4	-0.4	-	53.0	74.0	-	21.0
		46.0	-		45.6	-		54.0	8.4
4959.608	Vertical	-	57.7	-0.4	-	57.3	74.0	-	16.7
		50.2	-		49.8	-		54.0	4.2
7441.650	Horizontal	-	44.7	3.6	-	48.3	74.0	-	25.7
		33.2	-		36.8	-		54.0	17.2

6.3.2 Receiving mode

Spurious Emission (Radiated) 2402MHz

Serial No. : 31
 Power : DC 3.3V
 Mode : Receiving mode
 Temperature : 20°C
 Humidity : 33 %

Axial Direction : XY-Plane

Frequency [MHz]	Antenna Polarization	Meter Reading [dB(μV)]		Factor [dB/m]	Emission Level [dB(μV/m)]		Limits [dB(μV/m)]	Margin [dB]	
		Average	Peak		Average	Peak		Average	Peak
1064.330	Vertical	-	51.4	-13.7	-	37.7	74.0	-	36.3
		38.7	-		25.0	-	54.0	29.0	-
1600.397	Horizontal	-	62.0	-12.3	-	49.7	74.0	-	24.3
		60.2	-		47.9	-	54.0	6.1	-
2484.500	Vertical	-	49.5	-7.8	-	41.7	74.0	-	32.3
		36.5	-		28.7	-	54.0	25.3	-
3204.070	Horizontal	-	46.2	-4.6	-	41.6	74.0	-	32.4
		34.5	-		29.9	-	54.0	24.1	-
4803.280	Horizontal	-	41.9	-0.5	-	41.4	74.0	-	32.6
		32.7	-		32.2	-	54.0	21.8	-
7203.800	Horizontal	-	44.6	3.5	-	48.1	74.0	-	25.9
		32.5	-		36.0	-	54.0	18.0	-

Axial Direction : YZ-Plane

Frequency [MHz]	Antenna Polarization	Meter Reading [dB(μ V)]		Factor [dB/m]	Emission Level [dB(μ V/m)]		Limits [dB(μ V/m)]	Margin [dB]	
		Average	Peak		Average	Peak		Average	Peak
1063.030	Vertical	-	52.0	-13.7	-	38.3	74.0	-	35.7
		38.7	-		25.0	-		29.0	-
1600.275	Horizontal	-	63.1	-12.3	-	50.8	74.0	-	23.2
		61.4	-		49.1	-		4.9	-
2484.500	Vertical	-	49.5	-7.8	-	41.7	74.0	-	32.3
		36.5	-		28.7	-		25.3	-
3204.070	Horizontal	-	46.2	-4.6	-	41.6	74.0	-	32.4
		34.5	-		29.9	-		24.1	-
4803.280	Horizontal	-	41.9	-0.5	-	41.4	74.0	-	32.6
		32.7	-		32.2	-		21.8	-
7203.800	Horizontal	-	44.6	3.5	-	48.1	74.0	-	25.9
		32.5	-		36.0	-		18.0	-

Axial Direction : ZX-Plane

Frequency [MHz]	Antenna Polarization	Meter Reading [dB(μ V)]		Factor [dB/m]	Emission Level [dB(μ V/m)]		Limits [dB(μ V/m)]	Margin [dB]	
		Average	Peak		Average	Peak		Average	Peak
1064.800	Vertical	-	52.8	-13.7	-	39.1	74.0	-	34.9
		39.3	-		25.6	-		28.4	-
1600.275	Horizontal	-	63.3	-12.3	-	51.0	74.0	-	23.0
		62.0	-		49.7	-		4.3	-
1600.471	Vertical	-	59.4	-12.3	-	47.1	74.0	-	26.9
		56.6	-		44.3	-		9.7	-
2484.500	Vertical	-	49.5	-7.8	-	41.7	74.0	-	32.3
		36.5	-		28.7	-		25.3	-
3204.070	Horizontal	-	46.2	-4.6	-	41.6	74.0	-	32.4
		34.5	-		29.9	-		24.1	-
4803.280	Horizontal	-	41.9	-0.5	-	41.4	74.0	-	32.6
		32.7	-		32.2	-		21.8	-
7203.800	Horizontal	-	44.6	3.5	-	48.1	74.0	-	25.9
		32.5	-		36.0	-		18.0	-

Spurious Emission (Radiated) 2441MHz

Serial No. : 31
 Power : DC 3.3V
 Mode : Receiving mode
 Temperature : 20°C
 Humidity : 33 %

Axial Direction : XY-Plane

Frequency [MHz]	Antenna Polarization	Meter Reading [dB(μV)]		Factor [dB/m]	Emission Level [dB(μV/m)]		Limits [dB(μV/m)]	Margin [dB]	
		Average	Peak		Average	Peak		Average	Peak
1063.450	Vertical	-	53.4	-13.7	-	39.7	74.0	-	34.3
		39.3	-		25.6	-		28.4	-
1626.359	Horizontal	-	59.1	-12.2	-	46.9	74.0	-	27.1
		56.3	-		44.1	-		9.9	-
2484.500	Vertical	-	49.5	-7.8	-	41.7	74.0	-	32.3
		36.5	-		28.7	-		25.3	-
3255.925	Horizontal	-	44.9	-4.5	-	40.4	74.0	-	33.6
		34.0	-		29.5	-		24.5	-
4882.890	Vertical	-	43.8	-0.4	-	43.4	74.0	-	30.6
		32.2	-		31.8	-		22.2	-
7323.017	Horizontal	-	45.6	3.6	-	49.2	74.0	-	24.8
		32.6	--		36.2	-		17.8	-

Axial Direction : YZ-Plane

Frequency [MHz]	Antenna Polarization	Meter Reading [dB(μ V)]		Factor [dB/m]	Emission Level [dB(μ V/m)]		Limits [dB(μ V/m)]	Margin [dB]	
		Average	Peak		Average	Peak		Average	Peak
1062.670	Vertical	-	53.8	-13.7	-	40.1	74.0	-	33.9
		40.3	-		26.6	-		27.4	-
1626.316	Horizontal	-	59.5	-12.2	-	47.3	74.0	-	26.7
		56.7	-		44.5	-		9.5	-
2484.500	Vertical	-	49.5	-7.8	-	41.7	74.0	-	32.3
		36.5	-		28.7	-		25.3	-
3255.925	Horizontal	-	44.9	-4.5	-	40.4	74.0	-	33.6
		34.0	-		29.5	-		24.5	-
4882.890	Vertical	-	43.8	-0.4	-	43.4	74.0	-	30.6
		32.2	-		31.8	-		22.2	-
7323.017	Horizontal	-	45.6	3.6	-	49.2	74.0	-	24.8
		32.6	--		36.2	-		17.8	-

Axial Direction : ZX-Plane

Frequency [MHz]	Antenna Polarization	Meter Reading [dB(μ V)]		Factor [dB/m]	Emission Level [dB(μ V/m)]		Limits [dB(μ V/m)]	Margin [dB]	
		Average	Peak		Average	Peak		Average	Peak
1064.070	Vertical	-	56.0	-13.7	-	42.3	74.0	-	31.7
		40.7	-		27.0	-		27.0	-
1626.325	Horizontal	-	62.4	-12.2	-	50.2	74.0	-	23.8
		60.6	-		48.4	-		5.6	-
2484.500	Vertical	-	49.5	-7.8	-	41.7	74.0	-	32.3
		36.5	-		28.7	-		25.3	-
3255.925	Horizontal	-	44.9	-4.5	-	40.4	74.0	-	33.6
		34.0	-		29.5	-		24.5	-
4882.890	Vertical	-	43.8	-0.4	-	43.4	74.0	-	30.6
		32.2	-		31.8	-		22.2	-
7323.017	Horizontal	-	45.6	3.6	-	49.2	74.0	-	24.8
		32.6	--		36.2	-		17.8	-

Spurious Emission (Radiated) 2480MHz

Serial No. : 31
 Power : DC 3.3V
 Mode : Receiving mode
 Temperature : 20°C
 Humidity : 33 %

Axial Direction : XY-Plane

Frequency [MHz]	Antenna Polarization	Meter Reading [dB(μV)]		Factor [dB/m]	Emission Level [dB(μV/m)]		Limits [dB(μV/m)]	Margin [dB]	
		Average	Peak		Average	Peak		Average	Peak
1065.930	Vertical	-	57.3	-13.6	-	43.7	74.0	-	30.3
		41.2	-		27.6	-		26.4	-
1652.363	Horizontal	-	59.1	-12.1	-	47.0	74.0	-	27.0
		56.6	-		44.5	-		9.5	-
2484.500	Vertical	-	49.5	-7.8	-	41.7	74.0	-	32.3
		36.5	-		28.7	-		25.3	-
3308.058	Horizontal	-	45.2	-4.5	-	40.7	74.0	-	33.3
		34.4	-		29.9	-		24.1	-
4958.983	Horizontal	-	43.2	-0.4	-	42.8	74.0	-	31.2
		32.4	-		32.0	-		22.0	-
7441.650	Horizontal	-	44.7	3.6	-	48.3	74.0	-	25.7
		33.2	-		36.8	-		17.2	-

Axial Direction : YZ-Plane

Frequency [MHz]	Antenna Polarization	Meter Reading [dB(μ V)]		Factor [dB/m]	Emission Level [dB(μ V/m)]		Limits [dB(μ V/m)]	Margin [dB]	
		Average	Peak		Average	Peak		Average	Peak
1063.530	Vertical	-	54.1	-13.7	-	40.4	74.0	-	33.6
		40.0	-		26.3	-		27.7	-
1652.258	Horizontal	-	60.2	-12.1	-	48.1	74.0	-	25.9
		57.9	-		45.8	-		8.2	-
2484.500	Vertical	-	49.5	-7.8	-	41.7	74.0	-	32.3
		36.5	-		28.7	-		25.3	-
3308.058	Horizontal	-	45.2	-4.5	-	40.7	74.0	-	33.3
		34.4	-		29.9	-		24.1	-
4958.983	Horizontal	-	43.2	-0.4	-	42.8	74.0	-	31.2
		32.4	-		32.0	-		22.0	-
7441.650	Horizontal	-	44.7	3.6	-	48.3	74.0	-	25.7
		33.2	-		36.8	-		17.2	-

Axial Direction : ZX-Plane

Frequency [MHz]	Antenna Polarization	Meter Reading [dB(μ V)]		Factor [dB/m]	Emission Level [dB(μ V/m)]		Limits [dB(μ V/m)]	Margin [dB]	
		Average	Peak		Average	Peak		Average	Peak
1061.170	Vertical	-	58.1	-13.7	-	44.4	74.0	-	29.6
		42.3	-		28.6	-		54.0	25.4
1652.425	Horizontal	-	59.6	-12.1	-	47.5	74.0	-	26.5
		57.4	-		45.3	-		54.0	8.7
2484.500	Vertical	-	49.5	-7.8	-	41.7	74.0	-	32.3
		36.5	-		28.7	-		54.0	25.3
3308.058	Horizontal	-	45.2	-4.5	-	40.7	74.0	-	40.7
		34.4	-		29.9	-		54.0	29.9
4958.983	Horizontal	-	43.2	-0.4	-	42.8	74.0	-	31.2
		32.4	-		32.0	-		54.0	22.0
7441.650	Horizontal	-	44.7	3.6	-	48.3	74.0	-	25.7
		33.2	-		36.8	-		54.0	17.2

7 20dB Bandwidth

7.1 Test Setup

The spectrum analyzer was connected to the transmitter output port through the RF cable.

Spectrum analyzer setting :-
 DETECTOR MODE : PEAK
 RBW : 30kHz
 VBW : 30kHz
 SPAN : 2MHz
 SWEEP TIME : AUTO

7.2 Test Instrument

Equipment	Manufacture	Model No.	Serial No.	Calibration Date	Next Calibration Due
Spectrum Analyzer	Agilent Technologies	E4446A	US42070181	14 th .11.2005.	13 th .11.2006.
RF cable	SUHNER	SUCOFLEX 104E	RF2	5 th .7.2005.	4 th .7.2006.

7.3 Test Results

Serial No. : 31
 Power : DC 3.3V
 Mode : Transmitting mode , Non Frequency Hopping
 Temperature : 20 °C
 Humidity : 45 %

- (1) Operation mode: Transmitting mode (GFSK Modulation)

CH	Frequency [MHz]	20dB Bandwidth [MHz]
0ch(Lowest)	2402.0	0.870
39ch(Middle)	2441.0	0.873
78ch(Highest)	2480.0	0.867

- (2) Operation mode: Transmitting mode ($\pi/4$ DQPSK Modulation)

CH	Frequency [MHz]	20dB Bandwidth [MHz]
0ch(Lowest)	2402.0	1.230
39ch(Middle)	2441.0	1.227
78ch(Highest)	2480.0	1.230

- (3) Operation mode: Transmitting mode (8DPSK Modulation)

CH	Frequency [MHz]	20dB Bandwidth [MHz]
0ch(Lowest)	2402.0	1.260
39ch(Middle)	2441.0	1.263
78ch(Highest)	2480.0	1.260

8 Carrier Frequency Separation

8.1 Test Setup

The spectrum analyzer was connected to the transmitter output port through the RF cable.

Spectrum Analyzer setting : -
 DETECTOR MODE :PEAK
 RBW : 100kHz
 VBW : 300kHz
 SPAN : 3MHz
 SWEEP TIME : AUTO

8.2 Test Instrument

Equipment	Manufacture	Model No.	Serial No.	Calibration Date	Next Calibration Due
Spectrum Analyzer	Agilent Technologies	E4446A	US42070181	14 th .11.2005.	13 th .11.2006.
RF cable	SUHNER	SUCOFLEX 104E	RF2	5 th .7.2005.	4 th .7.2006.

8.3 Test Results

Serial No. : 31
 Power : DC 3.3V
 Mode : Transmitting mode , Frequency Hopping
 Transmitting mode , Adoptive Frequency Hopping
 Temperature : 20 °C
 Humidity : 45 %
 Regulation : FCC Part15 C §15.247 (a)(1)

- (1) Operation mode: Transmitting mode (GFSK Modulation)
 Transmitting mode , Frequency Hopping (79ch)

Channel	Channel Separation [MHz]	Limit *1 [MHz]
Low frequency (0ch-1ch)	0.835	> 0.580
Middle frequency (38ch-39ch)	1.040	> 0.582
High frequency (77ch-78ch)	0.915	> 0.578

Transmitting mode , Adoptive Frequency Hopping (20ch)

Channel	Channel Separation [MHz]	Limit *1 [MHz]
Low frequency (0ch-1ch)	0.845	> 0.580
Middle frequency (38ch-39ch)	1.025	> 0.582
High frequency (77ch-78ch)	1.040	> 0.578

- (2) Operation mode: Transmitting mode ($\pi/4$ DQPSK Modulation)
Transmitting mode , Frequency Hopping (79ch)

Channel	Channel Separation [MHz]	Limit *1 [MHz]
Low frequency (0ch-1ch)	1.000	> 0.820
Middle frequency (38ch-39ch)	1.005	> 0.818
High frequency (77ch-78ch)	1.000	> 0.820

Transmitting mode , Adoptive Frequency Hopping (20ch)

Channel	Channel Separation [MHz]	Limit *1 [MHz]
Low frequency (0ch-1ch)	1.000	> 0.820
Middle frequency (38ch-39ch)	1.000	> 0.818
High frequency (77ch-78ch)	1.000	> 0.820

- (3) Operation mode: Transmitting mode (8DPSK Modulation)
Transmitting mode , Frequency Hopping (79ch)

Channel	Channel Separation [MHz]	Limit *1 [MHz]
Low frequency (0ch-1ch)	1.005	> 0.840
Middle frequency (38ch-39ch)	1.010	> 0.842
High frequency (77ch-78ch)	1.010	> 0.840

Transmitting mode , Adoptive Frequency Hopping (20ch)

Channel	Channel Separation [MHz]	Limit *1 [MHz]
Low frequency (0ch-1ch)	1.000	> 0.840
Middle frequency (38ch-39ch)	1.020	> 0.842
High frequency (77ch-78ch)	1.015	> 0.840

*1 Limit value of Carrier Frequency Separation is 2/3 of 20dB Bandwidth. Refer the result of 20dB Bandwidth to Section 7.

9 Number of Hopping Frequency

9.1 Test Setup

The spectrum analyzer was connected to the transmitter output port through the RF cable.

spectrum analyzer setting : -
 DETECTOR MODE : PEAK
 RBW : 300kHz
 VBW : 300kHz
 SWEEP TIME : AUTO

9.2 Test Instrument

Equipment	Manufacture	Model No.	Serial No.	Calibration Date	Next Calibration Due
Spectrum Analyzer	Agilent Technologies	E4446A	US42070181	14 th .11.2005.	13 th .11.2006.
RF cable	SUHNER	SUCOFLEX 104E	RF2	5 th .7.2005.	4 th .7.2006.

9.3 Test Results

Serial No. : 31
 Power : DC 3.3V
 Mode : Transmitting mode , Frequency Hopping
 Transmitting mode , Adoptive Frequency Hopping
 Temperature : 24 °C
 Humidity : 33 %
 Regulation : FCC Part15 C §15.247 (a)(1)(iii)

(1) Operation mode: Transmitting mode (GFSK Modulation)

Mode	Number of channel [time]	Limit [time]
Transmitting mode Frequency Hopping (79ch)	79	≥ 15
Transmitting mode Adoptive Frequency Hopping (20ch)	20 *A	≥ 15

AFH: Intelligent hopping techniques to avoid interference to other transmission.

*A: None of them is overlapped each other.

(2) Operation mode: Transmitting mode ($\pi/4$ DQPSK Modulation)

Mode	Number of channel [time]	Limit [time]
Transmitting mode Frequency Hopping (79ch)	79	≥ 15
Transmitting mode Adoptive Frequency Hopping (20ch)	20 *A	≥ 15

AFH: Intelligent hopping techniques to avoid interference to other transmission.

*A: None of them is overlapped each other.

(3) Operation mode: Transmitting mode (8DPSK Modulation)

Mode	Number of channel [time]	Limit [time]
Transmitting mode Frequency Hopping (79ch)	79	≥ 15
Transmitting mode Adoptive Frequency Hopping (20ch)	20 *A	≥ 15

AFH: Intelligent hopping techniques to avoid interference to other transmission.

*A: None of them is overlapped each other.

10 Dwell Time

10.1 Test Setup

The spectrum analyzer was connected to the transmitter output port through the RF cable.

Spectrum analyzer setting : -
 DETECTOR MODE : PEAK
 RBW : 1MHz
 VBW : 1MHz
 SPAN : 0Hz
 SWEEP TIME : AUTO

10.2 Test Instrument

Equipment	Manufacture	Model No.	Serial No.	Calibration Date	Next Calibration Due
Spectrum Analyzer	Agilent Technologies	E4446A	US42070181	14 th .11.2005.	13 th .11.2006.
RF cable	SUHNER	SUCOFLEX 104E	RF2	5 th .7.2005.	4 th .7.2006.

10.3 Test Results

Serial No. : 31
 Power : DC 3.3V
 Mode : Transmitting mode (DH1,DH3,DH5), Frequency Hopping
 Transmitting mode (DH1,DH3,DH5), Adoptive Frequency Hopping
 Temperature : 24 °C
 Humidity : 33 %
 Regulation : FCC Part15 C §15.247 (a)(1)(iii)

(1) Operation mode: Transmitting mode, Frequency Hopping (79ch)

(i) GFSK Modulation

Packet	Dwell time [ms]	Limit [ms]
DH1	134.45	400
DH3	269.94	400
DH5	312.34	400

(ii) $\pi/4$ DQPSK Modulation

Packet	Dwell time [ms]	Limit [ms]
DH1	138.93	400
DH3	271.23	400
DH5	312.34	400

(iii) 8DPSK Modulation

Packet	Dwell time [ms]	Limit [ms]
DH1	136.69	400
DH3	272.68	400
DH5	312.34	400

(2) Operation mode: Transmitting mode, Adoptive Frequency Hopping (20ch)

(i) GFSK Modulation

Packet	Dwell time [ms]	Limit [ms]
DH1	134.40	400
DH3	268.00	400
DH5	311.30	400

(ii) $\pi/4$ DQPSK Modulation

Packet	Dwell time [ms]	Limit [ms]
DH1	138.56	400
DH3	269.28	400
DH5	313.01	400

(iii) 8DPSK Modulation

Packet	Dwell time [ms]	Limit [ms]
DH1	138.56	400
DH3	269.28	400
DH5	313.01	400

Data of Dwell Time (Frequency Hopping (79ch))

Time of occupancy (Dwell Time) for packet type DH1.

FH hop rate of Bluetooth system is 1600hops per 1 second.

A DH1 packet needs 1 time slot for transmitting and 1 time slot for receiving.

In a DH1 packet, it hops 800 times for transmitting per 1 second.

The number of hopping channel is 79.

The number of times that appears in 1 channel per 1 second is as follows.

$$800/79=10.13 \text{ (times)}$$

The average time of occupancy on any channel shall not be greater than 0.4 seconds (400ms) within a period of 0.4 seconds multiplied by the number of hopping channels employed $0.4 \times 79 = 31.6$ seconds

The number of times that appears in 1 channel per 31.6 seconds is as follows.

$$10.13 \times 31.6 = 320.11 \text{ (times)}$$

Transmitting time is 0.420ms.

Then, dwell time is $320.11 \times 0.420\text{ms} = 134.45\text{ms}$ per 31.6 seconds.

Time of occupancy (Dwell Time) for packet type DH3.

FH hop rate of Bluetooth system is 1600hops per 1 second.

A DH3 packet needs 3 times slot for transmitting and 1 time slot for receiving.

In a DH3 packet, it hops 400 times for transmitting per 1 second.

The number of hopping channel is 79.

The number of times that appears in 1 channel per 1 second is as follows.

$$400/79=5.1 \text{ (times)}$$

The average time of occupancy on any channel shall not be greater than 0.4 seconds (400ms) within a period of 0.4 seconds multiplied by the number of hopping channels employed $0.4 \times 79 = 31.6$ seconds

The number of times that appears in 1 channel per 31.6 seconds is as follows.

$$5.1 \times 31.6 = 161.16 \text{ (times)}$$

Transmitting time is 1.675ms.

Then, dwell time is $161.16 \times 1.675\text{ms} = 269.94\text{ms}$ per 31.6 seconds.

Time of occupancy (Dwell Time) for packet type DH5.

FH hop rate of Bluetooth system is 1600hops per 1 second.

A DH5 packet needs 5 times slot for transmitting and 1 time slot for receiving.

In a DH5 packet, it hops 266.67 times for transmitting per 1 second.

The number of hopping channel is 79.

The number of times that appears in 1 channel per 1 second is as follows.

$$266.67/79=3.37 \text{ (times)}$$

The average time of occupancy on any channel shall not be greater than 0.4 seconds (400ms) within a period of 0.4 seconds multiplied by the number of hopping channels employed $0.4 \times 79 = 31.6$ seconds

The number of times that appears in 1 channel per 31.6 seconds is as follows.

$$3.37 \times 31.6 = 106.49 \text{ (times)}$$

Transmitting time is 2.933ms.

Then, dwell time is $106.49 \times 2.933\text{ms} = 312.34\text{ms}$ per 31.6 seconds.

Data of Dwell Time (Frequency Hopping (20ch))

Time of occupancy (Dwell Time) for packet type DH1.

FH hop rate of Bluetooth system is 1600hops per 1 second.

A DH1 packet needs 1 time slot for transmitting and 1 time slot for receiving.

In a DH1 packet, it hops 800 times for transmitting per 1 second.

The number of hopping channel is 20.

The number of times that appears in 1 channel per 1 second is as follows.

$$800/20=40 \text{ (times)}$$

The average time of occupancy on any channel shall not be greater than 0.4 seconds (400ms) within a period of 0.4 seconds multiplied by the number of hopping channels employed $0.4 \times 20 = 8.0$ seconds

The number of times that appears in 1 channel per 8.0 seconds is as follows.

$$40 \times 8.0 = 320.00 \text{ (times)}$$

Transmitting time is 0.420ms.

Then, dwell time is $320.00 \times 0.420\text{ms} = 134.40\text{ms}$ per 8.0 seconds.

Time of occupancy (Dwell Time) for packet type DH3.

FH hop rate of Bluetooth system is 1600hops per 1 second.

A DH3 packet needs 3 times slot for transmitting and 1 time slot for receiving.

In a DH3 packet, it hops 400 times for transmitting per 1 second.

The number of hopping channel is 20.

The number of times that appears in 1 channel per 1 second is as follows.

$$400/20=20 \text{ (times)}$$

The average time of occupancy on any channel shall not be greater than 0.4 seconds (400ms) within a period of 0.4 seconds multiplied by the number of hopping channels employed $0.4 \times 20 = 8.0$ seconds

The number of times that appears in 1 channel per 8.0 seconds is as follows.

$$20 \times 8.0 = 160.00 \text{ (times)}$$

Transmitting time is 1.675ms.

Then, dwell time is $160.00 \times 1.675\text{ms} = 268.00\text{ms}$ per 8.0 seconds.

Time of occupancy (Dwell Time) for packet type DH5.

FH hop rate of Bluetooth system is 1600hops per 1 second.

A DH5 packet needs 5 times slot for transmitting and 1 time slot for receiving.

In a DH5 packet, it hops 266.67 times for transmitting per 1 second.

The number of hopping channel is 20.

The number of times that appears in 1 channel per 1 second is as follows.

$$266.67/20=13.34 \text{ (times)}$$

The average time of occupancy on any channel shall not be greater than 0.4 seconds (400ms) within a period of 0.4 seconds multiplied by the number of hopping channels employed $0.4 \times 20 = 8.0$ seconds

The number of times that appears in 1 channel per 8.0 seconds is as follows.

$$13.34 \times 8.0 = 106.72 \text{ (times)}$$

Transmitting time is 2.917ms.

Then, dwell time is $106.72 \times 2.917\text{ms} = 311.30\text{ms}$ per 8.0 seconds.

11 Maximum Peak Output Power

11.1 Test Setup

The spectrum analyzer was connected to the transmitter output port through the RF cable.

spectrum analyzer setting : -
 DETECTOR MODE : PEAK
 RBW : 1MHz
 VBW : 1MHz
 SWEEP TIME : AUTO

11.2 Test Instrument

Equipment	Manufacture	Model No.	Serial No.	Calibration Date	Next Calibration Due
Spectrum Analyzer	Agilent Technologies	E4446A	US42070181	14 th .11.2005.	13 th .11.2006.
RF cable	SUHNER	SUCOFLEX 104E	RF2	5 th .7.2005.	4 th .7.2006.

11.3 Test Results

Serial No. : 31
 Power : DC 3.3V
 Mode : Transmitting mode , Non Frequency Hopping
 Temperature : 24 °C
 Humidity : 33 %
 Regulation : FCC Part15 C §15.247 (b)(1)

(1) Operation mode: Transmitting mode (GFSK Modulation)

CH	Freq. [MHz]	Reading [dBm]	Cable Loss [dB]	Result [dBm]	Limit [dBm]
0ch(Lowest)	2402.0	-1.01	1.15	0.14	30.0
39ch(Middle)	2441.0	-1.00	1.13	0.13	30.0
78ch(Highest)	2480.0	-0.34	1.16	0.82	30.0

Result = Reading + Cable Loss

(2) Operation mode: Transmitting mode ($\pi/4$ DQPSK Modulation)

CH	Freq. [MHz]	Reading [dBm]	Cable Loss [dB]	Result [dBm]	Limit [dBm]
0ch(Lowest)	2402.0	-0.07	1.15	1.08	30.0
39ch(Middle)	2441.0	-0.23	1.13	0.90	30.0
78ch(Highest)	2480.0	-0.41	1.16	0.75	30.0

Result = Reading + Cable Loss

(3) Operation mode: Transmitting mode (8DPSK Modulation)

CH	Freq. [MHz]	Reading [dBm]	Cable Loss [dB]	Result [dBm]	Limit [dBm]
0ch(Lowest)	2402.0	-0.12	1.15	1.03	30.0
39ch(Middle)	2441.0	-0.15	1.13	0.98	30.0
78ch(Highest)	2480.0	-0.30	1.16	0.86	30.0

Result = Reading + Cable Loss

12 Band Edge Compliance

12.1 Test Setup

The spectrum analyzer was connected to the transmitter output port through the RF cable.

Spectrum analyzer setting : -
 DETECTOR MODE : PEAK
 RBW : 100kHz
 VBW : 100kHz
 SWEEP TIME : AUTO

12.2 Test Instrument

Equipment	Manufacture	Model No.	Serial No.	Calibration Date	Next Calibration Due
Spectrum Analyzer	Agilent Technologies	E4446A	US42070181	14 th .11.2005.	13 th .11.2006.
RF cable	SUHNER	SUCOFLEX 104E	RF2	5 th .7.2005.	4 th .7.2006.

12.3 Test Results

Serial No. : 31
 Power : DC 3.3V
 Mode : Transmitting mode , Frequency Hopping (79ch)
 Transmitting mode , Adoptive Frequency Hopping (20ch)
 Transmitting mode , Non Frequency Hopping
 Temperature : 20 °C
 Humidity : 45 %
 Regulation : FCC Part15 C §15.247 (c)

The spectrum data are attached below. Display line indicates the 20dB offset below highest level. It shows compliance with the requirement in part 15.247(c)

(1) Operation mode: Transmitting mode (GFSK Modulation)

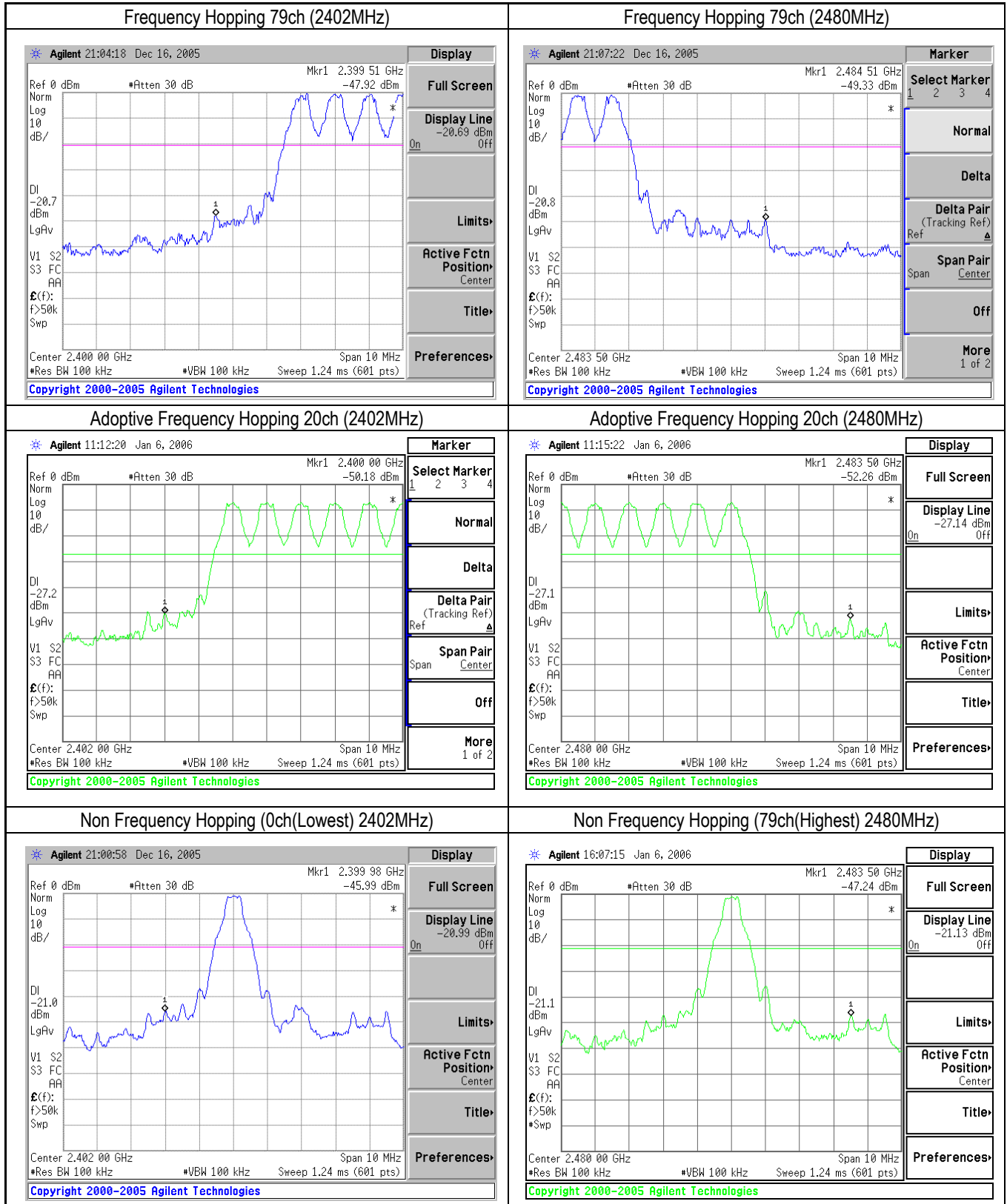

(2) Operation mode: Transmitting mode ($\pi/4$ DQPSK Modulation)

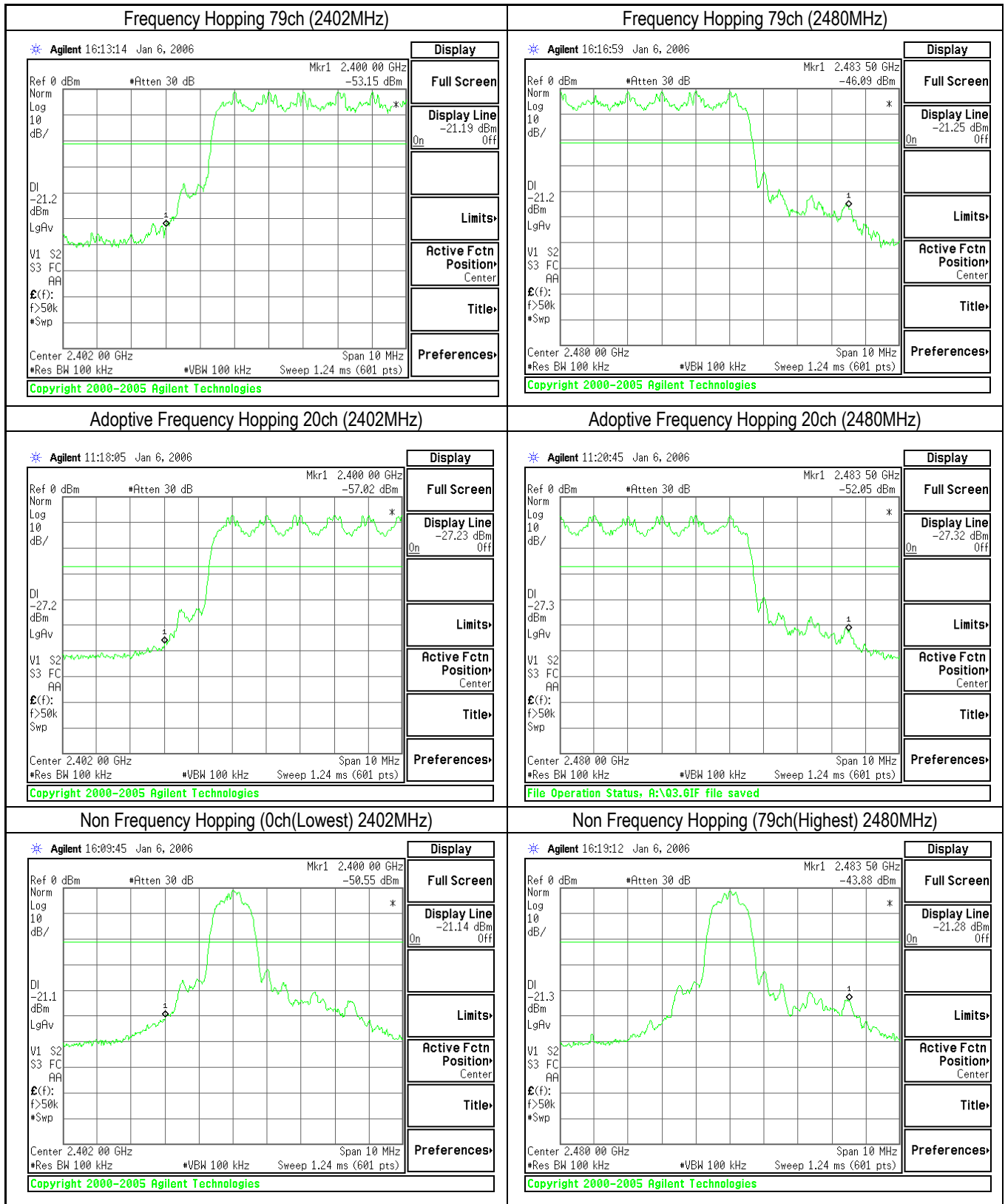

(3) Operation mode: Transmitting mode (8DPSK Modulation)

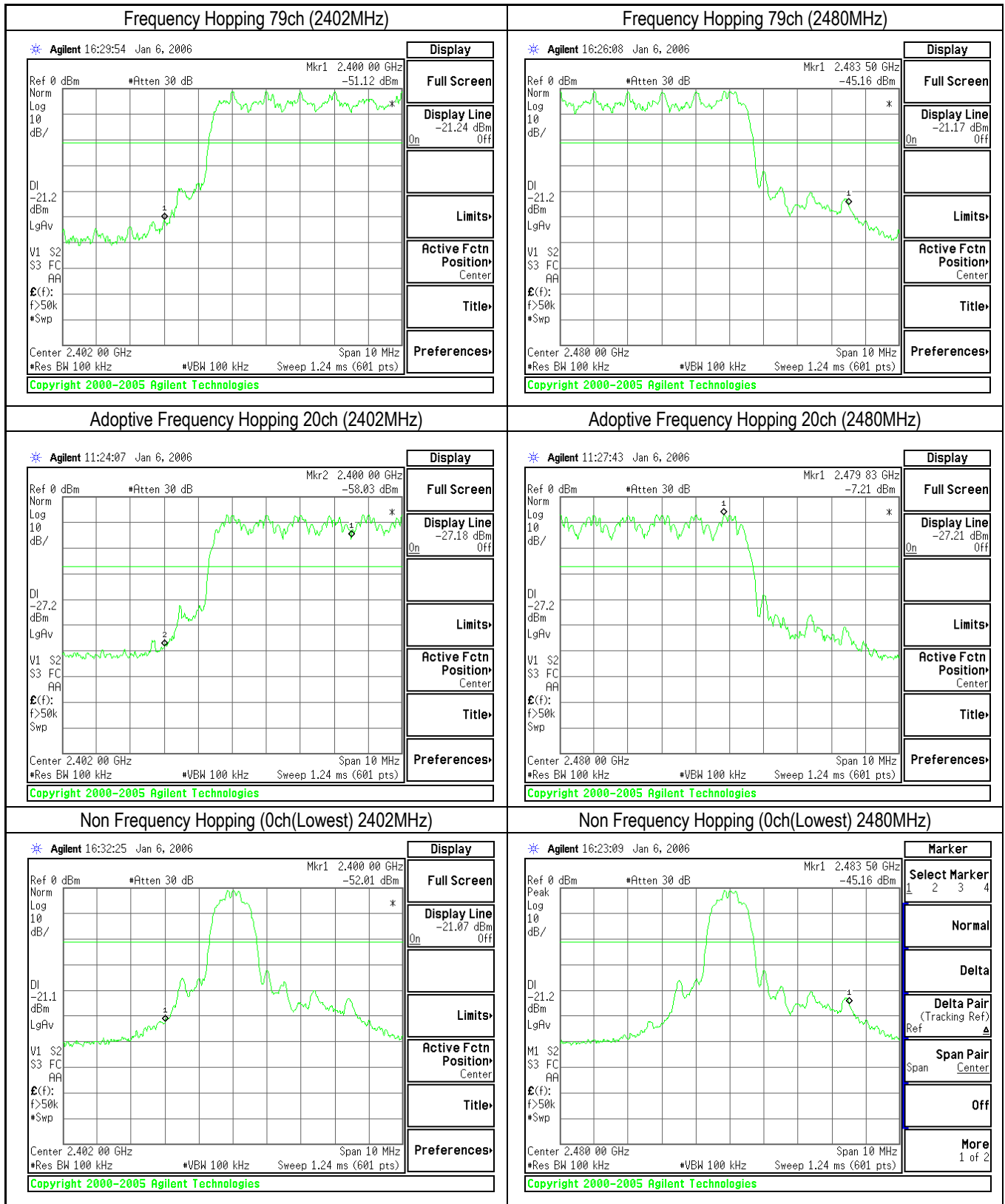

13 Spurious RF Conducted Emission

13.1 Test Setup

The spectrum analyzer was connected to the transmitter output port through the RF cable.

spectrum analyzer setting :-
DETECTOR : PEAK
RBW : 100kHz
VBW : 100kHz
SWEEP TIME : AUTO

13.2 Test Instrument

Equipment	Manufacture	Model No.	Serial No.	Calibration Date	Next Calibration Due
Spectrum Analyzer	Agilent Technologies	E4446A	US42070181	14 th .11.2005.	13 th .11.2006.
RF cable	SUHNER	SUCOFLEX 104E	RF2	5 th .7.2005.	4 th .7.2006.

13.3 Test Results

Serial No. : 31
Power : DC 3.3V
Mode : Transmitting mode , Non Frequency Hopping
Temperature : 24 °C
Humidity : 33 %
Regulation : FCC Part15 C §15.247 (c)

The spectrum data are attached below. Display line indicates the 20dB offset below highest level.
It shows compliance with the requirement in part 15.247(c)

Non Frequency Hopping

(1) Operation mode: Transmitting mode (GFSK Modulation)

0ch(Lowest) 2402MHz

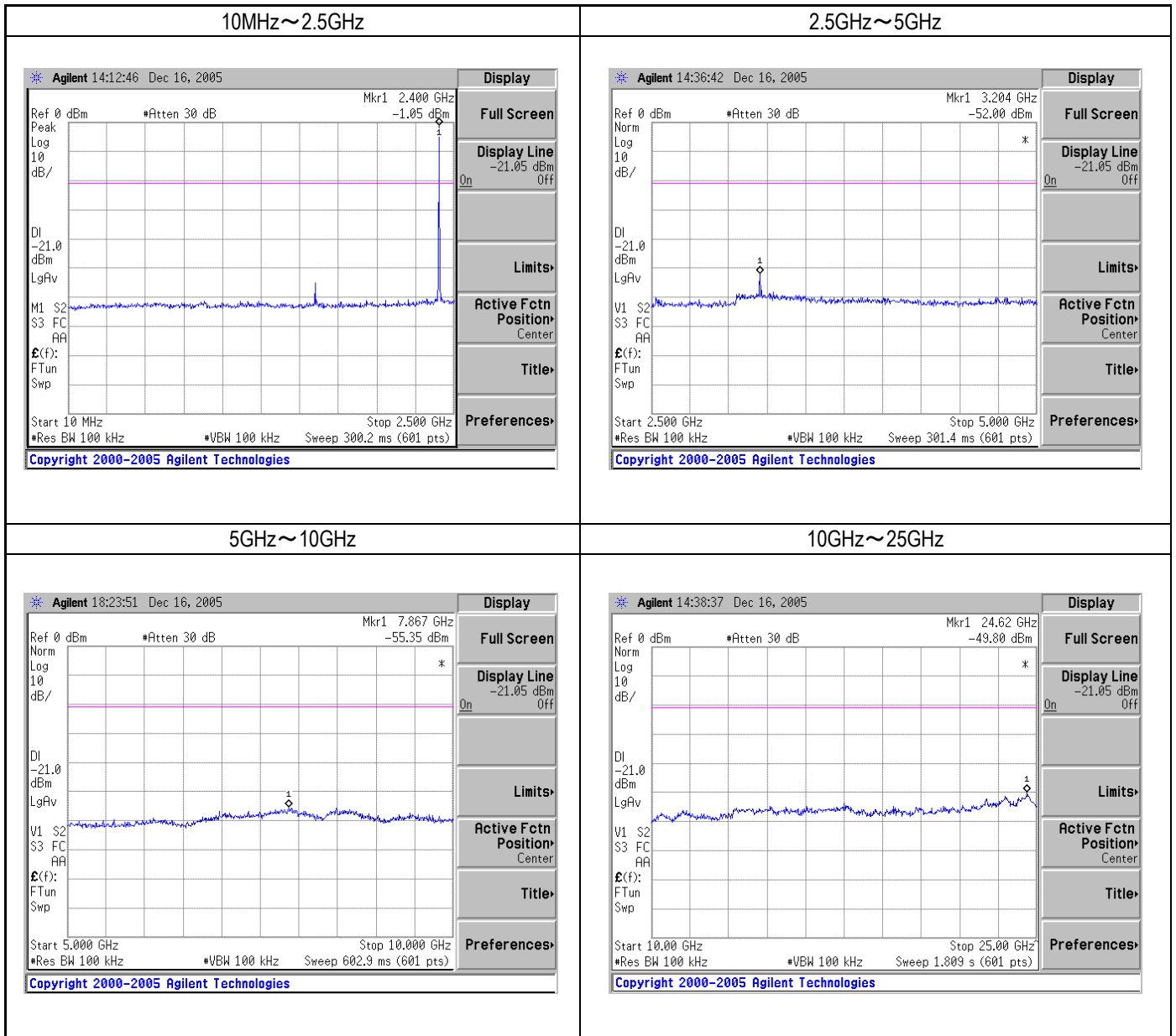

39ch(Middle) 2441MHz

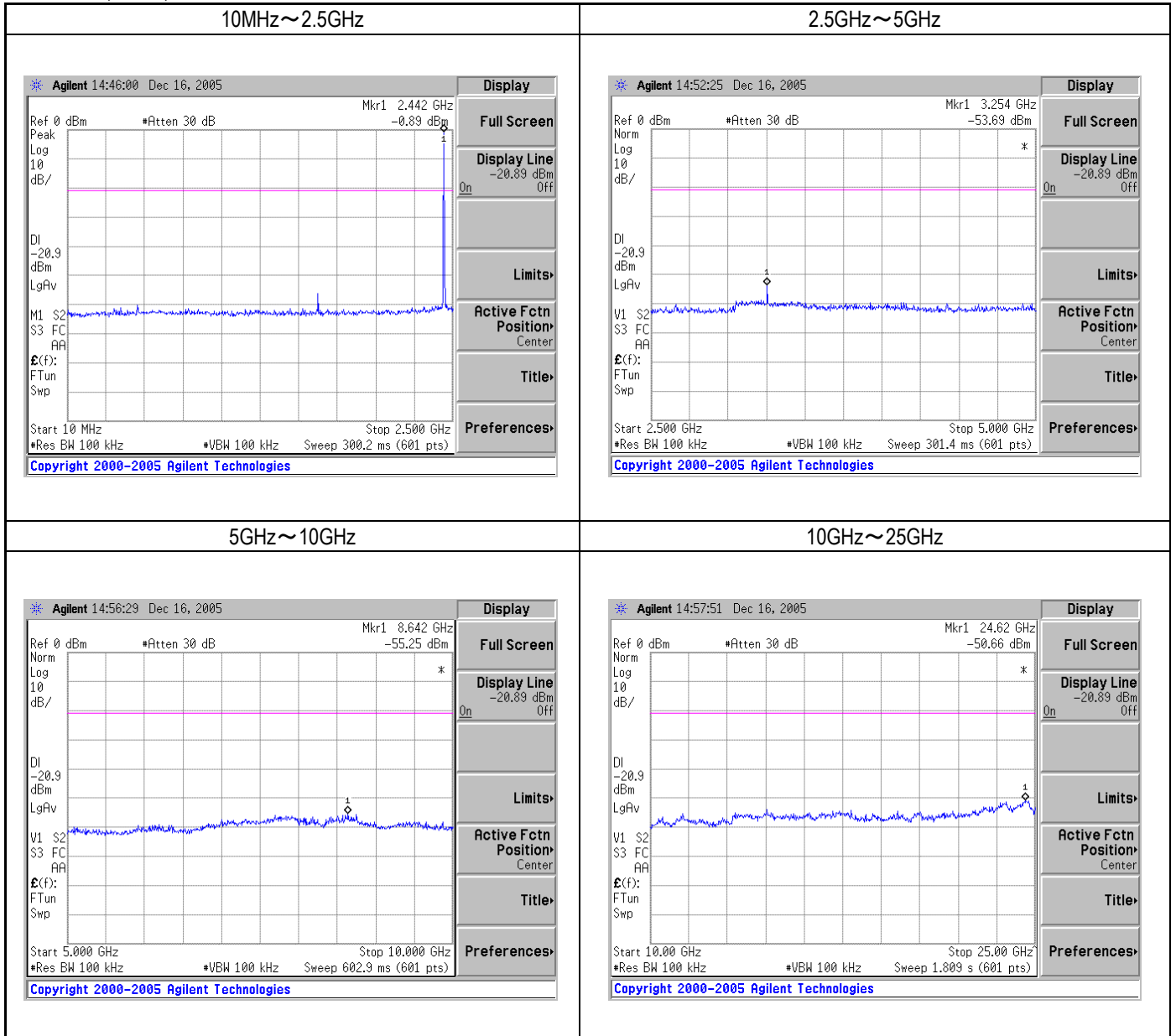

78ch(Highest) 2480MHz

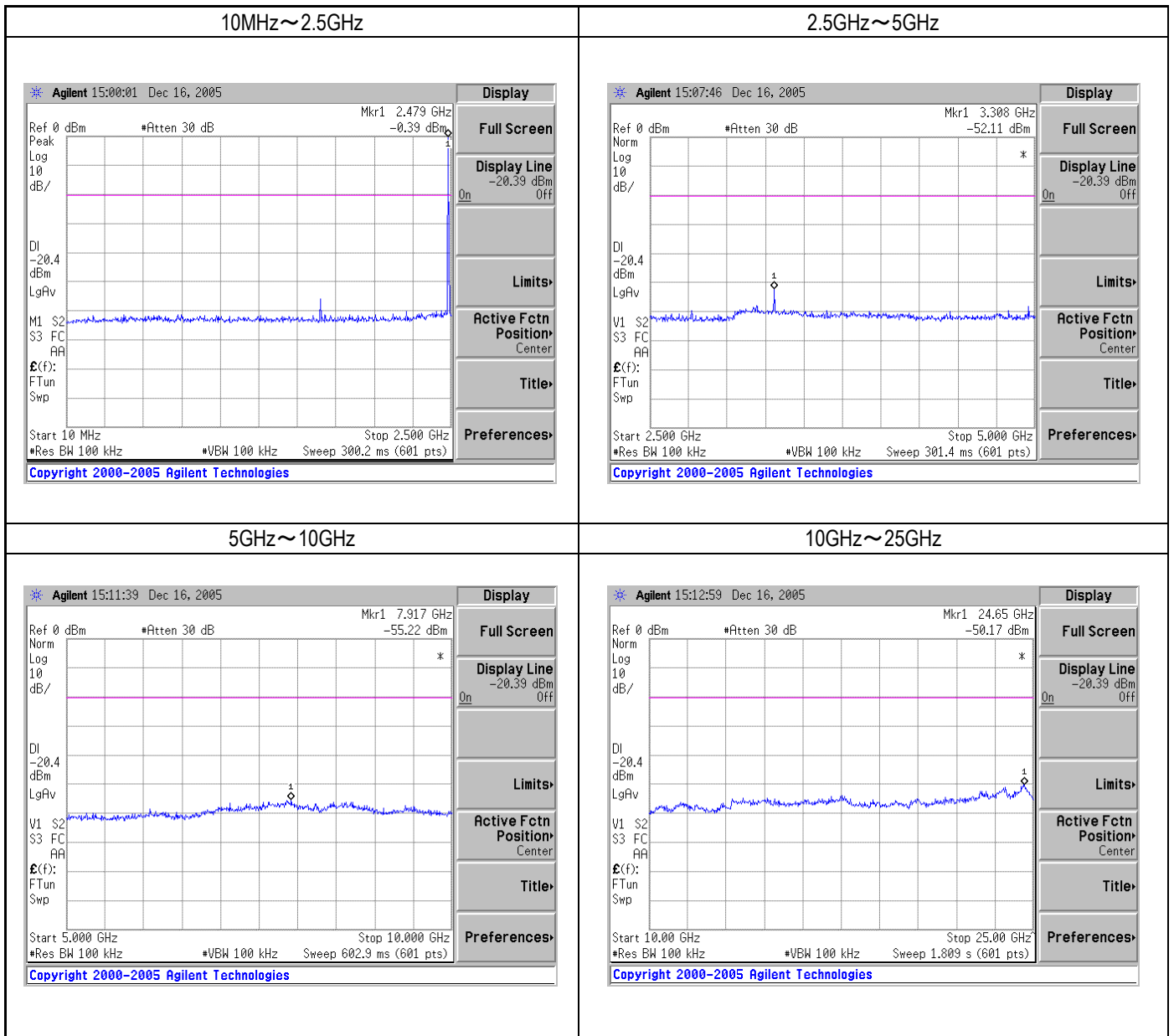

The spectrum data are attached below. Display line indicates the 20dB offset below highest level.
It shows compliance with the requirement in part 15.247(c)

Non Frequency Hopping

(2) Operation mode: Transmitting mode ($\pi/4$ DQPSK modulation)

0ch(Lowest) 2402MHz

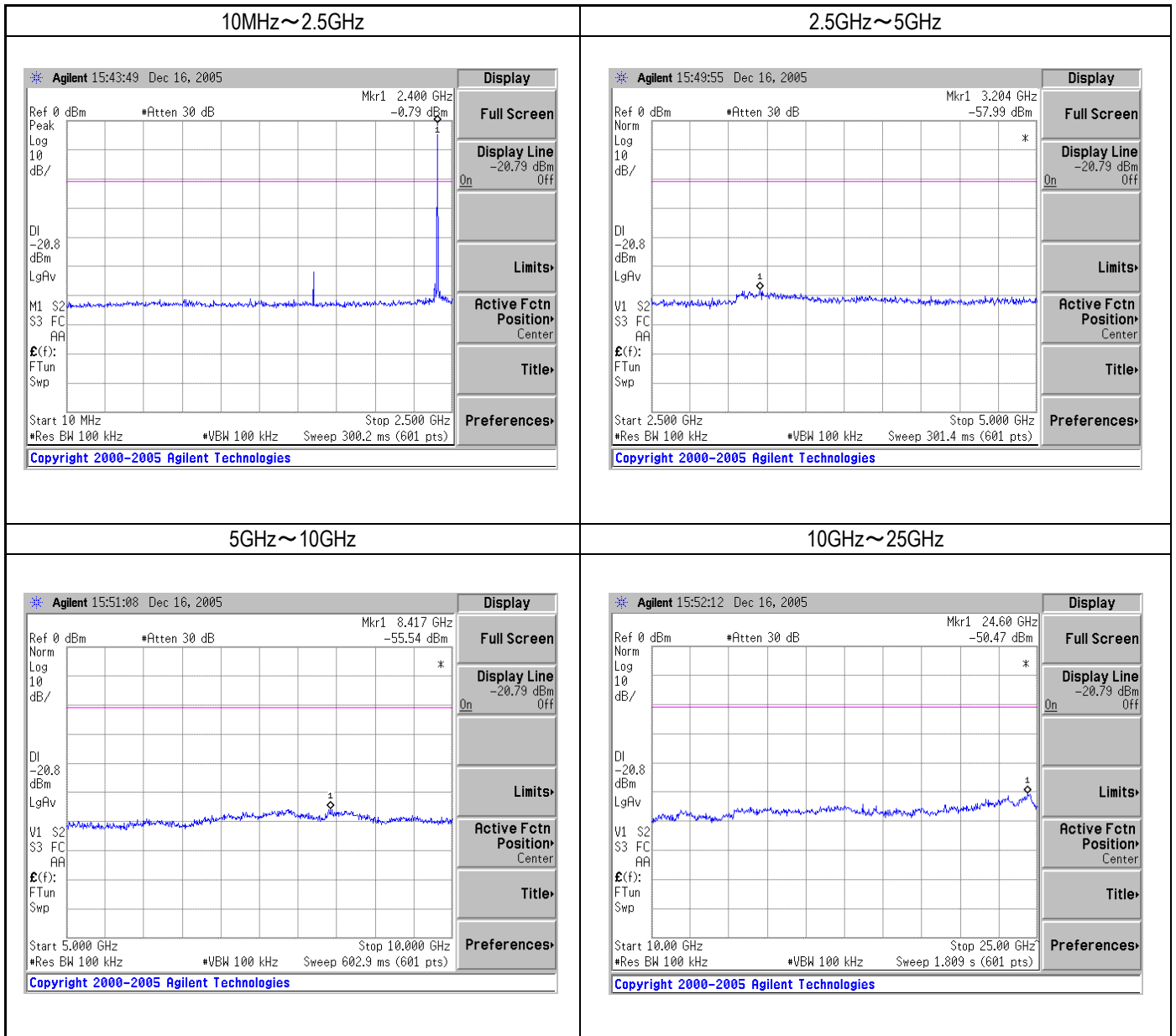

39ch(Middle) 2441MHz

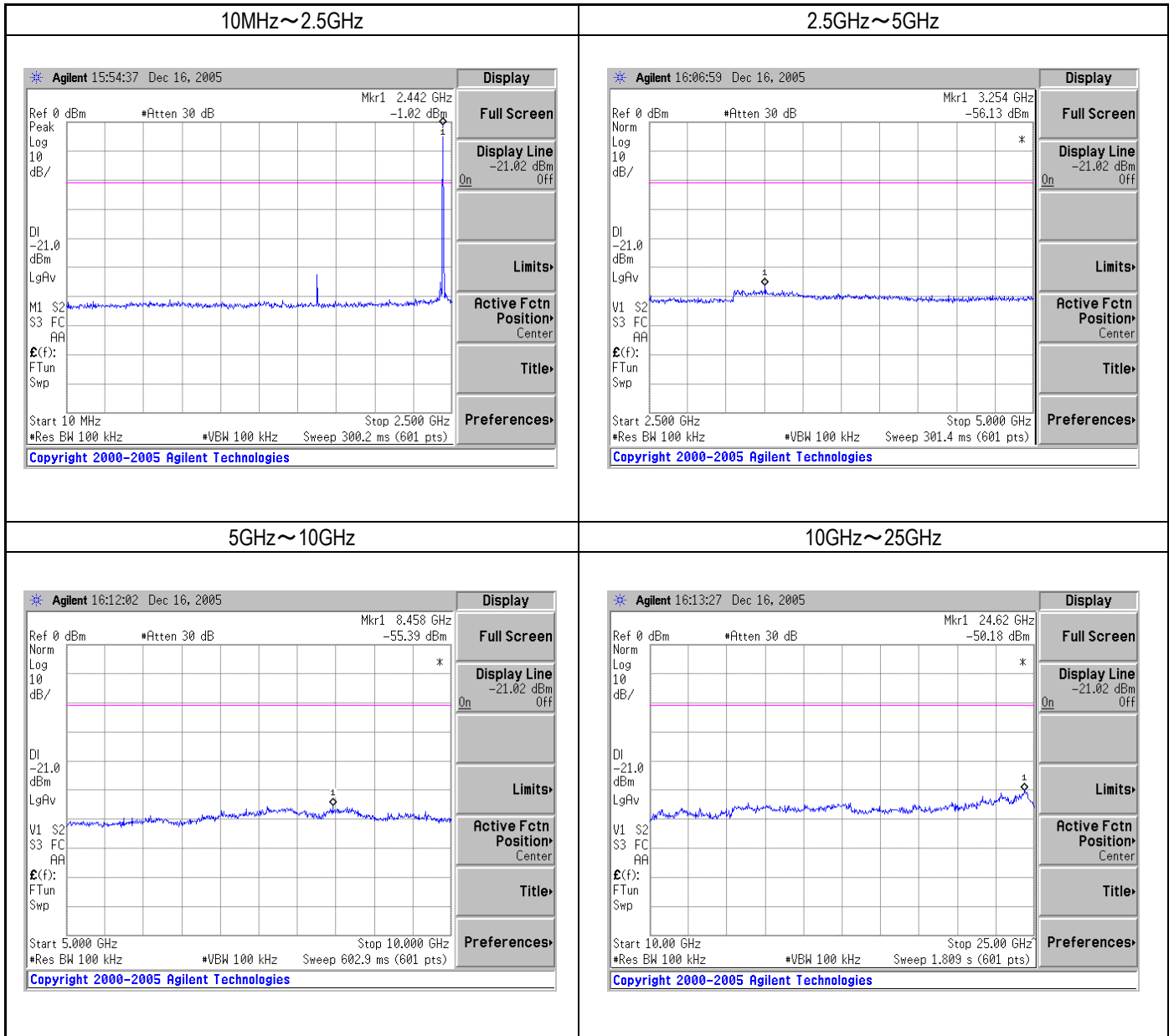

78ch(Highest) 2480MHz

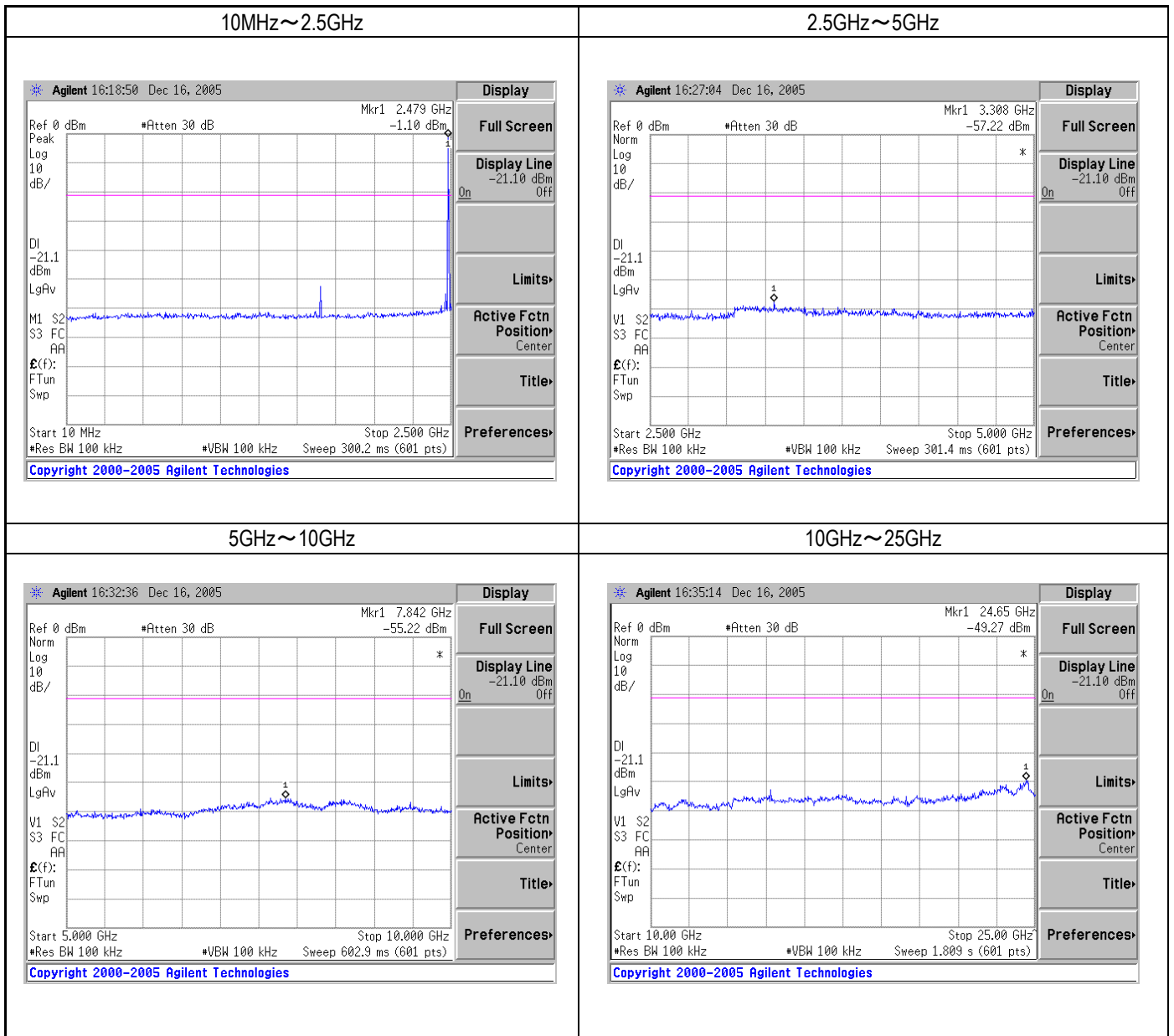

The spectrum data are attached below. Display line indicates the 20dB offset below highest level.
It shows compliance with the requirement in part 15.247(c)

Non Frequency Hopping

(3) Operation mode: Transmitting mode (8DPSK modulation)

0ch(Lowest) 2402MHz

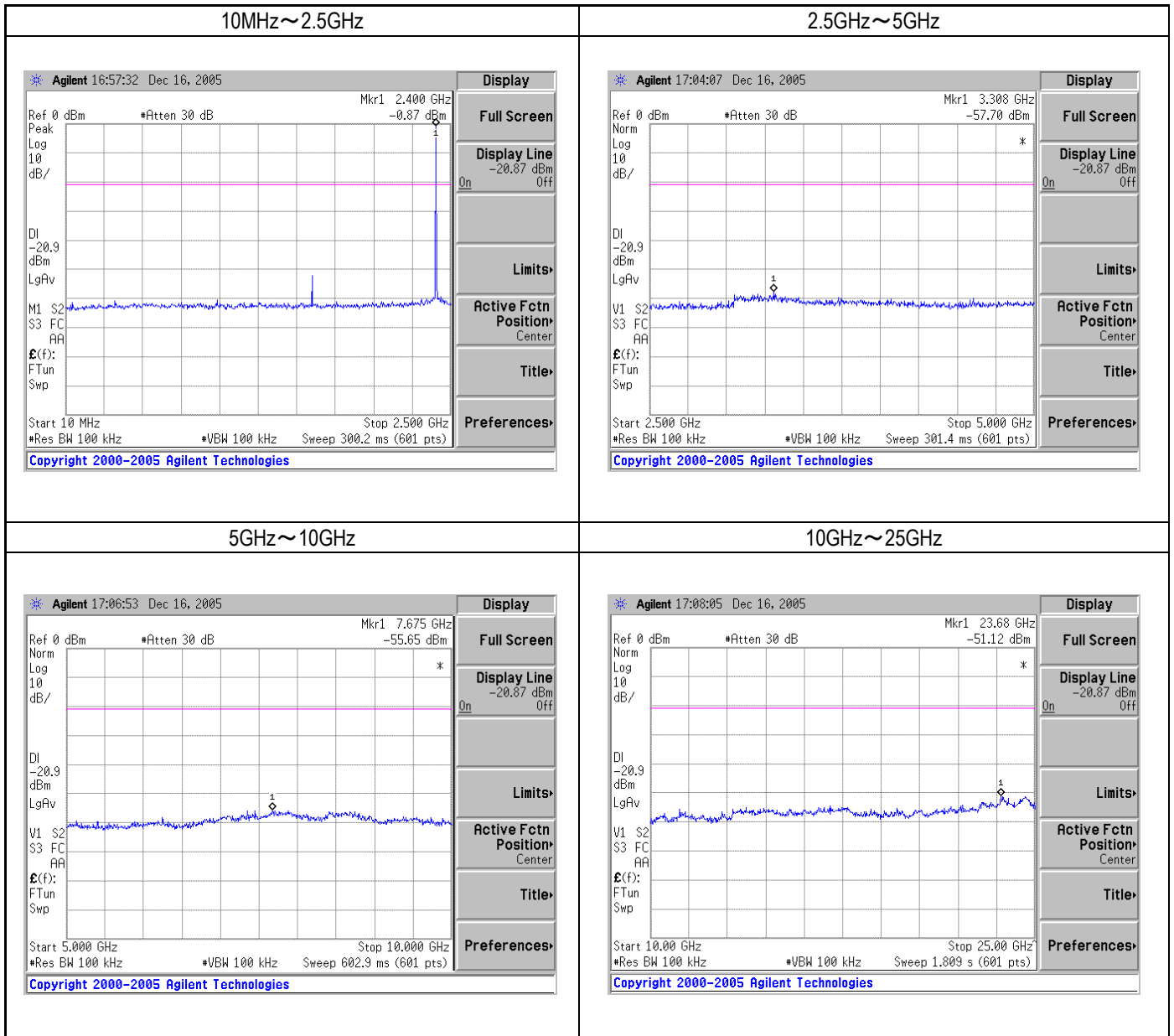

39ch(Middle) 2441MHz

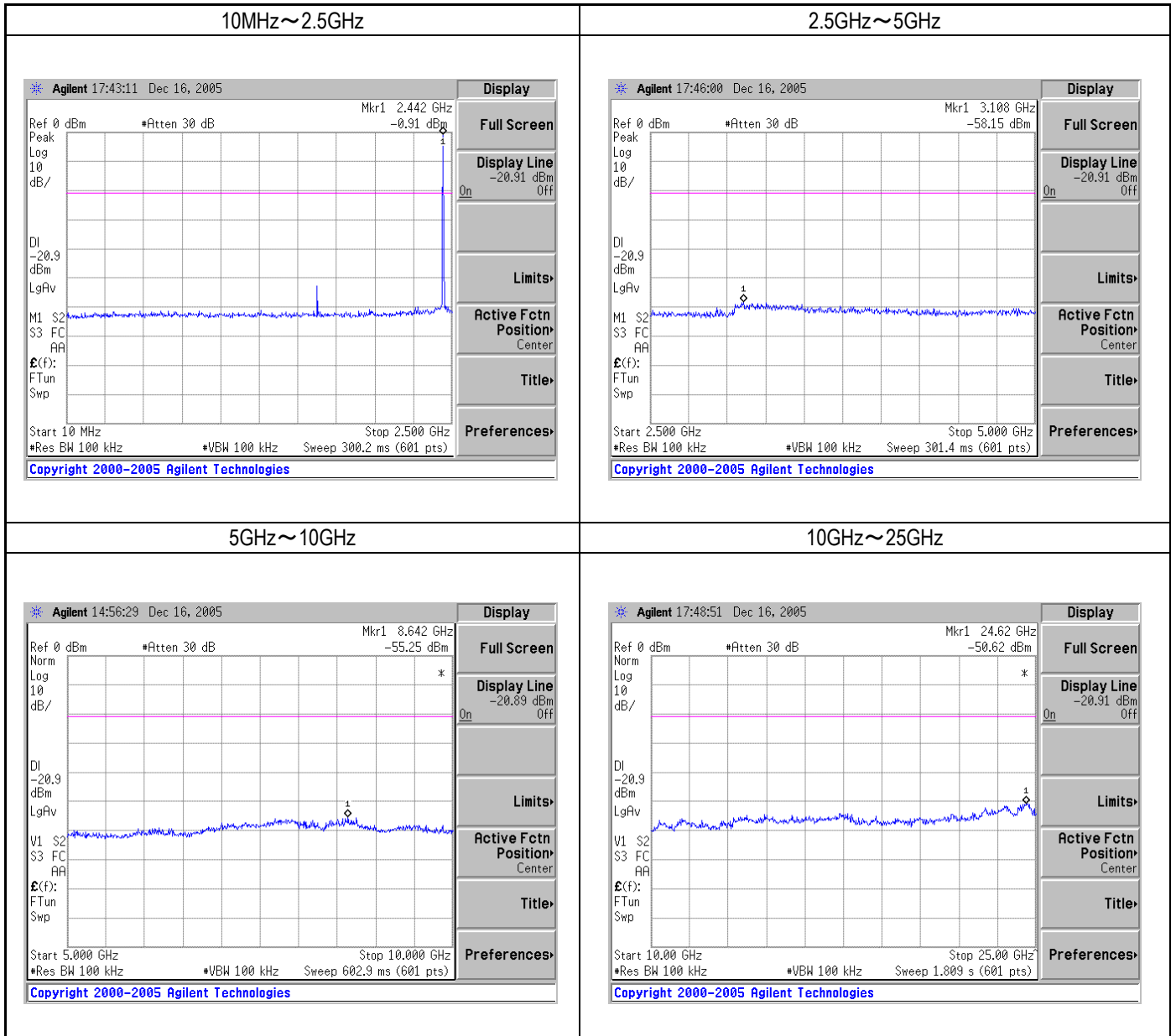

78ch(Highest) 2480MHz

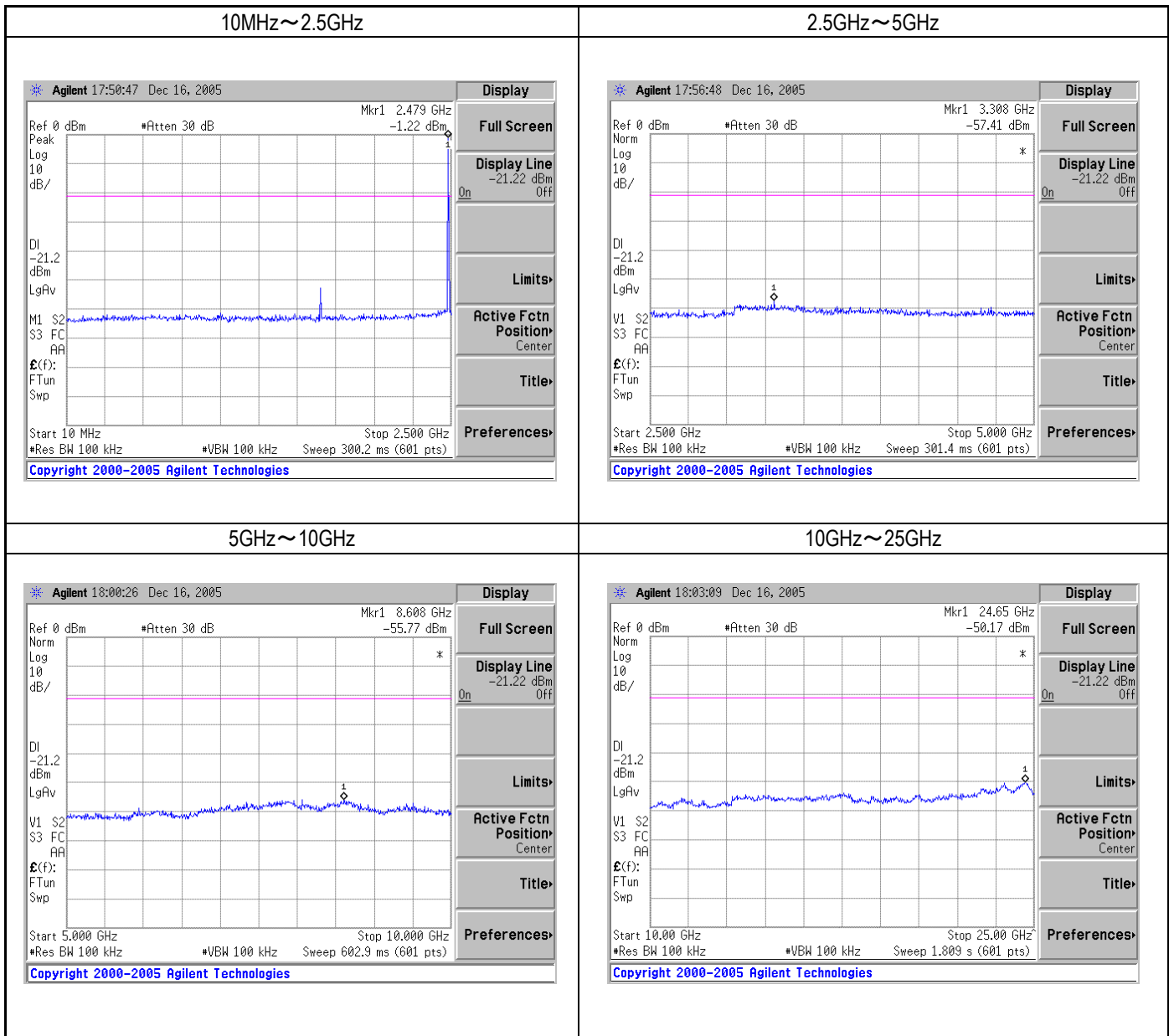

14 EIRP Calculation from Peak Power

15.247 (b)(5): Systems operating under the provisions of this section shall be operated in a manner that ensures that the public is not exposed to radio frequency energy levels in excess of the Commission's guidelines.

EIRP Calculation :

A	B	C
Specified Antenna Gain (dBi)	Max. RF Output Power at Antenna Terminal (dBm)	Total EIRP (dBm)
3.27	1.08	4.35

Calculation : $C = A + B$

EIRP = 4.35dBm = 2.72mW

15 PHOTOS OF TESTED EUT

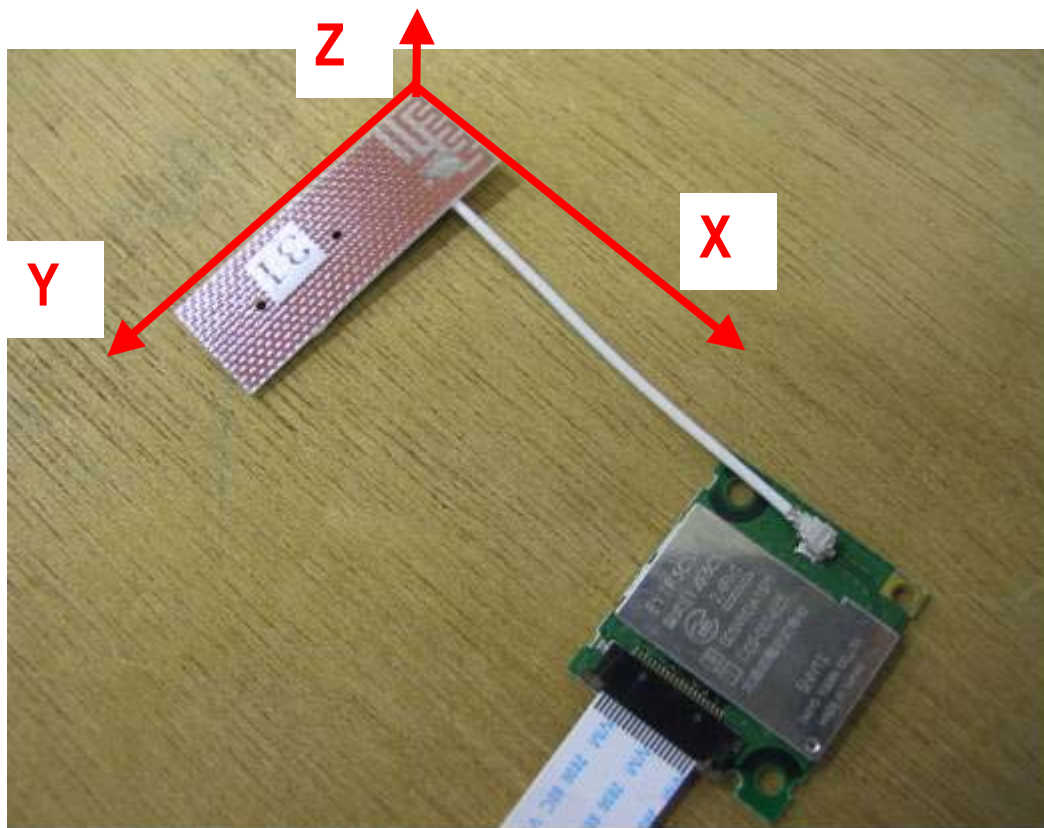
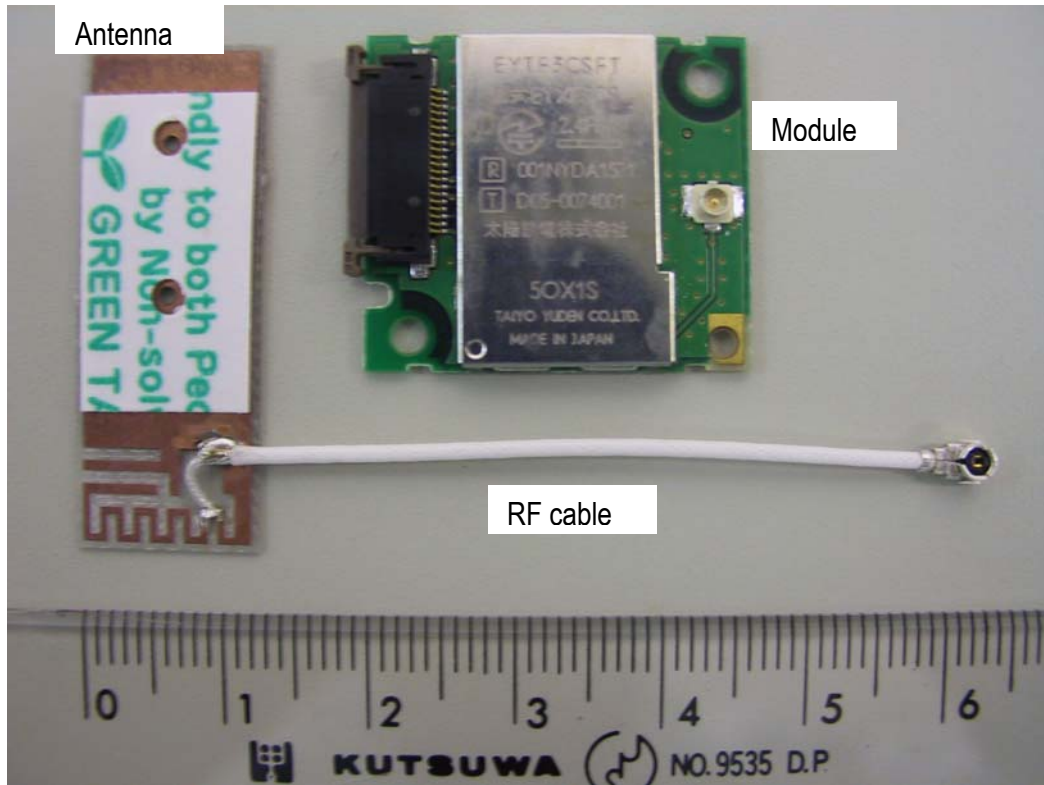

16 PHOTOS OF TEST SETUP

16.1 Photos of Radiated Measurement

Axial Direction : XY-Plane

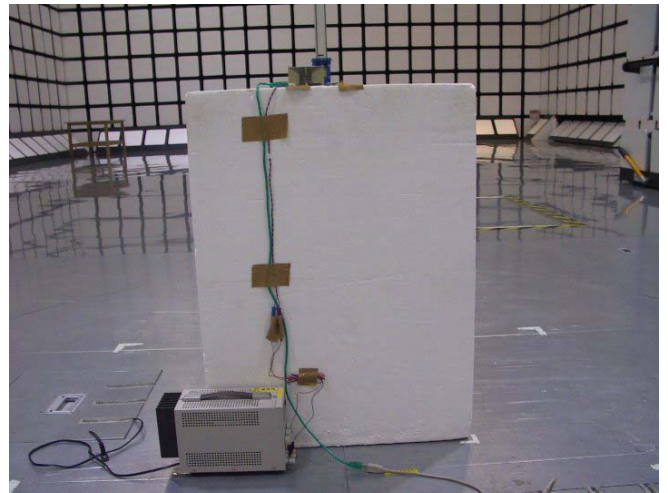
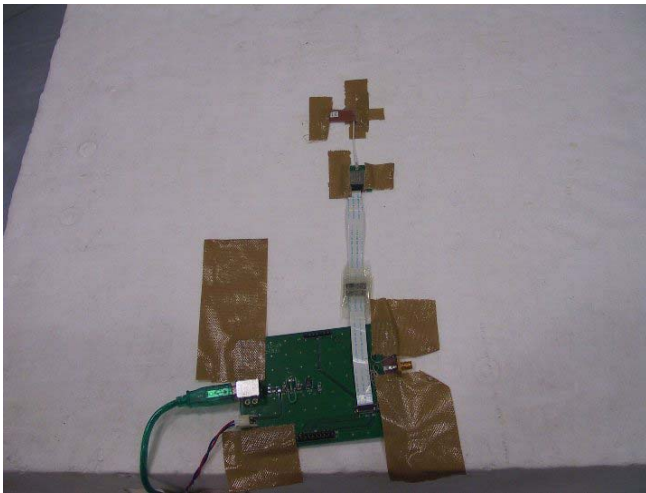

Axial Direction : YZ-Plane

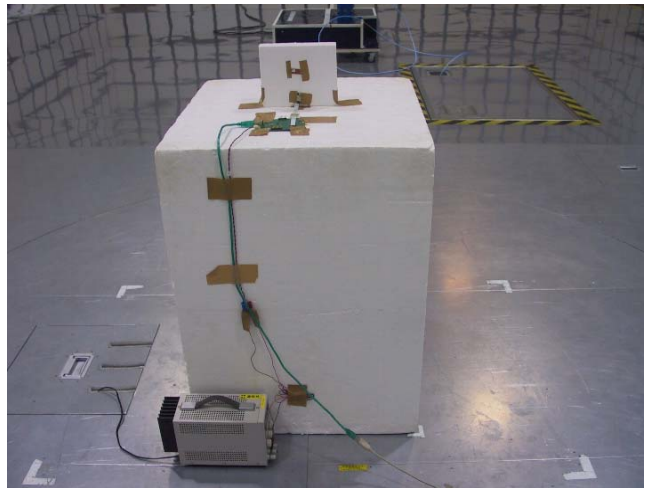
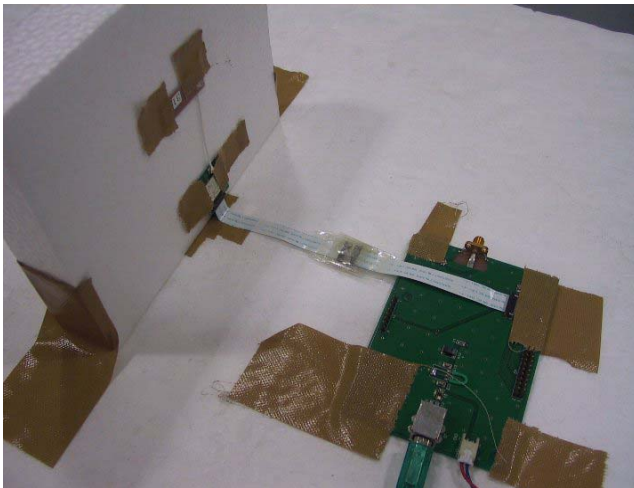

Axial Direction : ZX-Plane

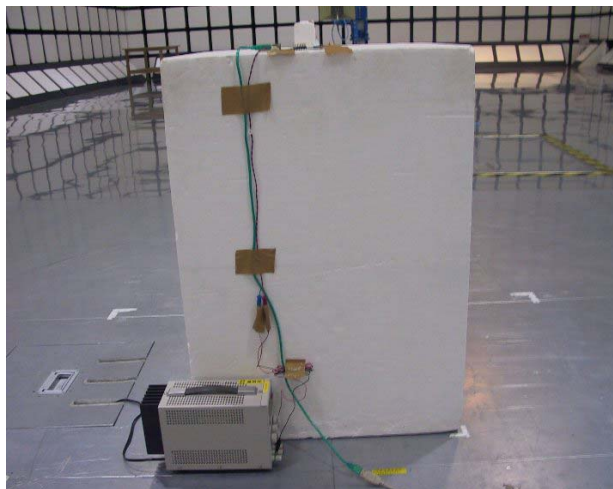
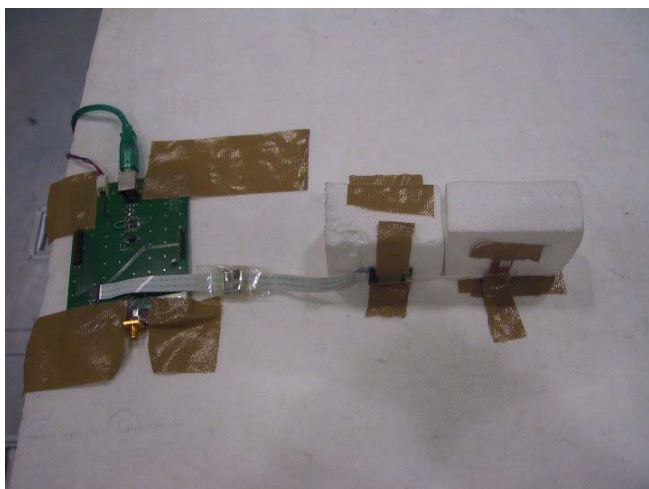

16.2 Photos of Conducted Measurement

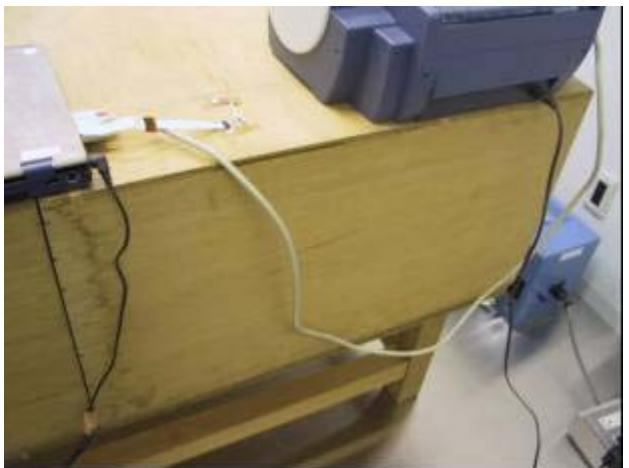

APPENDIX 1

About AFH-Hopping Sequence

AFH-Hopping Sequence is provided for in the Bluetooth Spec 1.2. Here is an outline below.

1. In the case of 79Hopping

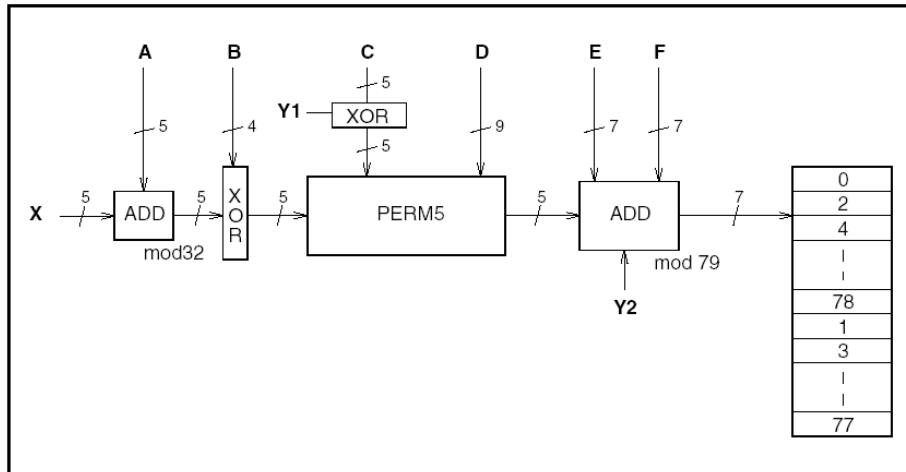

Due to the above flow, 32 hops are made into 5 ways. Then, the sign of the sign head 160 is formed. The remainder that is worked out by dividing with 79 is assigned to Hopping Channel.

Each parameter of the above figure uses the value calculated from the Bluetooth clock and the Bluetooth address which are shown in the next page.

2. In the case of AFH-Hopping

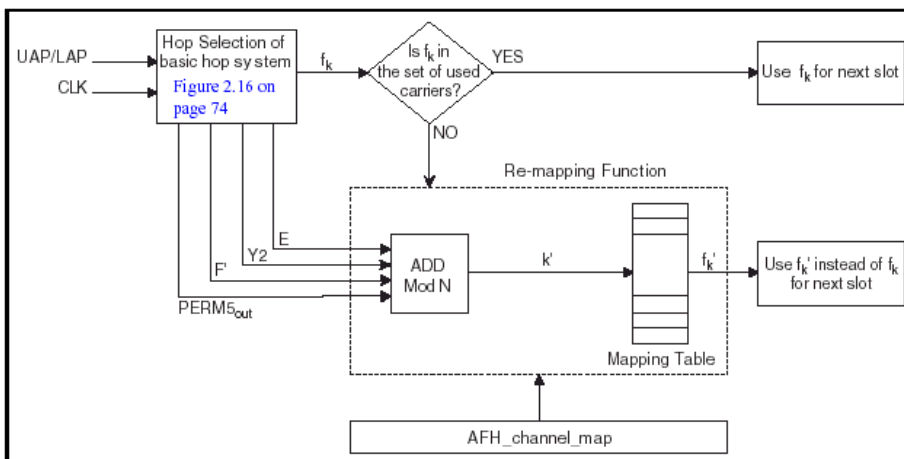

Also in the case of AFH, the fundamental sign adopt the sign head 160 that is the same as the case of 79Hopping. Hopping Pattern uses the value that is worked out by dividing with the number of AFH-Channel's. Then, available Hopping becomes even as well as 79Hopping.

The selection of the communication Channel is done by the communication error rate and the receiving signal strength. Frequency is determined by pairing the channel and the value which is divided by the number of AFH-Channel one-to-one.

It is decided in the specifications that Communication Channel has to have “20Channels” at least. However, if the number of communication Channel is controlled to be under 20 back to 79Channel-Hopping, and select the communication Channel again.

3.The parameter list which decides Hopping-Pattern

	Page scan / Interlaced Page Scan / Inquiry scan / Interlaced Inquiry Scan	Page/Inquiry	Master/Slave page response and Inquiry response	Connection state
X	$CLKN_{16-12} /$ $(CLKN_{16-12} + 16) \bmod 32 /$ $Xir_{4-0} /$ $Xir_{4-0} + 16) \bmod 32$	Xp_{4-0} / Xi_{4-0}	$Xprm_{4-0} /$ $Xprs_{4-0} /$ Xir_{4-0}	CLK_{6-2}
Y1	0	$CLKE_1 / CLKN_1$	$CLKE_1 / CLKN_1 / 1$	CLK_1
Y2	0	$32 \times CLKE_1 /$ $32 \times CLKN_1$	$32 \times CLKE_1 /$ $32 \times CLKN_1 /$ 32×1	$32 \times CLK_1$
A	A_{27-23}	A_{27-23}	A_{27-23}	$A_{27-23} \oplus CLK_{25-21}$
B	A_{22-19}	A_{22-19}	A_{22-19}	A_{22-19}
C	$A_{8,6,4,2,0}$	$A_{8,6,4,2,0}$	$A_{8,6,4,2,0}$	$A_{8,6,4,2,0} \oplus CLK_{20-16}$
D	A_{18-10}	A_{18-10}	A_{18-10}	$A_{18-10} \oplus CLK_{15-7}$
E	$A_{13,11,9,7,5,3,1}$	$A_{13,11,9,7,5,3,1}$	$A_{13,11,9,7,5,3,1}$	$A_{13,11,9,7,5,3,1}$
F	0	0	0	$16 \times CLK_{27-7} \bmod 79$
F'	n/a	n/a	n/a	$16 \times CLK_{27-7} \bmod N$

APPENDIX 2

United States Department of Commerce
National Institute of Standards and Technology

COPY

NVLAP[®]

Certificate of Accreditation to ISO/IEC 17025:1999

NVLAP LAB CODE: 200607-0

Taiyo Yuden Co., Ltd. EMC Center
Gunma-gun Gunma 370-3347
JAPAN

*is recognized by the National Voluntary Laboratory Accreditation Program for conformance with criteria set forth in
NIST Handbook 150:2001 and all requirements of ISO/IEC Guide 17025:1999.
Accreditation is granted for specific services, listed on the Scope of Accreditation, for:*

ELECTROMAGNETIC COMPATIBILITY AND TELECOMMUNICATIONS

2005-10-01 through 2006-09-30
Effective dates



For the National Institute of Standards and Technology

NVLAP-01C (REV. 2005-05-19)