

**FUJITSU**

Fujitsu LifeBook®  
E8310 Notebook

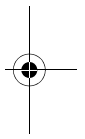

**User's Guide**

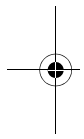
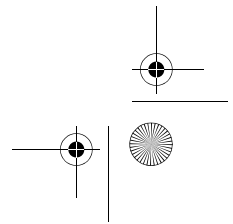
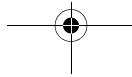
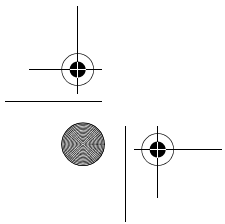

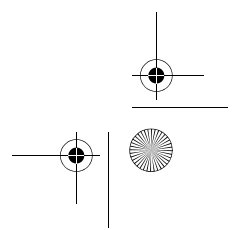
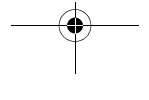
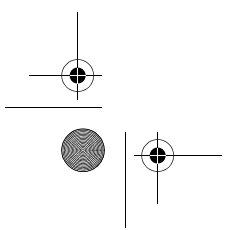
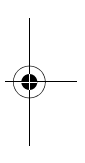
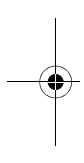
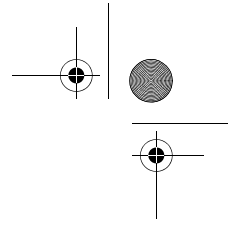
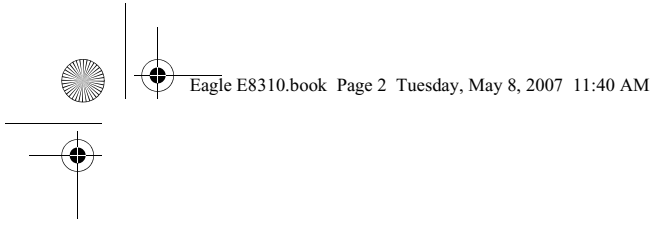

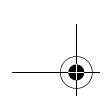

Copyright

## Copyright and Trademark Information

Fujitsu Computer Systems Corporation has made every effort to ensure the accuracy and completeness of this document; however, as ongoing development efforts are continually improving the capabilities of our products, we cannot guarantee the accuracy of the contents of this document. We disclaim liability for errors, omissions, or future changes.

Fujitsu, the Fujitsu logo, and LifeBook are registered trademarks of Fujitsu Limited.

Intel, Intel Core, Centrino, and Intel Centrino Pro are trademarks or registered trademarks of Intel Corporation or its subsidiaries in the United States and other countries.

Microsoft, Windows, and Windows Vista are either registered trademarks or trademarks of Microsoft Corporation in the United States and/or other countries.

The ExpressCard word mark and logo are owned by the Personal Computer Memory Card International Association (PCMCIA) and any use of such marks by Fujitsu Computer Systems Corporation is under license.

PCMCIA is a trademark of the Personal Computer Memory Card International Association.

Bluetooth is a trademark of Bluetooth SIG, Inc., USA.

OmniPass is a trademark of Softex, Inc.

Atheros and Super AG are registered trademarks of Atheros Communications, Inc.

Roxio is a trademark of Roxio, a division of Sonic Solutions.

Adobe, Acrobat, and Acrobat Reader are either a registered trademarks or trademarks of Adobe Systems Inc. in the United States and/or other countries.

Norton and Norton Internet Security are trademarks or registered trademarks of Symantec Corporation in the United States and other countries.

PowerProducer is a trademark of CyberLink Corp.

The DVD player found in some models of the LifeBook notebook incorporates copyright protection technology that is protected by method claims of certain U.S. patents and other intellectual property rights owned by Macrovision Corporation and other rights users. Use of this copyright protection technology must be authorized by Macrovision Corporation, and is intended for home and other limited viewing uses only unless authorized by Macrovision Corporation. Reverse engineering or disassembly is prohibited.

All other trademarks mentioned herein are the property of their respective owners.

**Warning**



Handling the cord on this product will expose you to lead, a chemical known to the State of California to cause birth defects or other reproductive harm.

***Wash hands after handling.***

© Copyright 2007 Fujitsu Computer Systems Corporation. All rights reserved.

No part of this publication may be copied, reproduced, or translated, without prior written consent of Fujitsu. No part of this publication may be stored or transmitted in any electronic form without the written consent of Fujitsu.

B5FJ-3971-01EN-00



### DECLARATION OF CONFORMITY

according to FCC Part 15

Responsible Party Name:	Fujitsu Computer Systems Corporation
Address:	1250 E. Arques Avenue, M/S 122 Sunnyvale, CA 94085
Telephone:	(408) 746-6000
Declares that product:	Base Model Configuration: LifeBook E8310 notebook Complies with Part 15 of the FCC Rules.

This device complies with Part 15 of the FCC rules. Operations are subject to the following two conditions:  
(1) This device may not cause harmful interference, (2) This device must accept any interference received, including interference that may cause undesired operation.

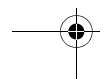
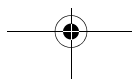

### IMPORTANT SAFETY INSTRUCTIONS

This unit requires an AC adapter to operate. Use only UL Listed Class II Adapters with an output rating of 19 VDC, with a current of 5.27 A (100W).

AC adapter output polarity:



When using your notebook equipment, basic safety precautions should always be followed to reduce the risk of fire, electric shock and injury to persons, including the following:

- Do not use this product near water for example, near a bathtub, washbowl, kitchen sink or laundry tub, in a wet basement or near a swimming pool.
- Avoid using the modem during an electrical storm. There may be a remote risk of electric shock from lightning.
- Do not use the modem to report a gas leak in the vicinity of the leak.
- Use only the power cord and batteries indicated in this manual. Do not dispose of batteries in a fire. They may explode. Check with local codes for possible special disposal instructions.
- To reduce the risk of fire, use only No. 26 AWG or larger UL Listed or CSA Certified Telecommunication Line Cord.

For TV tuner use: To protect from overvoltages and transients on the Cable Distribution System, make sure that the outer shield of the coaxial cable is connected to earth (grounded) at the building premise as close to the point of cable entrance as practicable, as required per NEC Article 820.93, ANSI/NFPA 70: 2005. If you have questions about your CATV installation, contact your service provider.

SAVE THESE INSTRUCTIONS

### For Authorized Repair Technicians Only



Danger of explosion if Lithium (clock) battery is incorrectly replaced. Replace only with the same or equivalent type recommended by the manufacturer. Dispose of used batteries according to the manufacturer's instruction.



For continued protection against risk of fire, replace only with the same type and rating fuse.

### System Disposal



LAMP(S) INSIDE THIS PRODUCT CONTAIN MERCURY AND MUST BE RECYCLED OR DISPOSED OF ACCORDING TO LOCAL, STATE, OR FEDERAL LAWS.



**Table of Contents**

# Fujitsu LifeBook® E8310 Notebook Table of Contents

## 1

### PREFACE

Conventions Used in the Guide . . . . .	1
Fujitsu Contact Information . . . . .	1
Limited Warranty . . . . .	1

## 2

### GETTING TO KNOW YOUR LIFEBOOK NOTEBOOK

#### Overview

Unpacking . . . . .	5
---------------------	---

#### Locating the Controls/Connectors

Top Components . . . . .	6
Left-Side Panel Components . . . . .	8
Right-Side Panel Components . . . . .	9
Back Panel Components . . . . .	10
Bottom Components . . . . .	11

#### Status Indicator Panel

Power Indicator . . . . .	12
AC Adapter Indicator . . . . .	12
Battery Level Indicators . . . . .	12
Battery Charging Indicators . . . . .	13
WLAN Access Power Indicator . . . . .	13
Optical Drive Access Indicator . . . . .	13
Hard Drive Access Indicator . . . . .	13
PC Card Access Indicator . . . . .	13
NumLk Indicator . . . . .	13
CapsLock Indicator . . . . .	13
ScrLk Indicator . . . . .	13
Security Indicator . . . . .	13

#### Keyboard

Using the Keyboard . . . . .	14
Numeric Keypad . . . . .	14
Windows Keys . . . . .	14
Cursor Keys . . . . .	14
Function Keys . . . . .	15

#### Touchpad Pointing Device

Clicking . . . . .	16
Double-Clicking . . . . .	16
Dragging . . . . .	17
Touchpad Control Adjustment . . . . .	17
Scrolling . . . . .	17
Optional Quick Point Feature . . . . .	17

#### Volume Control

Controlling the Volume . . . . .	18
----------------------------------	----

#### Flexible Bay Devices

Removing and Installing Modular Devices . . . . .	19
---	----

#### LifeBook Security/Application Panel

Setting up Your LifeBook Security Panel . . . . .	20
Passwords . . . . .	20
Operating Your Security/Application Panel . . . . .	21
Uninstalling the Security Panel Application . . . . .	21
Launching Applications with the Panel . . . . .	22

## 3

### GETTING STARTED

#### Power Sources

Connecting the Power Adapters . . . . .	27
---	----

#### Display Panel

Opening the Display Panel . . . . .	28
Adjusting Display Panel Brightness . . . . .	28
Closing the Display Panel . . . . .	28

#### Starting Your LifeBook Notebook

Power On . . . . .	29
Boot Sequence . . . . .	29
Hard Disk Drive Passwords . . . . .	29
BIOS Setup Utility . . . . .	29
Booting the System . . . . .	30
Starting Windows Vista the first time . . . . .	30
Starting Windows XP the First Time . . . . .	31
Registering Your LifeBook notebook . . . . .	31
Installing Click Me! . . . . .	31
Fujitsu Driver Update Utility . . . . .	31

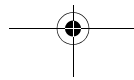
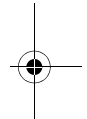
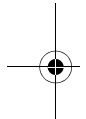

## Power Management

Power/Suspend/Resume Button . . . . .	32
Standby Mode . . . . .	32
Hibernation (Save-to-Disk) Feature . . . . .	32
Windows Power Management . . . . .	33
Restarting the System . . . . .	33
Powering Off . . . . .	33

## 4

### USER-INSTALLABLE FEATURES

#### Lithium ion Battery

Recharging the Batteries . . . . .	37
Replacing the Battery . . . . .	38

#### Optical Drive

Media Player Software . . . . .	39
Loading Media on Your Drive . . . . .	39
Removing Media . . . . .	40
Emergency Optical Drive Tray Release . . . . .	40
Using the Media Player Software . . . . .	40

#### Memory Stick/Secure Digital Cards

Installing Memory Stick/SD Cards . . . . .	41
Removing A Memory Stick/SD Card . . . . .	41

#### PC Cards/ExpressCards™

Inserting PC Cards . . . . .	42
Removing PC Cards . . . . .	42
Inserting ExpressCards . . . . .	43
Removing ExpressCards . . . . .	43
Smart Card Reader . . . . .	43

#### Memory Upgrade Module

Installing Memory Upgrade Modules . . . . .	44
Removing a Memory Upgrade Module . . . . .	44
Checking the Memory Capacity . . . . .	45

#### Device Ports

Modem (RJ-11) Telephone Jack . . . . .	46
Internal LAN (RJ-45) Jack . . . . .	46
Parallel Port . . . . .	46
Serial Port . . . . .	47
Port Replicator Connector . . . . .	47
Universal Serial Bus Ports . . . . .	47
Infrared Port . . . . .	47
Headphone Jack . . . . .	47
Microphone Jack . . . . .	48
External Video Port . . . . .	48

## 5

### TROUBLESHOOTING

Identifying the Problem . . . . .	51
Specific Problems . . . . .	51
Troubleshooting Table . . . . .	52
Power On Self Test Messages . . . . .	59
Emergency Media Player Drive Tray Release . . . . .	60
Modem Result Codes . . . . .	60
Restoring Your Pre-installed Software . . . . .	61
Restoring the Factory Image . . . . .	61
Automatically Downloading Driver Updates . . . . .	62

## 6

### CARE AND MAINTENANCE

Batteries . . . . .	66
Floppy Disks and Drives . . . . .	66
Media Care . . . . .	67
PC Cards/ExpressCards . . . . .	67

## 7

### SYSTEM SPECIFICATIONS

Configuration Label . . . . .	71
Microprocessor . . . . .	71
Chipset . . . . .	71
Memory . . . . .	71
Video . . . . .	71
Audio . . . . .	71
Mass Storage Device Options . . . . .	71
Features . . . . .	72
Device Ports . . . . .	72
Keyboard . . . . .	72
Power . . . . .	72
Dimensions and Weight . . . . .	72
Environmental Requirements . . . . .	73
Popular Accessories . . . . .	73
Pre-Installed Software . . . . .	73

## 8

### GLOSSARY/REGULATORY

Glossary . . . . .	77
Regulatory Information . . . . .	83

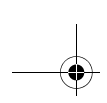

**Table of Contents**

**APPENDIX A: INTEGRATED WIRELESS LAN USER'S GUIDE**

**Before Using the Wireless LAN**

Wireless LAN Modes Using this Device. . . . .88  
 Wireless Network Considerations . . . . .89  
 Deactivating the WLAN Device . . . . .89  
 Activating the WLAN Device . . . . .90

**Configuration of the WLAN Device**

Configuring the WLAN with Windows Vista. . . .91  
 Connecting to a Network with Windows Vista . .91  
 Configuring the WLAN Using Windows XP . . .91  
 Connection to the Network . . . . .94

**Troubleshooting the WLAN**

Troubleshooting. . . . .97

**WLAN Specifications**

Specifications . . . . .98

**Using the Bluetooth Device**

What is Bluetooth. . . . .99  
 Where to Find Information About Bluetooth . . .99

**APPENDIX B: USING THE FINGERPRINT SENSOR**

**Fingerprint Sensor Device**

Introducing the Fingerprint Sensor Device . . .103  
 Getting Started. . . . .103  
 Installing OmniPass . . . . .103  
 User Enrollment . . . . .104  
 Using OmniPass. . . . .105  
 Configuring OmniPass . . . . .107  
 OmniPass Control Center. . . . .108  
 Troubleshooting. . . . .109

**Index**

Index . . . . .111

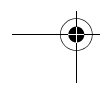
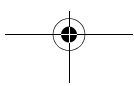

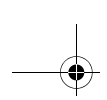

LifeBook E8000 Notebook

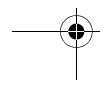
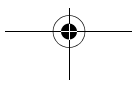
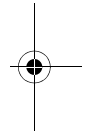
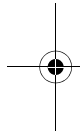



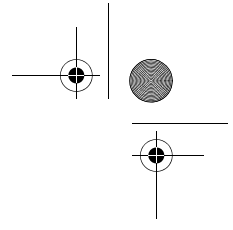
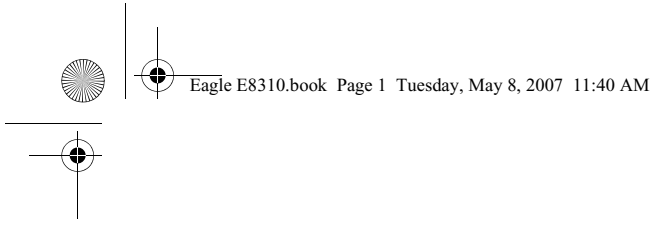

# 1 Preface

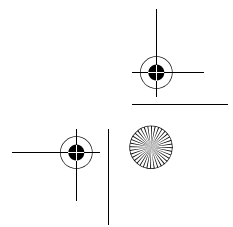
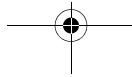
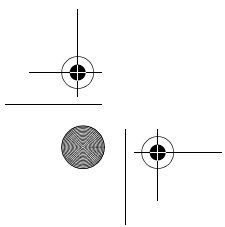
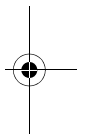
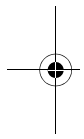

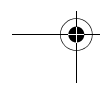
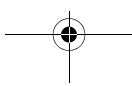
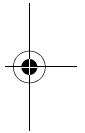
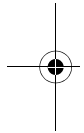
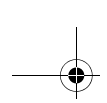

## Preface

### ABOUT THIS GUIDE

The LifeBook E8310 notebook from Fujitsu Computer Systems Corporation provides desktop performance with a fast, Intel® Core™ 2 Duo processor. Depending upon the configuration, your notebook has either a built-in 15.4" TFT XGA or SXGA+ color display. This system brings the computing power of desktop personal computers (PCs) to a portable environment.

Your computer comes with Microsoft Windows® XP Professional or Windows Vista Business operating system pre-installed.

This manual explains how to operate your LifeBook notebook's hardware and built-in system software.

### CONVENTIONS USED IN THE GUIDE

Keyboard keys appear in brackets.  
Example: [Fn], [F1], [ESC], [ENTER] and [CTRL].

Pages with additional information about a specific topic are cross-referenced within the text.  
For example: (See page xx.)

On screen buttons or menu items appear in bold  
Example: Click **OK** to restart your LifeBook notebook.



The information icon highlights information that will enhance your understanding of the subject material.



The caution icon highlights information that is important to the safe operation of your computer, or to the integrity of your files. Please read all caution information carefully.



The warning icon highlights information that can be hazardous to either you, your LifeBook notebook, or your files. Please read all warning information carefully.

### FUJITSU CONTACT INFORMATION

#### Service and Support

You can contact Fujitsu Service and Support in the following ways:

- Toll free: 1-800-8Fujitsu (1-800-838-5487)
- E-mail: [8fujitsu@us.fujitsu.com](mailto:8fujitsu@us.fujitsu.com)
- Website: [us.fujitsu.com/computers](http://us.fujitsu.com/computers)

Before you place the call, you should have the following information ready so that the customer support representative can provide you with the fastest possible solution:

- Product name
- Product configuration number
- Product serial number
- Purchase date
- Conditions under which the problem occurred
- Any error messages that have occurred
- Type of device connected, if any

#### Fujitsu Shopping Online

You can go directly online to the Fujitsu Product catalog for your LifeBook notebook by going to the website at [www.shopfujitsu.com](http://www.shopfujitsu.com).

You can also reach Fujitsu Service and Support online by clicking on Start -> Fujitsu Weblinks -> Fujitsu Service and Support.



You must have an active internet connection to use the online URL links.

### LIMITED WARRANTY

Your LifeBook notebook is backed by a Fujitsu International Limited Warranty. Check the service kit that came with your notebook for the Limited Warranty period and terms and conditions.

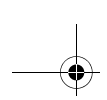

LifeBook E8000 Notebook

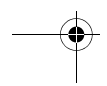
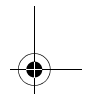
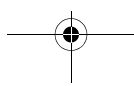
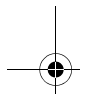
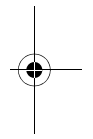
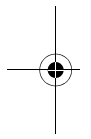

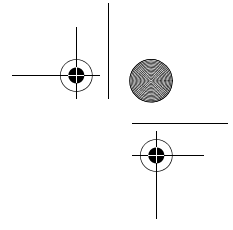
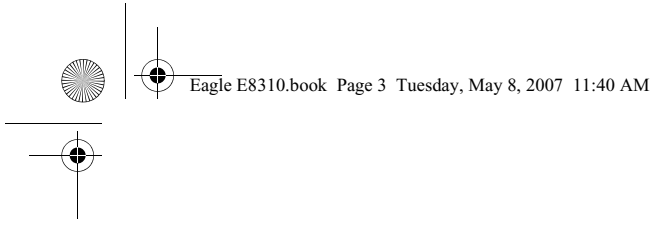

# 2

## Getting to Know Your LifeBook Notebook

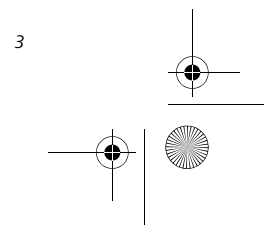
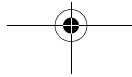
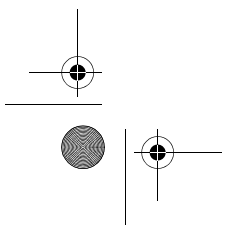
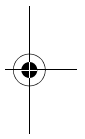
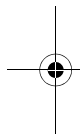

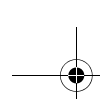

LifeBook E8000 Notebook

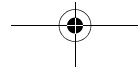
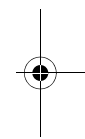
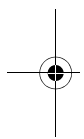



Figure 2-1. Fujitsu LifeBook E8310 notebook

## Overview

This section describes the components of your Fujitsu LifeBook E8310 notebook. We strongly recommend that you read it before using your notebook – even if you are already familiar with notebook computers.

### UNPACKING

When you receive your LifeBook notebook, unpack it carefully, and compare the parts you have received with the items listed below.

For a pre-configured model you should have:

- LifeBook E8310 notebook (Figure 2-1)
- AC adapter with AC power cord (Figure 2-2)
- Lithium ion Battery, pre-installed
- Weight Saver
- Phone/Modem (RJ-11) telephone cable
- Driver and Application Restore (DAR) Disc
- Recovery DVD
- Getting Started Guide
- User's Guide (this document)
- International Limited Warranty Brochure
- Microsoft®-associated product materials

Depending on your system configuration, one of the following devices will be pre-installed in the Flexible Bay:

- Weight Saver
- Modular Dual-Layer Multi-Format DVD Writer
- Modular DVD/CD-RW combo drive
- Modular DVD-ROM drive

Depending on your system configuration, the following optional items may be included with your system:

- Modular 2nd bay battery
- External USB floppy disk drive
- Application CDs for third-party software

Once you have checked and confirmed that your LifeBook system is complete, read through the following pages to learn about all of your notebook's components.

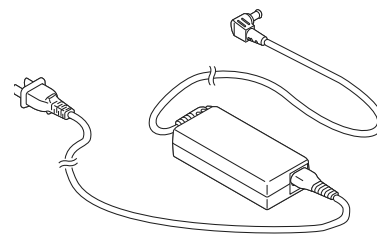

Figure 2-2 AC Adapter

LifeBook E8000 Notebook

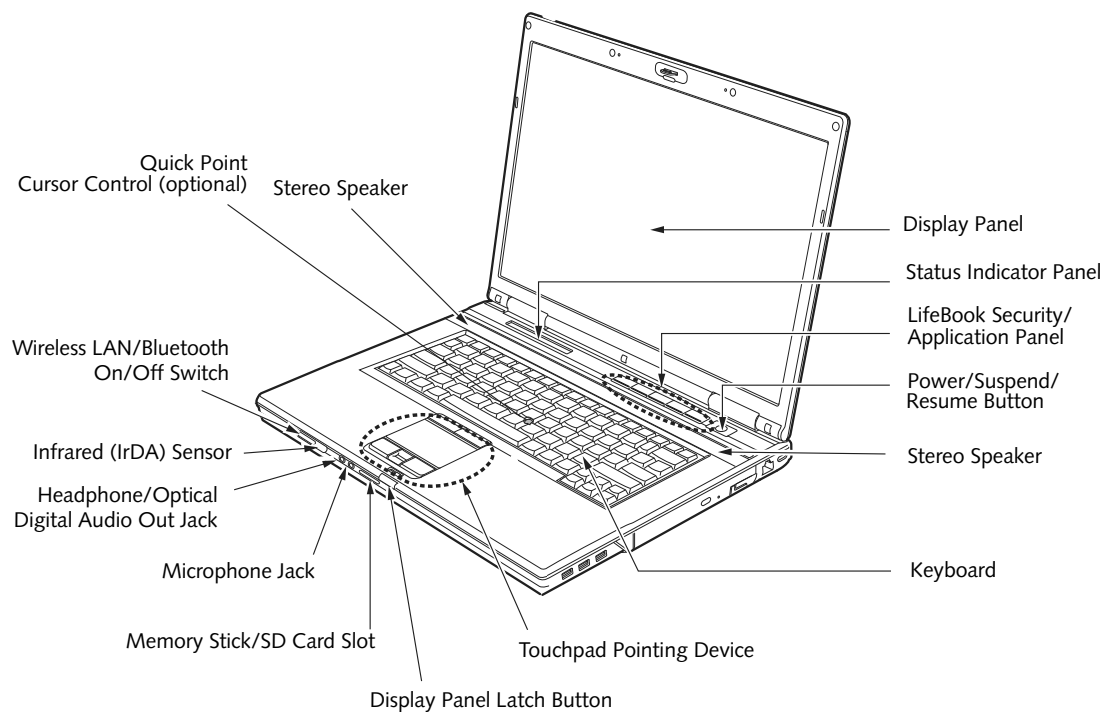

Figure 2-3. LifeBook notebook with display open

## Locating the Controls and Connectors

### TOP COMPONENTS

The following is a brief description of your LifeBook notebook's top components.

#### Display Panel

The display panel is a color LCD panel with back lighting for the display of text and graphics.

#### Status Indicator Panel

The Status Indicator Panel displays symbols that correspond with a specific component of your LifeBook notebook. (See *Status Indicator Panel on page 12 for more information*)

#### LifeBook Security/Application Panel

The LifeBook Security/Application Panel provides hardware security and one-touch application launch capability. (See *LifeBook Security/Application Panel on page 20 for more information*)

#### Power/Suspend/Resume Button

The Power/Suspend/Resume button allows you to suspend notebook activity without powering off, resume your notebook from standby mode, and power on your notebook when it has been shut down from Windows.

(See *Power/Suspend/Resume Button on page 29 for more information*)

#### Stereo Speakers

The built-in dual speakers allow for stereo sound.

#### Keyboard

A full-size keyboard with dedicated Windows keys. (See *Keyboard on page 14 for more information*)

#### Touchpad Pointing Device

The Touchpad pointing device is a mouse-like cursor control with five buttons: two right mouse-like buttons, two left mouse-like buttons, and a scroll button. The upper left and right buttons are for use with the Quick Point cursor control. (See *Touchpad Pointing Device on page 16 for more information*) Depending upon the configuration of your system, the scroll button may be configured as a fingerprint sensor device. (See *Fingerprint Sensor Device on page 103 for more information*)

#### Display Panel Latch Button

The display panel latch button is used to latch and unlatch the display. (See *Opening the Display Panel on page 28 for more information*)

#### Memory Stick/SD Card Slot

The Memory Stick/SD card slot allows you to install a Memory Stick or a Secure Digital (SD) card for data storage. This architecture allows you to transfer data



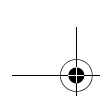

from a variety of different digital devices. (See *Installing Memory Stick/SD Cards on page 41 for more information*)

**Microphone Jack**

The microphone jack allows you to connect an external mono microphone.

**Headphone Jack**

The headphone jack allows you to connect headphones to listen to audio files.

**Infrared (IrDA) Sensor**

Provides an infrared interface for communication with devices IrDA Standard Rev.1.1-compliant.

**Wireless LAN/Bluetooth On/Off Switch**

The wireless LAN/Bluetooth on/off switch is used to turn on and off the optional WLAN and Bluetooth devices. Switching the device off when not in use will help to extend battery life. (See *Activating the WLAN Device on page 90 for more information*)

**Quick Point Cursor Control**

The optional Quick Point control offers an additional method for moving the cursor. (See *Optional Quick Point Feature on page 17 for more information*)

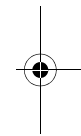
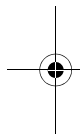

## LifeBook E8000 Notebook

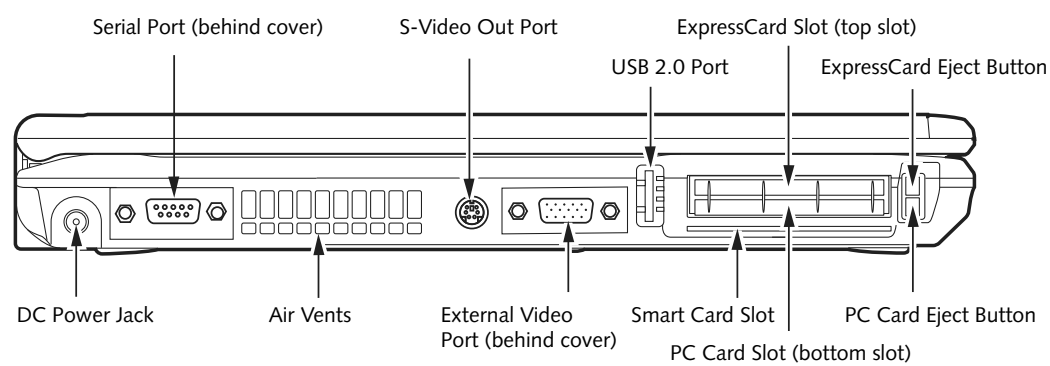

Figure 2-4. LifeBook notebook left-side panel

**LEFT-SIDE PANEL COMPONENTS**

The following is a brief description of your LifeBook notebook's left-side components.

**Serial Port**

The serial port allows you to connect serial RS-232 devices, such as serial printers or serial scanners. (See *Serial Port* on page 48 for more information)

**S-Video Out Port**

The S-Video output is used to transmit a higher resolution video signal to a compatible TV or VCR.

**USB 2.0 Ports**

The USB 2.0 ports allow you to connect Universal Serial Bus devices. USB 2.0 transfers data at up to 480 Mbps and is backward-compatible with USB 1.1 devices, which transfer data at up to 12 Mbps. (See *Universal Serial Bus Ports* on page 47 for more information)

**ExpressCard Slot/Eject Button**

The ExpressCard slot allows you to install an ExpressCard. (See *PC Cards/ExpressCards™* on page 42 for more information) The ExpressCard eject button is used for removing an ExpressCard from the slot.

**PC Card Slot/Eject Button**

The PC Card slot is for installing a Type I or Type II PC Card. (See *PC Cards/ExpressCards™* on page 42 for more information) The PC Card eject button is used for removing a PC Card from the slot.

**Smart Card Slot**

A dedicated Smart Card slot is provided on your notebook. Smart Cards are the same size and shape as credit cards, but they contain an integrated microprocessor chip. (See *Smart Card Reader* on page 43 for more information) In order to use the embedded Smart Card Reader, you must purchase optional third-party software for installation.

**External Video Port**

The external monitor port allows you to connect an external monitor or LCD projector. (See *External Video Port* on page 48 for more information)

**Air Vents**

The air vents are used to cool the system to prevent overheating.



To protect your notebook from damage and to optimize system performance, be sure to **keep all air vents unobstructed, clean, and clear of debris**. This may require periodic cleaning, depending upon the environment in which the system is used.

Do not operate the notebook in areas where the air vents can be obstructed, such as in tight enclosures or on soft surfaces like a bed or cushion.

**DC Power Jack**

The DC power jack allows you to plug in the AC adapter to power your LifeBook notebook and charge the internal Lithium ion battery.

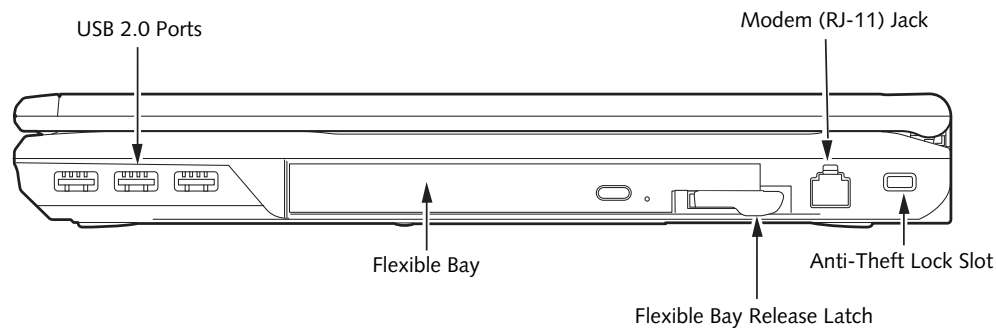

Figure 2-5. LifeBook notebook right-side panel

**RIGHT-SIDE PANEL COMPONENTS**

The following is a brief description of your LifeBook notebook's right-side components.

**USB 2.0 Ports**

The USB 2.0 ports allow you to connect Universal Serial Bus devices. USB 2.0 transfers data at up to 480Mbps and is backward-compatible with USB 1.1 devices, which transfer data at up to 12Mbps. (See *Universal Serial Bus Ports* on page 47 for more information)

**Modem (RJ-11) Telephone Jack**

The Modem (RJ-11) telephone jack is for attaching a telephone line to the internal multinational 56K modem. (See *Modem (RJ-11) Telephone Jack* on page 46 for more information)



The internal modem is not intended for use with Digital PBX systems. Do not connect the internal modem to a Digital PBX as it may cause serious damage to the internal modem or your entire notebook. Consult your PBX manufacturer's documentation for details. Some hotels have Digital PBX systems. Be sure to find out **BEFORE** you connect your modem.



The internal multinational modem is designed to the ITU-T V.90/v.92 standard. Its maximum speed of 53000 bps is the highest allowed by FCC, and its actual connection rate depends on the line conditions. The maximum speed is 33600 bps at upload, in accordance with FCC regulations.

For additional information about the modem, refer to the Fujitsu website at: [us.fujitsu.com/computers](http://us.fujitsu.com/computers).

**Flexible Bay Release Latch**

The Flexible Bay release latch releases the Flexible Bay device.

**Flexible Bay**

The Flexible Bay can accommodate one of the following devices. (See *Flexible Bay Devices* on page 19 for more information)

- Modular DVD-ROM drive
- Modular DVD/CD-RW combo drive
- Modular Dual-Layer Multi-Format DVD Writer
- Modular Lithium ion battery
- Modular second hard disk drive
- Weight Saver

**Anti-theft Lock Slot**

The anti-theft lock slot allows you to attach an optional physical lock down device.

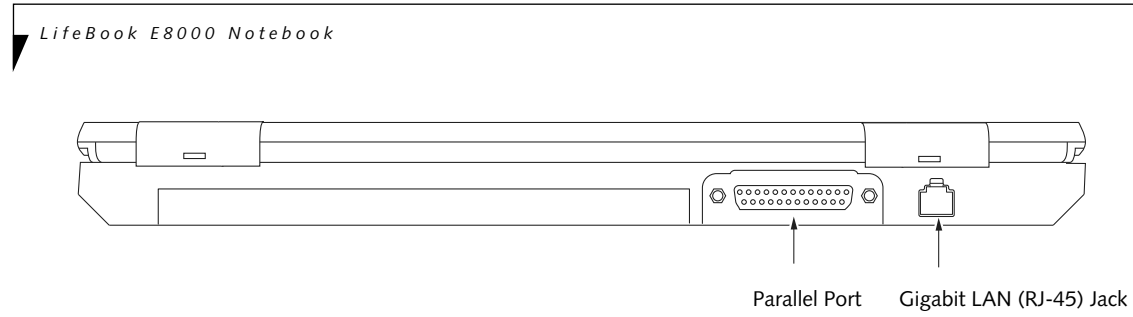

Figure 2-6. LifeBook notebook back panel

### BACK PANEL COMPONENTS

Following is a brief description of your LifeBook notebook's back panel components.

#### Parallel Port

The parallel port allows you to connect parallel devices, such as a printer. (This is also sometimes referred to as an LPT port.) (See *Parallel Port* on page 48 for more information)

#### Gigabit LAN (RJ-45) Jack

The internal LAN (RJ-45) jack is used for an internal Gigabit (10Base-T/100Base-Tx/1000Base-T) Ethernet LAN connection. (See *Internal LAN (RJ-45) Jack* on page 46 for more information)

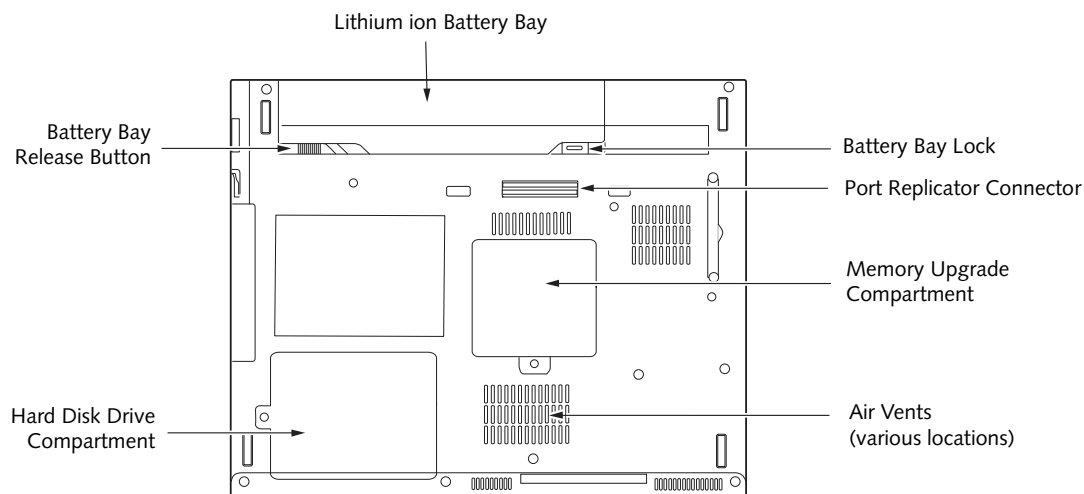

Figure 2-7. LifeBook notebook bottom panel

### BOTTOM COMPONENTS

The following is a brief description of your LifeBook notebook's bottom panel components.

#### Lithium ion Battery Bay

The battery bay contains the internal Lithium ion battery. It can be opened for the removal of the battery when stored over a long period of time or for swapping a discharged battery with a charged Lithium ion battery. (See *Lithium ion Battery* on page 37 for more information)

#### Battery Bay Lock/Release Button

The battery bay lock and release button are used together to secure or remove the Lithium ion battery. (See *Replacing the Battery* on page 38 for more information)

#### Port Replicator Connector

This connector allows you to connect the optional Port Replicator to your notebook.

#### Memory Upgrade Compartment

Your notebook comes with high speed Double Data Rate 2 Synchronous Dynamic RAM (DDR2 SDRAM). The memory upgrade compartment allows you to expand the system memory capacity of your notebook, thus improving overall performance. (See *Memory Upgrade Module* on page 44 for more information) Under normal circumstances, it should not be necessary to open this compartment.

#### Air Vents

The air vents allow air to circulate through the system to cool down the components.



To protect your notebook from damage and to optimize system performance, be sure to **keep all air all vents unobstructed, clean, and clear of debris**. This may require periodic cleaning, depending upon the environment in which the system is used.

Do not operate the notebook in areas where the air vents can be obstructed, such as in tight enclosures or on soft surfaces like a bed or cushion.

#### Hard Disk Drive Compartment

The hard disk drive compartment contains the hard disk drive. Under normal circumstances, it should not be necessary to open this compartment.

LifeBook E8000 Notebook

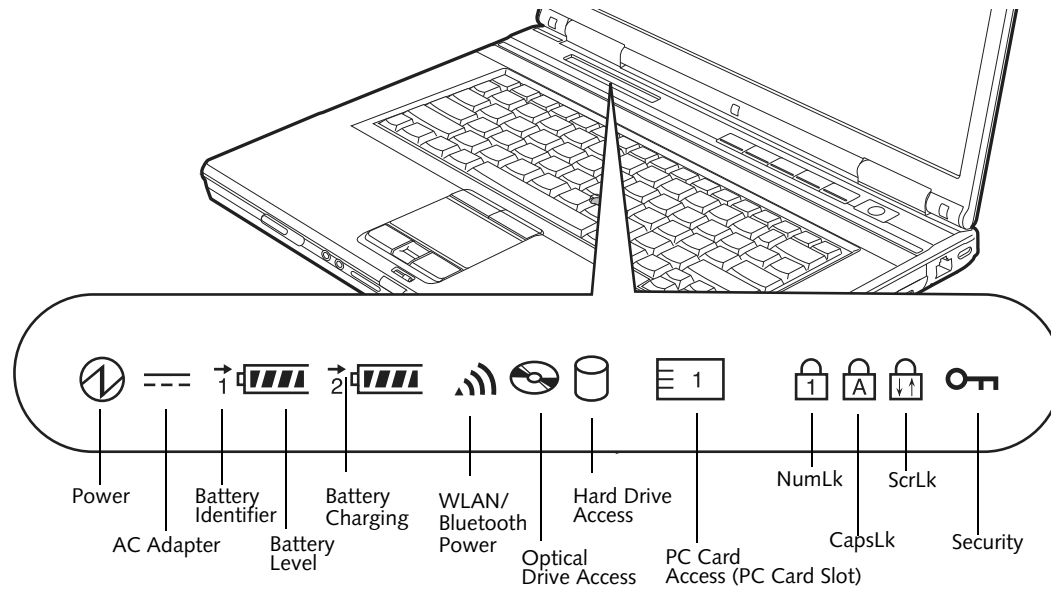

Figure 2-8. Status Indicator Panel

## Status Indicator Panel

The Status Indicator displays symbols that correspond with a specific component of your Fujitsu LifeBook notebook. These symbols tell you how each of those components are operating.



### POWER INDICATOR

The Power indicator symbol states whether your system is operational. It has several different states, each of which tells you the mode your notebook is in.

- **Steady On:** This means that there is power to your LifeBook notebook and that it is ready for use.
- **Flashing:** This means that your notebook is in Standby mode.
- **Steady Off:** This means that your notebook is either in Save-to-Disk mode, or it has been turned off.

If you are charging your battery, the Power indicator will remain on even if your notebook is shut off. The Power indicator will also remain on if you have either adapter connected and are shut down from Windows.



### AC ADAPTER INDICATOR

The AC Adapter indicator shows whether your notebook is operating from the AC adapter, Auto/Airline adapter or battery(s). This icon has two different states that can tell you what power source your notebook is using.

- **On:** This means that either of the adapters are currently in use.
- **Off:** Power is only coming from the batteries, and you do not have an adapter connected.



### BATTERY LEVEL INDICATORS

The two Battery Level indicators state whether or not the primary Lithium ion battery and/or the optional second Lithium ion battery are installed (Battery 1 refers to the primary Lithium ion battery, while Battery 2 refers to the Flexible Bay optional second battery). In addition, this symbol states how much charge is available within each installed battery. The symbol will only be displayed for a battery that is currently installed in your LifeBook notebook.

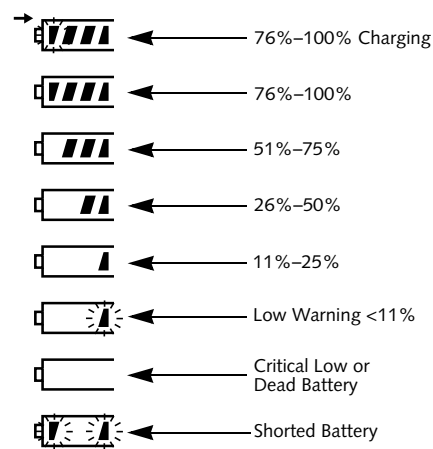

Figure 2-9 Battery Level Indicator



A shorted battery is damaged and must be replaced. (Figure 2-9)

**→ BATTERY CHARGING INDICATORS**

Located to the left of each Battery Level indicator is a small arrow symbol. This symbol states whether that specific battery is charging. This indicator will flash if the battery is too hot or cold to charge.



Batteries subjected to shocks, vibration or extreme temperatures can be permanently damaged.

**WLAN ACCESS POWER INDICATOR**

The WLAN power indicator appears when the Wireless LAN or Bluetooth power is applied.

**OPTICAL DRIVE ACCESS INDICATOR**

The Optical Drive Access indicator tells you that the DVD/CD-RW/CD-ROM drive is being accessed. If the Auto Insert Notification function is active, the indicator will flash periodically when your system is checking the DVD/CD-RW/CD-ROM drive. If the Auto Insert Notification function is not active, the indicator will only flash when you access the DVD/CD-RW/CD-ROM drive. The default setting is the Auto Insert Notification function active.



The DVD/CD-RW/CD-ROM Auto Insert Notification function will periodically check for a DVD/CD-RW/CD-ROM installed in the drive, causing the DVD/CD-RW/CD-ROM Access indicator to flash. The DVD/CD-RW/CD-ROM Auto Insert Notification function allows your system to start a DVD/CD-RW/CD-ROM automatically as soon as it is inserted in the drive and the tray is closed. It will begin playing an audio DVD/CD or will start an application if the DVD/CD has an auto-run file

**HARD DRIVE ACCESS INDICATOR**

The Hard Drive Access indicator shows whether your internal hard drive is being accessed.



The Hard Drive Access indicator does not show which hard drive is being accessed.

**PC CARD ACCESS INDICATOR**

The PC Card Access indicator shows whether or not your notebook is accessing a PC Card. The indicator will flash if your software tries to access a PC Card even if there is no card installed. (See *PC Cards/ExpressCards™* on page 42 for more information)

**NUMLK INDICATOR**

The NumLk indicator states that the integral keyboard is set in ten-key numeric keypad mode.

**CAPSLOCK INDICATOR**

The CapsLock indicator states that your keyboard is set to type in all capital letters.

**SCRCLK INDICATOR**

The ScrLk indicator states that your scroll lock is active.

**SECURITY INDICATOR**

The Security Indicator flashes (if a password was set) when the system resumes from Off or Standby modes. You must enter the password that was set in the Security Panel before your system will resume operation.

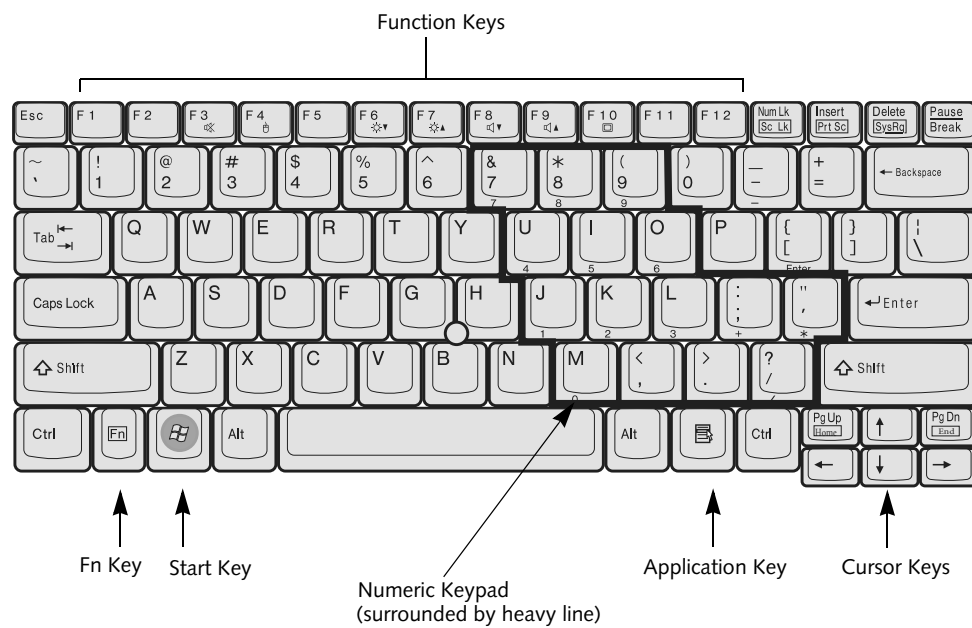

Figure 2-10 Keyboard

## Keyboard

### USING THE KEYBOARD

Your Fujitsu LifeBook notebook has an integral 84-key keyboard. The keys perform all the standard functions of a 101-key keyboard, including the Windows keys and other special function keys. This section describes the following keys. (Figure 2-10)

- **Numeric keypad:** Your notebook allows certain keys to serve dual purposes, both as standard characters and as numeric and mathematical keys. The ability to toggle between the standard character and numerical keys is controlled through the [NumLk] key.
- **Cursor keys:** Your keyboard contains four arrow keys for moving the cursor or insertion point to the right, left, up, or down within windows, applications and documents.
- **Function keys:** The keys labeled [F1] through [F12], are used in conjunction with the [Fn] key to produce special actions that vary depending on what program is running.
- **Windows keys:** These keys work with your Windows operating system and function the same as the onscreen Start menu button, or the right button on your pointing device.

### NUMERIC KEYPAD

Certain keys on the keyboard perform dual functions as both standard character keys and numeric keypad keys. NumLk can be activated by pressing the [NumLk] keys. Turning off the NumLk feature is done the same way. Once this feature is activated you can enter numerals 0 through 9, perform addition (+), subtraction (-), multiplication (\*), or division (/), and enter decimal points (.) using the keys designated as ten-key function keys. The keys in the numeric keypad are marked on the front edge of the key to indicate their secondary functions. (Figure 2-10)

### WINDOWS KEYS

Your LifeBook notebook has two Windows keys, consisting of a Start key and an Application key. The Start key displays the Start menu. This button functions the same as your onscreen Start menu button. The Application key functions the same as your right mouse button and displays shortcut menus for the selected item. (Please refer to your Windows documentation for additional information regarding the Windows keys.) (Figure 2-10)

### CURSOR KEYS

The cursor keys are the four arrow keys on the keyboard which allow you to move the cursor up, down, left and right in applications. In programs such as Windows Explorer, it moves the "focus" (selects the next item up, down, left, or right). (Figure 2-10)



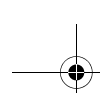

## FUNCTION KEYS

Your LifeBook notebook has 12 function keys, F1 through F12. The functions assigned to these keys differ for each application. You should refer to your software documentation to find out how these keys are used. (Figure 2-10)

The [Fn] key provides extended functions for the notebook and is always used in conjunction with another key.

- [Fn+F3]: Pressing [F3] while holding [Fn] will toggle the Audio Mute on and off.
- [Fn+F4]: Pressing [F4] while holding [Fn] will toggle the Quick Point feature on and off. Note that the [Fn+F4] combination only works if Manual Setting is selected in the BIOS. (See *Entering the BIOS Setup Utility* on page 29 for more information)
- [Fn+F6]: Pressing [F6] repeatedly while holding [Fn] will lower the brightness of your display.
- [Fn+F7]: Pressing [F7] repeatedly while holding [Fn] will increase the brightness of the display.
- [Fn+F8]: Pressing [F8] repeatedly while holding [Fn] will decrease the volume of your LifeBook notebook.
- [Fn+F9]: Pressing [F9] repeatedly while holding [Fn] will increase the volume of your LifeBook notebook.
- [Fn+F10]: Pressing [F10] while holding [Fn] allows you to change your selection of where to send your display video. Each time you press the combination of keys you will step to the next choice. The choices, in order, are: built-in display panel only, both built-in display panel and external monitor or external monitor only.

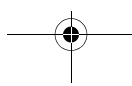
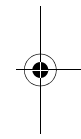
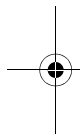

## LifeBook E8000 Notebook

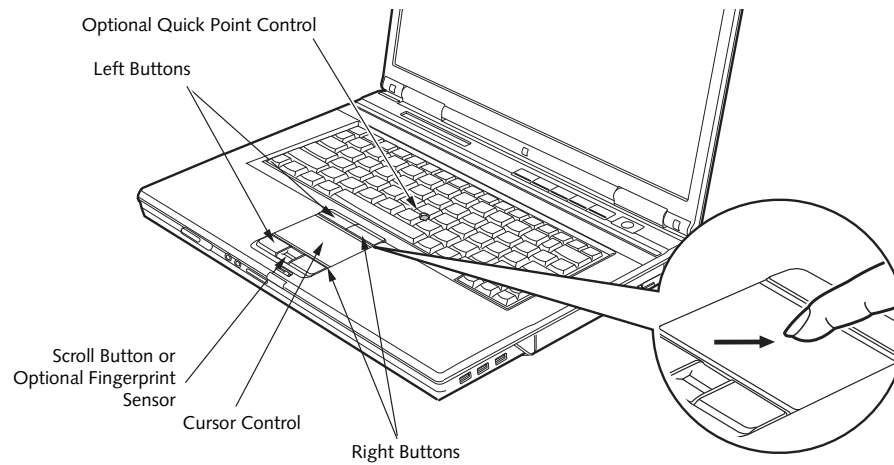

Figure 2-11. Touchpad pointing device

## Touchpad Pointing Device

The Touchpad pointing device built into your Fujitsu LifeBook is used to control the movement of the pointer to select items on your display panel. The Touchpad is composed of a cursor control, two left and right buttons, and a scrolling button. The cursor control works the same as a mouse, and moves the cursor around the display. It only requires light pressure with the tip of your finger. The left and right buttons function the same as mouse buttons. The left and right buttons that are located at the top of the Touchpad are designed for use with the optional Quick Point Control, and they function the same as the lower buttons. The actual functionality of the buttons may vary depending on the application that is being used. The scrolling button allows you to navigate quickly through pages, without having to use the scroll bars.

- Certain E8310 LifeBooks are equipped with an optional "Quick Point" button for moving the cursor. For more about Quick Point, see "Optional Quick Point Feature" on page 17.
  - The scrolling button may be replaced by an optional fingerprint sensor. To read about the fingerprint sensor, see "Fingerprint Sensor Device" on page 99.
- i**
- An external mouse can be connected to either USB or PS/2 ports on your LifeBook or the optional port replicator, and used simultaneously with the Touchpad. Note: If you boot the system with an external mouse connected the Touchpad will be disabled or enabled depending on your BIOS settings. (See *Entering the BIOS Setup Utility* on page 29 for more information)

### CLICKING

Clicking means pushing and releasing a button. To left-click, move the cursor to the item you wish to select, press the left button once, and then immediately release it. To right-click, move the mouse cursor to the item you wish to select, press the right button once, and then immediately release it. You also have the option to perform the clicking operation by tapping lightly on the Touchpad once. (Figure 2-12)

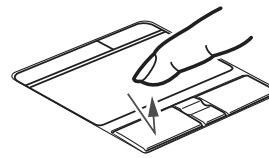

Figure 2-12 Clicking

### DOUBLE-CLICKING

Double-clicking means pushing and releasing the left button twice in rapid succession. This procedure does not function with the right button. To double-click, move the cursor to the item you wish to select, press the left button twice, and immediately release it. You can also perform the double-click operation by tapping lightly on the Touchpad twice. (Figure 2-13)

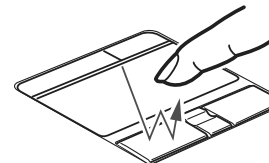
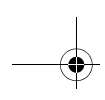

Figure 2-13 Double-clicking



### DRAGGING

Dragging means pressing and holding the left button, while moving the cursor. To drag, move the cursor to the item you wish to move. Press and hold the left button while moving the item to its new location and then release it. Dragging can also be done using the Touchpad. First, tap the Touchpad twice over the item you wish to move making sure to leave your finger on the pad after the final tap. Next, move the object to its new location by moving your finger across the Touchpad, and then release your finger. (Figure 2-14)

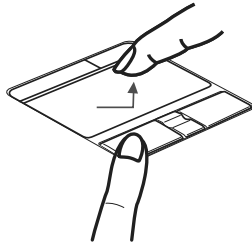

Figure 2-14 Dragging

### TOUCHPAD CONTROL ADJUSTMENT

The Windows Control Panel allows you to customize your Touchpad with selections made from within the Mouse Properties dialog box.

### SCROLLING

Using the Scrolling button allows you to navigate through a document quickly without using the window's scroll bars. This is particularly useful when you are navigating through on-line pages. To use the Scrolling button, press the crescent shape at the top or bottom of the button to scroll up or down a page. When you have reached the desired section of the page, release the button. (Figure 2-15)

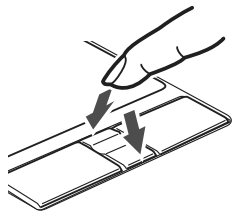

Figure 2-15 Scrolling

### OPTIONAL QUICK POINT FEATURE

The optional Quick Point device consists of a cursor control button at the lower center of the keyboard. It is roughly the same size and shape as a pencil eraser. The cursor control works the same way a mouse ball does, and moves the cursor around the display. It only requires light pressure to move; the more pressure you use, the faster the cursor will move.

The left and right buttons that are located at the top of the Touchpad are designed for use with the Quick Point control, and they function in the same manner as the lower buttons.

When used with the Quick Point button, the middle Touchpad button allows you to scroll up and down a screen.

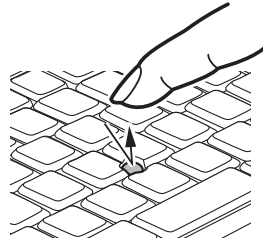
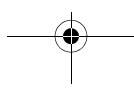
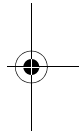
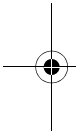
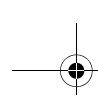

Figure 2-16 Using Quick Point





## Volume Control

Your Fujitsu LifeBook notebook has multiple volume controls which interact with each other.



Any software that contains audio files will also contain a volume control of its own. If you install an external audio device that has an independent volume control, the hardware volume control and the software volume control will interact with each other. It should be noted that if you set your software volume to Off, you will override the external volume control setting.

### CONTROLLING THE VOLUME

The volume can be controlled in several different ways:

- Volume can be changed or muted from within the Volume Control on the Taskbar.
- Volume can be controlled with the F8 and F9 functions keys. Pressing [F8] repeatedly while holding [Fn] will decrease the volume of your notebook. Pressing [F9] repeatedly while holding [Fn] will increase the volume of your notebook.
- Volume can be muted by pressing the [F3] key while holding down the [Fn] key. To restore audio, repeat the [Fn+F3] procedure.
- Volume can be controlled by many volume controls that are set within individual applications.
- Certain external audio devices you might connect to your system may have hardware volume controls.

Each source discussed above puts an upper limit on the volume level that must then be followed by the other sources.

We recommend that you experiment with the various volume controls to discover the optimal sound level.

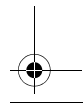
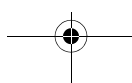
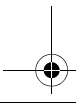
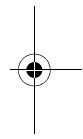
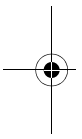

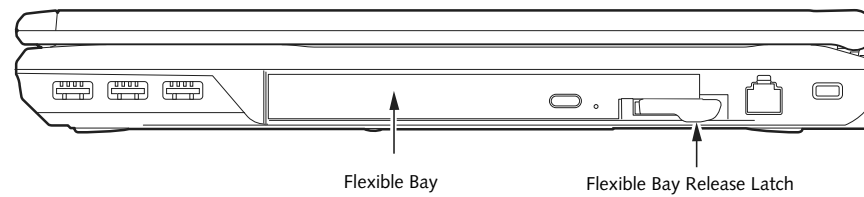

Figure 2-17 Flexible Bay

## Flexible Bay Devices

Your notebook has a Flexible Bay that can house one of several devices. Your Flexible Bay will have one of the following devices installed.

- **Modular Dual-Layer Multi-Format DVD Writer:** This allows you to access movies, software, and audio DVD/CDs and record to DVD, CD, and DVD-RAM discs.
- **Modular DVD/CD-RW combo drive:** This allows you to access movies, software, and audio DVD/CDs as well as to write to CDs.
- **Modular DVD-ROM drive:** This allows you to access software, data, video, or audio discs.
- **Modular Lithium ion battery:** This is a rechargeable battery that can be used to power your LifeBook notebook when an adapter is not connected.
- **Modular Second Hard Disk Drive:** This allows you to store additional data and applications.
- **Weight Saver:** This is used to fill the bay when no device is needed.

### REMOVING AND INSTALLING MODULAR DEVICES

There are two ways to remove and install modular devices in the Flexible Bay:

- **Cold-swapping:** swapping devices while your LifeBook notebook is powered off.
- **Hot-swapping:** swapping devices while your system is active using the Safely Remove Hardware icon from your system tray.



You should never leave your Flexible Bay empty when the notebook is in operation. If left empty, dust or foreign matter may accumulate inside the notebook.

#### Cold-swapping

To cold-swap modular devices in your Flexible Bay follow these easy steps: (Figure 2-18)

1. Close any open files.
2. Shut down your LifeBook notebook.

3. Pull out the Flexible Bay release latch. This will push your device out slightly, allowing you to remove it.
4. Slide your device out until it is clear of the bay. This will require light force.

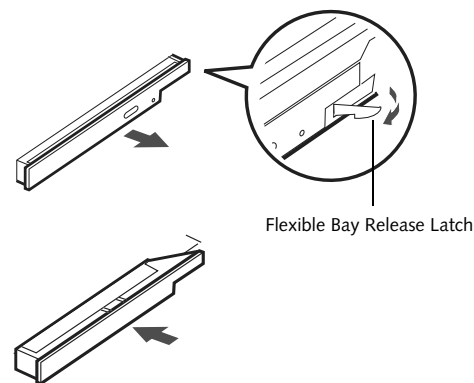

Figure 2-18 Removing/Installing a device in the Flexible Bay



Be careful when aligning and seating devices in the bay. If the fit is incorrect, you may damage the bay or the device. If the device does not move easily in the bay, remove it, and check for dirt or foreign objects. It will require a firm push to latch the device in place.

5. Slide the device you are installing into your notebook until it clicks into place.
6. It is now safe to turn your notebook back on.
7. You can now access and use the device.

Your LifeBook notebook will automatically detect the new device and activate it within your system. The drive letters associated with the device will be created and listed under My Computer and Windows Explorer.

#### Hot-swapping

Under Windows XP, hot-swapping is provided through the Safely Remove Hardware utility.

The icon for the utility appears on the taskbar. Click on the icon and follow the on-screen instructions.

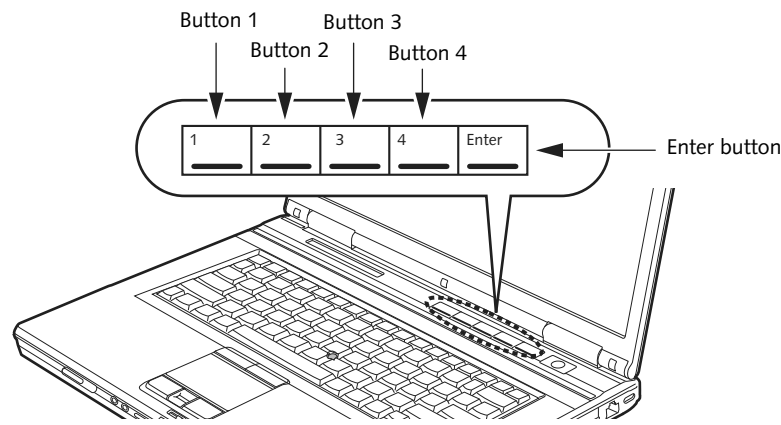

Figure 2-19. LifeBook Security/Application Panel

## LifeBook Security/ Application Panel

A unique feature of your LifeBook notebook is the Security/Application Panel that allows you to secure your notebook from unauthorized use. The Security/Application Panel also allows you to launch applications with the touch of a button when your system is on.

If the security system is activated, upon starting your notebook or resuming from suspend mode the security system requires you to enter a password code using the buttons on the Security/Application Panel. After entering a correct password, your notebook resumes system operation. (Figure 2-19)

### SETTING UP YOUR LIFEBOOK SECURITY PANEL

When you receive your LifeBook notebook, the security panel application is pre-installed without any passwords. The following sections provide detailed information on your security panel, and how to set, change or remove passwords.

#### Numbered Buttons

Use these buttons to enter your password.

#### Enter Button

After entering the button strokes, push this button to enter the password into the LifeBook notebook.

#### PASSWORDS

The user and supervisor password may be set on this notebook. A supervisor password is typically the same for all LifeBook notebooks in a working group, office, or company to allow for system management. Individual LifeBook notebooks in a group environment should not use a common password. A password consists of one to five button strokes plus the [Enter] button. A valid

stroke consists of pushing one or up to four buttons simultaneously. The following are valid button strokes:

- Pushing [4] by itself
- Pushing [2] and [3] at the same time
- Pushing [1], [2], and [4] at the same time
- Pushing [1], [2], [3], and [4] at the same time

The following are valid passwords. The numbers within braces ( { } ) are button strokes using more than one button.

- { [2]+[3] }, [1], [enter]
- [4], [enter]
- { [1]+[3] }, { [2]+[3]+[4] }, [1], [4], [2], [enter]

#### Setting Passwords

When shipped from the factory, no passwords are set. You have a choice of having no password or setting a supervisor and user password. You must set the supervisor password before the user password.



The purpose of supervisor password is to be able to bypass the user password in case the user password is forgotten. The supervisor password alone will not lock the system.

You must set both the supervisor and user passwords for the security panel to work.

#### Setting Supervisor Password

You must have set a supervisor password before setting any user passwords. The supervisor password can bypass the user password. Depending upon your operating system, use the appropriate procedure below.

#### Windows XP:

1. Go to the Start menu.
2. Click on Run.

- Type in:  
C:\Program Files\Fujitsu\Security Panel Application\Supervisor\FJSECS.EXE, then press [Enter]
- Follow the on-screen instructions to set the Supervisor password.

**Windows Vista:**

- Go to the Start menu.
- Select All Programs.
- Select Accessories, then select Run.
- Type in:  
C:\Program Files\Fujitsu\Security Panel Application\Supervisor\FJSECS.EXE, then press [Enter]
- Follow the on-screen instructions to set the Supervisor password.

**Setting User Password****Windows XP:**

- Go to the Start menu.
- Click on Programs.
- Click on Security Panel Application and Set User Password.
- Follow the on-screen instructions to set the user password

**Windows Vista:**

- Go to the Start menu.
- Select All Programs.
- Select Security Panel Application and Set User Password.
- Follow instructions to set the user password.



You may change or remove the supervisor or user password by repeating the steps defined above.

## OPERATING YOUR LIFEBOOK SECURITY/APPLICATION PANEL

The security lock feature is in effect both when the system resumes from Off or suspend state. You will need to enter the user password right after pressing the Suspend/Resume button. Your system will not boot or resume from Standby without entering your supervisor/user password.

**From Off State**

- Turn on your system.
- When the Security Indicator flashes, enter the password and press [Enter] button.

For example, if the password is 22222, press button number [2] five times and press [Enter] button. The notebook will boot to normal operation.

**From Standby State**

- Press your Power/Suspend/Resume button.
- When the Security Indicator flashes, enter the password and press [Enter] button.
- The notebook should resume normal operation.

**Incorrect Password Entry**

If an invalid supervisor or user password is entered three times in succession, the system will “beep” for about one minute. If a valid password is entered within a minute (while system beeps), the beeping will stop and the notebook will resume normal operation. If no password (or an invalid one) is entered while the system beeps, the system will return to its previous locked state (Standby or off) and the Security Indicator will go off. To reactivate the notebook after a password failure, you must press the Power/Suspend/Resume button, then enter a correct password.



Remember the user password you specified on the Security Panel Application. If you forget the password you will not be able to use your computer. The supervisor password can override the user password.

**PRECAUTIONS****Opening and Closing the Cover**

Closing the cover automatically places the notebook into standby mode. Opening the cover does not automatically place the notebook into normal operation. Instead, you must enter the proper security password after pushing the Power/Suspend/Resume button. This setting can be changed in the Power Options Control Panel.

**Low Battery Operations**

If your LifeBook notebook has a low battery, pushing the Power/Suspend/Resume button only turns on the Security Indicator, your notebook does not unlock. The Security Indicator turns off after one minute. To resume normal operation, first attach a power supply to the notebook. Then you may unlock the notebook.

**UNINSTALLING THE SECURITY PANEL APPLICATION**

You have two options when uninstalling the security panel application:

- Uninstall the security panel application software. This will disable all security features.
- Uninstall the security panel application with password still active. This will not allow any changes to the password.

**Uninstalling the Security Panel Application**

Remove passwords when User wants no password protection whatsoever and doesn't want to give anybody

the utility to set a password on their computer. In this case, if passwords (supervisor, user, or both) are set, the passwords must first be cleared BEFORE removing the application. To clear passwords, follow same procedure in "Setting Passwords" except this time, select [Remove], enter current password then click [Next]. When asked to confirm, select [Yes].

#### Removing Security Panel Application with Passwords Still Active

Using this feature will not allow any changes to the password.



Removing the applications does not remove the password. It simply removes the utility to change/add/remove passwords. To change your password you must reinstall the application.

#### User:

1. Go to Start Menu, Click on Control Panel.
2. Open **Add or Remove Programs** (In Vista: **Programs and Features**) in the Control Panel.
3. Select the **Security Panel Application** (In Vista: **Security Panel**) in the list, and click **Add/Remove**.
4. When the Confirm File Deletion box appears, click **Yes**.

#### Supervisor:

1. Go to Start Menu, Click on Control Panel.
2. Open **Add or Remove Programs** (In Vista: **Programs and Features**) in the Control Panel.
3. Select the **Security Panel Application for Supervisor** (In Vista: **Security Panel for Supervisor**) in the list, and click **Add/Remove** (In Vista: **Uninstall**).
4. When the Confirm File Deletion box appears, click **Yes**.

#### Reinstalling the Security/Application Panel

To reinstall supervisor or user security application, you will need your Drivers and Applications CD. The **Utilities/Security Application Panel** folder contains two separate folders: **Supervisor** and **User**. The setup files for supervisor and user security applications are contained in those folders.

1. Go to the **Utilities/Security Application Panel/Supervisor** folder on the CD and double-click the **setupS.exe** file. (In Vista, the path is: **Utilities/SAP/Vista/Supervisor/SetupS.exe**). The Installing Security Panel Application window will appear. Follow the instructions on the screen.
2. Go to the **Utilities/Security Application Panel/User** folder on the CD and double-click the **setup.exe** file. (In Vista, the path is: **Utilities/SAP/Vista/Setup.exe**) The Installing Security Panel Application

window will appear. Follow the instructions on the screen.

Supervisor and user passwords can be set via Windows software using the FJSECS.exe and FJSECU.exe files, respectively. FJSECU.exe for the user password cannot run without first setting a supervisor password. You need to run FJSECS.exe first to set the supervisor password. Follow instructions under Setting Passwords on page 20.

If you forget both passwords, contact Fujitsu Computer Systems Corporation Service and Support at 1-800-8FUJITSU (1-800-838-5487). Fujitsu Computer Systems Corporation charges a service fee for unlocking a password restricted LifeBook notebook. When calling please have a valid credit card and provide proof of ownership. You will then be given instructions on where to ship your notebook.

#### LAUNCHING APPLICATIONS WITH THE SECURITY/APPLICATION PANEL

When you start Windows, the LifeBook Application Panel is automatically activated. As an application launcher, the LifeBook Application Panel is very flexible, giving you a variety of options. To set up the Panel to best suit your needs, we have provided the Application Panel Setup utility that quickly and easily helps you make the most of this valuable feature.

#### Configuring your LifeBook Application Panel

When you start Windows, the LifeBook Application Panel is automatically activated. An icon resembling a finger pressing a button will appear on the system tray (the indented portion of the status bar where the clock is displayed). When you see this icon you will know that LifeBook Application Panel is active.

As an application launcher, the LifeBook Application Panel is very flexible, giving you a variety of options. To set up the Panel to best suit your needs, we have provided the Application Panel Setup utility that quickly and easily helps you make the most of this valuable feature.

#### To configure your LifeBook Application Panel with Application Panel Setup:

1. Click on [Start].
2. Click on Programs.
3. Click on LifeBook Application Panel.
4. Click on Application Panel Setup. The Application Panel Setup utility will appear. There are tabs that correspond to the application buttons on the LifeBook Application Panel. When you receive your notebook, these buttons are pre-configured to launch specific programs, as referenced in the specifications section of this document.



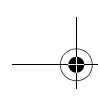

The tabs in Application Panel Setup may not be in the same order as the buttons on your LifeBook notebook, please select the tab you wish to change carefully.

To change an application associated with the Application buttons, click on the tab for the button you would like to reconfigure – for example, Application A. Click on Browse from Start Menu, scroll down the list of applications, click on the application you wish to launch with this button, and then click OK. The button will now launch the new application.

The Internet tab is different. It comes set to launch your Windows default Internet browser (Internet Explorer), unless you have changed this in Windows. In order to reconfigure it to launch another program follow these easy steps:

1. Click on **Other** from the Internet browser box.
2. Click on **Browse** from Start Menu.
3. Scroll down the list of applications, and then click on the application you wish to launch with this button.
4. Click **OK**.

The button will now launch the new application. If you want to return to launching your Windows default Internet browser with this button, you need only click on “Default Internet Browser” from the Internet browser box. Be aware that you will erase the settings for the “other application”. If you wish to go back to launching the “other application” from this button, you will need to reconfigure it as described above.



If your system has dedicated one of the application launcher buttons to be an Internet launcher, the button can still be configured to launch any application you wish, not just an Internet browser.

When you have finished with Application Panel Setup click OK, and the new settings will take effect. You can reconfigure your LifeBook Application Panel as often as you like.

#### Deactivating and Activating the LifeBook Application Panel

To deactivate the LifeBook Application Panel, follow these easy steps:

1. Click on **Start**.
2. Click on **Programs**.
3. Click on **LifeBook Application Panel**.
4. Click on **Stop Application Panel**.

To reactivate, follow the same procedure, except for step 4. Click on **Activate Panel** instead.



Every time you start Windows the LifeBook Application Panel is activated, even if you deactivated it before you shut down.

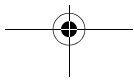
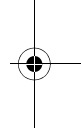
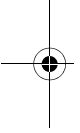

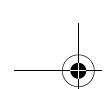

*LifeBook E8000 Notebook*

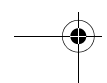
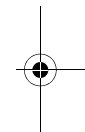
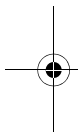

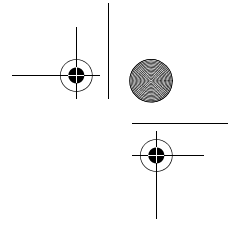
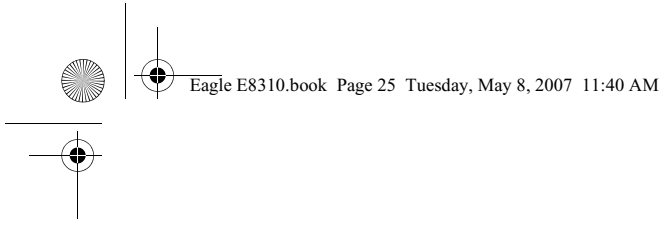

# 3 Getting Started

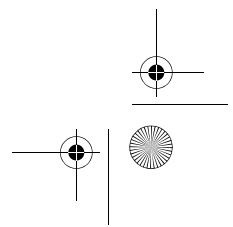
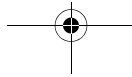
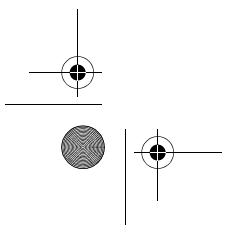
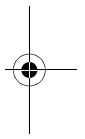
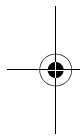

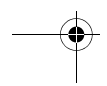
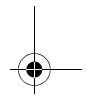
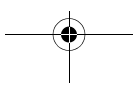
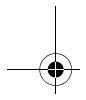
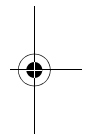
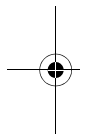
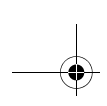

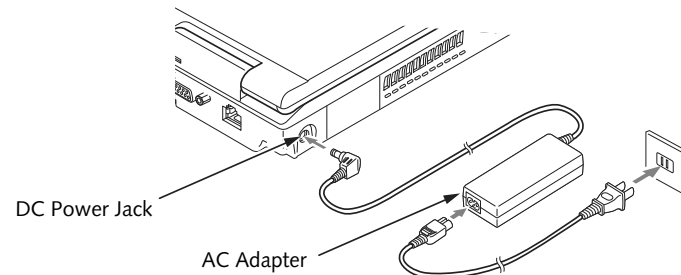
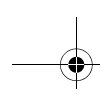

Figure 3-1 Connecting the AC Adapter

## Power Sources

Your Fujitsu LifeBook notebook has three possible power sources: a primary Lithium ion battery, an AC adapter or an optional Auto/Airline adapter.

### CONNECTING THE POWER ADAPTERS

The AC adapter or optional Auto/Airline adapter provides power for operating your notebook and charging the batteries.

#### Connecting the AC Adapter

1. Plug the DC output cable into the DC power jack of your LifeBook notebook.
2. Plug the AC adapter into an AC electrical outlet. (Figure 3-1)

#### Connecting the Optional Auto/Airline Adapter

1. Plug the DC output cable into the DC power jack on your notebook.

2. Plug the Auto/Airline adapter into the cigarette lighter of an automobile with the ignition key in the On or Accessories position.  
OR
3. Plug the Auto/Airline adapter into the DC power jack on an airplane seat.

#### Switching from AC Adapter Power or the Auto/Airline Adapter to Battery Power

1. Be sure that you have at least one charged battery installed.
2. Remove the AC adapter or the Auto/Airline adapter.



The Lithium ion battery is not charged upon purchase. Initially, you will need to connect either the AC adapter or the Auto/Airline adapter to use your notebook.

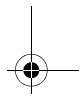
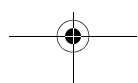
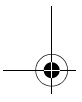
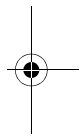
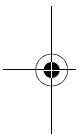

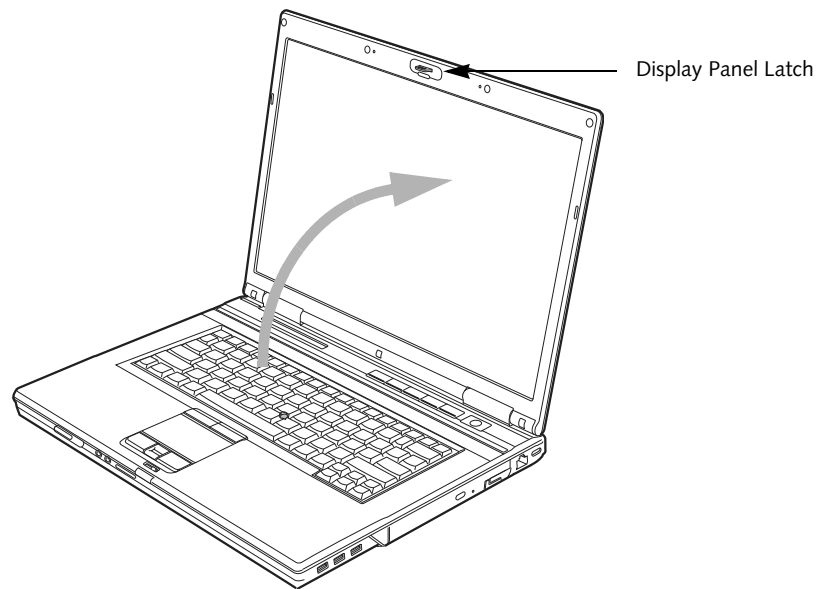
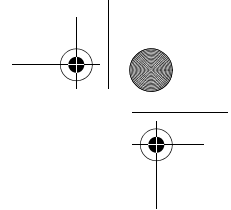

Figure 3-2 Opening the Display Panel

## Display Panel

Your Fujitsu LifeBook notebook contains a display panel that is backlit for easier viewing in bright environments and maintains top resolution through the use of active-matrix technology.

### OPENING THE DISPLAY PANEL

1. Press the Display Panel latch in. This releases the locking mechanism, allowing you to raise the display.
2. Lift the display backwards, being careful not to touch the screen, until it is at a comfortable viewing angle. (Figure 3-2)

### ADJUSTING DISPLAY PANEL BRIGHTNESS

Once you have turned on your LifeBook notebook, you may want to adjust the brightness level of the screen to a more comfortable viewing level. There are two ways to adjust the brightness, by using the keyboard or the power management utility.

#### Using the Keyboard

Adjusting the brightness using the keyboard changes the setting only temporarily.

- [Fn+F6]: Pressing repeatedly will lower the brightness of your display.
- [Fn+F7]: Pressing repeatedly will increase the brightness of the display.

- 
- When using AC power your brightness setting is set to its highest level by default. When using battery power your brightness setting is set to approximately mid-level by default.
  - The higher the brightness level, the more power the notebook will consume and the faster your batteries will discharge. For maximum battery life, make sure that the brightness is set as low as possible.
- 



### CLOSING THE DISPLAY PANEL

1. Holding the edge of your display panel, pull it forward until it is flush with the body of your LifeBook notebook.
2. Push down until you hear a click. This will engage the locking mechanism and prevent your display panel from opening unexpectedly.

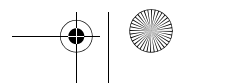
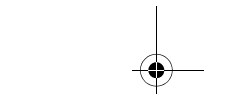
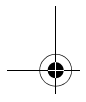

## Starting Your LifeBook Notebook

### POWER ON

#### Power/Suspend/Resume Button

The Power/Suspend/Resume button is used to turn on your LifeBook notebook from its off state. Once you have connected your AC adapter or charged the internal Lithium ion battery, you can power on your LifeBook notebook.



When you turn on your LifeBook notebook be sure you have a power source. This means that at least one battery is installed and charged, or that the AC or Auto/Airline adapter is connected and has power.

To turn on your LifeBook notebook from its off state, press the Power/Suspend/Resume button, located above the keyboard to the right. When you are done working you can either leave your notebook in Standby mode, (See *Standby Mode on page 32 for more information*), or you can turn it off (See *Powering Off on page 33 for more information*)



Do not carry your LifeBook notebook around with the power on or subject it to shocks or vibration, as you risk damaging your notebook.

When you power on your LifeBook, it will perform a Power On Self Test (POST) to check the internal parts and configuration for correct functionality. If a fault is found, your LifeBook notebook will emit an audio warning and/or an error message will be displayed. (See *Power On Self Test Messages on page 59 for more information*) Depending on the nature of the problem, you may be able to continue by starting the operating system or by entering the BIOS setup utility and revising the settings.

After satisfactory completion of the POST, your notebook will load your operating system.



Never turn off your LifeBook notebook during the Power On Self Test (POST) or it will cause an error message to be displayed when you turn your LifeBook notebook on the next time. (See *Power On Self Test Messages on page 59 for more information*)

### BOOT SEQUENCE

The procedure for starting-up your notebook is termed the Bootup sequence and involves your notebook's BIOS. When your LifeBook notebook is first turned on, the main system memory is empty, and it needs to find instructions to start up your notebook. This information is in the BIOS program. Each time you power up or restart your notebook, it goes through a boot sequence which displays a Fujitsu logo until your operating system is loaded. During booting, your notebook is performing a standard boot sequence including a Power On Self Test (POST). When the boot sequence is completed without a failure and without a request for the BIOS Setup Utility, the system displays the operating system's opening screen.

The boot sequence is executed when:

- You turn on the power to your LifeBook notebook.
- You restart your notebook from the Windows Shut Down dialog box.
- The software initiates a system restart.  
Example: When you install a new application.

### HARD DISK DRIVE PASSWORDS

To provide additional security for your data, you can assign passwords to your hard disk drive(s). This feature is managed in the system BIOS Setup Utility. See *BIOS Setup Utility* below for information about accessing the utility.



**Remember your passwords.** If you set and forget your User and Master hard disk passwords, Fujitsu Computer Systems Corporation will not be able to reset it. You may lose data and have to replace your system board or hard disk drive.

### BIOS SETUP UTILITY

The BIOS Setup Utility is a program that sets up the operating environment for your LifeBook notebook. Your BIOS is set at the factory for normal operating conditions, therefore there is no need to set or change the BIOS' environment to operate your notebook.

The BIOS Setup Utility configures:

- Device control feature parameters, such as changing I/O addresses and boot devices.
- System Data Security feature parameters, such as passwords.

#### Entering the BIOS Setup Utility

To enter the BIOS Setup Utility do the following (or use the TrustedCore Menu, as detailed in the next section):

1. Turn on or restart your LifeBook notebook.

2. To enter the BIOS Setup Utility, press the [F2] key once the Fujitsu logo appears on the screen. This will open the main menu of the BIOS Setup Utility with the current settings displayed.
3. Press the [RIGHT ARROW] or [LEFT ARROW] key to scroll through the other setup menus to review or alter the current settings.

#### Using the TrustedCore Menu

When the Fujitsu logo appears on the screen, press the [Enter] key or click on the left mouse or touchpad button; the TrustedCore Menu will appear.

The TrustedCore Menu provides shortcuts to the following menus and information screens:

- BIOS Setup
- Diagnostic Screen
- Boot Menu
- Patent Information
- System Information
- Continue Booting

Clicking on any of the fields will invoke the screen, information, or action described.

The Boot Menu can also be invoked by pressing the [F12] key when the Fujitsu logo appears on the screen.

#### BIOS Guide

A guide to your notebook's BIOS is available online. Please visit our service and support website at <http://www.computers.us.fujitsu.com/support>, then select Users Guides under Online Support. Select your product, series, and model, then press [Go].



The bottom of this notebook computer can become hot when used for long periods of time. When using the notebook, take caution to limit long term or continuous use while resting it on exposed skin, such as the lap.

#### BOOTING THE SYSTEM

We strongly recommend that you not attach any external devices and do not put a DVD/CD in your drive until you have gone through the initial power on sequence.

When you turn on your notebook for the first time, it will display a Fujitsu logo on the screen. If you do nothing the system will load the operating system, and then the Windows Welcome will begin.

Depending upon your operating system (Windows Vista or XP edition), there is a different procedure for starting your system for the first time, as outlined below.

#### STARTING WINDOWS VISTA THE FIRST TIME



**The first time you initialize your Windows Vista system, the screen will be blank for approximately two minutes.** This is normal. After initialization, a "Set Up Windows" dialog box will appear.

**Important:** During the setup procedure, do not disconnect the power supply, press any buttons, or use any peripheral devices such as a mouse, keyboard, or remote control.

In order to ensure that you receive the most benefits from the Windows Vista operating system, it should be registered the first time you use it.

1. First of all, you will need to read and accept the End User License Agreements (EULAs).



- If you reject the terms of the license agreement you will be asked to review the license agreement for information on returning Windows or to shut down your LifeBook notebook.
- You cannot use your notebook until you have accepted the License Agreement. If you stop the process your notebook will return to the beginning of the Windows Welcome Process, even if you shut your notebook down and start it up again.

2. You will be prompted to enter your User Name and Password and you will be given a chance to select an icon for your account.
3. The next screen asks for a Computer Name and allows you to choose a desktop background.
4. You will next see a "Help protect Windows automatically" screen in which the default choice is "Use recommended settings". The other two choices are "Install important updates only" and "Ask me later". Select from the three choices.
5. On the next screen set your time and date settings.
6. You will next see the "Select your computer's current location" screen. Make your selection from Home, Work (Default), and Public location.
7. The "Thank you" screen follows and an offer for free Norton Internet Security is extended. Following are several screens while Windows checks the system performance.
8. Windows will then boot up for the first time. As noted above, the first time you initialize your Windows Vista system, the screen will be blank for approximately two minutes. This is normal. During this period, do not disconnect the power supply,



## Getting Started

press any buttons, or use any peripheral devices such as mouse, keyboard, or remote control.

### Registering Windows Vista with Microsoft

1. After Windows has booted up for the first time, the Control Panel Welcome Center will appear. If the Register Windows Online icon is not seen in the window, click on "Show all 14 items".
2. Click on Register Windows Online and follow the instructions that appear to register your copy of Windows.

### STARTING WINDOWS XP THE FIRST TIME

#### Registering Windows XP with Microsoft

In order to ensure that you receive the most benefits from the Windows operating system, it should be registered the first time you use it.

After you receive the Windows Welcome screen, you will be prompted to enter registration information in the following order.

First of all, you will need to read and accept the End User License Agreements (EULAs). After accepting the EULAs, you will be asked if you want to enable the Automatic Updates feature. Acceptance of this feature is recommended because it allows your system to be updated automatically whenever an important change becomes available for your notebook.



- If you reject the terms of the license agreement you will be asked to review the license agreement for information on returning Windows or to shut down your LifeBook notebook.
- You cannot use your notebook until you have accepted the License Agreement. If you stop the process your notebook will return to the beginning of the Windows Welcome Process, even if you shut your notebook down and start it up again.

Several additional windows will appear, prompting you to enter a name and description for your computer, an Administrator password, and a domain name. Read the instructions on the screens carefully and fill in the information as directed.

You will then be automatically connected to the Internet, if you have an appropriate connection available. If an automatic connection is not possible, you will be asked about how you dial out from where you will be using your LifeBook notebook. If you are not connected to a phone line and plan to register at a later time, you may click the **Skip** button.

Once you are connected to the Internet, you will be asked if you wish to continue with the registration. If you select **Yes** you will then enter your name and

address, and email address if desired. Click **Next** to complete registration.

### REGISTERING YOUR LIFEBOOK NOTEBOOK

You can register your LifeBook by going to our website at: [us.fujitsu.com/computers](http://us.fujitsu.com/computers)

You will need to be set up with an Internet Service Provider (ISP) to register online.

### INSTALLING CLICK ME!



Before installing the ClickMe! utility, be sure the wireless LAN switch is turned on.

### Windows Vista Systems

The first time you boot up your system, you will see a "Primary Settings for the PC" window. This window explains the installations which will be performed by the Click Me! utility. If you click [Execute], Click Me! will begin installing. If after clicking the button you receive a "User Account Control" window, you will be asked for your permission to continue. Click [Yes] to continue. If you cancel the operation, the Click Me! icon will appear on your desktop for later installation.

### Windows XP Systems

The first time you boot up your system, you will see an icon called Click Me! in the Start menu. **We highly recommend that you install the ClickMe! utility the first time you boot up.** When you click the Click Me! icon, your system will automatically create the related icons in the system tray in the bottom right of the screen. These icons provide links to utilities that you will frequently access, such as wireless LAN software provided by the wireless LAN manufacturer.



There may be additional third-party applications that are installed by the ClickMe! utility. For more information, refer to your Getting Started Guide.

### FUJITSU DRIVER UPDATE UTILITY

Your system has a convenient tool called the Fujitsu Driver Update (FDU) utility. With FDU, you can choose to automatically or manually go to the Fujitsu site to check for new updates for your system. For more information about the FDU utility, refer to "Automatically Downloading Driver Updates" on page 83.

## Power Management

Your Fujitsu LifeBook notebook has many options and features for conserving battery power. Some of these features are automatic and need no user intervention, such as those for the internal modem. However, others depend on the parameters you set to best suit your operating conditions, such as those for the display brightness. Internal power management for your notebook may be controlled from settings made in your operating system, pre-bundled power management application, or from settings made in BIOS setup utility.

Besides the options available for conserving battery power, there are also some things that you can do to prevent your battery from running down as quickly. For example, you can create an appropriate power saving profile, put your notebook into Standby mode when it is not performing an operation, and you can limit the use of high power devices. As with all mobile, battery powered computers, there is a trade-off between performance and power savings.

### POWER/SUSPEND/RESUME BUTTON

When your notebook is active, the Power/Suspend/Resume button can be used to manually put the notebook into Standby mode. Push the Power/Suspend/Resume button when the notebook is active, but not actively accessing anything, and immediately release the button. You will hear two short beeps and the system will enter Standby mode.

If your notebook is suspended, pushing the Power/Suspend/Resume button returns your notebook to active operation. You can tell whether the system is suspended by looking at the Power indicator. If the indicator is visible and not flashing, your notebook is fully operational. If the indicator is visible *and* flashing, your notebook is in Standby mode. If the indicator is not visible, the power is off or your notebook is in Hibernation mode. (See *Hibernation Feature*)

### STANDBY MODE

Standby (or Suspend) mode in Windows saves the contents of your system memory during periods of inactivity by maintaining power to critical parts. This mode turns off the CPU, display, hard drive, and all other internal components except those necessary to maintain system memory and for restarting.

- Your notebook can be put in Standby mode by:
  - Pressing the Power/Suspend/Resume button when your system is turned on.
  - Selecting Standby from the Windows Shut Down menu.
  - Timing out from lack of activity.

- Allowing the battery to reach the Dead Battery Warning condition.

Your notebook's system memory typically stores the file on which you are working, open application information, and any other data required to support operations in progress. When you resume operation from Standby mode, your notebook will return to the point where it left off. You must use the Power/Suspend/Resume button to resume operation, and there must be an adequate power source available, or your notebook will not resume.

- If you are running your notebook on battery power, be aware that the battery continues to discharge while your notebook is in Suspend mode, though not as fast as when fully operational.
- Disabling the Power/Suspend/Resume button prevents it from being used to put the notebook into Standby or Hibernation (Save-to-Disk) mode. The button resume function cannot be disabled.
- The Standby or Hibernation (Save-to-Disk) mode should not be used with certain PC Cards. Check your PC Card documentation for more information. When PC Cards or external devices are in use, Hibernation (Save-to-Disk) mode cannot return to the exact state prior to suspension, because all of the peripheral devices will be re-initialized when the system restarts.
- If your notebook is actively accessing information when you enter the Standby or Hibernation (Save-to-Disk) mode, changes to open files are not lost. The files are left open and memory is kept active during Standby mode or the memory is transferred to the internal hard drive during Hibernation mode.

The main advantage of using Hibernation (Save-to-Disk) is that power is not required to maintain your data. This is particularly important if you will be leaving your notebook in a suspended state for a prolonged period of time. The drawback of using Hibernation mode is that it lengthens the power down and power up sequences and resets peripheral devices.



### HIBERNATION (SAVE-TO-DISK) FEATURE

The Hibernation feature saves your system's memory contents to the hard drive as a part of the Suspend/Resume mode. You can enable or disable this feature.

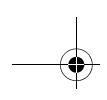

### Enable or Disable the Hibernation Feature

#### Windows Vista:

The default settings are not enabled. To enable or disable the Hibernation feature follow these steps:

1. From the **Start** menu, select **Control Panel**, then select **Power Options**.
2. Select “Choose what the power button does” or “Choose what closing the lid does”, then make your selections (Do Nothing, Sleep, Hibernate, or Shut Down).

#### Windows XP:

The default settings are not enabled. To enable or disable the Hibernation feature follow these steps:

1. From the **Start** menu, select **Settings**, and then select **Control Panel**.
2. From the **Control Panel** select **Power Options**.
3. Select the **Hibernate** tab. Select the box to enable or disable this feature.

### WINDOWS POWER MANAGEMENT

The Power Options icon located in the Windows Control Panel allows you to configure some of the power management settings. For example, you can use the Power Options to set timeout values to turn off the display and hard disks whether you are running the notebook on battery power or on an adapter.

### RESTARTING THE SYSTEM

If your system is on and you need to restart it, be sure that you use the following procedure.

#### Windows Vista:

1. Click the **Start** button, and then move the mouse over the right arrow.
2. Select **Restart** from the list.

#### Windows XP:

1. Click the **Start** button, and then click **Shut Down**.
2. Select the **Restart** option from within the Windows Shut Down dialog box.
3. Click **OK** to restart your notebook. Your notebook will shut down and then reboot.



Turning off your notebook without exiting Windows, or turning it on within 10 seconds of being shut off may cause an error when you start the next time.

### POWERING OFF

Before turning off the power, check that the hard drive/optical drive access indicator is off. If you turn off the power while accessing a disk there is a risk of data loss. To ensure that your notebook shuts down without error, use the Windows shut down procedure.



Be sure to close all files, exit all applications, and shut down your operating system prior to turning off the power. If files are open when you turn the power off, you will lose any changes that have not been saved, and may cause disk errors.

Using the correct procedure to shut down from Windows allows your notebook to complete its operations and turn off power in the proper sequence to avoid errors. The proper sequence is:

1. Click the [Start] button, and then click [Shut Down].
2. Select the Shut Down option from within the Windows Shut Down dialog box. (In Vista, select the small arrow at the bottom right of the menu, then select Shut Down.)
3. Click [OK] to shut down your notebook.

If you are going to store your notebook for a month or more see Care and Maintenance Section.

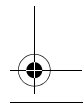
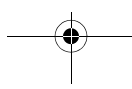
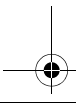
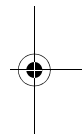
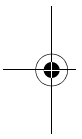

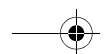
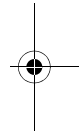
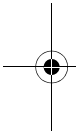
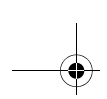

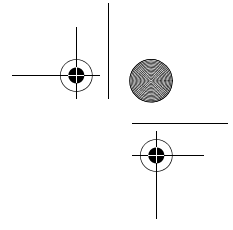
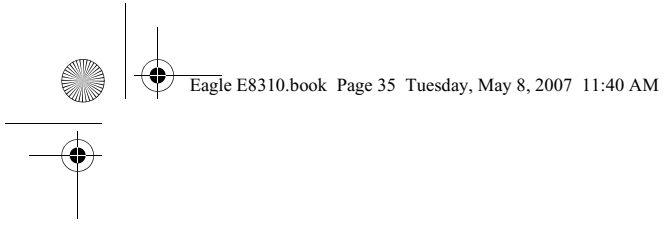

# 4

## User-Installable Features

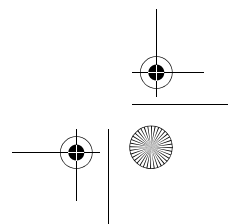
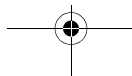
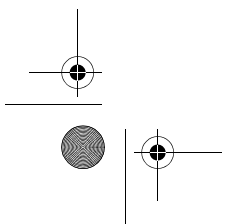
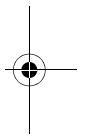
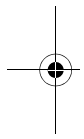

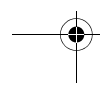
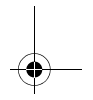
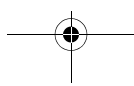
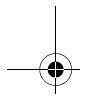
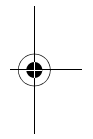
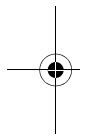
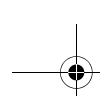

## Lithium ion Battery

Your LifeBook notebook has a Lithium ion battery that provides power for operating your notebook when no external power source is available. The battery is durable and long lasting, but should not be exposed to extreme temperatures, high voltages, chemicals or other hazards.

The Lithium ion battery operating time may become shorter if it is used under the following conditions:

- When used at temperatures that exceeds a low of 5°C or a high of 35°C. Extreme temperatures not only reduce charging efficiency, but can also cause battery deterioration. The Charging icon on the Status Indicator panel will flash when you try to charge a battery that is outside its operating temperature range. (See *Battery Charging Indicators on page 13 for more information*)
- When using a high current device such as a modem, Multi-Format DVD Writer, CD-ROM drive, DVD/CD-RW combo drive, or the hard drive, using the AC adapter will conserve your battery life.



Do not leave a faulty battery in your LifeBook notebook. It may damage your AC adapter, optional Auto/Airline adapter, another battery or your notebook itself. It may also prevent operation of your notebook by draining all available current into the bad battery.



- Actual battery life will vary based on screen brightness, applications, features, power management settings, battery condition and other customer preferences. CD-ROM drive, Multi-Format DVD Writer, DVD/CD-RW drive combo, or hard drive usage may also have a significant impact on battery life. The battery charging capacity is reduced as the battery ages. If your battery is running low quickly, you should replace it with a new one.
- Under federal, state, or local law it may be illegal to dispose of batteries by putting them in the trash. Please take care of our environment and dispose of batteries properly. Check with your local government authority for details regarding recycling or disposing of old batteries. If you cannot find this information elsewhere, contact your support representative at 1-800-8FUJITSU (1-800-838-5487)

## RECHARGING THE BATTERIES

If you want to know the condition of the primary Lithium ion battery, check the Battery Level indicator located on the Status Indicator panel. The indicator changes as the battery level changes.

The Lithium ion battery is recharged internally using the AC adapter or Auto/Airline adapter. To recharge the battery make sure the battery that needs to be charged is installed in your LifeBook notebook and connect the AC or Auto/Airline adapter.



Make sure that the Battery Charging indicator and the percentage charge is shown inside the Battery Level icon on the Status Indicator Panel.

There is no memory effect on the Lithium ion battery therefore you do not need to discharge the battery completely before recharging. The charge times will be significantly longer if your notebook is in use while the battery is charging. If you want to charge the battery more quickly, put your notebook into Suspend mode, or turn it off while the adapter is charging the battery. (See *Power Management on page 32 for more information on Standby mode and shutdown procedure*)



Using heavy current devices such as the modem or frequent DVD/CD-RW/CD-ROM accesses may prevent charging completely.

## Low Battery State

When the battery is running low, a low battery notification message will appear. If you do not respond to the low battery message, the batteries will continue to discharge until they are too low to operate. When this happens, your notebook will go into Standby mode. There is no guarantee that your data will be saved once the notebook reaches this point.



- Once the low battery notification message appears, you need to save all your active data and put your LifeBook notebook into Standby mode until you can provide a new power source. You should provide a charged battery, an AC power adapter, or Auto/Airline adapter as soon as possible.
- When you are in Standby mode there must always be at least one power source active. If you remove all power sources while your LifeBook notebook is in Standby mode, any data that has not been saved to the hard drive will be lost.

Dead Battery Suspend mode shows on the Status indicator just like the normal Standby mode. Once your notebook goes into Dead Battery Suspend mode you will be unable to resume operation until you provide a source of power either from an adapter, or a charged battery. Once you have provided power, you will need to press the Power/Suspend/Resume button to resume operation.

In the Dead Battery Suspend mode, your data can be maintained for some time, but if a power source is not provided promptly, the Power indicator will stop flashing and go out, meaning that you have lost the data that was not stored. Once you provide power, you can continue to use your notebook while an adapter is charging the battery.

#### Shorted Batteries

The Status Indicator panel uses a symbol inside the battery outline of the Battery Level indicator to display the operating level available in that battery. If this display shows a Shorted Battery, it means the battery is damaged and must be replaced so it does not damage other parts of your LifeBook notebook.

### REPLACING THE BATTERY

With the purchase of an additional battery, you can have a fully charged spare to swap with one that is not charged. There are two ways to swap batteries, cold-swapping and hot-swapping:

#### Cold-swapping Batteries

To cold-swap batteries in your battery bay follow these easy steps: (Figure 4-1)

1. Have a charged battery ready to install.
2. Shut down your notebook and disconnect the AC adapter.
3. While pushing the battery lock away from the battery pack, slide the battery release button towards the battery lock. While holding the battery lock button, lift the battery out of the bay using the orange notch next to the battery release button.
4. Insert a new battery into the bay, and press it down so that the latches click into place.
5. Plug in the AC adapter and turn the power on.

#### Hot-swapping Batteries

To hot-swap batteries in your battery bay follow these easy steps: (Figure 4-1)



**Be sure to plug in an AC Adapter prior to removing the battery.** There is no bridge battery present to support the system while the battery is being replaced. If you do not use an AC Adapter you will lose any unsaved files.

1. Plug an AC Adapter into the system and connect it to a power outlet.

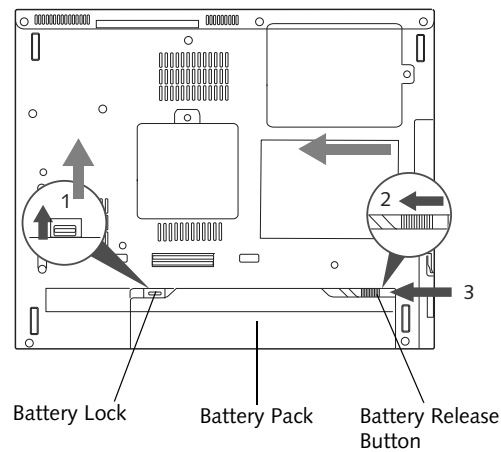

Figure 4-1. Removing a Battery

2. Follow steps 3 through 6 in "Cold Swapping Batteries".



If the Lithium ion battery connector is not fully seated, you may not be able to use your notebook or charge your battery.



## User Installable Features

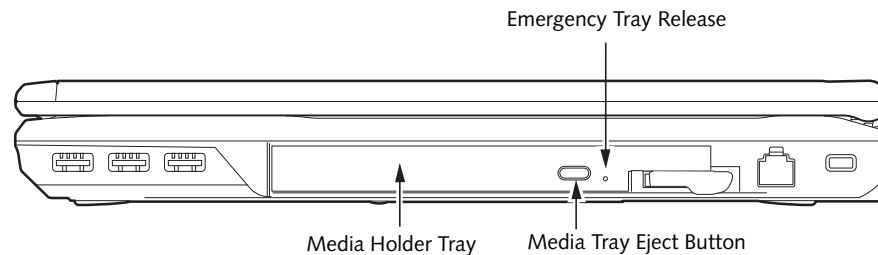

Figure 4-2. Optical Drive

## Optical Drive

There is a variety of media available to use with your system, depending upon the system configuration you have selected. Multi-Format DVD Writers, DVD/CD-RW Combo drives, and DVD-ROM drives are collectively known as “optical drives”.

DVD-R and DVD-RW discs hold up to 4.7 GB of data (DVD-R discs used with Multi-Format Dual-Layer DVD writer hold up to 8.5 GB). A DVD-R disc can only be written to once; DVD-RW discs can be written to over and over. DVD-R and DVD-RW discs can be played on most standard players.

CD-R and CD-RW discs hold up to 640 MB of data. A CD-R disc can only be written to once; CD-RW discs can be written to over and over.

Depending upon your notebook configuration, you may have one of the following optical drives:

- **DVD/CD-RW combo:** A DVD/CD-RW combo drive allows you to access movie, software, data, or audio DVD/CDs, and to write data onto recordable CD-R and CD-RW discs.
- **Dual-Layer Multi-Format DVD Writer:** Allows you to access movies, software, and audio DVD/CDs as well as read and write to CD-R, CD-RW, DVD-R, DVD+R, DVD-RW, DVD+RW, and DVD RAM discs. Dual-layer architecture allows you to record up to 8.5 GB on DVD+R discs.
- **DVD-ROM:** A DVD-ROM drive allows you to access software, data, or audio from CDs or DVDs.



Install your media player software before first using the DVD, DVD/CD-RW, or CD-ROM media drives. Refer to the applicable readme file on the Driver Applications CD-ROM.

### MEDIA PLAYER SOFTWARE

*Dual-Layer Multi-Format DVD Writer model only:* With the Dual-Layer Multi-Format DVD Writer and media player software you can play DVD movies and music CDs on your LifeBook notebook. The media player includes controls which allow you to take full advantage of the features of a DVD movie, as well as standard features such as fast forward, fast reverse, pause, etc. With this drive you can also burn onto recordable DVD-R/RW, DVD+R/RW, or CD-R/RW discs.

*DVD/CD-RW Combo model only:* With the combo drive, you can play DVD movies, read audio CDs, and write data onto recordable CD-R or CD-RW discs.

*DVD-ROM model only:* With the DVD-ROM drive, you can read software, audio, or data from CD or DVD discs.



- Do not operate your optical drive unless your LifeBook notebook is sitting on a flat surface. Using a drive when the system is not level may damage the drive or prevent proper operation.
- Prolonged use of the optical drive, such as watching a DVD movie, will substantially reduce your battery life if no other power source is attached.

### LOADING MEDIA ON YOUR DRIVE

To load a disc into your optical drive:

1. Push and release the eject button on the front of the optical drive to open the holder tray. The tray will come out of the LifeBook notebook a short distance.
2. Gently pull the tray out until a media disc can easily be placed in the tray.
3. Place the media into the tray, label side up, with the hole in the center of the disc. Snap the disc onto the raised circle in the center of the tray.
4. Gently push the holder tray back in until you hear a click. (Figure 4-3)



- If you have disabled the Auto Insert Notification Function, you will have to start the drive from your desktop, since your LifeBook notebook will not automatically recognize that media has been loaded.
- You should periodically check the Fujitsu website at [us.fujitsu.com/computers](http://us.fujitsu.com/computers) for the most current drivers.
- All LifeBook DVD players are set to play DVD titles with region code number 1 which is specified for the North American market. The region number is a regional restriction code defined by the DVD Forum acting on Hollywood requirements. Different region codes are recorded on video DVD titles for publication in different areas of the world. If the regional code of the DVD player does not match the regional codes on the titles, then playback is impossible.
- You can change the region code on the DVD player using the Properties menu of the DVD software. Note, however, that **you can only change the region code up to four times.** After the fourth change, the last region code entered becomes permanent, and cannot be changed.

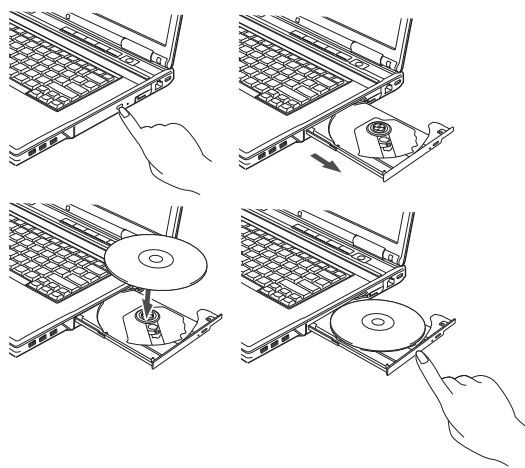

Figure 4-3. Loading/Ejecting Media

#### REMOVING MEDIA

1. Push and release the eject button on the front of the optical drive. This will stop the drive and the holder tray will come out of the LifeBook notebook a short distance.
2. Gently pull the tray out until the disc can easily be removed from the tray.

3. Carefully remove the media disc from the holder tray.
4. Gently push the holder tray back in until you hear a click.

#### EMERGENCY OPTICAL DRIVE TRAY RELEASE

If for some reason the eject button fails, you can open the media tray with a paper clip or similar tool inserted into the eject hole in the right side of the front of the tray (Figure 4-4). Straighten one side of a paper clip and push it gently into the hole. The tray will pop out.

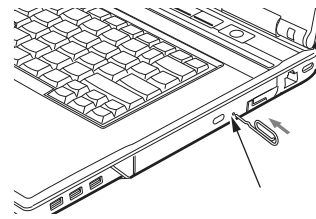

Figure 4-4 Emergency Tray Release

#### USING THE MEDIA PLAYER SOFTWARE



Depending upon its configuration, your system may not have the media player software pre-installed. If it is not installed, reference the documentation that accompanies the media application.

#### Starting a DVD Movie (DVD Models only)

1. Insert the DVD into the optical drive of the notebook. If the CD AutoRun feature activates, skip Step 2.
2. The first time you insert a movie into the DVD/CD-RW tray, you will be prompted to select what you want the system to do when discs are inserted (e.g., start automatically or wait for a prompt). Until you make a selection, you will receive the same prompt whenever you insert a disc.
3. Click OK to close the About DVD Player Performance dialog box and the movie will begin.

#### Opening the Media Player Control Panel

With most DVD-ROMs, you have the option of altering how the movie should play and what you wish to view. You can do this by using the media player control panel and the mouse.

1. Right-click on the movie screen to open a dropdown menu for options.

## Memory Stick/SD Card

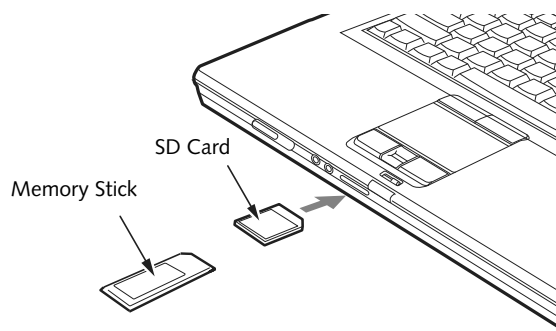

Figure 4-5. Inserting a Memory Stick/SD Card

## Memory Stick/ Secure Digital Cards

Your LifeBook notebook supports Memory Sticks and Secure Digital (SD) cards, on which you can store and transfer data to and from a variety of digital devices. These cards use flash memory architecture, which means they don't need a power source to retain data.

Memory Stick is a flash memory technology that allows you to record, transfer and share digital content, such as digital pictures, movies, music, voice, and computer data and applications.

Secure Digital (SD) Cards are very similar to Memory Sticks. Like Memory Sticks, SD Cards allow portable storage among a variety of devices, such as cell phones, GPS systems, digital cameras, and PDAs. SD Cards transfer data quickly, with low battery consumption. Like the memory stick, it uses flash memory architecture.

### INSTALLING MEMORY STICK/SD CARDS

Memory Stick and SD Cards are inserted in the Memory Stick/SD Card slot (*Figure 4-5*). To insert a Memory Stick or SD Card, follow these steps:



- Installing or removing a Memory Stick or SD Card during your LifeBook notebook's shutdown or bootup process may damage the card and/or your LifeBook notebook.
- Do not insert a card into a slot if there is water or any other substance on the card as you may permanently damage the card, your LifeBook notebook, or both.

1. See your specific card manual for instructions on the insertion of your card. Some cards may require that your notebook is off while inserting them.

2. Make sure there is no card currently in the slot. If there is, see Removing a Memory Stick/SD Card.
3. Insert your card into the slot with the product label facing up.
4. Push the card firmly into the slot until it is seated in the connector.

### REMOVING A MEMORY STICK/SD CARD

To remove a Memory Stick or SD Card, follow these easy steps:



See your card manual for specific instructions on the removal of your card. Some cards may require your LifeBook notebook to be in Suspend Mode or Off while removing them.

Push the Memory Stick or SD Card in until it unlatches. It will then eject from the slot for removal.

LifeBook E8000 Notebook

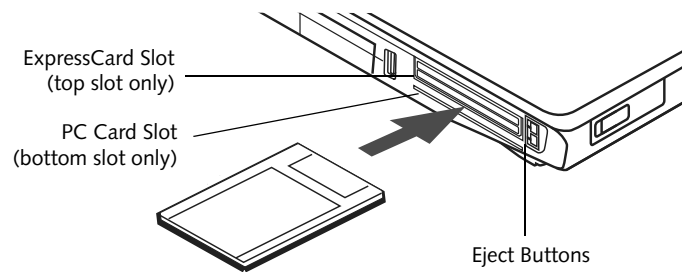

Figure 4-6. Inserting/Removing PC Card

## PC Cards/ExpressCards™

Your LifeBook notebook supports Type I and Type II PC Cards and ExpressCards™, which can perform a variety of functions depending on which type of card you insert. You can insert one or two cards at a time, depending on its type. PC Cards should be inserted in the bottom slot, and ExpressCards in the top slot.

Some available PC/ExpressCards:

- Gigabit Ethernet Local area network (LAN) cards
- IEEE1394 cards
- S-ATA II cards
- IEEE802.11n WLAN cards
- Other PC Cards that conform to PCMCIA 2.1 or CardBus standards

For further information, refer to the instructions supplied with your card(s).

### INSERTING PC CARDS

PC Cards are inserted in the PC Card slot (the lower of the two slots). To insert a PC Card, follow these steps:



- Inserting or removing a PC Card during your LifeBook notebook's shutdown or bootup process may damage the card and/or your LifeBook notebook.
- Do not insert a PC Card into a slot if there is water or any other substance on the card as you may permanently damage the card, your LifeBook notebook, or both.



You may be required to log on as an Administrator or member of the Administrator's Group to complete this procedure. If the computer is connected to a network, network policy settings may also prevent you from completing this procedure.

1. See your PC Card manual for instructions on the insertion of your card. Some cards may require that your notebook is off while inserting them.
2. Make sure there is no PC Card currently in the slot. If there is, see Removing PC Cards.
3. If the eject button is extended, press it until it clicks.
4. Insert the card into the slot with the label facing up.
5. Push the card firmly into the slot until it is seated in the connector.

### REMOVING PC CARDS

See your PC Card manual for specific instructions on removing your card. Some cards may require your notebook to be in Suspend Mode or Off during removal.



- Windows has a shutdown procedure for PC Cards that must be followed before removing a card. (Review your operating system manual for the correct procedure.) It is good practice to remove devices using the Safely Remove Hardware icon in the system tray.
- If the dialog box states that the device cannot be removed, you must save all of your open files, close any open applications and shut down your notebook.

1. Unlock the card from the slot by pressing the eject button associated with the slot in which the card is located. When pressed, the button will pop out.
2. Firmly press the button again until it is flush with the notebook. This will eject the card slightly out of the slot allowing you to remove the card.



If the PC Card has an external connector and cable, do not pull the cable when removing the card.

**INSERTING EXPRESSCARDS**

There are two different width ExpressCards: 34 mm and 54 mm. The connector inside the slot is located on the left-hand side of the slot. If you insert a 34 mm card, be sure to align it with the left side of the slot when inserting it.

ExpressCards are inserted in the ExpressCard slot (the top slot). (Figure 4-7).

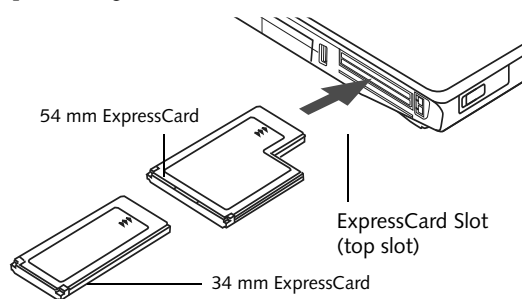

Figure 4-7. Inserting/Removing ExpressCards

- Inserting or removing an ExpressCard during your notebook's shutdown or bootup process may damage the card and/or your notebook.
- Do not insert an ExpressCard into a slot if there is water or any other substance on the card as you may permanently damage the card, your notebook, or both.



You may be required to log on as Administrator or a member of the Administrator's Group to complete this procedure. If your computer is connected to a network, network policy settings may also prevent you from completing this procedure.

See your ExpressCard manual for instructions on the insertion of your card. Some cards may require that your notebook is off while inserting them.

To insert an ExpressCard, follow these steps:

1. Make sure there is no ExpressCard currently in the slot. If there is, see Removing ExpressCards.
2. If the eject button is extended, press it in until it clicks.
3. Insert your ExpressCard into the slot with the product label facing up. If you are inserting a 34 mm card, be sure to align it with the left side of the slot when inserting it.
4. Push the card firmly into the slot until it is seated in the connector.

**REMOVING EXPRESSCARDS**

See your ExpressCard manual for specific instructions on removing your card. Some cards may require your notebook to be in Suspend Mode or Off during removal.



- Windows has a shutdown procedure for ExpressCards that must be followed before removing a card. (Review your operating system manual for the correct procedure.) It is good practice to remove devices using the Safely Remove Hardware icon in the system tray.
- If the dialog box states that the device cannot be removed, you must save all of your open files, close any open applications and shut down your notebook.

To remove an ExpressCard, follow these steps:

2. Unlock the card from the slot by pressing the eject button associated with the slot in which the card is located. When pressed, the button will pop out.
3. Firmly press the button again until it is flush with the notebook. This will eject the card slightly out of the slot allowing you to remove the card.

**SMART CARD READER**

A dedicated Smart Card Reader is provided on your notebook (Figure 4-8). Smart Cards are the same size and shape as credit cards, but they contain an integrated microprocessor chip. The chip can hold a variety of information, and provides you with many possible options, such as allowing you to make secure purchases, pay for phone calls, store security information, and provide personal identification and information.

In order to use the Smart Card Reader, you must purchase optional Smart Card third-party software.

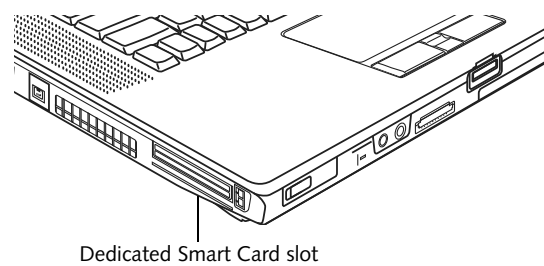

Figure 4-8. Smart Card Slot

## Memory Upgrade Module

Your Fujitsu LifeBook notebook comes with a minimum of 256 MB of high speed Double Data Rate Synchronous Dynamic RAM (DDR2-667 SDRAM) factory installed. To increase your notebook's memory capacity, you may install an additional memory upgrade module. The memory upgrade must be a dual-in-line (DIMM) SDRAM module. To ensure 100% compatibility, purchase the SDRAM module only from the Fujitsu web store at [www.shopfujitsu.com](http://www.shopfujitsu.com).

- Do not remove any screws from the memory upgrade module compartment except the ones specifically shown in the directions for installing and removing the memory upgrade module.
- The memory upgrade module can be severely damaged by electrostatic discharge (ESD). To minimize risk to the module, observe the following precautions:
  - Before handling a memory module, touch a grounded metal object to discharge static electricity built up in your body.
  - When installing or removing a memory module, hold it by the edge so as not to touch any contacts or chips. Be careful not to touch any internal computer terminals or components; the oil from your fingers could cause a short to the components.
  - Be sure to power down your system before adding or removing memory modules. Even if the system is in hibernate or standby states, data could be lost or the memory could be damaged if power is still available to the system.

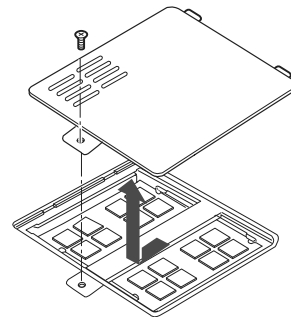

Figure 4-9. Opening the Memory Upgrade Compartment

7. Insert the memory upgrade module at a 45° angle. Press the connector edge of the module firmly down and into the connector until it lodges under the retaining clip. You'll hear a click when it is properly in place.
8. Replace the cover and reinstall the screws.

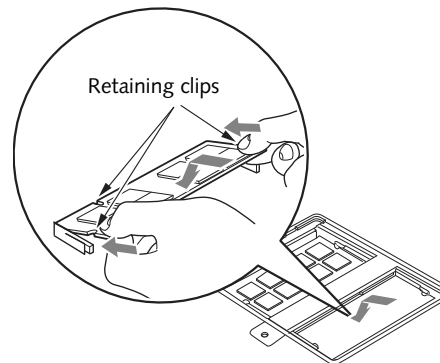

Figure 4-10. Installing a Second Memory Module



The memory upgrade module is not something you routinely remove from your notebook. Once it is installed, you can leave it in place unless you want to change system memory capacity.

### INSTALLING MEMORY UPGRADE MODULES

1. Turn off power to your notebook, remove any power adapter (AC or auto/airline). Remove the battery.
2. Make sure that all the connector covers are closed.
3. Turn the notebook bottom side up, and remove the screw from the memory upgrade module compartment.
4. Remove the cover.
5. Remove the memory upgrade module from the static guarded sleeve.
6. Align the memory upgrade module with the part side up. Align the connector edge of the memory upgrade module with the connector slot in the compartment.

### REMOVING A MEMORY UPGRADE MODULE

1. Perform steps 1 through 4 of Installing a Memory Upgrade Module.
2. Pull the clips sideways away from each side of the memory upgrade module at the same time.
3. While holding the clips out, remove the module from the slot by lifting it up and pulling it away from your notebook.
4. Store the memory upgrade module in a static guarded sleeve.
5. Replace the cover and reinstall the screws.

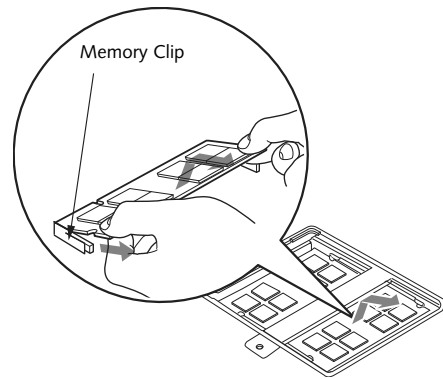
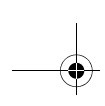

Figure 4-11. Removing a Memory Upgrade Module

#### CHECKING THE MEMORY CAPACITY

Once you have changed the system memory capacity by replacing the installed module with a larger one, be sure to check that your notebook has recognized the change.

**Windows XP:** Check the memory capacity by clicking [Start] -> Settings -> Control Panel, then double-clicking the System icon. Select the General tab and check the amount of memory under “Computer:”

**Windows Vista:** Check the memory capacity by clicking [Start] -> Control Panel -> System and Maintenance -> System. The amount of memory is displayed next to “Memory - RAM:”

There may be a variation between the actual memory size and what is displayed. This is possible if your system is configured with an integrated Intel Graphics Media Accelerator X3100 which dynamically allocates system memory to accelerate graphics performance.



If the total memory displayed is incorrect, check that your memory upgrade module is properly installed. (If the module is properly installed and the capacity is still not correctly recognized, see Troubleshooting on page 51.)

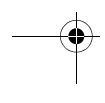
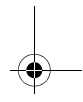
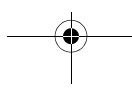
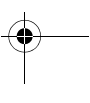
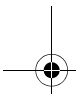
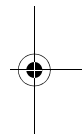
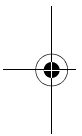

## Device Ports

Your Fujitsu LifeBook notebook and the optional Port Replicator come equipped with multiple ports to which you can connect external devices including: disk drives, keyboards, modems, printers, etc.

### MODEM (RJ-11) TELEPHONE JACK

The modem (RJ-11) telephone jack is used for an internal modem. To connect the telephone cable follow these easy steps:

1. Align the connector with the port opening.
2. Push the connector into the port until it is seated.
3. Plug the other end of the telephone cable into a telephone outlet. (Figure 4-12)

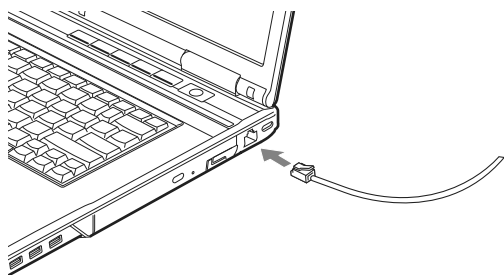

Figure 4-12. Connecting a Modem

The modem sound may initially be deactivated. To activate modem sound follow these easy steps.

#### Windows XP:

1. Right click on the Speaker icon in your system tray.
2. Select **Open Volume**.
3. Select **Option/Properties**.
4. Under "Show the following volume controls", click on **Phone** and click **OK**.
5. Uncheck the Mute box under Phone Balance.

#### Windows Vista:

1. Select [Start] -> Control Panel.
2. Select Classic View in the left pane.
3. Double-click Phone and Modems.
4. You may initially need to enter your area code in order to open the Phone and Modem Options window.
5. Select the Modems tab, and click the [Properties] button.
6. Select the Modem tab and adjust the volume as necessary

The internal modem is not intended for use with Digital PBX systems. Do not connect the internal modem to a Digital PBX as it may cause serious damage to the internal modem or your entire LifeBook notebook. Consult your PBX manufacturer's documentation for details. Some hotels have Digital PBX systems. Be sure to find out **BEFORE** you connect your modem.



- The internal modem is designed to the ITU-T V.90 standard. Its maximum speed of 53000bps is the highest allowed by FCC, and its actual connection rate depends on the line conditions. The maximum speed is 33600bps at upload.
- The internal modem on all Fujitsu LifeBook notebooks from Fujitsu are certified for use in the United States and Canada. The modem may be certified in other countries.

### INTERNAL LAN (RJ-45) JACK

The internal LAN (RJ-45) jack is used for a Gigabit (10Base-T/100Base-Tx/1000Base-T) Ethernet LAN connection. You may need to configure your notebook to work with your particular network. (Please refer to your network administrator for information on your network configuration.) To connect the LAN cable follow these easy steps:

1. Align the connector with the port opening.
2. Push the connector into the port until it is seated. (Figure 4-13)
3. Plug the other end of the cable into a LAN outlet.

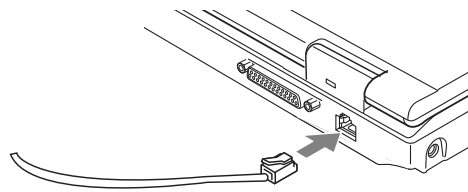

Figure 4-13. Connecting the LAN

### PARALLEL PORT

The parallel port, or LPT port, located on the system and on the optional Port Replicator allows you to connect parallel devices, such as a printer to your notebook. In order to connect a parallel interface device follow these easy steps:



1. Align the connector with the port opening.
2. Push the connector into the port until it is seated. (Figure 4-14)
3. Tighten the two hold-down screws, located on each side of the connector.

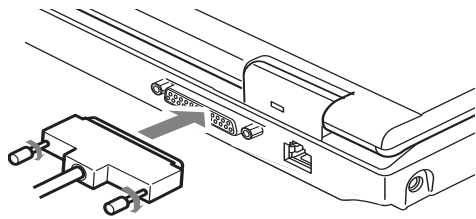

Figure 4-14. Connecting a Parallel Device

#### SERIAL PORT

The serial port, or COM port, located on the system and on the optional Port Replicator allows you to connect serial devices, such as printers or scanners. In order to connect a serial interface device follow these easy steps:

1. Open the plastic cover that is over the port, then align the connector with the port opening.
2. Push the connector into the port until it is seated (Figure 4-15).
3. Tighten the two hold-down screws, located on each side of the connector.

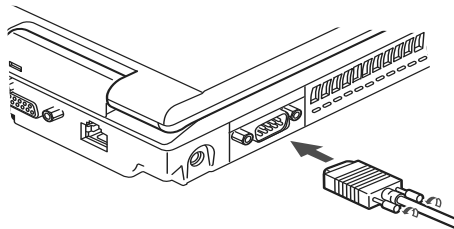

Figure 4-15. Connecting a Serial Device

#### PORT REPLICATOR CONNECTOR

The port replicator connector is used for the connection of your notebook to an optional port replicator. In order to connect your notebook to this device, follow the instructions that came with your port replicator. (See Figure 2-7 on page 11 for location)

#### UNIVERSAL SERIAL BUS PORTS

The Universal Serial Bus 2.0 ports (USB) allow you to connect USB devices such as external game pads, pointing devices, keyboards and/or speakers. There are four USB 2.0 ports on your notebook: one on the left side and three on the right.

In order to connect a USB device follow these steps:

1. Align the connector with the port opening. (Figure 4-16)
2. Push the connector into the port until it is seated.

#### User Installable Features



Due to the ongoing changes in USB technology and standards, not all USB devices and/or drivers are guaranteed to work.

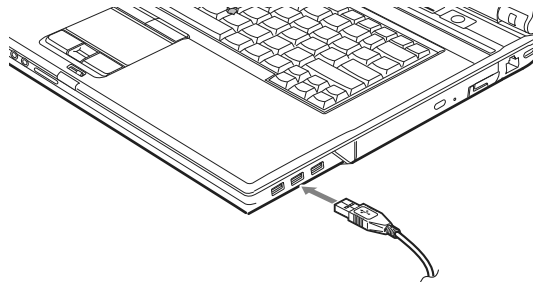

Figure 4-16. Connecting a USB Device

#### INFRARED PORT

The Infrared IrDA (4Mbps) port allows for wireless data transfer between your notebook and other IrDA-compatible devices, such as another computer or a printer, without the use of a cable. The infrared port is located adjacent to the wireless LAN switch (See Figure 2-3 on page 6 for location)

It is important to keep in mind that while carrying out this form of communication, both devices must be placed so their infrared ports are directly facing each other without obstruction. The devices must also be separated by at least 6" but no more than 36" for maximum performance.

The following conditions may interfere with infrared communications:

- A television, radio remote control unit, or a wireless headphone is being used nearby.
- Direct sunlight, fluorescent light, or incandescent light shines directly on the port.



- Do not move either device while communication is active as it may interrupt data transmission.
- Be careful not to scratch the infrared port lens. Dirt, scratches, or other surface marks can degrade operation.

#### HEADPHONE JACK

The headphone jack allows you to connect headphones or powered external speakers to your notebook. Your headphones or speakers must be equipped with a 1/8" (3.5 mm) stereo mini-plug. In order to connect headphones or speakers follow these easy steps:

1. Align the connector with the port opening.
2. Push the connector into the port until it is seated.

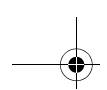

- Depending upon your system configuration, the headphone jack may serve different purposes. On some configurations, the jack serves as a stereo headphone/Optical Digital Audio Out jack. On other configurations, the jack serves as a stereo headphone/Line-Out/Optical Digital Audio Out jack.
- If you plug headphones into the headphone jack, built-in stereo speakers will be disabled.

### MICROPHONE JACK

The microphone jack allows you to connect an external mono microphone. Your microphone must be equipped with a 1/8" (3.5 mm) mono mini-plug in order to fit into the microphone jack of your notebook. In order to connect a microphone follow these easy steps:

1. Align the connector with the port opening.
2. Push the connector into the port until it is seated.



Depending upon your system configuration, the microphone jack may serve single or dual purposes. On some configurations, the jack serves as a mono microphone jack. On other configurations, the jack serves as a stereo microphone/Line-In jack.

### EXTERNAL VIDEO PORT

The external video port allows you to connect an external monitor or LCD projector. In order to connect an external video device, follow these easy steps: (See Figure 2-4 on page 8 for location)

1. Open the plastic cover that is over the port, then align the connector with the port opening.
2. Push the connector into the port until it is seated.
3. Tighten the two hold-down screws, located on each end of the connector.



Pressing the [Fn] + [F10] keys allows you to change your selection of where to send your display video. Each time you press the key combination, you will step to the next choice, starting with the built-in display panel only, moving to both the built-in display panel and the external monitor, finally moving to external monitor only.



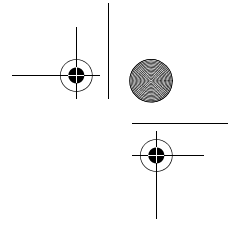
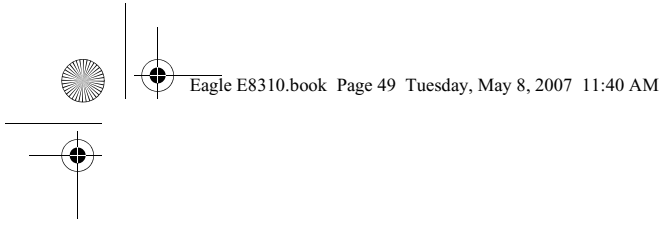

# 5 Troubleshooting

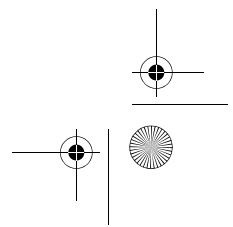
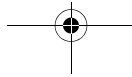
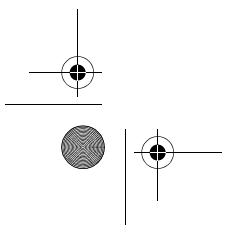
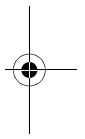
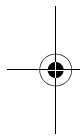



LifeBook E8000 Notebook

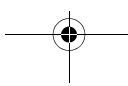
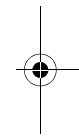
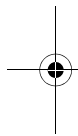

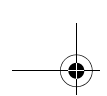

## Troubleshooting

There may be occasions when you encounter simple setup or operating problems that you can solve on the spot, or problems with peripheral devices that can be solved by replacing the device. The information in this section helps you isolate and resolve some of these straightforward issues and identify failures that require service.

### IDENTIFYING THE PROBLEM

If you encounter a problem, go through the following procedure before pursuing complex troubleshooting:

1. Turn off your LifeBook notebook.
2. Make sure the AC adapter is plugged into your notebook and to an active AC power source.
3. Make sure that any card inserted in the PC Card slot is seated properly. You can also remove the card from the slot, thus eliminating it as a possible cause of failure.
4. Make sure that any devices connected to the external connectors are plugged in properly. You can also disconnect such devices, thus eliminating them as possible causes of failure.
5. Turn on your notebook. Make sure it has been off at least 10 seconds before you turn it back on.
6. Go through the boot sequence.
7. If the problem has not been resolved, refer to the Troubleshooting Table, that follows, for more detailed troubleshooting information.



If you keep notes about what you have tried, your support representative may be able to help you more quickly by giving additional suggestions over the phone.

8. If you have tried the solutions suggested in the Troubleshooting Table without success, contact your support representative:

Toll free: 1-800-8Fujitsu (1-800-838-5487)

E-mail: 8fujitsu@us.fujitsu.com

Website:

<http://www.computers.us.fujitsu.com/support>.

Before you place the call, you should have the following information ready so that the customer support representative can provide you with the fastest possible solution:

- Product name
- Product configuration number
- Product serial number
- Purchase date
- Conditions under which the problem occurred
- Any error messages that have occurred
- Type of device connected, if any

See the Configuration Label on the bottom of your notebook for configuration and serial numbers.

### SPECIFIC PROBLEMS

#### Using the Troubleshooting Table

When you have problems with your LifeBook notebook, try to find the symptoms under the Problem column of the troubleshooting table for the feature giving you difficulty. You will find a description of common causes for that symptom under the column Possible Cause and what, if anything, you can do to correct the condition under Possible Solutions. All possible causes or solutions may not apply to your notebook.

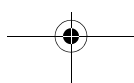
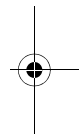
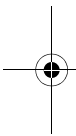

**TROUBLESHOOTING TABLE**

<b>Problem</b>	<b>Page</b>	<b>Problem</b>	<b>Page</b>
Audio Problems . . . . .	page 52	Modem Problems. . . . .	page 54
DVD/CD-ROM Drive Problems. . . . .	page 52	Parallel, Serial and USB Device Problems . . . . .	page 54
Port Replicator Problems. . . . .	page 53	PC Card Problems . . . . .	page 54
Floppy Disk Drive Problems . . . . .	page 53	Power Failures . . . . .	page 55
Hard Drive Problems . . . . .	page 53	Shutdown and Startup Problems . . . . .	page 56
Keyboard or Mouse Problems. . . . .	page 53	Video Problems . . . . .	page 57
Memory Problems . . . . .	page 54	Miscellaneous Problems . . . . .	page 58

Problem	Possible Cause	Possible Solutions
<b>Audio Problems</b>		
There is no sound coming from the built-in speakers.	The volume is turned too low.	Adjust the volume control on your notebook and operating system. Use the [Fn+F9] key combination on your LifeBook keyboard. Pressing [F9] repeatedly while holding [Fn] will increase the volume of your notebook.
	The software volume control is set too low.	Manually adjusting the volume (i.e. keyboard "hot keys") should dynamically adjust the volume of the operating (see above). If that doesn't work, adjust the sound volume control settings in your software or application.
	Headphones are plugged into your notebook.	Plugging in headphones disables the built-in speakers, remove the headphones.
	BIOS audio settings are incorrect.	Set the BIOS setup utility to the default values within the Multimedia Device Configuration menu. (See <i>BIOS Setup Utility on page 29 for more information</i> )
	Software driver is not configured correctly.	The Audio Driver may be installed or reinstalled by using the Drivers and Applications CD that came with your Fujitsu LifeBook. Refer to your application and operating system documentation for help.
	The speakers have been muted using the Volume icon in the system tray.	Click on the Volume icon in the tool tray on the bottom right of the screen. (It looks like a speaker). If the Mute box is checked, click on it to uncheck it. You can also use the [Fn+F3] key combination to toggle the volume on and off. Pressing [F3] while holding [Fn] will toggle the audio mute.
<b>DVD/CD-RW/CD-ROM Drive Problems</b>		
LifeBook notebook fails to recognize DVD/CD-RW/CD-ROM's.	The disc is not pushed down onto raised center circle of the drive.	Open the optical drive tray and re-install the disc properly.
	Optical drive tray is not latched shut.	Push on the front of the optical drive tray until it latches. If that doesn't work, pull out the modular drive latch to remove the device from the bay, then re-insert the drive until it latched; this ensures that the drive is properly seated.
	Incorrect DVD Player or no DVD Player software is installed.	Install DVD Player software. (See <i>"Media Player Software" on page 39 for more information.</i> )

### Troubleshooting

Problem	Possible Cause	Possible Solutions
LifeBook notebook fails to recognize DVD/CD-RW/CD-ROM's. (continued)	Wrong drive designator was used for the disc in the application.	Verify the drive designator used by the application is the same as the one used by the operating system. When the operating system is booted from a DVD/CD, drive designations are automatically adjusted. Note that the drive designation can be changed with the Disk Management tool located in the Control Panel under Administrative Tools -> Computer Management.
	Disc is dirty or defective.	Wipe the disc with a non-abrasive CD cleaning cloth and reinsert. If it still will not work try another disc in the drive.
The optical drive access indicator on the Status Indicator Panel blinks at regular intervals when no disc is in the tray or the drive is not installed.	The Windows auto insertion function is active and is checking to see if a disc is ready to run.	This is normal. However, you may disable this feature.
<b>Port Replicator Problems</b>		
Note: Be sure to power down your LifeBook notebook before adding a printer to the Port Replicator parallel port.		
LifeBook notebook does not turn on when installed in the optional Port Replicator	Port Replicator AC adapter is not plugged in.	Provide power to the Port Replicator.
	Notebook is not properly seated in the Port Replicator.	Remove and re-dock your LifeBook notebook.
<b>Floppy Disk Drive Problems</b>		
You cannot access your optional external floppy disk.	You tried to write to a write protected floppy disk.	Eject the floppy disk and set it to write enable.
	Floppy disk is not loaded correctly.	Eject floppy disk, check orientation and re-insert.
	The floppy disk drive may not be properly installed.	Remove and re-install your floppy disk drive.
	Security is set to protect access to floppy disk data.	Verify your password and security settings.
<b>Hard Drive Problems</b>		
You cannot access your hard drive.	The wrong drive designator was used by an application when a bootable CD-ROM was used to start the notebook.	Verify drive designator used by application is in use by the operating system. When the operating system is booted from a CD, drive designations are automatically adjusted.
	Security is set so your operating system cannot be started without a password.	Verify your password and security settings.
<b>Keyboard or Mouse Problems</b>		
The built-in keyboard does not seem to work.	The notebook has gone into Standby mode.	Push the <b>Power/Suspend/Resume</b> button.
	Your application has locked out your keyboard.	Try to use your integrated pointing device to restart your system.

## LifeBook E8000 Notebook

Problem	Possible Cause	Possible Solutions
You have installed an external keyboard or mouse, and it does not seem to work.	Your external device is not properly installed.	Re-install your device. (See <i>Device Ports</i> on page 46 for more information)
	Your operating system software is not set up with correct software driver for that device.	Check your device and operating system documentation and activate the proper driver.
You have connected an external keyboard or a mouse and it seems to be locking up the system.	Your operating system software is not setup with correct software driver for that device.	Check your device and operating system documentation and activate the proper driver.
	Your system has crashed.	Try to restart your notebook.
<b>Memory Problems</b>		
Your Power On screen does not show the correct amount of installed memory.	Your memory upgrade module is not properly installed.	Remove and re-install your memory upgrade module. (See <i>Memory Upgrade Module</i> on page 44 for more information)
	You have a memory failure.	Check for Power On Self Test (POST) messages. (See <i>Power On Self Test Messages</i> on page 59 for more information)
<b>Modem Problems</b>		
Messages about modem operation.	Messages about modem operation are generated by whichever modem application is in use.	See your application software documentation for additional information.
<b>Parallel, Serial, and USB Device Problems</b>		
You have installed a parallel port device, a serial port device or a USB device. Your LifeBook notebook does not recognize the device, or the device does not seem to work properly.	The device is not properly installed.	Remove and re-install the device. (See <i>Device Ports</i> on page 46 for more information)
	The device may have been installed while an application was running, so your notebook is not aware of its installation.	Close the application and restart your notebook.
	Your device may not have the correct software driver active.	See your software documentation and activate the correct driver.
	You may have the wrong I/O address selected for your device.	See your device documentation and software documentation to determine the required I/O address. Change the settings in the BIOS setup utility. (See <i>BIOS Setup Utility</i> on page 29 for more information)
	Your device and another device are assigned the same I/O address.	Check all I/O addresses located within the BIOS setup utility and any other installed hardware or software to make sure there are no duplications.
	Parallel port is set to output only.	Check parallel port setting in the BIOS and set to bi-directional or ECP.
<b>PC Card/ExpressCard Problems</b>		
A card inserted in the PC Card or ExpressCard slot does not work or is locking up the system.	The card is not properly installed.	Remove and re-install the card. (See <i>PC Cards/ExpressCards™</i> on page 42 for more information)



### Troubleshooting

Problem	Possible Cause	Possible Solutions
A card inserted in the PC Card or ExpressCard slot does not work or is locking up the system.  (continued)	The card may have been installed while an application was running, so your notebook is not aware of its installation.	Close the application and restart your notebook.
	Your software may not have the correct software driver active.	See your software documentation and activate the correct driver via the Device Manager
	You may have the wrong I/O address selected for your card device.	See your PC Card/ExpressCard documentation to determine the required I/O address. Change the settings in the Device Manager.
	Your card device and another device are assigned the same I/O address.	Check all I/O addresses located within the BIOS setup utility and any other installed hardware or software to make sure there are no duplications.
<b>Power Failures</b>		
You turn on your LifeBook notebook and nothing seems to happen.	The installed primary battery is completely discharged, there is no optional second battery installed or there is no Power adapter (AC or Auto/Airline) installed.	Check the Status Indicator Panel to determine the presence and condition of the batteries. ( <i>See Status Indicator Panel on page 12 for more information</i> ) Install a charged battery or a Power adapter.
	The primary battery is installed but is faulty.	Use the Status Indicator panel to verify the presence and condition of the batteries. ( <i>See Status Indicator Panel on page 12 for more information</i> ) If a battery is indicating a short, remove that battery and operate from another power source or replace that battery.
	The battery or batteries are low.	Check the Status Indicator Panel to determine the presence and condition of the batteries. ( <i>See Status Indicator Panel on page 12 for more information</i> ) Use a Power adapter to operate until a battery is charged or install a charged battery.
	The power adapter (AC or auto/airline) is not plugged in properly.	Verify that your adapter is connected correctly. ( <i>See Power Sources on page 27 for more information</i> )
	The Power adapter (AC or auto/airline) has no power from the AC outlet, airplane seat jack, or the car's cigarette lighter.	Move the AC cord to a different outlet, check for a line switch or tripped circuit breaker for the AC outlet. If you are using an auto/airline adapter in a car make sure the ignition switch is in the On or Accessories position.
	The Power adapter (AC or auto/airline) is faulty.	Try a different Power adapter or install a charged optional second battery.
Your LifeBook notebook turns off all by itself.	The power management parameters are set for auto timeouts which are too short for your operating needs.	Press any button on the keyboard, or move the mouse to restore operation. If that fails, push the Power/Suspend/Resume button. Check your power management settings, or close your applications and go to the Power Options Properties located in the Control Panel to adjust the timeout values to better suit your needs.

## LifeBook E8000 Notebook

Problem	Possible Cause	Possible Solutions
Your LifeBook notebook turns off all by itself. (continued)	You are operating on battery power and ignored a low battery alarm until the batteries are at the dead battery state and the system has gone into Dead Battery Suspend mode.	Install a power adapter and then push the Power/Suspend/Resume button. (See <i>Power Sources on page 27 for more information</i> )
	You have a battery failure.	Verify the condition of the batteries using the Status Indicator panel, and replace or remove any batteries that are shorted. (See <i>Status Indicator Panel on page 12 for more information</i> )
	Your power adapter has failed or lost its power source.	Make sure the adapter is plugged in and the outlet has power.
Your LifeBook notebook will not work on battery alone.	The installed batteries are dead.	Replace the battery with a charged one or install a power adapter.
	No batteries are installed.	Install a charged battery.
	The batteries are improperly installed.	Verify that the batteries are properly connected by re-installing them.
	Your installed batteries are faulty.	Verify the condition of the batteries using the Status Indicator panel and replace or remove any batteries that are shorted. (See <i>Status Indicator Panel on page 12 for more information</i> )
The batteries seem to discharge too quickly.	You are running an application that uses a lot of power due to frequent hard drive access or optical drive access, or use of a modem, LAN PC card, Wireless LAN, or Bluetooth device.	Use both the primary battery and an optional second battery and/or use a power adapter for this application when at all possible.
	The power savings features may be disabled.	Check the Power Options menu settings and adjust according to your operating needs.
	The brightness is turned all the way up.	Turn down the brightness adjustment. The higher the brightness the more power your display uses.
	The batteries are very old.	Replace the batteries.
	The batteries have been exposed to high temperatures.	Replace the batteries.
	The batteries are too hot or too cold.	Restore the notebook to normal operating temperature. Charging icon on the Status Indicator panel will flash when battery is outside of operating range.
<b>Shutdown and Startup Problems</b>		
The Suspend/Resume button does not work.	Suspend/Resume button is disabled.	In Windows XP, enable the button by going to the Control Panel -> Power Options Properties and clicking on the Advanced tab. In the Power buttons area, select the option that best suits your needs. In Windows Vista, select the Change what the power button does" option.
	There may be a conflict with the software.	Close all applications and try the button again.

### Troubleshooting

Problem	Possible Cause	Possible Solutions
The system powers up, and displays power on information, but fails to load the operating system.	The boot sequence settings of the setup utility are not compatible with your configuration.	Set the operating source by pressing the [ESC] key while the Fujitsu logo is on screen or use the [F2] key and enter the setup utility and adjust the source settings from the Boot menu. <i>(See BIOS Setup Utility on page 29 for more information)</i>
	You have a secured system requiring a password to load your operating system.	Make sure you have the right password. Enter the setup utility and verify the Security settings and modify them as accordingly. <i>(See BIOS Setup Utility on page 29 for more information)</i>
	Internal hard drive was not detected.	Use the BIOS setup utility or Primary Master submenu, located within the Main menu, to try to auto detect the internal hard drive.
An error message is displayed on the screen during the notebook (boot) sequence.	Power On Self Test (POST) has detected a problem.	See the Power On Self Test (POST) messages to determine the meaning and severity of the problem. Not all messages are errors; some are simply status indicators. <i>(See Power On Self Test Messages on page 59 for more information)</i>
Your notebook appears to change setup parameters when you start it.	BIOS setup changes were not saved when you made them and exited the setup utility returning it to earlier settings.	Make sure you select <b>Save Changes And Exit</b> when exiting the BIOS setup utility.
	The BIOS CMOS hold-up battery has failed.	Contact your support representative for repairs. This is not a user serviceable part but has a normal life of 3 to 5 years.
Your system display won't turn on when the system is turned on or has resumed.	You have installed the LifeBook/Security Application panel.	Check the Status Indicator Panel for presence of the Security icon. If it is visible, enter your password <i>(See Security Indicator on page 13 for more information)</i>
<b>Video Problems</b>		
The built-in display is blank when you turn on your LifeBook notebook.	The notebook is set for an external monitor only.	Pressing [F10] while holding down the [Fn] key allows you to change your selection of where to send your display video. Each time you press the keys you will step to the next choice. The choices, in order are: built-in display only, external monitor only, both built-in display and external monitor.
	The display angle and brightness settings are not adequate for your lighting conditions.	Move the display and the brightness control until you have adequate visibility. Pressing either the [F6] or [F7] keys while holding down the [Fn] key also allows you to change the brightness level of the display.
	The power management timeouts may be set for very short intervals and you failed to notice the display come on and go off again.	Press a keyboard button or move the mouse to restore operation. If that fails, push the Power/Suspend/Resume button. (The display may be shut off by Standby mode, Auto Suspend or Video Timeout)
The LifeBook notebook turned on with a series of beeps and your built-in display is blank.	Power On Self Test (POST) has detected a failure which does not allow the display to operate.	Contact your support representative.

## LifeBook E8000 Notebook

Problem	Possible Cause	Possible Solutions
The display goes blank by itself after you have been using it.	The notebook has gone into Video timeout, Standby mode, Suspend mode or Save-to-Disk mode because you have not used it for a period of time.	Press any button on the keyboard, or move the mouse to restore operation. If that fails, push the Power/Suspend/Resume button. Check your power management settings, or close your applications and go to the Power Options control panel.
	The power management time-outs may be set for very short intervals and you failed to notice the display come on and go off again.	Press any button on the keyboard, or move the mouse to restore operation. If that fails, push the Power/Suspend/Resume button. (The display may be shut off by Standby Mode, Auto Suspend or Video Timeout)
Your system display won't turn on when the system is turned on or when the system has resumed.	The system may be password-protected.	Check the status indicator panel to verify that the Security icon is blinking. If it is blinking, enter your password.
The display does not close.	A foreign object, such as a paper clip, is stuck between the display and the keyboard.	Remove all foreign objects from the keyboard.
The display has bright or dark spots.	If the spots are very tiny and few in number, this is normal for a large LCD display.	This is normal; do nothing.
	If the spots are numerous or large enough to interfere with your operation needs.	Display is faulty; contact your support representative.
The display is dark when on battery power.	The Power Management utility default is set on low brightness to conserve power.	Press [Fn] + [F7] to increase brightness or right-click on the battery gauge and adjust Power Properties (In Vista: Power Options).
You have connected an external monitor and it does not display any information.	Your BIOS setup is not set to enable your external monitor.	Toggle the video destination by pressing [Fn]+ [F10] together, or check your BIOS setup and enable your external monitor. (See the Video Features submenu, located within the Advanced Menu of the BIOS. (See <i>BIOS Setup Utility on page 29 for more information</i> )
You have connected an external monitor and it does not display any information.	Your external monitor is not properly installed.	Reinstall your device. (See <i>External Video Port on page 48 for more information</i> )
	Your operating system is not setup with the correct software driver for that device.	Check your device and operating system documentation and activate the proper driver.
You have connected an external monitor and it does not come on.	Your external monitor is not compatible with your LifeBook notebook.	See your monitor documentation and the External Monitor Support portions of the Specifications section. (See <i>Specifications on page 71 for more information</i> )
<b>Miscellaneous Problems</b>		
An error message is displayed on the screen during the operation of an application.	Application software often has its own set of error message displays.	See your application manual and help displays screens for more information. Not all messages are errors some may simply be status.

**POWER ON SELF TEST MESSAGES**

The following is an alphabetic list of error-and-status messages that Phoenix BIOS and/or your operating system can generate and an explanation of each message. Error messages are marked with an \*. If an error message is displayed that is not in this list, write it down and check your operating system documentation both on screen and in the manual. If you can find no reference to the message and its meaning is not clear, contact your support representative for assistance.

**nnnn Cache SRAM Passed**

Where nnnn is the amount of system cache in kilobytes successfully tested by the Power On Self Test. (This can only appear if you have an SRAM PC Card installed.)

**\*Diskette drive A error or Diskette drive B error**

Drive A: or B: is present but fails the BIOS Power On Self Test diskette tests. Check to see that the drive is defined with the proper diskette type in the Setup Utility, (*See BIOS Setup Utility on page 29 for more information*) and that the diskette drive is installed correctly. If the disk drive is properly defined and installed, avoid using it and contact your support representative.

**\*Extended RAM Failed at offset: nnnn**

Extended memory not working or not configured properly. If you have an installed memory upgrade module, verify that the module is properly installed. If it is properly installed, you may want to check your Windows Setup to be sure it is not using unavailable memory until you can contact your support representative.

**nnnn Extended RAM Passed**

Where nnnn is the amount of memory in kilobytes successfully tested.

**\*Failing Bits: nnnn The hex number nnnn**

This is a map of the bits at the memory address (in System, Extended, or Shadow memory) which failed the memory test. Each 1 (one) in the map indicates a failed bit. This is a serious fault that may cause you to lose data if you continue. Contact your support representative.

**\*Fixed Disk x Failure or Fixed Disk Controller Failure (where x = 1-4)**

The fixed disk is not working or not configured properly. This may mean that the hard drive type identified in your setup utility does not agree with the type detected by the Power On Self Test. Run the setup utility to check for the hard drive type settings and correct them if necessary. If the settings are OK and the message appears when you restart the system, there may be a serious fault which might cause you to lose data if you continue. Contact your support representative.

**\*Incorrect Drive A type – run SETUP**

Type of floppy drive A: not correctly identified in Setup. This means that the floppy disk drive type identified in your setup utility does not agree with the type detected by the Power On Self Test. Run the setup utility to correct the inconsistency.

**\*Incorrect Drive B type – run SETUP**

Type of floppy drive B: not correctly identified in Setup. This means that the floppy disk drive type identified in your setup utility does not agree with the type detected by the Power On Self Test. Run the setup utility to correct the inconsistency.

**\*Invalid NVRAM media type**

Problem with NVRAM access. In the unlikely case that you see this message you may have some display problems. You can continue operating but should contact your support representative for more information.

**\*Keyboard controller error**

The keyboard controller test failed. You may have to replace your keyboard or keyboard controller but may be able to use an external keyboard until then. Contact your support representative.

**\*Keyboard error**

Keyboard not working. You may have to replace your keyboard or keyboard controller but may be able to use an external keyboard until then. Contact your support representative.

**\*Keyboard error nn**

BIOS discovered a stuck key and displays the scan code for the stuck key. You may have to replace your keyboard but may be able to use an external keyboard until then. Contact your support representative.

**\*Monitor type does not match CMOS – Run SETUP**

Monitor type not correctly identified in Setup. This error probably means your BIOS is corrupted, run the setup utility and set all settings to the default conditions. If you still get this error, contact your support representative.

**\*Operating system not found**

Operating system cannot be located on either drive A: or drive C: Enter the setup utility and see if both the fixed disk, and drive A: are properly identified and that the boot sequence is set correctly. Unless you have changed your installation greatly, the operating system should be on drive C:. If the setup utility is correctly set, your hard drive may be corrupted.

**\*Parity Check 1 nnnn**

Parity error found in the system bus. BIOS attempts to locate the address and display it on the screen. If it cannot locate the address, it displays ????. This is a potentially data destroying failure. Contact your support representative.

**\*Parity Check 2 nnnn**

Parity error found in the I/O bus. BIOS attempts to locate the address and display it on the screen. If it cannot locate the address, it displays ????. This is a potentially data-destroying failure. Contact your support representative.

**\*Press <F1> to resume, <F2> to SETUP**

Displayed after any recoverable error message. Press the [F1] key to continue the boot process or the [F2] key to enter Setup and change any settings.

**\*Previous boot incomplete – Default configuration used**

Previous Power On Self Test did not complete successfully. The Power On Self Test will load default values and offer to run Setup. If the previous failure was caused by incorrect values and they are not corrected, the next boot will likely fail also. If using the default settings does not allow you to complete a successful boot sequence, you should turn off the power and contact your support representative.

**\*Real time clock error**

Real-time clock fails BIOS test. May require board repair. Contact your support representative.

**\*Shadow RAM Failed at offset: nnnn**

Shadow RAM failed at offset nnnn of the 64k block at which the error was detected. You are risking data corruption if you continue. Contact your support representative.

**nnnn Shadow RAM Passed**

Where nnnn is the amount of shadow RAM in kilobytes successfully tested.

**\*System battery is dead – Replace and run SETUP**

The BIOS CMOS RAM memory hold up battery is dead. This is part of your BIOS and is a board mounted battery which requires a support representative to change. You can continue operating but you will have to use setup utility default values or reconfigure your setup utility every time you turn off your notebook. This battery has an expected life of 2 to 3 years.

**System BIOS shadowed**

System BIOS copied to shadow RAM.

**\*System CMOS checksum bad – run SETUP**

BIOS CMOS RAM has been corrupted or modified incorrectly, perhaps by an application program that changes data stored in BIOS memory. Run Setup and reconfigure the system.

**\*System RAM Failed at offset: nnnn**

System memory failed at offset nnnn of in the 64k block at which the error was detected. This means that there is a fault in your built-in memory. If you continue to operate, you risk corrupting your data. Contact your support representative for repairs.

**nnnn System RAM Passed**

Where nnnn is the amount of system memory in kilobytes successfully tested.

**\*System timer error**

The timer test failed. The main clock that operates the computer is faulty. Requires repair of system board. Contact your support representative for repairs.

**UMB upper limit segment address: nnnn**

Displays the address of the upper limit of Upper Memory Blocks, indicating released segments of the BIOS memory which may be reclaimed by a virtual memory manager.

**Video BIOS shadowed**

Video BIOS successfully copied to shadow RAM.

**EMERGENCY MEDIA PLAYER DRIVE TRAY RELEASE**

If for some reason the eject button fails, you can open the DVD/CD-ROM tray with a paper clip or similar tool inserted into the eject hole in the far right side of the front of the tray. Straighten one side of a paper clip and push it gently into the hole. The tray will pop out a short distance.

**MODEM RESULT CODES**

The operating system and application software that is factory installed detects the modem characteristics and provides the necessary command strings to operate the modem. The internal modem operation is controlled by generic AT commands from the operating system and application software. The standard long form result codes may, in some cases, be displayed on your screen to keep you informed of the actions of your modem. The operating system and application software may suppress display of the result codes.

Examples of result codes are:

- OK
- NO CARRIER
- NO DIALTONE
- CONNECT 53000 (Connection complete at 53,000 bps.)
- ERROR
- FAX
- RING (This means an incoming call.)
- BUSY
- NO ANSWER

When using the internal modem with applications that are not factory installed refer to the application documentation.

## RESTORING YOUR PRE-INSTALLED SOFTWARE

The Drivers and Applications Restore (DAR) DVD contains sets of device drivers and Fujitsu utilities (in specific directories) that are unique to your computer configuration for use as documented below.



In order to install applications and/or drivers from the DAR DVD, you will need to use a DVD drive either in your system or attached externally.



If you have access to the internet, visit the Fujitsu Support website at <http://www.computers.us.fujitsu.com/support> to check for the most current information, drivers and hints on how to perform recovery and system updates.

### Re-Installing Individual Drivers and Applications

The Drivers and Applications CD can be used to selectively re-install drivers and/or applications that may have been un-installed or corrupted.



There may be certain free third-party applications pre-installed on your system that are not on the DAR CD. The latest versions of the applications can be downloaded from the third-party's website.

To re-install drivers and/or applications:

1. Boot up the system and insert the DAR CD after Windows has started. A Fujitsu Installer screen is displayed after the CD is inserted.
2. After reading the License Agreement, click [I agree].
3. A window will appear containing a list of applications, drivers, and utilities that you can install from the Drivers and Applications CD.



The components listed are color-coded in terms of their install status. Blue indicates that the component can be installed. Green indicates that the component needs to be installed separately. Grey indicates a component that is already installed; grey items can be reinstalled, but prior to installation you will receive a reminder that the component is already installed.

4. In the list, check off all the components you want to install. If you want to install all components, click [Select All]. Clicking [Select All] will select all of the blue-coded components; you must select grey and green components separately.

5. Once you have selected the components you wish to install, click [Install Selected Subsystems]; the components will be installed.
6. After the components are installed, click [OK], then click [Yes] when asked if you want to reboot the system.

## RESTORING THE FACTORY IMAGE

The Restore Disc that came with your system contains two utilities:

- The **Recovery** utility allows you to restore the original contents of the C: drive.
- The **Hard Disk Data Delete** utility on this disc is used to delete all data on your hard disk and prevent it from being reused. Do not use the Hard Disk Data Delete utility unless you are absolutely certain that you want to erase your entire hard disk, including all partitions.



- The use of this disc requires that you have a device capable of reading DVDs attached to your system. If you do not have a built-in DVD player, you will need to attach an external player. For more information on available external devices, visit our website at: [us.fujitsu.com/computers](http://us.fujitsu.com/computers).

- This disc can only be used with the system with which it was purchased.

## BOOT Priority Change

Before restoring an image, you must first verify that your system is set up to boot from the DVD drive. To verify/change the boot-up priority (rather than booting-up from the hard drive or an external floppy disk drive), perform one of the following procedures:

### Changing priority from BIOS Setup utility:

1. Start your system and press the [F2] key when the Fujitsu logo appears. You will enter the BIOS Setup Utility. Or..., press the [Enter] key or the left mouse button when the Fujitsu logo appears. The TrustedCore Menu will appear. Select BIOS Setup from the TrustedCore Menu.
2. Using the arrow keys, go to the Boot menu.
3. Arrow down to the Boot Device Priority submenu. Press [Enter].
4. If "Optical Media Drive" or "CD-ROM Drive" is not at the top of the list, arrow down to the drive in the list, and press the space bar (or the + key) to move it to the top of the list (the system attempts to boot from the devices in the order in which they are listed). Note that the BIOS for some systems will

indicate “CD-ROM Drive”, even when a DVD drive is connected.

5. If you have an *external* DVD drive connected, proceed to the next step; otherwise, proceed to step 7.
6. If you have an external DVD drive connected:
  - Select the Advanced menu in the BIOS window.
  - Scroll down to the USB Features submenu and press the Enter key to open it.
  - If Legacy USB Support is disabled, press the space bar to enable it.
  - Scroll down to SCSI SubClass Support and press the space bar to enable it.
7. Press [F10], then click on [Yes] to exit the BIOS Setup Utility and return to the boot process.

#### Changing priority from BOOT Menu:

1. Start your system and press the [F12] key when the Fujitsu logo appears. You will open the Boot Menu window.
2. Using the arrow keys, select the device from which you want to boot.
3. Press [Enter]. Note that this is a one-time boot priority. To change the boot priority for a longer period, perform the steps above in “Changing priority from BIOS Setup utility”.

After you have changed the boot priority, you can restore a backup image when you are booting up.

#### Procedure

1. Turn on the power to your system.
2. Ensure that you have a device that can read DVDs either installed in your system or attached externally to it.
3. Insert the Restore Disc into the drive tray.
4. Reboot your system.
5. After the system reboots, follow the instructions that appear to either restore your system image or erase all data from your hard disk.

## AUTOMATICALLY DOWNLOADING DRIVER UPDATES

Your system has a convenient tool called the Fujitsu Driver Update (FDU) utility. With FDU, you can choose to automatically or manually go to the Fujitsu site to check for new updates for your system.

The FDU icon should appear in the system tray at the bottom right of your screen (roll the cursor over the icons to find the correct one). If the FDU icon does not appear in the system tray, it can be started by going to [Start] -> All Programs, and clicking on Fujitsu Driver Update; this will create the icon automatically.

To invoke the FDU menu, right-click on the FDU icon. The menu contains the following items:

- **Check for updates now**  
Allows for manual driver update search. The first time it is used, you are prompted to agree to a user agreement. After clicking on the icon, the FDU automatically connects with the Fujitsu site to check for updates and downloads them. While downloading, the icon has a red bar through it, indicating that it cannot be used while the download is in process. When the update is complete, a message appears informing you of the fact.
- **Enable Automatic Update Notifications**  
Automatically searches for new updates on a regular basis (approximately every 3 days).
- **Show update history**  
Brings up a screen that displays a history of updates that have been made via the FDU.
- **About Fujitsu Driver Update**  
Displays the FDU version number and copyright information
- **Fujitsu Driver Update Readme**  
Displays the FDU readme.



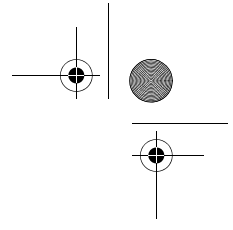
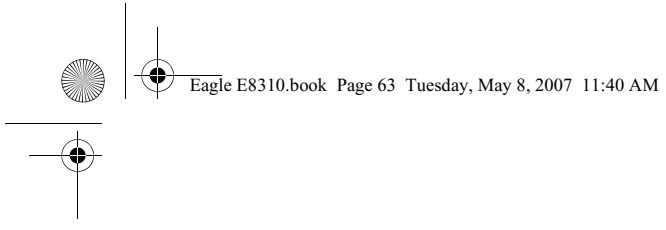

# 6 Care and Maintenance

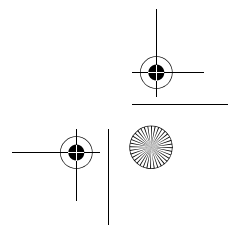
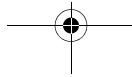
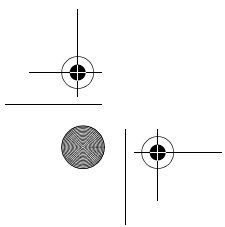
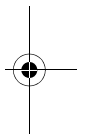
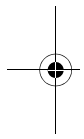

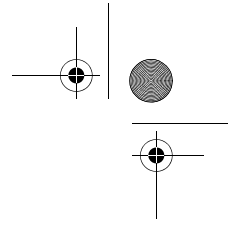
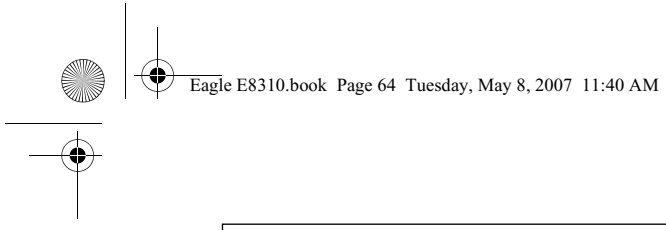

LifeBook E8000 Notebook

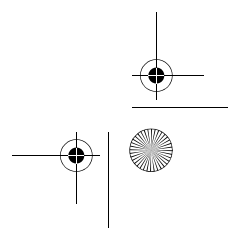
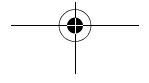
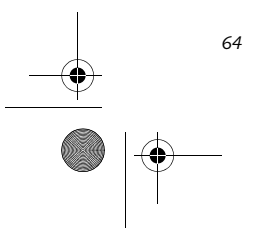
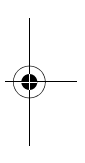
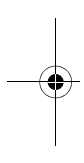

## Care and Maintenance

If you use your Fujitsu LifeBook notebook carefully, you will increase its life and reliability. This section provides some tips for looking after the notebook and its devices.



- The system contains components that can be severely damaged by electrostatic discharge (ESD). To minimize risk to the components, observe the following precautions:
  - Before docking or undocking your LifeBook notebook (when using a port replicator), it is a good practice to always touch a grounded metal object to discharge static electricity built up in your body.
  - Be sure to power down your system before adding or removing system components. Even if the system is in hibernate or standby states, data could be lost or memory could be damaged if power is still available to the system.
  - When installing or removing a memory module, hold it by the edge so as not to touch any contacts or chips. Be careful not to touch any internal computer terminals or components; the oil from your fingers could cause a short to the components.
  - Electrical equipment may be hazardous if misused. Operations of this product or similar products, must always be supervised by an adult. Do not allow children access to the interior of any electrical products and do not permit them to handle any cables.

### Caring for your LifeBook notebook

- Your LifeBook notebook is a durable but sensitive electronic device. Treat it with respect and care.
- Make a habit of transporting it in a suitable carrying case.
- Do not attempt to service the computer yourself.
- Always follow installation instructions closely.
- Keep it away from food and beverages.
- To protect your notebook from damage and to optimize system performance, be sure to **keep all air all vents unobstructed, clean, and clear of debris**. This may require periodic cleaning, depending upon the environment in which the system is used.

- Do not operate the notebook in areas where the air vents can be obstructed, such as in tight enclosures or on soft surfaces like a bed or cushion.
- If you accidentally spill liquid on your LifeBook notebook:
  1. Turn it off.
  2. Position it so that the liquid can run out.
  3. Let it dry out for 24 hours, or longer if needed.
  4. If your notebook will not boot after it has dried out, call your support representative.
- Do not use your Fujitsu LifeBook notebook in a wet environment (near a bathtub, swimming pool).
- Always use the AC adapter and batteries that are approved for your notebook.
- Avoid exposure to sand, dust and other environmental hazards.
- Do not expose your notebook to direct sunlight for long periods of time as temperatures above 140° F (60° C) may damage your notebook.
- Keep the covers closed on the connectors and slots when they are not in use.
- Do not put heavy or sharp objects on the computer.
- If you are carrying your LifeBook notebook in a briefcase, or any other carrying case, make sure that there are no objects in the case pressing on the lid.
- Never position your notebook such that the optical drive is supporting the weight of the notebook.
- Do not drop your notebook.
- Do not touch the screen with any sharp objects.

### Cleaning your LifeBook notebook

- Always disconnect the power plug. (Pull the plug, not the cord.)
- Clean your LifeBook notebook with a damp, lint-free cloth. Do not use abrasives or solvents.
- Use a soft cloth to remove dust from the screen. Never use glass cleaners.

### Storing your LifeBook notebook





- If storing your notebook for a month or longer, turn your LifeBook notebook off, fully charge the battery(s), then remove and store all Lithium ion batteries.
- Store your notebook and batteries separately. If you store your LifeBook with a battery installed, the battery will discharge, and battery life will be reduced. In addition, a faulty battery might damage your LifeBook.

**LifeBook E8000 Notebook**

- Store your Fujitsu LifeBook in a cool, dry location. Temperatures should remain between 13°F (-25°C) and 140°F (60°C).

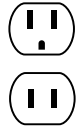
**Traveling with your LifeBook notebook**

- Do not transport your notebook while it is turned on.
- You should carry your notebook with you while traveling, rather than checking it in as baggage.
- Always bring your System Recovery CD that came with your notebook when you travel. If you experience system software problems while traveling, you may need it to correct any problems.
- Never put your notebook through a metal detector. Have your notebook hand-inspected by security personnel. You can however, put your notebook through a properly tuned X-ray machine. To avoid problems, place your notebook close to the entrance of the machine and remove it as soon as possible or have your notebook hand-inspected by security personnel. Security officials may require you to turn your notebook On. Make sure you have a charged battery on hand.
- When traveling with the hard drive removed, wrap the drive in a non-conducting materials (cloth or paper). If you have the drive checked by hand, be ready to install the drive if needed. Never put your hard drive through a metal detector. Have your hard drive hand-inspected by security personnel. You can however, put your hard drive through a properly tuned X-ray machine.
- Take the necessary plug adapters if you're traveling overseas. Check the following diagram to determine which plug adapter you'll need or ask your travel agent.

Outlet Type	Location
	United States, Canada, parts of Latin America, Mexico, Japan, Korea, the Philippines, Taiwan
	Russia and the Commonwealth of Independent States (CIS), most of Europe, parts of Latin America, the Middle East, parts of Africa, Hong Kong, India, most of South Asia
	United Kingdom, Ireland, Malaysia, Singapore, parts of Africa
	China, Australia, New Zealand

**BATTERIES**

**Caring for your Batteries**

- Always handle batteries carefully.
- Do not short-circuit the battery terminals (that is, do not touch both terminals with a metal object). Do not carry loose batteries in a pocket or purse where they may mix with coins, keys, or other metal objects. Doing so may cause an explosion or fire.
- Do not drop, puncture, disassemble, mutilate or incinerate the battery.
- Recharge batteries only as described in this manual and only in ventilated areas.
- Do not leave batteries in hot locations for more than a day or two. Intense heat can shorten battery life.
- Do not leave a battery in storage for longer than 6 months without recharging it.

**Increasing Battery Life**

- Power your LifeBook notebook through the AC or optional auto/airline adapter whenever possible.
- If your notebook is running on battery power all day, connect it to the AC adapter overnight to recharge the battery.
- Keep brightness to the lowest level comfortable.
- Set the power management for maximum battery life.
- Put your notebook in Suspend mode when it is turned on and you are not actually using it.
- Limit your media drive access.
- Disable the Media Player auto insert notification function.
- Always use fully charged batteries.
- Eject PCMCIA™ Cards when not in use.

**FLOPPY DISKS AND DRIVES**

**Caring for your Floppy Disks**

If you have an optional external floppy disk drive:

- Avoid using the floppy disks in damp and dusty locations.
- Never store a floppy disk near a magnet or magnetic field.
- Do not use a pencil or an eraser on a disk or disk label.
- Avoid storing the floppy disks in extremely hot or cold locations, or in locations subject to severe temperature changes. Store at temperatures between 50° F (10°C) and 125°F (52°C).

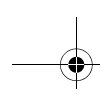

## Care and Maintenance

- Do not touch the exposed part of the disk behind the metal shutter.
- Never use the floppy disk drive with any liquid, metal, or other foreign matter inside the floppy disk drive or disk.
- Never disassemble your floppy disk drive.

### MEDIA CARE

#### Caring for your Media (DVD/CD/CD-R)

Media discs are precision devices and will function reliably if given reasonable care.

- Always store your media disc in its case when it is not in use.
- Always handle discs by the edges and avoid touching the surface.
- Avoid storing any media discs in extreme temperatures.
- Do not bend media discs or set heavy objects on them.
- Do not spill liquids on media discs.
- Do not scratch media discs.
- Do not get dust on media discs.
- Never write on the label surface with a ballpoint pen or pencil. Always use a felt pen.
- If a media disc is subjected to a sudden change in temperature, cold to warm condensation may form on the surface. Wipe the moisture off with a clean, soft, lint free cloth and let it dry at room temperature. DO NOT use a hair dryer or heater to dry media discs.
- If a disc is dirty, use only a DVD/CD cleaner or wipe it with a clean, soft, lint free cloth starting from the inner edge and wiping to the outer edge.

#### Caring for your Optical Drive

Your optical drive is durable but you must treat it with care. Please pay attention to the following points:

- The drive rotates the compact disc at a very high speed. Do not carry it around or subject it to shock or vibration with the power on.
- Avoid using or storing the drive where it will be exposed to extreme temperatures.
- Avoid using or storing the drive where it is damp or dusty.
- Avoid using or storing the drive near magnets or devices that generate strong magnetic fields.
- Avoid using or storing the drive where it will be subjected to shock or vibration.
- Do not disassemble or dismantle the optical drive.
- Use of a commercially available lens cleaner is recommended for regular maintenance of your drive.

### PC CARDS/EXPRESSCARDS

#### Caring for your Cards

PC Cards and ExpressCards are durable, but you must treat them with care. The documentation supplied with your card will provide specific information, but you should pay attention to the following points:

- To keep out dust and dirt, store cards in their protective sleeves when they are not installed in your LifeBook notebook.
- Avoid prolonged exposure to direct sunlight or excessive heat.
- Keep the cards dry.
- Do not flex or bend the cards, and do not place heavy objects on top of them.
- Do not force cards into the slot.
- Avoid dropping cards, or subjecting them to excessive vibration.

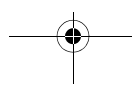
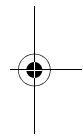
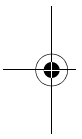

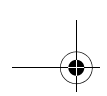

*LifeBook E8000 Notebook*

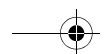
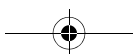
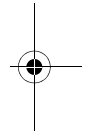
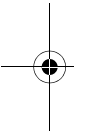

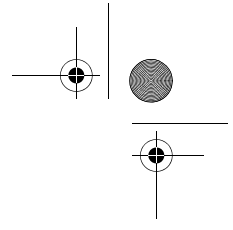
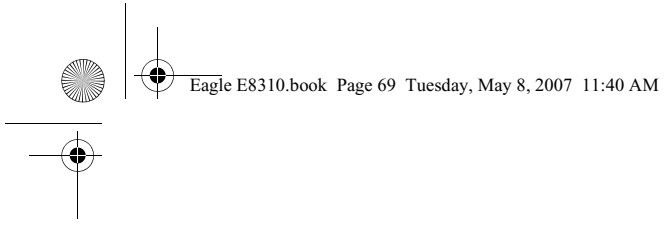

# 7 System Specifications

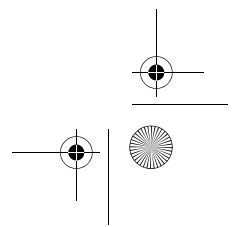
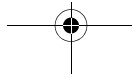
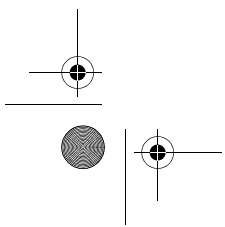
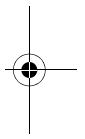
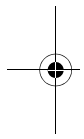

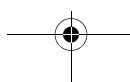
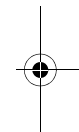
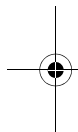



## Specifications

### Specifications

This section provides the hardware and environmental specifications for your Fujitsu LifeBook notebook. Specifications of particular configurations will vary.

### CONFIGURATION LABEL

There is a configuration label located on the bottom of your LifeBook notebook. This label contains specific information regarding the options you've chosen for your notebook. Following is an example label and information on how to read your own configuration label.

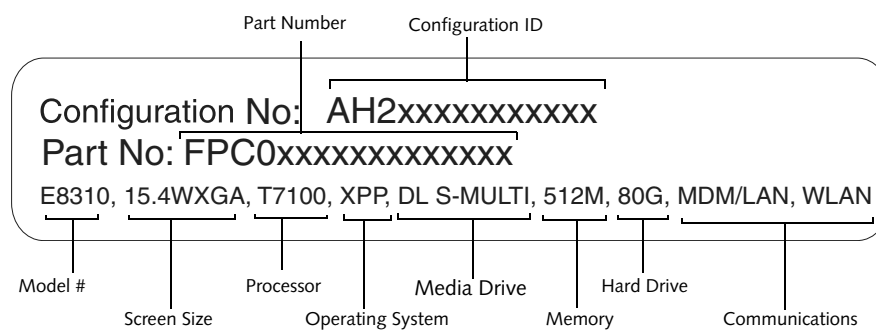

Figure 7-1 Configuration Label

### MICROPROCESSOR

Intel® Core™ 2 Duo processors (Refer to the system label to determine the speed of your processor).

### CHIPSET

- Intel GM965
- I/O Controller Hub 8 Mobile (ICH8-M)

### MEMORY

#### System Memory

- DDR2-667 MHz SDRAM dual-channel memory module.
- Two DIMM slots; upgradeable to 4 GB of total memory (2 GB x 2). Note that when 4 MB of memory is installed in a Windows Vista system, approximately 3.3 GB is addressable memory; the upper memory is reserved by Vista for hardware usage.

#### Cache Memory

2 MB or 4 MB L2 cache on-die, depending upon processor type

### VIDEO

Built-in color flat-panel TFT active matrix LCD display with simultaneous display capability.

#### Video Color and Resolution

15" XGA model:

- Internal: 1024 x 768 pixel resolution, 16M colors
- External: 1600 x 1200 pixel resolution, 16M colors
- Simultaneous: 1024 x 768, 16M colors

15" TFT SXGA+ model:

- Internal: 1400 x 1050 pixel resolution, 16M colors
- External: 1600 x 1200 pixel resolution, 16M colors
- Simultaneous: 1400 x 1050, 16M colors

### Video RAM

- Intel® Graphics Media Accelerator X3100 video graphics. Up to 384 MB shared video memory using Dynamic Video Memory Technology (DVMT)

### AUDIO

- Realtek codec ALC262 with 2-channel High Definition (HD) audio.
- Headphones**  
Stereo headphone/line-out jack, 3.5 mm, 1 V<sub>rms</sub> or less, minimum impedance 32 Ohms
- Microphone**  
Stereo microphone/line-in jack, 3.5 mm, 100 mV<sub>p-p</sub> or less, minimum impedance 10K Ohms
- Two built-in stereo speakers, 20 mm diameter

### MASS STORAGE DEVICE OPTIONS

#### Hard Drive

- Serial ATA, 150 Mbps data buffer, 5400 rpm, 2.5", 9.5 mm
- Choice of 40 GB, 60 GB, 80 GB, 100 GB, or 120 GB

#### Media Player

Depending upon the configuration of your system, one of the following is installed.

- DVD-ROM Drive: 8x maximum read, or,
- Combo DVD/CD-RW Drive: 24x CD-ROM, 24x CD-R, 10x CD-RW, 8x DVD-ROM, or,
- Dual-Layer Multi-Format DVD Writer: 24x CD-ROM, 24x CD-R, 10x CD-RW, 8x DVD-ROM, 5x DVD-RAM, 8x DVD-R, 4x DVD-R (DL), 6x DVD-RW, 8x DVD-R, 4x DVD-R (DL), 8x DVD-RW

## LifeBook E8000 Notebook

**FEATURES****Integrated Pointing Device**

- Touchpad pointing device with scroll button
- Optional Quick Point cursor control button

**Communications**

- **Modem:** Internal V.90 standard 56K fax/modem (ITU V.90, 56K data, 14.4K fax)
- **Gigabit LAN:** Internal wired 10/100/1000 Gigabit Ethernet LAN

**Wireless LAN:**

- Optional Integrated Intel PRO/Wireless 3945ABG Network Connection (802.11a+b/g)
- Optional Atheros AR5006EXS Mini-Card Wireless network card (802.11a+b/g)
- Optional Bluetooth device for wireless personal area network communication

**Trusted Platform Module**

The LifeBook E8310 has a Trusted Platform Module (TPM) installed for added system security.

**LifeBook Security/Application Panel**

The Application Launcher buttons on your LifeBook notebook default to the following applications:

Button Label	Button Function	Default Application
1	Application A	Notepad
2	Application B	Calculator
3	Internet	Internet Explorer
4	E-Mail	Outlook

Table 7-1 Application Launcher Defaults

**Theft Prevention Lock**

Two lock slots for use with security restraint systems.

**DEVICE PORTS****On the LifeBook notebook:**

- PC Card slot for one Type I or Type II card: PCMCIA Standard 2.1 with CardBus support
- ExpressCard slot for one ExpressCard
- Memory Stick/SD Card slot
- One 15-pin D-SUB connector for VGA external monitor (see Display specifications)
- Four USB 2.0 (Universal Serial Bus) connectors for input/output devices
- One DC In connector
- One serial port (RS-232, D-Sub 9-pin)
- One parallel port (ECP, D-Sub 25-pin)
- Infrared port (IrDA1.1, 4 Mbps max.)
- One 7-pin S-Video out jack
- One modular modem (RJ-11) connector
- One LAN (RJ-45) connector
- Docking port (100-pin, to dock with port replicator)
- One stereo headphone jack
- One mono microphone jack

- Dedicated Smart Card slot (requires third-party application)

**On the Optional Port Replicator:**

- One 6-pin mini DIN PS/2 compatible connectors for external keyboard or mouse
- One 25-pin D-SUB connector for parallel input/output devices; Bi-directional, output only or ECP
- One 15-pin D-SUB connector for VGA external monitor (see Display specifications)
- One 9-pin D-SUB connector for RS-232C serial input/output devices
- Four USB 2.0 connectors for input/output devices
- One LAN (RJ-45) connector
- One DC-in connector
- One microphone in jack
- One headphone jack
- One power/suspend/resume button with LED

**KEYBOARD**

Built-in keyboard with all functions of 101 key PS/2 compatible keyboards.

- Total number of keys: 84
- Function keys: F1 through F12
- Feature extension key: Fn
- Two Windows keys: one Start key, one Application key
- Key pitch: 19 mm
- Key stroke: 2.7 mm
- Built-in Touchpad pointing device with two left and two right buttons and scroll button.
- Optional Quick Point cursor control button
- Built-in Palm Rest

**External Keyboard and/or Mouse Support**

USB or PS/2-compatible (PS/2 compatible with Port Replicator only)

**POWER****Batteries**

- Standard Lithium ion battery, rechargeable, 6-cell 10.8V, 5200 mAh, 56.1 Wh, or,
- Optional Flexible Bay battery: 6-cell Lithium ion battery, rechargeable, 10.8V, 3800 mAh, 41 Wh

**AC Adapter**

Autosensing 100-240V AC, supplying 19V DC, 5.27A, 100W to the LifeBook notebook, including an AC cable.

**Power Management**

Conforms to ACPI (Advanced Configuration and Power Interface).

**DIMENSIONS AND WEIGHT****Overall Dimensions**

Approximately 14.06"(w) x 10.12"(d) x 1.40"/1.44"(h)  
(357 mm x 257 mm x 35.5/36.5 mm)

## Specifications

### Weight

15.0" XGA model: Approximately 5.93 lbs. (2.69 kg) with battery and optical drive

15.0" TFT SXGA+ model: Approximately 6.11 lbs. (2.77 kg) with battery and optical drive

### ENVIRONMENTAL REQUIREMENTS

#### Temperature

Operating: 41° to 95° F (5° to 35° C)

Non-operating: 5° to 140° F (-15° to 60° C)

#### Humidity

Operating: 20% to 85%, relative, non-condensing

Non-operating: 8% to 85%, relative, non-condensing

#### Altitude

Operating: 10,000 feet (3,048 m) maximum

### POPULAR ACCESSORIES

For ordering or additional information on Fujitsu accessories please visit our website at: [www.shopfujitsu.com](http://www.shopfujitsu.com) or call 1-800-FUJITSU.

### PRE-INSTALLED SOFTWARE

Depending on your pre-installed operating system, your notebook comes with pre-installed software for playing audio and video files of various formats. In addition there is file transfer software, virus protection software and Power Management software. The following list indicates the pre-installed software on your system.

- Adobe Acrobat Reader
- Norton Internet Security™ 2007 (90-day free trial)
- Roxio Easy Media Creator (on select models)
- CyberLink PowerProducer
- Google Desktop
- Google Picasa
- OmniPass Fingerprint application
- Fujitsu Driver Update utility
- Microsoft Office Small Business Edition 2007 (60-day free trial)
- Microsoft Works 8.5
- Evernote

### LEARNING ABOUT YOUR SOFTWARE

#### Tutorials

All operating systems and most application software have tutorials built into them upon installation. We highly recommend that you step through the tutorial before you use an application.

#### Manuals

Included with your notebook you will find manuals for your installed operating system and other pre-installed software. We recommend that you review these manuals for general information on the use of these applications.

### Adobe Acrobat Reader

Adobe Acrobat Reader allows you to view, navigate, and print PDF files from across all of the major computing platforms.

### Norton Internet Security 2007

Your system is preinstalled with a free 90-day trial version of Symantec's Norton Internet Security™ 2007. Norton Internet Security is a suite of tools designed to protect your LifeBook notebook from computer viruses, hackers, spyware, and spam. It assists in the protection of data currently on your hard disk from destruction or contamination. The trial version is activated upon your acceptance of software license agreement. After 90 days, you will need to purchase a subscription from Symantec to download latest virus, spyware, and spam definitions.

### Roxio Easy Media Creator

Easy Media Creator allows you to easily burn CDs and organize, edit and share digital photos, music, data, and videos.

### CyberLink PowerProducer

CyberLink PowerProducer allows you to produce and edit home movies and slideshows on discs.

### OmniPass Fingerprint application

The fingerprint sensor uses Softex OmniPass which provides password management capabilities to Microsoft Windows operating systems. OmniPass lets you use a "master password" for all Windows, applications, and on-line passwords, and presents a convenient user interface through which you can securely manage passwords, users, and multiple identities for each user.

### Google Desktop

Google Desktop lets you to search the contents of your computer for emails, web history, and files. It also allows you to view news and photos from anywhere on your desktop.

### Google Picasa

Google Picasa lets you to search for, locate, move and label all of the photos on your computer.

### Fujitsu Driver Update Utility

The Fujitsu Driver Update (FDU) utility is pre-installed on your system. With FDU, you can choose to automatically or manually go to the Fujitsu site to check for new updates for your system. (See *Automatically Downloading Driver Updates* on page 117 for more information)

### EverNote

EverNote allows you to easily capture, store and access a variety of documents, such as typed and handwritten memos, webpage excerpts, emails, phone messages, addresses, passwords, sketches, and documents.

### Operating System Options

Depending upon your system, one of the following operating system configurations will be installed:



*LifeBook E8000 Notebook*

**Microsoft Windows XP Professional Edition**  
With Microsoft Works 8.5 and Microsoft Office 60-day trial (Small Business Edition 2007)

**Microsoft Windows Vista Business Edition**  
With Microsoft Works 8.5 and Microsoft Office 60-day trial (Small Business Edition 2007)

**Microsoft Works 8.5**  
Microsoft Works 8.5 is a software suite containing the basic tools to write letters and reports, track family and friends with address books, manage home finances, and create a home inventory.

**Microsoft Office 2007 Small Business Edition**  
Microsoft Office 2007 Small Business Edition is easy-to-use software to help you manage business opportunities more effectively, create marketing materials, manage e-mail, and share information. Microsoft SBE includes Microsoft Word, Excel, Outlook, PowerPoint, Publisher, and Business Contact Manager.

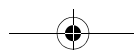
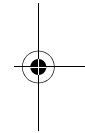
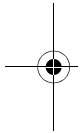

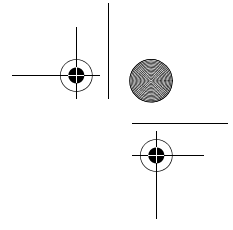
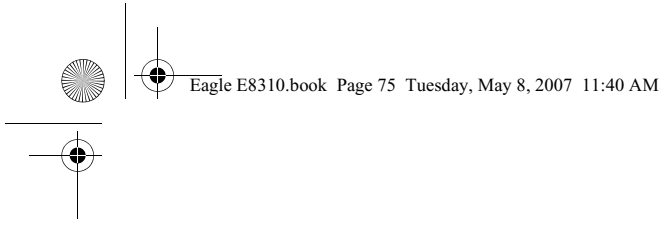

# 8 Glossary

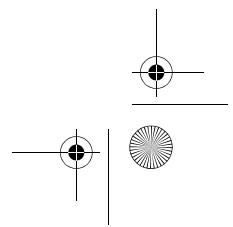
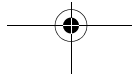
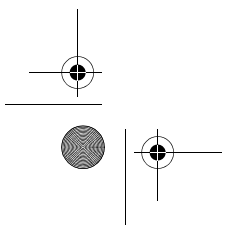
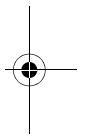
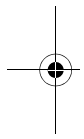

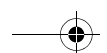
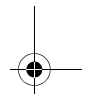
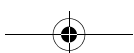
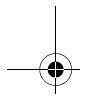
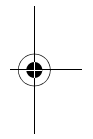
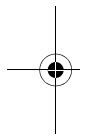
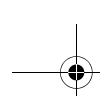

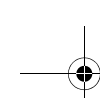

## Glossary

### AC Adapter

A device which converts the AC voltage from a wall outlet to the DC voltage needed to power your LifeBook notebook.

### ACPI

Advanced Configuration and Power Interface

### Active-Matrix Display

A type of technology for making flat-panel displays which has a transistor or similar device for every pixel on the screen.

### AdHoc

A name of a wireless LAN configuration.

It is a type of communication using wireless cards only.

Another type of communication is called Infrastructure (using a wireless card and an access point).

### ADSL

#### Asymmetric Digital Subscriber Line

Technology for transporting high bit-rate services over ordinary phone lines.

### AGP

Accelerated Graphics Port

Graphics port specifically designed for graphics-intensive devices, such as video cards and 3D accelerators.

### Auto/Airline Adapter

A device which converts the DC voltage from an automobile cigarette lighter or aircraft DC power outlet to the DC voltage needed to power your LifeBook notebook.

### BIOS

Basic Input-Output System. A program and set of default parameters stored in ROM which tests and operates your LifeBook notebook when you turn it on until it loads your installed operating system from disk. Information from the BIOS is transferred to the installed operating system to provide it with information on the configuration and status of the hardware.

### Bit

An abbreviation for binary digit. A single piece of information which is either a one (1) or a zero (0).

### bps

An abbreviation for bits per second. Used to describe data transfer rates.

### Boot

To start-up a computer and load its operating system from disk, ROM or other storage media into RAM.

### Bus

An electrical circuit which passes data between the CPU and the sub-assemblies inside your LifeBook notebook.

### Byte

8 bits of parallel binary information.

### Cache Memory

A block of memory built into the micro-processor which is much faster to access than your system RAM and used in specially structured ways to make your overall data handling time faster.

### CardBus

A faster, 32-bit version of the PC Card interface which offers performance similar to the 32-bit PCI architecture.

### CD-ROM

Compact disk read only memory. This is a form of digital data storage which is read optically with a laser rather than a magnetic head. A typical CD-ROM can contain about 600MB of data and is not subject to heads crashing into the surface and destroying the data when there is a failure nor to wear from reading.

### Channel

A radio frequency band used for communication between wireless cards and access points.

### CMOS RAM

Complementary metal oxide semiconductor random access memory. This is a technology for manufacturing random access memory which requires very low levels of power to operate.

### COM Port

Abbreviation for communication port. This is your serial interface connection.

### Command

An instruction which you give your operating system. Example: run a particular application or format a floppy disk.

### Configuration

The combination of hardware and software that makes up your system and how it is allocated for use.

### CRT

Cathode Ray Tube. A display device which uses a beam of electronic particles striking a luminescent screen. It

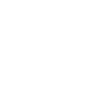
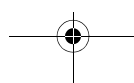

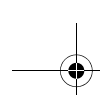

produces a visual image by varying the position and intensity of the beam.

**Data**

The information a system stores and processes.

**DC**

Direct current. A voltage or current that does not fluctuate periodically with time.

**Default Value**

A pre programmed value to be used if you fail to set your own.

**DHCP**

Dynamic Host Configuration Protocol

A protocol used to automatically acquire parameters required for the communication, such as IP address.

The sender of IP address is called a DHCP server, and the receiver is called a DHCP client.

**DIMM**

Dual-in-line memory module.

**Disk**

A spinning platter of magnetic data storage media. If the platter is very stiff it is a hard drive, if it is highly flexible it is a floppy disk, if it is a floppy disk in a hard housing with a shutter it is commonly called a diskette.

**Disk Drive**

The hardware which spins the disk and has the heads and control circuitry for reading and writing the data on the disk.

**Diskette**

A floppy disk in a hard housing with a shutter.

**DMA**

Direct Memory Access. Special circuitry for memory to memory transfers of data which do not require CPU action.

**DMI**

Desktop Management Interface. A standard that provides PC management applications with a common method of locally or remotely querying and configuring PC computer systems, hardware and software components, and peripherals.

**DNS**

Domain Name System

A function to control the association between the IP address and the name assigned to the computer.

If you do not know the IP address but if you know the computer name, you can still communicate to that computer.

**DOS**

Disk Operating System (MS-DOS is a Microsoft Disk Operating System).

**Driver**

A computer program which converts application and operating system commands to external devices into the exact form required by a specific brand and model of device in order to produce the desired results from that particular equipment.

**DVMT**

Dynamic Video Memory Technology

A video memory architecture that increases the efficiency of the motherboard by using innovative memory utilization and direct AGP.

**ECP**

Extended Capability Port. A set of standards for high speed data communication and interconnection between electronic devices.

**Encryption Key (Network Key)**

Data encryption key used to encrypt message text and for computing message integrity checks. Data encryption protects data from unauthorized viewing.

This device uses the same encryption key to encode and decode the data, and the identical encryption key is required between the sender and receiver.

**ESD**

Electrostatic Discharge. The sudden discharge of electricity from a static charge which has built up slowly. Example: the shock you get from a doorknob on a dry day or the sparks you get from brushing hair on a dry day.

**Extended Memory**

All memory more than the 640KB recognized by MS-DOS as system memory.

**FCC**

Federal Communication Commission.

**Floppy Disk**

A spinning platter of magnetic data storage media which is highly flexible.

**GB**

Gigabyte.

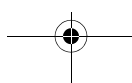



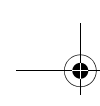

## Glossary

### Hard drive

A spinning platter of magnetic data storage media where the platter is very stiff.

### I/O

Input/Output. Data entering and leaving your notebook in electronic form.

### I/O Port

The connector and associated control circuits for data entering and leaving your notebook in electronic form.

### IDE

Intelligent Drive Electronics. A type of control interface for a hard drive which is inside the hard drive unit.

### Infrared

Light just beyond the red portion of the visible light spectrum which is invisible to humans.

### Infrastructure

A name of a wireless LAN configuration. This type of communication uses an access point.

Another type of communication is called AdHoc.

### IP Address

An identifier for a computer or device on a TCP/IP network. Networks using the TCP/IP protocol route messages based on the IP address of the destination. The format of an IP address is a 32-bit numeric address written as four numbers separated by periods. Each number can be zero to 255. For example, 1.160.10.240 could be an IP address.

Within an isolated network, you can assign IP addresses at random as long as each one is unique. However, connecting a private network to the Internet requires using registered IP addresses (called Internet addresses) to avoid duplicates.

The four numbers in an IP address are used in different ways to identify a particular network and a host on that network. Three regional Internet registries -- ARIN, RIPE NCC and APNIC -- assign Internet addresses from the following three classes.

Class A - supports 16 million hosts on each of 126 networks

Class B - supports 65,000 hosts on each of 16,000 networks

Class C - supports 254 hosts on each of 2 million networks

The number of unassigned Internet addresses is running out, so a new classless scheme called CIDR is gradually

replacing the system based on classes A, B, and C and is tied to adoption of IPv6. (credit: webspedia.com)

### IR

An abbreviation for infrared.

### IrDA

Infrared Data Association. An organization which produces standards for communication using infrared as the carrier.

### IRQ

Interrupt Request. An acronym for the hardware signal to the CPU that an external event has occurred which needs to be processed.

### KB

Kilobyte.

### LAN

Local Area Network. An interconnection of computers and peripherals within a single limited geographic location which can pass programs and data amongst themselves.

### LCD

Liquid Crystal Display. A type of display which makes images by controlling the orientation of crystals in a crystalline liquid.

### Lithium ion Battery

A type of rechargeable battery which has a high power-time life for its size and is not subject to the memory effect as Nickel Cadmium batteries.

### LPT Port

Line Printer Port. A way of referring to parallel interface ports because historically line printers were the first and latter the most common device connected to parallel ports.

### MAC Address

Media Access Control Address

A unique physical address of a network card. For Ethernet, the first three bytes are used as the vendor code, controlled and assigned by IEEE. The remaining three bytes are controlled by each vendor (preventing overlap), therefore, every Ethernet card is given a unique physical address in the world, being assigned with a different address from other cards. For Ethernet, frames are sent and received based on this address.

### MB

Megabyte.

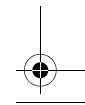
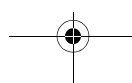
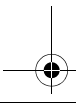
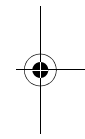
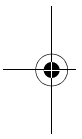

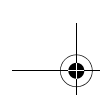
**Megahertz**

1,000,000 cycles per second.

**Memory**

A repository for data and applications which is readily accessible to your LifeBook notebook's CPU.

**MHz**

Megahertz.

**MIDI**

Musical Instrument Digital Interface. A standard communication protocol for exchange of information between computers and sound producers such as synthesizers.

**Modem**

A contraction for MOdulator-DEModulator. The equipment which connects a computer or other data terminal to a communication line.

**Monaural**

A system using one channel to process sound from all sources.

**MPU-401**

A standard for MIDI interfaces and connectors.

**MTU**

Maximum Transmission Unit

The maximum data size that can be transferred at a time through the Internet or other networks. You can set a smaller MTU size to obtain successful communication, if you have difficulty transferring data due to the fact that the maximum size is too large.

**Norton AntiVirus**

Web-based software that protects you email, instant messages, and other files by removing viruses, worms, and Trojan horses.

**NTSC**

National TV Standards Commission. The standard for TV broadcast and reception for the USA.

**Operating System**

A group of control programs that convert application commands, including driver programs, into the exact form required by a specific brand and model of micro-processor in order to produce the desired results from that particular equipment.

**Partition**

A block of space on a hard drive which is set aside and made to appear to the operating system as if it were a separate disk, and addressed by the operating system accordingly.

**PCI**

Peripheral Component Interconnect

Self-configuring PC local bus. Designed by Intel, PCI has gained wide acceptance as a standard bus design.

**PCMCIA**

PCMCIA is a trademark of the Personal Computer Memory Card International Association. The Personal Computer Memory Card International Association is an organization that sets standards for add-in cards for personal computers.

**Peripheral Device**

A piece of equipment which performs a specific function associated with but not integral to a computer. Examples: a printer, a modem, a CD-ROM.

**Pitch (keyboard)**

The distance between the centers of the letter keys of a keyboard.

**Pixel**

The smallest element of a display, a dot of color on your display screen. The more pixels per area the clearer your image will appear.

**POST**

Power On Self Test. A program which is part of the BIOS which checks the configuration and operating condition of your hardware whenever power is applied to your notebook. Status and error messages may be displayed before the operating system is loaded. If the self test detects failures that are so serious that operation can not continue, the operating system will not be loaded.

**PPP**

Point to Point Protocol

A protocol for Ethernet which is used for connection on the phone line.

**Program**

An integrated set of coded commands to your computers telling your hardware what to do and how and when to do it.

**Protocol**

Procedures and rules use to send and receive data between computers.

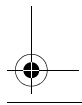
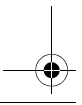
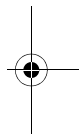
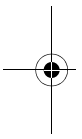

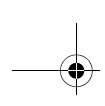

## Glossary

- Method of sending and receiving data
- Process used to handle communication errors

Conditions required for communication are organized in procedures for correct transfer of information.

### RAM

Random Access Memory. A hardware component of your LifeBook notebook that holds binary information (both program and data) as long as it has the proper power applied to it.

### RAM Module

A printed circuit card with memory and associated circuitry which allows the user to add additional memory to the computer without special tools.

### Reset

The act of reloading the operating system. A reset erases all information stored in RAM.

### Restart

See Reset.

### Resume

To proceed after interruption. In your notebook this refers to returning to active operation after having been in one of the suspension states.

### ROM

Read Only Memory. A form of memory in which information is stored by physically altering the material. Data stored in this way can not be changed by your notebook and does not require power to maintain it.

### SDRAM

Synchronous Dynamic Random Access Memory.

### Serial Port

A connection to another device through which data is transferred one bit at a time on a single wire with any other wires only for control of the device not for transfer of data.

### SMART

Self-Monitoring, Analysis and Reporting Technology (SMART) is an emerging technology that provides near-term failure predictions for hard drives. When SMART is enabled the hard drive monitors pre-determined drive attributes that are susceptible to degradation over time. If a failure is likely to occur, SMART makes a status report available so that the LifeBook notebook can prompt the user to back up the data on the drive. Naturally not all failures are predictable. SMART predictability is limited to those attributes which the drive can

self-monitor. In those cases where SMART can give advance warning, a considerable amount of precious data can be saved.

### SRAM

Static random access memory. A specific technology of making RAM which does not require periodic data refreshing.

### SSID

Service Set Identifier

Specifies which network you are joining. Some systems allow you to specify any SSID as an option so you can join any network.

### Standby

To make inoperative for a period of time. Your LifeBook notebook uses various suspension states to reduce power consumption and prolong the charge of your battery.

### Status Indicator

A display which reports the condition of some portion of your hardware. On your LifeBook notebook this is an LCD screen just above the keyboard.

### Stereo (audio)

A system using two channels to process sound from two different sources.

### SVGA

Super VGA.

### S-Video

Super Video. A component video system for driving a TV or computer monitor.

### System Clock

An oscillator of fixed precise frequency which synchronizes the operation of the system and is counted to provide time of day and date.

### TCP/IP

Transmission Control Protocol/Internet Protocol. A standard Internet protocol that is most widely used.

### TFT

Thin Film Transistor – A technology for flat display panels which uses a thin film matrix of transistors to control each pixel of the display screen individually.

### UL

Underwriters Laboratories – An independent organization that tests and certifies the electrical safety of devices.

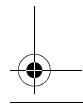
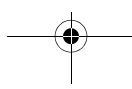
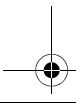
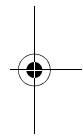
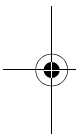

**USB**

Universal Serial Bus.

Standard that allows you to simultaneously connect up to 127 USB devices such as game pads, pointing devices, printers, and keyboards to your computer.

**VGA**

Video Graphics Array. A video display standard originally introduced by IBM with the PS/2 series of personal computers.

**VRAM**

Video Random Access Memory. A memory dedicated to video display data and control.

**WFM**

Wired for Management is Intel's broad-based initiative to reduce the total cost of ownership (TCO) of business computing without sacrificing power and flexibility.

**Wi-Fi Compatible**

Wi-Fi (Wireless Fidelity) Identifies that the product has passed the interoperability test, supplied by the WECA (Wireless Ethernet Compatibility Alliance), which guarantees the interoperability of wireless IEEE 802.11 LAN products. For more information on the Wi-Fi standard, go to the WECA website at: [www.wirelessethernet.com](http://www.wirelessethernet.com).

**WLAN**

Wireless Local Area Network. A wireless interconnection of computers and peripherals within a single limited geographic location which can pass programs and data amongst themselves.

**Write Protect**

Prevent alteration of the binary state of all bits in a storage media. Example: all information on a device such as a floppy diskette; a block of space in a storage media such as a partition of a hard drive; a file or directory of floppy diskette or hard drive.

**XGA**

Extended VGA.

**Zip Drive**

A 100MB or 250MB read/write removable media disk drive.

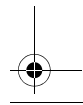
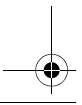
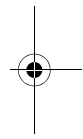
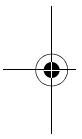

## Regulatory Information

### NOTICE

Changes or modifications not expressly approved by Fujitsu could void this user's authority to operate the equipment.

### FCC NOTICES

#### Notice to Users of Radios and Television

This equipment has been tested and found to comply with the limit for class B digital devices, pursuant to parts 15 of the FCC Rules.

These limits are designed to provide reasonable protection against harmful interference in a residential installation. This equipment generates, uses, and can radiate radio frequency energy and, if not installed and used in accordance with the instructions, may cause harmful interference to radio communications. However, there is no guarantee that interference will not occur in a particular installation. If this equipment does cause harmful interference to radio or television reception, which can be determined by turning the equipment off and on, the user is encouraged to try to correct the interference by one or more of the following measures:

- Reorient or relocate the receiving antenna.
- Increase the separation between the equipment and receiver.
- Connect the equipment into an outlet that is on a different circuit than the receiver.
- Consult the dealer or an experienced radio/TV technician for help.

Shielded interconnect cables must be employed with this equipment to ensure compliance with the pertinent RF emission limits governing this device.

#### Notice to Users of the US Telephone Network

This equipment complies with Part 68 of the FCC rules, and the requirements adopted by ACTA. On the bottom of this equipment is a label that contains, among other information, the FCC registration number and ringer equivalence number (REN) for this equipment; or a product identifier in the format US:AAAEQ##TXXXX. If requested, this information or number must be provided to the telephone company.

This equipment is designed to be connected to the telephone network or premises wiring using a standard jack type USOC RJ11C. A plug and jack used to connect this equipment to the premises wiring and telephone network must comply with the applicable FCC Part 68 rules and requirements adopted by the ACTA. A compliant telephone cord and modular plug is provided with this product. It is designed to be connected to a compatible modular jack that is also compliant.

The ringer equivalent number (REN) of this equipment is 0.1B as shown on the label. The REN is used to determine the number of devices that may be connected to a telephone line. Excessive RENs on a telephone may result in the devices not ringing in response to an incoming call. In most but not all areas, the sum of RENs should not exceed five (5.0). To be certain of the number of devices that may be connected to a line, as determined by the total RENs, contact the local telephone company.

If this equipment causes harm to the telephone network, the telephone company will notify you in advance that temporary discontinuance of service may be required. But if advance notice isn't practical, the telephone company will notify the customer as soon as possible. Also, you will be advised of your right to file a complaint with the FCC if you believe it is necessary.

The telephone company may make changes in its facilities, equipment, operations or procedures that could effect the operation of the equipment. If this happens the telephone company will provide advance notice in order for you to make necessary modifications to maintain uninterrupted service.

If trouble is experienced with this equipment, for repair or warranty information, please refer to the manual or contact Fujitsu Computer Systems Corporation, Customer Service. If the equipment is causing harm to the telephone network, the telephone company may request that you disconnect the equipment until the problem is resolved.

The equipment cannot be used on public coin service provided by the telephone company. Connection to party line service is subject to state tariffs. (Contact the state public utility commission, public service commission or corporation commission for information).

If your home has specially wired alarm equipment connected to the telephone line, ensure the installation of this computer does not disable your alarm equipment. If you have any questions about what will disable alarm equipment, consult your telephone company or a qualified installer.

The Telephone Consumer Protection Act of 1991 makes it unlawful for any person to use a computer or other electronic device to send any message via a telephone fax machine unless such message clearly contains in a margin at the top or bottom of each transmitted page or on the first page of the transmission, the date and time it is sent and an identification of the business or other entity, or other individual sending the message and the telephone number of the sending machine or such business, other entity, or individual.

LifeBook E8000 Notebook

**DOC (INDUSTRY CANADA) NOTICES**  
**Notice to Users of Radios and Television**

This Class B digital apparatus meets all requirements of Canadian Interference-Causing Equipment Regulations.

CET appareil numérique de la class B respecte toutes les exigences du Règlement sur le matériel brouilleur du Canada.

**Notice to Users of the Canadian Telephone Network**

**NOTICE:** This equipment meets the applicable Industry Canada Terminal Equipment Technical Specifications. This is confirmed by the registration number. The abbreviation, IC, before the registration number signifies that registration was performed based on a Declaration of Conformity indicating that Industry Canada technical specifications were met. It does not imply that Industry Canada approved the equipment.

Before connecting this equipment to a telephone line the user should ensure that it is permissible to connect this equipment to the local telecommunication facilities. The user should be aware that compliance with the certification standards does not prevent service degradation in some situations.

Repairs to telecommunication equipment should be made by a Canadian authorized maintenance facility. Any repairs or alterations not expressly approved by Fujitsu or any equipment failures may give the telecommunication company cause to request the user to disconnect the equipment from the telephone line.

**NOTICE:** The Ringer Equivalence Number (REN) for this terminal equipment is 0.1B. The REN assigned to each terminal equipment provides an indication of the maximum number of terminals allowed to be connected to a telephone interface. The termination on an interface may consist of any combination of devices subject only to the requirement that the sum of the Ringer Equivalence Numbers of all the devices does not exceed five.



For safety, users should ensure that the electrical ground of the power utility, the telephone lines and the metallic water pipes are connected together. Users should NOT attempt to make such connections themselves but should contact the appropriate electric inspection authority or electrician. This may be particularly important in rural areas.

**Avis Aux Utilisateurs Du Réseau Téléphonique Canadien**

**AVIS:** Le présent matériel est conforme aux spécifications techniques d'Industrie Canada applicables au matériel terminal. Cette conformité est confirmée par le numéro d'enregistrement. Le sigle IC, placé devant le numéro d'enregistrement, signifie que l'enregistrement s'est effectué conformément à une déclaration de conformité et indique que les spécifications techniques d'Industrie Canada ont été respectées. Il n'implique pas qu'Industrie Canada a approuvé le matériel.

Avant de connecter cet équipement à une ligne téléphonique, l'utilisateur doit vérifier s'il est permis de connecter cet équipement aux installations de télécommunications locales. L'utilisateur est averti que même la conformité aux normes de certification ne peut dans certains cas empêcher la dégradation du service.

Les réparations de l'équipement de télécommunications doivent être effectuées par un service de maintenance agréé au Canada. Toute réparation ou modification, qui n'est pas expressément approuvée par Fujitsu, ou toute défaillance de l'équipement peut entraîner la compagnie de télécommunications à exiger que l'utilisateur déconnecte l'équipement de la ligne téléphonique.

**AVIS:** L'indice d'équivalence de la sonnerie (IES) du présent matériel est de 0.1B. L'IES assigné à chaque dispositif terminal indique le nombre maximal de terminaux qui peuvent être raccordés à une interface téléphonique. La terminaison d'une interface peut consister en une combinaison quelconque de dispositifs, à la seule condition que la somme d'indices d'équivalence de la sonnerie de tous les dispositifs n'excède pas 5.



Pour assurer la sécurité, les utilisateurs doivent vérifier que la prise de terre du service d'électricité, les lignes téléphoniques et les conduites d'eau métalliques sont connectées ensemble. Les utilisateurs NE doivent PAS tenter d'établir ces connexions eux-mêmes, mais doivent contacter les services d'inspection d'installations électriques appropriés ou un électricien. Ceci peut être particulièrement important en régions rurales.

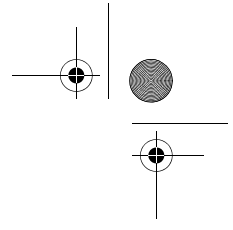
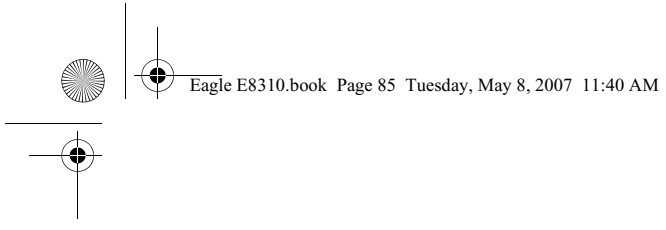

# Appendix A

## Integrated Wireless LAN\* User's Guide

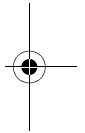
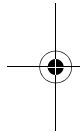

\* Optional device

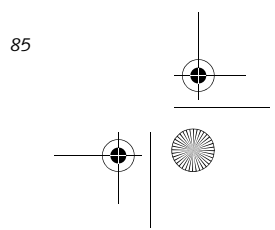
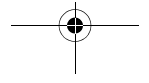
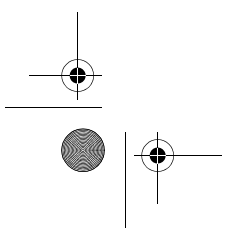

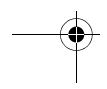
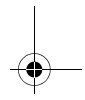
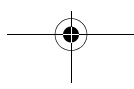
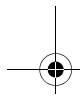
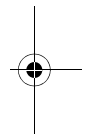
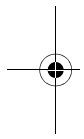
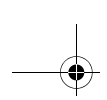



## **FC** FCC REGULATORY INFORMATION

Please note the following regulatory information related to the wireless LAN device.

### **Regulatory Notes and Statements** Wireless LAN, Health and Authorization for use

Radio frequency electromagnetic energy is emitted from Wireless LAN devices. The energy levels of these emissions, however, are far much less than the electromagnetic energy emissions from wireless devices such as mobile phones. Wireless LAN devices are safe for use by consumers because they operate within the guidelines found in radio frequency safety standards and recommendations. The use of Wireless LAN devices may be restricted in some situations or environments, such as:

- On board an airplane, or
- In an explosive environment, or
- In situations where the interference risk to other devices or services is perceived or identified as harmful.

In cases in which the policy regarding use of Wireless LAN devices in specific environments is not clear (e.g., airports, hospitals, chemical/oil/gas industrial plants, private buildings), obtain authorization to use these devices prior to operating the equipment.

### **Regulatory Information/Disclaimers**

Installation and use of this Wireless LAN device must be in strict accordance with the instructions included in the user documentation provided with the product. Any changes or modifications made to this device that are not expressly approved by the manufacturer may void the user's authority to operate the equipment. The manufacturer is not responsible for any radio or television interference caused by unauthorized modification of this device, or the substitution or attachment of connecting cables and equipment other than those specified by the manufacturer. It is the responsibility of the user to correct any interference caused by such unauthorized modification, substitution or attachment. The manufacturer and its authorized resellers or distributors will assume no liability for any damage or violation of government regulations arising from failure to comply with these guidelines.

This device must not be co-located or operated in conjunction with any other antenna or transmitter.

### **For IEEE 802.11a Wireless LAN:**

For operation within 5.15~5.25 GHz frequency range, it is restricted to indoor environments, and the antenna of this device must be integral.

### **Federal Communications Commission statement**

This device complies with Part 15 of FCC Rules.

Operation is subject to the following two conditions: (1) This device may not cause interference, and, (2) This device must accept any interference, including interference that may cause undesired operation of this device.

### **FCC Interference Statement**

This equipment has been tested and found to comply with the limits for a Class B digital device, pursuant to Part 15 of the FCC Rules. These limits are designed to provide reasonable protection against harmful interference in a residential installation. This equipment generates, uses, and can radiate radio frequency energy. If not installed and used in accordance with the instructions, it may cause harmful interference to radio communications. However, there is no guarantee that interference will not occur in a particular installation.

If this equipment does cause harmful interference to radio or television reception, which can be determined by turning the equipment off and on, the user is encouraged to try and correct the interference by one or more of the following measures:

1. Reorient or relocate the receiving antenna.
2. Increase the distance between the equipment and the receiver.
3. Connect the equipment to an outlet on a circuit different from the one the receiver is connected to.
4. Consult the dealer or an experienced radio/TV technician for help.

### **FCC Radio Frequency Exposure statement**

This equipment complies with FCC radiation exposure limits set forth for an uncontrolled environment. This equipment should be installed and operated with a minimum distance of 20 centimeters between the Wireless LAN antenna (located on the top edge of the LCD screen) and your body. The transmitters in this device must not be co-located or operated in conjunction with any other antenna or transmitter.

### **Export restrictions**

This product or software contains encryption code which may not be exported or transferred from the US or Canada without an approved US Department of Commerce export license. This device complies with Part 15 of FCC Rules., as well as ICES 003 B / NMB 003 B. Operation is subject to the following two conditions: (1) this device may not cause harmful interference, and (2) this device must accept any interference received, including interference that may cause undesirable operation. Modifications not expressly authorized by Fujitsu Computer Systems Corporation may invalidate the user's right to operate this equipment.

### **Canadian Notice**

The device for the 5150 - 5250 MHz band is only for indoor usage to reduce the potential for harmful interference to co-channel mobile satellite systems.

## Before Using the Wireless LAN

This manual describes the procedures required to properly set up and configure the integrated Wireless LAN Mini-PCI device (referred to as "WLAN device" in the rest of the manual). Before using the WLAN device, read this manual carefully to ensure its correct operation. Keep this manual in a safe place for future reference.

### Wireless LAN Device Covered by this Document

This document is applicable to systems containing one of the following two devices. Most of the procedures are identical. Sections that differ between the two devices have been noted in the text:

- Intel® PRO/Wireless 3945ABG (WM3945ABG) Network Connection (802.11a+b/g)
- Atheros® AR5006EXS (AR5BXB6) Mini-Card Wireless network card (802.11a+b/g)

### Characteristics of the WLAN Device

- The WLAN device is a Mini-PCI card attached to the main board of the mobile computer.
- It operates in two license-free RF bands, therefore eliminating the need to procure an FCC license to operate. It operates in the 2.4GHz Industrial, Scientific, and Medical (ISM) RF band and in the lower and middle bands of the 5GHz Unlicensed National Information Infrastructure (UNII) bands.
- The WLANs are capable of three operating modes, IEEE802.11a, IEEE802.11b and IEEE802.11g, wireless LAN standards governed by the IEEE (Institute of Electronics and Electrical Engineers).
- Encoding of data is modulated using Direct Sequence Spread Spectrum (DSSS) and Complementary Code Keying (CCK) when the WLAN device is operating in IEEE 802.11b mode and Orthogonal Frequency Division Multiplexing

(OFDM) when operating in IEEE802.11a or IEEE802.11g mode.

- The WLAN device is Wi-Fi certified and operates at the maximum data transfer rate of 54 Mbps in IEEE802.11a or IEEE802.11g mode and 11 Mbps in IEEE802.11b mode.
- The WLAN device supports the following encryption methods - WEP, TKIP, and AES encryption.

### WIRELESS LAN MODES USING THIS DEVICE

#### Ad Hoc Mode

(See Figure A-1) "Ad Hoc Mode" refers to a wireless network architecture where wireless network connectivity between multiple computers is established without a central wireless network device, typically known as Access Point(s). Connectivity is accomplished using only client devices in a peer-to-peer fashion. That is why Ad Hoc networks are also known as peer-to-peer networks. Ad Hoc networks are an easy and inexpensive method for establishing network connectivity between multiple computers.

Ad Hoc mode requires that the SSID, network authentication, and encryption key settings are identically configured on all computers in the Ad Hoc network.

#### Access Point (Infrastructure) Mode

(See Figure A-2) Infrastructure mode refers to a wireless network architecture in which devices communicate with wireless or wired network devices by communicating through an Access Point. In infrastructure mode, wireless devices can communicate with each other or with a wired network. Corporate wireless networks operate in infrastructure mode because they require access to the WLAN in order to access services, devices, and computers (e.g., file servers, printers, databases).

Figure A-1. Ad Hoc Mode Network

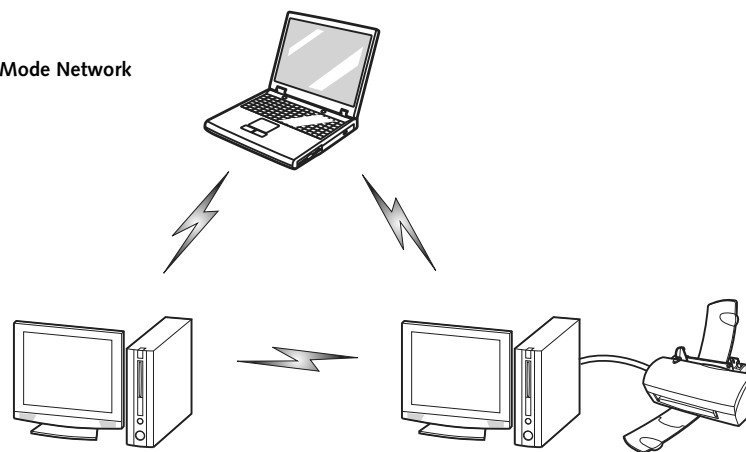

### How to Handle This Device

The WLAN device is an optional device that may come pre-installed in your mobile computer. Under normal circumstances, it should not be necessary for you to remove or re-install it. The Operating System that your mobile computer comes with has been pre-configured to support the WLAN device.

### WIRELESS NETWORK CONSIDERATIONS

- The WLAN devices support IEEE802.11a+b/g.
- The devices operate in the 2.4GHz ISM band and the 5 GHz lower and middle UNII bands.
- The maximum range of the WLAN device indoors is typically 80 feet (25 meters). Please note that the maximum range you achieve may be shorter or longer than 80 feet, depending on factors such as access point transmit power, number and density of obstructions, or external RF interference.
- Microwave ovens will interfere with the operation of WLAN device as microwave ovens operate in the same 2.4GHz frequency range that IEEE802.11b/g devices operate in. Interference by microwaves does not occur with IEEE802.11a radio which operates in the 5 GHz RF band.
- Wireless devices that transmit in the 2.4 GHz frequency range may interfere with the operation of WLAN devices in IEEE802.11b/g modes. Interference symptoms include reduced throughput, intermittent disconnects, and large amounts of frame errors. It is HIGHLY recommended that interfering devices be powered off to ensure proper operation of the WLAN.

### DEACTIVATING THE WLAN DEVICE

Deactivation of the WLAN device may be desired in certain circumstances (to extend battery life) or where certain environments require it (i.e. hospitals, clinics, airplanes, etc.). Fujitsu mobile computers employ two methods with which to deactivate the WLAN device:

- Using the Wireless On/Off Switch, or,
- In Windows XP, using the Intel PROSet Software or Atheros Client Utility software.



Before using the wireless LAN device, you must first install ClickMe! to ensure that the correct software for your device is installed. (See *Installing Click Me!* on page 28 for more information)

### Deactivation using the Wireless On/Off Switch

The WLAN device can be deactivated quickly and efficiently by toggling the Wireless On/Off Switch to the Off position. (Figure A-3)

The Wireless On/Off switch has no effect on non-Wireless LAN models.

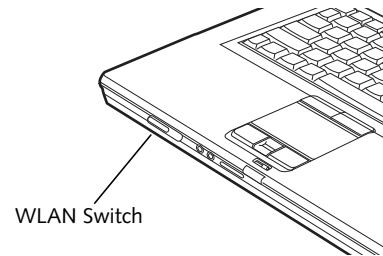
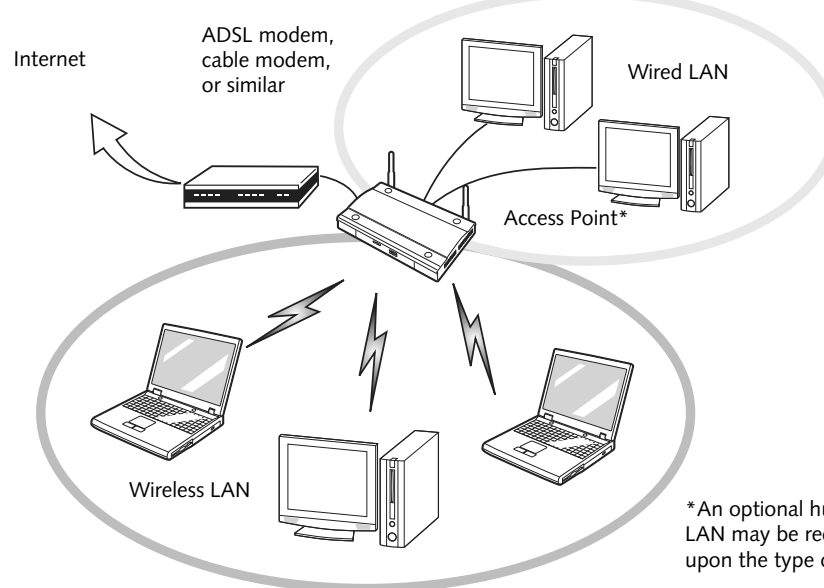

Figure A-3. Wireless LAN On/Off Switch

Figure A-2. Access Point(Infrastructure) Mode Network



\*An optional hub for a wired LAN may be required depending upon the type of access point used.

The Wireless LAN/Bluetooth On/Off Switch will power off both the optional wireless LAN and Bluetooth devices at the same time. To enable or disable either one of the devices individually, perform the following steps:



1. Slide the Wireless LAN/Bluetooth on/off switch to On position.
2. XP: In the Control Panel, double-click the Fujitsu Radio Control icon. Vista: Use the Bluetooth icon in the system tray to disable Bluetooth radio.
3. In the window that appears, click the button associated with Bluetooth and/or Wireless LAN Status to enable or disable the individual devices.
4. Click [OK].

#### Windows XP: Deactivation using the Intel PROSet Software

The WLAN device can also be deactivated in Windows using the Intel PROSet Software. The procedure to accomplish this:

1. Click [Start]-> [All Programs].
2. Select Intel ProSet Wireless, then click on Intel ProSet Wireless from the menu that appears. The Intel ProSet Wireless utility will be displayed.
3. At the bottom left corner of the window, select Wireless Off from the dropdown list.

#### Windows XP: Deactivation using Atheros Client Utility software

1. Click [Start] -> [Program Files] -> [Atheros] -> Atheros Client Utility.
2. Choose Action and click Disable Radio.

#### ACTIVATING THE WLAN DEVICE

Activation of the WLAN device can be accomplished using the same methods as the deactivation process.

- Using the Wireless On/Off Switch
- In Windows XP, using the Intel PROSet Software or Atheros Software.

## Configuration of the WLAN Device

The optional WLAN Device can be configured to establish wireless network connectivity using one of the following tools:

- Intel PROSet Software - The Intel PROSet Software allows for multiple profile setup and supports automatic profile switching. Support for most industry standard security solutions is contained in this software.
- Atheros Client Utility - The Atheros Client Utility software allows for multiple profile setups and supports automatic profile switching. Support for most industry standard security solutions is contained in this software.

There are two procedures outlines below. The first one is for use with the Windows Vista operating system, and the other is used with the Windows XP operating system.

### CONFIGURING THE WLAN WITH WINDOWS VISTA

The WLAN device can be configured to establish wireless network connectivity using the software that is built into Windows Vista. Support for most industry standard security solutions is contained in this software.

Pre-defined parameters will be required for this procedure. Please consult with your network administrator for these parameters:

1. Click the Start button, then select Control Panel.
2. If the Control Panel is not in Classic View, select Classic View from the left panel. Double-click the Network and Sharing Center icon.
3. Select "Manage wireless networks" from the left panel.
4. Click on the [Add] button.
5. Depending upon what type of connection you would like to make, make a selection. For an infrastructure network, select "Manually create a network profile. For ad hoc network, select "Create an ad hoc network".
6. Enter the required information. It may be necessary to consult with your network administrator for some of the information.
7. In the event you require assistance, go to the Network and Sharing Center window (Start -> Control Panel -> Network and Sharing Center), and type in relevant keywords in the Search box.

### CONNECTING TO A NETWORK WITH WINDOWS VISTA

After you have configured your computer, you can connect to an active network by performing the following steps:

1. Click on the WLAN icon in the system tray.
2. Select "connect to a network".
3. Select a network from the list that appears, and click the [Connect] button.

### CONFIGURING THE WLAN USING WINDOWS XP

#### Configuring Using Intel PROSet Software

This section explains the procedure to properly configure the WLAN device in a system using Windows XP using the Intel PROSet Software. Pre-defined parameters will be required for this procedure. Please consult with your network administrator for these parameters:

**Network Name** - Also known as the SSID

**Network Key (WEP)** - Required if using static WEP keys.

**Authentication Type** - Open, Shared, WPA, or WPA-PSK

#### Procedure

1. Activate the WLAN device using either the Wireless On/Off Switch or the Intel PROSet software.
2. Click the [Start] button first and then [All Programs].
3. Click the icon [Intel PROSet Wireless] to execute the Intel PROSet Wireless software.
4. Click the [Add] button. The General Settings dialog displays.
5. Enter a profile name in the Profile Name field.
6. Enter the network SSID, in the Network Name (SSID) field.
7. Click Infrastructure or Ad Hoc for the operating mode.
8. Click [Advanced].
9. The Mandatory Access Point option is only used if Infrastructure mode is selected. Use this option to connect to a specific access point. Enter the MAC

address for the access point. Click OK to save the setting and return to the General Settings page.

10. Click [Next].
11. If you are using Cisco CCX, click Cisco Options to enable Cisco CKIP data encryption on the Security Settings page. Check the Cisco Compatible Extensions Options. If you have checked the Cisco's "Mixed-Cell" box in the Advanced Setting, this option must also be checked.
12. Click [OK].
13. Click Next.
14. Select Open, Shared, WPA-Enterprise, WPA2-Enterprise, WPA-Personal, or WPA2-Personal in the Network Authentication options.
15. Select either None, WEP, CKIP (if Enable Cisco Client eXtensions is enabled, use CKIP or WEP), or TKIP for the data encryption.
16. If WEP is selected, select either 64 or 128-bit for the Encryption Level.
17. Select the key index 1, 2, 3 or 4.
18. Enter the WEP key if required. If your network does not employ a 802.1x/EAP security mechanism, please skip to step 24.
19. Click the Enable 802.1x checkbox to enable the 802.1x security option. Please contact your network administrator if configuration of this setting is required.
20. Select the appropriate Authentication Type. Please contact your network administrator if configuration of this setting is required.
21. After selecting your authentication type, enter the user name, domain, and password of the user you have created on the authentication server. The user name and password do not have to be the same as name and password of your current Windows user login.
22. Click [OK] to save the settings.
23. From the Intel ProSet Wireless page, click the new profile name shown in the Profile List. Use the up and down arrows to position the priority of the new profile in the priority list.
24. Click the Connect button to connect to the network.
25. Click [Close] if you want to close the Intel PROSet for Wireless window.

### Configuring Using Atheros Client Utility Software

This section explains the procedure to properly configure the WLAN device using the Atheros Client Utility. Pre-defined parameters will be required for this procedure. Please consult with your network administrator for these parameters:

**Network Name** - Also known as the SSID

**Network Key (WEP)** - Required if using static WEP keys.

**Authentication Type** - Open, Shared, WPA, or WPA-PSK

#### Procedure

1. Activate the WLAN device using either the Wireless On/Off Switch or the Atheros Client Utility
2. Right-click the "Atheros Client Utility" icon in the system tray, and select "Open Atheros Client Utility" from menu.
3. From the Current Status page, click the Profile Management tab.
4. If this is your first time using this utility, highlight the profile [Default] and Click the [Modify] button, otherwise Click the [New] button. The General Settings dialog displays.
5. From the General page, enter a profile name in the Profile Name field.
6. Enter the network SSID, in the SSID1 field. If you wish to create a profile that can connect to up to 3 different wireless networks, SSID's can be entered in the SSID2 and SSID3 fields as well.
7. Click the Security tab.
8. The Security tab allows for the configuration of the Security modes listed in the table below. Please select the radio button of the desired security mode. If these settings are not known to you, please consult with your network administrator for the correct settings.

Field Name	Description
WPA	Enables the use of Wi-Fi Protected Access. Choosing WPA opens the WPA EAP drop-down menu. Options include TLS and PEAP. If these settings are not known to you, please consult with your network administrator for the correct settings.
WPA-PSK	Enables WPA-Pre-Shared Key. Click on the Configure button to enter the WPA Passphrase. If these settings are not known to you, please consult with your network administrator for the correct settings.
802.1x	Enables 802.1x security. If these settings are not known to you, please consult with your network administrator for the correct settings. Choosing this option opens the 802.1x EAP type drop-down menu. Options include TLS, PEAP, and LEAP
Pre-Shared Key	Enables the use of pre-shared keys defined on both the access point and the station. This is where static WEP keys are entered. Click the Configure button to fill in the Define Pre-Shared Keys window.
None	No security

9. Click OK, then click the Advanced tab

10. The Advanced tab allows for the configuration of the options detailed in the table below.

Field Name	Description
Power Save Mode	Options are Maximum, Normal, or Off
Network Type	Options are AP (Infrastructure) or Ad Hoc
802.11b Preamble	Specifies the preamble setting in 802.11b. The default setting is Short and Long (Access Point mode), which allows both short and long headers in the 802.11b frames. Set to Long Only to override allowing short frames.
Transmit Power Level	Options are selectable, depending upon whether 802.11b/g or 802.11a is used.
Wireless Mode	Specifies 5 GHz 54 Mbps, 2.4 GHz 11 Mbps, or 2.4 GHz 54 Mbps operation in an access point network.
Wireless Mode when Starting Ad Hoc Network	Specifies 5GHz 54 Mbps, 2.4 GHz 11 Mbps, or 2.4 GHz 54 Mbps to start an Ad Hoc network if no matching network name is found after scanning all available modes.

11. Click OK

12. If the profile you just created does not activate immediately, click the Profile Management tab, highlight the desired Profile, and click Activate.

13. Click OK to close the Atheros Client Utility.

## CONNECTION TO THE NETWORK

This section explains connection to the network.

If there is an administrator of the network, contact the network administrator for data settings.

### Setting the network

Perform the "Setting TCP/IP" and "Confirming the computer and work group names" operations required for network connection.

### Setting TCP/IP



To change the setting of the IP address, you need to be logged in from Windows as an administrator.

1. Click the [Start] button first and then [Control Panel].
2. If the Control Panel is in Category view, switch to Classic view by clicking "Switch to Classic View" under Control Panel the left frame. (If you are already in Classic view, "Switch to Category View" will be displayed.)
3. Double-click [Network Connections]. A list of currently installed networks will be displayed.
4. Right-click [Wireless Network Connection] in the list, and then click [Properties] in the menu displayed. The [Wireless Network Connection Properties] window will be displayed.
5. Click the [General] tab if it is not already selected.
6. Click [Internet Protocol (TCP/IP)] and then click [Properties]. The [Internet Protocol (TCP/IP) Properties] window will be displayed.
7. Set the IP address as follows:
  - **For ad hoc connection:** Select [Use the following IP address:] and then enter data for [IP address] and [Subnet mask].
  - **For access point (infrastructure) connection:** If your network uses DHCP, select [Obtain an IP address automatically] and [Obtain DNS server address automatically]. If your network uses static IP addresses, consult with your network administrator for the correct IP address settings.
8. Click the [OK] button. Processing will return to the [Wireless Network Connection Properties] window.
9. Click the [OK] button.
10. Close the [Network Connection] window.

Following this operation, confirm the names of the computer and the workgroup as follows.

### Confirming the computer and work group names



To modify the computer name and/or the work group name, you need to be logged in from Windows as an administrator.

1. Click the [Start] button, then [Control Panel].
2. If the Control Panel is in Category view, switch to Classic view by clicking "Switch to Classic View" under Control Panel in the left frame. (If you are already in Classic view, "Switch to Category View" will be displayed.)
3. Double-click the [System] icon. The [System Properties] window will be displayed.
4. Click the [Computer Name] tab.
5. Confirm the settings of [Full computer name:] and [Workgroup:].
  - a. The setting of [Full computer name:] denotes the name for identifying the computer. Any name can be assigned for each personal computer.



To change the name, click [Change] and then proceed in accordance with the instruction messages displayed on the screen.

Enter the desired name in less than 15 ASCII character code format. Identifiability can be enhanced by entering the model number, the user name, and other factors.

b. [Workgroup name] is the group name of the network. Enter the desired name in less than 15 ASCII character code format.

**For ad hoc connection:** Assign the same network name to all personal computers existing on the network.

**For access point (infrastructure) connection:** Assign the name of the work group to be accessed.

6. Click the [OK] button. If a message is displayed that requests you to restart the personal computer, click [Yes] to restart the computer.



### Setting the sharing function

Set the sharing function to make file and/or printer sharing with other network-connected personal computers valid.

This operation is not required unless the sharing function is to be used.

The folder and printer for which the sharing function has been set will be usable from any personal computer present on the network.



To share a file and/or the connected printer, you need to be logged in as an administrator.

### Setting the Microsoft network-sharing service

1. Click the [Start] button first and then [Control Panel].
2. If the Control Panel is in Category view, switch to Classic view by clicking "Switch to Classic View" under Control Panel the left frame. (If you are already in Classic view, "Switch to Category View" will be displayed.)
3. Double-click [Network Connections]. A list of currently installed networks will be displayed.
4. Right-click [Wireless Network Connection] in the list, and then click [Properties] in the menu displayed. The [Wireless Network Connection Properties] window will be displayed.
5. If [File and Printer Sharing for Microsoft Networks] is displayed, proceed to step 6. If [File and Printer Sharing for Microsoft Networks] is not displayed, skip to step 7.
6. Make sure that the [File and Printer Sharing for Microsoft Networks] check box is checked, and then click the [OK] button. Skip to "Setting file-sharing function".
7. Click [Install]. The [Select Network Component Type] window will be displayed.
8. Click [Service], then click the [Add] button. The [Select Network Service] window will be displayed.
9. Click [File and Printer Sharing for Microsoft Networks] and then click the [OK] button. Processing will return to the [Wireless Network Connection Properties] window, and [File and Printer Sharing for Microsoft Networks] will be added to the list.
10. Click the [Close] button.

### Setting the file-sharing function

The procedure for setting the file-sharing function follows, with the "work" folder in drive C: as an example.

1. Click the [Start] button first and then [My Computer].
2. Double-click [Local disk (C:)].
3. Right-click the "work" folder (or whichever folder you want to share), and then click [Sharing and Security...] in the menu displayed. The [Folder Name Properties] window will be displayed

Setting the file-sharing function for the file which has been used to execute Network Setup Wizard is suggested on the screen. For the wireless LAN, however, since security is guaranteed by entry of the network name (SSID) and the network key, the steps to be taken to set the file-sharing function easily without using Network Setup Wizard are given below.



4. Click [Sharing] if it isn't already selected.
5. Click the link stating "If you understand the security risks, but want to share files without running the wizard, click here".
6. Click "Just enable file sharing" and click [OK].
7. Check the [Share this folder on the network] check box.



To specify the corresponding folder as a read-only folder, select the [Read only] checkbox under the General tab.

8. Click the [OK] button. The folder will be set as a sharable folder, and the display of the icon for the "work." folder will change.

### Setting the printer-sharing function

1. Click the [Start] button first and then [Printers and FAX] (In Vista: Printers control panel). A list of connected printers will be displayed.
2. Right-click the printer for which the sharing function is to be set, and then click [Sharing] in the

menu displayed. The property window corresponding to the selected printer will be displayed.



Setting the printer-sharing function when Network Setup Wizard has been executed is suggested on the screen. For the wireless LAN, however, since security is guaranteed by entry of the network name (SSID) and the network key, the steps to be taken to set the printer-sharing function without using Network Setup Wizard are laid down below.

3. Click the [Sharing] tab.
4. Click [Share this printer].
5. Enter the sharing printer name in [Share name].
6. Click the [OK] button.

#### Confirming connection

After you have finished the network setup operations, access the folder whose sharing has been set for other personal computers. Also, confirm the status of the radio waves in case of trouble such as a network connection failure.



In the case of access point (infrastructure) connection, enter the necessary data for the access point before confirming connection. Refer to the manual of the access point for the access point setup procedure.

#### Connecting your personal computer to another personal computer

1. Click [Start] first and then [My Computer]. The [My Computer] window will be displayed in the left frame.
2. Click [My Network Places] in the "Other Places" list. The window [My Network Places] will be displayed.
3. Click [View workgroup computers] under Network Tasks in the left frame.
4. Double-click the personal computer to which your personal computer is to be connected. The folder that was specified in "Setting the file-sharing function" on page 95 will be displayed.

5. Double-click the folder to be accessed.

#### Confirming the status of the radio

1. Right-click the Intel PRO Wireless icon in the lower right corner of the screen.
2. Click [Open Intel PROSet for Wireless]. The Intel PROSet for Wireless window opens.
3. Contained within the General tab and the Details section (accessed by pressing the [Details] button), you will find the current operating status of the radio. (When the radio is turned off or the computer is not yet connected, some of the conditions will not be displayed.)

- **Network Name (SSID)**  
Displays the Network Name (SSID) currently used by the radio.
- **Profile Name**  
The current configuration profile is displayed.
- **Mode**  
Displays the current operating mode. [Infrastructure (AP)] or [Ad Hoc] will be displayed.
- **Security**  
Displays the current security status of the profile being used:  
**None:** No encryption used.  
**WEP:** WEP encryption algorithm used.  
**CKIP:** WEP encryption algorithm used.  
**TKIP:** WEP encryption algorithm used.
- **Speed**  
Displays the highest data rate of the associated access point in mega-bits-per-second (Mbps) until data transfer occurs.  
**802.11g:** 1, 2, 5.5, 6, 9, 11, 12, 18, 24, 36, 48, or 54.  
**802.11b:** 1, 2, 5.5, or 11.
- **Band (Frequency)**  
Displays the current band and frequency being used. Displays Out of Range if no band and frequency is displayed. Displays:  
802.11g (2.4 GHz) or 802.11b (2.4 GHz)
- **Channel**  
Displays the current transmit and receive channel being used.
- **802.1x Protocol**  
Displays Enabled if the profile uses 802.1x authentication. Default is Disabled.

## Troubleshooting the WLAN

### TROUBLESHOOTING

Causes and countermeasures for troubles you may encounter while using your wireless LAN are described in the following table.

Problem	Possible Cause	Possible Solution
<b>Unavailable network connection</b>	<b>Incorrect network name (SSID) or network key</b>	<p><b>Ad hoc connection:</b> verify that the network names (SSID's) and network keys (WEP) of all computers to be connected have been configured correctly. SSID's and WEP key values must be identical on each machine.</p> <p><b>Access Point (Infrastructure) connection:</b> set the network name (SSID) and network key to the same values as those of the access point.</p> <p>Set the Network Authentication value identically to that of the Access Point (<i>See Configuring the WLAN Using Windows XP on page 91 for more information</i>). Please consult your network administrator for this value, if necessary.</p>
	<b>Weak received signal strength and/or link quality</b>	<p>Ad hoc connection: Retry connection after shortening the distance to the destination computer or removing any obstacles for better sight.</p> <p>Access Point (Infrastructure) connection: Retry connection after shortening the distance to the access point or removing any obstacles for better sight.</p> <p>To check the wave condition, refer to the following page: "Confirming the status of the radio waves" on page 96.</p>
	<b>The WLAN device has been deactivated or disabled</b>	Check if the wireless switch is turned ON. Also verify "Disable Radio" is not checked in "Network setting" window.
	<b>The computer to be connected is turned off</b>	Check if the computer to be connected is turned ON.
	<b>RF interference from Access Points or other wireless networks</b>	The use of identical or overlapping RF channels can cause interference with the operation of the WLAN device. Change the channel of your Access Point to a channel that does not overlap with the interfering device.
	<b>Wireless network authentication has failed</b>	Re-check your Network Authentication, Encryption, and Security settings. Incorrectly configured security settings such as an incorrectly typed WEP key, a mis-configured LEAP username, or an incorrectly chosen authentication method will cause the LAN device to associate but not authenticate to the wireless network.
	<b>Incorrectly configured network settings</b>	<p>Recheck the configuration of your network settings.</p> <p>For the method of checking, refer to the following page: "Connection to the Network" on page 94.</p>
	<b>Incorrect IP address configuration</b>	This only applies to networks using static IP addresses. Please contact your network administrator for the correct settings.

## WLAN Specifications

### SPECIFICATIONS

Item	Specification
Type of network	Conforms to IEEE 802.11a/802.11b/g (Wi-Fi based)*
Transfer rate	(Automatic switching) IEEE 802.11a/g: 54 Mbps maximum data rate IEEE 802.11b: 11 Mbps maximum data rate
Active frequency	802.11b/g: 2400~2473 MHz 802.11a: 4900 ~ 5850 MHz
Typical operating distances**	802.11a: 40 ft. (12 m) @ 54 Mbps; 300 ft. (91 m) @ 6 Mbps 802.11b: 100 ft. (30 m) @ 11 Mbps; 300 ft. (91 m) @ 1 Mbps 802.11g: 100 ft. (30 m) @ 54 Mbps; 300 ft. (91 m) @ 1 Mbps
Number of channels	802.11a: 8 independent channels 802.11b/g: 11 channels, 3 non-overlapping channels
Security	Encryption Types - WEP, TKIP, AES*** WPA 1.0 compliant  Encryption Keylengths Supported: 64 bits, 128 bits, and 152 bits (Using AES encryption only)  802.1x/EAP CCX 1.0 compliant
Maximum recommended number of computers to be connected over wireless LAN (during ad hoc connection)	10 units or less ****

\* "Wi-Fi based" indicates that the interconnectivity test of the organization which guarantees the interconnectivity of wireless LAN (Wi-Fi Alliance) has been passed.

\*\* The communication ranges shown above will increase or decrease depending on factors such as number of walls, reflective material, or interference from external RF sources.

\*\*\* Encryption with network key (WEP) is performed using the above number of bits, however, users can set 40 bits/104 bits after subtracting the fixed length of 24 bits.

\*\*\*\* Depending on practical environments, the allowable number of computers to be connected may be decreased.

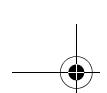

## Using the Bluetooth Device

The Integrated Bluetooth module (EYTF3CSFT) is an optional device available for Fujitsu mobile computers.

### WHAT IS BLUETOOTH

Bluetooth technology is designed as a short-range wireless link between mobile devices, such as laptop computers, phones, printers, and cameras. Bluetooth technology is used to create Personal Area Networks (PANs) between devices in short-range of each other.



You may need to install the Bluetooth application on your system using the Bluetooth disc that came with the notebook.

### WHERE TO FIND INFORMATION ABOUT BLUETOOTH

The Bluetooth module contains a robust Help user's guide to assist you in learning about operation of the Bluetooth device.

Windows XP: To access the Help file, click [Start] -> All Programs, and click on Toshiba. Select Bluetooth, then select User's Guide.

Windows Vista: To access the Help file, click [Start] -> All Programs, and click on Bluetooth, then select User's Guide.

For additional information about Bluetooth Technology, visit the Bluetooth Web site at: [www.bluetooth.com](http://www.bluetooth.com).

### FCC Radiation Exposure Statement

This equipment complies with FCC radiation exposure limits set forth for an uncontrolled environment. The Bluetooth antenna is located on the right of the palm rest and is exempt from minimum distance criteria due to its low power.

The transmitters in this device must not be co-located or operated in conjunction with any other antenna or transmitter.

### Canadian Notice

To prevent radio interference to the licensed service, this device is intended to be operated indoors and away from windows to provide maximum shielding. Equipment (or its transmit antenna) that is installed outdoors is subject to licensing.

### Warranty

Users are not authorized to modify this product. Any modifications invalidate the warranty.

This equipment may not be modified, altered, or changed in any way without signed written permission from Fujitsu. Unauthorized modification will void the equipment authorization from the FCC and Industry Canada and the warranty.



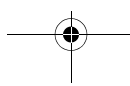
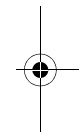
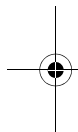

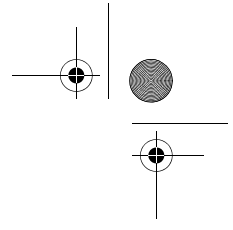
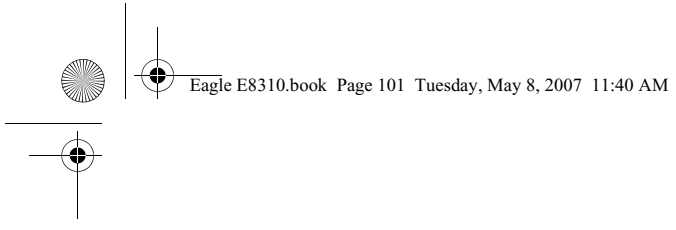

# Appendix B

## Using the Fingerprint Sensor\*

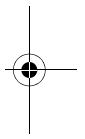
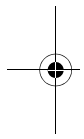

\*Optional device

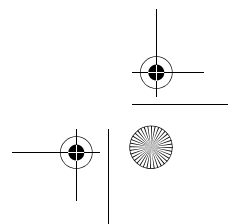
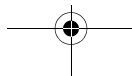
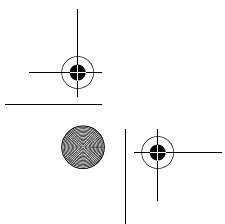

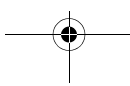
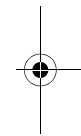
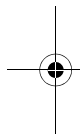
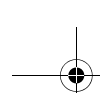



## Fingerprint Sensor Device

### INTRODUCING THE FINGERPRINT SENSOR DEVICE

Your system has an optional fingerprint sensor device below the Touchpad, between the left and right buttons. This also serves as a scroll button. (Figure 1)

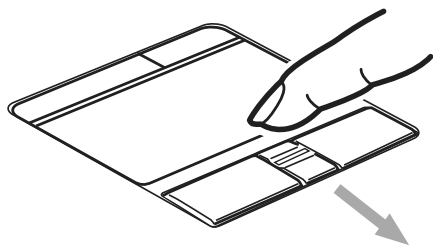

Figure A-1 Fingerprint sensor



Although the system may have a fingerprint sensor in place of a scroll button, the fingerprint sensor can be used for scrolling. Simply move your fingerprint over the sensor the same as you would use a scroll button.

With a fingerprint sensor, you can avoid having to enter a username and password every time you want to:

- Log onto Windows
- Recover from Standby mode
- Cancel a password-protected screen saver
- Log into homepages that require a username and password

After you have “enrolled” - or registered - your fingerprint, you can simply swipe your fingertip over the sensor for the system recognize you.

The fingerprint sensor uses Softex OmniPass which provides password management capabilities to Microsoft Windows operating systems. OmniPass enables you to use a “master password” for all Windows, applications, and on-line passwords.

The use of OmniPass results in a secure authentication system for restricting access to your computer, applications, websites, and other password-protected resources.

OmniPass presents a convenient graphical user interface, through which you can securely manage passwords, users, and multiple identities for each user.

### GETTING STARTED

This section guides you through the preparation of your system for the OmniPass fingerprint recognition application. You will be led through the OmniPass

installation process. You will also be led through the procedure of enrolling your first user into OmniPass.

### INSTALLING OMNIPASS

If OmniPass has already been installed on your system, skip this section and go directly to “User Enrollment” on page 104. You can determine whether OmniPass has already been installed by checking to see if the following are present:

- The presence of the gold key-shaped OmniPass icon in the system tray at the bottom right of the screen.
- The presence of the Softex program group in the Programs group of the Start menu

### System Requirements

The OmniPass application requires space on your hard drive; it also requires specific Operating Systems (OS's). The minimum requirements are as follows:

- Windows XP Professional operating system
- At least 35 MB available hard disk space

### Installing the OmniPass Application

If OmniPass is already installed on your system, go to “User Enrollment” on page 104. (If you have run the ClickMe! utility, it is likely that OmniPass has already been installed on your system.) Otherwise continue with this section on software installation.



For installation, OmniPass requires that the user installing OmniPass have administrative privileges to the system. If your current user does not have administrative privileges, log out and then log in with an administrator user before proceeding with OmniPass installation.

To install OmniPass on your system you must:

1. Insert the installation media for the OmniPass application into the appropriate drive. If you are installing from CD-ROM or DVD-ROM, you must find and launch the OmniPass installation program (setup.exe) from the media.
2. Follow the directions provided in the OmniPass installation program. Specify a location to which you would like OmniPass installed. It is recommended that you NOT install OmniPass in the root directory (e.g. C:\).
3. Once OmniPass has completed installation you will be prompted to restart your system. Once your system has rebooted you will be able to use OmniPass. If you choose not to restart immediately after installation, OmniPass will not be available for use until the next reboot.

The installation program automatically places an icon (Softex OmniPass) in the Windows Control Panel as well as a golden key shaped icon in the taskbar.

### Verifying Information about OmniPass

After you have completed installing OmniPass and restarted your system, you may wish to check the version of OmniPass on your system.

To check the version information of OmniPass:

1. From the Windows Desktop, double-click the key-shaped OmniPass icon in the taskbar (usually located in the lower right corner of the screen), or, Click the **Start** button, select **Settings**, and click **Control Panel** (if you are using Windows XP you will see the Control Panel directly in the Start menu; click it, then click **Switch to Classic View**). Double-click **Softex OmniPass** in the Control Panel, and the OmniPass Control Center will appear. If it does not appear, then the program is not properly installed, or, Click the **Start** button, select **Programs**, and from the submenu select the **Softex** program group, from that submenu click **OmniPass Control Center**.
2. Select the **About** tab at the top of the OmniPass Control Panel. The About tab window appears with version information about OmniPass.

### Uninstalling OmniPass



Before you uninstall the software, decrypt all OmniPass encrypted files and export all OmniPass User Profiles. Failure to do so may result in permanent loss of encrypted file data, and permanent loss of all remembered passwords and associated information (see Chapter 5 of the OmniPass help document:: Exporting and Importing Users).



For uninstallation, OmniPass requires that the user uninstalling OmniPass have administrative privileges to the system. If your current user does not have administrative privileges, log out and then log in with an administrator user before proceeding with OmniPass uninstallation.

To remove the OmniPass application from your system:

1. Click **Start** on the Windows taskbar. Select **Settings**, and then **Control Panel**.
2. Double-click **Add/Remove Programs**.
3. Select **OmniPass**, and then click **Change/Remove**.
4. Follow the directions to uninstall the OmniPass application.
5. Once OmniPass has finished uninstalling, reboot your system when prompted.

### USER ENROLLMENT

Before you can use any OmniPass features you must first enroll a user into OmniPass.

#### Master Password Concept

Computer resources are often protected with passwords. Whether you are logging into your computer, accessing your email, e-banking, paying bills online, or accessing network resources, you often have to supply credentials to gain access. This can result in dozens of sets of credentials that you have to remember.

During OmniPass user enrollment a "master password" is created for the enrolled user. This master password "replaces" all other passwords for sites you register with OmniPass.

**Example:** A user, John, installs OmniPass on his system (his home computer) and enrolls an OmniPass user with username "John\_01" and password "freq14". He then goes to his webmail site to log onto his account. He inputs his webmail credentials as usual (username "John\_02" and password "lifebook"), but instead of clicking [Submit], he directs OmniPass to **Remember Password**. Now whenever he returns to that site, OmniPass will prompt him to supply access credentials.

John enters his OmniPass user credentials ("John\_01" and "freq14") in the OmniPass authentication prompt, and he is allowed into his webmail account. He can do this with as many websites or password protected resources he likes, and he will gain access to all those sites with his OmniPass user credentials ("John\_01" and "freq14"). This is assuming he is accessing those sites with the system onto which he enrolled his OmniPass user. OmniPass does not actually change the credentials of the password protected resource. If John were to go to an Internet cafe to access his webmail, he would need to enter his original webmail credentials ("John\_02" and "lifebook") to gain access. If he attempts his OmniPass user credentials on a system other than where he enrolled that OmniPass user, he will not gain access.



The enrollment procedure assumes you have no hardware authentication devices or alternate storage locations that you wish to integrate with OmniPass. If you desire such functionality, consult the appropriate sections of this document.

#### Basic Enrollment

The Enrollment Wizard will guide you through the process of enrolling a user. Unless you specified otherwise, after OmniPass installation the Enrollment Wizard will launch on Windows login. If you do not see the Enrollment Wizard, you can bring it up by clicking **Start** on the Windows taskbar; select **Programs**; select **Softex**; click **OmniPass Enrollment Wizard**.

## Using the Fingerprint Sensor

1. Click **Enroll** to proceed to username and password verification. By default, the OmniPass Enrollment Wizard enters the credentials of the currently logged in Windows user.
2. Enter the password you use to log in to Windows. This will become the “master password” for this OmniPass user. In most cases, the **Domain:** value will be your Windows computer name. In a corporate environment, or when accessing corporate resources, the **Domain:** may not be your Windows computer name. Click [Next] to continue.
3. In this step OmniPass captures your fingerprint. Refer to “Enrolling a Fingerprint” on page 105 for additional information.
4. Next, choose how OmniPass notifies you of various events. We recommend you keep **Taskbar Tips** on **Beginner mode taskbar tips** and **Audio Tips** on at least **Prompt with system beeps only** until you get accustomed to how OmniPass operates. Click [Next] to proceed with user enrollment. You will then see a Congratulations screen indicating your completion of user enrollment.
5. Click [Done] to exit the OmniPass Enrollment Wizard. You will be asked if you’d like to log in to OmniPass with your newly enrolled user; click [Yes].

### Enrolling a Fingerprint

Enrolling a fingerprint will increase the security of your system and streamline the authentication procedure.

You enroll fingerprints in the OmniPass Control Center. With an OmniPass user logged in, double-click the system tray OmniPass icon. Select the **User Settings** tab and click **Enrollment** under the **User Settings** area. Click **Enroll Authentication Device** and authenticate at the authentication prompt to start device enrollment.

1. During initial user enrollment, you will be prompted to select the finger you wish to enroll. Fingers that have already been enrolled will be marked by a green check. The finger you select to enroll at this time will be marked by a red arrow. OmniPass will allow you re-enroll a finger. If you choose a finger that has already been enrolled and continue enrollment, OmniPass will enroll the fingerprint, overwriting the old fingerprint. Select a finger to enroll and click [Next].
2. It is now time for OmniPass to capture your selected fingerprint. It may take a several capture attempts before OmniPass acquires your fingerprint. Should OmniPass fail to acquire your fingerprint, or if the capture screen times out, click [Back] to restart the fingerprint enrollment process.

Your system has a “swipe” fingerprint sensor. A swipe sensor is small and resembles a skinny elongated rectangle. To capture a fingerprint, gently

swipe or pull your fingertip over the sensor (starting at the second knuckle) **towards yourself**. Swiping too fast or too slow will result in a failed capture. The **Choose Finger** screen has a [Practice] button; click it to practice capturing your fingerprint. When you are comfortable with how your fingerprint is captured, proceed to enroll a finger.

3. Once OmniPass has successfully acquired the fingerprint, the **Verify Fingerprint** screen will automatically appear. To verify your enrolled fingerprint, place your fingertip on the sensor and hold it there as if you were having a fingerprint captured. Successful fingerprint verification will show a green fingerprint in the capture window and the text **Verification Successful** under the capture window.

### USING OMNIPASS

You are now ready to begin using OmniPass. Used regularly, OmniPass will streamline your authentications.

#### Password Replacement

You will often use the password replacement function. When you go to a restricted access website (e.g., your bank, your web-based email, online auction or payment sites), you are always prompted to enter your login credentials. OmniPass can detect these prompts and you can teach OmniPass your login credentials. The next time you go to that website, you can authenticate with your fingerprint to gain access.

#### OmniPass Authentication Toolbar

After installing OmniPass and restarting, you will notice a dialog you have not seen before at Windows Logon. This is the OmniPass Authentication Toolbar, and it is displayed whenever the OmniPass authentication system is invoked. The OmniPass authentication system may be invoked frequently: during Windows Logon, during OmniPass Logon, when unlocking your workstation, when resuming from standby or hibernate, when unlocking a password-enabled screensaver, during password replacement for remembered site or application logins, and more. When you see this toolbar, OmniPass is prompting you to authenticate.

The **Logon Authentication** window indicates what OmniPass-restricted function you are attempting. The icons in the lower left (fingerprint and key) show what authentication methods are available to you. Selected authentication methods are highlighted while unselected methods are not. When you click the icon for an unselected authentication method, the authentication prompt associated with that method is displayed.

When prompted to authenticate, you must supply the appropriate credentials: an enrolled finger for the fingerprint capture window or your master password for the master password prompt (the key icon).

### Remembering a Password

OmniPass can remember any application, GUI, or password protected resource that has a password prompt.

Using the following procedure, you can store a set of credentials into OmniPass. These credentials will then be linked to your “master password” or fingerprint.

Go to a site that requires a login (username and password), but *do not log in yet*. At the site login prompt, enter your username and password in the prompted fields, but *do not enter the site* (do not hit [Enter], [Submit], [OK], or Login). Right-click the OmniPass system tray icon and select **Remember Password** from the submenu. The Windows arrow cursor will change to a golden key OmniPass cursor. Click this OmniPass cursor in the login prompt area, but do not click the [Login] or [Submit] button.

#### Associating a Friendly Name

After clicking the OmniPass key cursor near the login prompt, OmniPass will prompt you to enter a “friendly name” for this site. You should enter something that reminds you of the website, the company, or the service you are logging into. In its secure database, OmniPass associates this friendly name with this website.

#### Additional Settings for Remembering a Site

When OmniPass prompts you to enter a “friendly name” you also have the opportunity to set how OmniPass authenticates you to this site. There are three effective settings for how OmniPass handles a remembered site.

The default setting is **Automatically click the “OK” or “Submit” button for this password protected site once the user is authenticated**. With this setting, each time you navigate to this site OmniPass will prompt you for your master password or fingerprint authentication device. Once you have authenticated with OmniPass, you will automatically be logged into the site.

Less secure is the option to **Automatically enter this password protected site when it is activated. Do not prompt for authentication**. Check the upper box to get this setting, and each time you navigate to this site OmniPass will log you into the site without prompting you to authenticate.



This setting is more convenient in that whenever you go to a site remembered with this setting, you will bypass any authentication procedure and gain instant access to the site. But should you leave your system unattended with your OmniPass user logged in, anyone using your system can browse to your password protected sites and gain automatic access.

If you uncheck both boxes in **Settings for this Password Site**, OmniPass will prompt you for your master password or fingerprint authentication device. Once you have authenticated with OmniPass your credentials will be filled in to the site login prompt, but you will have to click the website [OK], [Submit], or [Login] button to gain access to the site.

Click **Finish** to complete the remember password procedure. The site location, the credentials to access the site, and the OmniPass authentication settings for the site are now stored in the OmniPass secure database. The OmniPass authentication settings (**Settings for this Password Site**) can always be changed in **Vault Management**.

#### Logging in to a Remembered Site

Whether or not OmniPass prompts you to authenticate when you return to a remembered site is determined by **Settings for this Password Site** and can be changed in **Vault Management**.

The following cases are applicable to using OmniPass to login to: Windows, remembered websites, and all other password protected resources.

#### With Master Password

Once you return to a site you have remembered with OmniPass, you may be presented with a master password prompt. Enter your master password and you will be allowed into the site.

#### Logging into Windows with a Fingerprint Device

When logging into Windows with a fingerprint device, the fingerprint capture window will now appear next to the Windows Login screen. Place your enrolled fingertip on the sensor to authenticate. You will be simultaneously logged into Windows and OmniPass. The capture window will also appear if you have used **Ctrl-Alt-Del** to lock a system, and the fingerprint device can be used to log back in as stated above.



If a machine is locked and OmniPass detects a different user logging back in with a fingerprint, the first user will be logged out and the second user logged in.

In Windows XP, your login options must be set either for classic login, or for fast user switching and logon screen to be enabled to use your fingerprint to log on to Windows. To change this go to **Control Panel**, select **User Accounts** and then click **Change the way users log on or off**. If your Windows screensaver is password protected, the fingerprint capture window will now appear next to screensaver password dialog during resume. You can authenticate to your screensaver password prompt with your enrolled finger.

## Using the Fingerprint Sensor

### Password Management

OmniPass provides an interface that lets you manage your passwords. To access this GUI, double-click the OmniPass key in the system tray. Click **Vault Management**; you will be prompted to authenticate. Once you gain access to **Vault Management**, click **Manage Passwords** under **Vault Settings**. You will see the **Manage Passwords** interface, with a list of friendly names.

You can view the credentials stored for any remembered website by highlighting the desired resource under **Password Protected Dialog** and clicking **Unmask Values**. Should a password be reset, or an account expire, you can remove stored credentials from OmniPass. Highlight the desired resource under **Password Protected Dialog** and click **Delete Page**. You will be prompted to confirm the password deletion.

The two check boxes in **Manage Passwords** govern whether OmniPass prompts you to authenticate or directly logs you into the remembered site.

OmniPass will overwrite an old set of credentials for a website if you attempt to use **Remember Password** on an already remembered site.

The exception to the above rule is the resetting of your Windows password. If your password is reset in Windows, then the next time you login to Windows, OmniPass will detect the password change and prompt you to "Update" or "Reconfirm" your password with OmniPass. Enter your new Windows password in the prompt(s) and click **OK** and your OmniPass "master password" will still be your Windows password.

### OmniPass User Identities

Identities allow OmniPass users to have multiple accounts to the same site (e.g., *bob@biblomail.com* and *boballen@biblomail.com*). If OmniPass did not provide you identities, you would be limited to remembering one account per site.

To create and manage identities, double-click the OmniPass key in the system tray. Click **Vault Management**; OmniPass will prompt you to authenticate. Once you gain access to **Vault Management**, click **Manage Identities** under **Vault Settings**. You can only manage the identities of the currently logged in OmniPass user.

To add a new identity, click **New Identity** or double-click **Click here to add a new identity**. Name the new identity and click **[OK]**, then click **[Apply]**. You can now switch to the new identity and start remembering passwords.

To delete an identity, highlight the identity you want to delete and click **[Delete Identity]**, then click **[Apply]**.



When you delete an identity, all of its associated remembered sites and password protected dialogs are lost.

To set the default identity, highlight the identity you want as default and click **[Set as Default]**; click **[Apply]** to ensure the settings are saved. If you log in to OmniPass with a fingerprint device, you will automatically be logged in to the default identity for that OmniPass user. You can choose the identity with which you are logging in if you login using "master password".

### Choosing User Identity during Login

To choose your identity during login, type your username in the **User Name:** field. Press **[Tab]** and see that the **Domain:** field self-populates. Click the **Password:** field to bring the cursor to it, and you will see the pull-down menu in the **Identity:** field. Select the identity you wish to login as and then click **OK** to login.

### Switch User Identity

To switch identities at any time, right-click the OmniPass system tray icon and click **Switch User Identity** from the submenu. The **Switch Identity** dialog will appear. Select the desired identity and then click **OK**.

### Identities and Password Management

On the **Manage Passwords** interface of the **Vault Management** tab of the OmniPass Control Center, there is a pull-down selection box labeled, **Identity**. This field lets you choose which identity you are managing passwords for. When you select an identity here, only those password protected dialogs that are associated with that identity are shown. You can perform all the functions explained in "Password Management" on page 107.

### CONFIGURING OMNIPASS

This section gives an overview of both the **Export/Import** function and the OmniPass Control Center.

### Exporting and Importing Users

Using the OmniPass Control Center, you can export and import users in and out of OmniPass. The export process backs up all remembered sites, credentials, and any enrolled fingerprints for an OmniPass user. All OmniPass data for a user is backed up to a single encrypted database file. During the import process, the Windows login of the exported user is required. If the proper credentials cannot be supplied, the user profile will not be imported.

- You should periodically export your user profile and store it in a safe place. If anything happens to your system, you can import your OmniPass profile to a new system and have all your remembered settings and fingerprints instantly.
- You don't forget the Windows login credentials when exporting. When you examine the importation, you are prompted for authentication. The credentials that will allow a user profile to be imported are the Windows login credentials of the exported user. They are the credentials that had to be submitted when the user profile was exported. You will need User Name, Password, and Domain.



#### Exporting an OmniPass User Profile

To export a user, open the OmniPass Control Center, and click **Import/Export User** under **Manage Users**.

Click **Exports an OmniPass user profile**. OmniPass will prompt you to authenticate. Upon successfully authentication, you must name the OmniPass user profile and decide where to save it. An .opi file is generated, and you should store a copy of it in a safe place.

This .opi file contains all your user specific OmniPass data, and it is both encrypted and password protected. This user profile does NOT contain any of your encrypted data files.

#### Importing an OmniPass User Profile



You cannot import a user into OmniPass if there already is a user with the same name enrolled in OmniPass.

To import an OmniPass user open the OmniPass Control Center, and click **Import/Export User** under **Manage Users**. Click **Imports a new user into OmniPass** and then select **OmniPass Import/Export File (\*.opi)** and click **Next**. OmniPass will then prompt you to browse for the file you had previously exported (.opi file). When you select the .opi file for importation, OmniPass will prompt you for authentication. The credentials that will allow a user profile to be imported are the Windows login credentials of the exported user. They are the credentials that had to be submitted when the user profile was exported. You will need **User Name**, **Password**, and **Domain**. If you don't remember the value for **Domain**, in a PC or SOHO environment **Domain** should be your computer name.

OmniPass will notify you if the user was successfully imported.

#### Things to Know Regarding Import/Export

- Assume you export a local Windows User profile from OmniPass. You want to import that profile to another machine that has OmniPass. Before you can import the profile, a Windows user with the same login credentials must be created on the machine importing the profile.

**Example:** I have a Windows user with the username "Tom" and the password "Sunshine" on my system. I have enrolled Tom into OmniPass and remembered passwords. I want to take all my passwords to new system. I export Tom's OmniPass user profile. I go to my new system and using the Control Panel I create a user with the username "Tom" and the password "Sunshine". I can now successfully import the OmniPass user data to the new system.

- If you export an OmniPass-only user, you can import that user to any computer running OmniPass, provided that a user with that name is not already enrolled in OmniPass.
- If you attempt to import a user profile who has the same name as a user already enrolled in OmniPass, the OmniPass import function will fail.

#### OMNIPASS CONTROL CENTER

This section will serve to explain functions within the OmniPass Control Center that weren't explained earlier.

You can access the OmniPass Control Center any of three ways:

- Double-click the golden OmniPass key shaped icon in the Windows system tray (typically in the lower-right corner of the desktop)
- Click the **Start** button; select the **Programs** group; select the **Softex** program group; and click the **OmniPass Control Center** selection.
- Open the Windows **Control Panel** (accessible via **Start** button --> **Settings** --> **Control Panel**) and double-click the **Softex OmniPass** icon.

#### User Management

The User Management tab has two major interfaces: **Add/Remove User** and **Import/Export User**. Import/Export User functionality is documented in "Exporting and Importing Users" on page 107. Add/Remove User functionality is straightforward.

If you click **Adds a new user to OmniPass** you will start the OmniPass Enrollment Wizard. The Enrollment Wizard is documented in "User Enrollment" on page 104.

If you click **Removes a user from OmniPass**, OmniPass will prompt you to authenticate. Authenticate with the credentials (or enrolled fingerprint) of the user you wish to remove. OmniPass will prompt you to confirm user removal. Click **OK** to complete user removal.



Removing a user will automatically destroy all OmniPass data associated with that user. All identities and credentials associated with the user will be lost.

If you are sure about removing the user, we recommend you export the user profile.

### User Settings

The User Settings tab has four interfaces: **Audio Settings**, **Taskbar Tips**, and **Enrollment**. User settings allow users to customize OmniPass to suit their individual preferences. Under **User Settings** (**Audio Settings** and **Taskbar Tips**) you can set how OmniPass notifies the user of OmniPass events (e.g., successful login, access denied, etc.). The details of each setting under the **Audio Settings** and **Taskbar Tips** interfaces are self-explanatory.

The **Enrollment** interface allows you to enroll fingerprints. To enroll additional fingerprints, click **Enroll Authentication Device**, and authenticate with OmniPass. Select the fingerprint recognition device in the **Select Authentication Device** screen (it should already be marked by a green check if you have a finger enrolled) and click **Next**.

### System Settings

The OmniPass **Startup Options** interface can be found in the System Settings tab. With these options you can specify how your OmniPass Logon is tied to your Windows Logon.

The first option, **Automatically log on to OmniPass as the current user**, will do just as it says; during Windows login, you will be logged on to OmniPass using your Windows login credentials. If the user logging into Windows was never enrolled into OmniPass, upon login no one will be logged on to OmniPass. This setting is appropriate for an office setting or any setting where users must enter a username and password to log into a computer. This is the default setting.

With the second option, **Manually log on to OmniPass at startup**, OmniPass will prompt you to login once you have logged on to Windows.

With the third option, **Do not log on to OmniPass at startup**, OmniPass will not prompt for a user to be logged on.

You can manually log on to OmniPass by right-clicking the OmniPass system tray icon and clicking **Log in User** from the right-click menu.

## TROUBLESHOOTING

You cannot use OmniPass to create Windows users. You must first create the Windows user, and you will need administrative privileges to do that. Once the Windows user is created, you can add that user to OmniPass using the same username and password.

### Cannot add Windows users to OmniPass

If you experience difficulties adding a Windows user to OmniPass, you may need to adjust your local security settings. You can do this by going to **Start**, **Control Panel**, **Administrative Tools**, and **Local Security Settings**. Expand **Local Policies**, expand **Security Options**, and double-click **Network Access: Sharing and Security Model for Local Accounts**. The correct setting should be *Classic - Local Users Authenticate as Themselves*.

### Cannot add a User with a Blank Password to OmniPass

If you experience difficulties adding a user with a blank password to OmniPass, you may need to adjust your local security settings. First attempt the procedure explained in the *Cannot add Windows user to OmniPass* section. If the difficulties persist, then try the following procedure.

Click **Start**, **Control Panel**, **Administrative Tools**, and **Local Security Settings**. Expand **Local Policies**, expand **Security Options**, and double-click **Accounts: Limit local account use of blank passwords to console login only**. This setting should be set to **Disabled**.

### Dialog appears after OmniPass authentication during Windows Logon

After installing OmniPass on your system, you can choose to logon to Windows using OmniPass. You authenticate with OmniPass (via master password, or an enrolled security device) and OmniPass logs you into Windows. You may, during this OmniPass authentication, see a **Login Error** dialog box.

This dialog box occurs when OmniPass was unable to log you into Windows with the credentials supplied (username and password). This could happen if your Windows password has changed or your Windows account has been disabled.

If you are having difficulties due to the first reason, you will need to update OmniPass with your changed Windows account password. Click **Update Password** and you will be prompted with a dialog to reconfirm your password.

Enter the new password to your Windows user account and click **OK**. If the error persists, then it is unlikely the problem is due to your Windows user account password changing.

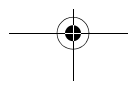
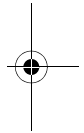
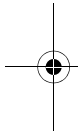
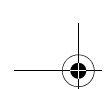



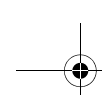

## Index

### A

- About This Guide ..... 1
- AC
  - adapter ..... 27
  - indicator ..... 12
  - plug adapters ..... 66
- Anti-theft lock slot ..... 10
- Application Panel ..... 20
- Auto/Airline Adapter ..... 27
- Automatically Downloading Driver Updates ..... 62

### B

- Battery ..... 37
  - alarm ..... 37
  - care ..... 66
  - charging indicator ..... 13
  - cold-swapping ..... 38
  - conserving power ..... 32
  - dead ..... 56
  - faulty ..... 56
  - increasing life ..... 66
  - level indicators ..... 12
  - lithium ion battery ..... 37
  - low ..... 37
  - problems ..... 56
  - recharging ..... 37
  - replacing ..... 38
  - shorted ..... 38
  - suspend mode ..... 37
- BIOS
  - guide ..... 30
  - setup utility ..... 29
- Bluetooth, where to find information ..... 99
- Built-in Speakers ..... 52

### C

- CapsLock ..... 13
- CD-ROM ..... 39
  - problems ..... 52, 53
- Click Me! ..... 31
- Clicking ..... 16
- Cold-swapping ..... 19, 38
- Configuration Label ..... 71
- Controls and Connectors ..... 6
- Cursor ..... 16
- Cursor Keys ..... 14

### D

- DC Power Jack ..... 27
- Device Ports ..... 46, 72
- DIMM ..... 44
- Disk care ..... 66
- Display Panel ..... 6, 28
  - adjusting ..... 28
  - brightness ..... 28
  - closing ..... 28
  - latch ..... 6
  - opening ..... 28
  - problems ..... 57, 58
- Display Timeout ..... 33
- Docking Port ..... 47
- Double-Clicking ..... 16
- Dragging ..... 17
- Drivers and Application Restore CD ..... 61
- DVD drive
  - access indicator ..... 13
  - problems ..... 52, 53
  - tray release ..... 40, 60

### E

- Emergency tray release ..... 10
- Error Messages ..... 59
- ExpressCards ..... 42
- External Floppy Disk Drive problems ..... 53
- External Video Port ..... 48

### F

- FDU ..... 31, 62, 73
- Fingerprint Sensor Device ..... 103
  - enrolling a fingerprint ..... 105
  - getting started ..... 103
  - installing OmniPass ..... 103
  - logging into a remembered site ..... 106
  - OmniPass authentication toolbar ..... 105
  - password replacement ..... 105
  - remembering a password ..... 106
  - uninstalling OmniPass ..... 104
  - user enrollment ..... 104
  - using OmniPass ..... 105
- Flexible Bay ..... 9, 19
  - cold-swapping ..... 19
  - devices ..... 19
  - eject lever ..... 9
  - installing ..... 19
  - Modular Multi-Format DVD Writer ..... 39
  - removing ..... 19

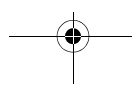



Fujitsu Contact Information ..... 1

Fujitsu Driver Update utility ..... 31, 62, 73

Fujitsu LifeBook

- storing ..... 65
- traveling ..... 66

Function Key

- F10 ..... 15
- F3 ..... 15
- F4 ..... 15
- F6 ..... 15
- F7 ..... 15
- F8 ..... 15, 18
- F9 ..... 15, 18
- FN ..... 15

**H**

Hard Disk Drive

- access indicator ..... 13
- problems ..... 53

Headphone Jack ..... 7, 47

Hibernation Feature ..... 32, 33

**I**

Infrared Port ..... 47

Internal LAN Jack ..... 46

IrDA ..... 7, 47

**K**

Keyboard ..... 6, 14

- cursor keys ..... 14
- function keys ..... 14
- numeric keypad ..... 14
- problems ..... 53
- windows keys ..... 14

**L**

LAN (RJ-45) Jack ..... 10

LifeBook Security Application Panel

- configuring ..... 22
- deactivating ..... 23
- deactivating and activating ..... 23
- launching applications ..... 22
- operating ..... 21
- passwords ..... 20
- uninstalling ..... 21

LifeBook Security/Application Panel ..... 6

**M**

Media Player

- care ..... 67
- Control Panel ..... 40
- loading ..... 39
- removing ..... 40
- Software ..... 39, 40

**Memory**

- capacity ..... 45
- compartment ..... 11, 44
- installing ..... 44
- problems ..... 54
- removing ..... 44, 45
- upgrade module ..... 44

**Memory Stick**

- installing ..... 41
- removing ..... 41

**Microphone Jack** ..... 7, 48

**Microsoft Works** ..... 74

**Modem** ..... 9, 54

**Modem Jack** ..... 46

**Modem Result Codes** ..... 60

**Modular Devices** ..... 19

- installing ..... 19
- removing ..... 19

**Mouse problems** ..... 53

**N**

**Numeric Keypad** ..... 14

**NumLk** ..... 13

**O**

**Optical Drive** ..... 39

**P**

Parallel Port ..... 46

- problems ..... 54

**PC Card**

- access indicator ..... 13
- care ..... 67
- problems ..... 54, 55
- slot ..... 8

**PC Cards** ..... 42, 43

**Pointing Device**

- See Touchpad ..... 16

**Port Replicator**

- connector ..... 11
- problems ..... 53

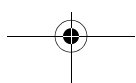

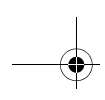
**Index**

<b>Power</b>	
AC adapter	27
Auto/Airline adapter	27
failure	55
indicator	12
management	32
off	33
on	29
problems	56
sources	27
Power Management	32, 33
Power On Self Test	29, 59
Power/Suspend/Resume Button	6, 32
Pre-Installed Software	73
Adobe Acrobat Reader	73
Google Toolbar	73
manuals	73
<b>R</b>	
Registration	31
Restarting	33
Restoring Your Pre-installed Software	61
RJ-11	46
RJ-45	46
<b>S</b>	
ScrLk	13
SD (Secure Digital) Card	
installing	41
removing	41
SDRAM	11, 44
Security Indicator	13
Security Panel	20
Serial Port	47
problems	54
Specifications	71
Audio	71
Chipset	71
Dimensions and Weight	72
Environmental Requirements	73
Keyboard	72
Memory	71
Microprocessor	71
Power	72
Video	71
Standby Mode	32
Status Indicator Panel	6, 12
Stereo Speakers	7
<b>T</b>	
Touchpad	16
buttons	16
controls	17
Touchpad Pointing Device	7
Troubleshooting	51
<b>U</b>	
Universal Serial Bus Ports	47
Unpacking	5
USB	9, 10, 47, 54
<b>V</b>	
Volume control	18
<b>W</b>	
Warranty	1
Windows keys	14
Application key	14
Start keys	14
Wireless LAN	
Before Using the Wireless LAN	88
IP address information	98
Specifications	98
Troubleshooting	97
Using Atheros Client Utility software	92
Using Intel PROSet software	91
Wireless LAN Glossary	98

