

THIS DRAWING AND SPECIFICATIONS, HEREIN, ARE THE PROPERTY OF INVENTEC CORPORATION AND SHALL NOT BE REPRODUCED, COPIED, OR USED IN WHOLE OR IN PART AS THE BASIS FOR THE MANUFACTURE OR SALE OF ITEMS WITHOUT WRITTEN PERMISSION, INVENTEC CORPORATION, 2004 ALL RIGHT RESERVED.

PART NO		REV	PART DESCRIPTION
		A01	Label Packaging drawing_FSC

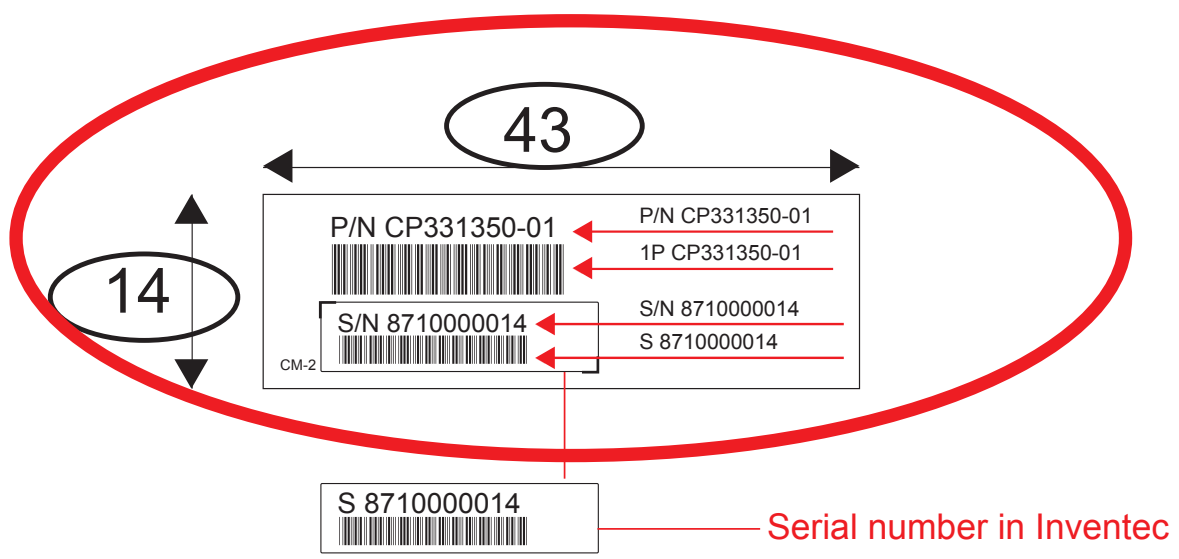

REVISION HISTORY	DATE	DOC	REV	CHG	BY	REASON
DESIGNER						

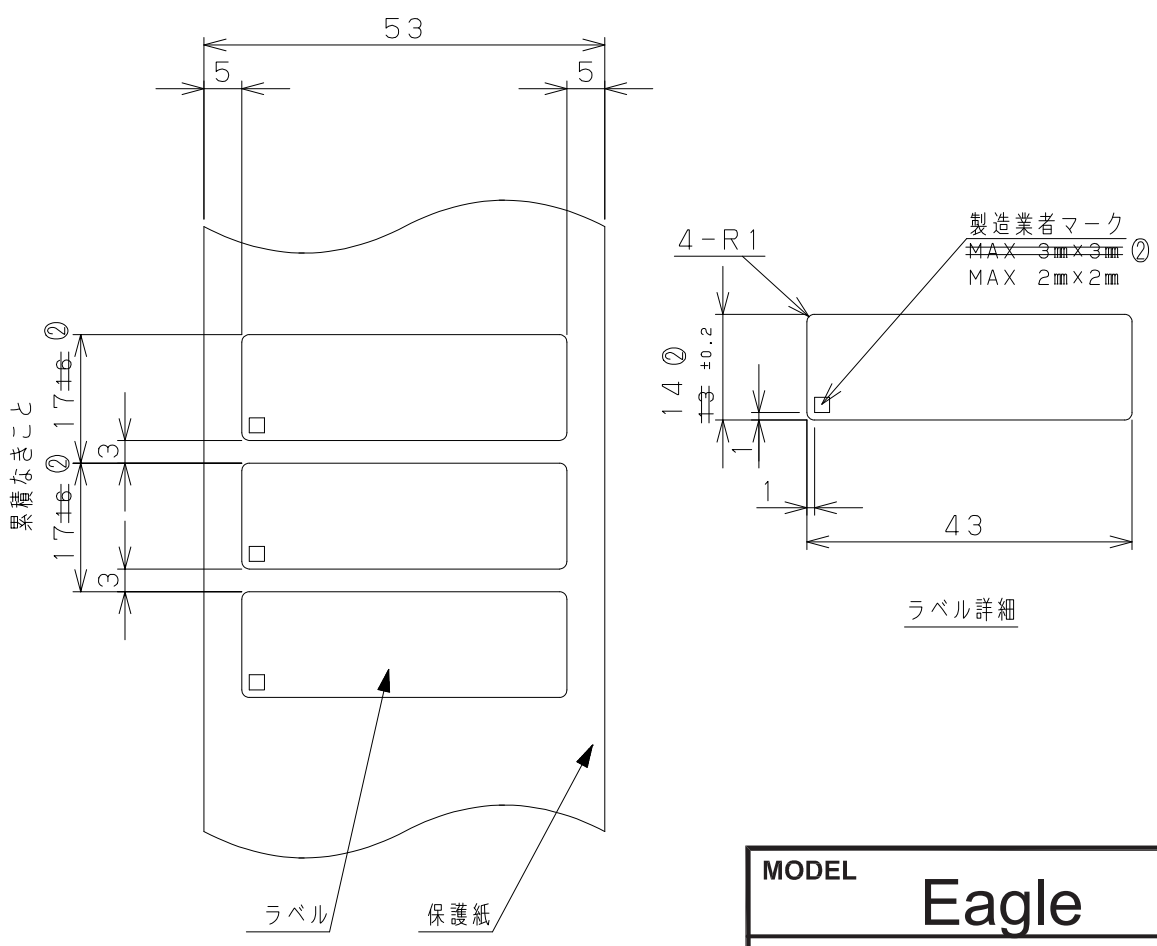
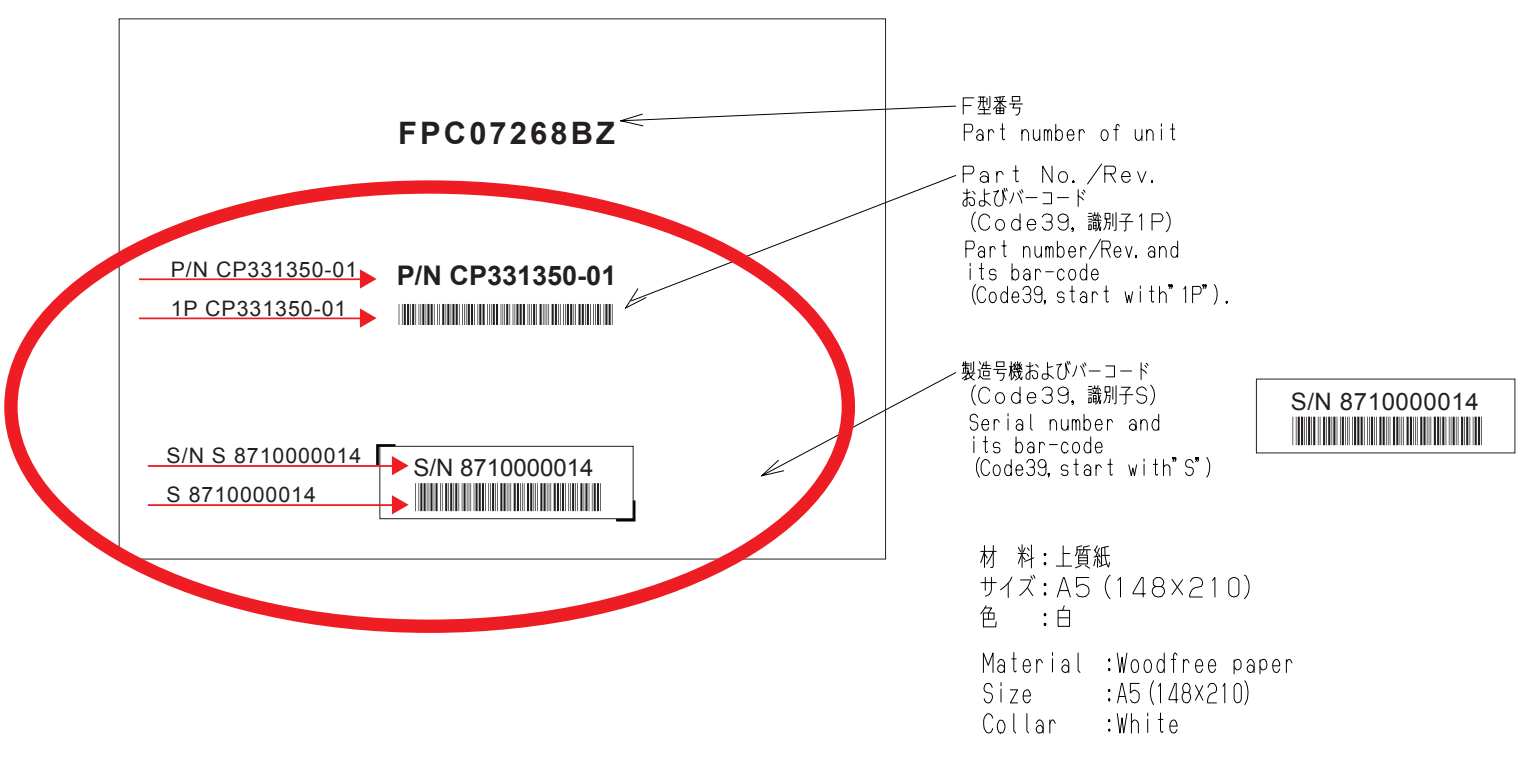
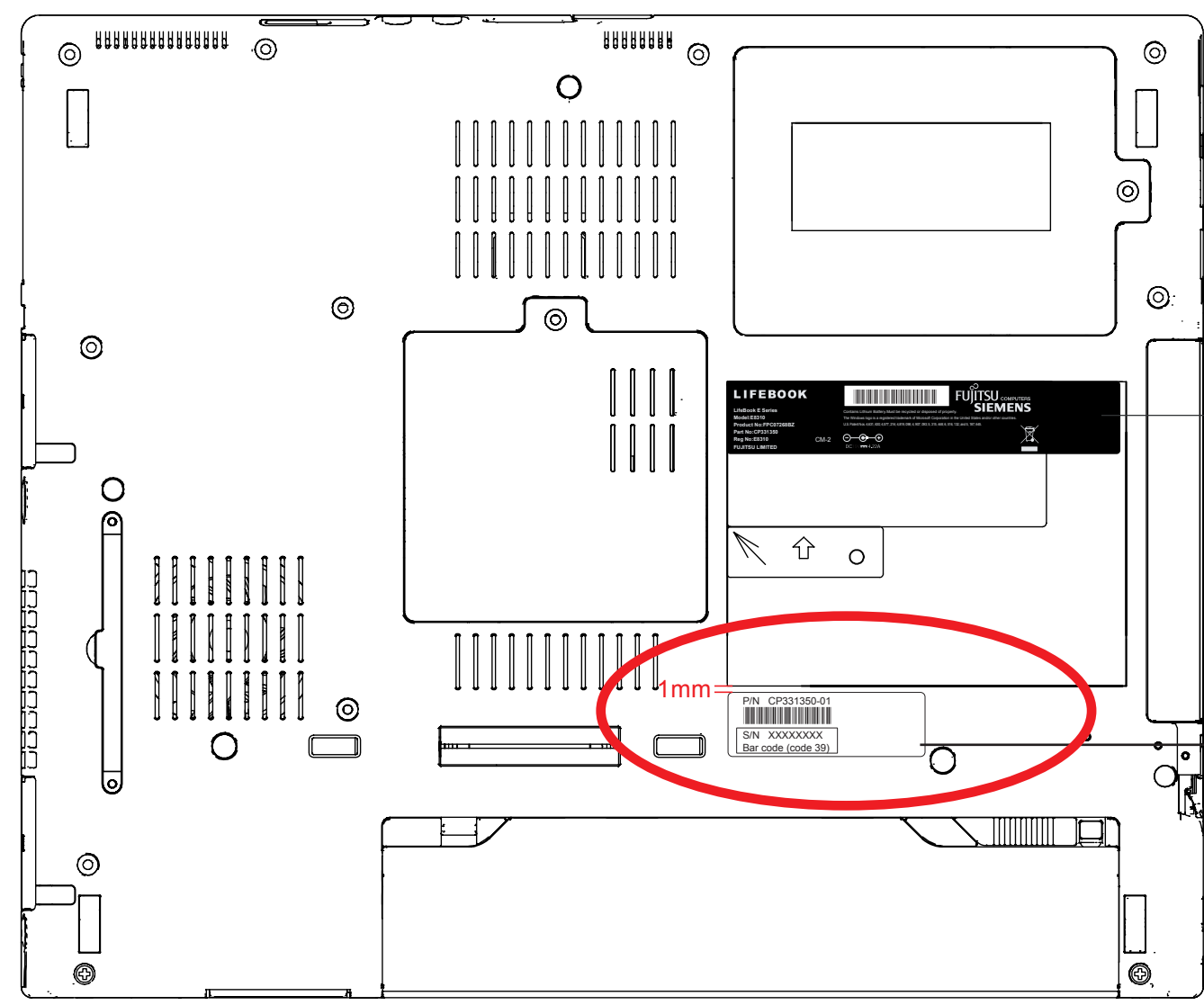
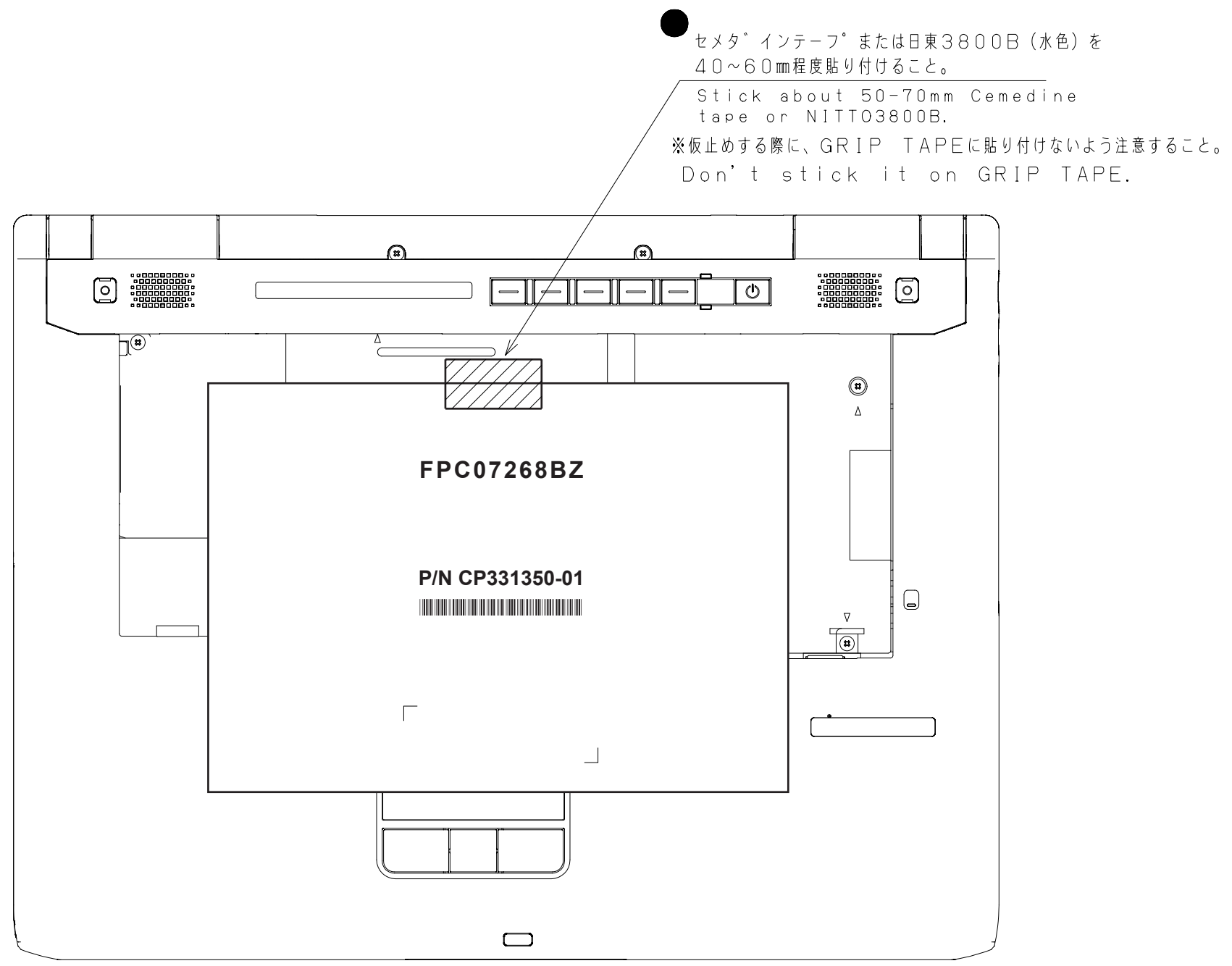
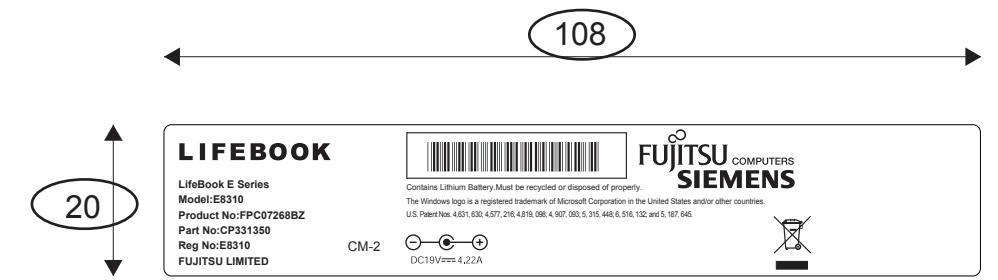
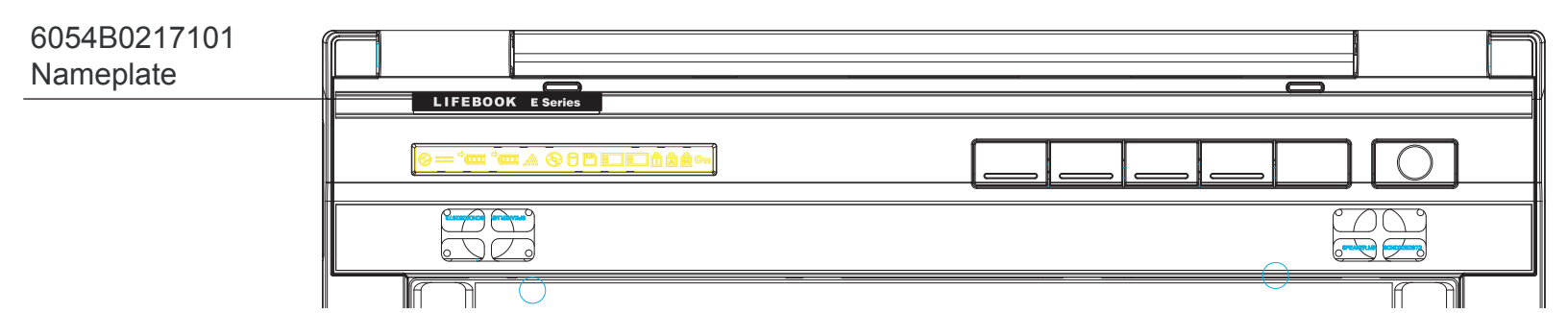

確認圖面

MODEL	Eagle	Inventec CORPORATION <small>CONFIDENTIAL</small>	
DESIGNER	Vicky, Tseng	D: 12 M: 09 Y: 06	TITLE Label Packaging drawing_Base E
MANAGER	Sam, Wang	D: 12 M: 09 Y: 06	DOCUMENT NUMBER XXXXXXXXXXXX
THIRD ANGLE DRAWING	DO NOT SCALE DRAWING	SIZE A PS	NUMBER XXXXXXXXXXXX
LINEAR	x x.X x.XX	SCALE: 1:1	UNIT: mm
mm		FILE NAME	Label Packaging drawing_Base E
INCH	±0.2	REV A	VER 0
		SHEET: 1 OF 1	