

**Attachment 4**

**INTEL FCC PART 15.407 TEST REPORT**

**REPORT NUMBER: INTEL-060908F**

Modular Approval  
Test Report  
And Application for Grant of Equipment Authorization

*TEST REPORT PERTAINING TO:*

Equipment Under Test	Model Number(s)
Intel PRO/Wireless 4965AGN Network Connection	4965AGN

CONFIGURATION
802.11a / 802.11b / 802.11g / 802.11n with a set of Ethertronics Antennas

*MEASUREMENTS PERFORMED IN ACCORDANCE WITH THE FOLLOWING STANDARD (S)*

Regulatory Standard(s)
47 CFR Part 15, Subpart E Section 15.407 (UNII Devices)
Test Method: ANSI C63.4: 2003 American National Standard for Methods of Measurement of Radio-Noise Emissions from Low-Voltage Electrical and Electronic Equipment in the Range of 9 kHz to 40 GHz



Certificate Number: 1111.01

**PREPARED FOR:**

Intel Corporation  
2111 NE 25<sup>th</sup> Avenue  
Hillsboro, Oregon 97124  
Contact(s): Mr. Robert Paxman

**PREPARED BY:**

Aegis Labs, Inc.  
22431 Antonio Parkway B160-417  
Rancho S. Margarita, CA 92688  
Agent(s): Mr. Rick Candelas  
Mr. Johnny Candelas



Test Report #: INTEL-060908F

Test Report Revision: A2

	REPORT BODY	APPENDICES		TOTAL PAGES
		A	B	
PAGES	17	150	1	168

The contents of this report shall not be reproduced except in full, without the written approval of Aegis Labs, Inc.  
The Intel logo is used for identification purposes only and is a registered trademark of Intel Corporation



## TABLE OF CONTENTS

SECTION	TITLE	PAGE
	<b>COVER SHEET.....</b>	<b>01</b>
	<b>TABLE OF CONTENTS.....</b>	<b>02</b>
<b>1.0</b>	<b>REGULATORY COMPLIANCE GUIDELINES.....</b>	<b>03</b>
1.1	Guidelines For Testing To Emissions Standards.....	03
<b>2.0</b>	<b>SUMMARY OF REGULATORY LIMITS.....</b>	<b>04</b>
<b>3.0</b>	<b>ADMINISTRATIVE DATA AND TEST DESCRIPTION.....</b>	<b>11</b>
<b>4.0</b>	<b>DESCRIPTION OF EUT CONFIGURATION.....</b>	<b>12</b>
4.1	EUT Description .....	12
4.2	EUT Configuration.....	13
4.3	List of EUT Sub-Assemblies and Host Equipment.....	13
4.4	I/O Cabling Diagram and Description .....	14
4.5	EMC Test Hardware and Software Measurement Equipment.....	15
<b>5.0</b>	<b>CONDITIONS DURING EMISSIONS MEASUREMENTS.....</b>	<b>16</b>
5.1	General.....	16
5.2	Conducted Emissions Test Setup.....	16
5.3	Radiated Emissions Test Setup.....	17

### APPENDICES

<b>A</b>	Test Data
<b>B</b>	Modifications And Recommendations





## 1.0 REGULATORY COMPLIANCE GUIDELINES

Aegis Labs, Inc. operates as both a Nevada and California Corporation with no organizational or financial relationship with any company, institution, or private individual. Testing and engineering functions provided by Aegis Labs were furnished by RF technicians and engineers with accredited qualifications and training credentials to carry out their duties.

The object of this report was to publish verifiable test results of an EUT subjected to the tests outlined in the standard listed on the cover page of this report.

### 1.1 Guidelines For Testing To Emissions Standards

This standard for EMC emission requirements apply to electrical equipment for Information Technology Equipment (ITE). Compliance to these standards and in combination with the other standards listed in this test report can be used to demonstrate presumption of compliance with the protection requirements of the appropriate agency standard.

The purpose of this standard is to specify minimum requirements for emissions regarding electromagnetic compatibility (EMC) and protect the radio frequency spectrum 9 kHz. – 400 GHz. from unwanted interference generated from electrical/digital systems that intentionally or unintentionally generated RF energy. The emissions standards, normative documents and/or publications were used to conduct all tests performed on the equipment herein referred to as “Equipment Under Test”.



## 2.0 SUMMARY OF TEST RESULTS

### *802.11a Mode (5150-5350 MHz) Chain A*

<b>EMISSIONS STANDARD</b>			
<b>FCC Part 15 Section</b>	<b>Description</b>	<b>Results</b>	<b>Comments</b>
<b>Operation in the 5.15-5.25 GHz Band</b>			
15.407(d)	Any UNII device shall use a transmitting antenna that is an integral part of the device.	PASSED	The antenna will be integral when installed in a notebook computer
15.407(e)	UNII devices will be restricted to indoor operations.	PASSED	Refer to "User's Manual" Exhibit
15.407(a)(1)	26dB emissions bandwidth in MHz.	N/A	5.18 GHz = 22.00 MHz
15.407(a)(1)	Peak transmit power shall not exceed the lesser of 50mW or 4dBm+10logB (where B = 26dB emissions bandwidth).	PASSED	5.18 GHz = 16.61dBm (45.81mW) 5.24 GHz = 16.81dBm (47.97mW)
15.407(a)(1)	The peak power spectral density shall not exceed 4dBm in any 1MHz band.	PASSED	5.18 GHz = -15.06dBm
15.407(a)(1)	Peak transmit power and the peak power spectral density shall be reduced by the amount in dB that the transmitting antenna exceeds 6dBi.	N/A	All antennas tested have less than 6dBi antenna gain (Please see the antenna data sheets)
15.407(b)(6) 15.209	Unwanted emissions below 1 GHz must comply with the general field strength limits set forth in Section 15.209.	PASSED	See Data Sheets
15.407(b)(1)	All emissions outside of the 5.15-5.35 GHz band shall not exceed an EIRP of -27dBm/MHz.	PASSED	See Data Sheets
<b>Operation in the 5.25-5.35 GHz Band</b>			
15.407(a)(2)	26dB emissions bandwidth in MHz.	N/A	5.26 GHz = 22.42 MHz 5.32 GHz = 21.50 MHz
15.407(a)(2)	Peak transmit power shall not exceed the lesser of 250mW or 11dBm+10logB (where B = 26dB emissions bandwidth).	PASSED	5.26 GHz = 18.61dBm (69.34mW) 5.32 GHz = 18.41dBm (72.60mW)
15.407(a)(2)	The peak power spectral density shall not exceed 11dBm in any 1MHz band.	PASSED	5.26 GHz = 9.50dBm 5.32 GHz = 9.83dBm
15.407(a)(2)	Peak transmit power and the peak power spectral density shall be reduced by the amount in dB that the transmitting antenna exceeds 6dBi.	N/A	All antennas tested have less than 6dBi antenna gain (Please see the antenna data sheets)
15.407(b)(6) 15.209	Unwanted emissions below 1 GHz must comply with the general field strength limits set forth in Section 15.209.	PASSED	See Data Sheets
15.407(b)(2)	All emissions outside of the 5.15-5.35 GHz band shall not exceed an EIRP of -27dBm/MHz. Must meet all applicable technical requirements for operating in the 5.15-5.25 GHz band.	PASSED	See Data Sheets
<b>General Requirements For All Bands</b>			
15.407(a)(6)	The ratio of the peak excursion of the modulation envelope to the peak transmit power shall not exceed 13dB across any 1 MHz bandwidth or the emissions bandwidth whichever is less.	PASSED	5.18 GHz = 5.83 dB 5.26 GHz = 5.67 dB 5.32 GHz = 5.50 dB
15.407(f)	Radio frequency radiation exposure requirement.	PASSED	Refer to MPE Calculations Exhibit
15.407(b)(6) 15.207	UNII devices using AC power line are required to comply with the conducted limits set forth in Section 15.207.	PASSED	See Data Sheets



## 2.0 Summary Of Test Results (Continued)

**802.11a Mode (5150-5350 MHz) Chain B**

<b>EMISSIONS STANDARD</b>			
<b>FCC Part 15 Section</b>	<b>Description</b>	<b>Results</b>	<b>Comments</b>
<b>Operation in the 5.15-5.25 GHz Band</b>			
15.407(d)	Any UNII device shall use a transmitting antenna that is an integral part of the device.	PASSED	The antenna will be integral when installed in a notebook computer
15.407(e)	UNII devices will be restricted to indoor operations.	PASSED	Refer to "User's Manual" Exhibit
15.407(a)(1)	26dB emissions bandwidth in MHz.	N/A	5.18 GHz = 23.50 MHz
15.407(a)(1)	Peak transmit power shall not exceed the lesser of 50mW or 4dBm+10logB (where B = 26dB emissions bandwidth).	PASSED	5.18 GHz = 16.81dBm (47.97mW) 5.24 GHz = 16.91dBm (49.09mW)
15.407(a)(1)	The peak power spectral density shall not exceed 4dBm in any 1MHz band.	PASSED	5.18 GHz = -13.62dBm
15.407(a)(1)	Peak transmit power and the peak power spectral density shall be reduced by the amount in dB that the transmitting antenna exceeds 6dBi.	N/A	All antennas tested have less than 6dBi antenna gain (Please see the antenna data sheets)
15.407(b)(6) 15.209	Unwanted emissions below 1 GHz must comply with the general field strength limits set forth in Section 15.209.	PASSED	See Data Sheets
15.407(b)(1)	All emissions outside of the 5.15-5.35 GHz band shall not exceed an EIRP of -27dBm/MHz.	PASSED	See Data Sheets
<b>Operation in the 5.25-5.35 GHz Band</b>			
15.407(a)(2)	26dB emissions bandwidth in MHz.	N/A	5.26 GHz = 23.75 MHz 5.32 GHz = 22.33 MHz
15.407(a)(2)	Peak transmit power shall not exceed the lesser of 250mW or 11dBm+10logB (where B = 26dB emissions bandwidth).	PASSED	5.26 GHz = 19.41dBm (87.29mW) 5.32 GHz = 19.11dBm (81.46mW)
15.407(a)(2)	The peak power spectral density shall not exceed 11dBm in any 1MHz band.	PASSED	5.26 GHz = 9.83dBm 5.32 GHz = 9.33dBm
15.407(a)(2)	Peak transmit power and the peak power spectral density shall be reduced by the amount in dB that the transmitting antenna exceeds 6dBi.	N/A	All antennas tested have less than 6dBi antenna gain (Please see the antenna data sheets)
15.407(b)(6) 15.209	Unwanted emissions below 1 GHz must comply with the general field strength limits set forth in Section 15.209.	PASSED	See Data Sheets
15.407(b)(2)	All emissions outside of the 5.15-5.35 GHz band shall not exceed an EIRP of -27dBm/MHz. Must meet all applicable technical requirements for operating in the 5.15-5.25 GHz band.	PASSED	See Data Sheets
<b>General Requirements For All Bands</b>			
15.407(a)(6)	The ratio of the peak excursion of the modulation envelope to the peak transmit power shall not exceed 13dB across any 1 MHz bandwidth or the emissions bandwidth whichever is less.	PASSED	5.18 GHz = 6.17 dB 5.26 GHz = 6.17 dB 5.32 GHz = 5.83 dB
15.407(f)	Radio frequency radiation exposure requirement.	PASSED	Refer to MPE Calculations Exhibit
15.407(b)(6) 15.207	UNII devices using AC power line are required to comply with the conducted limits set forth in Section 15.207.	PASSED	See Data Sheets



## 2.0 Summary Of Test Results (Continued)

**802.11n Mode 20MHz Wide (5150-5350 MHz) Chain A**

<b>EMISSIONS STANDARD</b>			
<b>FCC Part 15 Section</b>	<b>Description</b>	<b>Results</b>	<b>Comments</b>
<b>Operation in the 5.15-5.25 GHz Band</b>			
15.407(d)	Any UNII device shall use a transmitting antenna that is an integral part of the device.	PASSED	The antenna will be integral when installed in a notebook computer
15.407(e)	UNII devices will be restricted to indoor operations.	PASSED	Refer to "User's Manual" Exhibit
15.407(a)(1)	26dB emissions bandwidth in MHz.	N/A	5.18 GHz = 23.67 MHz
15.407(a)(1)	Peak transmit power shall not exceed the lesser of 50mW or 4dBm+10logB (where B = 26dB emissions bandwidth).	PASSED	5.18 GHz = 16.91dBm (49.09mW)
15.407(a)(1)	The peak power spectral density shall not exceed 4dBm in any 1MHz band.	PASSED	5.18 GHz = -13.99dBm
15.407(a)(1)	Peak transmit power and the peak power spectral density shall be reduced by the amount in dB that the transmitting antenna exceeds 6dBi.	N/A	All antennas tested have less than 6dBi antenna gain (Please see the antenna data sheets)
15.407(b)(6) 15.209	Unwanted emissions below 1 GHz must comply with the general field strength limits set forth in Section 15.209.	PASSED	See Data Sheets
15.407(b)(1)	All emissions outside of the 5.15-5.35 GHz band shall not exceed an EIRP of -27dBm/MHz.	PASSED	See Data Sheets
<b>Operation in the 5.25-5.35 GHz Band</b>			
15.407(a)(2)	26dB emissions bandwidth in MHz.	N/A	5.26 GHz = 22.75 MHz 5.32 GHz = 22.33 MHz
15.407(a)(2)	Peak transmit power shall not exceed the lesser of 250mW or 11dBm+10logB (where B = 26dB emissions bandwidth).	PASSED	5.26 GHz = 18.81dBm (76.03mW) 5.32 GHz = 18.41dBm (69.34mW)
15.407(a)(2)	The peak power spectral density shall not exceed 11dBm in any 1MHz band.	PASSED	5.26 GHz = 9.83dBm 5.32 GHz = 9.67dBm
15.407(a)(2)	Peak transmit power and the peak power spectral density shall be reduced by the amount in dB that the transmitting antenna exceeds 6dBi.	N/A	All antennas tested have less than 6dBi antenna gain (Please see the antenna data sheets)
15.407(b)(6) 15.209	Unwanted emissions below 1 GHz must comply with the general field strength limits set forth in Section 15.209.	PASSED	See Data Sheets
15.407(b)(2)	All emissions outside of the 5.15-5.35 GHz band shall not exceed an EIRP of -27dBm/MHz. Must meet all applicable technical requirements for operating in the 5.15-5.25 GHz band.	PASSED	See Data Sheets
<b>General Requirements For All Bands</b>			
15.407(a)(6)	The ratio of the peak excursion of the modulation envelope to the peak transmit power shall not exceed 13dB across any 1 MHz bandwidth or the emissions bandwidth whichever is less.	PASSED	5.18 GHz = 6.17 dB 5.26 GHz = 4.84 dB 5.32 GHz = 5.00 dB
15.407(f)	Radio frequency radiation exposure requirement.	PASSED	Refer to MPE Calculations Exhibit
15.407(b)(6) 15.207	UNII devices using AC power line are required to comply with the conducted limits set forth in Section 15.207.	PASSED	See Data Sheets



## 2.0 Summary Of Test Results (Continued)

**802.11n Mode 20MHz Wide (5150-5350 MHz) Chain B**

<b>EMISSIONS STANDARD</b>			
<b>FCC Part 15 Section</b>	<b>Description</b>	<b>Results</b>	<b>Comments</b>
<b>Operation in the 5.15-5.25 GHz Band</b>			
15.407(d)	Any UNII device shall use a transmitting antenna that is an integral part of the device.	PASSED	The antenna will be integral when installed in a notebook computer
15.407(e)	UNII devices will be restricted to indoor operations.	PASSED	Refer to "User's Manual" Exhibit
15.407(a)(1)	26dB emissions bandwidth in MHz.	N/A	5.18 GHz = 23.25 MHz
15.407(a)(1)	Peak transmit power shall not exceed the lesser of 50mW or 4dBm+10logB (where B = 26dB emissions bandwidth).	PASSED	5.18 GHz = 16.71dBm (46.88mW)
15.407(a)(1)	The peak power spectral density shall not exceed 4dBm in any 1MHz band.	PASSED	5.18 GHz = -12.67dBm
15.407(a)(1)	Peak transmit power and the peak power spectral density shall be reduced by the amount in dB that the transmitting antenna exceeds 6dBi.	N/A	All antennas tested have less than 6dBi antenna gain (Please see the antenna data sheets)
15.407(b)(6) 15.209	Unwanted emissions below 1 GHz must comply with the general field strength limits set forth in Section 15.209.	PASSED	See Data Sheets
15.407(b)(1)	All emissions outside of the 5.15-5.35 GHz band shall not exceed an EIRP of -27dBm/MHz.	PASSED	See Data Sheets
<b>Operation in the 5.25-5.35 GHz Band</b>			
15.407(a)(2)	26dB emissions bandwidth in MHz.	N/A	5.26 GHz = 23.00 MHz 5.32 GHz = 22.75 MHz
15.407(a)(2)	Peak transmit power shall not exceed the lesser of 250mW or 11dBm+10logB (where B = 26dB emissions bandwidth).	PASSED	5.26 GHz = 19.21dBm (83.36mW) 5.32 GHz = 18.71dBm (74.29mW)
15.407(a)(2)	The peak power spectral density shall not exceed 11dBm in any 1MHz band.	PASSED	5.26 GHz = 10.00dBm 5.32 GHz = 10.00dBm
15.407(a)(2)	Peak transmit power and the peak power spectral density shall be reduced by the amount in dB that the transmitting antenna exceeds 6dBi.	N/A	All antennas tested have less than 6dBi antenna gain (Please see the antenna data sheets)
15.407(b)(6) 15.209	Unwanted emissions below 1 GHz must comply with the general field strength limits set forth in Section 15.209.	PASSED	See Data Sheets
15.407(b)(2)	All emissions outside of the 5.15-5.35 GHz band shall not exceed an EIRP of -27dBm/MHz. Must meet all applicable technical requirements for operating in the 5.15-5.25 GHz band.	PASSED	See Data Sheets
<b>General Requirements For All Bands</b>			
15.407(a)(6)	The ratio of the peak excursion of the modulation envelope to the peak transmit power shall not exceed 13dB across any 1 MHz bandwidth or the emissions bandwidth whichever is less.	PASSED	5.18 GHz = 5.00 dB 5.26 GHz = 5.67 dB 5.32 GHz = 5.67 dB
15.407(f)	Radio frequency radiation exposure requirement.	PASSED	Refer to MPE Calculations Exhibit
15.407(b)(6) 15.207	UNII devices using AC power line are required to comply with the conducted limits set forth in Section 15.207.	PASSED	See Data Sheets



2.0 Summary Of Test Results (Continued)

**802.11n Mode 40MHz Wide (5150-5350 MHz) Chain A**

<b>EMISSIONS STANDARD</b>			
<b>FCC Part 15 Section</b>	<b>Description</b>	<b>Results</b>	<b>Comments</b>
<b>Operation in the 5.15-5.25 GHz Band</b>			
15.407(d)	Any UNII device shall use a transmitting antenna that is an integral part of the device.	PASSED	The antenna will be integral when installed in a notebook computer
15.407(e)	UNII devices will be restricted to indoor operations.	PASSED	Refer to "User's Manual" Exhibit
15.407(a)(1)	26dB emissions bandwidth in MHz.	N/A	5.19 GHz = 40.50 MHz
15.407(a)(1)	Peak transmit power shall not exceed the lesser of 50mW or 4dBm+10logB (where B = 26dB emissions bandwidth).	PASSED	5.19 GHz = 15.41dBm (34.75mW)
15.407(a)(1)	The peak power spectral density shall not exceed 4dBm in any 1MHz band.	PASSED	5.19 GHz = -22.79dBm
15.407(a)(1)	Peak transmit power and the peak power spectral density shall be reduced by the amount in dB that the transmitting antenna exceeds 6dBi.	N/A	All antennas tested have less than 6dBi antenna gain (Please see the antenna data sheets)
15.407(b)(6) 15.209	Unwanted emissions below 1 GHz must comply with the general field strength limits set forth in Section 15.209.	PASSED	See Data Sheets
15.407(b)(1)	All emissions outside of the 5.15-5.35 GHz band shall not exceed an EIRP of -27dBm/MHz.	PASSED	See Data Sheets
<b>Operation in the 5.25-5.35 GHz Band</b>			
15.407(a)(2)	26dB emissions bandwidth in MHz.	N/A	5.27 GHz = 47.50 MHz 5.31 GHz = 39.70 MHz
15.407(a)(2)	Peak transmit power shall not exceed the lesser of 250mW or 11dBm+10logB (where B = 26dB emissions bandwidth).	PASSED	5.27 GHz = 16.51dBm (44.76mW) 5.31 GHz = 15.41dBm (34.75mW)
15.407(a)(2)	The peak power spectral density shall not exceed 11dBm in any 1MHz band.	PASSED	5.27 GHz = 8.67dBm 5.31 GHz = 6.67dBm
15.407(a)(2)	Peak transmit power and the peak power spectral density shall be reduced by the amount in dB that the transmitting antenna exceeds 6dBi.	N/A	All antennas tested have less than 6dBi antenna gain (Please see the antenna data sheets)
15.407(b)(6) 15.209	Unwanted emissions below 1 GHz must comply with the general field strength limits set forth in Section 15.209.	PASSED	See Data Sheets
15.407(b)(2)	All emissions outside of the 5.15-5.35 GHz band shall not exceed an EIRP of -27dBm/MHz. Must meet all applicable technical requirements for operating in the 5.15-5.25 GHz band.	PASSED	See Data Sheets
<b>General Requirements For All Bands</b>			
15.407(a)(6)	The ratio of the peak excursion of the modulation envelope to the peak transmit power shall not exceed 13dB across any 1 MHz bandwidth or the emissions bandwidth whichever is less.	PASSED	5.19 GHz = 4.83 dB 5.27 GHz = 4.33 dB 5.31 GHz = 5.34 dB
15.407(f)	Radio frequency radiation exposure requirement.	PASSED	Refer to MPE Calculations Exhibit
15.407(b)(6) 15.207	UNII devices using AC power line are required to comply with the conducted limits set forth in Section 15.207.	PASSED	See Data Sheets



## 2.0 Summary Of Test Results (Continued)

**802.11n Mode 40MHz Wide (5150-5350 MHz) Chain B**

<b>EMISSIONS STANDARD</b>			
<b>FCC Part 15 Section</b>	<b>Description</b>	<b>Results</b>	<b>Comments</b>
<b>Operation in the 5.15-5.25 GHz Band</b>			
15.407(d)	Any UNII device shall use a transmitting antenna that is an integral part of the device.	PASSED	The antenna will be integral when installed in a notebook computer
15.407(e)	UNII devices will be restricted to indoor operations.	PASSED	Refer to "User's Manual" Exhibit
15.407(a)(1)	26dB emissions bandwidth in MHz.	N/A	5.19 GHz = 40.30 MHz
15.407(a)(1)	Peak transmit power shall not exceed the lesser of 50mW or 4dBm+10logB (where B = 26dB emissions bandwidth).	PASSED	5.19 GHz = 15.41dBm (34.75mW)
15.407(a)(1)	The peak power spectral density shall not exceed 4dBm in any 1MHz band.	PASSED	5.19 GHz = -22.27dBm
15.407(a)(1)	Peak transmit power and the peak power spectral density shall be reduced by the amount in dB that the transmitting antenna exceeds 6dBi.	N/A	All antennas tested have less than 6dBi antenna gain (Please see the antenna data sheets)
15.407(b)(6) 15.209	Unwanted emissions below 1 GHz must comply with the general field strength limits set forth in Section 15.209.	PASSED	See Data Sheets
15.407(b)(1)	All emissions outside of the 5.15-5.35 GHz band shall not exceed an EIRP of -27dBm/MHz.	PASSED	See Data Sheets
<b>Operation in the 5.25-5.35 GHz Band</b>			
15.407(a)(2)	26dB emissions bandwidth in MHz.	N/A	5.27 GHz = 44.20 MHz 5.31 GHz = 39.70 MHz
15.407(a)(2)	Peak transmit power shall not exceed the lesser of 250mW or 11dBm+10logB (where B = 26dB emissions bandwidth).	PASSED	5.27 GHz = 16.91dBm (49.08mW) 5.31 GHz = 15.21dBm (33.18mW)
15.407(a)(2)	The peak power spectral density shall not exceed 11dBm in any 1MHz band.	PASSED	5.27 GHz = 8.83dBm 5.31 GHz = 6.33dBm
15.407(a)(2)	Peak transmit power and the peak power spectral density shall be reduced by the amount in dB that the transmitting antenna exceeds 6dBi.	N/A	All antennas tested have less than 6dBi antenna gain (Please see the antenna data sheets)
15.407(b)(6) 15.209	Unwanted emissions below 1 GHz must comply with the general field strength limits set forth in Section 15.209.	PASSED	See Data Sheets
15.407(b)(2)	All emissions outside of the 5.15-5.35 GHz band shall not exceed an EIRP of -27dBm/MHz. Must meet all applicable technical requirements for operating in the 5.15-5.25 GHz band.	PASSED	See Data Sheets
<b>General Requirements For All Bands</b>			
15.407(a)(6)	The ratio of the peak excursion of the modulation envelope to the peak transmit power shall not exceed 13dB across any 1 MHz bandwidth or the emissions bandwidth whichever is less.	PASSED	5.19 GHz = 5.50 dB 5.27 GHz = 6.34 dB 5.31 GHz = 5.66 dB
15.407(f)	Radio frequency radiation exposure requirement.	PASSED	Refer to MPE Calculations Exhibit
15.407(b)(6) 15.207	UNII devices using AC power line are required to comply with the conducted limits set forth in Section 15.207.	PASSED	See Data Sheets





2.0 Summary Of Test Results (Continued)

**ANALYSIS AND CONCLUSIONS**

Based upon the measurement results we find that this equipment is within the limits of the global standards listed on the cover page of this test report. All results are based on a test of one sample. If any significant changes are made to the unit, the changes shall be evaluated and a retest may be required.

Approval Signatories

**Test and Report Completed By:**

**11/10/06**

**Johnny Candelas**  
**Test Technician**  
**Aegis Labs, Inc.**

**Date:**

**Report Approved By:**

**11/10/06**

**Rick Candelas**  
**Quality Assurance Manager**  
**Aegis Labs, Inc.**

**Date:**



### 3.0 ADMINISTRATIVE DATA AND TEST DESCRIPTION

<b>DEVICE TESTED:</b>	ITE Type: Intel PRO/Wireless 4965AGN Network Connection Model Number(s): 4965AGN Serial Number: 0013E804612B FCC ID: PD94965AGN
<b>DATE EUT RECEIVED:</b>	August 25 <sup>th</sup> , 2006
<b>TEST DATE(S):</b>	September 7 <sup>th</sup> – November 9 <sup>th</sup> , 2006
<b>ORIGIN OF TEST SAMPLE(S):</b>	Production
<b>EQUIPMENT CLASS:</b>	EUT tested as CLASS B device
<b>RESPONSIBLE PARTY:</b>	Intel Corporation 2111 NE 25 <sup>th</sup> Avenue Hillsboro, Oregon 97124
<b>CLIENT CONTACT:</b>	Mr. Robert Paxman
<b>MANUFACTURER:</b>	Intel Corporation
<b>TEST LOCATION:</b>	Aegis Labs, Inc. 32231 Trabuco Creek Road Trabuco Canyon, CA 92678 Open Area Test Site #1& #2
<b>ACCREDITATION CERTIFICATE(S):</b>	A2LA Certificate Number: 1111.01, Valid through February 28, 2008
<b>PURPOSE OF TEST:</b>	To demonstrate compliance with the standards as described in Sections 1.0 & 2.0 of this report.
<b>UNCERTAINTY BUDGET:</b>	Proficiency Testing and Uncertainty Calculations for all tests indicated in this report have been conducted in accordance with ISO 17025: 2005 requirements Section 5.4.6, and 5.9. Uncertainty Budgets and Proficiency Test results available upon request.
<b>STATEMENT OF CALIBRATION:</b>	All accredited equipment calibrations were performed by Liberty Labs, Inc. and World Cal. with typical calibration uncertainty estimates derived from ISO Guide to the determination of uncertainties with a Coverage Factor of k=2 for 95% level of confidence.



## 4.0 DESCRIPTION OF EUT CONFIGURATION

### 4.1 EUT Description

<b>Equipment Under Test (EUT)</b>	
<b>Trade Name:</b>	Intel PRO/Wireless 4965AGN Network Connection
<b>Model Number:</b>	4965AGN
<b>Frequency Range:</b>	802.11a = 5.15-5.35 GHz & 5.47-5.725 802.11n = 5.15-5.35 GHz & 5.47-5.725
<b>Enclosure:</b>	The EUT contains it's own shield made of aluminum approximately 2.5cm wide by 2cm deep by 2mm high.
<b>Transfer Rate:</b>	6/36/54 Mbps for 802.11a mode Up to 300 Mbps for 802.11n mode
<b>Antenna Type:</b>	PIFA (Main/Aux)
<b>Antenna Gain (See Note 2):</b>	Ethertronics Antenna @ 5 GHz = 5.00 dBi
<b>Transmit Output Power:</b>	Please see Appendix A (Data Sheets) for actual output power.
<b>Power Supply:</b>	3.3VDC from computer MPCIE slot.
<b>Number of External Test Ports Exercised:</b>	3 Antenna Ports

The Intel PRO/Wireless 4965AGN Network Connection is an embedded 802.11a/b/g/n network adapter operating in the 2.4 GHz and 5 GHz spectrum. The EUT is based on the Mini Card form factor designed to meet the space and size requirements for thin and light notebook PCs. It is capable of a data rate of up to 300 Mbps.

**NOTE 1:** For a more detailed description, please refer to the manufacture's specifications or User's Manual.

**NOTE 2:** The EUT was tested with a set of Ethertronics Antennas. (Refer to the antenna specifications exhibits).

## 4.2 EUT Configuration

The EUT was tested installed in the Mini PCI-E slot of the host computer as a modular device using a PCI extender board to extend the EUT outside the computer chassis. The EUT was then connected to a set of antennas via its Chain A, B, & C antenna ports. Data for a set of Ethertronics antennas can be found in Appendix A (Data Sheets)

The low, middle, and high channels were tested in 802.11a, b, g, & n modes. Also, the EUT was tested once transmitting from Chain A antenna port and once transmitting from Chain B antenna port. The EUT was placed in either continuous transmit or continuous receive mode by a program provided by the manufacturer (*CRTU Version 4.1.14.0000*).

## 4.3 List of EUT, Sub-Assemblies and Host Equipment

<b>Equipment Under Test</b>			
<b>Manufacturer</b>	<b>Equipment Name</b>	<b>Model or Part Number</b>	<b>Serial Number</b>
Intel Corporation	Intel PRO/Wireless 4965AGN Network Connection	4965AGN	0013E804612B

<b>EUT Sub Assemblies</b>			
<b>Manufacturer</b>	<b>Equipment Name</b>	<b>Model or Part Number</b>	<b>Serial Number</b>
Ethertronics	Chain A (Tx) Antenna	MPCI01001	N/A
Ethertronics	Chain B (Tx) Antenna	MPCI01001	N/A
Ethertronics	Chain C (Rx) Antenna	MPCI01001	N/A

<b>HOST EQUIPMENT LIST</b>			
<b>Manufacturer</b>	<b>Equipment Name</b>	<b>Model or Part Number</b>	<b>Serial Number</b>
GST	Host Computer	GST-8000	G0400295337-015
Sony	Monitor	CPD-200ES	0742818
Logitech	Keyboard	Y-BF37	MCT25200581
Logitech	Mouse	M-BJ58	LNA22802012

NOTE: All the power cords of the above support equipment are standard and non-shielded.



#### 4.4 I/O Cabling Diagram and Description

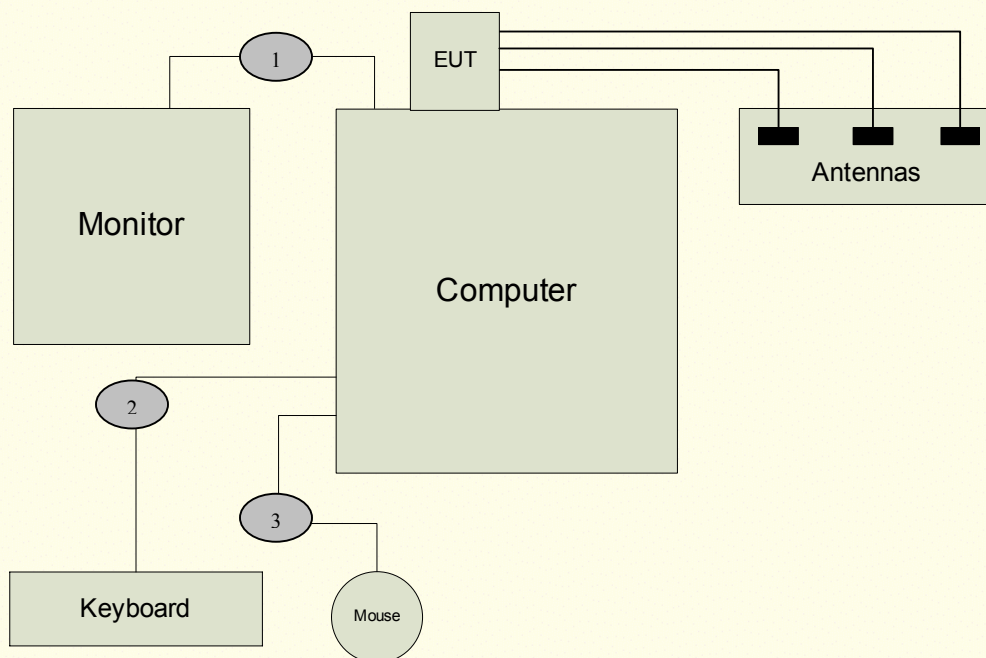

**Signal Line Cable Description**

Cable	Length	Construction	Source Connector	Destination Connector	Bundled Length	Ferrite Attached	Note
1	1.5m	Round, Braid & Foil Shielded	Host Computer: Metallic DB-15	Monitor: Hardwired	N/A	N/A	N/A
2	1.5m	Round, Braid & Foil Shielded	Host Computer: Metallic 8-pin Mini DIN	Keyboard: Hardwired	N/A	N/A	N/A
3	1.5m	Round, Braid & Foil Shielded	Host Computer: Metallic 8-pin Mini DIN	Mouse: Hardwired	N/A	N/A	N/A



#### 4.5 EMC Test Hardware and Software Measurement Equipment

TEST EQUIPMENT LIST - Emissions					
Equipment Name	Manufacturer	Model Number	Serial Number	Calibration Due Date	Maintenance Calibration Cycle
Spectrum Analyzer	Agilent	8565EC	3946A00245	07/24/07	1 Year
Antenna - Horn	EMCO	3115	2230	05/15/07	1 Year
Preamp	Agilent	8449B	3008A01573	12/08/06	1 Year
18 Foot Coax	Semflex	X116BFSX10216	546	12/14/06	1 Year
5.15-5.35 GHz Notch Filter	Microwave Circuits	N0452502	3173-01	04/21/07	2 Years
Antenna - 18-26.5 GHz Pre-amplified Horn	Aegis Labs, Inc.	H042	SLK-35-3W	02/08/07	1 Year
EMI Receiver - RF Section	Hewlett Packard	8546A	3325A00137	04/26/07	1 Year
EMI Receiver - RF Filter Section	Hewlett Packard	85460A	3325A00138	04/26/07	1 Year
10dB Attenuator	Radiall	R412710000	Lot 9624	06/30/07	2 Years
LISN (EUT)	Solar Electronics	9252-50-R-24-BNC	961025	03/30/08	2 Years
LISN (Access)	Solar Electronics	9252-50-R-24-BNC	961024	07/05/07	2 Years
Antenna - Biconical	EMCO	3110B	3383	04/06/07	1 Year
Antenna - Log Periodic	EMCO	3148	47943	06/22/07	1 Year
Power Meter	Anritsu	ML2487A	6K00001785	05/30/07	1 Year
Wide Bandwidth Sensor	Anritsu	MA2491A	31193	05/30/07	1 Year
12dB Attenuator	Narda	4779-12	203	12/09/06	1.5 Year
Temperature/Humidity Monitor	Dickson	TH550	7255185	03/24/07	1 Year



## 5.0 CONDITIONS DURING EMISSIONS MEASUREMENTS

### 5.1 General

All measurements were made according to the procedures defined in or referred to by the standard listed on the cover page of this report. The measurements were made in the operating mode producing the largest emissions consistent with normal operation and connected to the minimum configuration of auxiliary devices.

### 5.2 Conducted Emissions Test Setup

The following was the test configuration.

EUT signal cables that hung closer than 40 cm to the horizontal metal ground plane were folded back and forth forming a bundle 30 cm to 40 cm long. The power cord of the EUT was also bundled in the center and plugged into one of the artificial mains network (AMN). All peripheral equipment was powered from a second AMN via a multiple outlet strip placed at a distance on 10cm from each other. The AMN and ISN were positioned 80cm from the EUT. Signal cables that were not connected to an AE were terminated using the correct termination. If applicable, the current probe was placed at 0.1 m from the ISN.

Peak, quasi-peak and/or average detectors were used for testing performed between 150 kHz and 30 MHz. A swept frequency scan was performed for both Line 1 and Line 2. The six highest readings were compared against the limit and recorded in the data sheet along with a snapshot image of the sweep scan. The graphical scans in Appendix A only reflect peak readings while the tabulated data sheets reflect peak, average, and/or quasi-peak measurements.

#### Climatic Conditions:

The EUT was tested within its intended operating and climatic conditions.

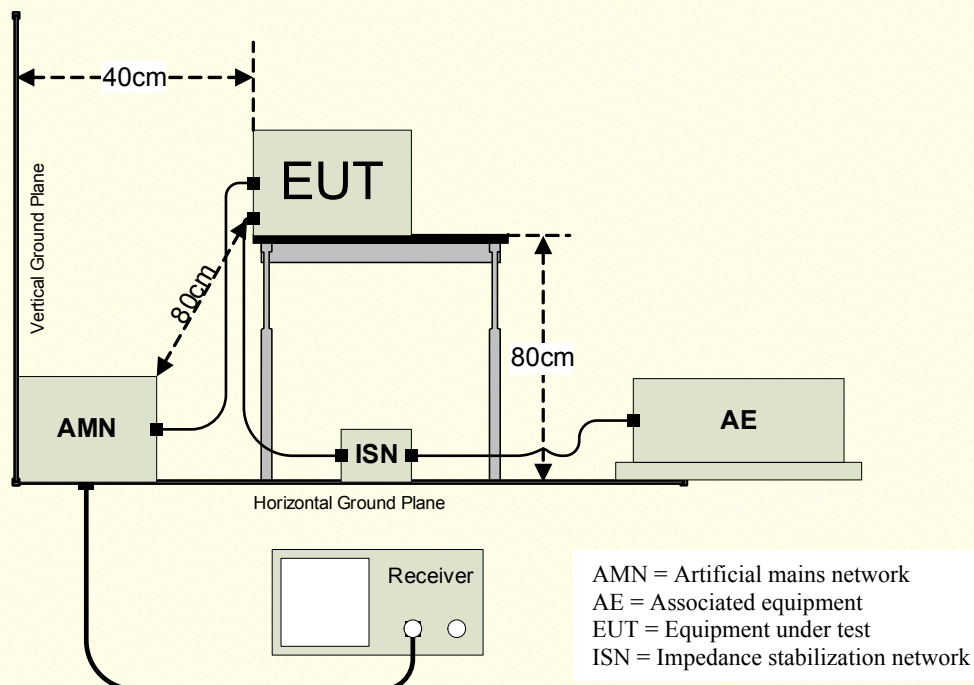



### 5.3 Radiated Emissions Test Setup

The Open Area Test Site (OATS) was used for radiated emission testing. The receiving (Rx) antenna(s) was placed 10m from the nearest side of the EUT facing the Rx antenna. The EUT (if floor-standing) was placed directly on the flush-mounted 360 degree rotating turntable. The EUT (if table-top) was placed directly on an 80cm high non-metallic table, and the table was placed on the rotating turntable. During the initial EMI scan, all the suspect frequencies, i.e.; harmonics, broadband signals were checked with the Rx broadband antennas in both vertical and horizontal polarities. The biconical Rx, log periodic Rx, and horn Rx antennas were used from 30MHz – 299.99MHz, 300MHz – 1000MHz, and 1GHz – 18GHz respectively.

Upon completion of all harmonic and broadband measurements, the balance of any remaining frequencies was checked between 30MHz – 18GHz. Any signals appearing within 20 dB of the classification limit was measured. Each signal was maximized by first rotating the turntable at least 360 degrees and recording the azimuth in the data sheet. Lastly, the Rx antenna was raised and/or lowered to maximize the signal elevation. If the measured signal was obtained using the peak detector and that signal appeared within 3 dB of the regulatory limit line, then the same signal was re-measured using the quasi-peak detector on the EMI receiver. Both meter readings if necessary were recorded on the data sheet.

#### Climatic Conditions:

The EUT was tested within its intended operating and climatic conditions.

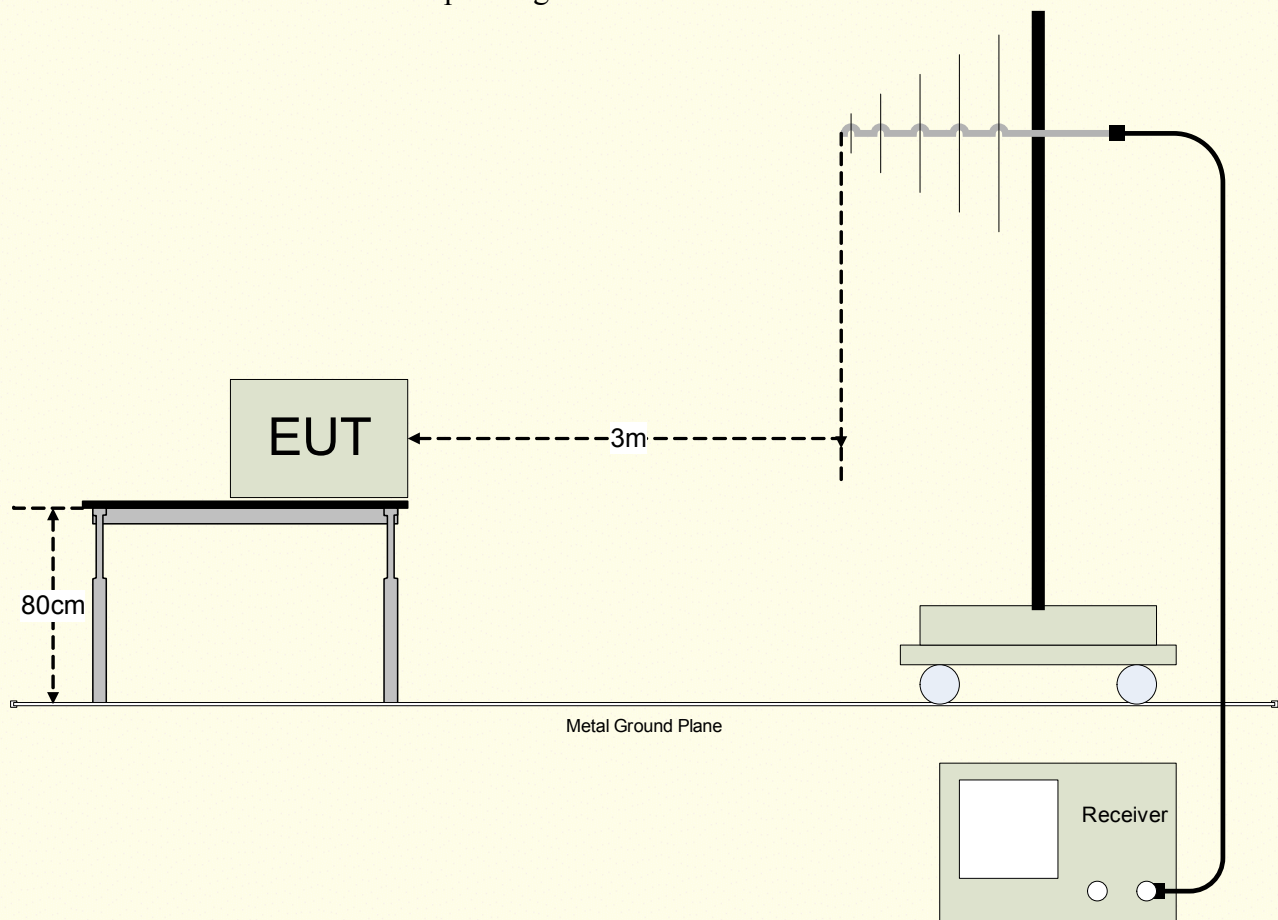





## **APPENDIX A**

### ***TEST DATA***



## AC POWER PORT - CONDUCTED EMISSIONS TEST RESULTS

<b>CLIENT:</b>	Intel Corporation	<b>DATE:</b>	09/07/06
<b>EUT:</b>	Intel PRO/Wireless 4965AGN Network Connection	<b>PROJECT NUMBER:</b>	INTEL-060907
<b>MODEL NUMBER:</b>	4965AGN	<b>TEST ENGINEER:</b>	JC
<b>SERIAL NUMBER:</b>	0013E804612B	<b>SITE #:</b>	1
<b>CONFIGURATION:</b>	Tested installed in the host computer's mini PCI slot.	<b>TEMPERATURE:</b>	22 deg. C
		<b>HUMIDITY:</b>	49%
		<b>TIME:</b>	2:15 PM

<b>Description:</b>	Conducted Power RF Emissions (150 kHz – 30 MHz)
<b>Results:</b>	<b>PASSED</b> LINE 1 and LINE 2 Limits
<b>Note:</b>	Conducted Emissions Measurements were performed on the EUT with the power supply set at the following voltage and frequency. <ul style="list-style-type: none"><li>• 120VAC / 60 Hz</li></ul>



AC Power Port – Conducted Emissions Test Results (Continued)

**Continuously Transmitting @ 120VAC/60Hz (INTEL-060907-01)**

**FCC CLASS B CONDUCTED EMISSIONS – LINE 1**

Freq. (MHz)	Meter Reading (dBuV)	Detector (PK/QP/AV)	Average Limit (dBuV)	Average Delta(dB)	Quasi-Peak Limit (dBuV)	Quasi-Peak Delta(dB)
0.2000	41.44	PK	54.57	-13.13	64.57	-23.13
0.2700	37.40	PK	52.57	-15.17	62.57	-25.17
1.8400	35.48	PK	46.00	-10.52	56.00	-20.52
7.3900	38.91	PK	50.00	-11.09	60.00	-21.09
10.0000	36.02	PK	50.00	-13.98	60.00	-23.98
16.1400	38.26	PK	50.00	-11.74	60.00	-21.74

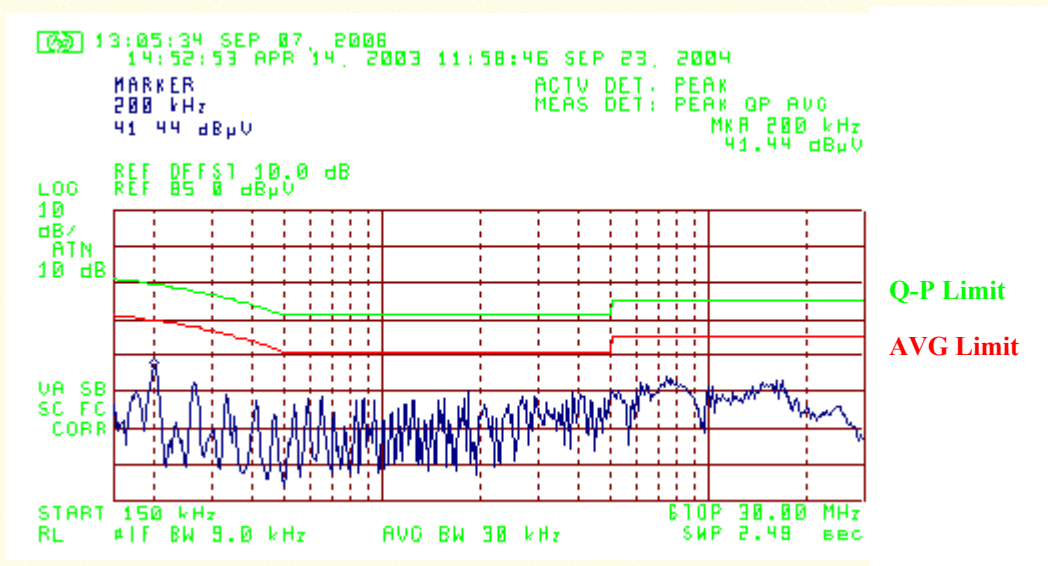

AC Power Port – Conducted Emissions Test Results (Continued)

**Continuously Transmitting @ 120VAC/60Hz (INTEL-060907-01)**

**FCC CLASS B CONDUCTED EMISSIONS - LINE 2**

Freq. (MHz)	Meter Reading (dBuV)	Detector (PK/QP/AV)	Average Limit (dBuV)	Average Delta(dB)	Quasi-Peak Limit (dBuV)	Quasi-Peak Delta(dB)
0.2000	41.56	PK	54.57	-13.01	64.57	-23.01
0.2700	37.40	PK	52.57	-15.17	62.57	-25.17
0.3300	33.69	PK	50.86	-17.17	60.86	-27.17
4.1300	32.63	PK	46.00	-13.37	56.00	-23.37
7.6800	36.91	PK	50.00	-13.09	60.00	-23.09
15.2200	37.46	PK	50.00	-12.54	60.00	-22.54

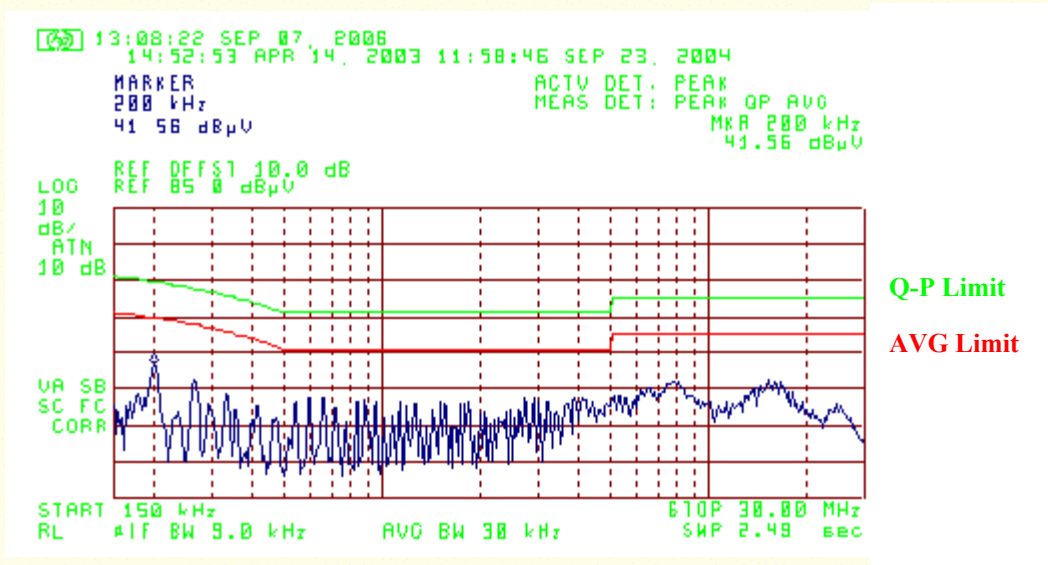





## RADIATED EMISSIONS TEST RESULTS

<b>CLIENT:</b>	Intel Corporation	<b>DATE:</b>	09/07/06
<b>EUT:</b>	Intel PRO/Wireless 4965AGN Network Connection	<b>PROJECT NUMBER:</b>	INTEL-060907
<b>MODEL NUMBER:</b>	4965AGN	<b>TEST ENGINEER:</b>	JC
<b>SERIAL NUMBER:</b>	0013E804612B	<b>SITE #:</b>	1
<b>CONFIGURATION:</b>	Tested installed in the host computer's mini PCI slot.	<b>TEMPERATURE:</b>	22 deg. C
		<b>HUMIDITY:</b>	49%
		<b>TIME:</b>	2:15 PM

<b>Description:</b>	Radiated RF Emissions (30 MHz – 1000 MHz)
<b>Results:</b>	<b>PASSED</b> Horizontal and Vertical Antenna Polarizations Class B Limits
<b>Note:</b>	Radiated Emissions Measurements were performed on the EUT with the power supply set at the following voltage and frequency. <ul style="list-style-type: none"><li>• 120VAC / 60 Hz.</li></ul>

### Radiated Emissions Sample Calculations

$$\text{Corrected Meter Reading} = \text{Meter Reading} + F + C - D$$

Where, F = Antenna Factor

C = Cable Factor

G = Amplifier Gain

D = Distance Factor (if applicable)

Therefore, the equation for determining the Corrected Meter Reading Limit (CML) is:

$$\text{CML} = \text{Specification Limit} - F - C + D$$



Radiated Emissions Test Results (Continued)

**Continuously Transmitting @ 120VAC/60Hz (INTEL-060907-03)**

**Horizontal Open Field Maximized Data**

<i>Freq. (MHz)</i>	<i>Meter Reading (dBuV)</i>	<i>Antenna Height (cm)</i>	<i>Azimuth (degrees)</i>	<i>Quasi pk or AVG (dBuV)</i>	<i>Cable Factor (dB)</i>	<i>Cable Factor (dB)</i>	<i>Antenna Factor (dB)</i>	<i>Corrected Reading (dBuV/m)</i>	<i>Limits (dBuV/m)</i>	<i>Diff (dB) +=FAIL</i>	
48.02	8.58	400	45			2.65	10.32	10.46	32.01	40.00	-7.99
120.00	14.23	400	90	11.03	Q	2.39	11.20	10.46	35.08	43.50	-8.42
250.01	10.96	350	90			2.91	17.40	10.46	41.73	46.00	-4.27
305.09	11.32	300	270			3.07	14.49	10.46	39.33	46.00	-6.67
375.00	10.53	250	45			3.35	15.10	10.46	39.44	46.00	-6.57
386.00	11.63	225	45			3.39	15.54	10.46	41.02	46.00	-4.98

**Vertical Open Field Maximized Data**

<i>Freq. (MHz)</i>	<i>Meter Reading (dBuV)</i>	<i>Antenna Height (cm)</i>	<i>Azimuth (degrees)</i>	<i>Quasi pk or AVG (dBuV)</i>	<i>Cable Factor (dB)</i>	<i>Cable Factor (dB)</i>	<i>Antenna Factor (dB)</i>	<i>Corrected Reading (dBuV/m)</i>	<i>Limits (dBuV/m)</i>	<i>Diff (dB) +=FAIL</i>	
48.01	11.12	100	45			2.65	10.52	10.46	34.75	40.00	-5.25
119.98	18.40	100	90	14.65	Q	2.39	10.80	10.46	38.30	43.50	-5.20
250.03	8.51	100	45			2.91	18.30	10.46	40.18	46.00	-5.82
306.35	13.06	100	45			3.07	14.78	10.46	41.37	46.00	-4.63
358.01	7.94	100	0			3.27	15.44	10.46	37.11	46.00	-8.89
375.05	8.85	100	90			3.35	15.30	10.46	37.96	46.00	-8.04
386.01	15.71	100	180	13.62	Q	3.39	15.61	10.46	43.08	46.00	-2.92





## RADIATED EMISSIONS TEST RESULTS

<b>CLIENT:</b>	Intel Corporation	<b>DATE:</b>	09/18/06
<b>EUT:</b>	Intel PRO/Wireless 4965AGN Network Connection	<b>PROJECT NUMBER:</b>	INTEL-060907
<b>MODEL NUMBER:</b>	4965AGN	<b>TEST ENGINEER:</b>	BM/JC
<b>SERIAL NUMBER:</b>	0013E804612B	<b>SITE #:</b>	2
<b>CONFIGURATION:</b>	Tested installed in the host computer's mini PCI slot in <b>802.11a (5150-5350 MHz) mode with Ethertronics Antennas.</b>	<b>TEMPERATURE:</b>	20 deg. C
		<b>HUMIDITY:</b>	48% RH
		<b>TIME:</b>	9:00 PM

<b>Description:</b>	Radiated RF Emissions (1 GHz – 18 GHz)
<b>Results:</b>	<b>PASSED</b> Horizontal and Vertical Antenna Polarizations Class B Limits
<b>Note:</b>	Radiated Emissions Measurements were performed on the EUT with power supply set at the following voltage and frequency. <ul style="list-style-type: none"> <li>• 120VAC / 60 Hz.</li> </ul>

Unwanted Spurious Emissions Limits			
Frequency (MHz)	Field Strength (uV/m)	Field Strength (dBuV/m) (Emissions in the restricted bands)	Field Strength (dBm/MHz) (Emissions outside the restricted bands)
Above 960	500	54.00 (Average) 74.00 (Peak)	< -20 dBc

### Radiated Emissions Sample Calculations

$$\text{Corrected Meter Reading} = \text{Meter Reading} + F + C - D$$

Where, F = Antenna Factor

C = Cable Factor

G = Amplifier Gain

D = Distance Factor (if applicable)

Therefore, the equation for determining the Corrected Meter Reading Limit (CML) is:

$$\text{CML} = \text{Specification Limit} - F - C + D$$



Radiated Emissions Test Results (Continued)

*Fundamental Measurements in 802.11a mode (5150-5350 MHz)  
 Channels 36, 48, 52, & 64  
 Continuous TX at Chain A Antenna port with Ethertronics Antennas  
 Aegis Labs, Inc. File #: INTEL-060907-20*

<b>RADIATED EMISSIONS - Horizontal Antenna Polarization</b>											
Freq. (MHz)	Meter Reading (dBuV)	Antenna Height (cm)	Azimuth (degrees)	Quasi pk or AVG (dBuV)		Cable Factor (dB)	Ant. Factor (dB)	Corrected Reading (dBuV)	Limits (dBuV)	Diff (dB) +=FAIL	Comments
5180.00	65.17	100	225			4.73	34.62	104.53			<b>Ch. 36</b>
5180.00				55.27	A	4.73	34.62	94.63			
5240.00	69.83	125	225			4.76	34.73	109.32			<b>Ch. 48</b>
5240.00				60.00	A	4.76	34.73	99.49			
5260.00	68.33	125	225			4.77	34.77	107.87			<b>Ch. 52</b>
5260.00				56.90	A	4.77	34.77	96.44			
5320.00	67.17	125	225			4.80	34.88	106.84			<b>Ch. 64</b>
5320.00				56.34	A	4.80	34.88	96.01			

<b>RADIATED EMISSIONS – Vertical Antenna Polarization</b>											
Freq. (MHz)	Meter Reading (dBuV)	Antenna Height (cm)	Azimuth (degrees)	Quasi pk or AVG (dBuV)		Cable Factor (dB)	Ant. Factor (dB)	Corrected Reading (dBuV)	Limits (dBuV)	Diff (dB) +=FAIL	Comments
5180.00	64.00	100	225			4.73	34.39	103.12			<b>Ch. 36</b>
5180.00				54.10	A	4.73	34.39	93.22			
5240.00	67.33	100	135			4.76	34.48	106.57			<b>Ch. 48</b>
5240.00				56.51	A	4.76	34.48	95.75			
5260.00	66.33	100	135			4.77	34.52	105.62			<b>Ch. 52</b>
5260.00				55.92	A	4.77	34.52	95.21			
5320.00	66.17	125	135			4.80	34.61	105.58			<b>Ch. 64</b>
5320.00				55.91	A	4.80	34.61	95.32			

NOTE: Fundamental signals measured to calculate the band edge field strengths using the “Marker Delta Method”.





Radiated Emissions Test Results (Continued)

*Band Edge Field Strength Measurements in 802.11a mode (5150-5350 MHz)  
Channels 36 & 64  
Continuous TX at Chain A Antenna port with Ethertronics Antennas  
Aegis Labs, Inc. File #: INTEL-060907-20*

<b>RADIATED EMISSIONS - Horizontal Antenna Polarization</b>										
Freq. (MHz)	Meter Reading (dBuV)	Antenna Height (cm)	Azimuth (degrees)	Quasi pk or AVG (dBuV)	Cable Factor (dB)	Ant. Factor (dB)	Corrected Reading (dBuV)	Limits (dBuV)	Diff (dB) +=FAIL	Comments
5150.00							62.53	74.00	-11.47	<b>Ch. 36</b>
5150.00				A			49.96	54.00	-4.04	
5350.00							64.34	74.00	-9.66	<b>Ch. 64</b>
5350.00				A			50.34	54.00	-3.66	

<b>RADIATED EMISSIONS – Vertical Antenna Polarization</b>										
Freq. (MHz)	Meter Reading (dBuV)	Antenna Height (cm)	Azimuth (degrees)	Quasi pk or AVG (dBuV)	Cable Factor (dB)	Ant. Factor (dB)	Corrected Reading (dBuV)	Limits (dBuV)	Diff (dB) +=FAIL	Comments
5150.00							61.12	74.00	-12.88	<b>Ch. 36</b>
5150.00				A			48.55	54.00	-5.45	
5350.00							63.08	74.00	-10.92	<b>Ch. 64</b>
5350.00				A			49.65	54.00	-4.35	

NOTE: The “Band Edge Field Strength” was calculated using the “Fundamental” and “Conducted Band Edge” measurements per the “Marker-Delta Method” with the following formula:

$$BE = Fm - \Delta m$$

Where





BE = Band Edge Field Strength

Fm = Measured Fundamental (Peak or Average)

Δm = Measured Conducted Band Edge Delta (Peak or Average)

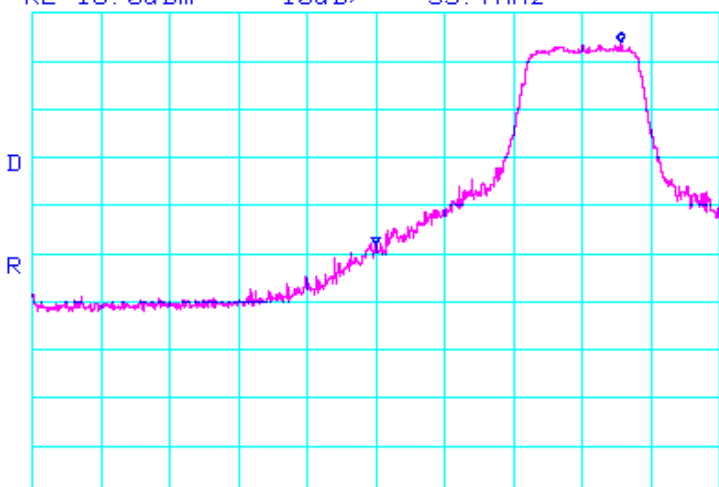
### Radiated Emissions Test Results (Continued)

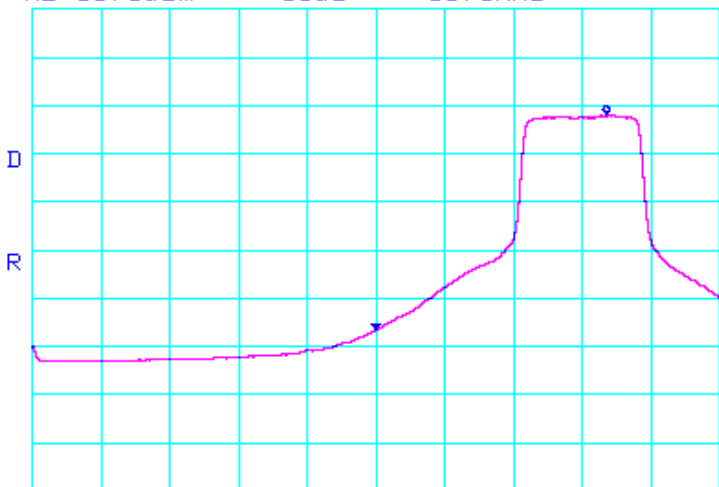
Plots Showing Out-Of-Band Emissions (Peak RBW=VBW=1MHz; Average RBW = 1MHz, VBW = 10Hz)

Test Date	Data	Test Eng.
09/21/06	5.18 GHz band edge <b>PEAK DELTA</b> (INTEL-060907-21a01)	JC
<p>*ATTEN 20dB                                  ΔMKR 42.00dB            RL 16.0dBm                                10dB/                                35.7MHz</p>  <p>CENTER 5.1500GHz                                  SPAN 100.0MHz            *RBW 1.0MHz                                *VBW 1.0MHz                                SWP 50.0ms</p>		
		
Test Date	Data	Test Eng.
09/21/06	5.18 GHz band edge <b>AVERAGE DELTA</b> (INTEL-060907-21a02)	JC
<p>*ATTEN 20dB                                  ΔMKR 44.67dB            RL 16.0dBm                                10dB/                                33.5MHz</p>  <p>CENTER 5.1500GHz                                  SPAN 100.0MHz            *RBW 1.0MHz                                *VBW 10Hz                                SWP 37.0sec</p>		
		







Radiated Emissions Test Results (Continued)

*Spurious Emissions Measurements in 802.11a mode (5150-5350 MHz)  
Channels 36, 52, & 64  
Continuous TX at Chain A Antenna port with Ethertronics Antennas  
Aegis Labs, Inc. File #: INTEL-060907-19*

**RADIATED EMISSIONS - Horizontal Antenna Polarization**

Freq. (MHz)	Meter Reading (dBuV)	Antenna Height (cm)	Azimuth (degrees)	Quasi pk or AVG (dBuV)		Preamp Factor (dB)	Cable Factor (dB)	Ant. Factor (dB)	Corrected Reading (dBuV)	Limits (dBuV)	Diff (dB) +=FAIL	Comments
3453.33	62.17	100	225			50.78	3.84	32.29	47.52	68.00	-20.48	<b>Ch. 36</b>
6906.66	63.67	100	135			50.50	5.49	35.91	54.56	68.00	-13.44	
10360.01	63.17	100	135			50.39	6.86	38.62	58.26	68.00	-9.74	
3506.66	58.67	125	225			50.76	3.87	32.41	44.20	68.00	-23.80	<b>Ch. 52</b>
7013.40	61.33	100	225			50.42	5.54	36.03	52.48	68.00	-15.52	
3546.66	57.17	150	225			50.76	3.90	32.50	42.81	68.00	-25.19	<b>Ch.64</b>
7093.55	61.33	125	225			50.38	5.57	36.24	52.76	68.00	-15.24	

**RADIATED EMISSIONS - Vertical Antenna Polarization**

Freq. (MHz)	Meter Reading (dBuV)	Antenna Height (cm)	Azimuth (degrees)	Quasi pk or AVG (dBuV)		Preamp Factor (dB)	Cable Factor (dB)	Ant. Factor (dB)	Corrected Reading (dBuV)	Limits (dBuV)	Diff (dB) +=FAIL	Comments
3453.33	58.67	125	135			50.78	3.84	31.80	43.53	68.00	-24.47	<b>Ch. 36</b>
6906.66	64.33	100	225			50.50	5.49	35.83	55.14	68.00	-12.86	
3506.16	57.00	100	225			50.76	3.87	31.92	42.03	68.00	-25.97	<b>Ch. 52</b>
7013.39	64.50	100	225			50.42	5.54	35.93	55.55	68.00	-12.45	
3546.74	58.67	100	225			50.76	3.90	32.02	43.82	68.00	-24.18	<b>Ch.64</b>
7093.55	61.83	100	225			50.38	5.57	36.14	53.16	68.00	-14.84	
10640.00	65.33	100	135			50.44	6.96	38.73	60.58	74.00	-13.42	
10640.00				51.86	A	50.44	6.96	38.73	47.11	54.00	-6.89	





Radiated Emissions Test Results (Continued)

*Spurious Emissions Measurements in 802.11a mode (5150-5350 MHz)  
Channels 36, 52, & 64  
Continuous RX at Chain A Antenna port with Ethertronics Antennas  
Aegis Labs, Inc. File #: INTEL-060907-19*

**RADIATED EMISSIONS - Horizontal Antenna Polarization**

Freq. (MHz)	Meter Reading (dBuV)	Antenna Height (cm)	Azimuth (degrees)	Quasi pk or AVG (dBuV)		Preamp Factor (dB)	Cable Factor (dB)	Ant. Factor (dB)	Corrected Reading (dBuV)	Limits (dBuV)	Diff (dB) +=FAIL	Comments
3453.33	57.83	100	225			50.78	3.84	32.29	43.18	74.00	-30.82	<b>Ch. 36</b>
3453.33				50.62	A	50.78	3.84	32.29	35.97	54.00	-18.03	
6906.66	56.50	100	225			50.50	5.49	35.91	47.39	74.00	-26.61	
6906.66				46.92	A	50.50	5.49	35.91	37.81	54.00	-16.19	
3506.66	57.00	125	225			50.76	3.87	32.41	42.53	74.00	-31.47	<b>Ch. 52</b>
3506.66				48.47	A	50.76	3.87	32.41	34.00	54.00	-20.00	
3546.66	57.17	100	225			50.76	3.90	32.50	42.81	74.00	-31.19	<b>Ch.64</b>
3546.66				48.85	A	50.76	3.90	32.50	34.49	54.00	-19.51	

**RADIATED EMISSIONS - Vertical Antenna Polarization**

Freq. (MHz)	Meter Reading (dBuV)	Antenna Height (cm)	Azimuth (degrees)	Quasi pk or AVG (dBuV)		Preamp Factor (dB)	Cable Factor (dB)	Ant. Factor (dB)	Corrected Reading (dBuV)	Limits (dBuV)	Diff (dB) +=FAIL	Comments
3453.33	57.00	100	135			50.78	3.84	31.80	41.86	74.00	-32.14	<b>Ch. 36</b>
3453.33				50.46	A	50.78	3.84	31.80	35.32	54.00	-18.68	
6906.71	54.83	100	225			50.50	5.49	35.83	45.64	74.00	-28.36	
6906.71				47.32	A	50.50	5.49	35.83	38.13	54.00	-15.87	
3506.68	57.83	100	135			50.76	3.87	31.92	42.86	74.00	-31.14	<b>Ch. 52</b>
3506.68				51.25	A	50.76	3.87	31.92	36.28	54.00	-17.72	
3546.66	56.67	100	135			50.76	3.90	32.02	41.82	74.00	-32.18	<b>Ch.64</b>
3546.66				49.84	A	50.76	3.90	32.02	34.99	54.00	-19.01	



Radiated Emissions Test Results (Continued)

*Fundamental Measurements in 802.11a mode (5150-5350 MHz)  
Channels 36, 48, 52, & 64  
Continuous TX at Chain B Antenna port with Ethertronics Antennas  
Aegis Labs, Inc. File #: INTEL-060907-24*

<b>RADIATED EMISSIONS - Horizontal Antenna Polarization</b>											
Freq. (MHz)	Meter Reading (dBuV)	Antenna Height (cm)	Azimuth (degrees)	Quasi pk or AVG (dBuV)		Cable Factor (dB)	Ant. Factor (dB)	Corrected Reading (dBuV)	Limits (dBuV)	Diff (dB) +=FAIL	Comments
5180.00	68.50	100	225			4.73	34.62	107.86			<b>Ch. 36</b>
5180.00				57.31	A	4.73	34.62	96.67			
5240.00	69.83	100	135			4.76	34.73	109.32			<b>Ch. 48</b>
5240.00				59.74	A	4.76	34.73	99.23			
5260.00	69.00	100	135			4.77	34.77	108.54			<b>Ch. 52</b>
5260.00				58.78	A	4.77	34.77	98.32			
5320.00	67.50	100	135			4.80	34.88	107.17			<b>Ch. 64</b>
5320.00				56.46	A	4.80	34.88	96.13			

<b>RADIATED EMISSIONS – Vertical Antenna Polarization</b>											
Freq. (MHz)	Meter Reading (dBuV)	Antenna Height (cm)	Azimuth (degrees)	Quasi pk or AVG (dBuV)		Cable Factor (dB)	Ant. Factor (dB)	Corrected Reading (dBuV)	Limits (dBuV)	Diff (dB) +=FAIL	Comments
5180.00	65.83	175	180			4.73	34.39	104.95			<b>Ch. 36</b>
5180.00				55.72	A	4.73	34.39	94.84			
5240.00	70.50	100	180			4.76	34.48	109.74			<b>Ch. 48</b>
5240.00				60.32	A	4.76	34.48	99.56			
5260.00	70.33	100	225			4.77	34.52	109.62			<b>Ch. 52</b>
5260.00				60.77	A	4.77	34.52	100.06			
5320.00	69.83	100	225			4.80	34.61	109.24			<b>Ch. 64</b>
5320.00				56.90	A	4.80	34.61	96.31			

NOTE: Fundamental signals measured to calculate the band edge field strengths using the “Marker Delta Method”.





Radiated Emissions Test Results (Continued)

*Band Edge Field Strength Measurements in 802.11a mode (5150-5350 MHz)  
Channels 36 & 64  
Continuous TX at Chain B Antenna port with Ethertronics Antennas  
Aegis Labs, Inc. File #: INTEL-060907-24*

<b>RADIATED EMISSIONS - Horizontal Antenna Polarization</b>										
Freq. (MHz)	Meter Reading (dBuV)	Antenna Height (cm)	Azimuth (degrees)	Quasi pk or AVG (dBuV)	Cable Factor (dB)	Ant. Factor (dB)	Corrected Reading (dBuV)	Limits (dBuV)	Diff (dB) +=FAIL	Comments
5150.00							68.03	74.00	-5.97	<b>Ch. 36</b>
5150.00				A			53.34	54.00	-0.66	
5350.00							66.84	74.00	-7.16	<b>Ch. 64</b>
5350.00				A			51.47	54.00	-2.53	

<b>RADIATED EMISSIONS – Vertical Antenna Polarization</b>										
Freq. (MHz)	Meter Reading (dBuV)	Antenna Height (cm)	Azimuth (degrees)	Quasi pk or AVG (dBuV)	Cable Factor (dB)	Ant. Factor (dB)	Corrected Reading (dBuV)	Limits (dBuV)	Diff (dB) +=FAIL	Comments
5150.00							65.12	74.00	-8.88	<b>Ch. 36</b>
5150.00				A			51.51	54.00	-2.49	
5350.00							68.91	74.00	-5.09	<b>Ch. 64</b>
5350.00				A			51.65	54.00	-2.35	

NOTE: The “Band Edge Field Strength” was calculated using the “Fundamental” and “Conducted Band Edge” measurements per the “Marker-Delta Method” with the following formula:

$$BE = F_m - \Delta m$$

Where

BE = Band Edge Field Strength

F<sub>m</sub> = Measured Fundamental (Peak or Average)

Δ<sub>m</sub> = Measured Conducted Band Edge Delta (Peak or Average)









Radiated Emissions Test Results (Continued)

*Spurious Emissions Measurements in 802.11a mode (5150-5350 MHz)  
Channels 36, 52, & 64  
Continuous TX at Chain B Antenna port with Ethertronics Antennas  
Aegis Labs, Inc. File #: INTEL-060907-22*

<b>RADIATED EMISSIONS - Horizontal Antenna Polarization</b>												
Freq. (MHz)	Meter Reading (dBuV)	Antenna Height (cm)	Azimuth (degrees)	Quasi pk or AVG (dBuV)		Preamp Factor (dB)	Cable Factor (dB)	Ant. Factor (dB)	Corrected Reading (dBuV)	Limits (dBuV)	Diff (dB) +=FAIL	Comments
3453.33	61.00	100	225			50.78	3.84	32.29	46.35	68.00	-21.65	<b>Ch. 36</b>
6906.66	63.33	100	135			50.50	5.49	35.91	54.22	68.00	-13.78	
10360.01	65.00	100	180			50.39	6.86	38.62	60.09	74.00	-13.91	
10360.01				51.86	A	50.39	6.86	38.62	46.95	54.00	-7.05	
3506.66	62.33	100	225			50.76	3.87	32.41	47.86	68.00	-20.14	<b>Ch. 52</b>
7013.40	62.00	100	135			50.42	5.54	36.03	53.15	68.00	-14.85	
10520.00	63.83	100	225			50.43	6.93	38.71	59.03	74.00	-14.97	
10520.00				50.28	A	50.43	6.93	38.71	45.48	54.00	-8.52	
3546.66	59.83	100	225			50.76	3.90	32.50	45.47	68.00	-22.53	<b>Ch.64</b>
7093.55	56.83	100	225			50.38	5.57	36.24	48.26	68.00	-19.74	
10640.00	62.67	100	225			50.44	6.96	38.76	57.95	74.00	-16.05	
10640.00				50.92	A	50.44	6.96	38.76	46.20	54.00	-7.80	

<b>RADIATED EMISSIONS - Vertical Antenna Polarization</b>												
Freq. (MHz)	Meter Reading (dBuV)	Antenna Height (cm)	Azimuth (degrees)	Quasi pk or AVG (dBuV)		Preamp Factor (dB)	Cable Factor (dB)	Ant. Factor (dB)	Corrected Reading (dBuV)	Limits (dBuV)	Diff (dB) +=FAIL	Comments
3453.33	60.67	125	135			50.78	3.84	31.80	45.53	68.00	-22.47	<b>Ch. 36</b>
6906.66	64.50	100	180			50.50	5.49	35.83	55.31	68.00	-12.69	
10360.00	66.50	100	225			50.39	6.86	38.59	61.56	74.00	-12.44	
10360.00				55.41	A	50.39	6.86	38.59	50.47	54.00	-3.53	
3506.16	59.00	125	180			50.76	3.87	31.92	44.03	68.00	-23.97	<b>Ch. 52</b>
7013.39	61.00	100	135			50.42	5.54	35.93	52.05	68.00	-15.95	
10520.01	65.67	100	225			50.43	6.93	38.70	60.87	74.00	-13.13	
10520.01				54.58	A	50.43	6.93	38.70	49.78	54.00	-4.22	
3546.74	59.17	100	180			50.76	3.90	32.02	44.32	68.00	-23.68	<b>Ch.64</b>
7093.55	58.83	100	225			50.38	5.57	36.14	50.16	68.00	-17.84	
10640.00	69.33	100	225			50.44	6.96	38.73	64.58	74.00	-9.42	
10640.00				55.29	A	50.44	6.96	38.73	50.54	54.00	-3.46	





Radiated Emissions Test Results (Continued)

*Spurious Emissions Measurements in 802.11a mode (5150-5350 MHz)  
Channels 36, 52, & 64  
Continuous RX at Chain B Antenna port with Ethertronics Antennas  
Aegis Labs, Inc. File #: INTEL-060907-22*

**RADIATED EMISSIONS - Horizontal Antenna Polarization**

Freq. (MHz)	Meter Reading (dBuV)	Antenna Height (cm)	Azimuth (degrees)	Quasi pk or AVG (dBuV)		Preamp Factor (dB)	Cable Factor (dB)	Ant. Factor (dB)	Corrected Reading (dBuV)	Limits (dBuV)	Diff (dB) +=FAIL	Comments
3453.33	57.83	100	225			50.78	3.84	32.29	43.18	74.00	-30.82	<b>Ch. 36</b>
3453.33				50.92	A	50.78	3.84	32.29	36.27	54.00	-17.73	
3506.66	58.33	100	225			50.76	3.87	32.41	43.86	74.00	-30.14	<b>Ch. 52</b>
3506.66				50.38	A	50.76	3.87	32.41	35.91	54.00	-18.09	
3546.66	57.00	100	225			50.76	3.90	32.50	42.64	74.00	-31.36	<b>Ch.64</b>
3546.66				48.32	A	50.76	3.90	32.50	33.96	54.00	-20.04	

**RADIATED EMISSIONS - Vertical Antenna Polarization**

Freq. (MHz)	Meter Reading (dBuV)	Antenna Height (cm)	Azimuth (degrees)	Quasi pk or AVG (dBuV)		Preamp Factor (dB)	Cable Factor (dB)	Ant. Factor (dB)	Corrected Reading (dBuV)	Limits (dBuV)	Diff (dB) +=FAIL	Comments
3453.33	57.33	100	135			50.78	3.84	31.80	42.19	74.00	-31.81	<b>Ch. 36</b>
3453.33				48.32	A	50.78	3.84	31.80	33.18	54.00	-20.82	
3506.68	58.83	100	225			50.76	3.87	31.92	43.86	74.00	-30.14	<b>Ch. 52</b>
3506.68				50.83	A	50.76	3.87	31.92	35.86	54.00	-18.14	
3546.66	57.17	125	225			50.76	3.90	32.02	42.32	74.00	-31.68	<b>Ch.64</b>
3546.66				49.29	A	50.76	3.90	32.02	34.44	54.00	-19.56	



## RADIATED EMISSIONS TEST RESULTS

<b>CLIENT:</b>	Intel Corporation	<b>DATE:</b>	10/06/06
<b>EUT:</b>	Intel PRO/Wireless 4965AGN Network Connection	<b>PROJECT NUMBER:</b>	INTEL-060907
<b>MODEL NUMBER:</b>	4965AGN	<b>TEST ENGINEER:</b>	BM/JC
<b>SERIAL NUMBER:</b>	0013E804612B	<b>SITE #:</b>	2
<b>CONFIGURATION:</b>	Tested installed in the host computer's mini PCI slot in <b>802.11n (5150-5350 MHz) mode 20MHz Wide with Ethertronics Antennas.</b>	<b>TEMPERATURE:</b>	16 deg. C
		<b>HUMIDITY:</b>	60% RH
		<b>TIME:</b>	4:30 PM

<b>Description:</b>	Radiated RF Emissions (1 GHz – 18 GHz)
<b>Results:</b>	<b>PASSED</b> Horizontal and Vertical Antenna Polarizations Class B Limits
<b>Note:</b>	Radiated Emissions Measurements were performed on the EUT with power supply set at the following voltage and frequency. <ul style="list-style-type: none"> <li>• 120VAC / 60 Hz.</li> </ul>

Unwanted Spurious Emissions Limits			
Frequency (MHz)	Field Strength (uV/m)	Field Strength (dBuV/m) (Emissions in the restricted bands)	Field Strength (dBm/MHz) (Emissions outside the restricted bands)
Above 960	500	54.00 (Average) 74.00 (Peak)	< -20 dBc

### Radiated Emissions Sample Calculations

$$\text{Corrected Meter Reading} = \text{Meter Reading} + F + C - D$$

Where, F = Antenna Factor

C = Cable Factor

G = Amplifier Gain

D = Distance Factor (if applicable)

Therefore, the equation for determining the Corrected Meter Reading Limit (CML) is:

$$\text{CML} = \text{Specification Limit} - F - C + D$$





Radiated Emissions Test Results (Continued)

*Fundamental Measurements in 802.11n mode 20MHz Wide (5150-5350 MHz)  
Channels 36, 48, 52, & 64  
Continuous TX at Chain A Antenna port with Ethertronics Antennas  
Aegis Labs, Inc. File #: INTEL-060907-52*

<b>RADIATED EMISSIONS - Horizontal Antenna Polarization</b>												
Freq. (MHz)	Meter Reading (dBuV)	Antenna Height (cm)	Azimuth (degrees)	Quasi pk or AVG (dBuV)		Distance Factor (dB)	Cable Factor (dB)	Ant. Factor (dB)	Corrected Reading (dBuV)	Limits (dBuV)	Diff (dB) +=FAIL	Comments
5180.00	72.00	100	225			9.54	2.98	34.62	100.06			<b>Ch. 36</b>
5180.00				57.67	A	9.54	2.98	34.62	85.73			
5240.00	75.00	100	135			9.54	3.00	34.73	103.19			<b>Ch. 48</b>
5240.00				60.33	A	9.54	3.00	34.73	88.52			
5260.00	72.67	100	225			9.54	3.00	34.77	100.90			<b>Ch. 52</b>
5260.00				59.17	A	9.54	3.00	34.77	87.40			
5320.00	71.00	100	225			9.54	3.02	34.88	99.36			<b>Ch. 64</b>
5320.00				57.17	A	9.54	3.02	34.88	85.53			

<b>RADIATED EMISSIONS - Vertical Antenna Polarization</b>												
Freq. (MHz)	Meter Reading (dBuV)	Antenna Height (cm)	Azimuth (degrees)	Quasi pk or AVG (dBuV)		Distance Factor (dB)	Cable Factor (dB)	Ant. Factor (dB)	Corrected Reading (dBuV)	Limits (dBuV)	Diff (dB) +=FAIL	Comments
5180.00	74.83	125	135			9.54	2.98	34.39	102.66			<b>Ch. 36</b>
5180.00				60.50	A	9.54	2.98	34.39	88.33			
5240.00	79.67	150	135			9.54	3.00	34.48	107.61			<b>Ch. 48</b>
5240.00				64.17	A	9.54	3.00	34.48	92.11			
5260.00	79.83	150	135			9.54	3.00	34.52	107.81			<b>Ch. 52</b>
5260.00				64.17	A	9.54	3.00	34.52	92.15			
5320.00	77.00	150	135			9.54	3.02	34.61	105.09			<b>Ch. 64</b>
5320.00				62.50	A	9.54	3.02	34.61	90.59			

NOTE: Fundamental signals measured at 1 meter and extrapolated to 3 meters to calculate the radiated band edge field strengths.



Radiated Emissions Test Results (Continued)

*Band Edge Field Strength Measurements in 802.11n mode 20MHz Wide (5150-5350 MHz)  
 Channels 36 & 64  
 Continuous TX at Chain A Antenna port with Ethertronics Antennas  
 Aegis Labs, Inc. File #: INTEL-060907-52*

RADIATED EMISSIONS - Horizontal Antenna Polarization												
Freq. (MHz)	Meter Reading (dBuV)	Antenna Height (cm)	Azimuth (degrees)	Quasi pk or AVG (dBuV)		Distance Factor (dB)	Cable Factor (dB)	Ant. Factor (dB)	Corrected Reading (dBuV)	Limits (dBuV)	Diff (dB) +=FAIL	Comments
5150.00	34.00	100	225			9.54	2.97	34.57	62.00	74.00	-12.00	<b>Ch. 36</b>
5150.00				20.50	A	9.54	2.97	34.57	48.50	54.00	-5.50	
5350.00	32.50	100	225			9.54	3.03	34.93	60.92	74.00	-13.08	<b>Ch. 64</b>
5350.00				20.17	A	9.54	3.03	34.93	48.59	54.00	-5.41	

RADIATED EMISSIONS - Vertical Antenna Polarization												
Freq. (MHz)	Meter Reading (dBuV)	Antenna Height (cm)	Azimuth (degrees)	Quasi pk or AVG (dBuV)		Distance Factor (dB)	Cable Factor (dB)	Ant. Factor (dB)	Corrected Reading (dBuV)	Limits (dBuV)	Diff (dB) +=FAIL	Comments
5150.00	36.83	125	135			9.54	2.97	34.34	64.60	74.00	-9.40	<b>Ch. 36</b>
5150.00				21.17	A	9.54	2.97	34.34	48.94	54.00	-5.06	
5350.00	38.50	150	135			9.54	3.03	34.66	66.65	74.00	-7.35	<b>Ch. 64</b>
5350.00				22.67	A	9.54	3.03	34.66	50.82	54.00	-3.18	

NOTE: The “Band Edge Field Strength” was calculated using the “Radiated Fundamental” measurements.

















Radiated Emissions Test Results (Continued)

*Spurious Emissions Measurements in 802.11n mode 20MHz Wide (5150-5350 MHz)*  
*Channels 36, 52, & 64*  
**Continuous TX at Chain A Antenna port with Ethertronics Antennas**  
*Aegis Labs, Inc. File #: INTEL-060907-44*

<b>RADIATED EMISSIONS - Horizontal Antenna Polarization</b>												
Freq. (MHz)	Meter Reading (dBuV)	Antenna Height (cm)	Azimuth (degrees)	Quasi pk or AVG (dBuV)		Preamp Factor (dB)	Cable Factor (dB)	Ant. Factor (dB)	Corrected Reading (dBuV)	Limits (dBuV)	Diff (dB) +=FAIL	Comments
3453.42	58.83	100	225			50.78	3.84	32.29	44.18	68.00	-23.82	<b>Ch. 36</b>
6906.66	63.83	100	135			50.50	5.49	35.91	54.72	68.00	-13.28	
10359.58	64.33	100	135			50.39	6.86	38.62	59.42	74.00	-14.58	
10359.58				50.50	A	50.39	6.86	38.62	45.59	54.00	-8.41	
3506.27	56.00	100	180			50.76	3.87	32.41	41.53	68.00	-26.47	<b>Ch. 52</b>
7013.30	60.67	100	180			50.42	5.54	36.03	51.82	74.00	-22.18	
7013.30				55.15	A	50.42	5.54	36.03	46.30	54.00	-7.70	
10519.88	62.83	100	180			50.43	6.93	38.71	58.03	68.00	-9.97	
3546.76	56.50	100	135			50.76	3.90	32.50	42.14	68.00	-25.86	<b>Ch.64</b>
7093.36	59.50	100	225			50.38	5.57	36.24	50.93	68.00	-17.07	
10640.00	61.00	100	180			50.44	6.96	38.76	56.28	74.00	-17.72	
10640.00				48.20	A	50.44	6.96	38.76	43.48	54.00	-10.52	

<b>RADIATED EMISSIONS - Vertical Antenna Polarization</b>												
Freq. (MHz)	Meter Reading (dBuV)	Antenna Height (cm)	Azimuth (degrees)	Quasi pk or AVG (dBuV)		Preamp Factor (dB)	Cable Factor (dB)	Ant. Factor (dB)	Corrected Reading (dBuV)	Limits (dBuV)	Diff (dB) +=FAIL	Comments
3453.31	60.67	150	135			50.78	3.84	31.80	45.53	68.00	-22.47	<b>Ch. 36</b>
6906.66	63.83	100	225			50.50	5.49	35.83	54.64	68.00	-13.36	
10360.00	64.33	100	225			50.39	6.86	38.59	59.39	74.00	-14.61	
10360.00				50.10	A	50.39	6.86	38.59	45.16	54.00	-8.84	
3506.66	58.83	100	135			50.76	3.87	31.92	43.86	68.00	-24.14	<b>Ch. 52</b>
7013.34	63.67	100	225			50.42	5.54	35.93	54.72	74.00	-19.28	
7013.34				59.93	A	50.42	5.54	35.93	50.98	54.00	-3.02	
10519.88	67.33	150	180			50.43	6.93	38.70	62.53	68.00	-5.47	
3546.63	58.50	100	135			50.76	3.90	32.02	43.65	68.00	-24.35	<b>Ch.64</b>
7093.35	62.33	100	225			50.38	5.57	36.14	53.66	68.00	-14.34	
10640.16	69.17	150	225			50.44	6.96	38.73	64.42	74.00	-9.58	
10640.16				54.52	A	50.44	6.96	38.73	49.77	54.00	-4.23	



Radiated Emissions Test Results (Continued)

*Fundamental Measurements in 802.11n mode 20MHz Wide (5150-5350 MHz)  
Channels 36, 48, 52, & 64  
Continuous TX at Chain B Antenna port with Ethertronics Antennas  
Aegis Labs, Inc. File #: INTEL-060907-53*

<b>RADIATED EMISSIONS - Horizontal Antenna Polarization</b>												
<i>Freq. (MHz)</i>	<i>Meter Reading (dBuV)</i>	<i>Antenna Height (cm)</i>	<i>Azimuth (degrees)</i>	<i>Quasi pk or AVG (dBuV)</i>		<i>Distance Factor (dB)</i>	<i>Cable Factor (dB)</i>	<i>Ant. Factor (dB)</i>	<i>Corrected Reading (dBuV)</i>	<i>Limits (dBuV)</i>	<i>Diff (dB) +=FAIL</i>	<i>Comments</i>
5180.00	70.50	100	135			9.54	4.73	34.62	100.32			<b>Ch. 36</b>
5180.00				56.50	A	9.54	4.73	34.62	86.32			
5240.00	74.50	100	135			9.54	4.76	34.73	104.45			<b>Ch. 48</b>
5240.00				59.33	A	9.54	4.76	34.73	89.28			
5260.00	74.00	100	135			9.54	4.77	34.77	104.00			<b>Ch. 52</b>
5260.00				60.00	A	9.54	4.77	34.77	90.00			
5320.00	70.33	100	135			9.54	4.80	34.88	100.46			<b>Ch. 64</b>
5320.00				56.33	A	9.54	4.80	34.88	86.46			

<b>RADIATED EMISSIONS - Vertical Antenna Polarization</b>												
<i>Freq. (MHz)</i>	<i>Meter Reading (dBuV)</i>	<i>Antenna Height (cm)</i>	<i>Azimuth (degrees)</i>	<i>Quasi pk or AVG (dBuV)</i>		<i>Distance Factor (dB)</i>	<i>Cable Factor (dB)</i>	<i>Ant. Factor (dB)</i>	<i>Corrected Reading (dBuV)</i>	<i>Limits (dBuV)</i>	<i>Diff (dB) +=FAIL</i>	<i>Comments</i>
5180.00	71.00	100	225			9.54	4.73	34.39	100.58			<b>Ch. 36</b>
5180.00				57.33	A	9.54	4.73	34.39	86.91			
5240.00	77.00	100	180			9.54	4.76	34.48	106.70			<b>Ch. 48</b>
5240.00				62.83	A	9.54	4.76	34.48	92.53			
5260.00	77.33	100	180			9.54	4.77	34.52	107.08			<b>Ch. 52</b>
5260.00				63.50	A	9.54	4.77	34.52	93.25			
5320.00	74.67	100	180			9.54	4.80	34.61	104.54			<b>Ch. 64</b>
5320.00				60.50	A	9.54	4.80	34.61	90.37			

NOTE: Fundamental signals measured at 1 meter and extrapolated to 3 meters to calculate the radiated band edge field strengths.





Radiated Emissions Test Results (Continued)

*Band Edge Field Strength Measurements in 802.11n mode 20MHz Wide (5150-5350 MHz)  
 Channels 36 & 64  
 Continuous TX at Chain B Antenna port with Ethertronics Antennas  
 Aegis Labs, Inc. File #: INTEL-060907-53*

**RADIATED EMISSIONS - Horizontal Antenna Polarization**

Freq. (MHz)	Meter Reading (dBuV)	Antenna Height (cm)	Azimuth (degrees)	Quasi pk or AVG (dBuV)		Distance Factor (dB)	Cable Factor (dB)	Ant. Factor (dB)	Corrected Reading (dBuV)	Limits (dBuV)	Diff (dB) +=FAIL	Comments
5150.00	32.17	100	135			9.54	4.72	34.57	61.92	74.00	-12.08	<b>Ch. 36</b>
5150.00				20.00	A	9.54	4.72	34.57	49.75	54.00	-4.25	
5350.00	33.50	100	135			9.54	4.81	34.93	63.70	74.00	-10.30	<b>Ch. 64</b>
5350.00				19.67	A	9.54	4.81	34.93	49.87	54.00	-4.13	

**RADIATED EMISSIONS - Vertical Antenna Polarization**

Freq. (MHz)	Meter Reading (dBuV)	Antenna Height (cm)	Azimuth (degrees)	Quasi pk or AVG (dBuV)		Distance Factor (dB)	Cable Factor (dB)	Ant. Factor (dB)	Corrected Reading (dBuV)	Limits (dBuV)	Diff (dB) +=FAIL	Comments
5150.00	32.50	100	225			9.54	4.72	34.34	62.02	74.00	-11.98	<b>Ch. 36</b>
5150.00				19.67	A	9.54	4.72	34.34	49.19	54.00	-4.81	
5350.00	38.17	100	180			9.54	4.81	34.66	68.10	74.00	-5.90	<b>Ch. 64</b>
5350.00				21.00	A	9.54	4.81	34.66	50.93	54.00	-3.07	

NOTE: The “Band Edge Field Strength” was calculated using the “Radiated Fundamental” measurements.















Radiated Emissions Test Results (Continued)

*Spurious Emissions Measurements in 802.11n mode 20MHz Wide (5150-5350 MHz)  
Channels 36, 52, & 64  
Continuous TX at Chain B Antenna port with Ethertronics Antennas  
Aegis Labs, Inc. File #: INTEL-060907-43*

<b>RADIATED EMISSIONS - Horizontal Antenna Polarization</b>												
Freq. (MHz)	Meter Reading (dBuV)	Antenna Height (cm)	Azimuth (degrees)	Quasi pk or AVG (dBuV)		Preamp Factor (dB)	Cable Factor (dB)	Ant. Factor (dB)	Corrected Reading (dBuV)	Limits (dBuV)	Diff (dB) +=FAIL	Comments
3453.42	61.67	100	225			50.78	3.84	32.29	47.02	68.00	-20.98	<b>Ch. 36</b>
6906.66	64.50	100	135			50.50	5.49	35.91	55.39	68.00	-12.61	
10359.58	66.33	100	135			50.39	6.86	38.62	61.42	74.00	-12.58	
10359.58				52.01	A	50.39	6.86	38.62	47.10	54.00	-6.90	
3506.27	61.00	100	225			50.76	3.87	32.41	46.53	68.00	-21.47	<b>Ch. 52</b>
7013.30	62.50	150	135			50.42	5.54	36.03	53.65	74.00	-20.35	
7013.30				57.92	A	50.42	5.54	36.03	49.07	54.00	-4.93	
10519.88	65.33	100	225			50.43	6.93	38.71	60.53	68.00	-7.47	
3546.76	60.17	100	225			50.76	3.90	32.50	45.81	68.00	-22.19	<b>Ch.64</b>
7093.36	58.67	100	225			50.38	5.57	36.24	50.10	68.00	-17.90	
10640.00	66.00	125	225			50.44	6.96	38.76	61.28	74.00	-12.72	
10640.00				51.75	A	50.44	6.96	38.76	47.03	54.00	-6.97	

<b>RADIATED EMISSIONS - Vertical Antenna Polarization</b>												
Freq. (MHz)	Meter Reading (dBuV)	Antenna Height (cm)	Azimuth (degrees)	Quasi pk or AVG (dBuV)		Preamp Factor (dB)	Cable Factor (dB)	Ant. Factor (dB)	Corrected Reading (dBuV)	Limits (dBuV)	Diff (dB) +=FAIL	Comments
3453.31	60.67	150	225			50.78	3.84	31.80	45.53	68.00	-22.47	<b>Ch. 36</b>
6906.66	63.67	150	225			50.50	5.49	35.83	54.48	68.00	-13.52	
10360.00	70.33	100	225			50.39	6.86	38.59	65.39	74.00	-8.61	
10360.00				56.02	A	50.39	6.86	38.59	51.08	54.00	-2.92	
3506.66	62.17	100	135			50.76	3.87	31.92	47.20	68.00	-20.80	<b>Ch. 52</b>
7013.34	63.17	150	225			50.42	5.54	35.93	54.22	74.00	-19.78	
7013.34				58.71	A	50.42	5.54	35.93	49.76	54.00	-4.24	
10519.88	67.33	100	225			50.43	6.93	38.70	62.53	68.00	-5.47	
3546.63	60.83	100	225			50.76	3.90	32.02	45.98	68.00	-22.02	<b>Ch.64</b>
7093.35	58.33	100	225			50.38	5.57	36.14	49.66	68.00	-18.34	
10640.16	65.33	100	225			50.44	6.96	38.73	60.58	74.00	-13.42	
10640.16				51.28	A	50.44	6.96	38.73	46.53	54.00	-7.47	





Radiated Emissions Test Results (Continued)

*Fundamental Measurements in 802.11n mode 20MHz Wide (5150-5350 MHz)  
Channels 36, 52, & 64  
Continuous TX at Dual Chain AB Antenna port with Ethertronics Antennas  
Aegis Labs, Inc. File #: INTEL-060907-54*

<b>RADIATED EMISSIONS - Horizontal Antenna Polarization</b>												
Freq. (MHz)	Meter Reading (dBuV)	Antenna Height (cm)	Azimuth (degrees)	Quasi pk or AVG (dBuV)		Distance Factor (dB)	Cable Factor (dB)	Ant. Factor (dB)	Corrected Reading (dBuV)	Limits (dBuV)	Diff (dB) +=FAIL	Comments
5180.00	72.00	100	225			9.54	2.98	34.62	100.06			<b>Ch. 36</b>
5180.00				54.50	A	9.54	2.98	34.62	82.56			
5260.00	73.17	100	225			9.54	3.00	34.77	101.40			<b>Ch. 52</b>
5260.00				55.33	A	9.54	3.00	34.77	83.56			
5320.00	74.33	100	225			9.54	3.02	34.88	102.69			<b>Ch. 64</b>
5320.00				55.50	A	9.54	3.02	34.88	83.86			

<b>RADIATED EMISSIONS - Vertical Antenna Polarization</b>												
Freq. (MHz)	Meter Reading (dBuV)	Antenna Height (cm)	Azimuth (degrees)	Quasi pk or AVG (dBuV)		Distance Factor (dB)	Cable Factor (dB)	Ant. Factor (dB)	Corrected Reading (dBuV)	Limits (dBuV)	Diff (dB) +=FAIL	Comments
5180.00	72.50	125	225			9.54	2.98	34.39	100.33			<b>Ch. 36</b>
5180.00				55.50	A	9.54	2.98	34.39	83.33			
5260.00	71.17	125	225			9.54	3.00	34.52	99.15			<b>Ch. 52</b>
5260.00				55.17	A	9.54	3.00	34.52	83.15			
5320.00	77.83	100	225			9.54	3.02	34.61	105.92			<b>Ch. 64</b>
5320.00				57.67	A	9.54	3.02	34.61	85.76			

NOTE: Fundamental signals measured at 1 meter and extrapolated to 3 meters to calculate the radiated band edge field strengths.



Radiated Emissions Test Results (Continued)

*Band Edge Field Strength Measurements in 802.11n mode 20MHz Wide (5150-5350 MHz)  
 Channels 36 & 64  
 Continuous TX at Dual Chain AB Antenna port with Ethertronics Antennas  
 Aegis Labs, Inc. File #: INTEL-060907-54*

<b>RADIATED EMISSIONS - Horizontal Antenna Polarization</b>												
Freq. (MHz)	Meter Reading (dBuV)	Antenna Height (cm)	Azimuth (degrees)	Quasi pk or AVG (dBuV)		Distance Factor (dB)	Cable Factor (dB)	Ant. Factor (dB)	Corrected Reading (dBuV)	Limits (dBuV)	Diff (dB) +=FAIL	Comments
5150.00	30.67	100	225			9.54	2.97	34.57	58.67	74.00	-15.33	<b>Ch. 36</b>
5150.00				19.17	A	9.54	2.97	34.57	47.17	54.00	-6.83	
5350.00	31.50	100	225			9.54	3.03	34.93	59.92	74.00	-14.08	<b>Ch. 64</b>
5350.00				19.67	A	9.54	3.03	34.93	48.09	54.00	-5.91	

<b>RADIATED EMISSIONS - Vertical Antenna Polarization</b>												
Freq. (MHz)	Meter Reading (dBuV)	Antenna Height (cm)	Azimuth (degrees)	Quasi pk or AVG (dBuV)		Distance Factor (dB)	Cable Factor (dB)	Ant. Factor (dB)	Corrected Reading (dBuV)	Limits (dBuV)	Diff (dB) +=FAIL	Comments
5150.00	31.00	125	225			9.54	2.97	34.34	58.77	74.00	-15.23	<b>Ch. 36</b>
5150.00				19.83	A	9.54	2.97	34.34	47.60	54.00	-6.40	
5350.00	35.83	100	225			9.54	3.03	34.66	63.98	74.00	-10.02	<b>Ch. 64</b>
5350.00				21.17	A	9.54	3.03	34.66	49.32	54.00	-4.68	

NOTE: The “Band Edge Field Strength” was calculated using the “Radiated Fundamental” measurements.

















Radiated Emissions Test Results (Continued)

*Spurious Emissions Measurements in 802.11n mode 20MHz Wide (5150-5350 MHz)  
Channels 36, 52, & 64  
Continuous TX at Dual Chain AB Antenna port with Ethertronics Antennas  
Aegis Labs, Inc. File #: INTEL-060907-55*

**RADIATED EMISSIONS - Horizontal Antenna Polarization**

Freq. (MHz)	Meter Reading (dBuV)	Antenna Height (cm)	Azimuth (degrees)	Quasi pk or AVG (dBuV)		Preamp Factor (dB)	Cable Factor (dB)	Ant. Factor (dB)	Corrected Reading (dBuV)	Limits (dBuV)	Diff (dB) +=FAIL	Comments
3453.42	59.17	100	225			50.78	3.84	32.29	44.52	68.00	-23.48	<b>Ch. 36</b>
6906.66	61.33	100	225			50.50	5.49	35.91	52.22	68.00	-15.78	
10359.58	61.00	100	135			50.39	6.86	38.62	56.09	68.00	-11.91	
3506.27	59.17	100	225			50.76	3.87	32.41	44.70	68.00	-23.30	<b>Ch. 52</b>
7013.30	60.50	100	180			50.42	5.54	36.03	51.65	68.00	-16.35	
10519.88	62.00	100	225			50.43	6.93	38.71	57.20	68.00	-10.80	
3546.76	58.00	100	225			50.76	3.90	32.50	43.64	68.00	-24.36	<b>Ch.64</b>
7093.36	57.83	100	180			50.38	5.57	36.24	49.26	68.00	-18.74	
10640.00	61.00	100	180			50.44	6.96	38.76	56.28	74.00	-17.72	
10640.00				48.09	A	50.44	6.96	38.76	43.37	54.00	-10.63	

**RADIATED EMISSIONS - Vertical Antenna Polarization**

Freq. (MHz)	Meter Reading (dBuV)	Antenna Height (cm)	Azimuth (degrees)	Quasi pk or AVG (dBuV)		Preamp Factor (dB)	Cable Factor (dB)	Ant. Factor (dB)	Corrected Reading (dBuV)	Limits (dBuV)	Diff (dB) +=FAIL	Comments
3453.31	61.33	100	135			50.78	3.84	31.80	46.19	68.00	-21.81	<b>Ch. 36</b>
6906.66	64.17	100	270			50.50	5.49	35.83	54.98	68.00	-13.02	
10360.00	66.17	100	315			50.39	6.86	38.59	61.23	68.00	-6.77	
3506.66	61.33	125	135			50.76	3.87	31.92	46.36	68.00	-21.64	<b>Ch. 52</b>
7013.34	63.67	100	315			50.42	5.54	35.93	54.72	68.00	-13.28	
10519.88	64.50	100	315			50.43	6.93	38.70	59.70	68.00	-8.30	
3546.63	61.50	100	135			50.76	3.90	32.02	46.65	68.00	-21.35	<b>Ch.64</b>
7093.35	62.50	100	315			50.38	5.57	36.14	53.83	68.00	-14.17	
10640.16	68.17	100	315			50.44	6.96	38.73	63.42	74.00	-10.58	
10640.16				53.54	A	50.44	6.96	38.73	48.79	54.00	-5.21	



## RADIATED EMISSIONS TEST RESULTS

<b>CLIENT:</b>	Intel Corporation	<b>DATE:</b>	10/06/06
<b>EUT:</b>	Intel PRO/Wireless 4965AGN Network Connection	<b>PROJECT NUMBER:</b>	INTEL-060907
<b>MODEL NUMBER:</b>	4965AGN	<b>TEST ENGINEER:</b>	BM/JC
<b>SERIAL NUMBER:</b>	0013E804612B	<b>SITE #:</b>	2
<b>CONFIGURATION:</b>	Tested installed in the host computer's mini PCI slot in <b>802.11n (5150-5350 MHz) mode 40MHz Wide with Ethertronics Antennas.</b>	<b>TEMPERATURE:</b>	16 deg. C
		<b>HUMIDITY:</b>	60% RH
		<b>TIME:</b>	4:30 PM

<b>Description:</b>	Radiated RF Emissions (1 GHz – 18 GHz)
<b>Results:</b>	<b>PASSED</b> Horizontal and Vertical Antenna Polarizations Class B Limits
<b>Note:</b>	Radiated Emissions Measurements were performed on the EUT with power supply set at the following voltage and frequency. <ul style="list-style-type: none"> <li>• 120VAC / 60 Hz.</li> </ul>

Unwanted Spurious Emissions Limits			
Frequency (MHz)	Field Strength (uV/m)	Field Strength (dBuV/m) (Emissions in the restricted bands)	Field Strength (dBm/MHz) (Emissions outside the restricted bands)
Above 960	500	54.00 (Average) 74.00 (Peak)	< -20 dBc

### Radiated Emissions Sample Calculations

$$\text{Corrected Meter Reading} = \text{Meter Reading} + F + C - D$$

Where, F = Antenna Factor

C = Cable Factor

G = Amplifier Gain

D = Distance Factor (if applicable)

Therefore, the equation for determining the Corrected Meter Reading Limit (CML) is:

$$\text{CML} = \text{Specification Limit} - F - C + D$$





Radiated Emissions Test Results (Continued)

*Fundamental Measurements in 802.11n mode 40MHz Wide (5150-5350 MHz)  
 Channels 38, 54, & 62  
 Continuous TX at Chain A Antenna port with Ethertronics Antennas  
 Aegis Labs, Inc. File #: INTEL-060907-52*

<b>RADIATED EMISSIONS - Horizontal Antenna Polarization</b>												
Freq. (MHz)	Meter Reading (dBuV)	Antenna Height (cm)	Azimuth (degrees)	Quasi pk or AVG (dBuV)		Distance Factor (dB)	Cable Factor (dB)	Ant. Factor (dB)	Corrected Reading (dBuV)	Limits (dBuV)	Diff (dB) +=FAIL	Comments
5190.00	68.00	100	135			9.54	2.98	34.64	96.08			<b>Ch. 38</b>
5190.00				53.33	A	9.54	2.98	34.64	81.41			
5270.00	69.67	100	225			9.54	3.01	34.79	97.92			<b>Ch. 54</b>
5270.00				54.83	A	9.54	3.01	34.79	83.08			
5310.00	67.00	100	225			9.54	3.02	34.86	95.34			<b>Ch. 62</b>
5310.00				52.33	A	9.54	3.02	34.86	80.67			

<b>RADIATED EMISSIONS - Vertical Antenna Polarization</b>												
Freq. (MHz)	Meter Reading (dBuV)	Antenna Height (cm)	Azimuth (degrees)	Quasi pk or AVG (dBuV)		Distance Factor (dB)	Cable Factor (dB)	Ant. Factor (dB)	Corrected Reading (dBuV)	Limits (dBuV)	Diff (dB) +=FAIL	Comments
5190.00	72.00	150	135			9.54	2.98	34.40	99.85			<b>Ch. 38</b>
5190.00				57.17	A	9.54	2.98	34.40	85.02			
5270.00	76.83	150	135			9.54	3.01	34.53	104.83			<b>Ch. 54</b>
5270.00				60.00	A	9.54	3.01	34.53	88.00			
5310.00	72.67	150	135			9.54	3.02	34.60	100.74			<b>Ch. 62</b>
5310.00				57.00	A	9.54	3.02	34.60	85.07			

NOTE: Fundamental signals measured at 1 meter and extrapolated to 3 meters to calculate the radiated band edge field strengths.



Radiated Emissions Test Results (Continued)

*Band Edge Field Strength Measurements in 802.11n mode 40MHz Wide (5150-5350 MHz)  
 Channels 38 & 62  
 Continuous TX at Chain A Antenna port with Ethertronics Antennas  
 Aegis Labs, Inc. File #: INTEL-060907-52*

<b>RADIATED EMISSIONS - Horizontal Antenna Polarization</b>												
Freq. (MHz)	Meter Reading (dBuV)	Antenna Height (cm)	Azimuth (degrees)	Quasi pk or AVG (dBuV)		Distance Factor (dB)	Cable Factor (dB)	Ant. Factor (dB)	Corrected Reading (dBuV)	Limits (dBuV)	Diff (dB) +=FAIL	Comments
5150.00	34.33	100	135			9.54	2.97	34.57	62.33	74.00	-11.67	<b>Ch. 38</b>
5150.00				21.33	A	9.54	2.97	34.57	49.33	54.00	-4.67	
5350.00	33.50	100	225			9.54	3.03	34.93	61.92	74.00	-12.08	<b>Ch. 62</b>
5350.00				20.00	A	9.54	3.03	34.93	48.42	54.00	-5.58	

<b>RADIATED EMISSIONS - Vertical Antenna Polarization</b>												
Freq. (MHz)	Meter Reading (dBuV)	Antenna Height (cm)	Azimuth (degrees)	Quasi pk or AVG (dBuV)		Distance Factor (dB)	Cable Factor (dB)	Ant. Factor (dB)	Corrected Reading (dBuV)	Limits (dBuV)	Diff (dB) +=FAIL	Comments
5150.00	35.67	150	135			9.54	2.97	34.34	63.44	74.00	-10.56	<b>Ch. 38</b>
5150.00				22.67	A	9.54	2.97	34.34	50.44	54.00	-3.56	
5350.00	38.67	150	135			9.54	3.03	34.66	66.82	74.00	-7.18	<b>Ch. 62</b>
5350.00				22.83	A	9.54	3.03	34.66	50.98	54.00	-3.02	

NOTE: The “Band Edge Field Strength” was calculated using the “Radiated Fundamental” measurements.

















Radiated Emissions Test Results (Continued)

*Spurious Emissions Measurements in 802.11n mode 40MHz Wide (5150-5350 MHz)  
Channels 38, 54, & 62  
Continuous TX at Chain A Antenna port with Ethertronics Antennas  
Aegis Labs, Inc. File #: INTEL-060907-44*

<b>RADIATED EMISSIONS - Horizontal Antenna Polarization</b>												
Freq. (MHz)	Meter Reading (dBuV)	Antenna Height (cm)	Azimuth (degrees)	Quasi pk or AVG (dBuV)		Preamp Factor (dB)	Cable Factor (dB)	Ant. Factor (dB)	Corrected Reading (dBuV)	Limits (dBuV)	Diff (dB) +=FAIL	Comments
3460.00	58.33	100	225			50.78	3.85	32.30	43.70	68.00	-24.30	<b>Ch. 38</b>
6920.13	61.33	100	180			50.49	5.49	35.92	52.25	68.00	-15.75	
10379.39	61.67	100	135			50.39	6.87	38.63	56.77	74.00	-17.23	
10379.39				48.17	A	50.39	6.87	38.63	43.27	54.00	-10.73	
3513.33	56.67	100	225			50.76	3.88	32.43	42.22	68.00	-25.78	<b>Ch. 54</b>
7026.76	60.67	100	225			50.42	5.54	36.07	51.86	68.00	-16.14	
10540.22	61.17	100	225			50.43	6.93	38.72	56.39	74.00	-17.61	
10540.22				46.97	A	50.43	6.93	38.72	42.19	54.00	-11.81	
3539.88	55.83	150	225			50.76	3.89	32.49	41.45	68.00	-26.55	<b>Ch.62</b>
7080.03	60.00	100	225			50.39	5.57	36.21	51.38	68.00	-16.62	
10620.47	63.00	100	180			50.43	6.95	38.75	58.27	74.00	-15.73	
10620.47				48.86	A	50.43	6.95	38.75	44.13	54.00	-9.87	

<b>RADIATED EMISSIONS - Vertical Antenna Polarization</b>												
Freq. (MHz)	Meter Reading (dBuV)	Antenna Height (cm)	Azimuth (degrees)	Quasi pk or AVG (dBuV)		Preamp Factor (dB)	Cable Factor (dB)	Ant. Factor (dB)	Corrected Reading (dBuV)	Limits (dBuV)	Diff (dB) +=FAIL	Comments
3460.00	61.33	100	135			50.78	3.85	31.81	46.21	68.00	-21.79	<b>Ch. 38</b>
6920.13	63.50	100	225			50.49	5.49	35.84	54.34	68.00	-13.66	
10379.60	63.17	100	225			50.39	6.87	38.60	58.25	74.00	-15.75	
10379.60				49.70	A	50.39	6.87	38.60	44.78	54.00	-9.22	
3513.33	59.17	100	180			50.76	3.88	31.93	44.22	68.00	-23.78	<b>Ch. 54</b>
7026.76	63.33	100	225			50.42	5.54	35.97	54.42	68.00	-13.58	
10540.22	65.33	125	225			50.43	6.93	38.71	60.54	74.00	-13.46	
10540.22				51.15	A	50.43	6.93	38.71	46.36	54.00	-7.64	
3540.11	58.33	100	180			50.76	3.89	32.00	43.46	68.00	-24.54	<b>Ch.62</b>
7080.01	62.50	100	225			50.39	5.57	36.11	53.78	68.00	-14.22	
10620.41	67.33	150	180			50.43	6.95	38.72	62.57	74.00	-11.43	
10620.41				51.96	A	50.43	6.95	38.72	47.20	54.00	-6.80	

## Radiated Emissions Test Results (Continued)

*Spurious Emissions Measurements in 802.11n mode 40MHz Wide (5150-5350 MHz)*  
*Channels 38, 54, & 62*  
*Continuous RX at Chain A Antenna port with Ethertronics Antennas*  
*Aegis Labs, Inc. File #: INTEL-060907-44*

**RADIATED EMISSIONS - Horizontal Antenna Polarization**

Freq. (MHz)	Meter Reading (dBuV)	Antenna Height (cm)	Azimuth (degrees)	Quasi pk or AVG (dBuV)		Preamp Factor (dB)	Cable Factor (dB)	Ant. Factor (dB)	Corrected Reading (dBuV)	Limits (dBuV)	Diff (dB) +=FAIL	Comments
3460.19	59.67	125	225			50.78	3.85	32.30	45.04	74.00	-28.96	<b>Ch. 38</b>
3460.19				53.82	A	50.78	3.85	32.30	39.19	54.00	-14.81	
3513.32	58.33	100	225			50.76	3.88	32.43	43.88	74.00	-30.12	<b>Ch. 54</b>
3513.32				50.53	A	50.76	3.88	32.43	36.08	54.00	-17.92	
3540.21	57.67	100	225			50.76	3.89	32.49	43.29	74.00	-30.71	<b>Ch.62</b>
3540.21				49.67	A	50.76	3.89	32.49	35.29	54.00	-18.71	

**RADIATED EMISSIONS - Vertical Antenna Polarization**

Freq. (MHz)	Meter Reading (dBuV)	Antenna Height (cm)	Azimuth (degrees)	Quasi pk or AVG (dBuV)		Preamp Factor (dB)	Cable Factor (dB)	Ant. Factor (dB)	Corrected Reading (dBuV)	Limits (dBuV)	Diff (dB) +=FAIL	Comments
3460.02	58.50	100	225			50.78	3.85	31.81	43.38	74.00	-30.62	<b>Ch. 38</b>
3460.02				51.78	A	50.78	3.85	31.81	36.66	54.00	-17.34	
3513.16	58.67	100	225			50.76	3.88	31.93	43.72	74.00	-30.28	<b>Ch. 54</b>
3513.16				52.44	A	50.76	3.88	31.93	37.49	54.00	-16.51	
3540.02	59.00	125	225			50.76	3.89	32.00	44.13	74.00	-29.87	<b>Ch.62</b>
3540.02				52.56	A	50.76	3.89	32.00	37.69	54.00	-16.31	



Radiated Emissions Test Results (Continued)

*Fundamental Measurements in 802.11n mode 40MHz Wide (5150-5350 MHz)  
Channels 38, 54, & 62  
Continuous TX at Chain B Antenna port with Ethertronics Antennas  
Aegis Labs, Inc. File #: INTEL-060907-53*

<b>RADIATED EMISSIONS - Horizontal Antenna Polarization</b>												
Freq. (MHz)	Meter Reading (dBuV)	Antenna Height (cm)	Azimuth (degrees)	Quasi pk or AVG (dBuV)		Distance Factor (dB)	Cable Factor (dB)	Ant. Factor (dB)	Corrected Reading (dBuV)	Limits (dBuV)	Diff (dB) +=FAIL	Comments
5190.00	67.50	100	135			9.54	4.74	34.64	97.34			<b>Ch. 38</b>
5190.00				50.83	A	9.54	4.74	34.64	80.67			
5270.00	67.50	100	135			9.54	4.77	34.79	97.52			<b>Ch. 54</b>
5270.00				51.17	A	9.54	4.77	34.79	81.19			
5310.00	67.33	100	135			9.54	4.79	34.86	97.44			<b>Ch. 62</b>
5310.00				50.33	A	9.54	4.79	34.86	80.44			

<b>RADIATED EMISSIONS - Vertical Antenna Polarization</b>												
Freq. (MHz)	Meter Reading (dBuV)	Antenna Height (cm)	Azimuth (degrees)	Quasi pk or AVG (dBuV)		Distance Factor (dB)	Cable Factor (dB)	Ant. Factor (dB)	Corrected Reading (dBuV)	Limits (dBuV)	Diff (dB) +=FAIL	Comments
5190.00	69.67	100	180			9.54	4.74	34.40	99.27			<b>Ch. 38</b>
5190.00				52.33	A	9.54	4.74	34.40	81.93			
5270.00	72.17	100	225			9.54	4.77	34.53	101.94			<b>Ch. 54</b>
5270.00				54.83	A	9.54	4.77	34.53	84.60			
5310.00	71.50	100	225			9.54	4.79	34.60	101.35			<b>Ch. 62</b>
5310.00				54.17	A	9.54	4.79	34.60	84.02			

NOTE: Fundamental signals measured at 1 meter and extrapolated to 3 meters to calculate the radiated band edge field strengths.

Radiated Emissions Test Results (Continued)

*Band Edge Field Strength Measurements in 802.11n mode 40MHz Wide (5150-5350 MHz)  
Channels 38 & 62  
Continuous TX at Chain B Antenna port with Ethertronics Antennas  
Aegis Labs, Inc. File #: INTEL-060907-53*

**RADIATED EMISSIONS - Horizontal Antenna Polarization**

Freq. (MHz)	Meter Reading (dBuV)	Antenna Height (cm)	Azimuth (degrees)	Quasi pk or AVG (dBuV)		Distance Factor (dB)	Cable Factor (dB)	Ant. Factor (dB)	Corrected Reading (dBuV)	Limits (dBuV)	Diff (dB) +=FAIL	Comments
5150.00	36.50	100	135			9.54	4.72	34.57	66.25	74.00	-7.75	<b>Ch. 38</b>
5150.00				23.00	A	9.54	4.72	34.57	52.75	54.00	-1.25	
5350.00	35.17	100	135			9.54	4.81	34.93	65.37	74.00	-8.63	<b>Ch. 62</b>
5350.00				20.83	A	9.54	4.81	34.93	51.03	54.00	-2.97	

**RADIATED EMISSIONS - Vertical Antenna Polarization**

Freq. (MHz)	Meter Reading (dBuV)	Antenna Height (cm)	Azimuth (degrees)	Quasi pk or AVG (dBuV)		Distance Factor (dB)	Cable Factor (dB)	Ant. Factor (dB)	Corrected Reading (dBuV)	Limits (dBuV)	Diff (dB) +=FAIL	Comments
5150.00	38.50	100	180			9.54	4.72	34.34	68.02	74.00	-5.98	<b>Ch. 38</b>
5150.00				23.50	A	9.54	4.72	34.34	53.02	54.00	-0.98	
5350.00	37.50	100	225			9.54	4.81	34.66	67.43	74.00	-6.57	<b>Ch. 62</b>
5350.00				22.83	A	9.54	4.81	34.66	52.76	54.00	-1.24	

NOTE: The “Band Edge Field Strength” was calculated using the “Radiated Fundamental” measurements.

















Radiated Emissions Test Results (Continued)

*Spurious Emissions Measurements in 802.11n mode 40MHz Wide (5150-5350 MHz)  
Channels 38, 54, & 62  
Continuous TX at Chain B Antenna port with Ethertronics Antennas  
Aegis Labs, Inc. File #: INTEL-060907-43*

RADIATED EMISSIONS - Horizontal Antenna Polarization												
Freq. (MHz)	Meter Reading (dBuV)	Antenna Height (cm)	Azimuth (degrees)	Quasi pk or AVG (dBuV)		Preamp Factor (dB)	Cable Factor (dB)	Ant. Factor (dB)	Corrected Reading (dBuV)	Limits (dBuV)	Diff (dB) +=FAIL	Comments
3460.11	60.83	150	225			50.78	3.85	32.30	46.20	68.00	-21.80	<b>Ch. 38</b>
6919.99	61.17	100	180			50.49	5.49	35.92	52.09	68.00	-15.91	
10379.36	60.83	100	180			50.39	6.87	38.63	55.93	74.00	-18.07	
10379.36				47.06	A	50.39	6.87	38.63	42.16	54.00	-11.84	
3513.33	59.83	100	225			50.76	3.88	32.43	45.38	68.00	-22.62	<b>Ch. 54</b>
10540.22	63.17	100	180			50.43	6.93	38.72	58.39	74.00	-15.61	
10540.22				49.15	A	50.43	6.93	38.72	44.37	54.00	-9.63	
3540.12	60.00	100	225			50.76	3.89	32.49	45.62	68.00	-22.38	<b>Ch.62</b>
7080.01	57.33	100	180			50.39	5.57	36.21	48.71	68.00	-19.29	
10620.32	62.67	100	225			50.43	6.95	38.75	57.94	74.00	-16.06	
10620.32				48.75	A	50.43	6.95	38.75	44.02	54.00	-9.98	

RADIATED EMISSIONS - Vertical Antenna Polarization												
Freq. (MHz)	Meter Reading (dBuV)	Antenna Height (cm)	Azimuth (degrees)	Quasi pk or AVG (dBuV)		Preamp Factor (dB)	Cable Factor (dB)	Ant. Factor (dB)	Corrected Reading (dBuV)	Limits (dBuV)	Diff (dB) +=FAIL	Comments
3460.03	59.83	125	135			50.78	3.85	31.81	44.71	68.00	-23.29	<b>Ch. 38</b>
6920.02	61.17	200	180			50.49	5.49	35.84	52.01	68.00	-15.99	
10379.79	68.50	100	225			50.39	6.87	38.60	63.58	74.00	-10.42	
10379.79				53.69	A	50.39	6.87	38.60	48.77	54.00	-5.23	
3513.33	61.33	100	135			50.76	3.88	31.93	46.38	68.00	-21.62	<b>Ch. 54</b>
10540.22	61.67	125	225			50.43	6.93	38.71	56.88	74.00	-17.12	
10540.22				48.13	A	50.43	6.93	38.71	43.34	54.00	-10.66	
3540.06	60.17	150	135			50.76	3.89	32.00	45.30	68.00	-22.70	<b>Ch.62</b>
7079.97	59.67	100	180			50.39	5.57	36.11	50.95	68.00	-17.05	
10620.42	69.50	100	225			50.43	6.95	38.72	64.74	74.00	-9.26	
10620.42				54.15	A	50.43	6.95	38.72	49.39	54.00	-4.61	



Radiated Emissions Test Results (Continued)

*Spurious Emissions Measurements in 802.11n mode 40MHz Wide (5150-5350 MHz)  
Channels 38, 54, & 62  
Continuous RX at Chain B Antenna port with Ethertronics Antennas  
Aegis Labs, Inc. File #: INTEL-060907-43*

**RADIATED EMISSIONS - Horizontal Antenna Polarization**

Freq. (MHz)	Meter Reading (dBuV)	Antenna Height (cm)	Azimuth (degrees)	Quasi pk or AVG (dBuV)		Preamp Factor (dB)	Cable Factor (dB)	Ant. Factor (dB)	Corrected Reading (dBuV)	Limits (dBuV)	Diff (dB) +=FAIL	Comments
3459.82	58.83	100	225			50.78	3.85	32.30	44.20	74.00	-29.80	<b>Ch. 38</b>
3459.82				50.89	A	50.78	3.85	32.30	36.26	54.00	-17.74	
3513.19	58.83	100	225			50.76	3.88	32.43	44.38	74.00	-29.62	<b>Ch. 54</b>
3513.19				50.65	A	50.76	3.88	32.43	36.20	54.00	-17.80	
3539.94	57.83	100	225			50.76	3.89	32.49	43.45	74.00	-30.55	<b>Ch.62</b>
3539.94				50.83	A	50.76	3.89	32.49	36.45	54.00	-17.55	

**RADIATED EMISSIONS - Vertical Antenna Polarization**

Freq. (MHz)	Meter Reading (dBuV)	Antenna Height (cm)	Azimuth (degrees)	Quasi pk or AVG (dBuV)		Preamp Factor (dB)	Cable Factor (dB)	Ant. Factor (dB)	Corrected Reading (dBuV)	Limits (dBuV)	Diff (dB) +=FAIL	Comments
3460.13	60.17	125	135			50.78	3.85	31.81	45.05	74.00	-28.95	<b>Ch. 38</b>
3460.13				51.04	A	50.78	3.85	31.81	35.92	54.00	-18.08	
3513.35	58.83	150	135			50.76	3.88	31.93	43.88	74.00	-30.12	<b>Ch. 54</b>
3513.35				49.97	A	50.76	3.88	31.93	35.02	54.00	-18.98	
3540.07	58.33	125	135			50.76	3.89	32.00	43.46	74.00	-30.54	<b>Ch.62</b>
3540.07				50.19	A	50.76	3.89	32.00	35.32	54.00	-18.68	





Radiated Emissions Test Results (Continued)

*Fundamental Measurements in 802.11n mode 40MHz Wide (5150-5350 MHz)  
Channels 38, 54, & 62  
Continuous TX at Dual Chain AB Antenna port with Ethertronics Antennas  
Aegis Labs, Inc. File #: INTEL-060907-54*

<b>RADIATED EMISSIONS - Horizontal Antenna Polarization</b>												
Freq. (MHz)	Meter Reading (dBuV)	Antenna Height (cm)	Azimuth (degrees)	Quasi pk or AVG (dBuV)		Distance Factor (dB)	Cable Factor (dB)	Ant. Factor (dB)	Corrected Reading (dBuV)	Limits (dBuV)	Diff (dB) +=FAIL	Comments
5190.00	73.00	125	225			9.54	2.98	34.64	101.08			<b>Ch. 38</b>
5190.00				50.50	A	9.54	2.98	34.64	78.58			
5270.00	71.83	100	225			9.54	3.01	34.79	100.08			<b>Ch. 54</b>
5270.00				50.17	A	9.54	3.01	34.79	78.42			
5310.00	72.67	100	225			9.54	3.02	34.86	101.01			<b>Ch. 62</b>
5310.00				49.17	A	9.54	3.02	34.86	77.51			

<b>RADIATED EMISSIONS - Vertical Antenna Polarization</b>												
Freq. (MHz)	Meter Reading (dBuV)	Antenna Height (cm)	Azimuth (degrees)	Quasi pk or AVG (dBuV)		Distance Factor (dB)	Cable Factor (dB)	Ant. Factor (dB)	Corrected Reading (dBuV)	Limits (dBuV)	Diff (dB) +=FAIL	Comments
5190.00	70.33	100	225			9.54	2.98	34.40	98.18			<b>Ch. 38</b>
5190.00				47.83	A	9.54	2.98	34.40	75.68			
5270.00	69.67	100	225			9.54	3.01	34.53	97.67			<b>Ch. 54</b>
5270.00				50.00	A	9.54	3.01	34.53	78.00			
5310.00	75.83	100	225			9.54	3.02	34.60	103.90			<b>Ch. 62</b>
5310.00				51.83	A	9.54	3.02	34.60	79.90			

NOTE: Fundamental signals measured at 1 meter and extrapolated to 3 meters to calculate the radiated band edge field strengths.



Radiated Emissions Test Results (Continued)

*Band Edge Field Strength Measurements in 802.11n mode 40MHz Wide (5150-5350 MHz)  
 Channels 38 & 62  
 Continuous TX at Dual Chain AB Antenna port with Ethertronics Antennas  
 Aegis Labs, Inc. File #: INTEL-060907-54*

<b>RADIATED EMISSIONS - Horizontal Antenna Polarization</b>												
Freq. (MHz)	Meter Reading (dBuV)	Antenna Height (cm)	Azimuth (degrees)	Quasi pk or AVG (dBuV)		Distance Factor (dB)	Cable Factor (dB)	Ant. Factor (dB)	Corrected Reading (dBuV)	Limits (dBuV)	Diff (dB) +=FAIL	Comments
5150.00	38.50	100	225			9.54	2.97	34.57	66.50	74.00	-7.50	<b>Ch. 38</b>
5150.00				23.33	A	9.54	2.97	34.57	51.33	54.00	-2.67	
5350.00	37.50	100	225			9.54	3.03	34.93	65.92	74.00	-8.08	<b>Ch. 62</b>
5350.00				21.50	A	9.54	3.03	34.93	49.92	54.00	-4.08	

<b>RADIATED EMISSIONS - Vertical Antenna Polarization</b>												
Freq. (MHz)	Meter Reading (dBuV)	Antenna Height (cm)	Azimuth (degrees)	Quasi pk or AVG (dBuV)		Distance Factor (dB)	Cable Factor (dB)	Ant. Factor (dB)	Corrected Reading (dBuV)	Limits (dBuV)	Diff (dB) +=FAIL	Comments
5150.00	36.33	100	225			9.54	2.97	34.34	64.10	74.00	-9.90	<b>Ch. 38</b>
5150.00				22.17	A	9.54	2.97	34.34	49.94	54.00	-4.06	
5350.00	44.67	100	225			9.54	3.03	34.66	72.82	74.00	-1.18	<b>Ch. 62</b>
5350.00				25.17	A	9.54	3.03	34.66	53.32	54.00	-0.68	

NOTE: The “Band Edge Field Strength” was calculated using the “Radiated Fundamental” measurements.

















Radiated Emissions Test Results (Continued)

*Spurious Emissions Measurements in 802.11n mode 40MHz Wide (5150-5350 MHz)  
Channels 38, 54, & 62  
Continuous TX at Dual Chain AB Antenna port with Ethertronics Antennas  
Aegis Labs, Inc. File #: INTEL-060907-55*

**RADIATED EMISSIONS - Horizontal Antenna Polarization**

Freq. (MHz)	Meter Reading (dBuV)	Antenna Height (cm)	Azimuth (degrees)	Quasi pk or AVG (dBuV)		Preamp Factor (dB)	Cable Factor (dB)	Ant. Factor (dB)	Corrected Reading (dBuV)	Limits (dBuV)	Diff (dB) +=FAIL	Comments
3460.00	61.17	100	225			50.78	3.85	32.30	46.54	68.00	-21.46	<b>Ch. 38</b>
6920.08	63.00	100	180			50.49	5.49	35.92	53.92	68.00	-14.08	
10379.89	61.33	100	225			50.39	6.87	38.63	56.43	68.00	-11.57	
3513.33	60.17	100	180			50.76	3.88	32.43	45.72	68.00	-22.28	<b>Ch. 54</b>
7026.76	60.17	100	180			50.42	5.54	36.07	51.36	68.00	-16.64	
10540.11	61.50	100	225			50.43	6.93	38.72	56.72	68.00	-11.28	
3539.98	60.17	100	180			50.76	3.89	32.49	45.79	68.00	-22.21	<b>Ch.62</b>
7089.97	58.17	100	180			50.39	5.57	36.23	49.59	68.00	-18.41	
10620.10	63.33	125	225			50.43	6.95	38.75	58.60	74.00	-15.40	
10620.10				49.06	A	50.43	6.95	38.75	44.33	54.00	-9.67	

**RADIATED EMISSIONS - Vertical Antenna Polarization**

Freq. (MHz)	Meter Reading (dBuV)	Antenna Height (cm)	Azimuth (degrees)	Quasi pk or AVG (dBuV)		Preamp Factor (dB)	Cable Factor (dB)	Ant. Factor (dB)	Corrected Reading (dBuV)	Limits (dBuV)	Diff (dB) +=FAIL	Comments
3460.00	62.50	100	135			50.78	3.85	31.81	47.38	68.00	-20.62	<b>Ch. 38</b>
6919.99	65.17	100	270			50.49	5.49	35.84	56.01	68.00	-11.99	
10380.02	65.83	100	315			50.39	6.87	38.60	60.91	68.00	-7.09	
3513.33	62.17	125	135			50.76	3.88	31.93	47.22	68.00	-20.78	<b>Ch. 54</b>
7026.76	64.67	100	315			50.42	5.54	35.97	55.76	68.00	-12.24	
10540.22	62.67	100	315			50.43	6.93	38.71	57.88	68.00	-10.12	
3540.00	59.50	100	180			50.76	3.89	32.00	44.63	68.00	-23.37	<b>Ch.62</b>
7080.01	61.83	100	315			50.39	5.57	36.11	53.11	68.00	-14.89	
10620.41	64.83	100	315			50.43	6.95	38.72	60.07	74.00	-13.93	
10620.41				50.19	A	50.43	6.95	38.72	45.43	54.00	-8.57	



## PEAK TRANSMIT POWER

<b>CLIENT:</b>	Intel Corporation	<b>DATE:</b>	09/29/06
<b>EUT:</b>	Intel PRO/Wireless 4965AGN Network Connection	<b>PROJECT NUMBER:</b>	INTEL-060907
<b>MODEL NUMBER:</b>	4965AGN	<b>TEST ENGINEER:</b>	BM/JC
<b>SERIAL NUMBER:</b>	0013E804612B	<b>SITE #:</b>	2
<b>CONFIGURATION:</b>	Tested installed in the host computer's mini PCI slot.	<b>TEMPERATURE:</b>	22 deg. C
		<b>HUMIDITY:</b>	36% RH
		<b>TIME:</b>	5:00 PM

<b>Description:</b>	<p>For the band 5.15-5.25 GHz, the peak transmit power over the frequency band of operation shall not exceed the lesser of 50 mW or <math>4 \text{ dBm} + 10\log B</math>, where B is the 26-dB emission bandwidth in MHz.</p> <p>For the band 5.25-5.35 GHz, the peak transmit power over the frequency band of operation shall not exceed the lesser of 250 mW or <math>11 \text{ dBm} + 10\log B</math>, where B is the 26-dB emission bandwidth in MHz.</p>
<b>Results:</b>	Passed (See Data Sheet)
<b>Note:</b>	<p>Conducted Emissions Measurements were performed on the EUT with power supply set at the following voltage and frequency.</p> <ul style="list-style-type: none"><li>• 120VAC / 60 Hz.</li></ul>





Peak Transmit Power (Continued)

Mode	Channel	Frequency (MHz)	Chain	Data Rate (Mbps)	Average Power (dBm)	Average Power (mW)	Peak Power (dBm)	Peak Power (mW)
802.11a	36	5180	A	6	16.38	43.45	16.61	45.81
802.11a	48	5240	A	6	17.46	55.71	16.81	47.97
802.11a	52	5260	A	6	17.50	56.23	18.61	72.60
802.11a	64	5320	A	6	16.46	44.25	18.41	69.34
802.11a	36	5180	B	6	16.43	43.95	16.81	47.97
802.11a	48	5240	B	6	17.42	55.20	16.91	49.09
802.11a	52	5260	B	6	17.57	57.14	19.41	87.29
802.11a	64	5320	B	6	16.54	45.08	19.11	81.46
802.11n	36	5180	A	HT0	17.49	56.10	16.91	49.09
802.11n	52	5260	A	HT0	17.46	55.71	18.81	76.03
802.11n	64	5320	A	HT0	16.51	44.77	18.41	69.34
802.11n	36	5180	B	HT0	17.47	55.84	16.71	46.88
802.11n	52	5260	B	HT0	17.53	56.62	19.21	83.36
802.11n	64	5320	B	HT0	16.50	44.66	18.71	74.29
802.11n (40MHz)	38	5190	A	HT0	15.36	34.35	15.41	34.75
802.11n (40MHz)	46	5270	A	HT0	17.43	55.33	16.51	44.76
802.11n (40MHz)	62	5310	A	HT0	15.30	33.88	15.41	34.75
802.11n (40MHz)	38	5190	B	HT0	15.35	34.27	15.41	34.75
802.11n (40MHz)	46	5270	B	HT0	17.38	54.69	16.91	49.08
802.11n (40MHz)	62	5310	B	HT0	15.41	34.75	15.21	33.18

NOTE: The output power measurement is conducted.



Peak Transmit Power (Continued)

Mode	Channel	Freq. (MHz)	Data Rate (Mbps)	Avg. Power (dBm) Ch. A	Avg. Power (mW) Ch. A	Peak Power (dBm) Ch. A	Peak Power (mW) Ch. A	Avg. Power (dBm) Ch. B	Avg. Power (mW) Ch. B	Peak Power (dBm) Ch. B	Peak Power (mW) Ch. B
802.11n (20MHz)	36	5180	HT 8	12.59	18.14	13.78	23.86	12.51	17.81	13.85	24.25
802.11n (20MHz)	52	5260	HT 8	14.61	28.89	16.99	49.97	14.40	27.53	17.19	52.33
802.11n (20MHz)	64	5320	HT 8	14.41	27.59	17.09	51.14	14.32	27.02	17.29	53.55
802.11n (40MHz)	38(F)	5190	HT 8	12.51	17.83	14.04	25.36	12.56	18.04	13.84	24.22
802.11n (40MHz)	46(F)	5270	HT 8	14.50	28.19	17.64	58.09	14.57	28.65	17.54	56.77
802.11n (40MHz)	62(F)	5310	HT 8	14.42	27.68	17.84	60.83	14.57	28.65	17.94	62.25

Mode	Channel	Freq. (MHz)	Data Rate (Mbps)	Aggregate Avg. Output Power (dBm) Ch. A + B	Aggregate Avg. Output Power (mW) Ch. A + B	Aggregate Peak Output Power (dBm) Ch. A + B	Aggregate Peak Output Power (mW) Ch. A + B
802.11n (20MHz)	36	5180	HT 8	15.56	35.96	16.82	48.12
802.11n (20MHz)	52	5260	HT 8	17.51	56.42	20.10	102.30
802.11n (20MHz)	64	5320	HT 8	17.37	54.61	20.20	104.69
802.11n (40MHz)	38(F)	5190	HT 8	15.55	35.86	16.95	49.58
802.11n (40MHz)	46(F)	5270	HT 8	17.55	56.84	20.60	114.86
802.11n (40MHz)	62(F)	5310	HT 8	17.51	56.33	20.90	123.08

(F) = Fat Channel





## CONDCUTED BAND EDGE EMISSIONS TEST RESULTS

<b>CLIENT:</b>	Intel Corporation	<b>DATE:</b>	09/29/06
<b>EUT:</b>	Intel PRO/Wireless 4965AGN Network Connection	<b>PROJECT NUMBER:</b>	INTEL-060907
<b>MODEL NUMBER:</b>	4965AGN	<b>TEST ENGINEER:</b>	BM/JC
<b>SERIAL NUMBER:</b>	0013E804612B	<b>SITE #:</b>	2
<b>CONFIGURATION:</b>	Tested installed in the host computer's mini PCI slot.	<b>TEMPERATURE:</b>	22 deg. C
		<b>HUMIDITY:</b>	36% RH
		<b>TIME:</b>	5:00 PM

<b>Description:</b>	For transmitters operating in the 5.25-5.35 GHz band: all emissions outside of the 5.15-5.35 GHz band shall not exceed an EIRP of -27 dBm/MHz. Devices operating in the 5.25-5.35 GHz band that generate emissions in the 5.15-5.25 GHz band must meet all applicable technical requirements for operation in the 5.15-5.25 GHz band (including indoor use) or alternatively meet an out-of-band emission EIRP limit of -27 dBm/MHz in the 5.15-5.25 GHz band.
<b>Results:</b>	See Data Sheet
<b>Note:</b>	Conducted Emissions Measurements were performed on the EUT with power supply set at the following voltage and frequency. <ul style="list-style-type: none"> <li>120VAC / 60 Hz.</li> </ul>

Unwanted Spurious Emissions Limits	
Frequency (MHz)	Field Strength (dBm/Hz) (Emissions outside the restricted bands)
5250-5350	EIRP < -27dBm/Hz (68.3dBuV/m)

Freq. (MHz)	Power Spec Den. Reading (dBm/Hz)	Antenna Gain (dBi)	Corrected Reading (dBm/Hz)	Limits (dBm/Hz)	Diff (dB) +=FAIL	Comments
<b>With Ethertronics Antennas (Gain at 5GHz) Transmitting on Chain A</b>						
5250.00	-34.50	5.00	-29.50	-27.00	-2.50	Tx @ 5240 MHz
5250.00	-33.70	5.00	-28.70	-27.00	-1.70	Tx @ 5260 MHz
<b>With Ethertronics Antennas (Gain at 5GHz) Transmitting on Chain B</b>						
5250.00	-34.50	5.00	-29.50	-27.00	-2.50	Tx @ 5240 MHz
5250.00	-33.70	5.00	-28.70	-27.00	-1.70	Tx @ 5260 MHz

### Conducted Band Edge Emissions Test Results (Continued)

#### 802.11a Mode

Test Date	Data	Chain	Test Eng.
09/20/06	5.24 GHz band edge (INTEL-060907-25g01)	A	JC
<p>*ATTEN 20dB    VAUG 100    MKR -32.50dBm RL 16.0dBm    10dB/    5.25000GHz</p> <p>D TOTAL -34.5dBm DENSITY -94.5dBm/Hz</p> <p>CENTER 5.25000GHz    SPAN 50.00MHz *RBW 1.0MHz    *VBW 1.0MHz    SWP 50.0ms</p>			
Test Date	Data	Chain	Test Eng.
09/20/06	5.26 GHz band edge (INTEL-060907-25g02)	A	JC
<p>*ATTEN 20dB    VAUG 100    MKR -31.83dBm RL 16.0dBm    10dB/    5.25000GHz</p> <p>D TOTAL -33.7dBm DENSITY -93.7dBm/Hz</p> <p>CENTER 5.25000GHz    SPAN 50.00MHz *RBW 1.0MHz    *VBW 1.0MHz    SWP 50.0ms</p>			



### Conducted Band Edge Emissions Test Results (Continued)

#### 802.11a Mode

Test Date	Data	Chain	Test Eng.
09/20/06	5.24 GHz band edge (INTEL-060907-25g03)	B	JC
<p>*ATTEN 20dB    VAUG 100    MKR -32.50dBm            RL 16.0dBm    10dB/    5.25000GHz</p> <p>D TOTAL -34.5dBm            DENSITY -94.5dBm/Hz</p> <p>R</p> <p>CENTER 5.25000GHz    SPAN 50.00MHz            *RBW 1.0MHz    *VBW 1.0MHz    SWP 50.0ms</p>			
09/20/06	5.26 GHz band edge (INTEL-060907-25g04)	B	JC
<p>*ATTEN 20dB    VAUG 100    MKR -31.83dBm            RL 16.0dBm    10dB/    5.25000GHz</p> <p>D TOTAL -33.7dBm            DENSITY -93.7dBm/Hz</p> <p>R</p> <p>CENTER 5.25000GHz    SPAN 50.00MHz            *RBW 1.0MHz    *VBW 1.0MHz    SWP 50.0ms</p>			



## 26dB EMISSIONS BANDWIDTH

<b>CLIENT:</b>	Intel Corporation	<b>DATE:</b>	09/20/06
<b>EUT:</b>	Intel PRO/Wireless 4965AGN Network Connection	<b>PROJECT NUMBER:</b>	INTEL-060907
<b>MODEL NUMBER:</b>	4965AGN	<b>TEST ENGINEER:</b>	JC
<b>SERIAL NUMBER:</b>	0013E804612B	<b>SITE #:</b>	2
<b>CONFIGURATION:</b>	Tested installed in the host computer's mini PCI slot.	<b>TEMPERATURE:</b>	21 deg. C
		<b>HUMIDITY:</b>	42% RH
		<b>TIME:</b>	9:15 AM

<b>Description:</b>	26dB emissions bandwidth in MHz.
<b>Results:</b>	See Data Sheet
<b>Note:</b>	Conducted Emissions Measurements were performed on the EUT with power supply set at the following voltage and frequency. <ul style="list-style-type: none"><li>• 120VAC / 60 Hz.</li></ul>











26dB Emissions Bandwidth (Continued)

802.11n Mode, 5GHz, 20MHz Wide

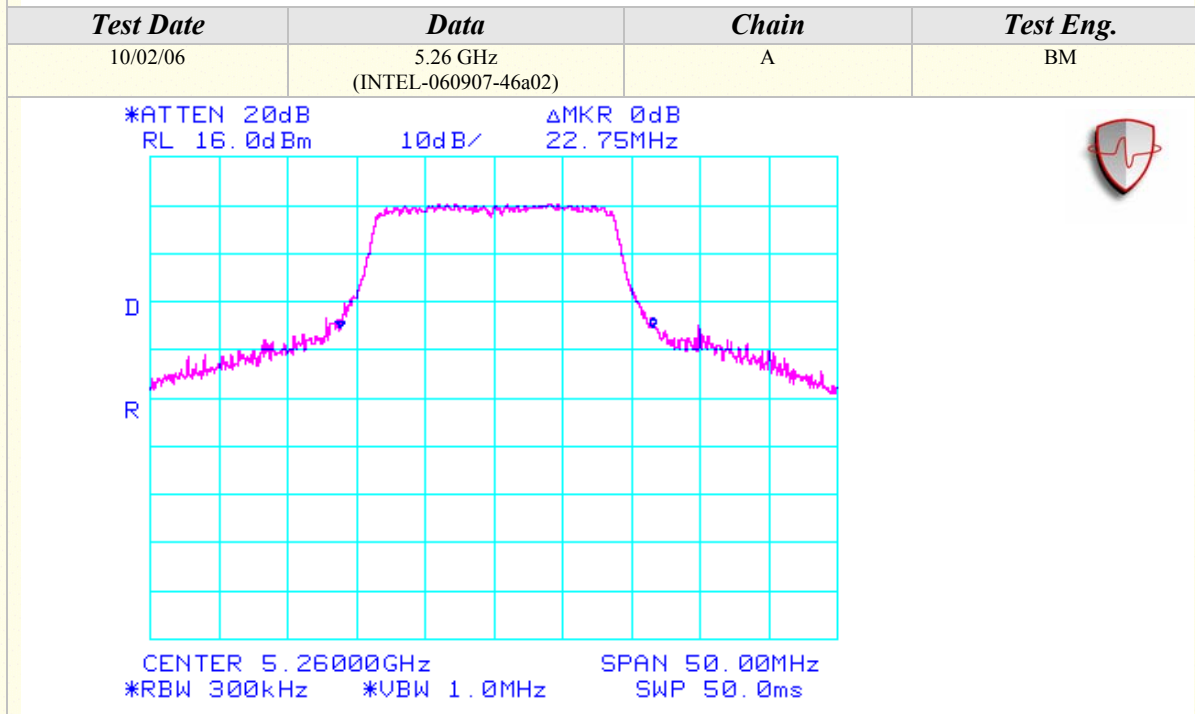
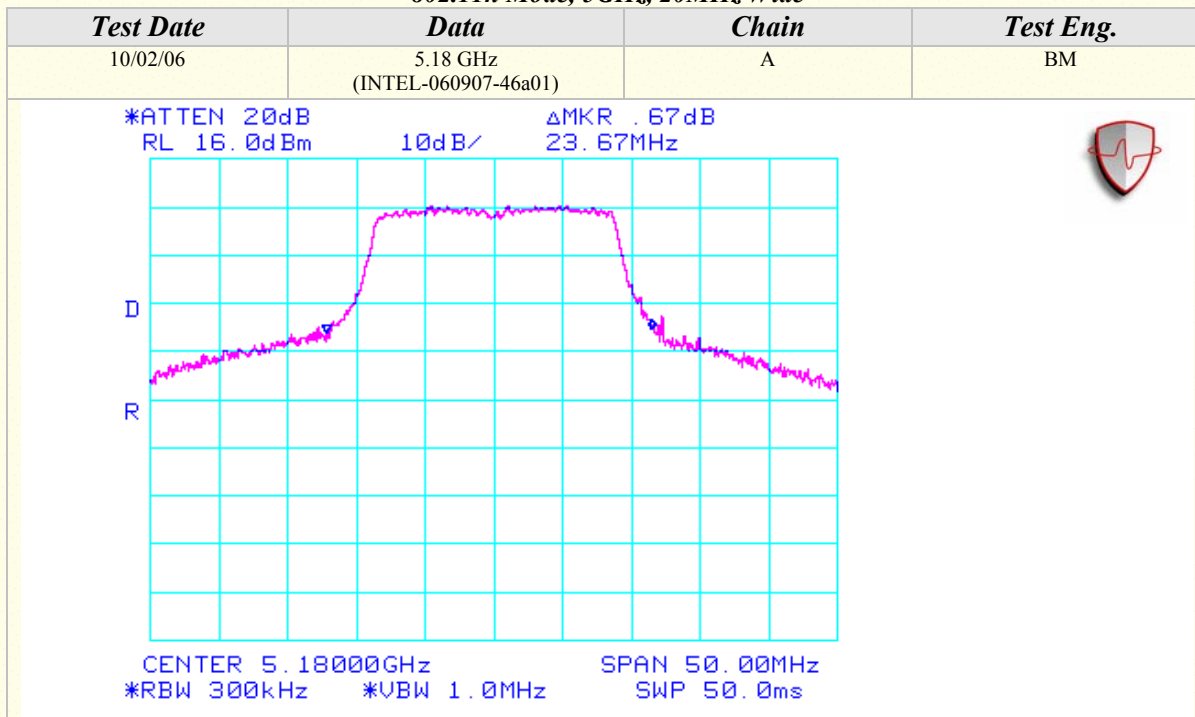



26dB Emissions Bandwidth (Continued)

802.11n Mode, 5GHz, 20MHz Wide

Test Date	Data	Chain	Test Eng.
10/02/06	5.32 GHz (INTEL-060907-46a03)	A	BM

\*ATTEN 20dB      ΔMKR -.50dB  
 RL 16.0dBm      10dB/      22.33MHz

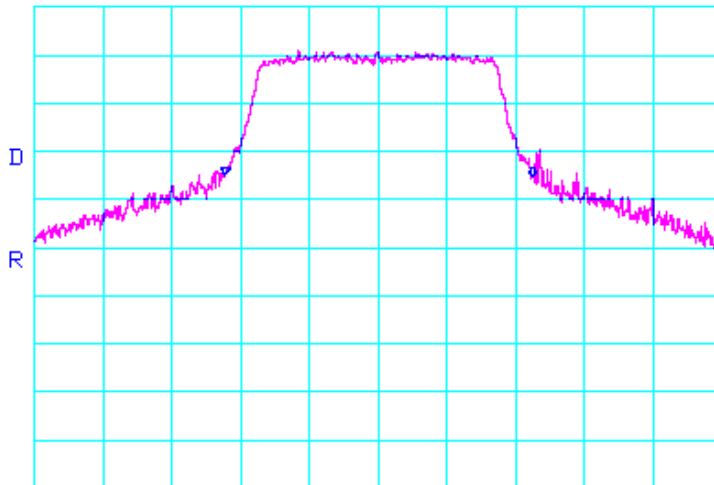

CENTER 5.32000GHz      SPAN 50.00MHz  
 \*RBW 300kHz      \*UBW 1.0MHz      SWP 50.0ms

Test Date	Data	Chain	Test Eng.
10/02/06	5.18 GHz (INTEL-060907-46a04)	B	BM

\*ATTEN 20dB      ΔMKR -.17dB  
 RL 16.0dBm      10dB/      23.25MHz

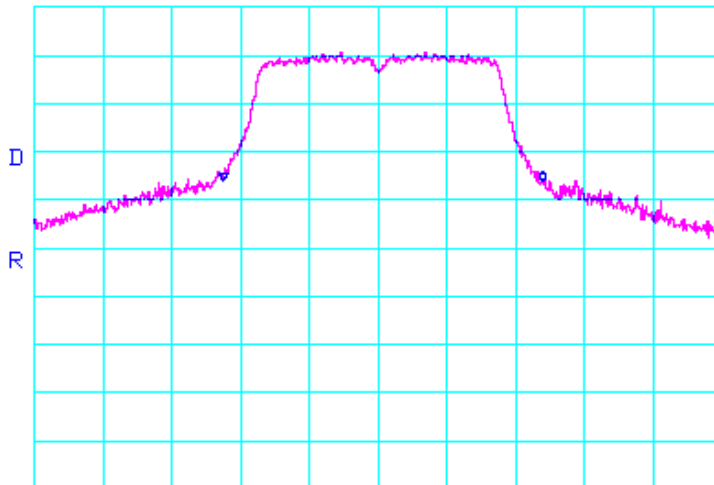

CENTER 5.18000GHz      SPAN 50.00MHz  
 \*RBW 300kHz      \*UBW 1.0MHz      SWP 50.0ms

26dB Emissions Bandwidth (Continued)

802.11n Mode, 5GHz, 20MHz Wide

Test Date	Data	Chain	Test Eng.
10/02/06	5.26 GHz (INTEL-060907-46a05)	B	BM

\*ATTEN 20dB      ΔMKR 0dB  
 RL 16.0dBm      10dB/      23.00MHz

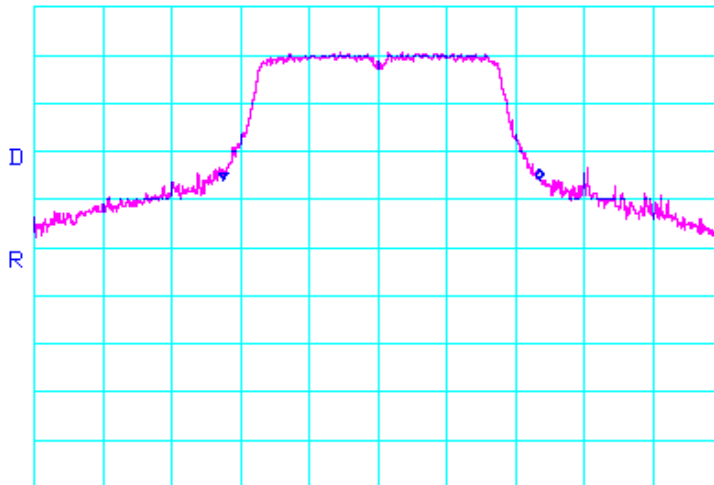

CENTER 5.26000GHz      SPAN 50.00MHz  
 \*RBW 300kHz      \*VBW 1.0MHz      SWP 50.0ms



Test Date	Data	Chain	Test Eng.
10/02/06	5.32 GHz (INTEL-060907-46a06)	B	BM

\*ATTEN 20dB      ΔMKR -.17dB  
 RL 16.0dBm      10dB/      22.75MHz

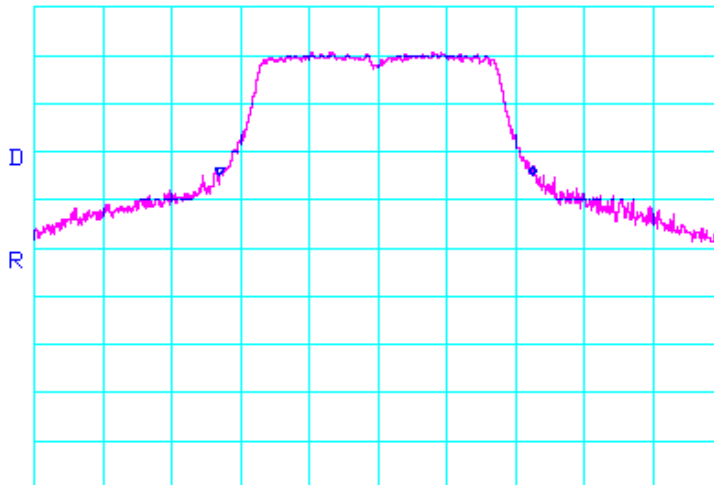

CENTER 5.32000GHz      SPAN 50.00MHz  
 \*RBW 300kHz      \*VBW 1.0MHz      SWP 50.0ms





26dB Emissions Bandwidth (Continued)

802.11n Mode, 5GHz, 40MHz Wide

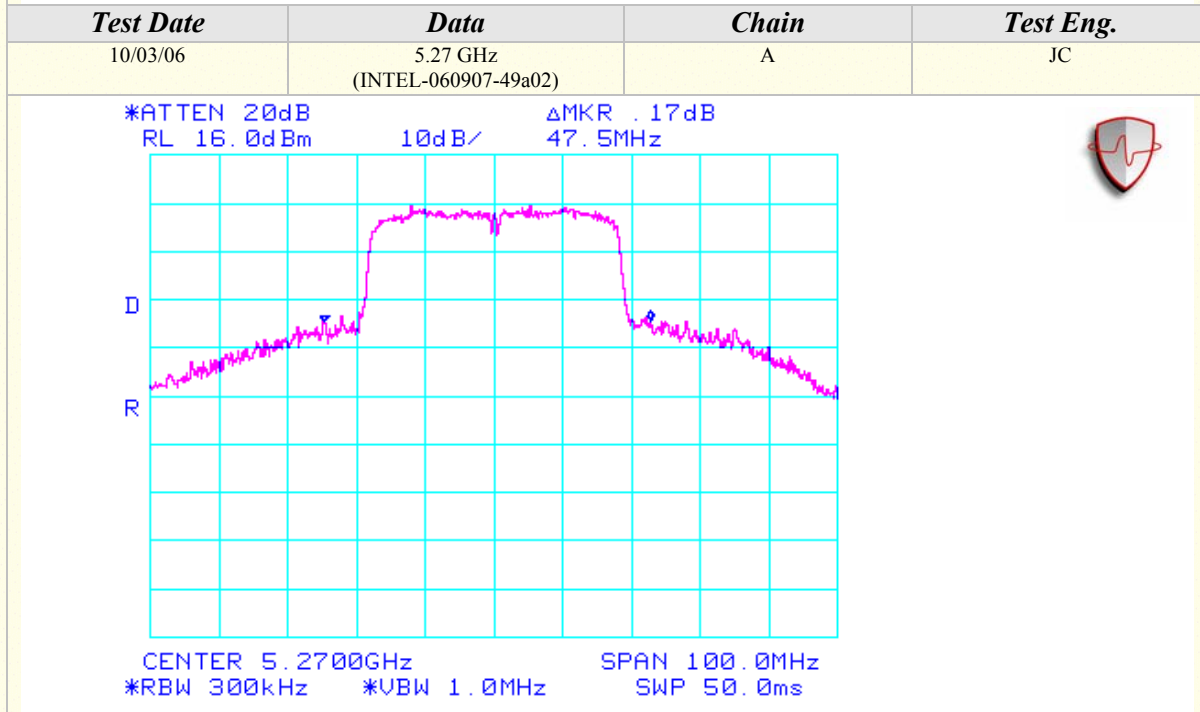
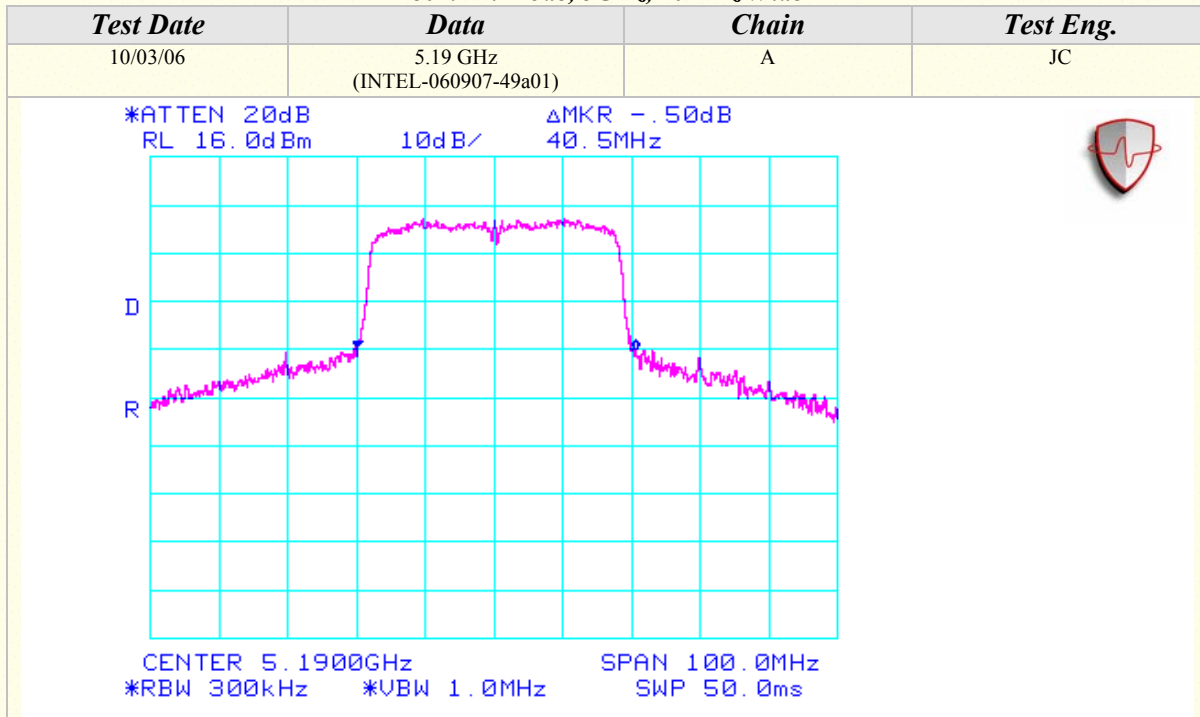

26dB Emissions Bandwidth (Continued)

802.11n Mode, 5GHz, 40MHz Wide

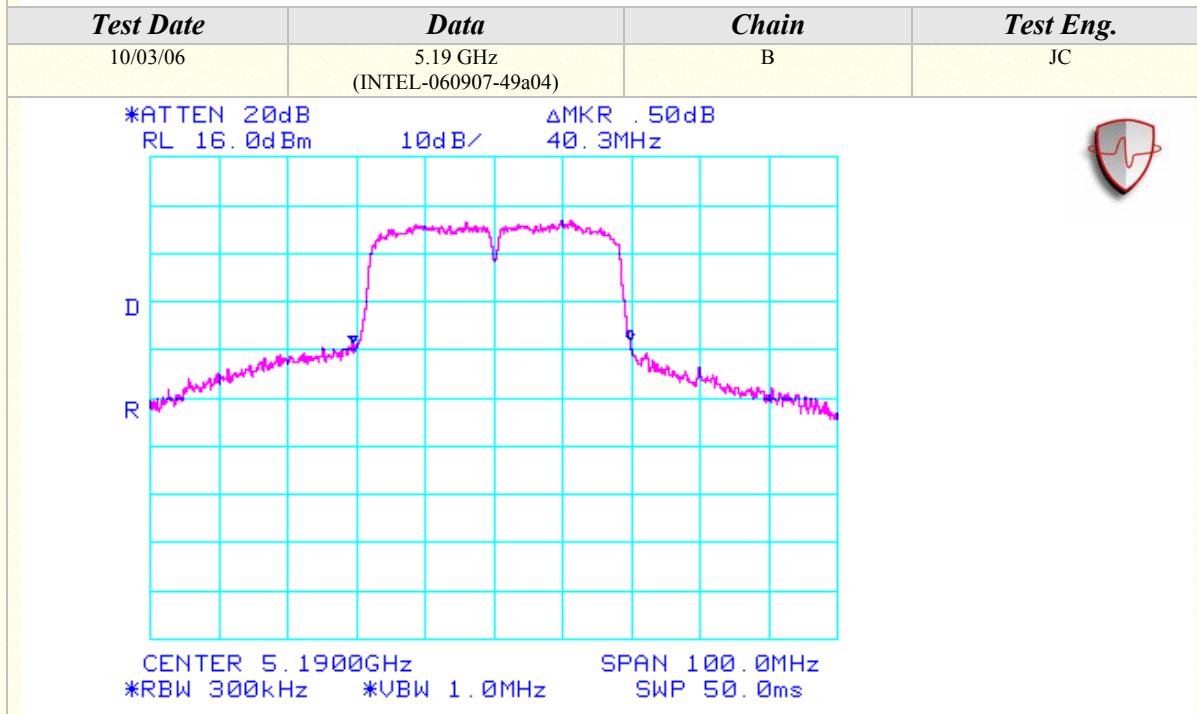
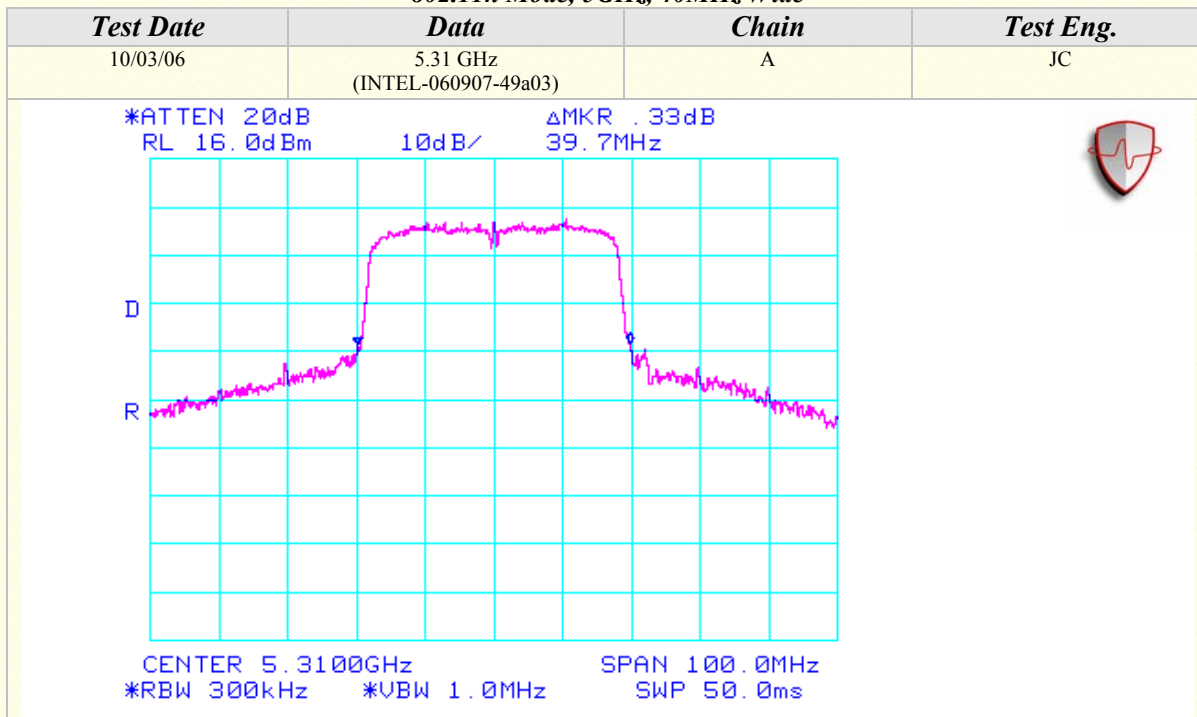



26dB Emissions Bandwidth (Continued)

802.11n Mode, 5GHz, 40MHz Wide

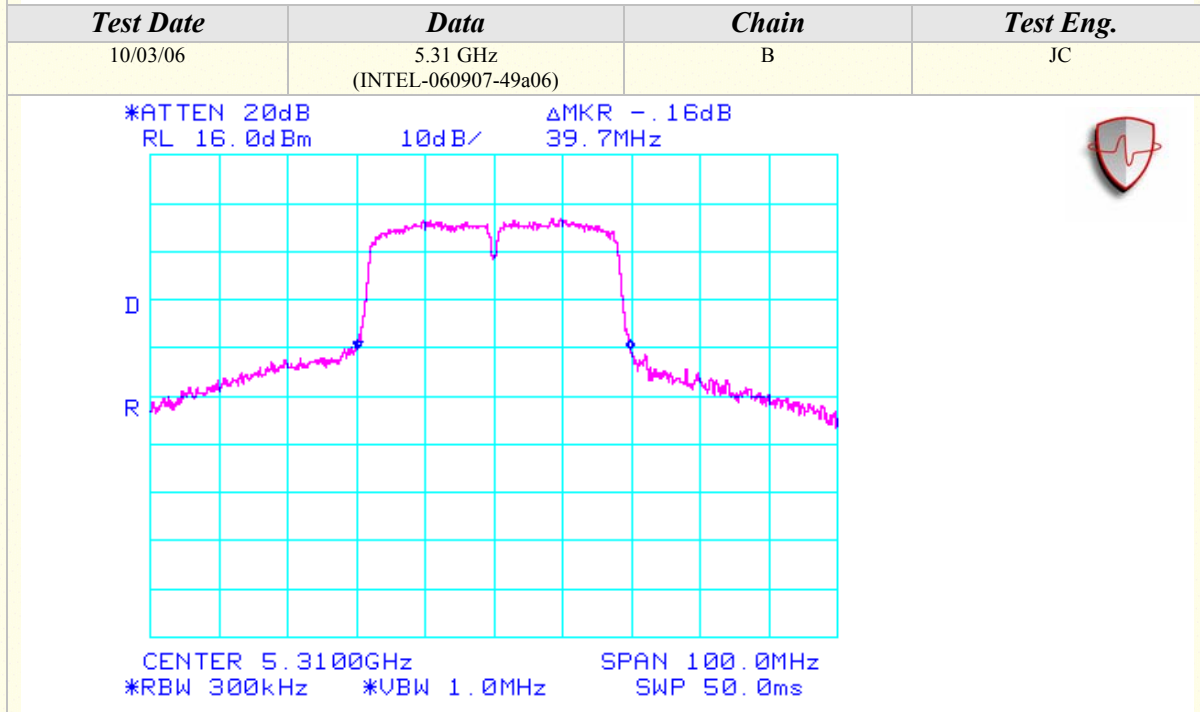
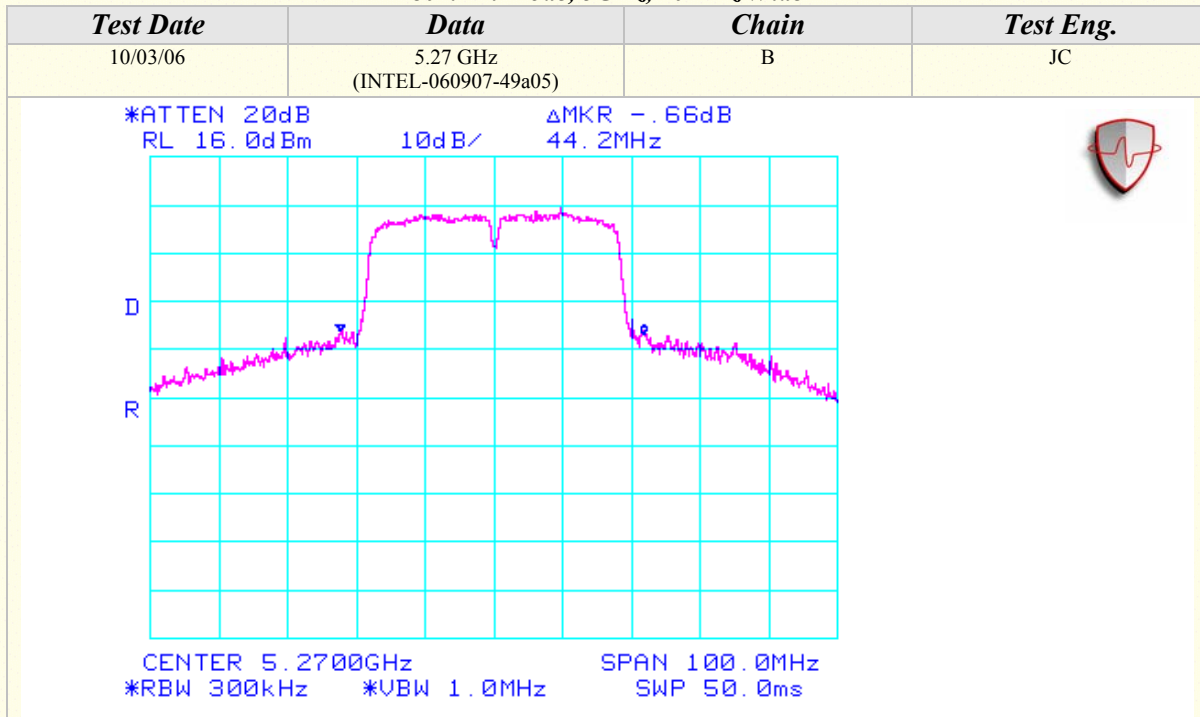



## PEAK POWER SPECTRAL DENSITY

<b>CLIENT:</b>	Intel Corporation	<b>DATE:</b>	09/20/06
<b>EUT:</b>	Intel PRO/Wireless 4965AGN Network Connection	<b>PROJECT NUMBER:</b>	INTEL-060907
<b>MODEL NUMBER:</b>	4965AGN	<b>TEST ENGINEER:</b>	JC
<b>SERIAL NUMBER:</b>	0013E804612B	<b>SITE #:</b>	2
<b>CONFIGURATION:</b>	Tested installed in the host computer's mini PCI slot.	<b>TEMPERATURE:</b>	21 deg. C
		<b>HUMIDITY:</b>	42% RH
		<b>TIME:</b>	9:15 AM

<b>Description:</b>	For the band 5.15-5.25 GHz, the peak power spectral density shall not exceed 4 dBm in any 1-MHz band  For the band 5.2 5-5.35 GHz, the peak power spectral density shall not exceed 11 dBm in any 1-MHz band
<b>Results:</b>	See Data Sheet
<b>Note:</b>	Conducted Emissions Measurements were performed on the EUT with power supply set at the following voltage and frequency. <ul style="list-style-type: none"> <li>• 120VAC / 60 Hz.</li> </ul>

Peak Power Spectral Density Limits	
Frequency (MHz)	Limit (dBm)
5150-5250	4
5250-5350	11

Using "Method 1" of the FCC Public Notice (DA 02-2138) for 5250-5350MHz band  
Using "Method 2" of the FCC Public Notice (DA 02-2138) for 5150-5250MHz band



Peak Power Spectral Density (Continued)

802.11a Mode

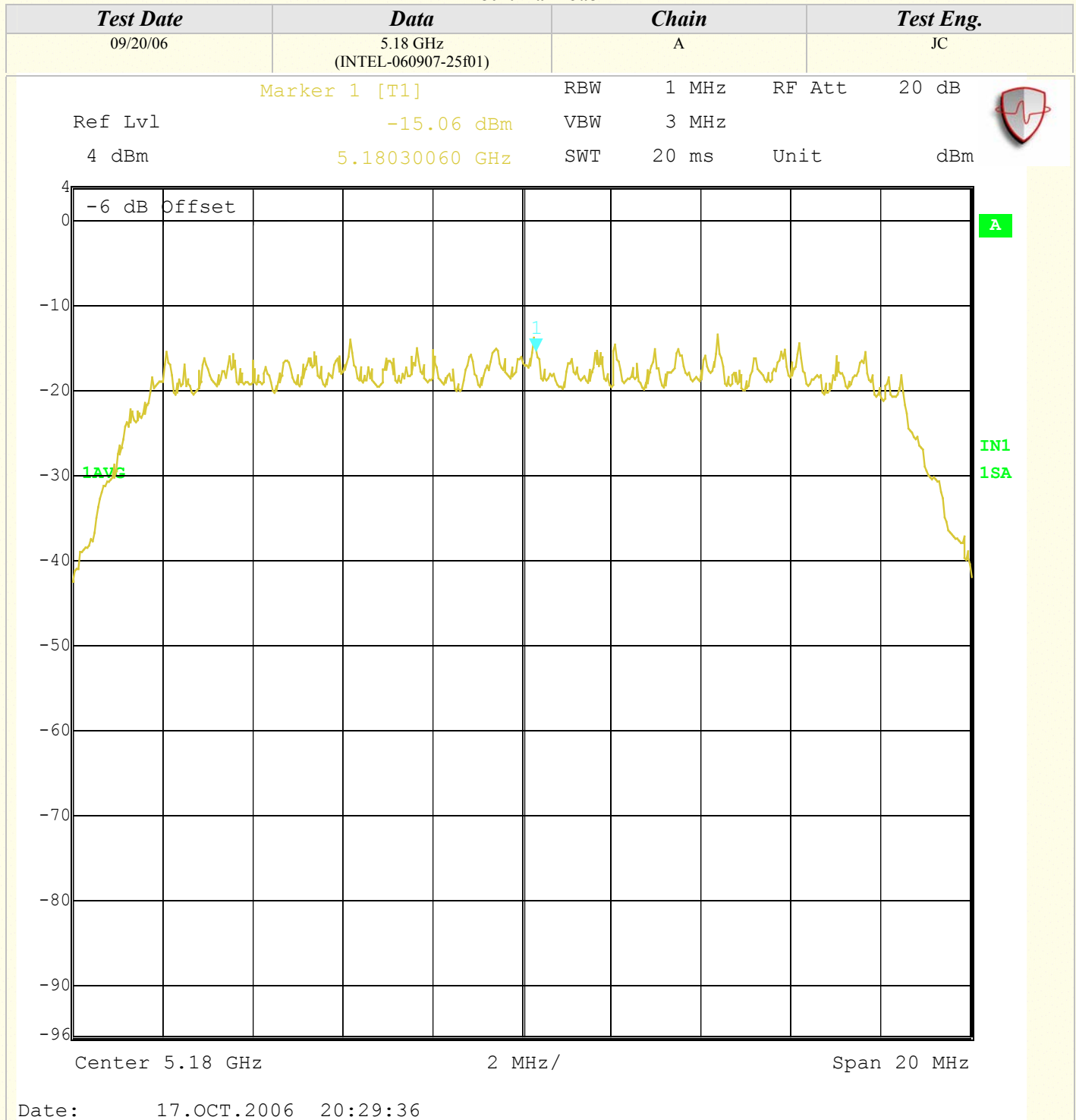





Peak Power Spectral Density (Continued)

802.11a Mode

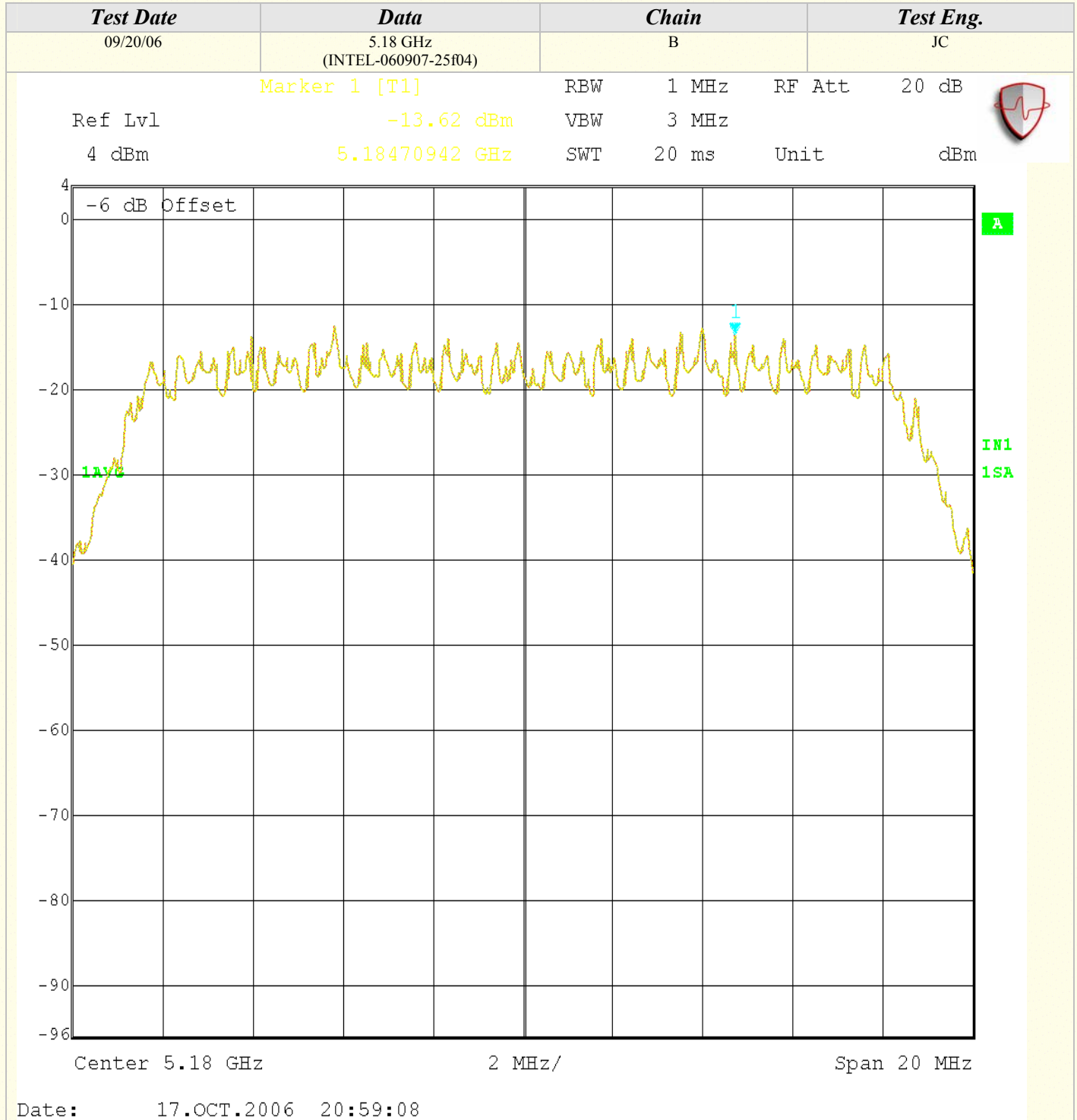

Peak Power Spectral Density (Continued)

802.11a Mode

Test Date	Data	Chain	Test Eng.
09/20/06	5.26 GHz (INTEL-060907-25f05)	B	JC

\*ATTEN 20dB  
 RL 16.0dBm 10dB/ MKR 9.83dBm  
 5.25720GHz

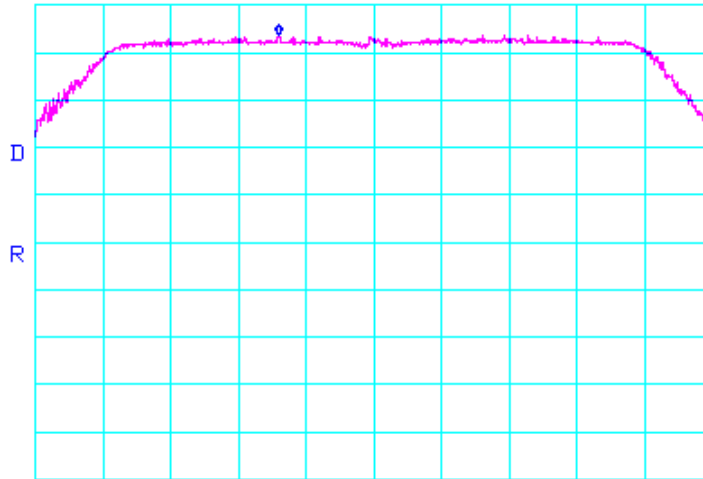

CENTER 5.26000GHz SPAN 20.00MHz  
 \*RBW 1.0MHz \*VBW 3.0MHz SWP 50.0ms



Test Date	Data	Chain	Test Eng.
09/20/06	5.32 GHz (INTEL-060907-25f06)	B	JC

\*ATTEN 20dB  
 RL 16.0dBm 10dB/ MKR 9.33dBm  
 5.32017GHz

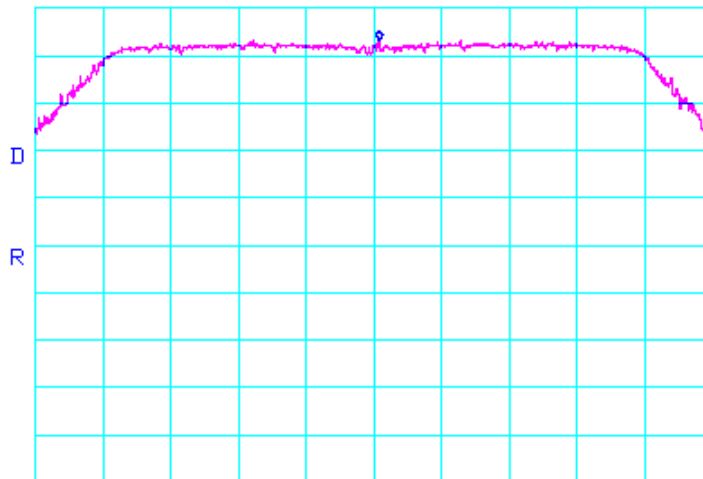

CENTER 5.32000GHz SPAN 20.00MHz  
 \*RBW 1.0MHz \*VBW 3.0MHz SWP 50.0ms











Peak Power Spectral Density (Continued)

802.11n Mode, 5GHz, 20MHz Wide

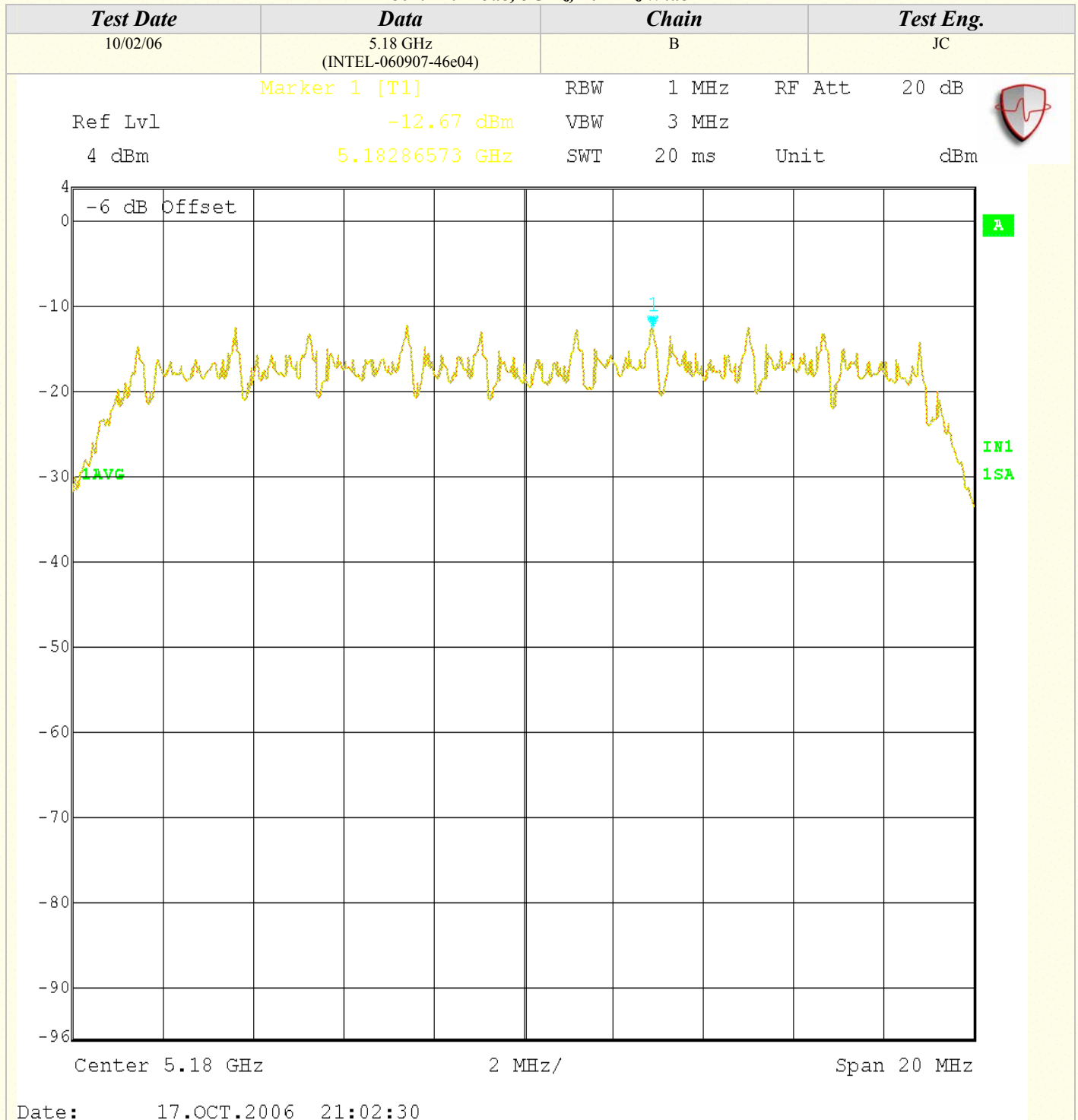





Peak Power Spectral Density (Continued)

802.11n Mode, 5GHz, 40MHz Wide

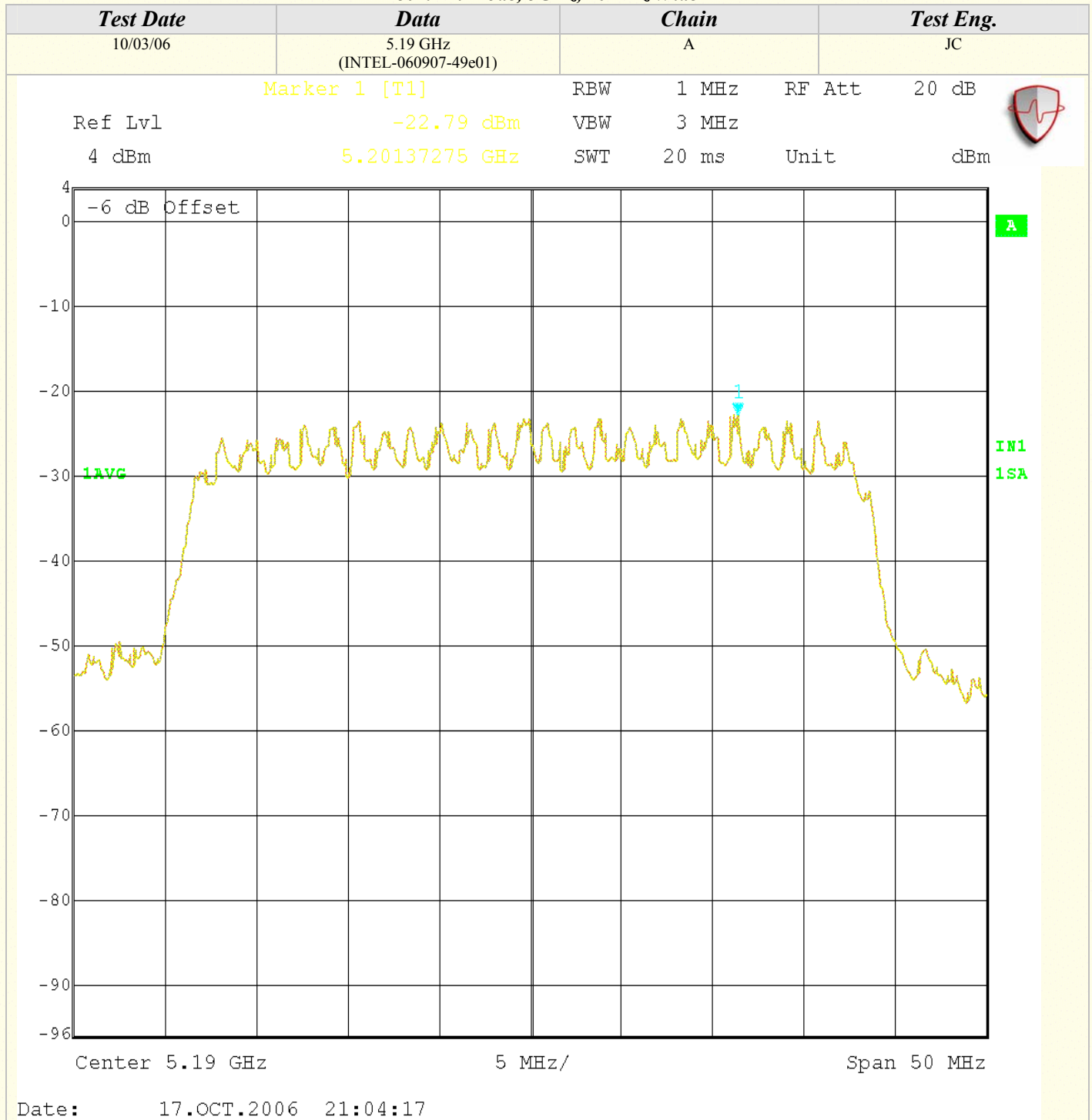





Peak Power Spectral Density (Continued)

802.11n Mode, 5GHz, 40MHz Wide

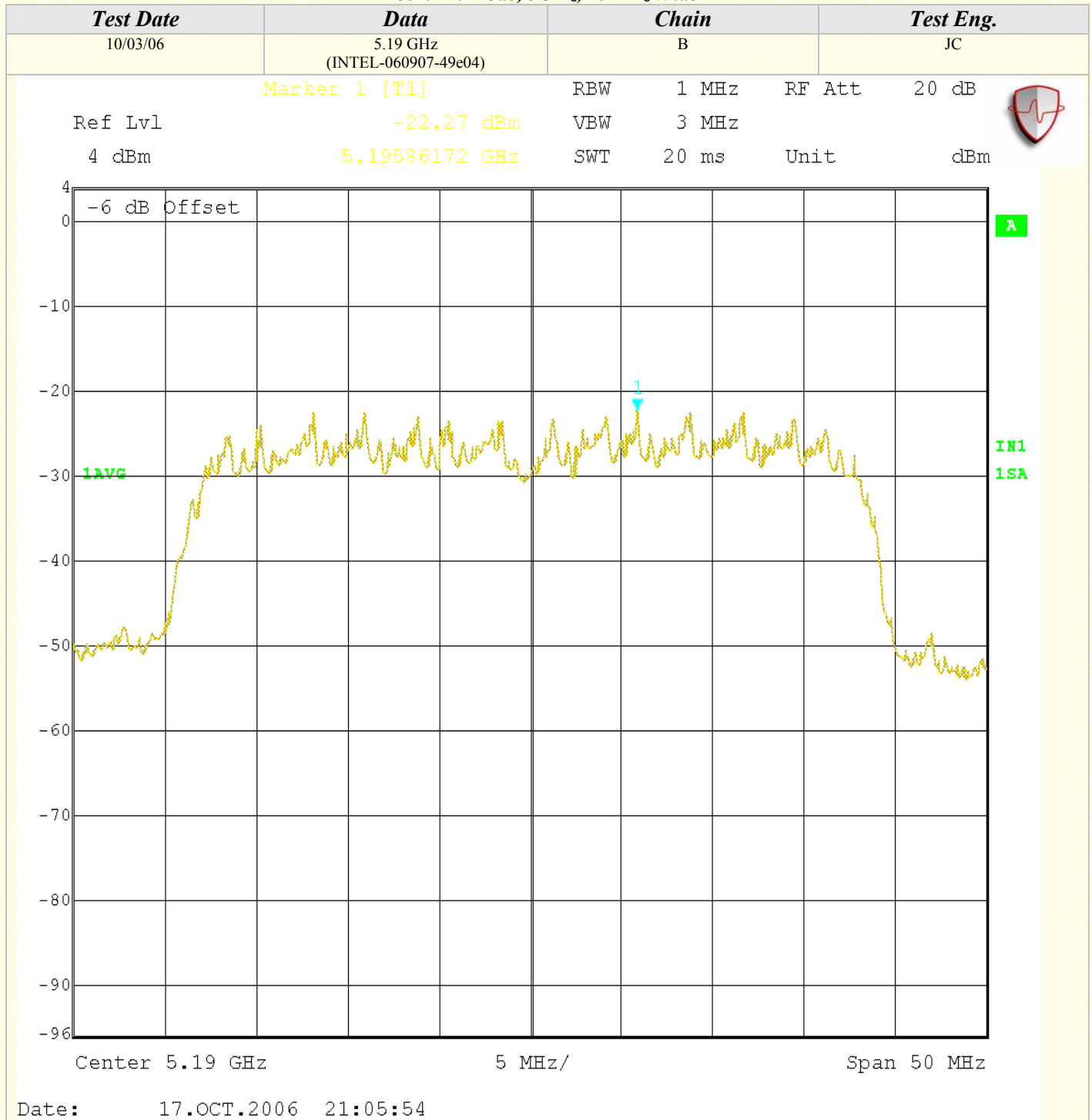







## PEAK EXCURSION

<b>CLIENT:</b>	Intel Corporation	<b>DATE:</b>	09/20/06
<b>EUT:</b>	Intel PRO/Wireless 4965AGN Network Connection	<b>PROJECT NUMBER:</b>	INTEL-060907
<b>MODEL NUMBER:</b>	4965AGN	<b>TEST ENGINEER:</b>	JC
<b>SERIAL NUMBER:</b>	0013E804612B	<b>SITE #:</b>	2
<b>CONFIGURATION:</b>	Tested installed in the host computer's mini PCI slot.	<b>TEMPERATURE:</b>	21 deg. C
		<b>HUMIDITY:</b>	42% RH
		<b>TIME:</b>	9:15 AM

<b>Description:</b>	The ratio of the peak excursion of the modulation envelope to the peak transmit power shall not exceed 13dB across any 1 MHz bandwidth or the emissions bandwidth whichever is less.
<b>Results:</b>	See Data Sheet
<b>Note:</b>	Conducted Emissions Measurements were performed on the EUT with power supply set at the following voltage and frequency. <ul style="list-style-type: none"><li>• 120VAC / 60 Hz.</li></ul>

Peak Power Spectral Density Limits	
Frequency (MHz)	Limit (dBm)
5150-5350	13





Peak Excursion (Continued)

802.11a Mode

Test Date	Data	Chain	Test Eng.
09/20/06	5.32 GHz (INTEL-060907-25d03)	A	JC

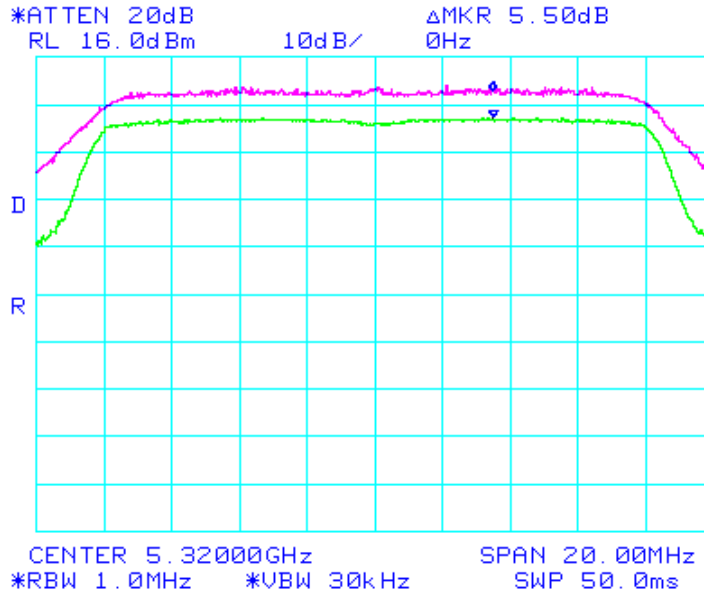

Test Date	Data	Chain	Test Eng.
09/20/06	5.18 GHz (INTEL-060907-25d04)	B	JC

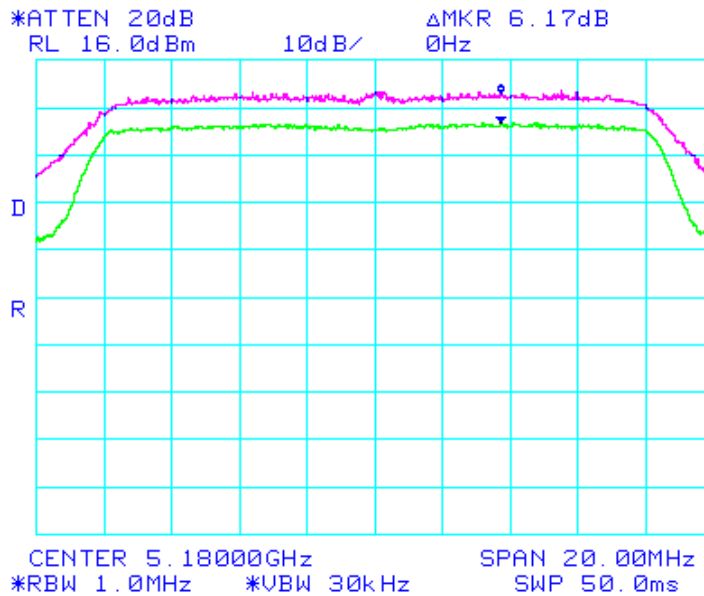





Peak Excursion (Continued)

802.11n Mode, 5GHz, 20MHz Wide

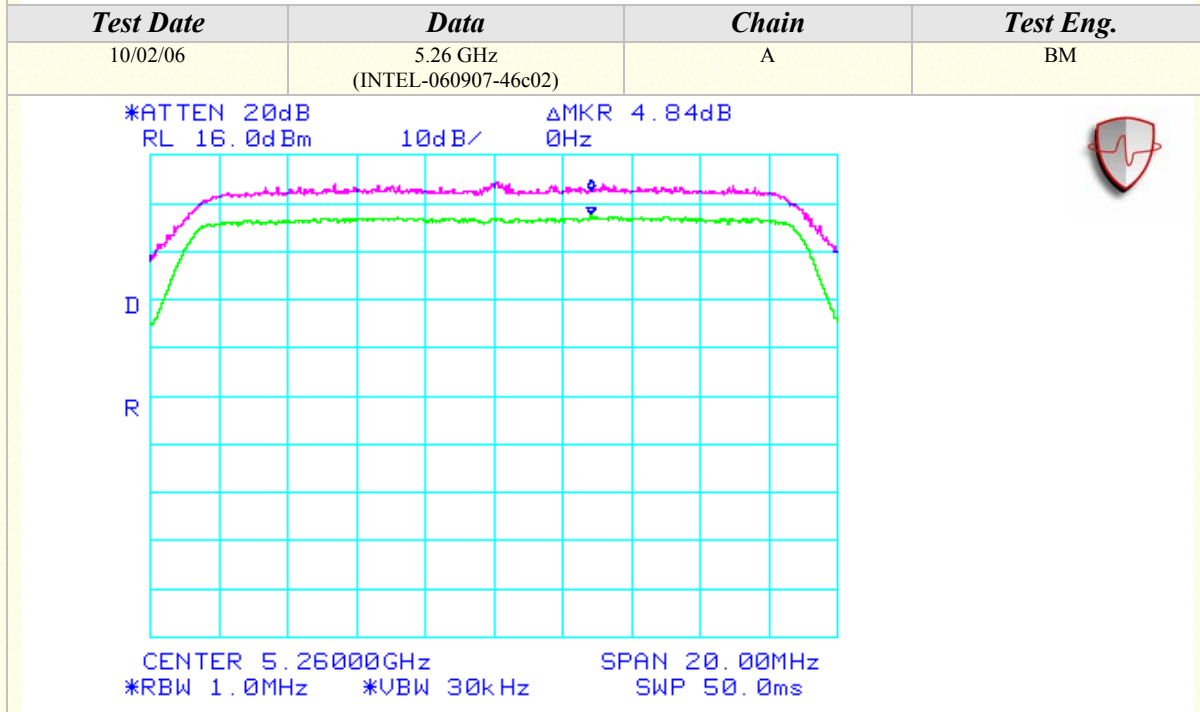
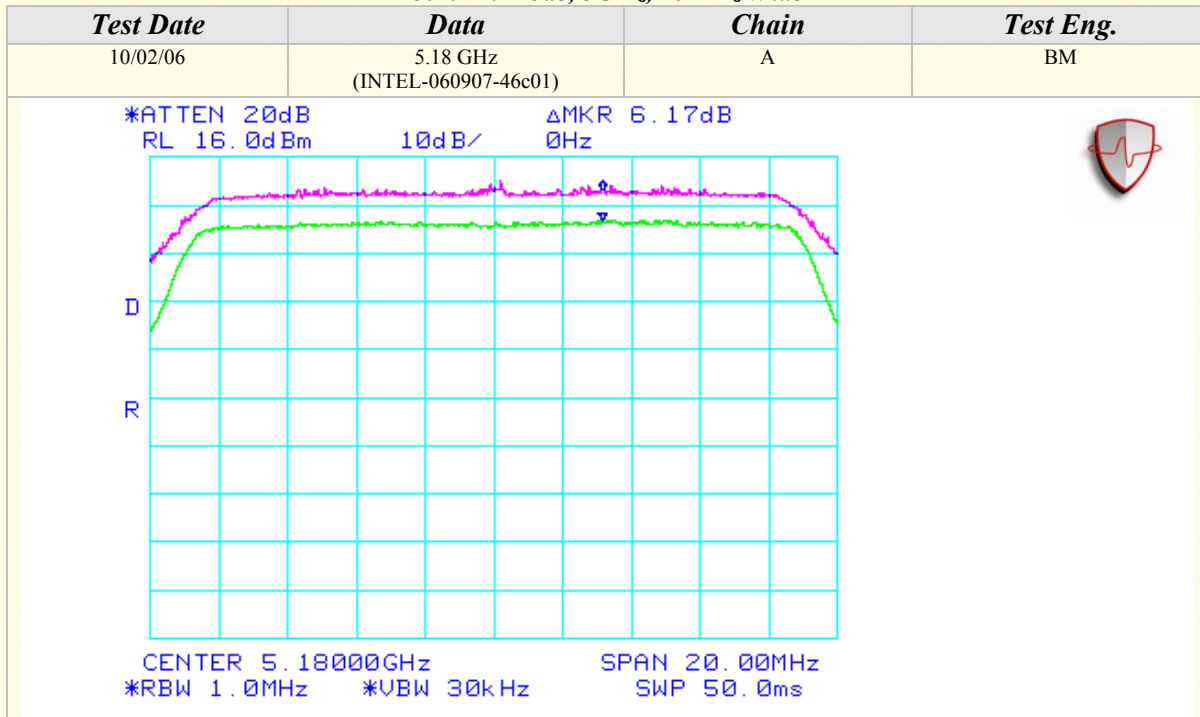

Peak Excursion (Continued)

802.11n Mode, 5GHz, 20MHz Wide

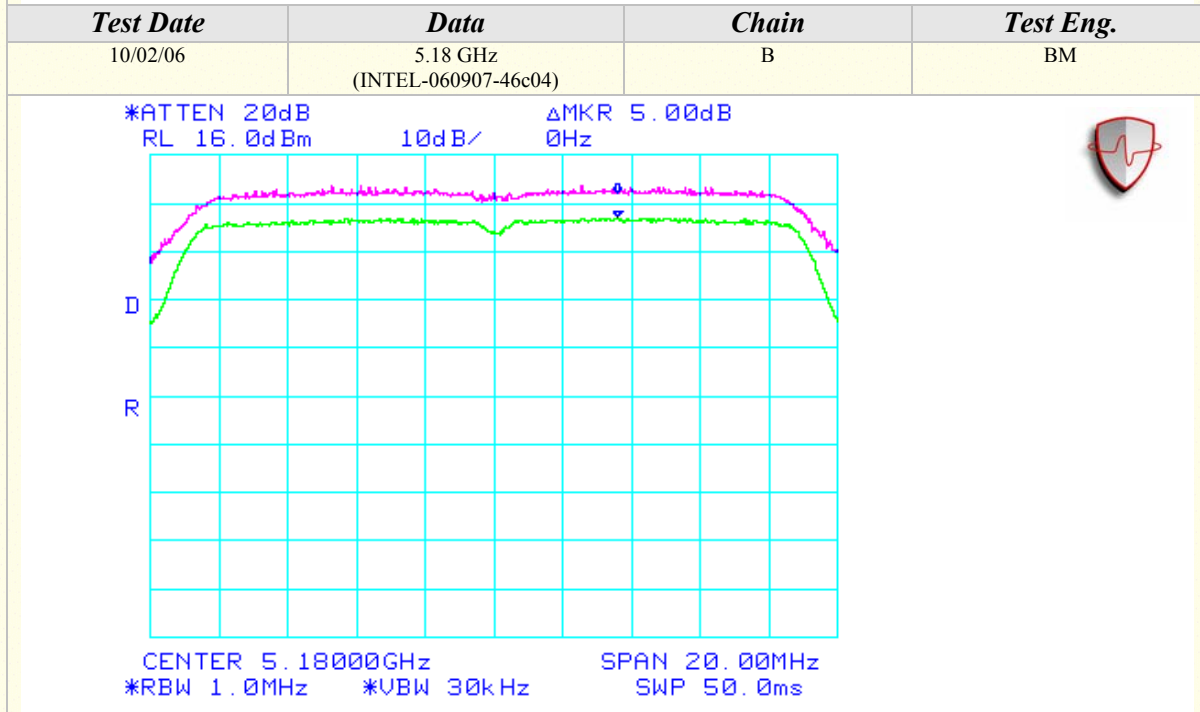
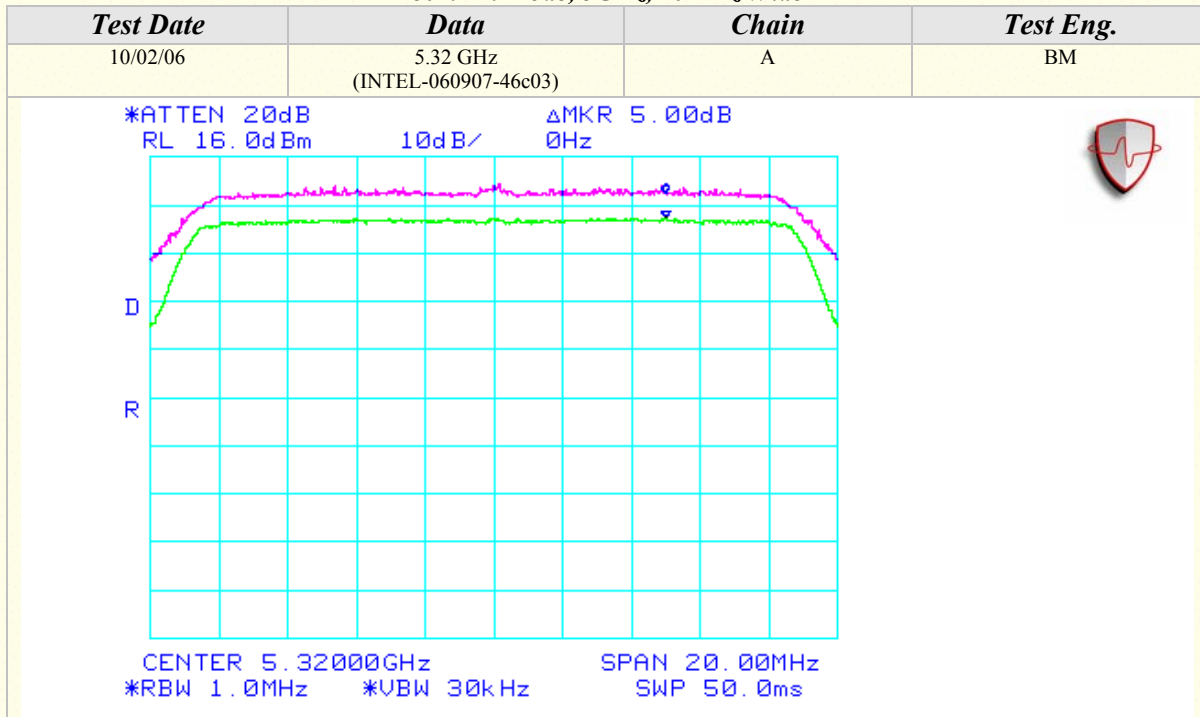



Peak Excursion (Continued)

802.11n Mode, 5GHz, 20MHz Wide

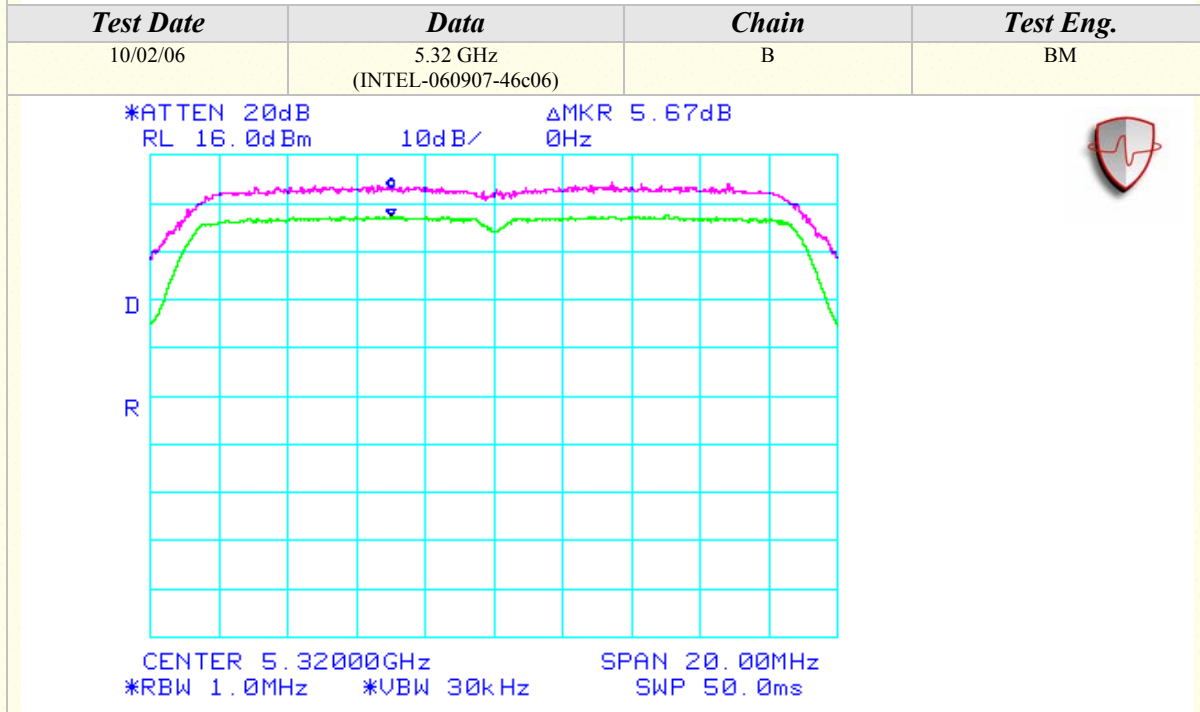
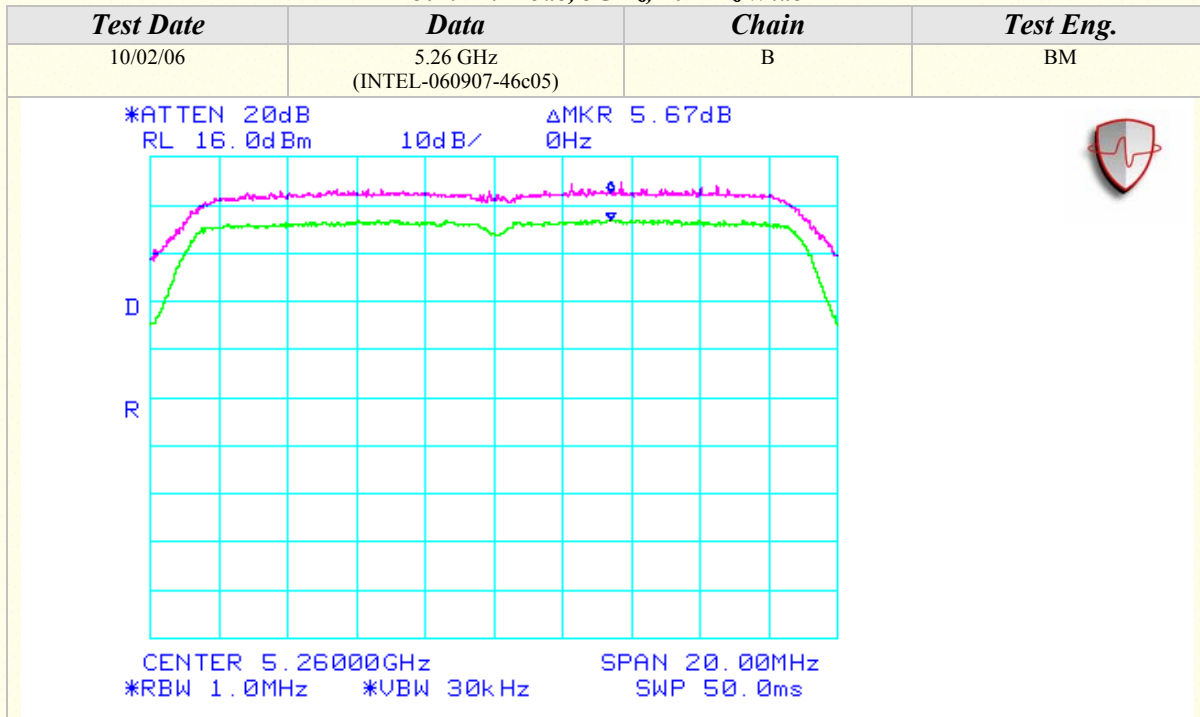

Peak Excursion (Continued)

802.11n Mode, 5GHz, 40MHz Wide

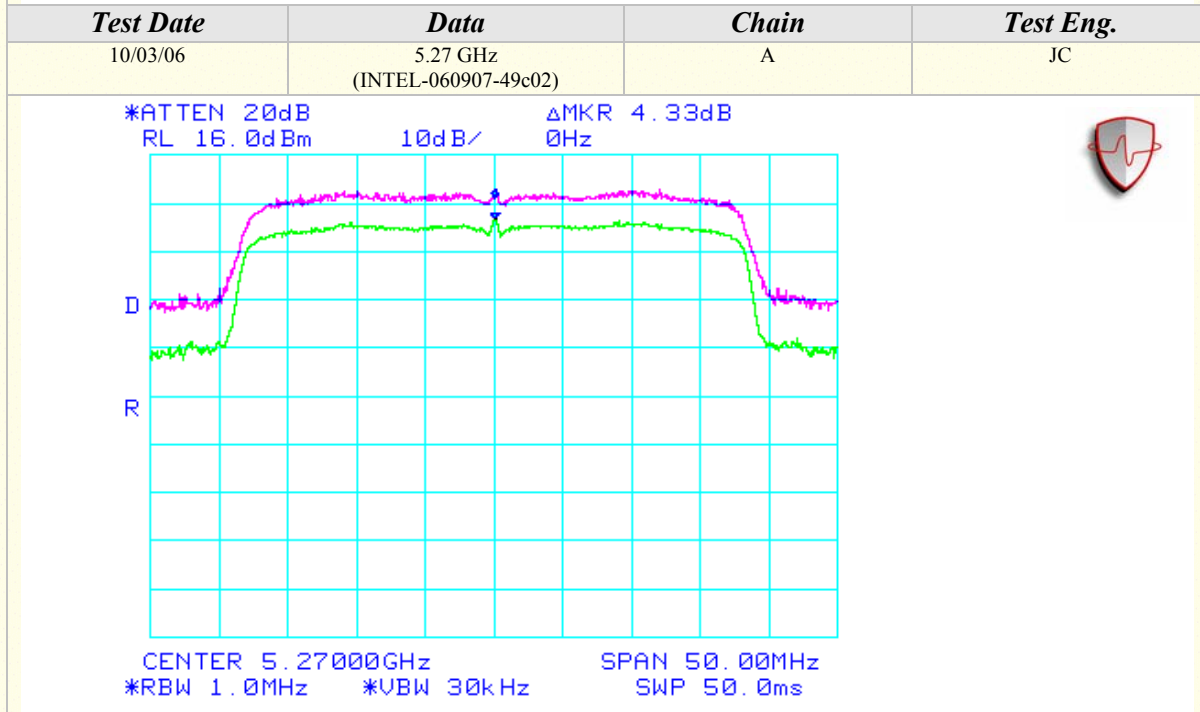
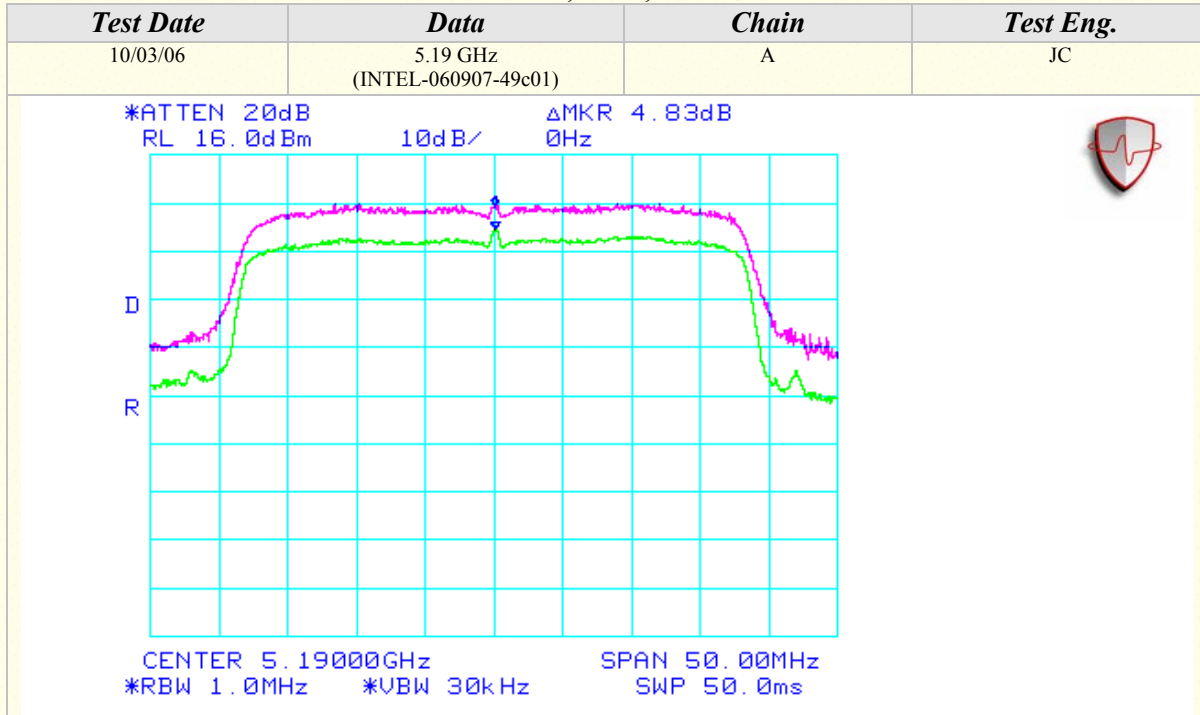



Peak Excursion (Continued)

802.11n Mode, 5GHz, 40MHz Wide

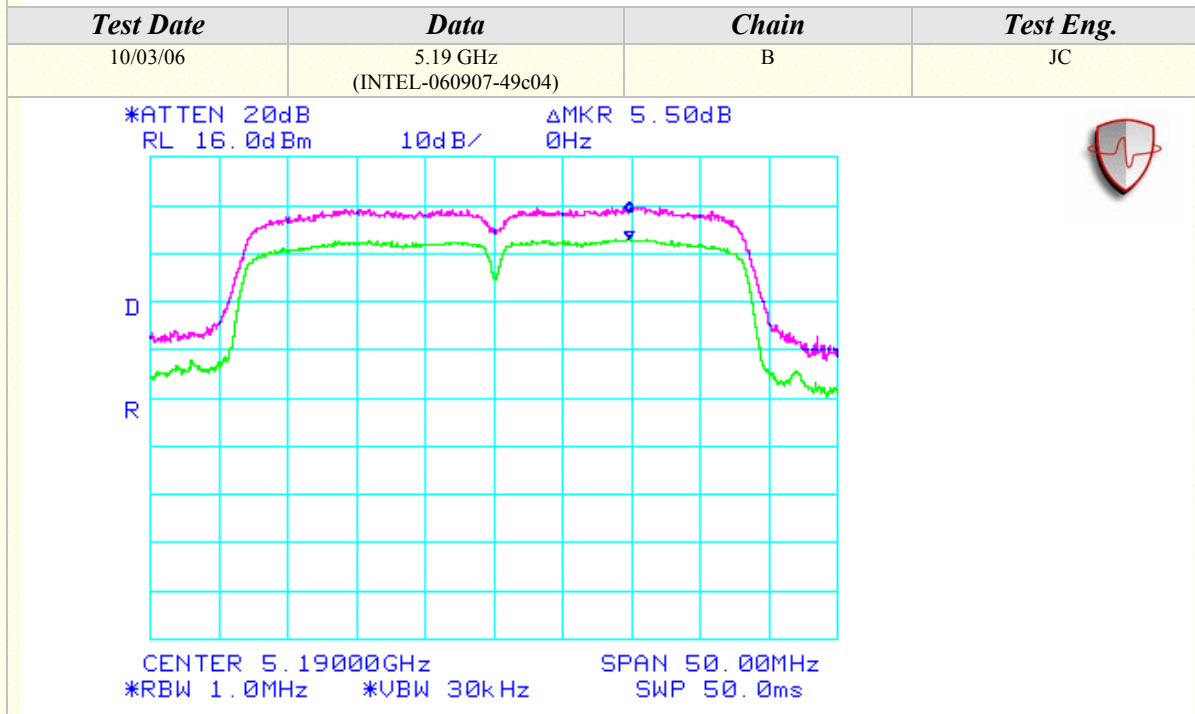
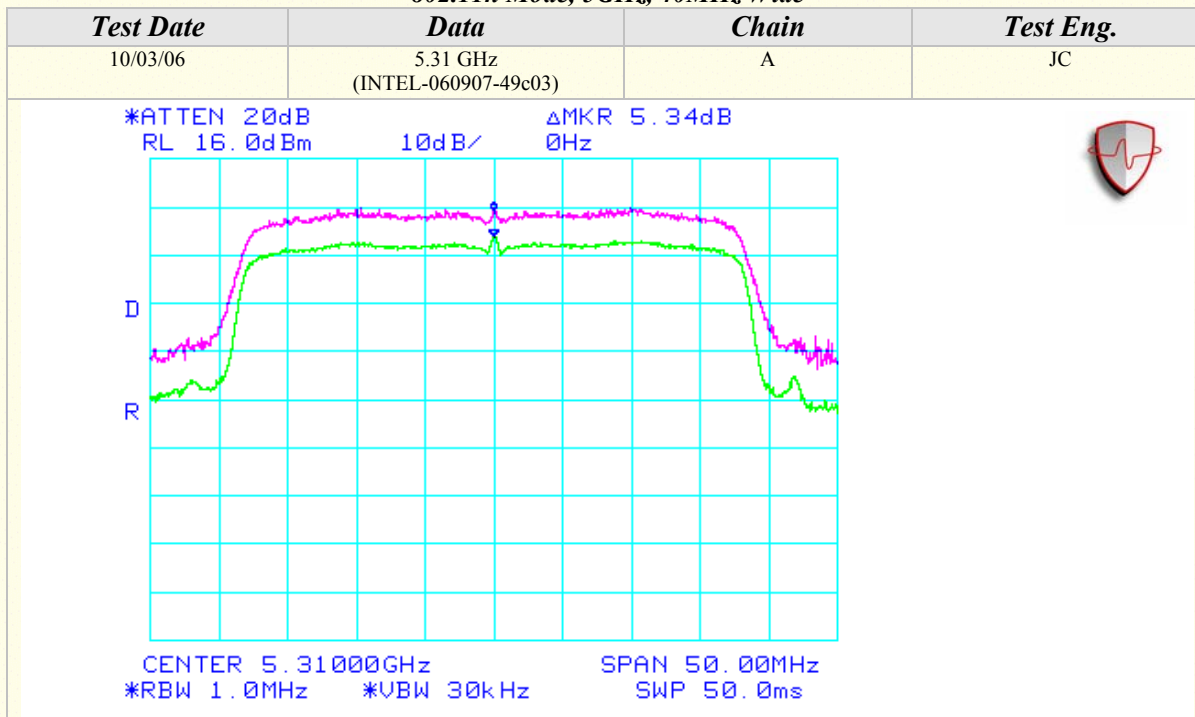

Peak Excursion (Continued)

802.11n Mode, 5GHz, 40MHz Wide

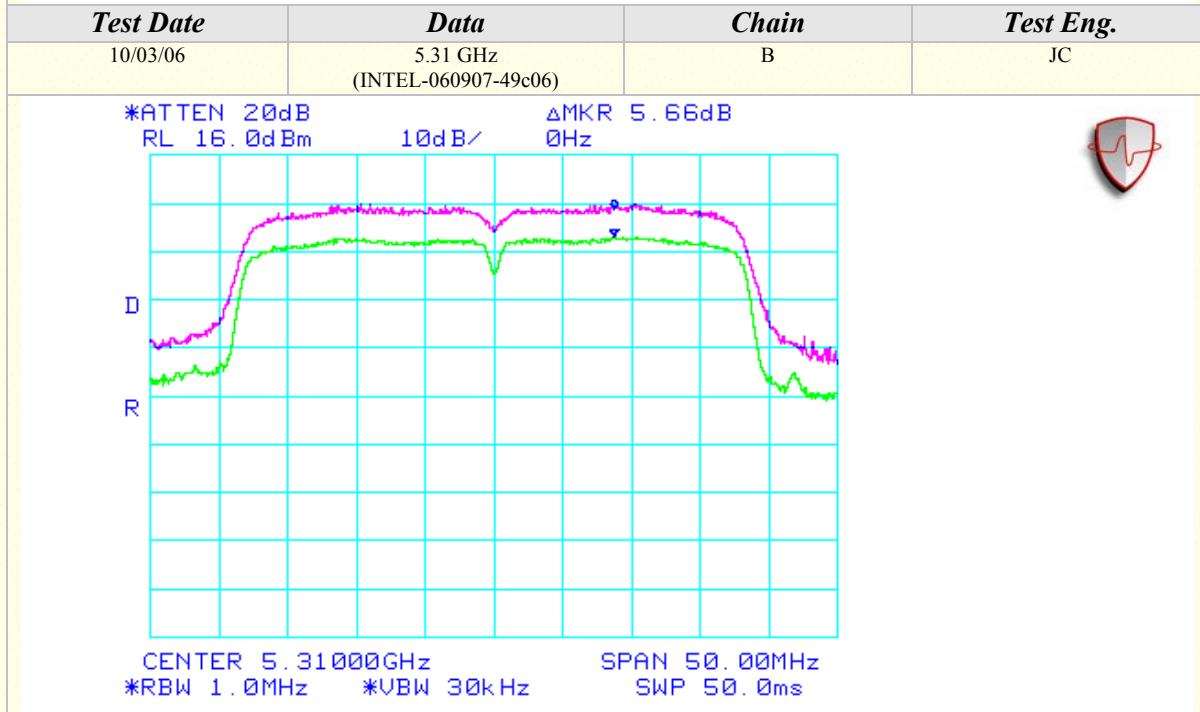
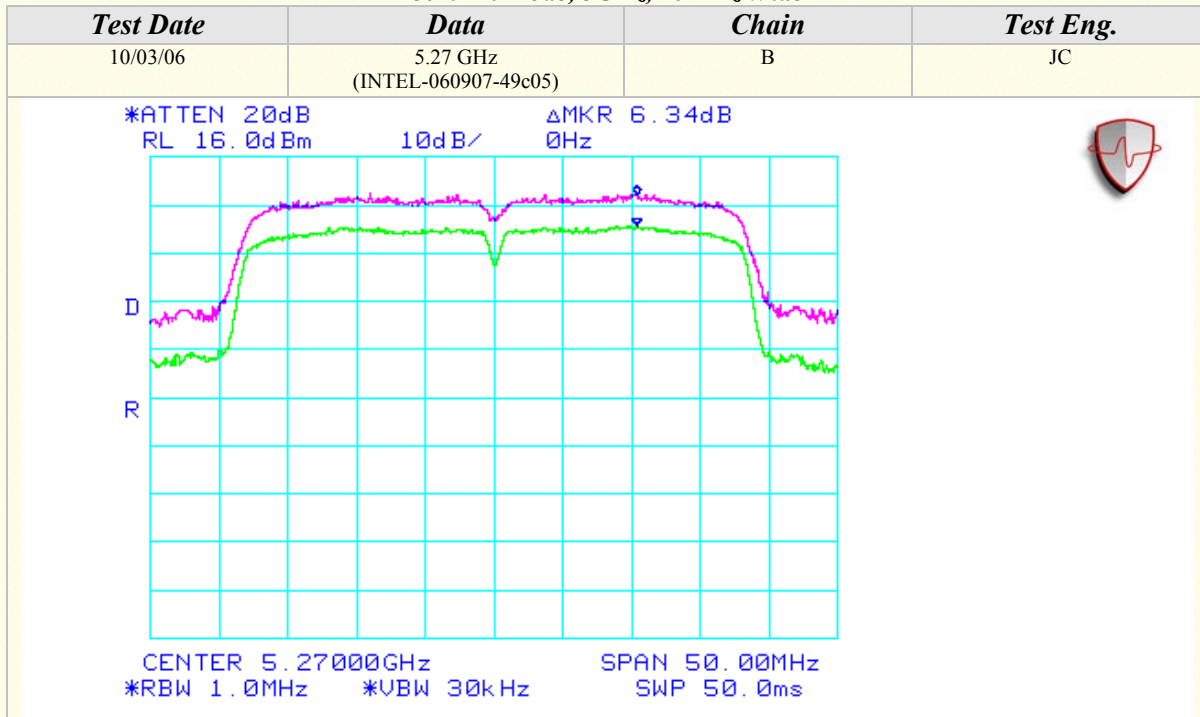





## CONDUCTED OUT OF BAND EMISSIONS

<b>CLIENT:</b>	Intel Corporation	<b>DATE:</b>	09/20/06
<b>EUT:</b>	Intel PRO/Wireless 4965AGN Network Connection	<b>PROJECT NUMBER:</b>	INTEL-060907
<b>MODEL NUMBER:</b>	4965AGN	<b>TEST ENGINEER:</b>	JC
<b>SERIAL NUMBER:</b>	0013E804612B	<b>SITE #:</b>	2
<b>CONFIGURATION:</b>	Tested installed in the host computer's mini PCI slot.	<b>TEMPERATURE:</b>	21 deg. C
		<b>HUMIDITY:</b>	42% RH
		<b>TIME:</b>	9:15 AM

<b>Description:</b>	<p>For transmitters operating in the 5.15-5.25 GHz band: all emissions outside of the 5.15-5.35 GHz band shall not exceed an EIRP of -27 dBm/MHz.</p> <p>For transmitters operating in the 5.25-5.35 GHz band: all emissions outside of the 5.15-5.35 GHz band shall not exceed an EIRP of -27 dBm/MHz. Devices operating in the 5.25-5.35 GHz band that generate emissions in the 5.15-5.25 GHz band must meet all applicable technical requirements for operation in the 5.15-5.25 GHz band (including indoor use) or alternatively meet an out-of-band emission EIRP limit of -27 dBm/MHz in the 5.15-5.25 GHz band.</p>
<b>Results:</b>	See Data Sheet
<b>Note:</b>	<p>Conducted Emissions Measurements were performed on the EUT with power supply set at the following voltage and frequency.</p> <ul style="list-style-type: none"><li>• 120VAC / 60 Hz.</li></ul>





Conducted Out Of Band Emissions (Continued)

802.11a Mode

Test Date	Data	Chain	Test Eng.
09/20/06	5.18 GHz (INTEL-060907-25e03)	A	JC

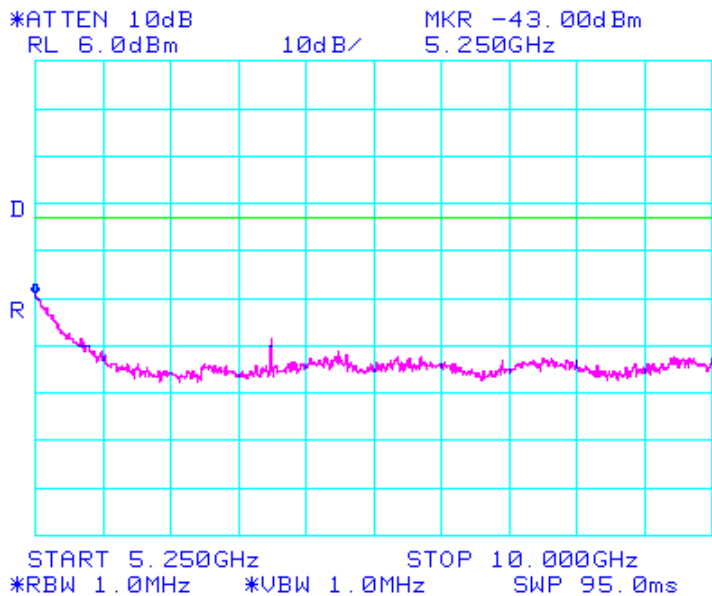

Test Date	Data	Chain	Test Eng.
09/20/06	5.18 GHz (INTEL-060907-25e04)	A	JC

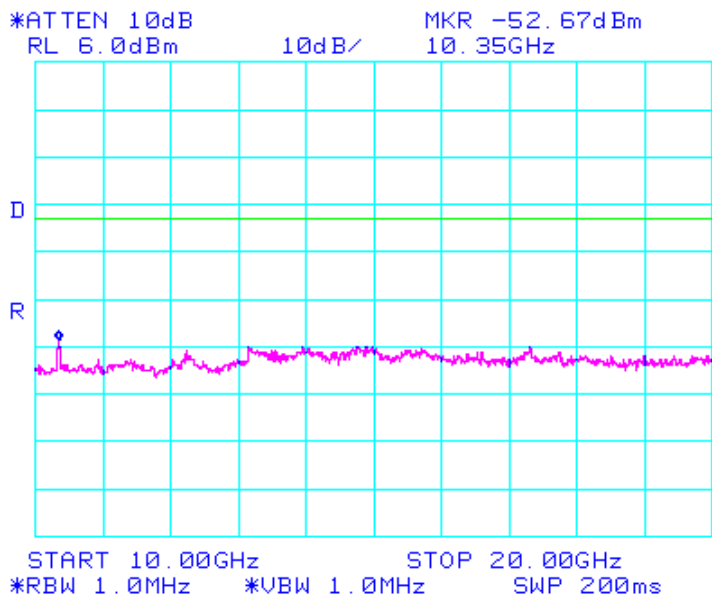







Conducted Out Of Band Emissions (Continued)

802.11a Mode

Test Date	Data	Chain	Test Eng.
09/20/06	5.26 GHz (INTEL-060907-25e09)	A	JC

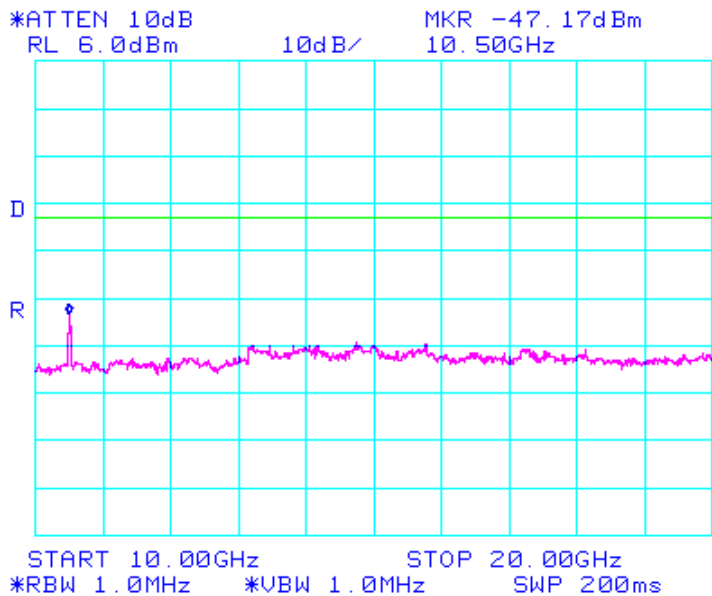

Test Date	Data	Chain	Test Eng.
09/20/06	5.26 GHz (INTEL-060907-25e10)	A	JC

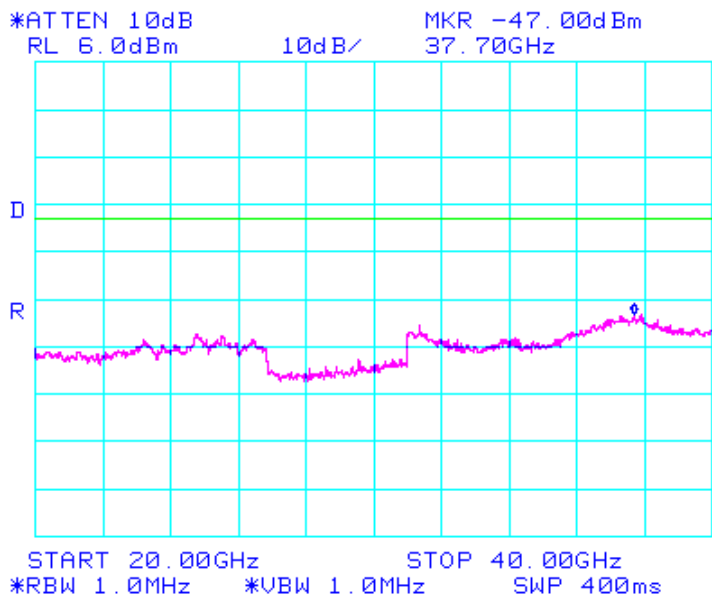



Conducted Out Of Band Emissions (Continued)

802.11a Mode

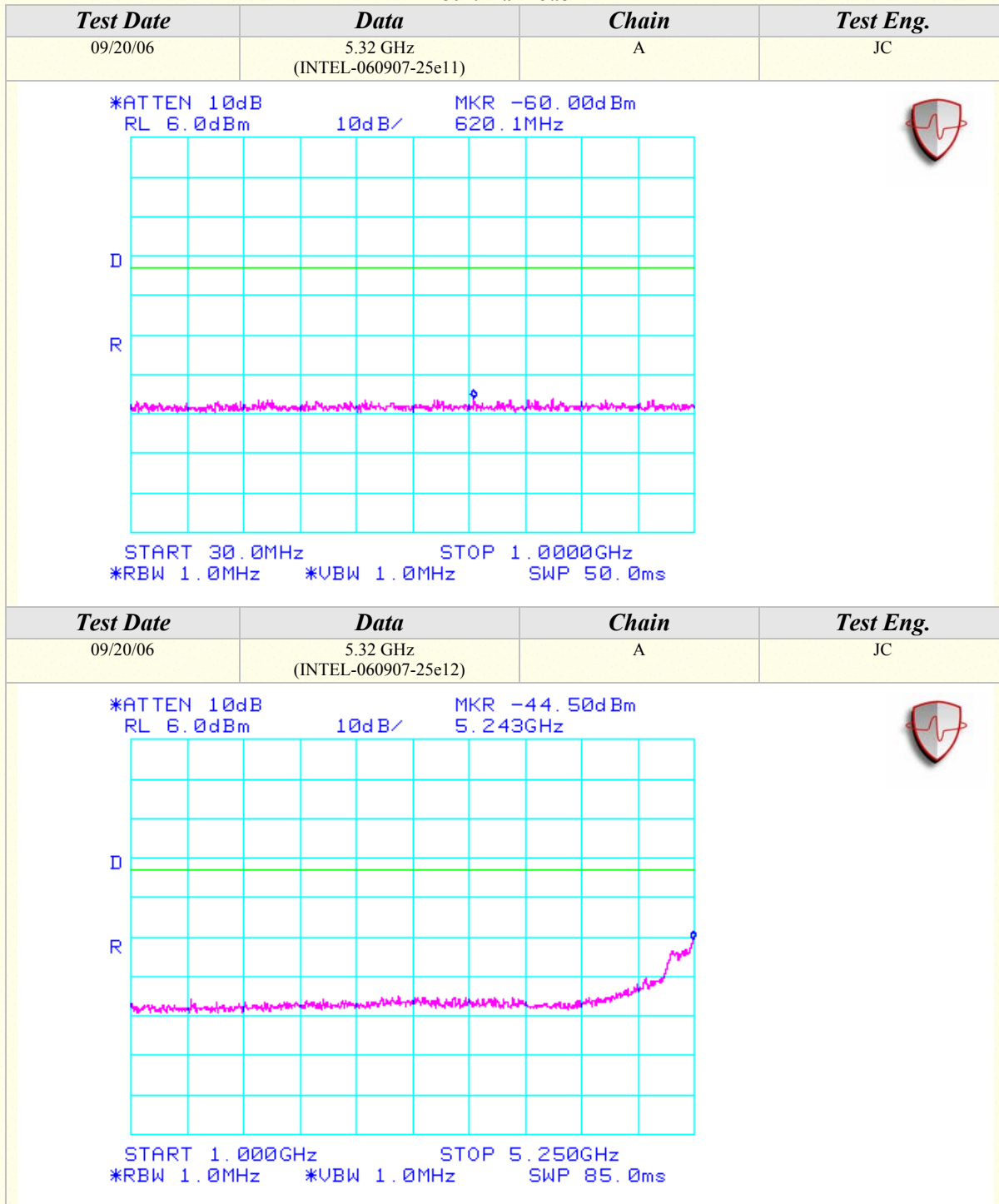

Conducted Out Of Band Emissions (Continued)

802.11a Mode

Test Date	Data	Chain	Test Eng.
09/20/06	5.32 GHz (INTEL-060907-25e13)	A	JC

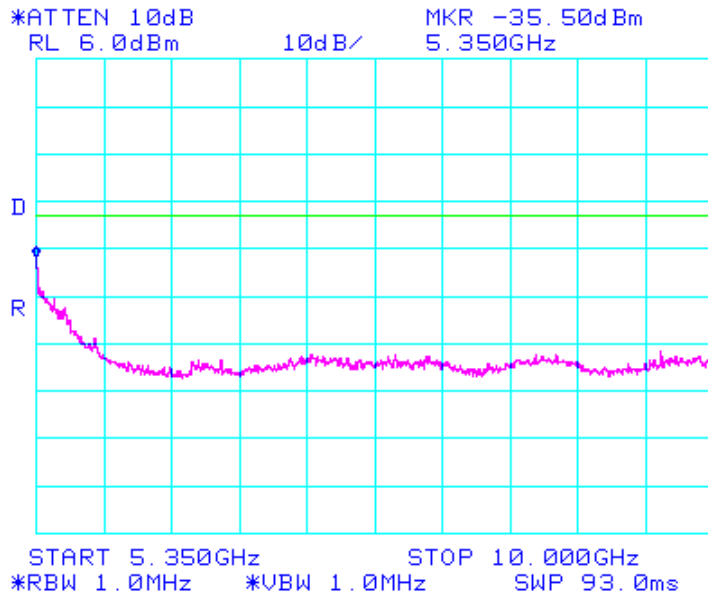

Test Date	Data	Chain	Test Eng.
09/20/06	5.32 GHz (INTEL-060907-25e14)	A	JC

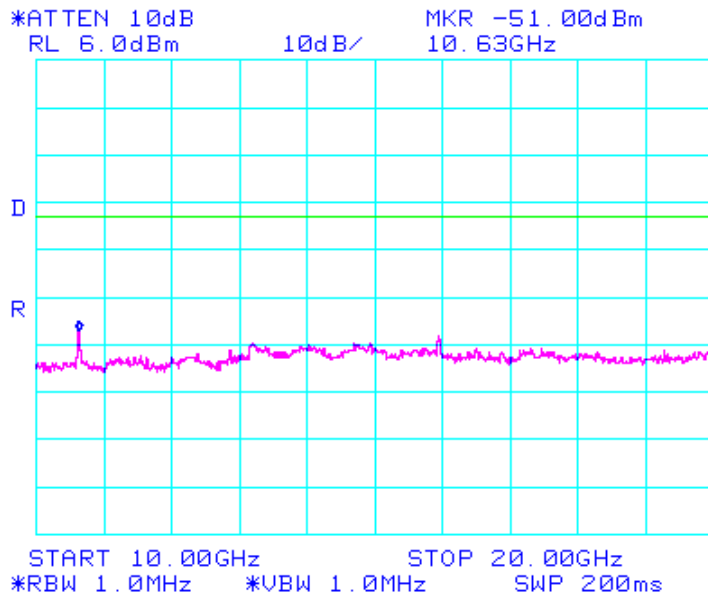





Conducted Out Of Band Emissions (Continued)

802.11a Mode

Test Date	Data	Chain	Test Eng.
09/20/06	5.18 GHz (INTEL-060907-25e17)	B	JC

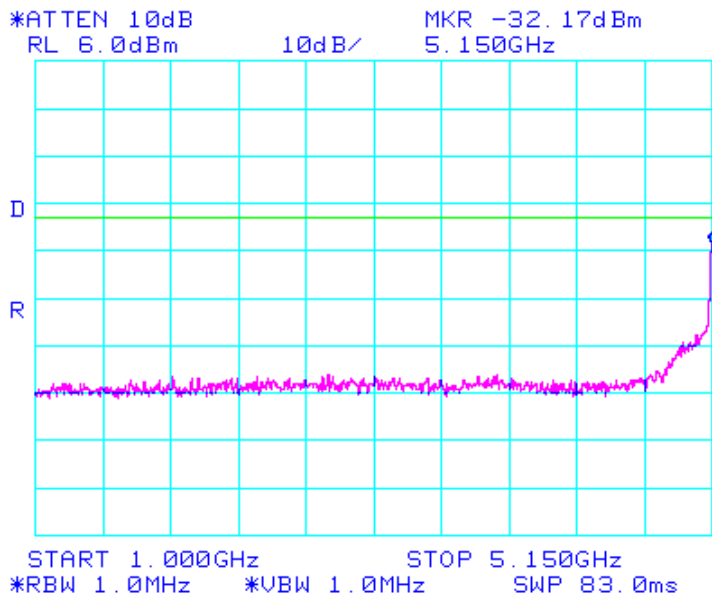

Test Date	Data	Chain	Test Eng.
09/20/06	5.18 GHz (INTEL-060907-25e18)	B	JC

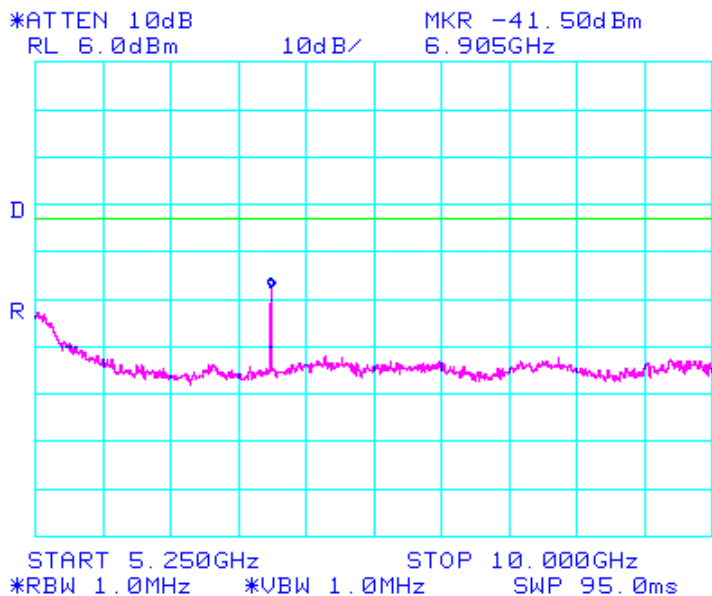



Conducted Out Of Band Emissions (Continued)

802.11a Mode

Test Date	Data	Chain	Test Eng.
09/20/06	5.18 GHz (INTEL-060907-25e19)	B	JC

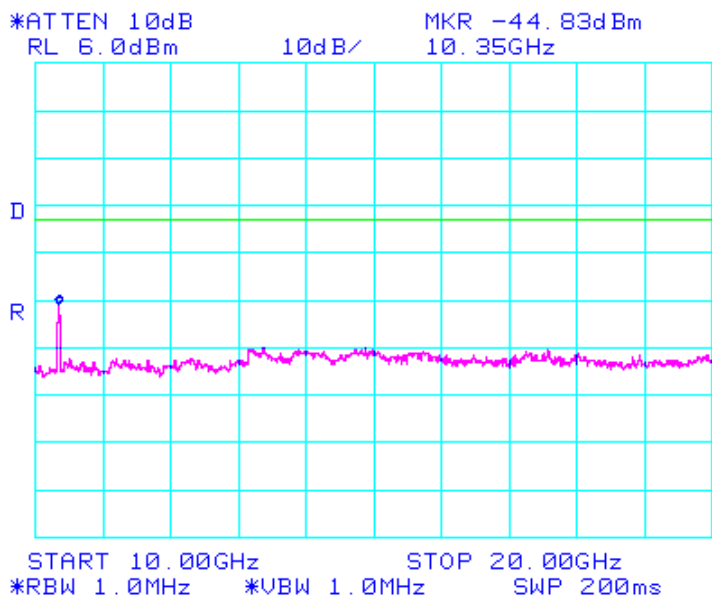

Test Date	Data	Chain	Test Eng.
09/20/06	5.18 GHz (INTEL-060907-25e20)	B	JC

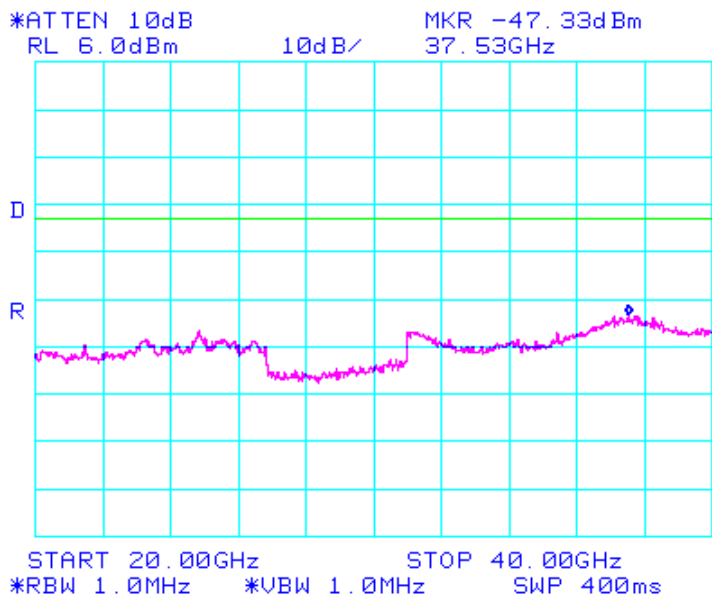





Conducted Out Of Band Emissions (Continued)

802.11a Mode

Test Date	Data	Chain	Test Eng.
09/20/06	5.26 GHz (INTEL-060907-25e23)	B	JC

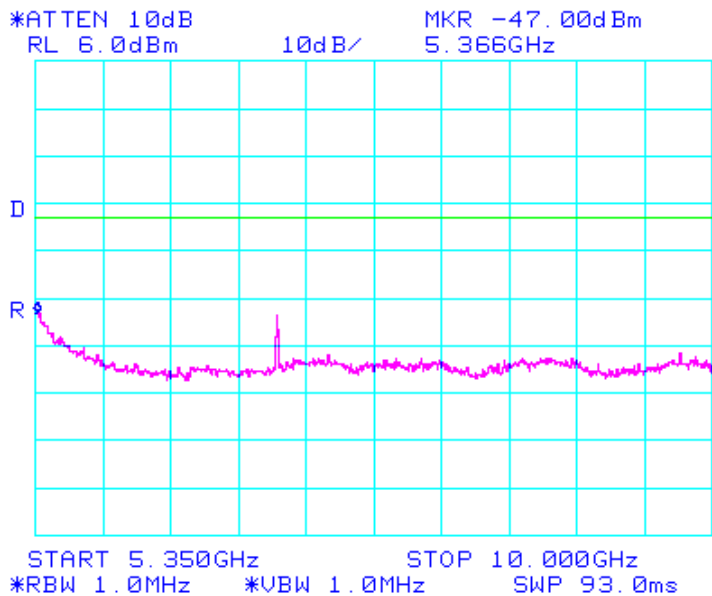

Test Date	Data	Chain	Test Eng.
09/20/06	5.26 GHz (INTEL-060907-25e24)	B	JC

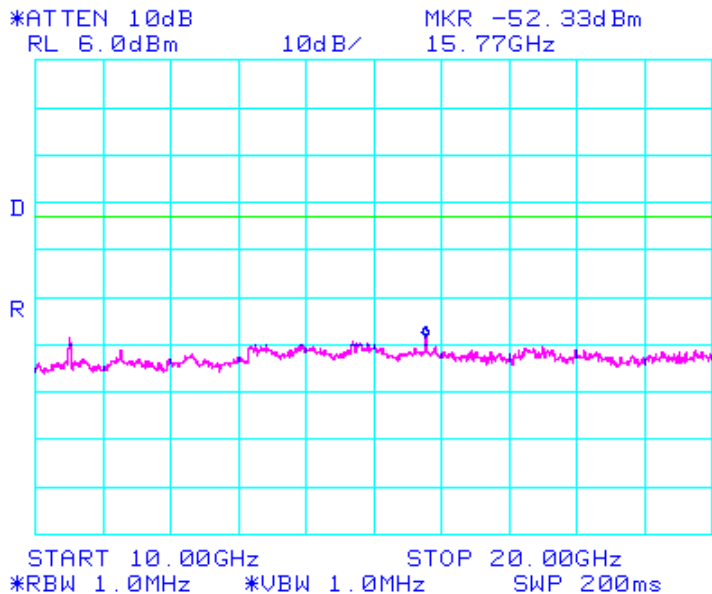

Conducted Out Of Band Emissions (Continued)

802.11a Mode

Test Date	Data	Chain	Test Eng.
09/20/06	5.26 GHz (INTEL-060907-25e25)	B	JC

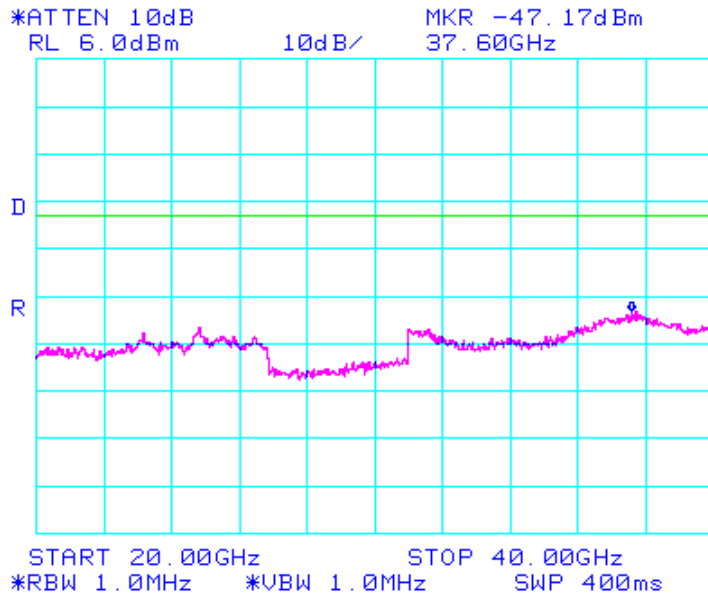

Test Date	Data	Chain	Test Eng.
09/20/06	5.32 GHz (INTEL-060907-25e26)	B	JC

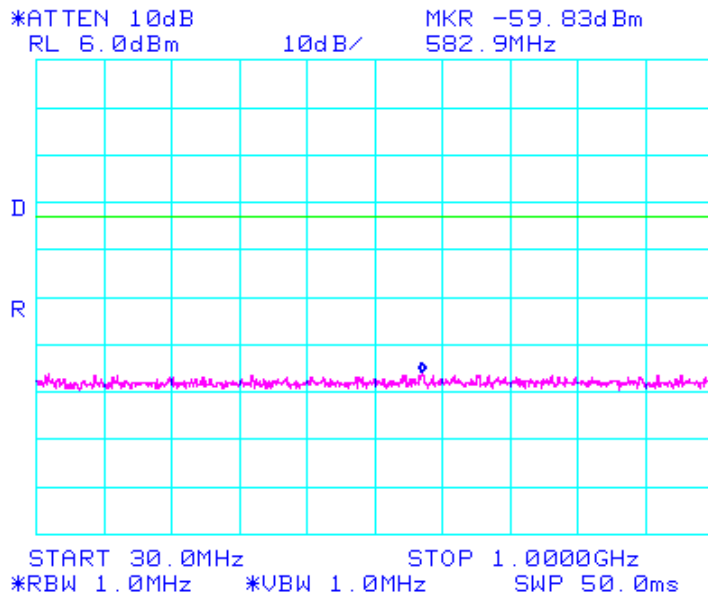



Conducted Out Of Band Emissions (Continued)

802.11a Mode

Test Date	Data	Chain	Test Eng.
09/20/06	5.32 GHz (INTEL-060907-25e27)	B	JC

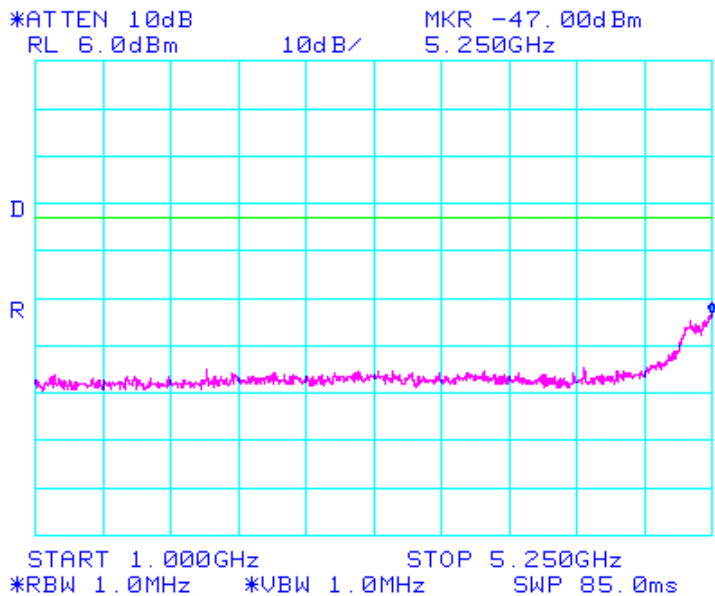

Test Date	Data	Chain	Test Eng.
09/20/06	5.32 GHz (INTEL-060907-25e28)	B	JC

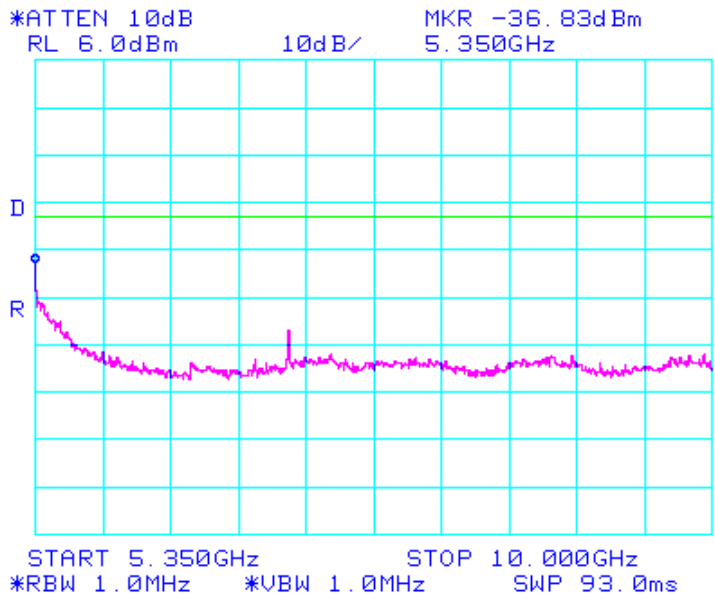





Conducted Out Of Band Emissions (Continued)

802.11n Mode, 5GHz, 20MHz Wide

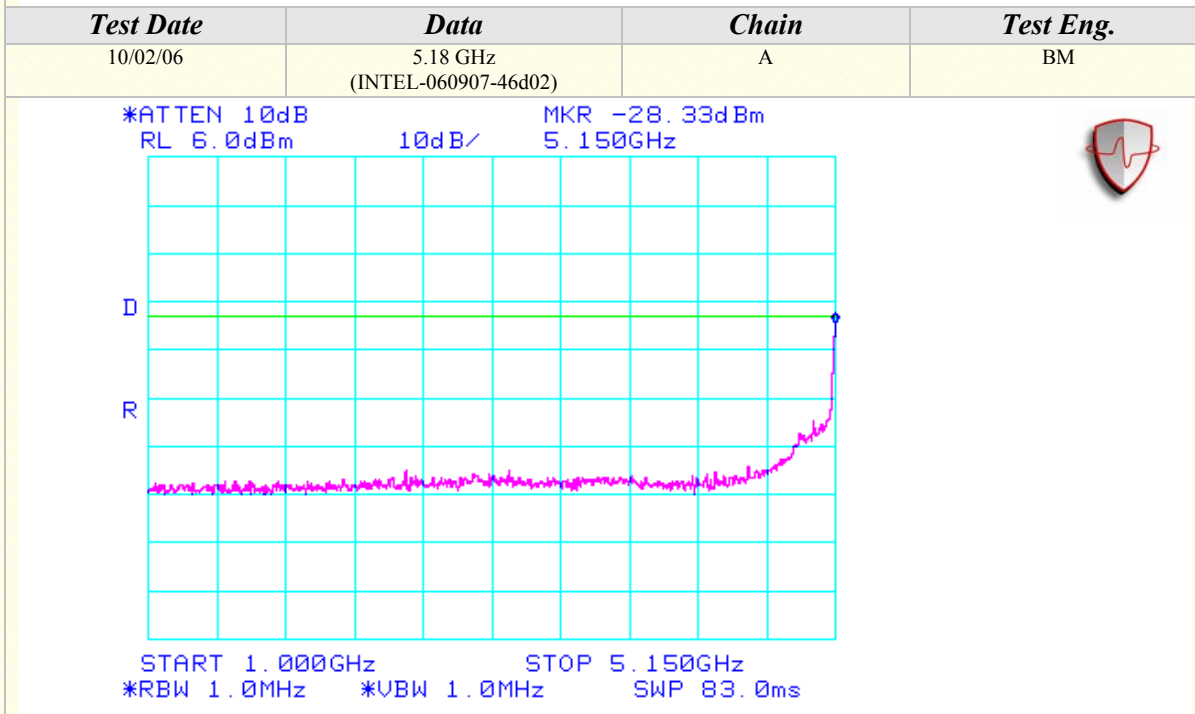
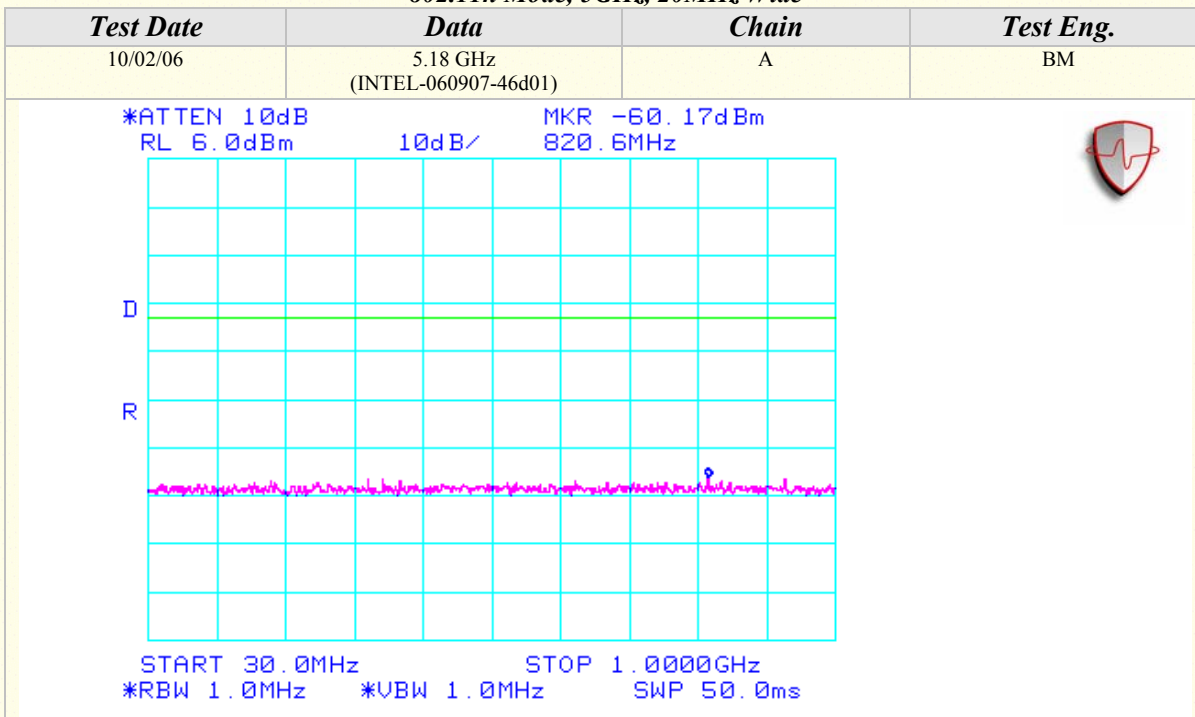

Conducted Out Of Band Emissions (Continued)

802.11n Mode, 5GHz, 20MHz Wide

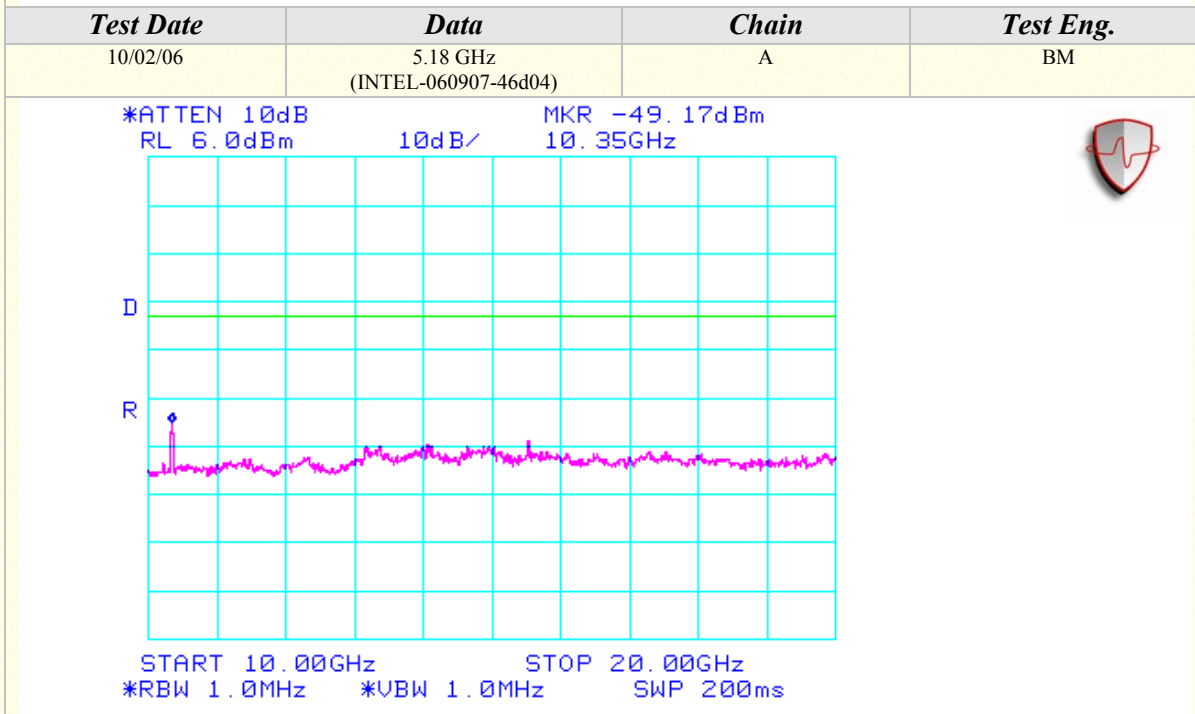
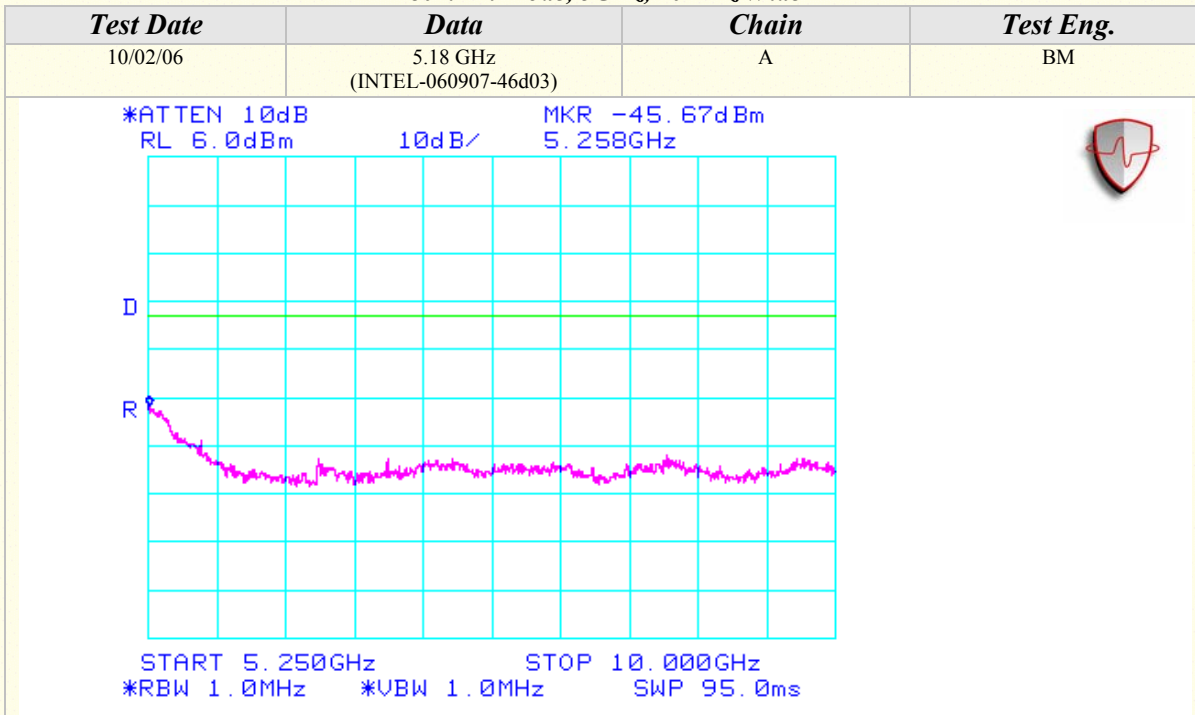



Conducted Out Of Band Emissions (Continued)

802.11n Mode, 5GHz, 20MHz Wide

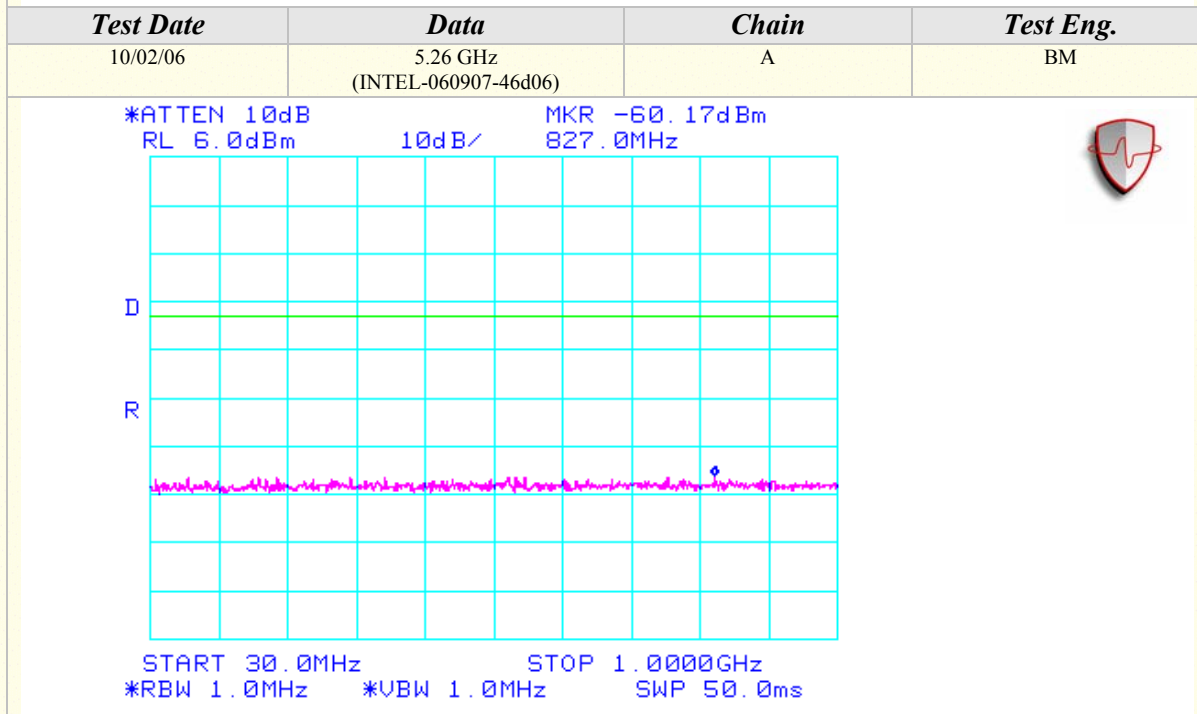
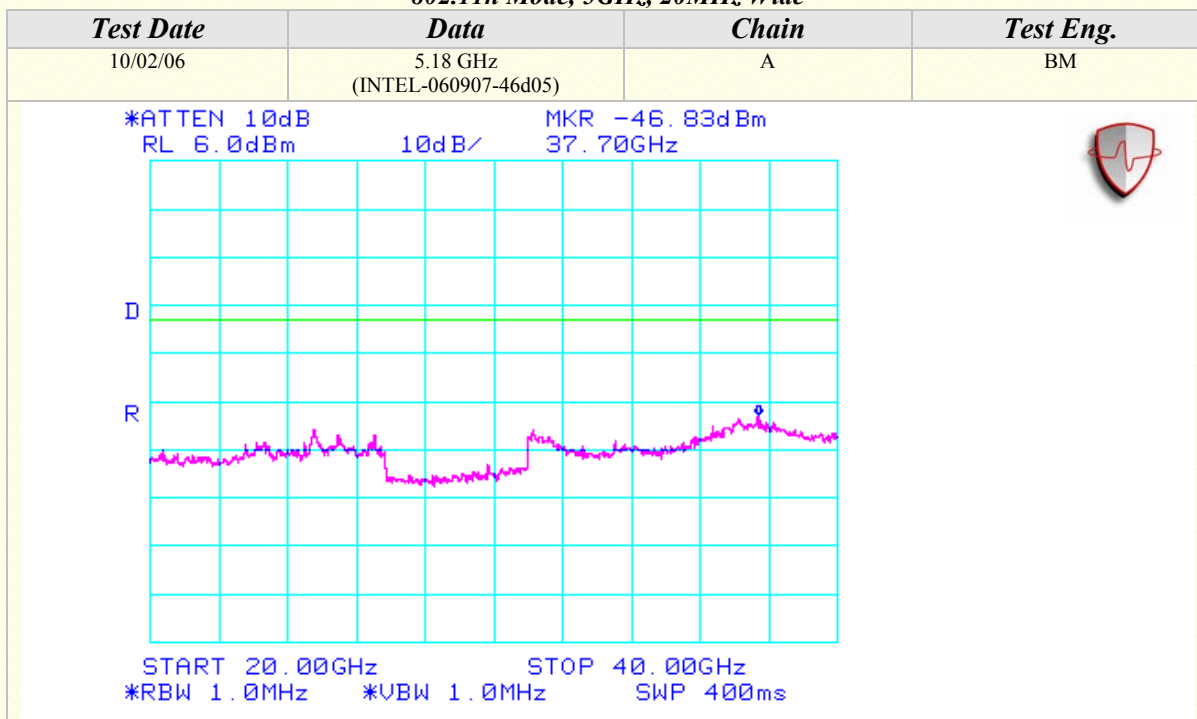

Conducted Out Of Band Emissions (Continued)

802.11n Mode, 5GHz, 20MHz Wide

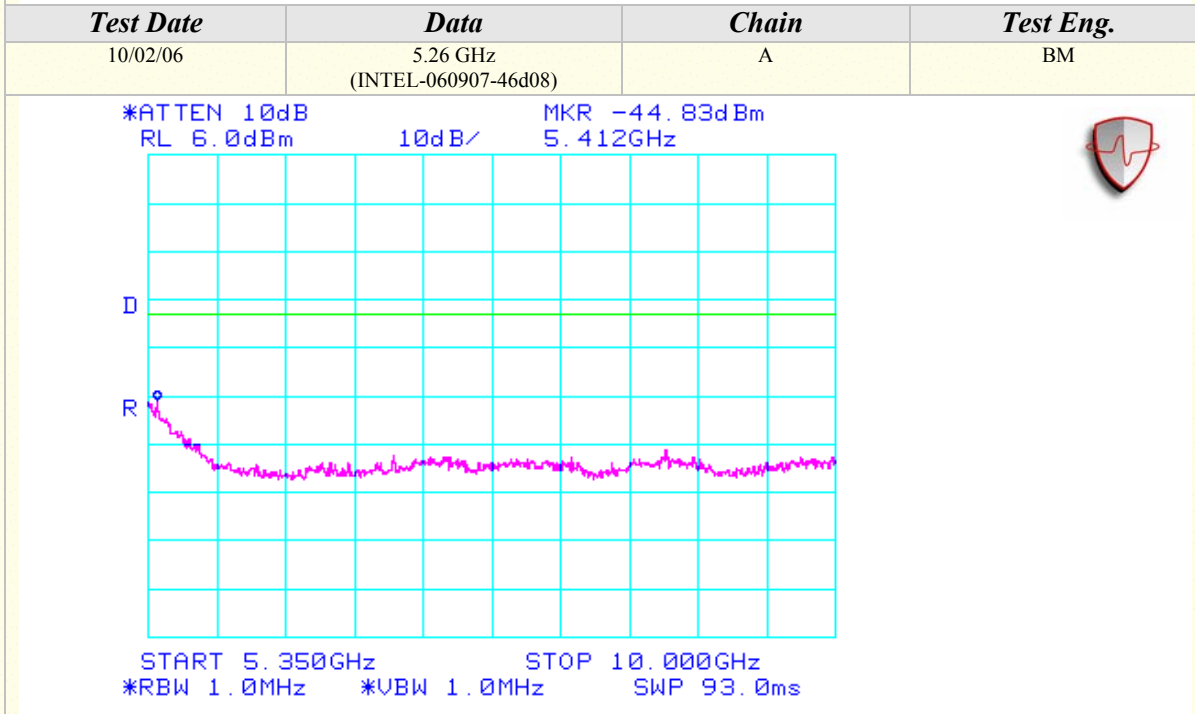
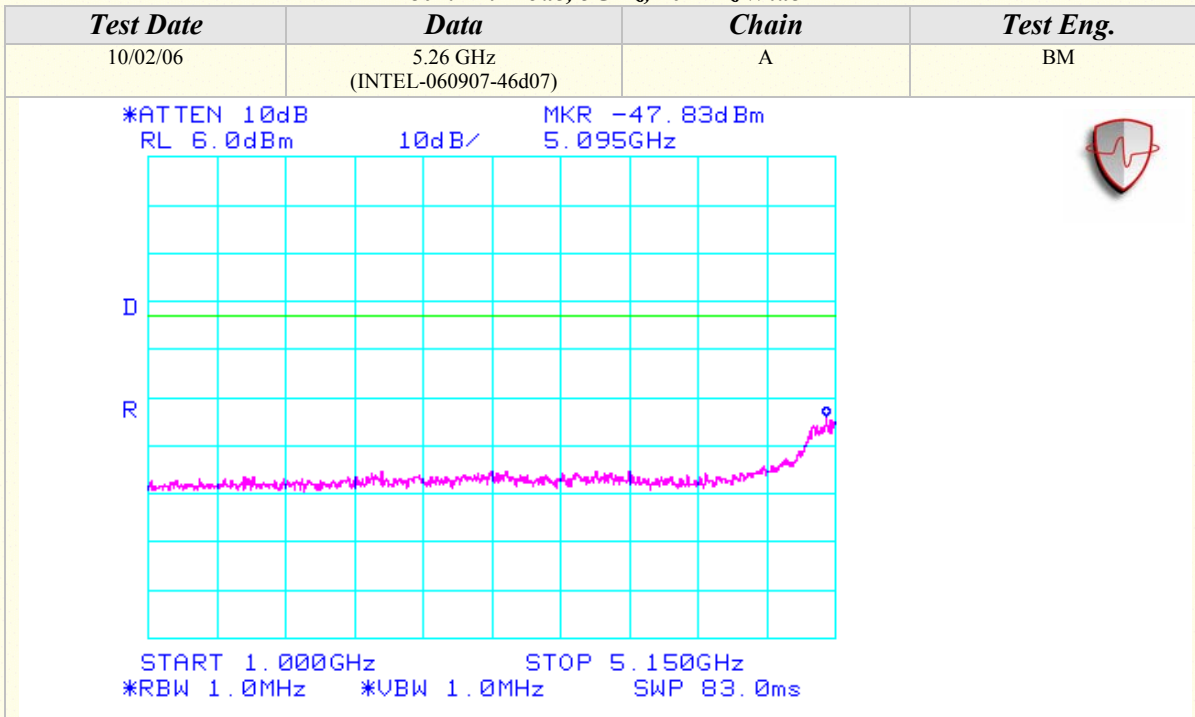



Conducted Out Of Band Emissions (Continued)

802.11n Mode, 5GHz, 20MHz Wide

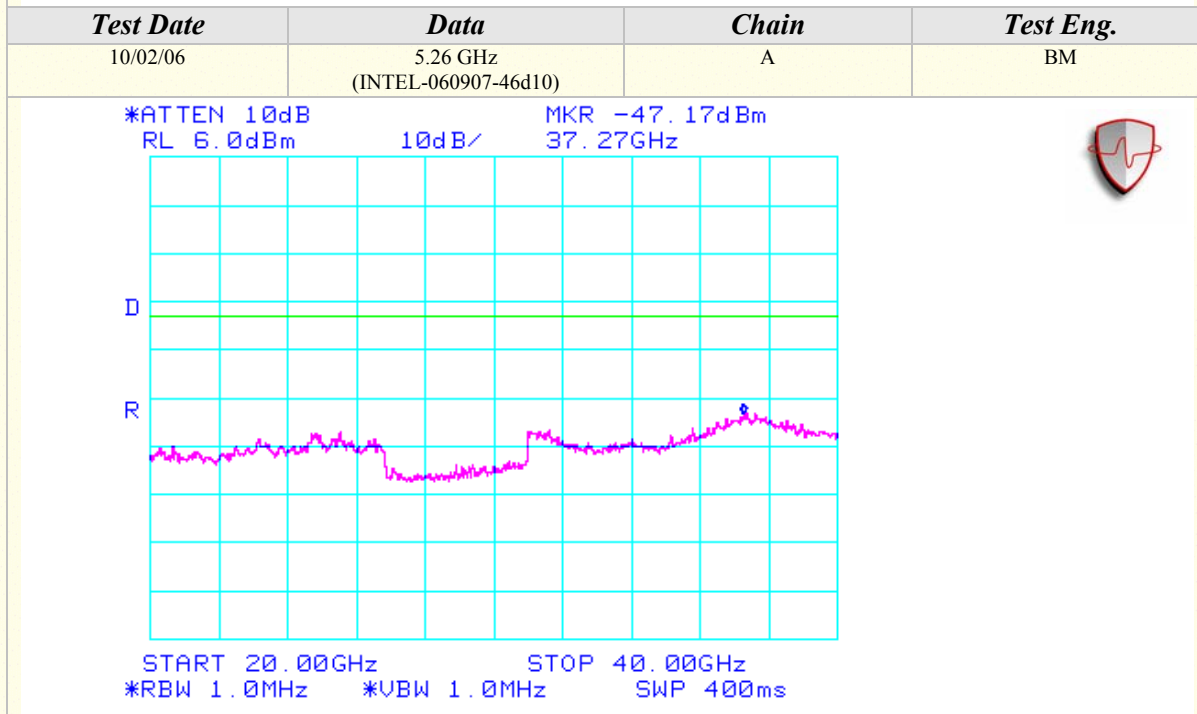
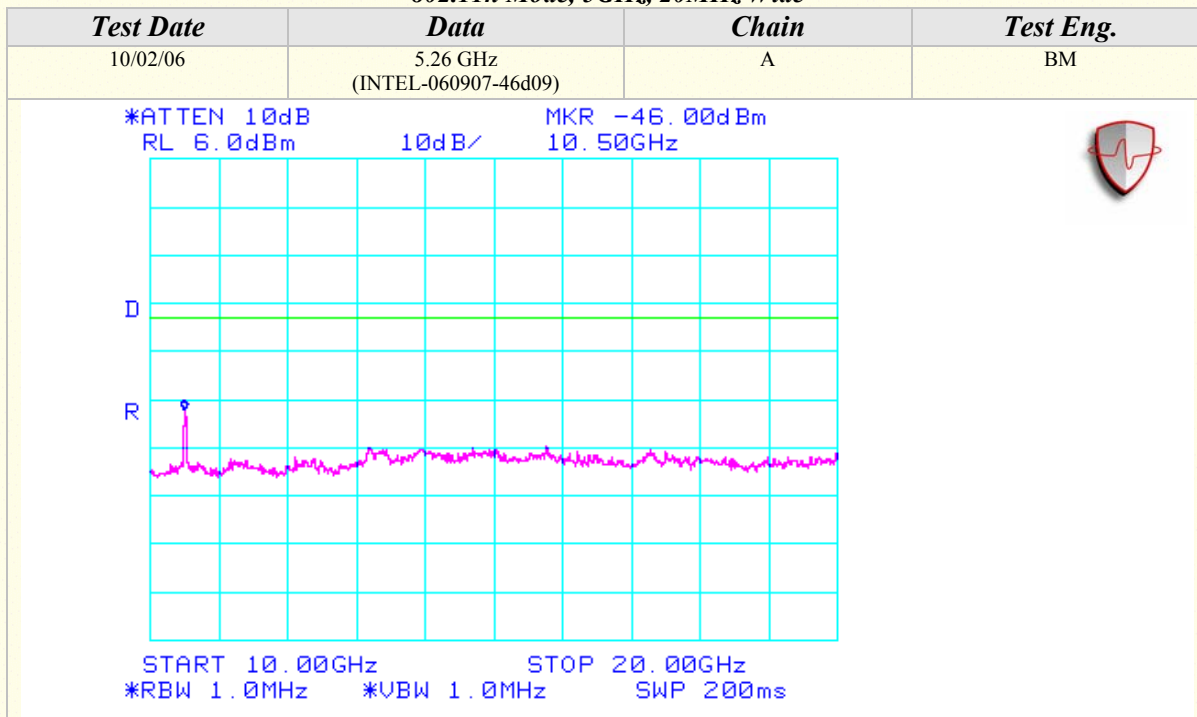





Conducted Out Of Band Emissions (Continued)

802.11n Mode, 5GHz, 20MHz Wide

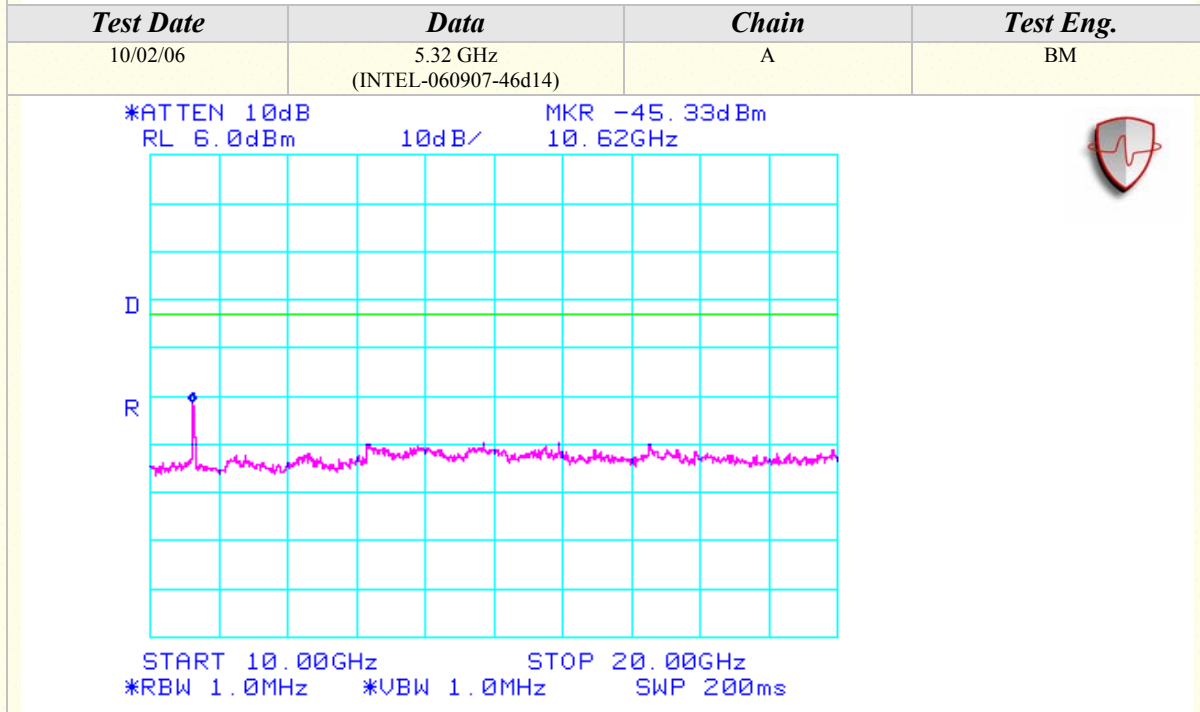
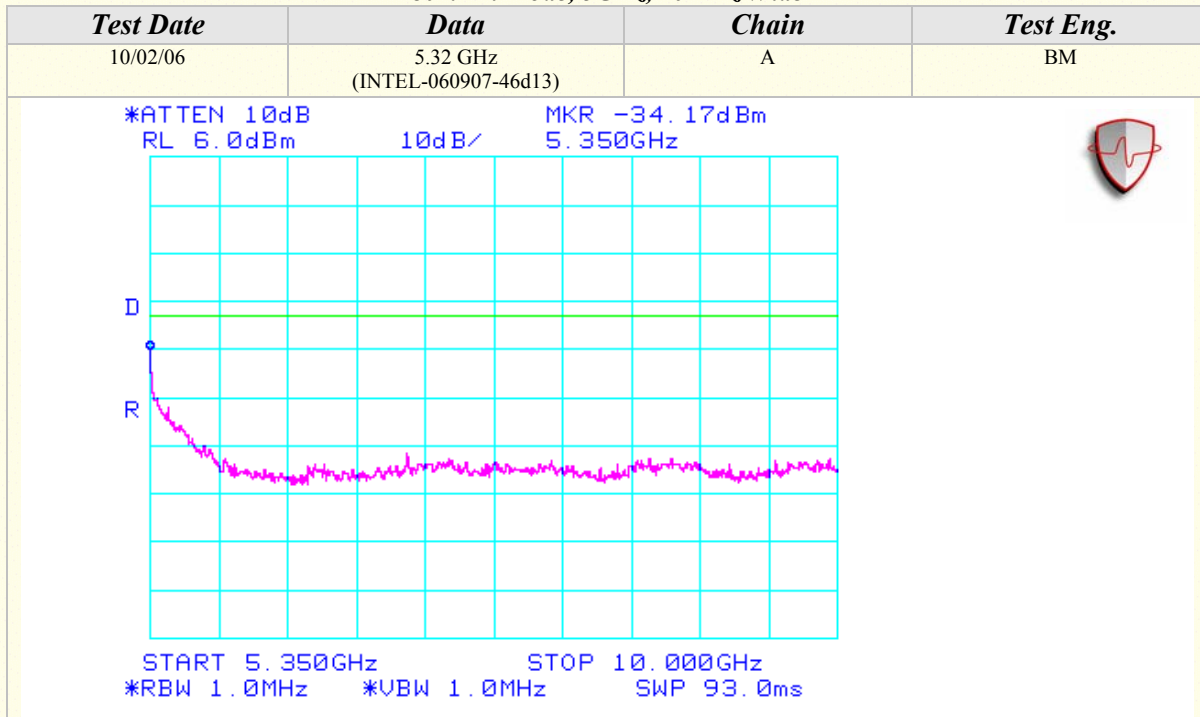

Conducted Out Of Band Emissions (Continued)

802.11n Mode, 5GHz, 20MHz Wide

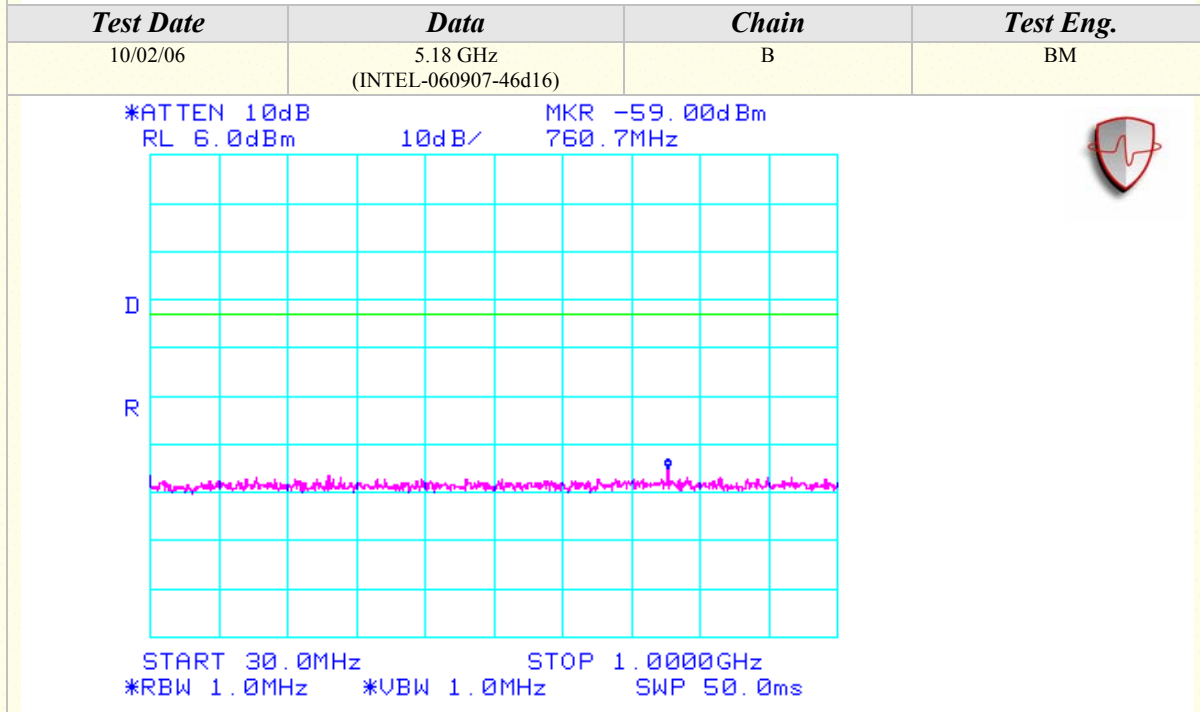
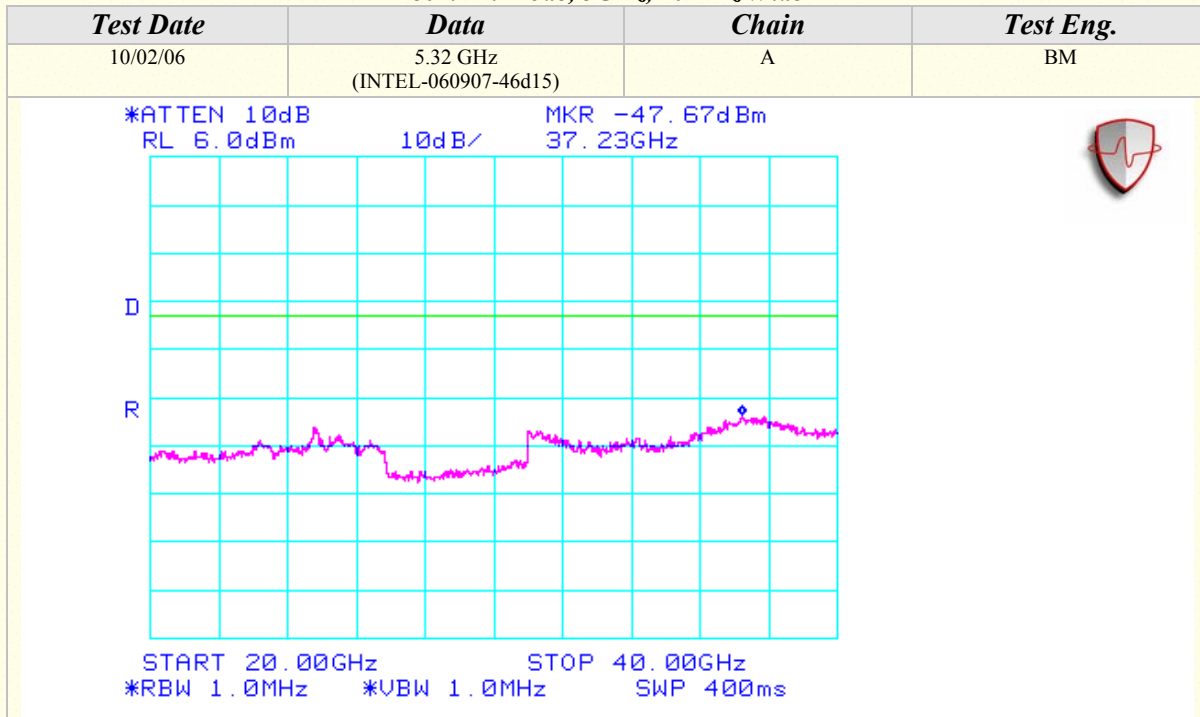



Conducted Out Of Band Emissions (Continued)

802.11n Mode, 5GHz, 20MHz Wide

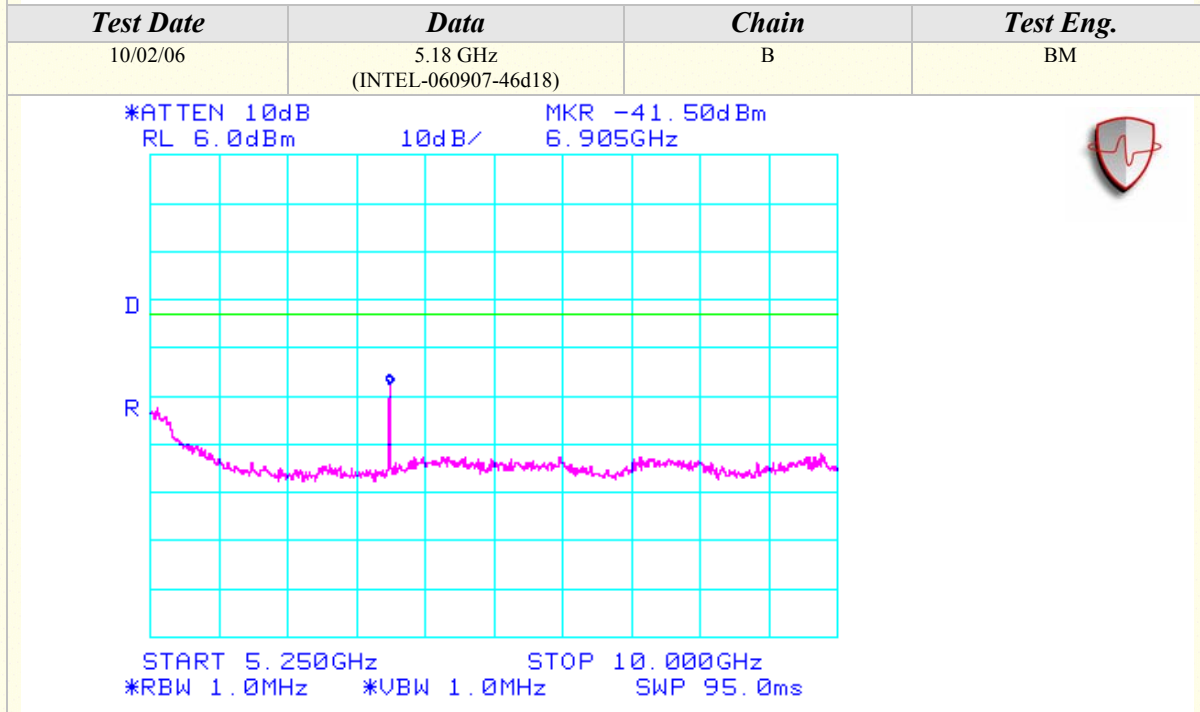
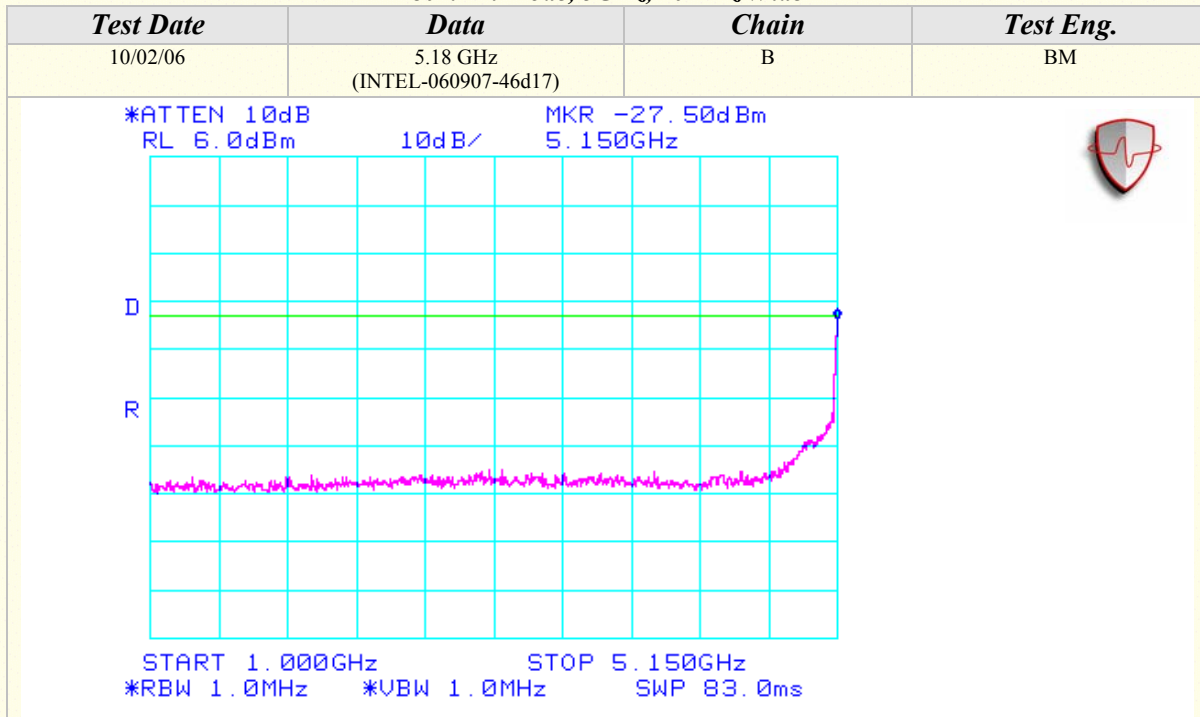

Conducted Out Of Band Emissions (Continued)

802.11n Mode, 5GHz, 20MHz Wide

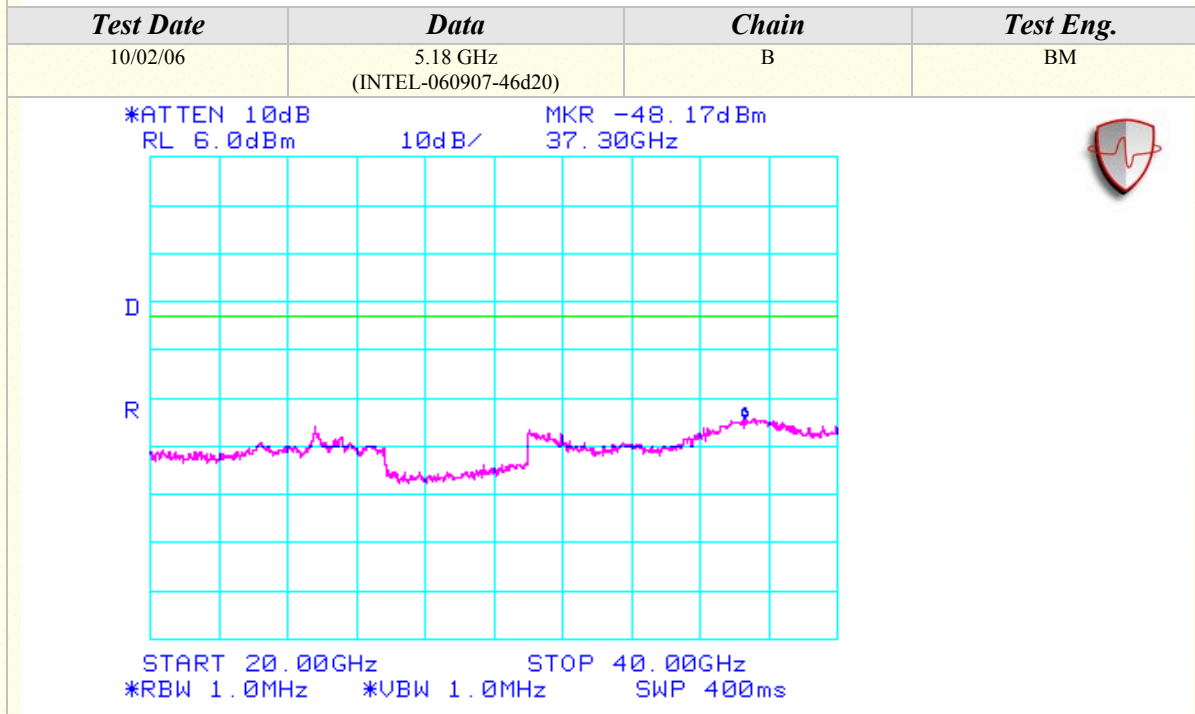
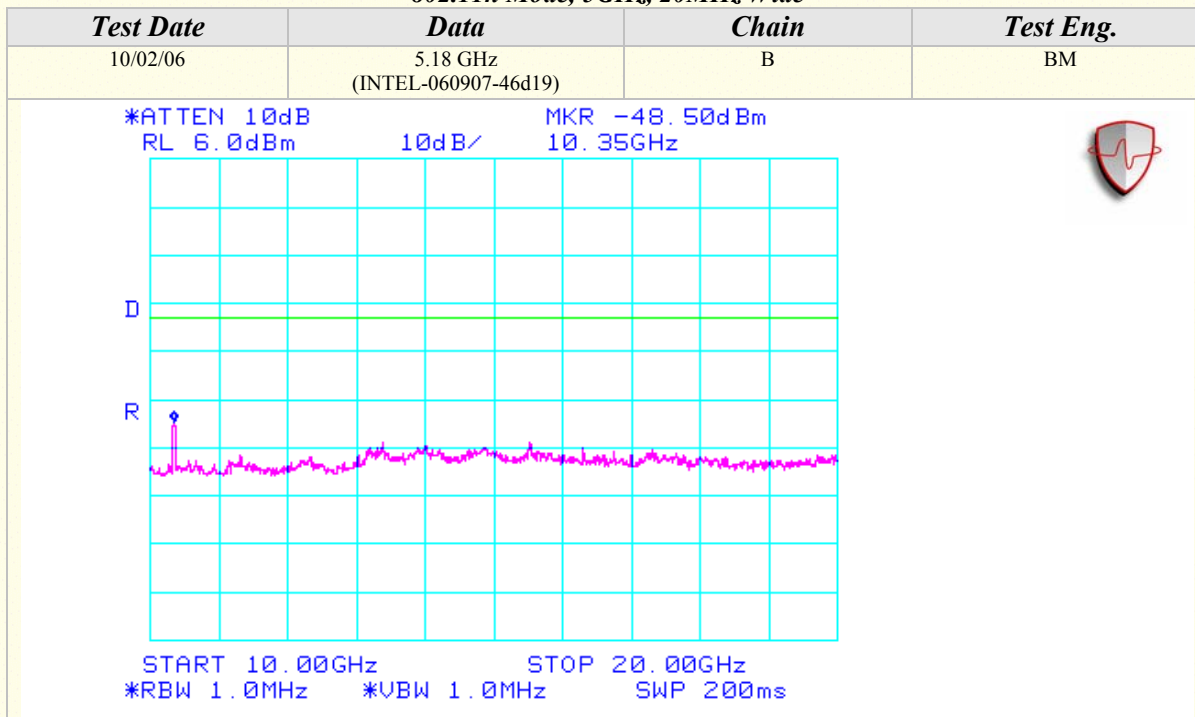



Conducted Out Of Band Emissions (Continued)

802.11n Mode, 5GHz, 20MHz Wide

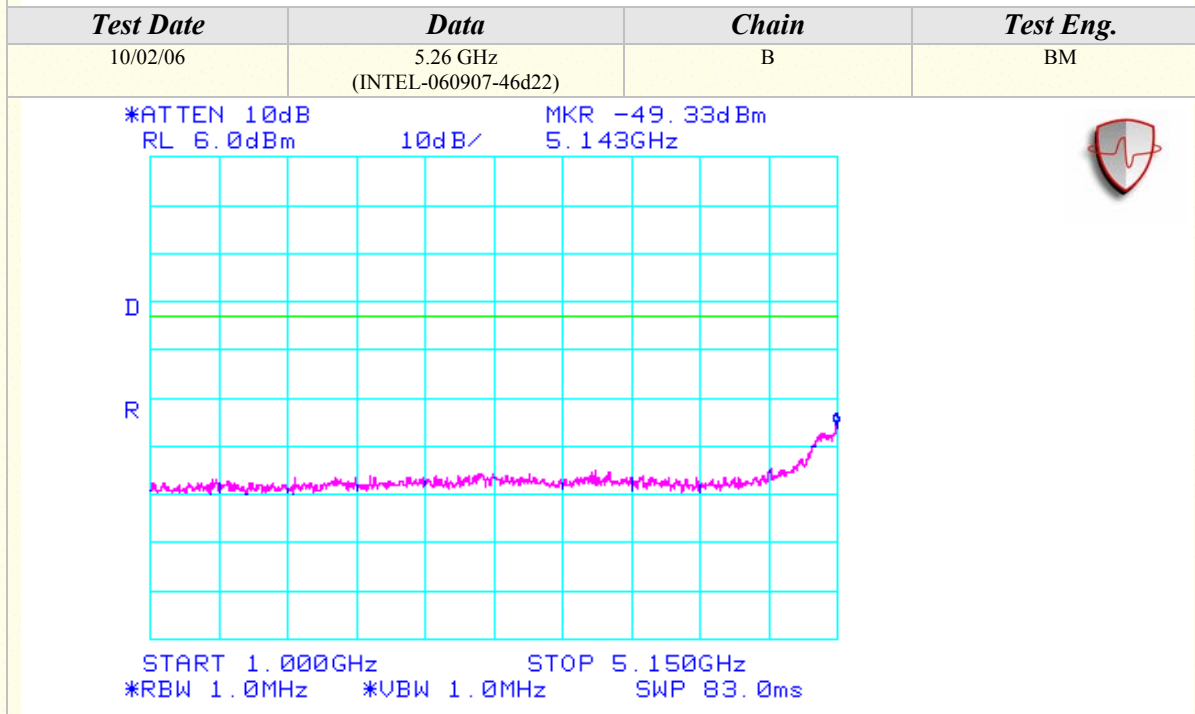
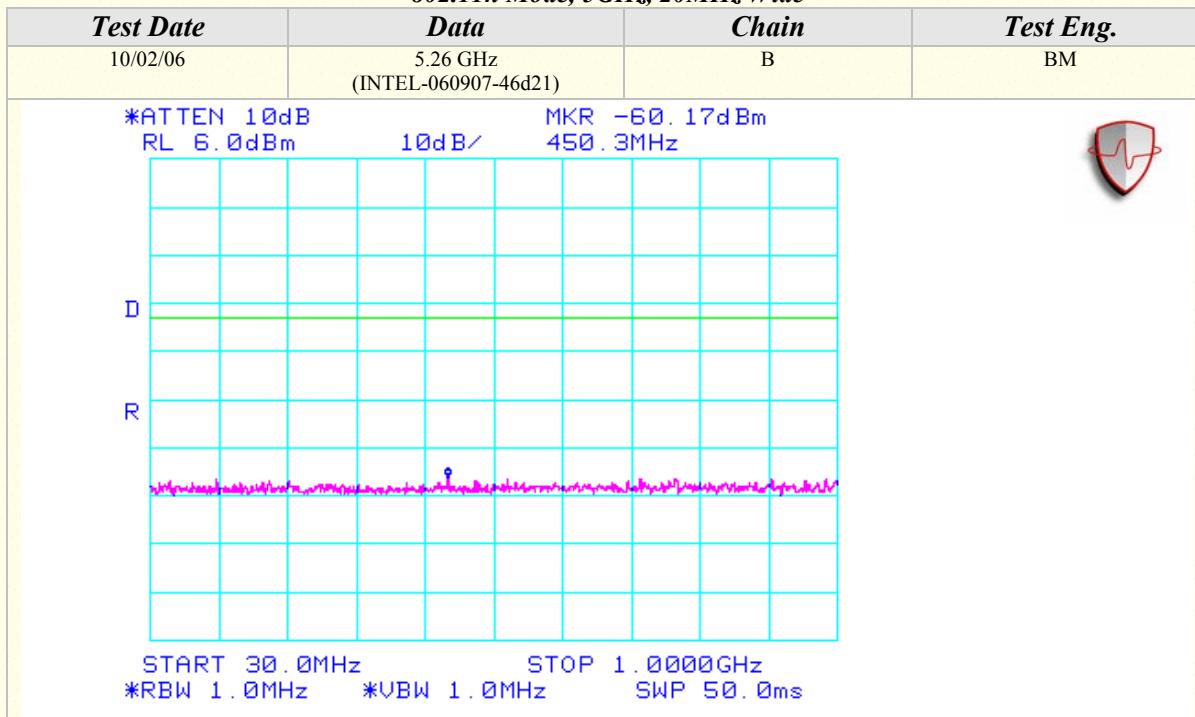

Conducted Out Of Band Emissions (Continued)

802.11n Mode, 5GHz, 20MHz Wide

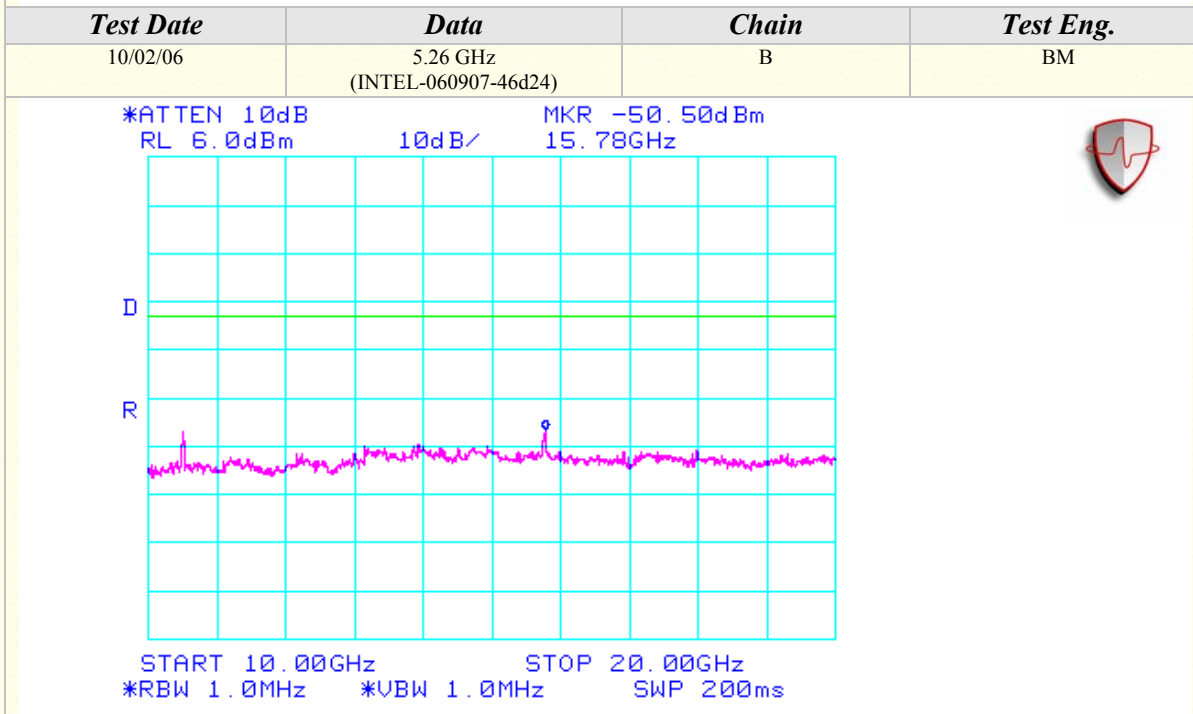
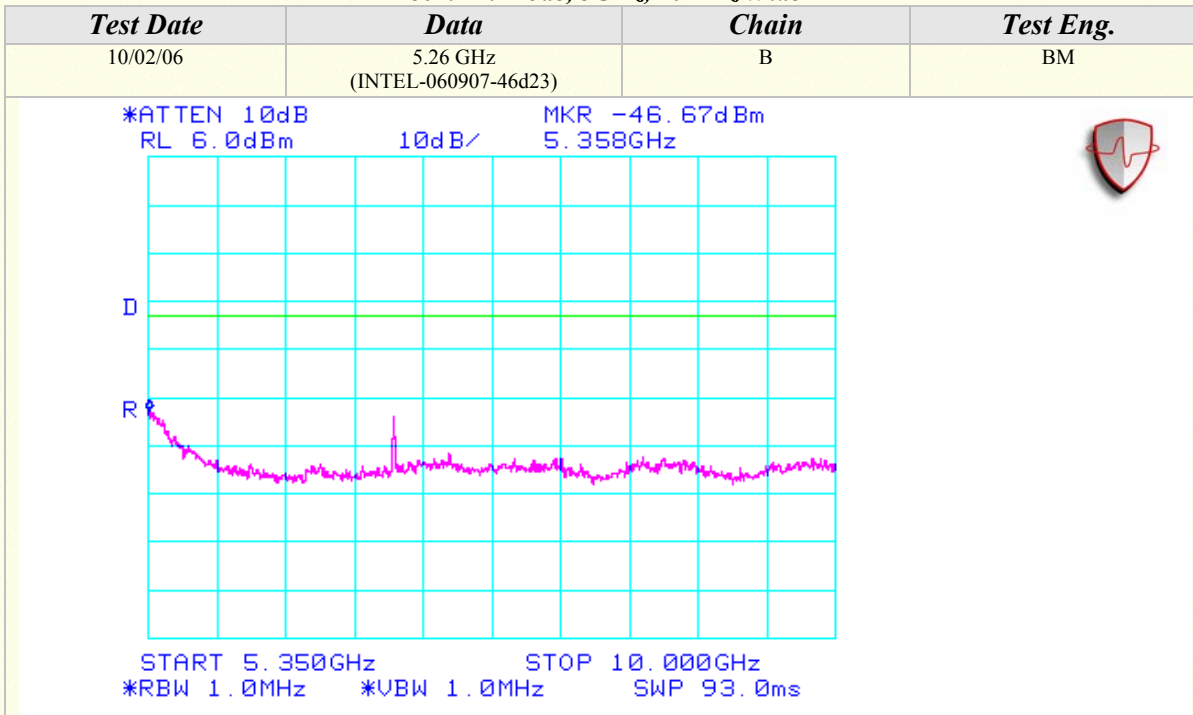



Conducted Out Of Band Emissions (Continued)

802.11n Mode, 5GHz, 20MHz Wide

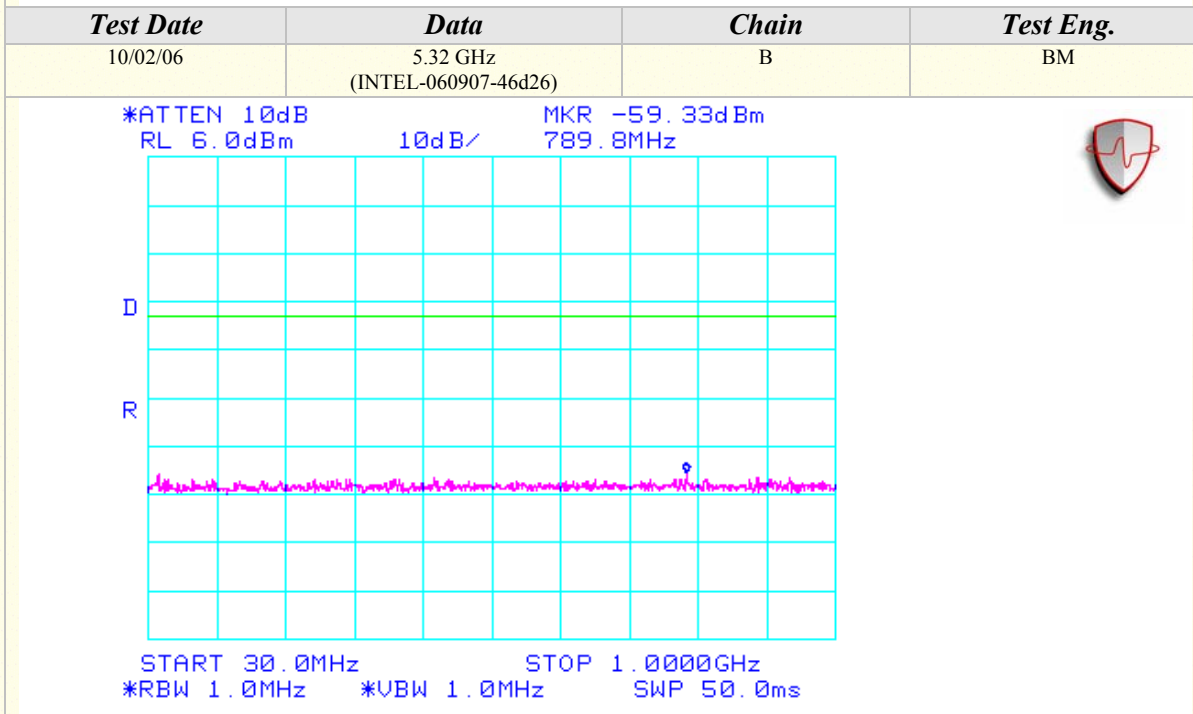
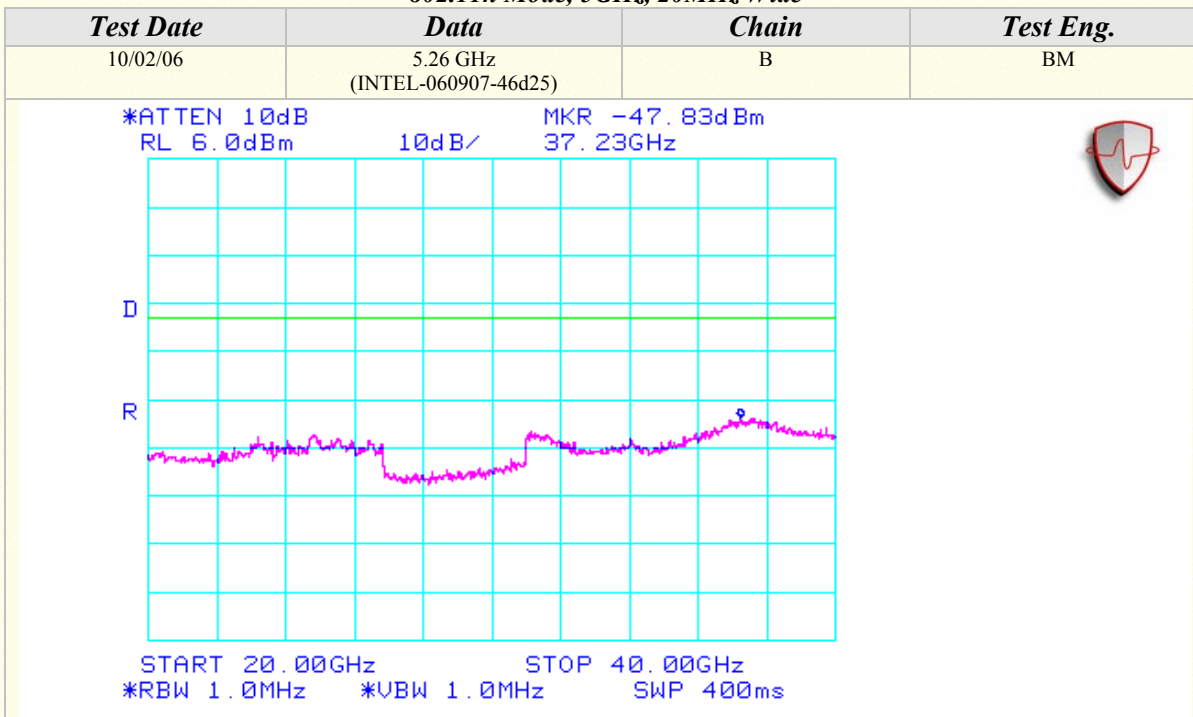

Conducted Out Of Band Emissions (Continued)

802.11n Mode, 5GHz, 20MHz Wide

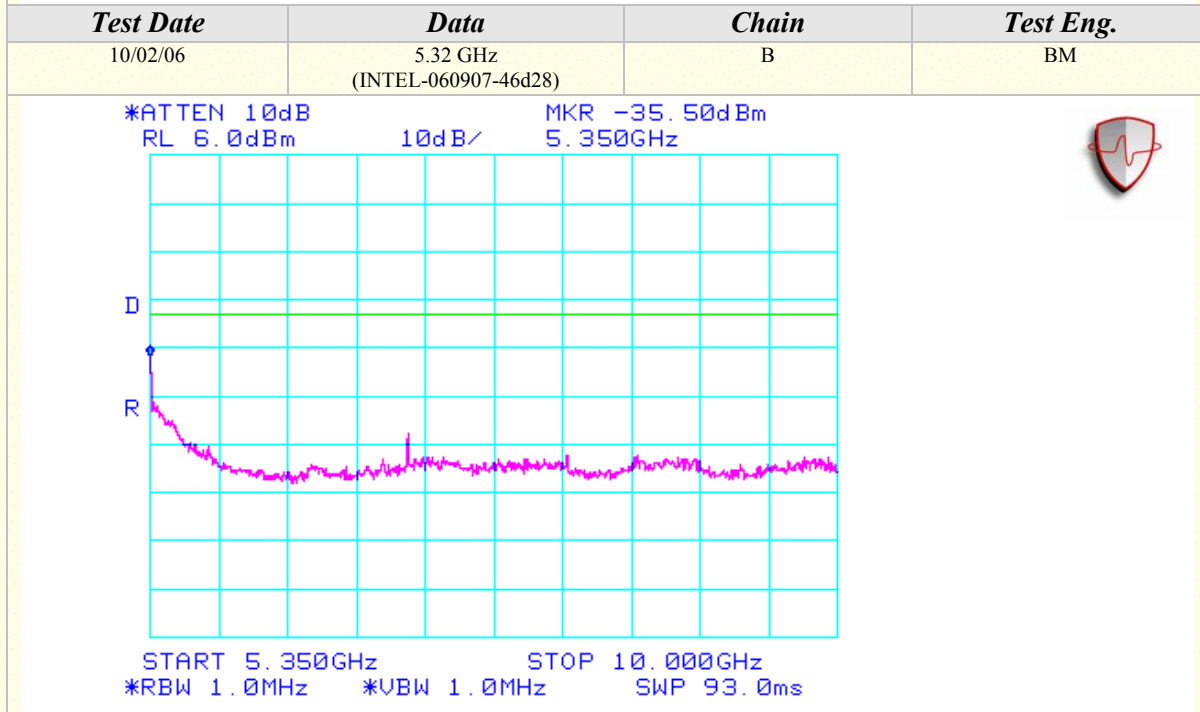
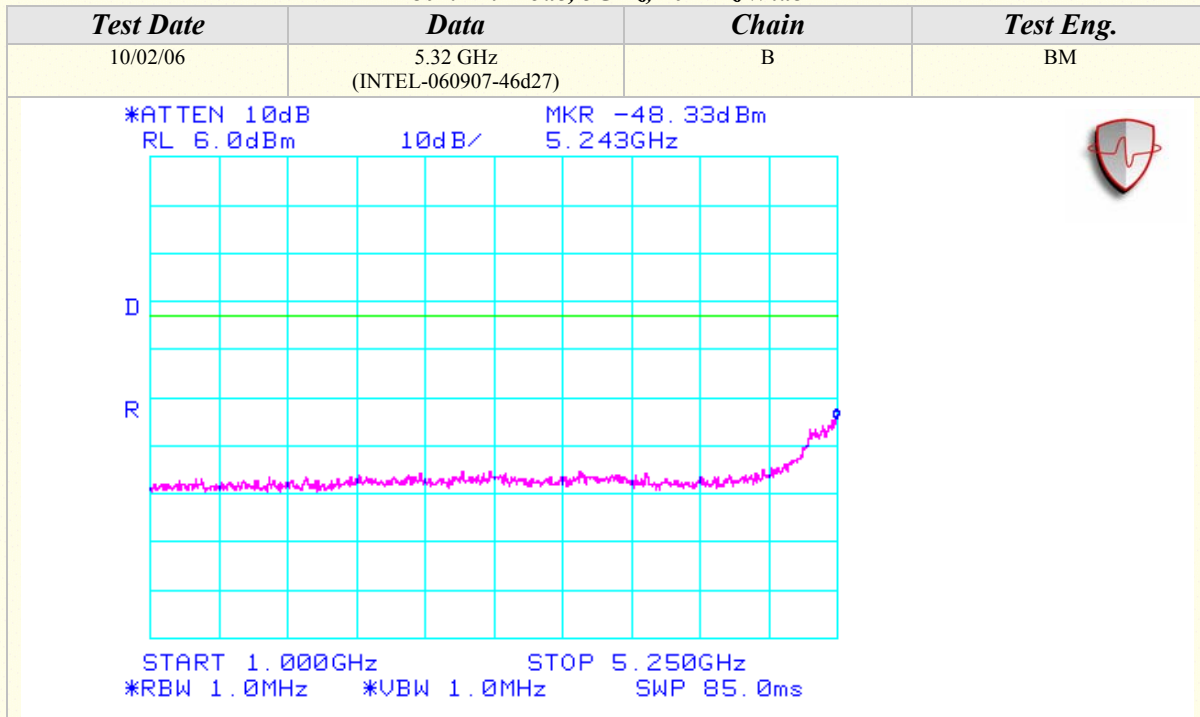





Conducted Out Of Band Emissions (Continued)

802.11n Mode, 5GHz, 40MHz Wide

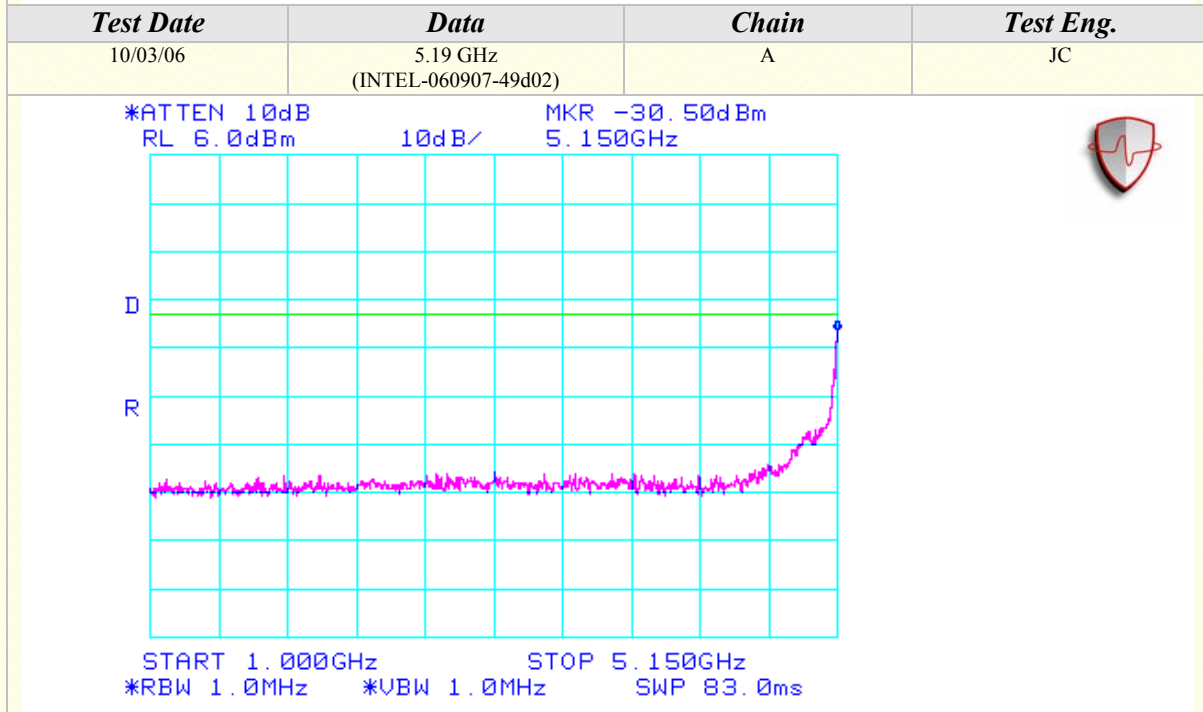
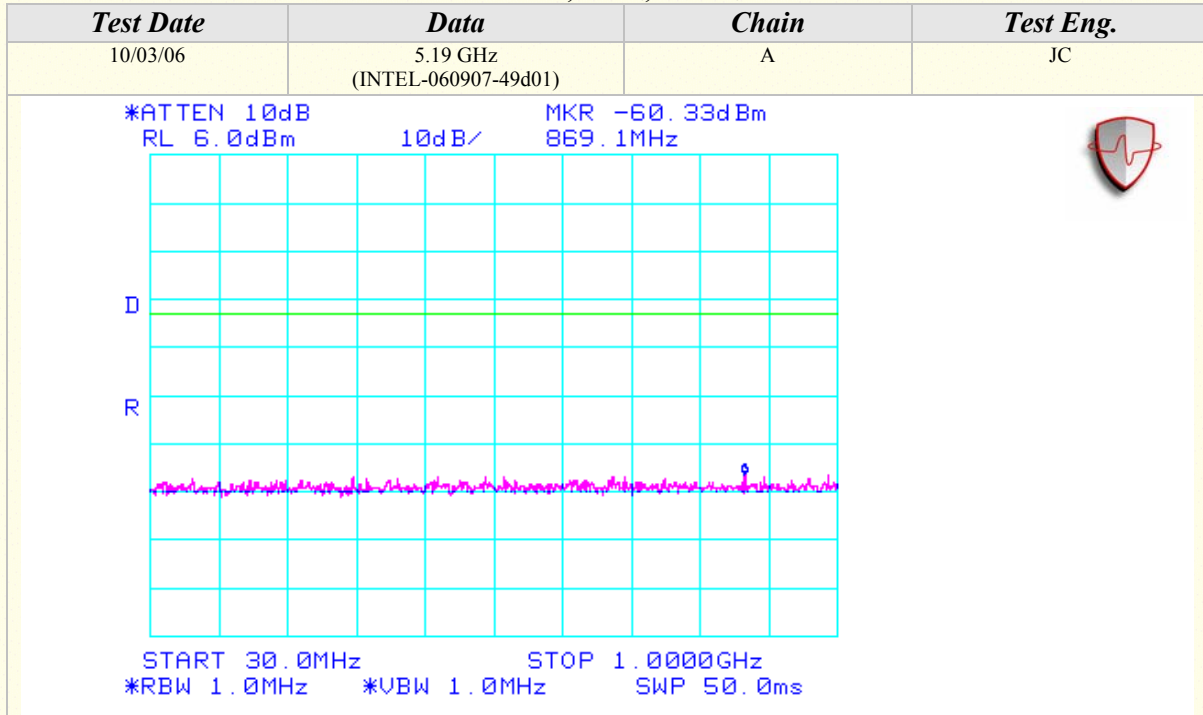



Conducted Out Of Band Emissions (Continued)

802.11n Mode, 5GHz, 40MHz Wide

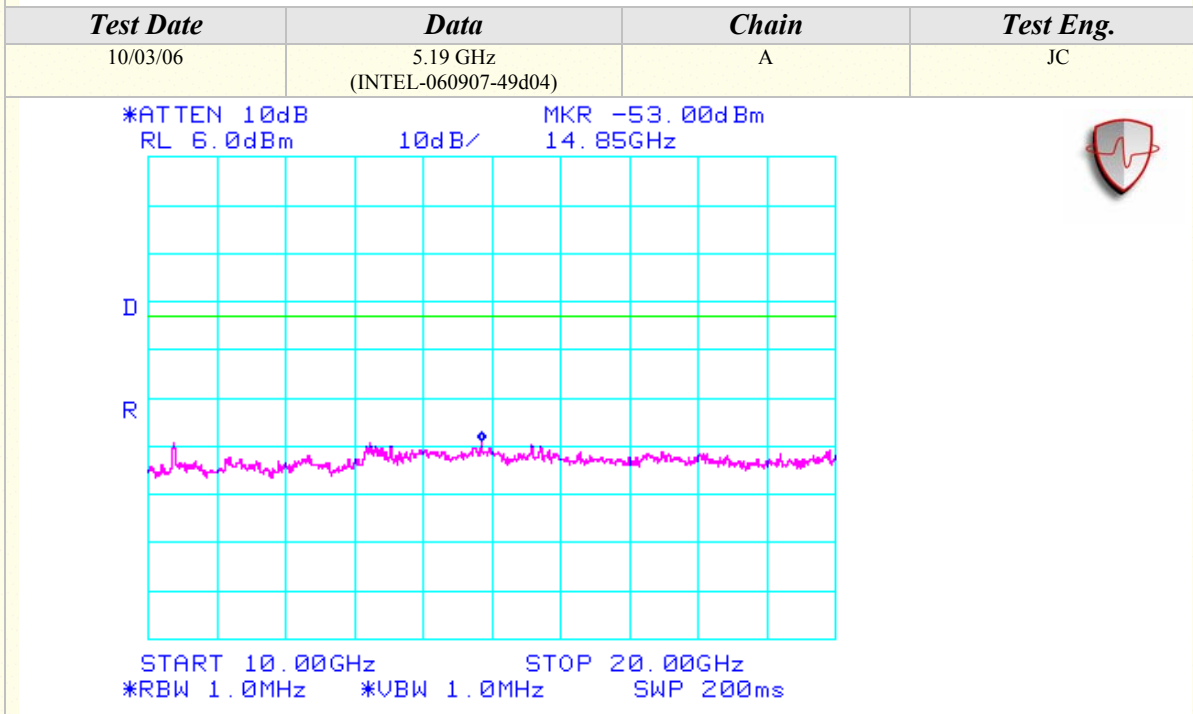
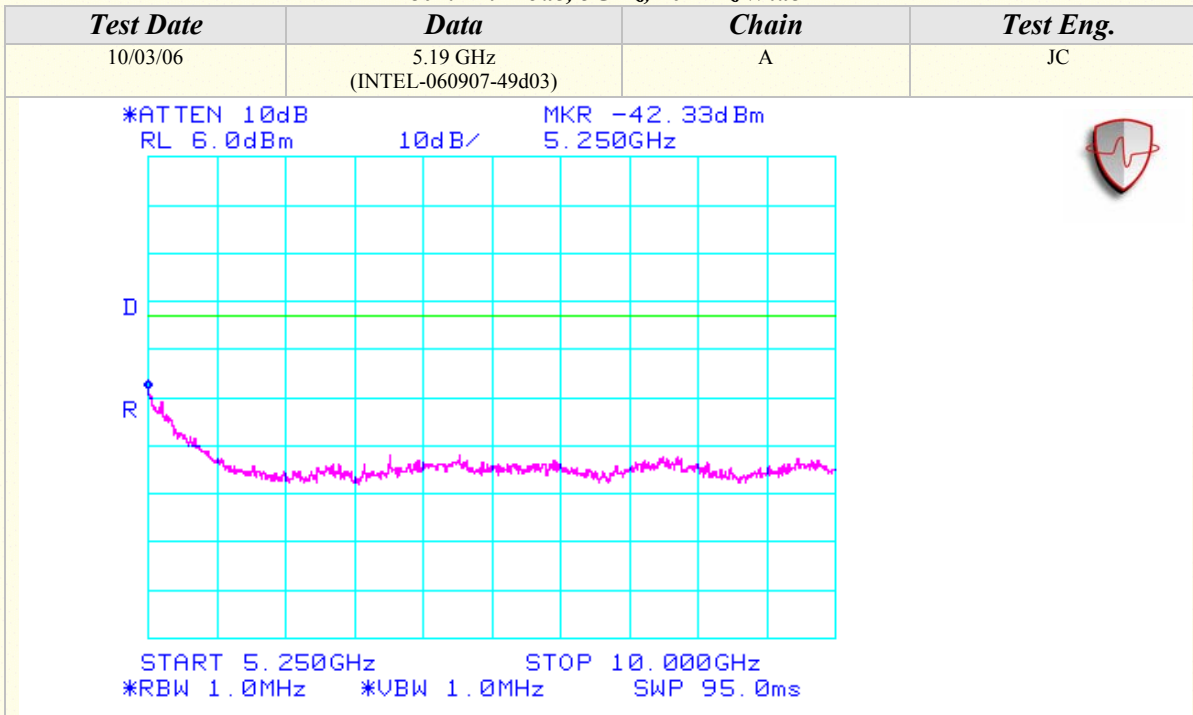

Conducted Out Of Band Emissions (Continued)

802.11n Mode, 5GHz, 40MHz Wide

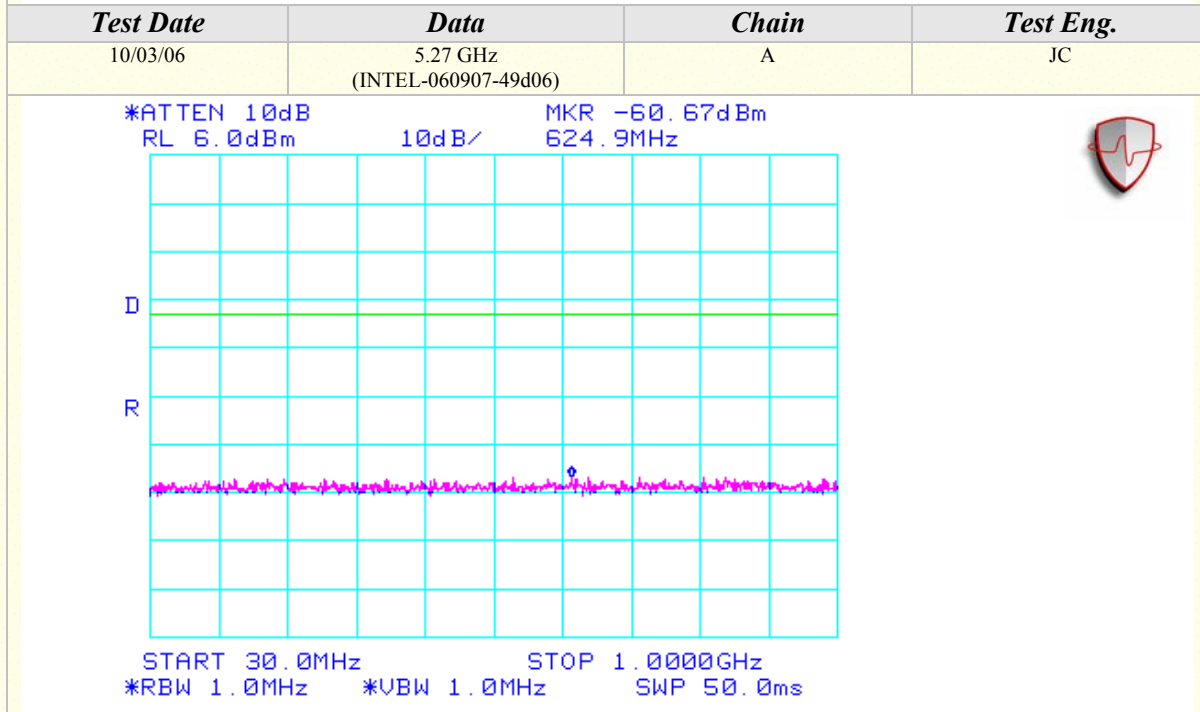
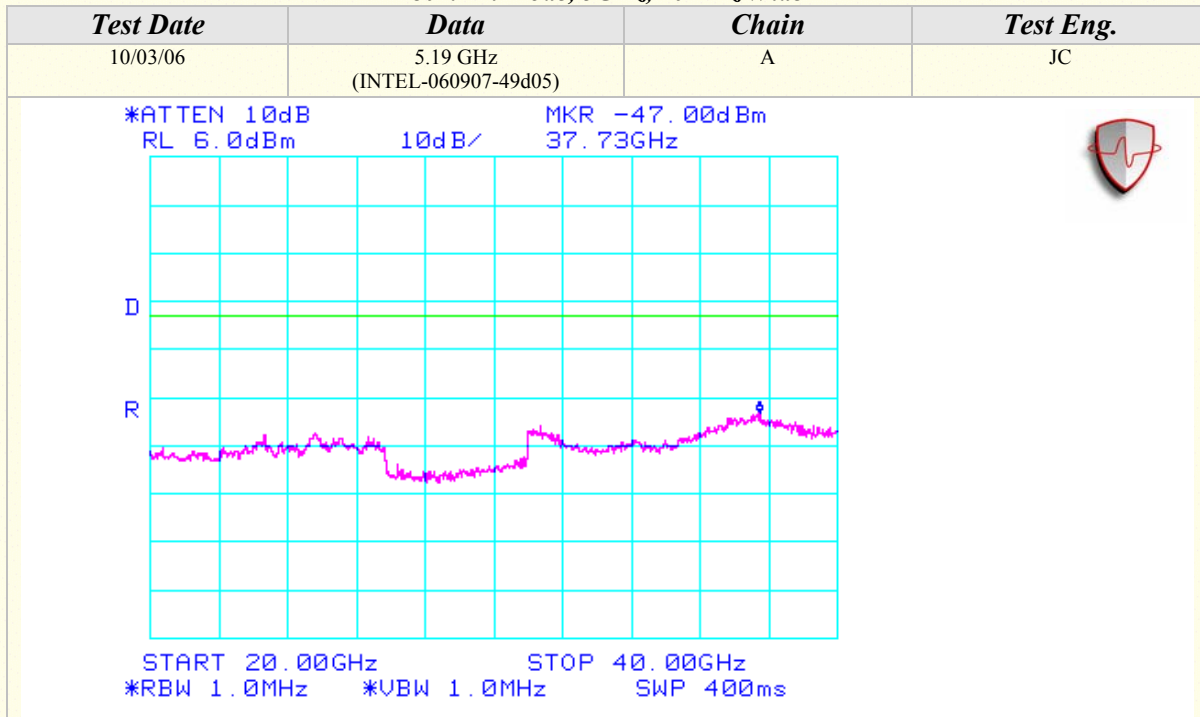



Conducted Out Of Band Emissions (Continued)

802.11n Mode, 5GHz, 40MHz Wide

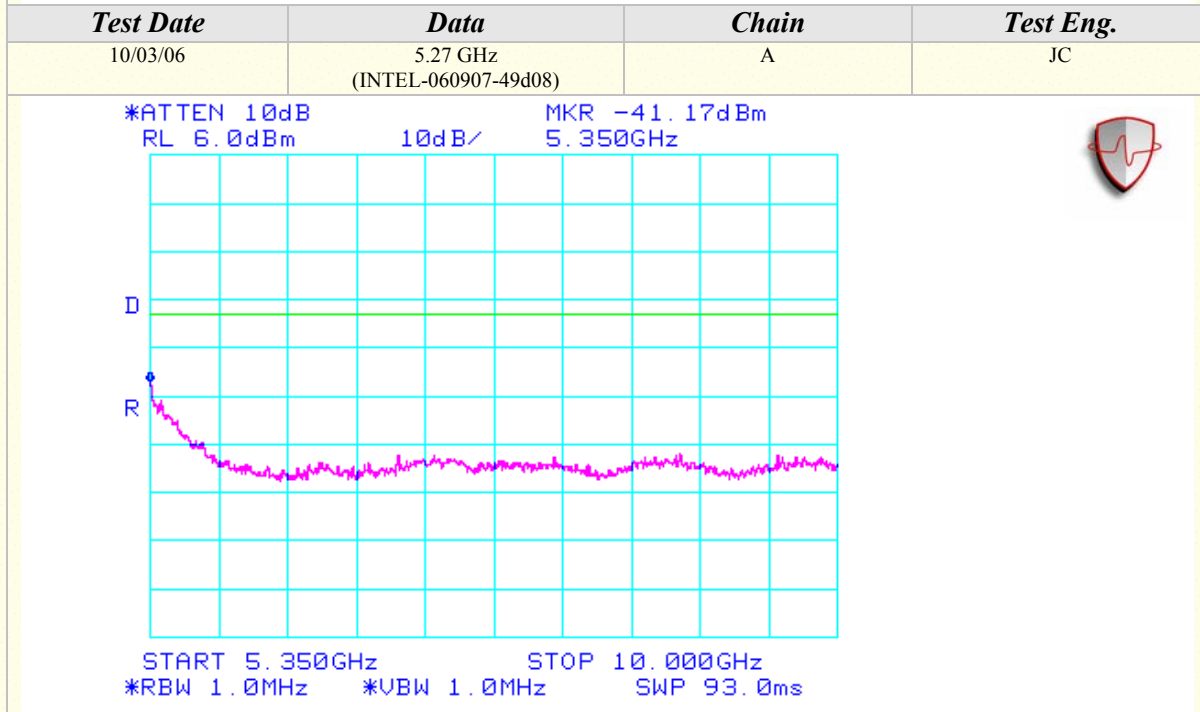
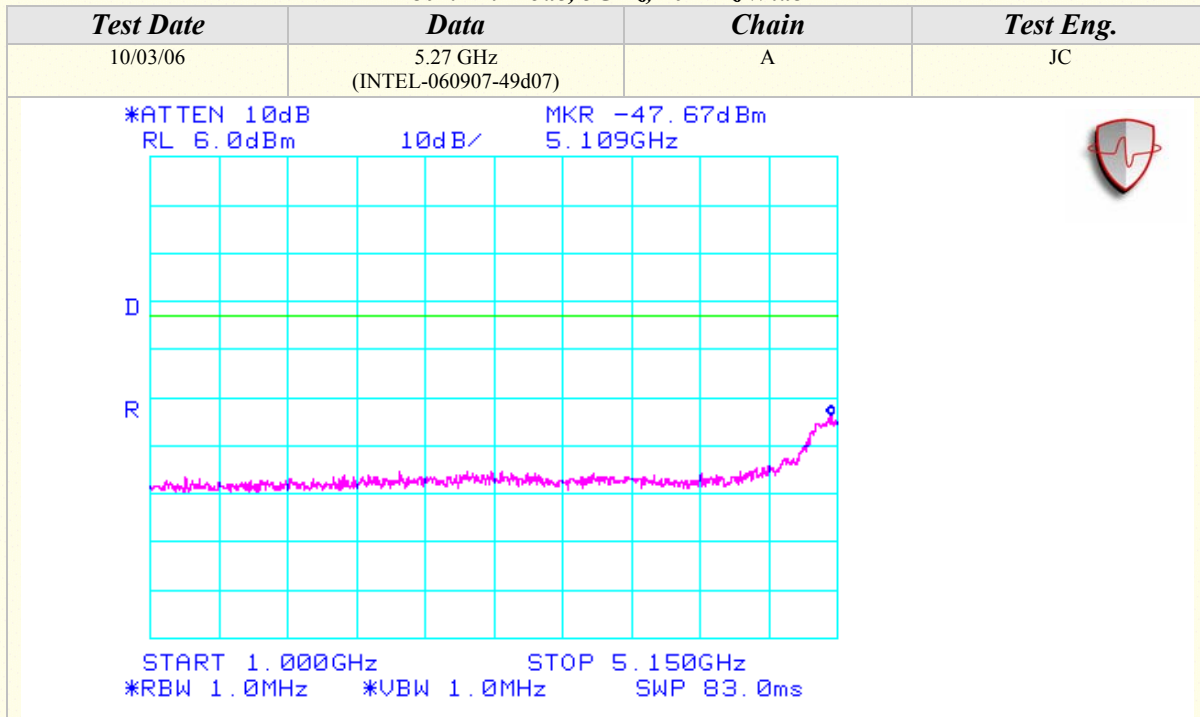

Conducted Out Of Band Emissions (Continued)

802.11n Mode, 5GHz, 40MHz Wide

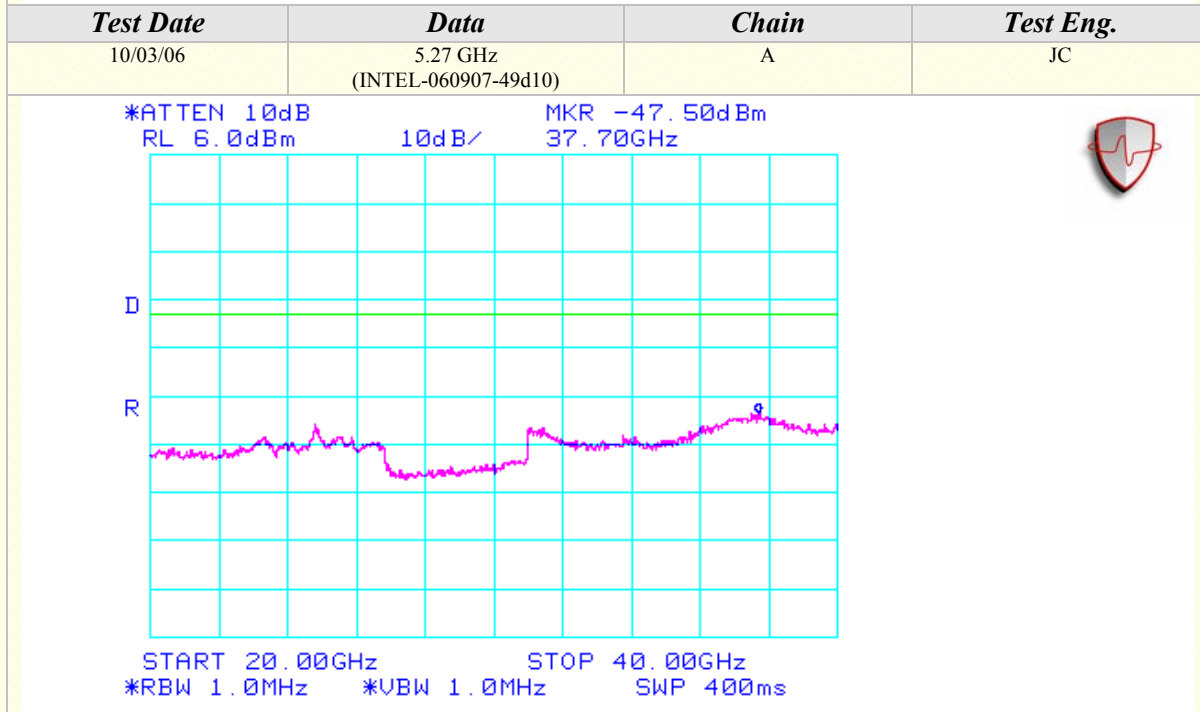
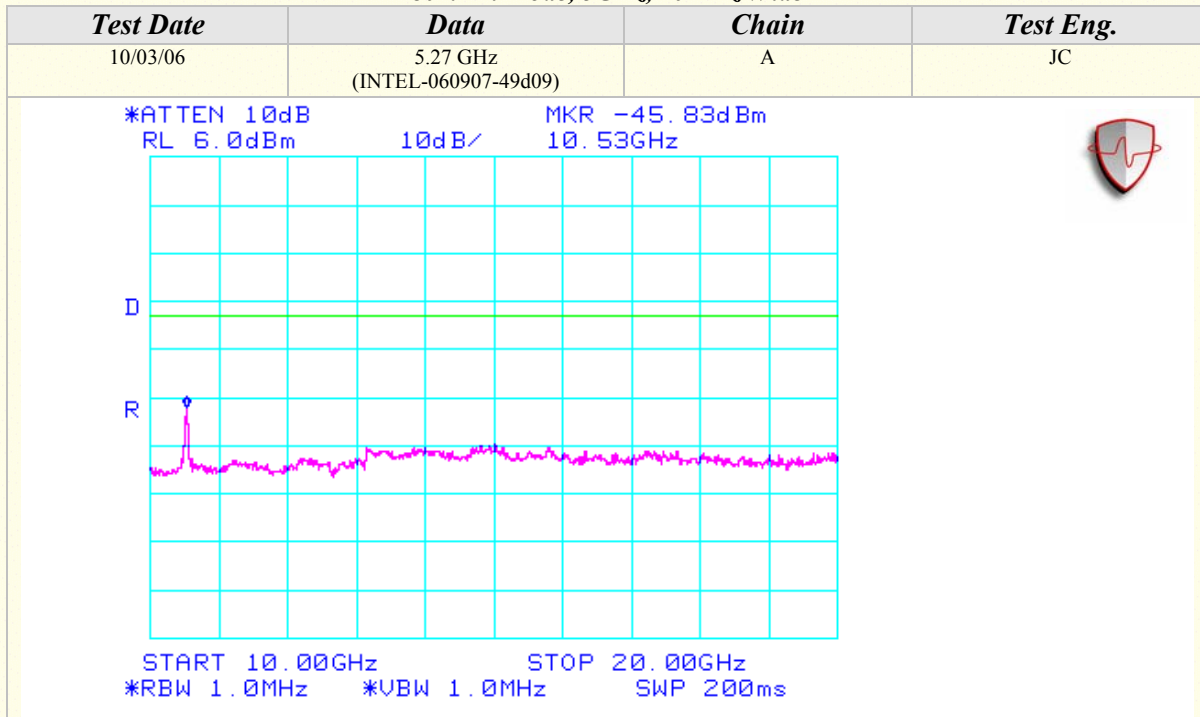





Conducted Out Of Band Emissions (Continued)

802.11n Mode, 5GHz, 40MHz Wide

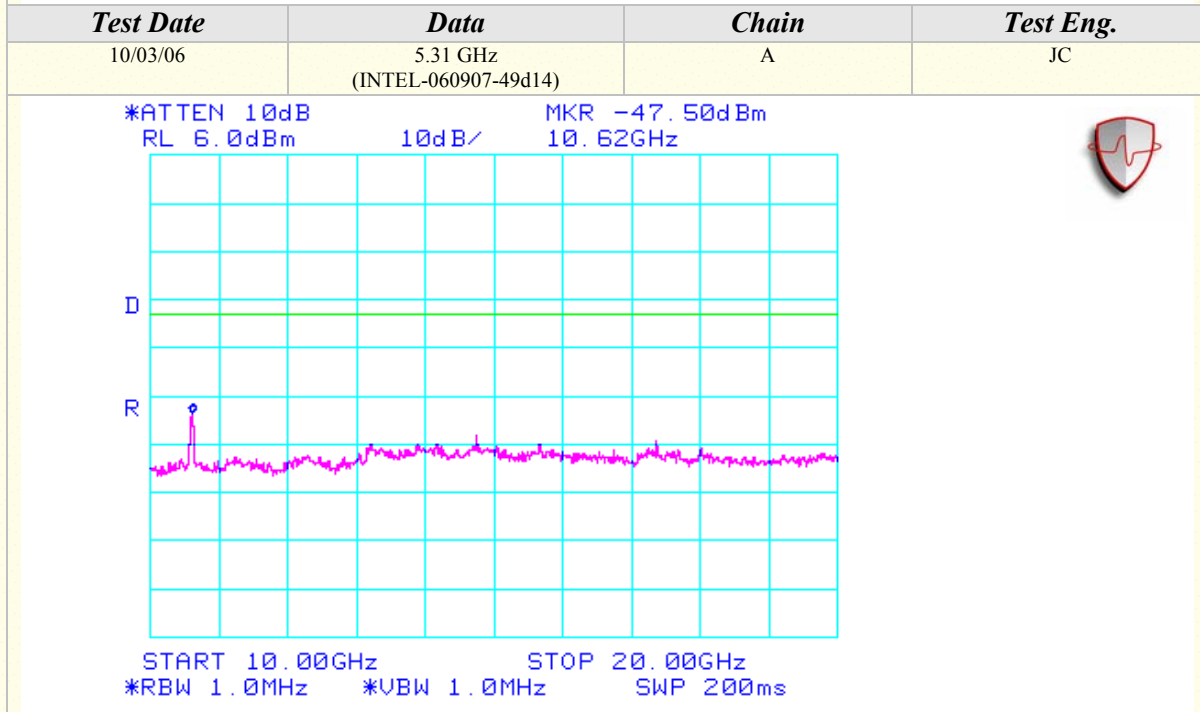
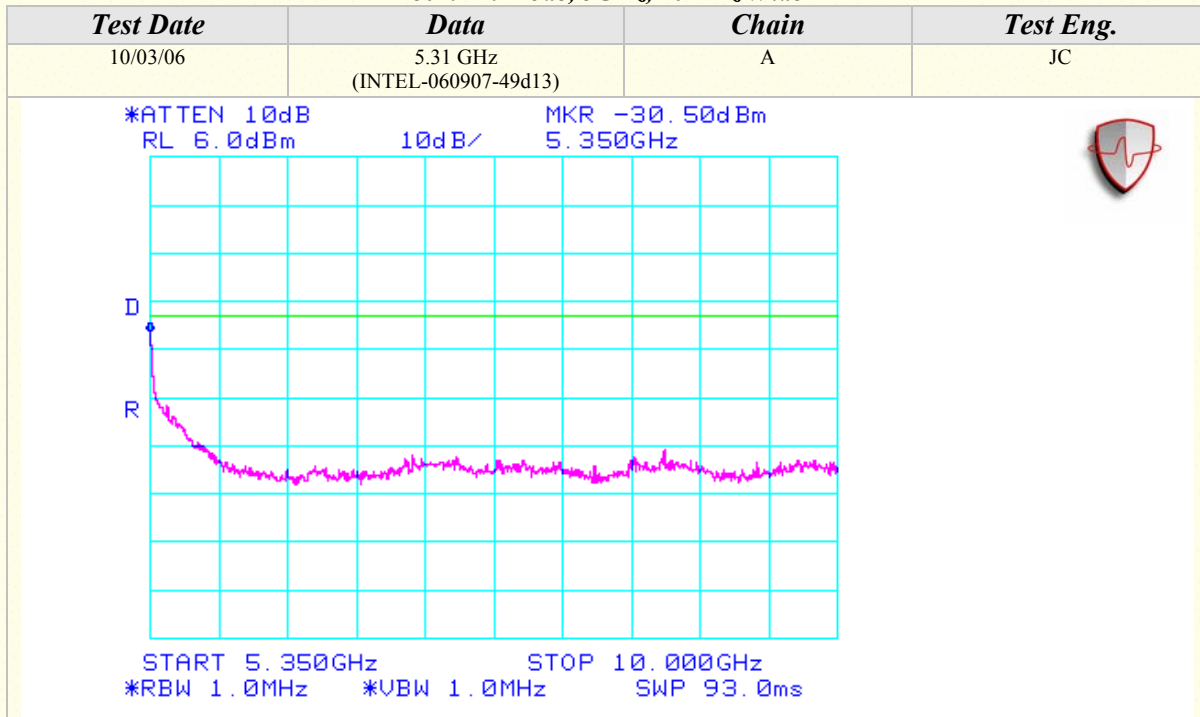



Conducted Out Of Band Emissions (Continued)

802.11n Mode, 5GHz, 40MHz Wide

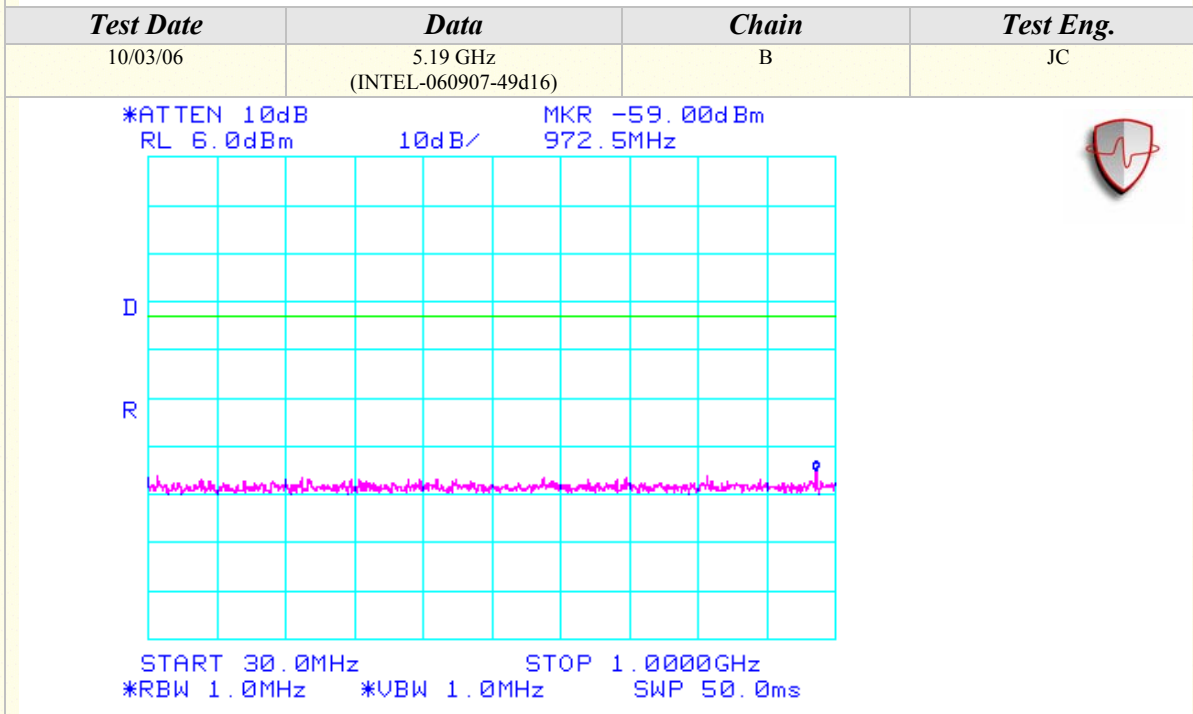
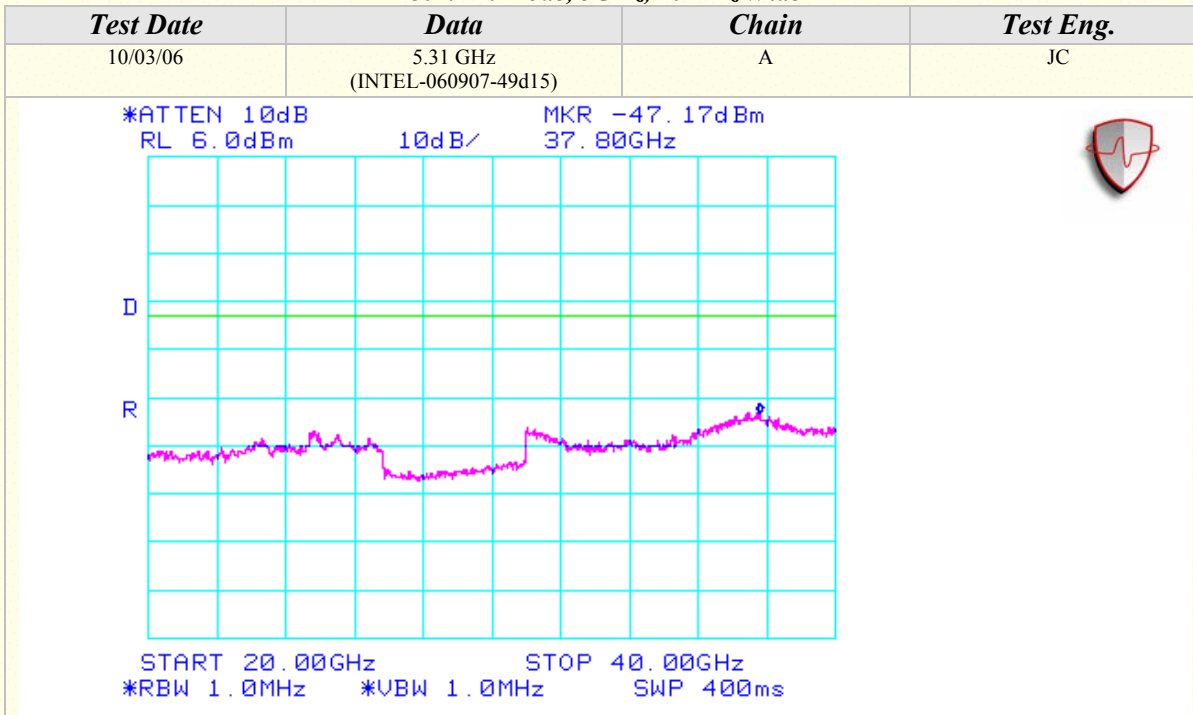

Conducted Out Of Band Emissions (Continued)

802.11n Mode, 5GHz, 40MHz Wide

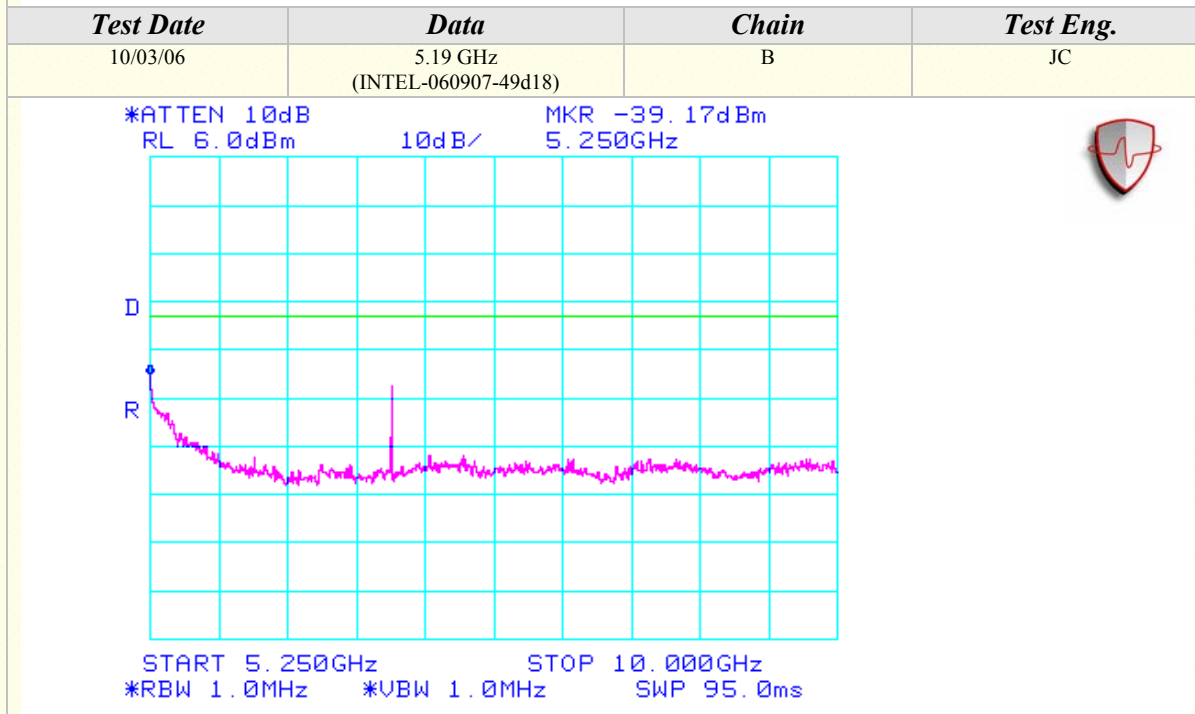
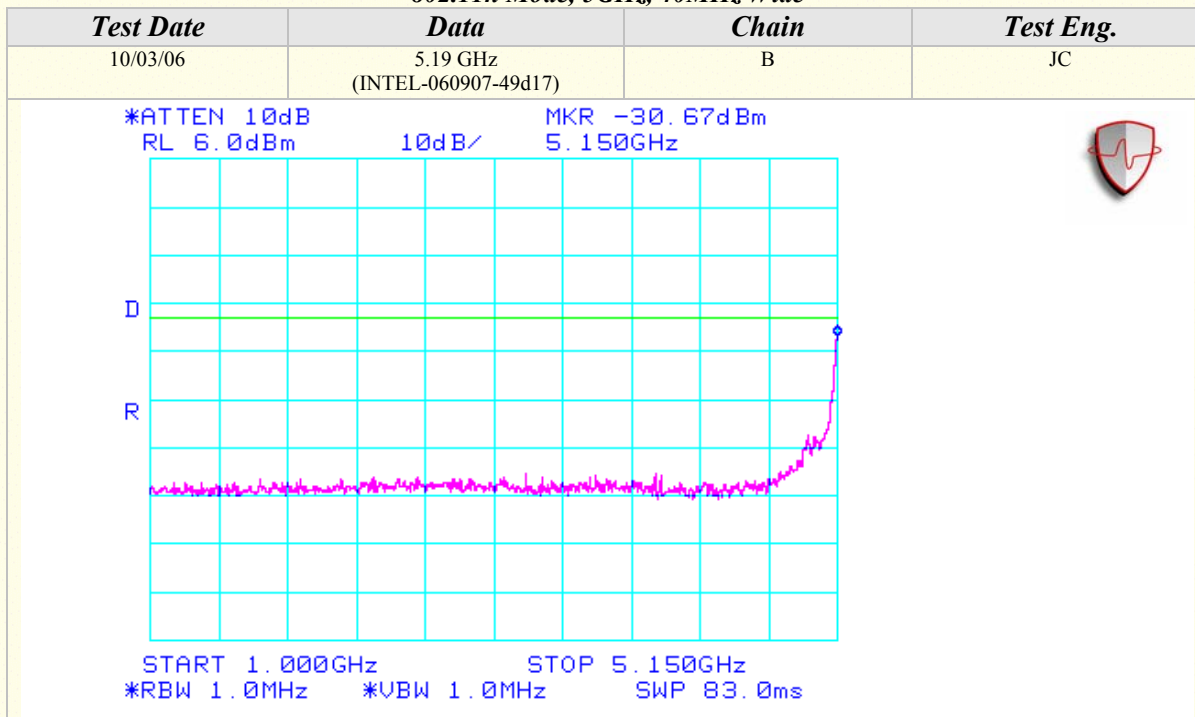



Conducted Out Of Band Emissions (Continued)

802.11n Mode, 5GHz, 40MHz Wide

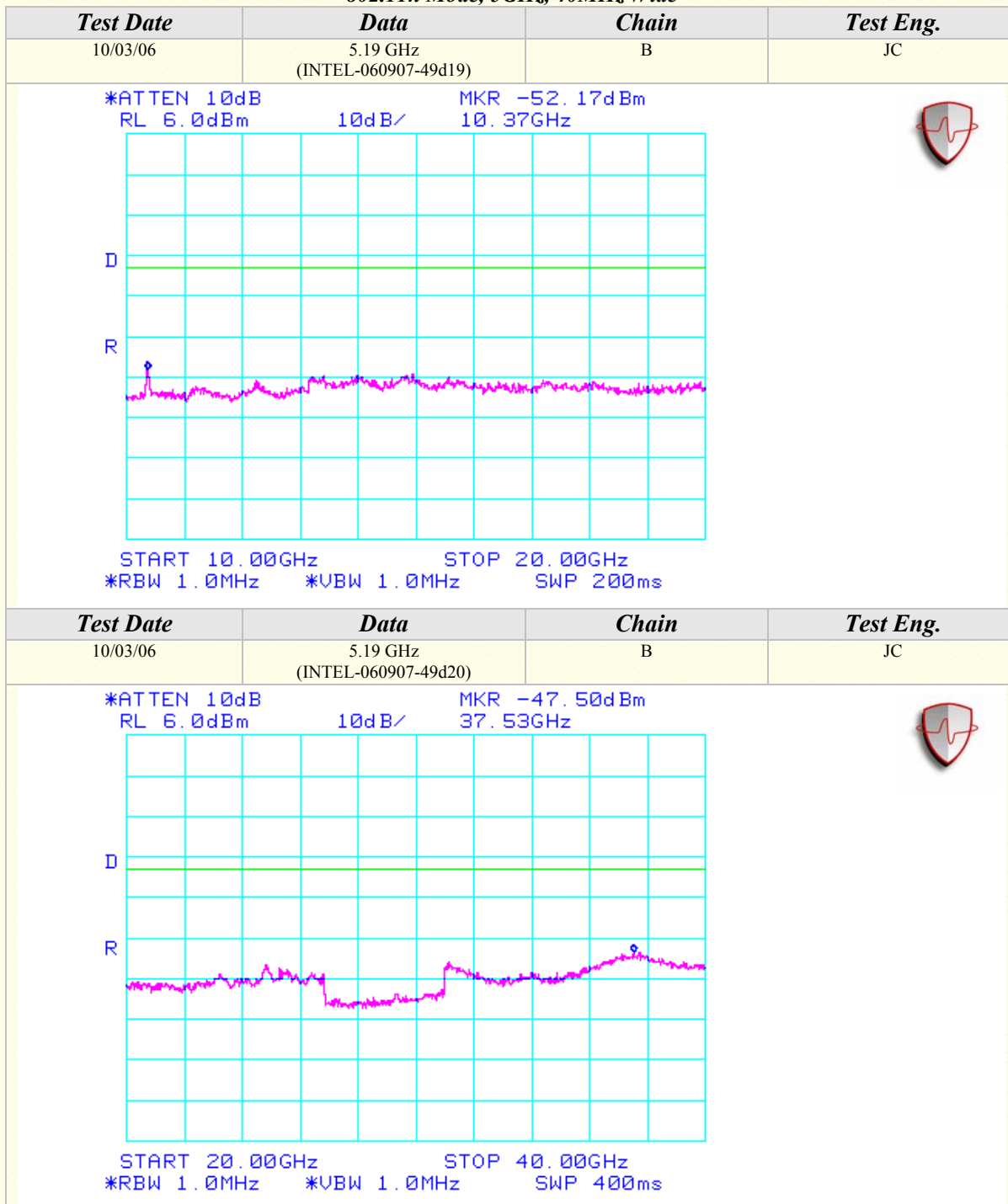

Conducted Out Of Band Emissions (Continued)

802.11n Mode, 5GHz, 40MHz Wide

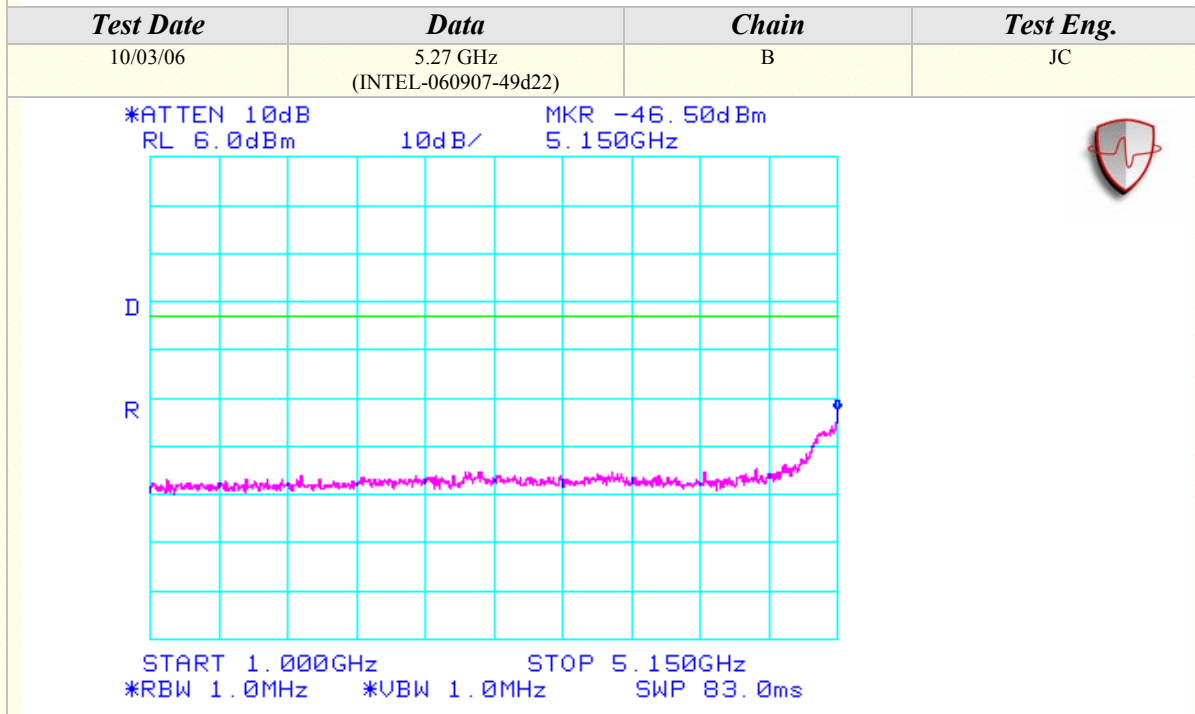
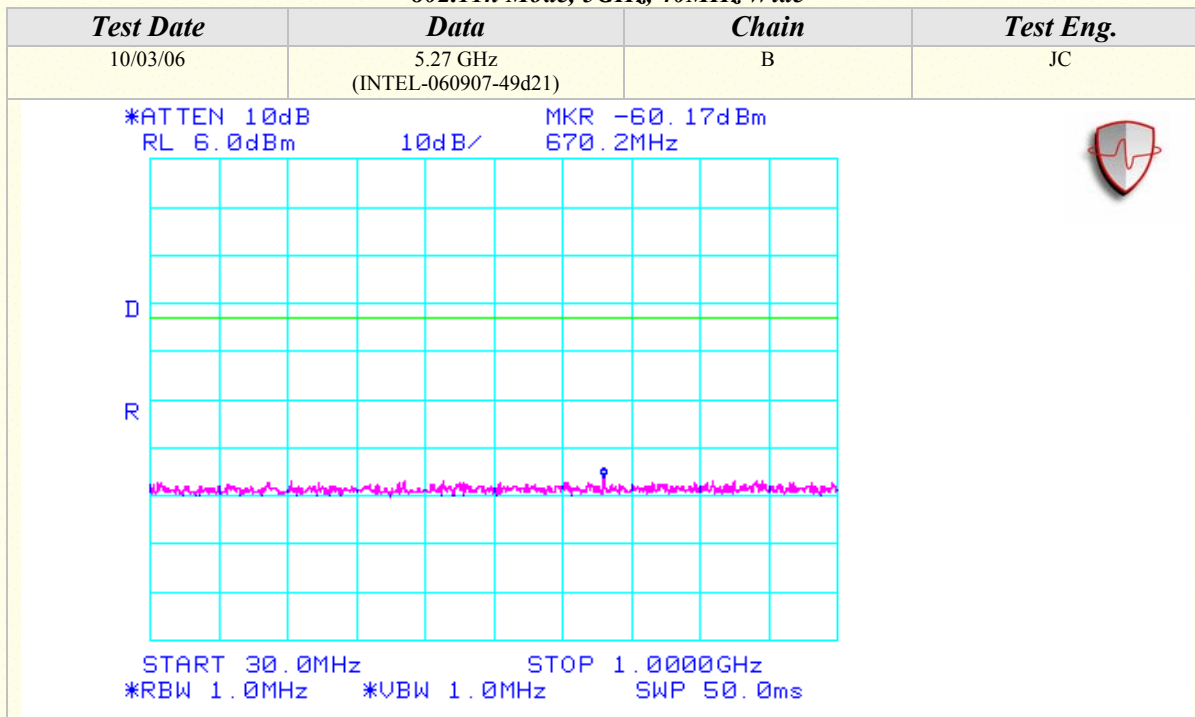



Conducted Out Of Band Emissions (Continued)

802.11n Mode, 5GHz, 40MHz Wide

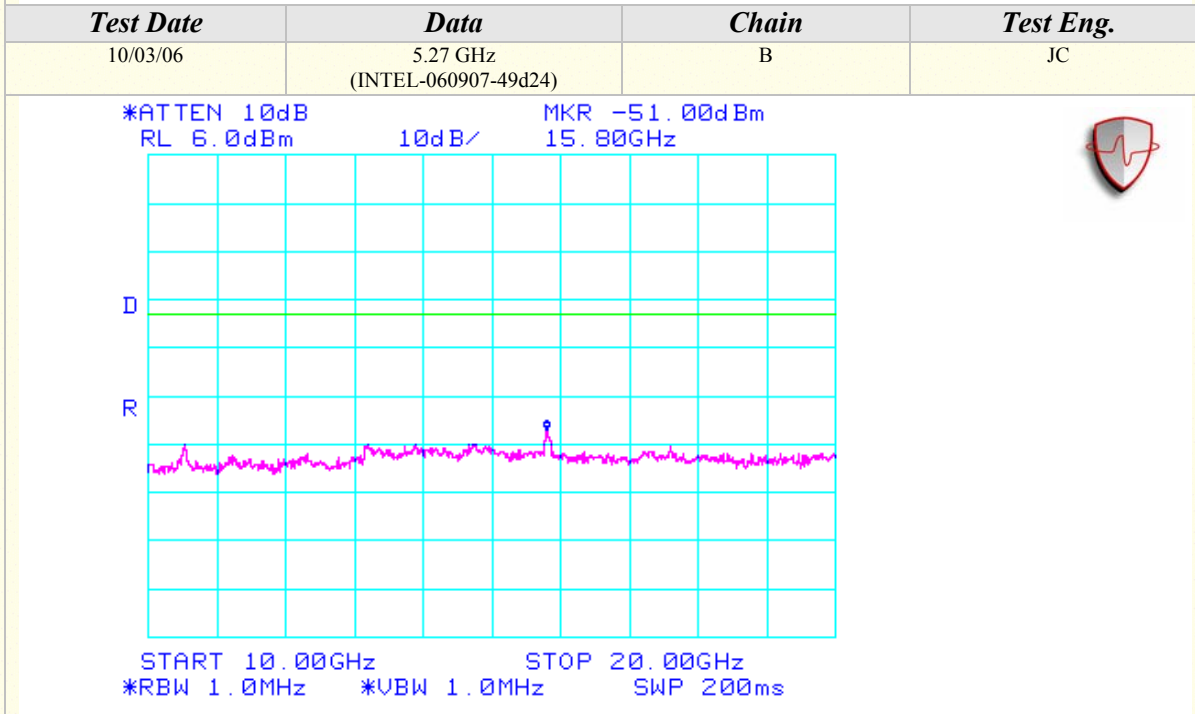
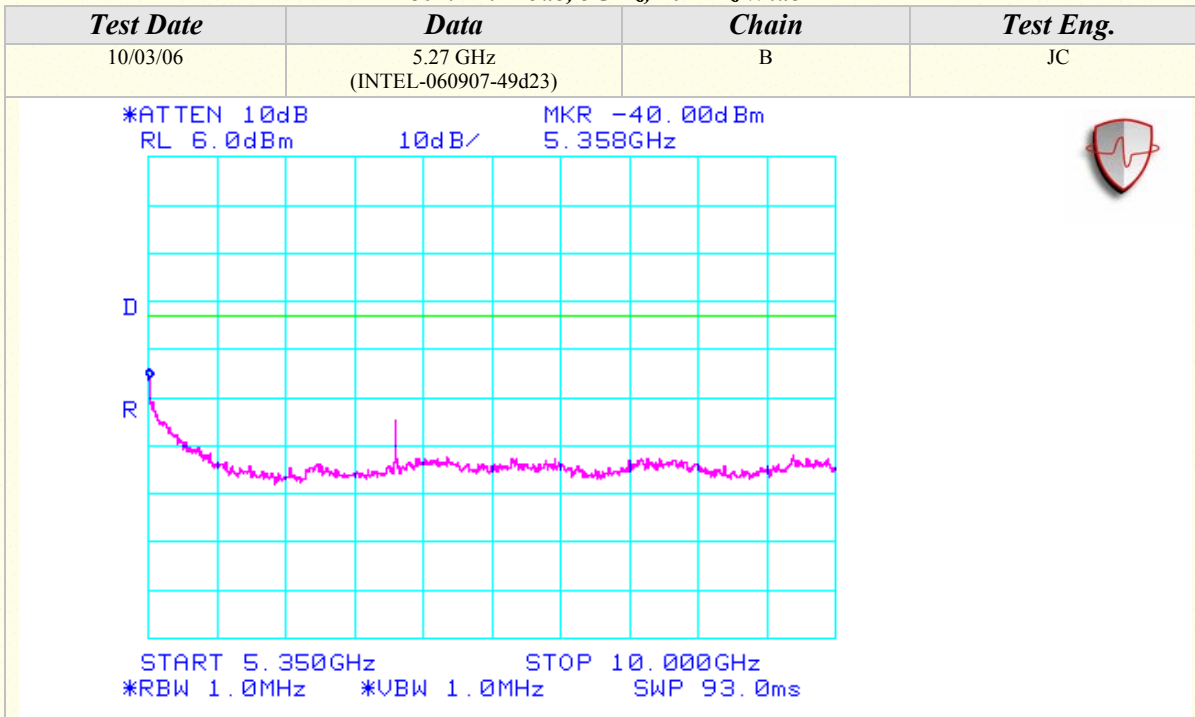

Conducted Out Of Band Emissions (Continued)

802.11n Mode, 5GHz, 40MHz Wide

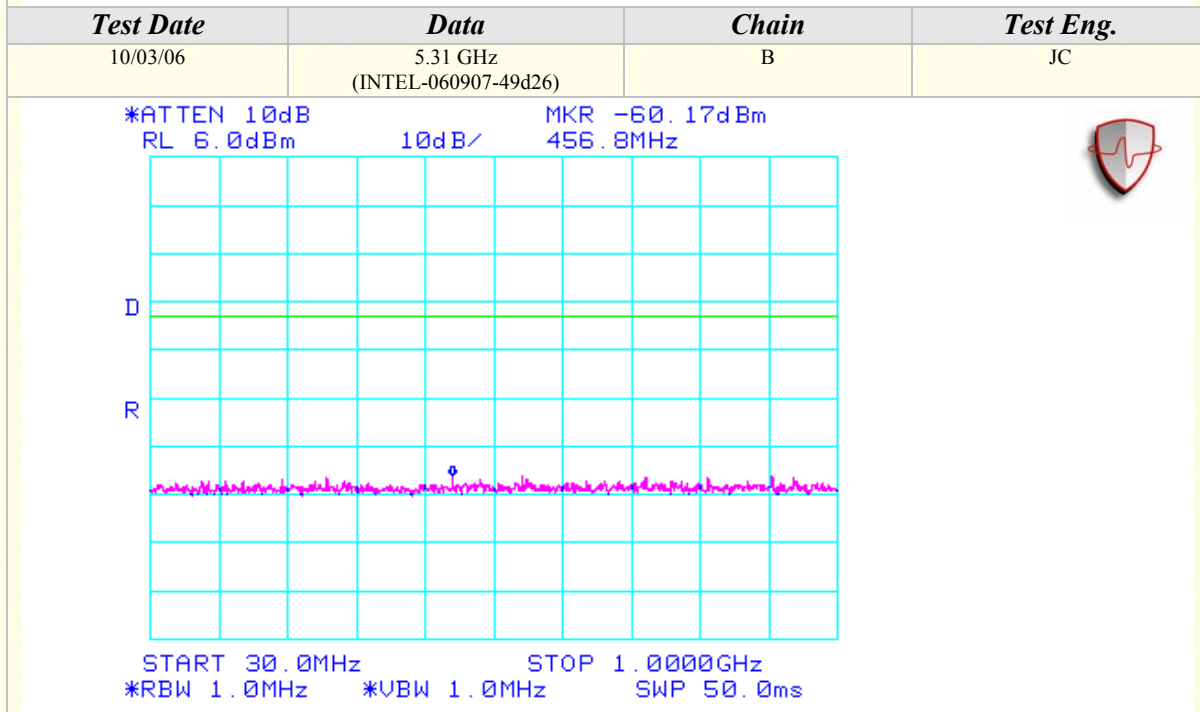
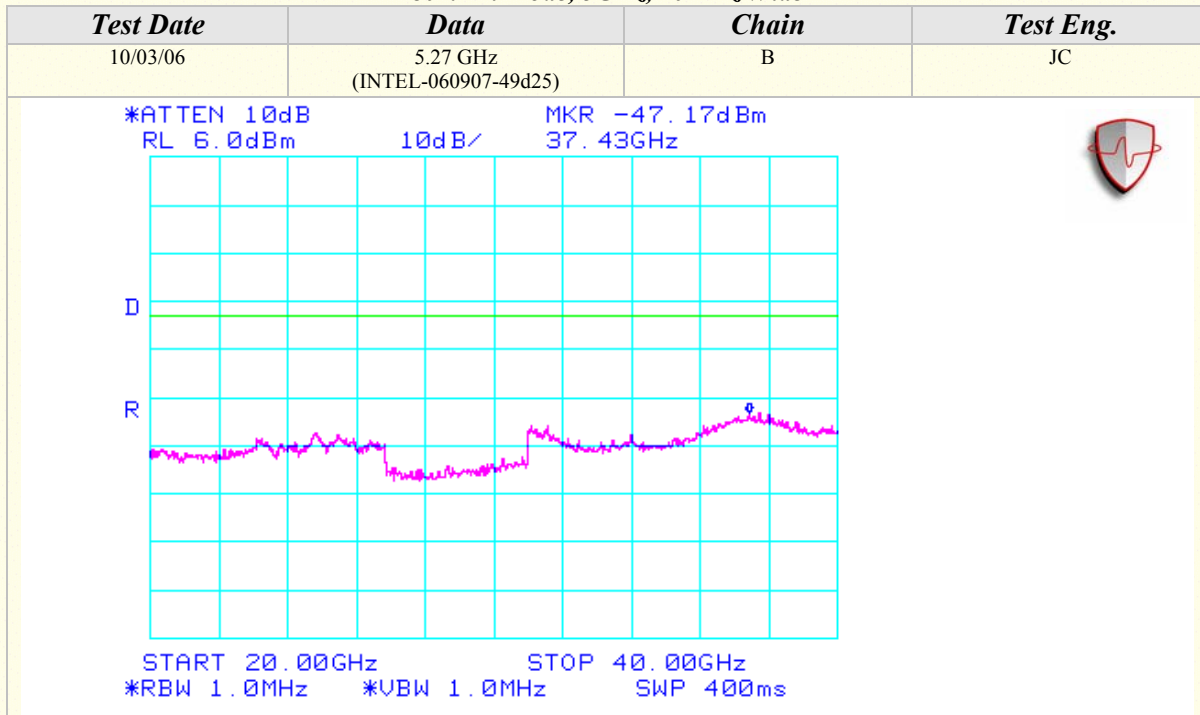



Conducted Out Of Band Emissions (Continued)

802.11n Mode, 5GHz, 40MHz Wide

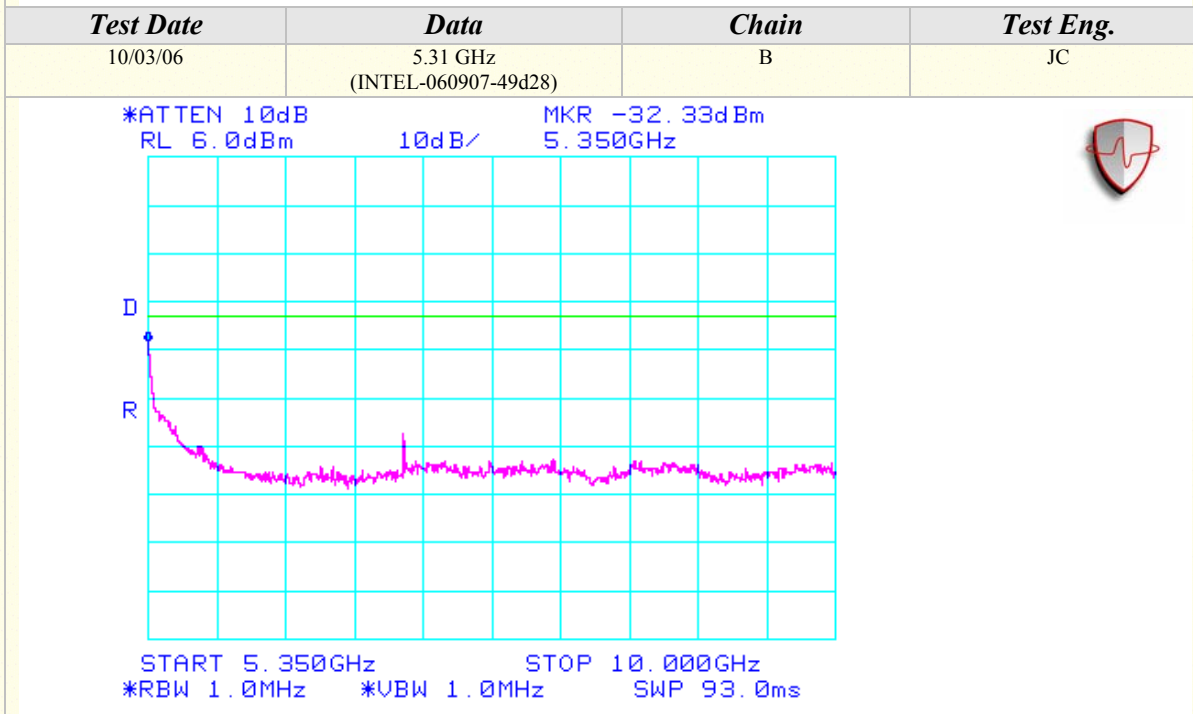
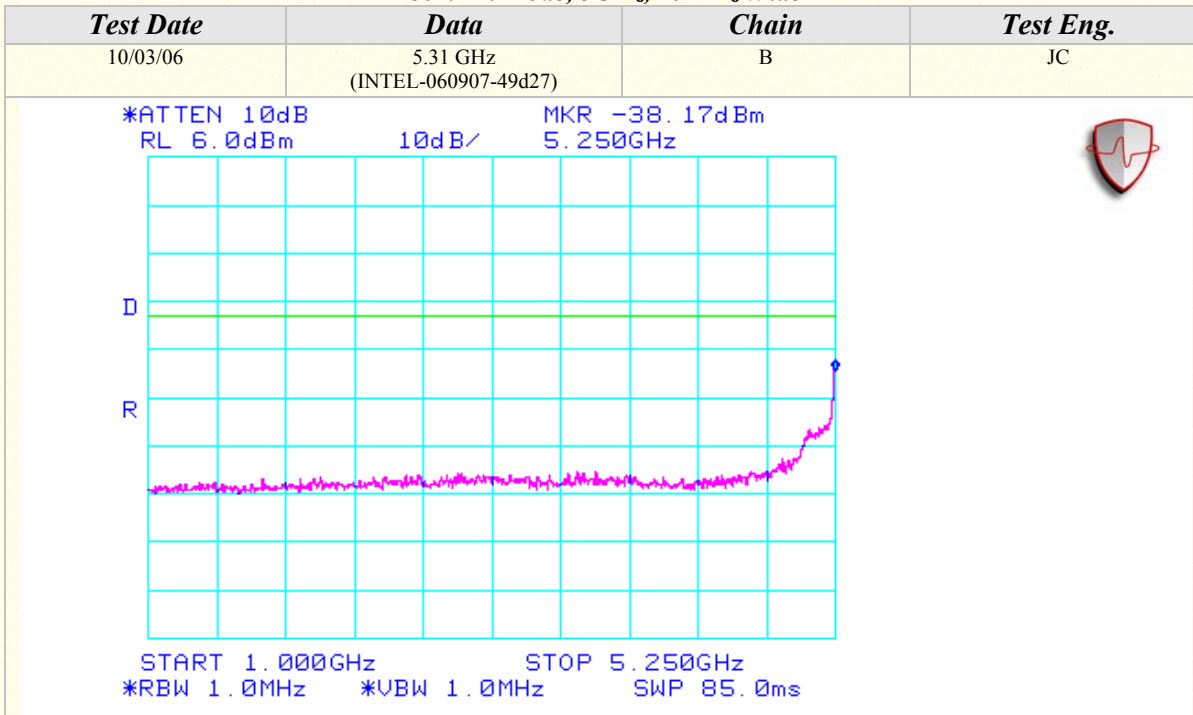

Conducted Out Of Band Emissions (Continued)

802.11n Mode, 5GHz, 40MHz Wide

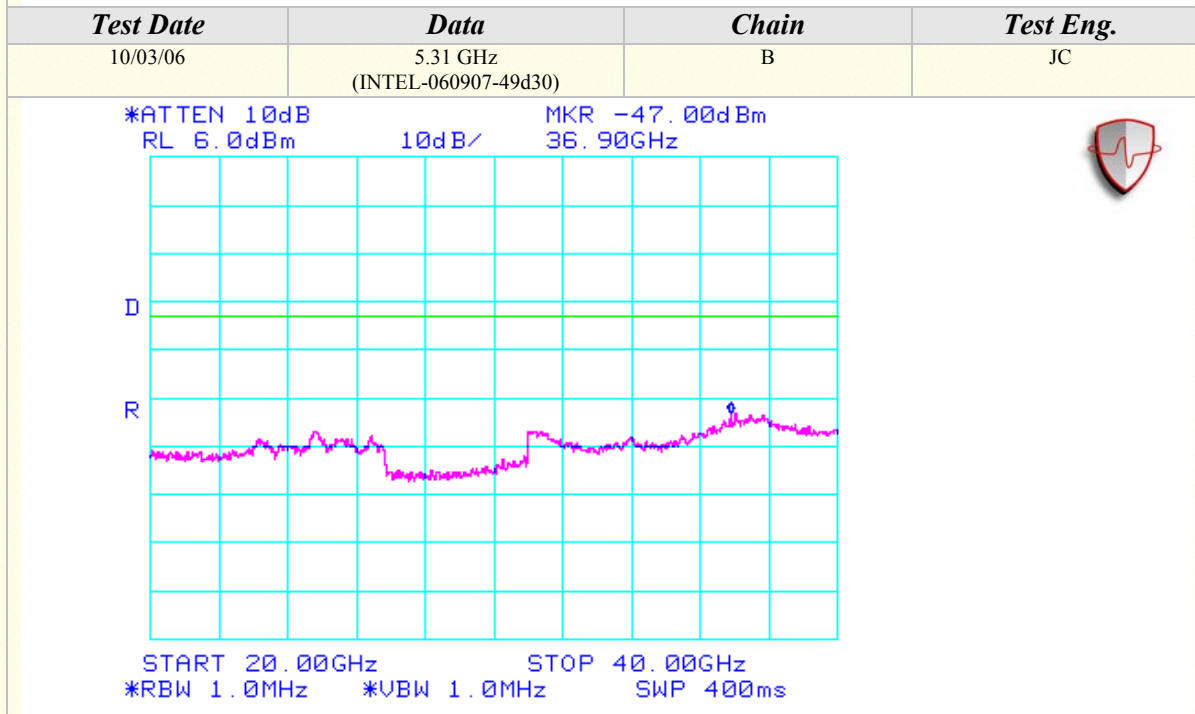
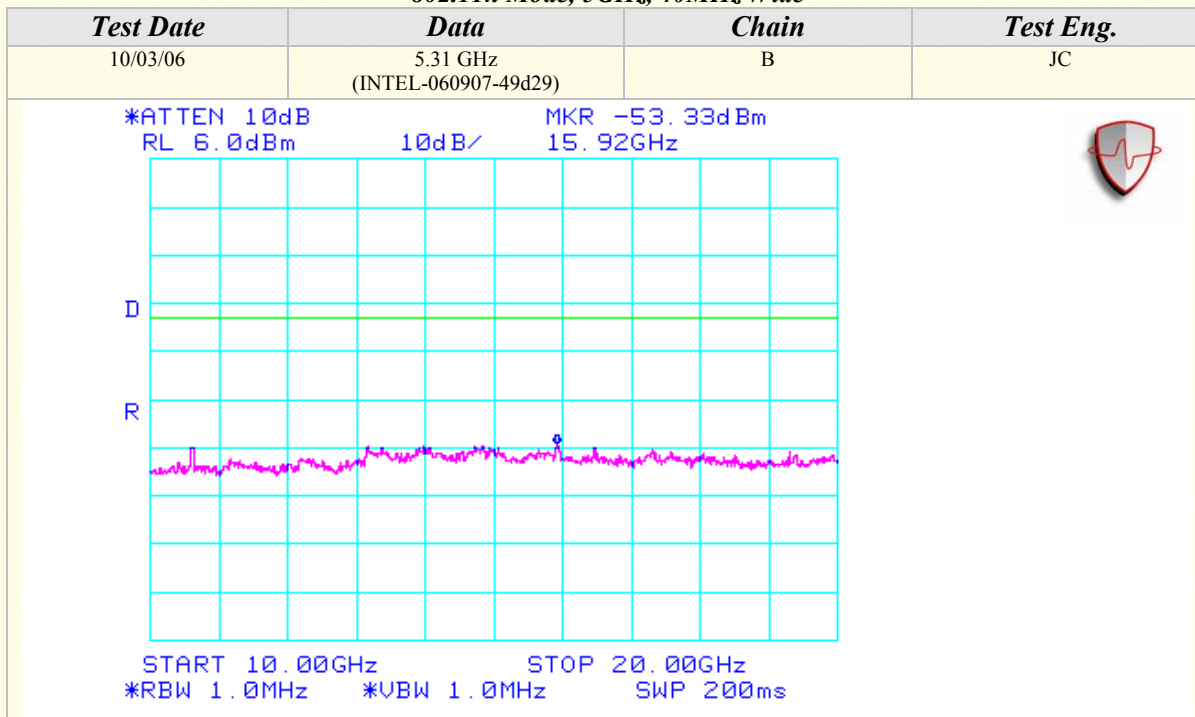





## APPENDIX B

### *MODIFICATIONS AND RECOMMENDATIONS*

<b>1.0</b>	NONE