



RADIO TEST REPORT

Test Report No. : 10981928S-A

Applicant : Fujitsu Limited
Type of Equipment : Ubiquitous-warecore module
Model No. : FUWC
FCC ID : EJE-BT0004
Test regulation : FCC Part 15 Subpart C: 2015
Test Result : Complied

1. This test report shall not be reproduced in full or partial, without the written approval of UL Japan, Inc.
2. The results in this report apply only to the sample tested.
3. This sample tested is in compliance with the above regulation.
4. The test results in this report are traceable to the national or international standards.
5. The opinions and the interpretations to the result of the description in this report are outside scopes where UL Japan has been accredited.
6. This test report covers Radio technical requirements. It does not cover administrative issues such as Manual or non-Radio test related Requirements. (if applicable)

Date of test: October 1 to 15, 2015

Representative test engineer:

H. Morikawa

Hiroyuki Morikawa
Engineer
Consumer Technology Division

Approved by:

T. Arai

Tatsuya Arai
Engineer
Consumer Technology Division



JAB
Testing
RTL02610

- The testing in which "Non-accreditation" is displayed is outside the accreditation scopes in UL Japan.
 There is no testing item of "Non-accreditation".

UL Japan, Inc.
Shonan EMC Lab.

1-22-3 Megumigaoka, Hiratsuka-shi, Kanagawa-ken, 259-1220 JAPAN

Telephone : +81 463 50 6400

Facsimile : +81 463 50 6401

13-EM-F0429

CONTENTS	PAGE
SECTION 1: Customer information.....	4
SECTION 2: Equipment under test (E.U.T.).....	4
SECTION 3: Test specification, procedures & results.....	5
SECTION 4: Operation of E.U.T. during testing.....	8
SECTION 5: Conducted Emission.....	11
SECTION 6: Radiated Spurious Emission	12
SECTION 7: Antenna Terminal Conducted Tests.....	13
APPENDIX 1: Test data	14
Conducted Emission	14
6dB Bandwidth	20
Maximum Peak Output Power	22
Average Output Power	23
Radiated Spurious Emission	26
Conducted Spurious Emission	37
Power Density	40
99%Occupied Bandwidth	42
APPENDIX 2: Test instruments	43
APPENDIX 3: Photographs of test setup	44
Conducted Emission	44
Radiated Spurious Emission	45
Worst Case Position	46

SECTION 1: Customer information

Company Name : Fujitsu Limited
Address : 1-1,Kamikodanaka 4-chome, Nakahara-ku, Kawasaki
211-8588, Japan
Telephone Number : + 81-44-754-3152
Facsimile Number : + 81-44-754-8575
Contact Person : Isamu Shida

SECTION 2: Equipment under test (E.U.T.)

2.1 Identification of E.U.T.

Type of Equipment : Ubiquitous-warecore module
Model No. : FUWC
Serial No. : Refer to Section 4, Clause 4.2
Rating : DC 1.9 V to 4.3 V
Receipt Date of Sample : October 1, 2015
Country of Mass-production : Japan
Condition of EUT : Production prototype
(Not for Sale: This sample is equivalent to mass-produced items.)
Modification of EUT : No Modification by the test lab.

2.2 Product Description

Model: FUWC (referred to as the EUT in this report) is a Ubiquitous-warecore module.

General Specification

Clock frequency(ies) in the system : 32.768 kHz

Radio Specification

Radio Type : Transceiver
Frequency of Operation : 2402 MHz - 2480 MHz
Modulation : GFSK
Antenna type : Internal antenna: Pattern
External antenna: Monopole
Antenna Gain : Internal antenna: -2.0 dBi
External antenna: 0.7 dBi *
*The loss of cable is adjusted to the same loss of actual use as the gain including cable loss .

SECTION 3: Test specification, procedures & results

3.1 Test Specification

Test Specification : FCC Part 15 Subpart C: 2015, final revised on November 23, 2015
Title : FCC 47CFR Part15 Radio Frequency Device Subpart C Intentional Radiators
Section 15.207 Conducted limits
Section 15.247 Operation within the bands 902-928MHz,
2400-2483.5MHz, and 5725-5850MHz

*Some parts are effective on and after December 17, 2015 or December 23, 2015. The revision does not affect the test specification applied to the EUT.

3.2 Procedures and results

Item	Test Procedure	Specification	Worst margin	Results	Remarks
Conducted Emission	FCC: ANSI C63.4-2009 7. AC powerline Conducted Emission measurements IC: RSS-Gen 8.8	FCC: Section 15.207 IC: RSS-Gen 8.8	5.4 dB 0.38910 MHz, L1, AV Tx 2480 MHz S/N:11	Complied	-
6dB Bandwidth	FCC: KDB 558074 D01 DTS Meas Guidance v03r03 IC: -	FCC: Section 15.247(a)(2) IC: RSS-247 5.2(1)	See data.	Complied	Conducted
Maximum Peak Output Power	FCC: KDB 558074 D01 DTS Meas Guidance v03r03 IC: RSS-Gen 6.12	FCC: Section 15.247(b)(3) IC: RSS-247 5.4(4)		Complied	Conducted
Power Density	FCC: KDB 558074 D01 DTS Meas Guidance v03r03 IC: -	FCC: Section 15.247(e) IC: RSS-247 5.2(2)		Complied	Conducted
Spurious Emission Restricted Band Edges	FCC: KDB 558074 D01 DTS Meas Guidance v03r03 IC: RSS-Gen 6.13	FCC: Section15.247(d) IC: RSS-247 5.5 RSS-Gen 8.9 RSS-Gen 8.10	6.5 dB 2483.5 MHz, AV, Vert. Tx 2480 MHz, S/N: 10	Complied	Conducted (below 30 MHz)/ Radiated (above 30 MHz) *1)

Note: UL Japan, Inc.'s EMI Work Procedures No. 13-EM-W0420 and 13-EM-W0422.

*1) Radiated test was selected over 30 MHz based on section 15.247(d) and KDB 558074 D01 DTS Meas Guidance v03r03 12.2.7.

* In case any questions arise about test procedure, ANSI C 63.10:2013 is also referred.

However, there is one deviation from ANSI C 63.10:2013. (ANSI C63.10:2013 is Non-accreditation)
Measurement height is not 1.5 m, but 0.8 m.

FCC Part 15.31 (e)

The RF Module has its own regulator. The RF part is constantly provided voltage (DC 1.2 V) through the regulator regardless of input voltage. Therefore, this EUT complies with the requirement.

FCC Part 15.203 / 212

The antenna is not removable from the EUT. Therefore, the equipment complies with the antenna requirement.

UL Japan, Inc.

Shonan EMC Lab.

1-22-3 Megumigaoka, Hiratsuka-shi, Kanagawa-ken, 259-1220 JAPAN

Telephone : +81 463 50 6400

Facsimile : +81 463 50 6401

3.3 Addition to standard

Item	Test Procedure	Specification	Worst margin	Results	Remarks
99% Occupied Bandwidth	IC: RSS-Gen 6.6	IC: -	N/A	-	Conducted

Other than above, no addition, exclusion nor deviation has been made from the standard.

3.4 Uncertainty

The following uncertainties have been calculated to provide a confidence level of 95 % using a coverage factor $k = 2$.
Shonan EMC Lab.

Item	Frequency range	Uncertainty (+/-)		
		No. 1 SAC / SR	No. 2 SAC / SR	No. 3 SAC / SR
Conducted emission (AC Mains) LISN	150 kHz-30 MHz	3.6 dB	3.4 dB	3.4 dB
Radiated emission (Measurement distance: 3 m)	9 kHz-30 MHz	3.7 dB	3.5 dB	3.5 dB
	30 MHz-300 MHz	4.9 dB	4.9 dB	4.7 dB
	300 MHz-1 GHz	5.0 dB	5.0 dB	4.8 dB
	1 GHz-13 GHz	4.9 dB	4.9 dB	4.9 dB
Radiated emission (Measurement distance: 1 m)	13 GHz-18 GHz	5.7 dB	5.7 dB	5.7 dB
	18 GHz-40 GHz	4.5 dB	4.3 dB	4.3 dB

SAC=Semi-Anechoic Chamber

SR= Shielded Room is applied besides radiated emission

Antenna terminal test	Uncertainty (+/-)
Power Measurement above 1 GHz (Average Detector)_SPM-06	0.76 dB
Power Measurement above 1 GHz (Peak Detector)_SPM-06	0.79 dB
Power Measurement above 1 GHz (Average Detector)_SPM-07	0.74 dB
Power Measurement above 1 GHz (Peak Detector)_SPM-07	1.08 dB
Spurious emission (Conducted) below 1GHz	1.5 dB

Conducted Emission test

The data listed in this test report has enough margin, more than the site margin.

Radiated emission test

The data listed in this test report has enough margin, more than the site margin.

3.5 Test Location

UL Japan, Inc. Shonan EMC Lab.
1-22-3, Megumigaoka, Hiratsuka-shi, Kanagawa-ken 259-1220 JAPAN
Telephone: +81 463 50 6400, Facsimile: +81 463 50 6401
JAB Accreditation No. RTL02610

Test site	IC Registration Number	Width x Depth x Height (m)	Size of reference ground plane (m) / horizontal conducting plane	Maximum measurement distance
No.1 Semi-anechoic chamber	2973D-1	20.6 x 11.3 x 7.65	20.6 x 11.3	10 m
No.2 Semi-anechoic chamber	2973D-2	20.6 x 11.3 x 7.65	20.6 x 11.3	10 m
No.3 Semi-anechoic chamber	2973D-3	12.7 x 7.7 x 5.35	12.7 x 7.7	5 m
No.4 Semi-anechoic chamber	-	8.1 x 5.1 x 3.55	8.1 x 5.1	-
No.1 Shielded room	-	6.8 x 4.1 x 2.7	6.8 x 4.1	-
No.2 Shielded room	-	6.8 x 4.1 x 2.7	6.8 x 4.1	-
No.3 Shielded room	-	6.3 x 4.7 x 2.7	6.3 x 4.7	-
No.4 Shielded room	-	4.4 x 4.7 x 2.7	4.4 x 4.7	-
No.5 Shielded room	-	7.8 x 6.4 x 2.7	7.8 x 6.4	-
No.6 Shielded room	-	7.8 x 6.4 x 2.7	7.8 x 6.4	-
No.8 shielded room	-	3.45 x 5.5 x 2.4	3.45 x 5.5	-
No.1 Measurement room	-	2.55 x 4.1 x 2.5	-	-

3.6 Test data, Test instruments, and Test set up

Refer to APPENDIX.

SECTION 4: Operation of E.U.T. during testing

4.1 Operating Mode(s)

Mode	Remarks*
Bluetooth Low Energy	PRBS9
* The worst condition was determined based on the test result of Maximum Peak Output Power.	
* Power of the EUT was set by the software as follows; Power settings: Fixed Software: ATBTLC1000 characterization software version 180	

*The details of Operating mode(s)

Test Item	Operating Mode	Tested frequency
Conducted Emission	Bluetooth Low Energy	2402 MHz
Spurious Emission		2440 MHz
6dB Bandwidth		2480 MHz
Maximum Peak Output Power		
Power Density		
99% Occupied Bandwidth		

4.2 Configuration and peripherals

<Internal Antenna>

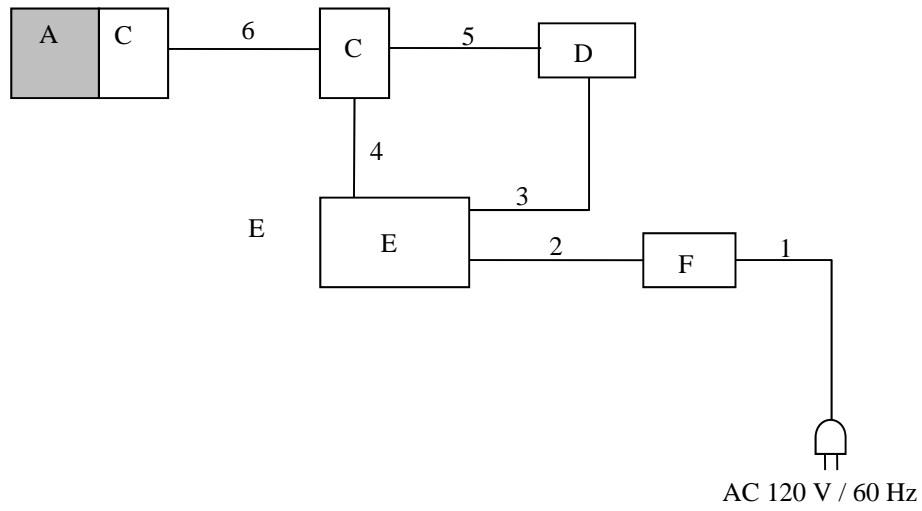

<External Antenna>

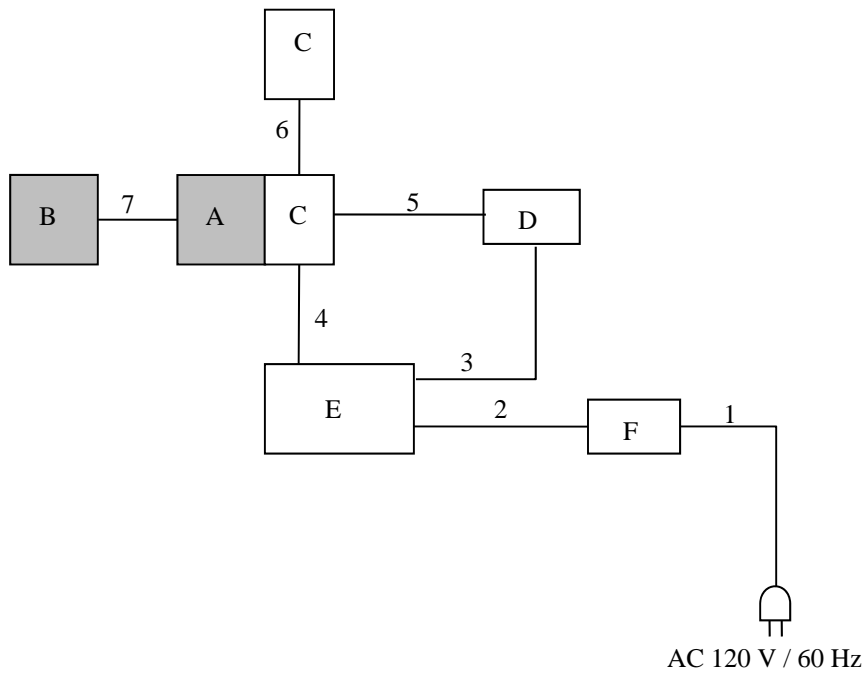

* Cabling and setup(s) were taken into consideration and test data was taken under worse case conditions.

Description of EUT

No.	Item	Model number	Serial number	Manufacturer	Remarks
A	Ubiquitous-warecore module	FUWC	11 *1), 10 *2)	Fujitsu Component Limited	EUT
B	External Antenna	-	-	Fujitsu Component Limited	EUT
C	JIG PWB	-	-	-	-
D	J-Link-ARM	-	158009434	IAR	-
E	Laptop PC	FMV-C8220	CP271004	Fujitsu	-
F	AC Adaptor	FMV-AC312	NL17DB	Fujitsu	-

*1) used for Radiated Emission [Internal Antenna]

*2) used for Radiated Emission [External Antenna], and Antenna Terminal Conducted test

List of cables used

No.	Name	Length (m)	Shield		Remarks
			Cable	Connector	
1	AC	2.0	Unshielded	Unshielded	-
2	DC	1.9	Unshielded	Unshielded	-
3	USB Type A-Type B	1.5	Shielded	Shielded	-
4	USB Type A-Micro B	1.8	Shielded	Shielded	-
5	Signal	0.2	Unshielded	Unshielded	-
6	Signal	0.2	Unshielded	Unshielded	-
7	Antenna	0.02	Shielded	Shielded	-

UL Japan, Inc.

Shonan EMC Lab.

1-22-3 Megumigaoka, Hiratsuka-shi, Kanagawa-ken, 259-1220 JAPAN

Telephone : +81 463 50 6400

Facsimile : +81 463 50 6401

SECTION 5: Conducted Emission

Test Procedure and conditions

EUT was placed on a platform of nominal size, 1.0 m by 2.0 m, raised 0.8 m above the conducting ground plane. The table is made of Styrofoam and covered with polyvinyl chloride. That has very low permittivity.

The rear of tabletop was located 40 cm to the vertical conducting plane. The rear of EUT, including peripherals aligned and flushed with rear of tabletop. All other surfaces of tabletop were at least 80cm from any other grounded conducting surface. EUT was located 80 cm from a Line Impedance Stabilization Network (LISN) / Artificial mains Network (AMN) and excess AC cable was bundled in center.

I/O cables that were connected to the peripherals were bundled in center. They were folded back and forth forming a bundle 30 cm to 40 cm long and were hanged at a 40 cm height to the ground plane.

The AC Mains Terminal Continuous disturbance Voltage has been measured with the EUT in a Semi Anechoic Chamber.

The EUT was connected to a LISN (AMN).

An overview sweep with peak detection has been performed.

The test results and limit are rounded off to one decimal place, so some differences might be observed.

Detector : QP and CISPR AV
Measurement range : 0.15 MHz – 30 MHz
Test data : APPENDIX
Test result : Pass

SECTION 6: Radiated Spurious Emission

Test Procedure

It was measured based on "11.0 Emissions in non-restricted frequency bands" of "558074 D01 DTS Meas Guidance v03r03".

EUT was placed on a polystyrene platform of nominal size, 0.5 m by 0.5 m, raised 0.8 m above the conducting ground plane. The Radiated Electric Field Strength has been measured in a Semi Anechoic Chamber with a ground plane. The height of the measuring antenna varied between 1 m and 4 m and EUT was rotated a full revolution in order to obtain the maximum value of the electric field strength.

The measurements were performed for both vertical and horizontal antenna polarization with the Test Receiver, or the Spectrum Analyzer. The measurements were made with the following detector function of the test receiver and the Spectrum analyzer (in linear mode).

The test was made with the detector (RBW/VBW) in the following table.

When using Spectrum analyzer, the test was made with adjusting span to zero by using peak hold.

Test Antennas are used as below;

Frequency	30 MHz to 300 MHz	300 MHz to 1 GHz	Above 1 GHz
Antenna Type	Biconical	Logperiodic	Horn

In any 100 kHz bandwidth outside the restricted band in which the spread spectrum intentional radiator is operating, the radio frequency power that is produced by the intentional radiator confirmed 20 dB below that in the 100 kHz bandwidth within the band that contains the highest level of the desired power, based on a radiated measurement.

20 dBc was applied to the frequency over the limit of FCC 15.209 / Table 4 of RSS-Gen 8.9(IC) and outside the restricted band of FCC15.205 / Table 6 of RSS-Gen 8.10 (IC).

Frequency	Below 1 GHz	Above 1 GHz		20 dBc
Instrument used	Test Receiver	Spectrum Analyzer		Spectrum Analyzer
Detector	QP	PK	AV *2)	PK
IF Bandwidth	BW 120 kHz	RBW: 1 MHz VBW: 3 MHz	Average Power Method: <u>12.2.5.2</u> RBW: 1 MHz VBW: 3 MHz Detector: Power Averaging (Linear voltage) Trace: 100 traces Duty factor was added to the results.	RBW: 100 kHz VBW: 300kHz
Test Distance	3m	3 m (below 13 GHz), 1 m *1) (above 13 GHz)		3 m (below 13 GHz), 1 m *1) (above 13 GHz)

*1) Distance Factor: $20 \times \log(3.0 \text{ m} / 1.0 \text{ m}) = 9.5 \text{ dB}$

*2) Average Power Measurement was performed based on 6.0 & 13.3.2 of "KDB 558074 D01 DTS Meas Guidance v03r03"

The carrier level and noise levels were confirmed at each position of X, Y and Z axes of EUT to see the position of maximum noise, and the test was made at the position that has the maximum noise.

Worst position:

	Below 1 GHz	1 G-2.8 GHz	2.8 G-13 GHz	13 G-18 GHz	18 G-25 GHz
Horizontal	X (S/N: 10) X (S/N: 11)	X (S/N: 10) X (S/N: 11)	X (S/N: 10) X (S/N: 11)	X (S/N: 10) X (S/N: 11)	Z (S/N: 10) X (S/N: 11)
Vertical	X (S/N: 10) X (S/N: 11)	Z (S/N: 10) Z (S/N: 11)	Z (S/N: 10) X (S/N: 11)	X (S/N: 10) X (S/N: 11)	Y (S/N: 10) Z (S/N: 11)

The test results and limit are rounded off to one decimal place, so some differences might be observed.

Measurement range : 30 M - 25 GHz
Test data : APPENDIX
Test result : Pass

UL Japan, Inc.

Shonan EMC Lab.

1-22-3 Megumigaoka, Hiratsuka-shi, Kanagawa-ken, 259-1220 JAPAN

Telephone : +81 463 50 6400

Facsimile : +81 463 50 6401

SECTION 7: Antenna Terminal Conducted Tests

Test Procedure

The tests were made with below setting connected to the antenna port.

Test	Span	RBW	VBW	Sweep time	Detector	Trace	Instrument used
6dB Bandwidth	10 MHz	100 kHz	300 kHz	Auto	Peak	Max Hold	Spectrum Analyzer
99% Occupied Bandwidth *1)	Enough width to display emission skirts	1 to 5 % of OBW	Three times of RBW	Auto	Peak	Max Hold	Spectrum Analyzer
Maximum Peak Output Power	-	-	-	Auto	Peak/Average *2)	-	Power Meter (Sensor: 50 MHz BW)
Peak Power Density	1.5 times the 6dB Bandwidth	3 kHz	9.1 kHz	Auto	Peak	Max Hold	Spectrum Analyzer *3) *4)
Conducted Spurious Emission *5)	9kHz to 150kHz	200 Hz	620 Hz	Auto	Peak	Max Hold	Spectrum Analyzer
	150kHz to 30MHz	10 kHz	30 kHz				

*1) Peak hold was applied as Worst-case measurement.
*2) Reference data
*3) Section 10.2 Method PKPSD (peak PSD) of "KDB 558074 D01 DTS Meas Guidance v03r03".
*4) The test was not performed at RBW:3 kHz however the measurement is to be performed with RBW:3kHz in the regulation, because, the measurement value with RBW:3 kHz is less than the value of RBW:30 kHz and the test data met the limit with RBW:30 kHz.
*5) In the frequency range below 30MHz, RBW was narrowed to separate the noise contents.
Then, wide-band noise near the limit was checked separately, however the noise was not detected as shown in the chart.
(9 kHz - 150 kHz: RBW = 200 Hz, 150 kHz - 30 MHz: RBW = 9.1 kHz)

The test results and limit are rounded off to two decimals place, so some differences might be observed.

Test data : APPENDIX
Test result : Pass

UL Japan, Inc.

Shonan EMC Lab.

1-22-3 Megumigaoka, Hiratsuka-shi, Kanagawa-ken, 259-1220 JAPAN

Telephone : +81 463 50 6400

Facsimile : +81 463 50 6401

APPENDIX 1: Test data

Conducted Emission

S/N: 10 + External antenna

DATA OF CONDUCTED EMISSION TEST

UL Japan, Inc. Shonan EMC Lab. No.3 Shielded Room
Date : 2015/10/15

Mode : BLE Tx 2402MHz
Power : DC 3.3 V
Temp./Humi. : 24 deg.C. / 45 %RH

Limit1 : FCC 15C (15.207) QP
Limit2 : FCC 15C (15.207) AV

Engineer : Hiroyuki Morikawa

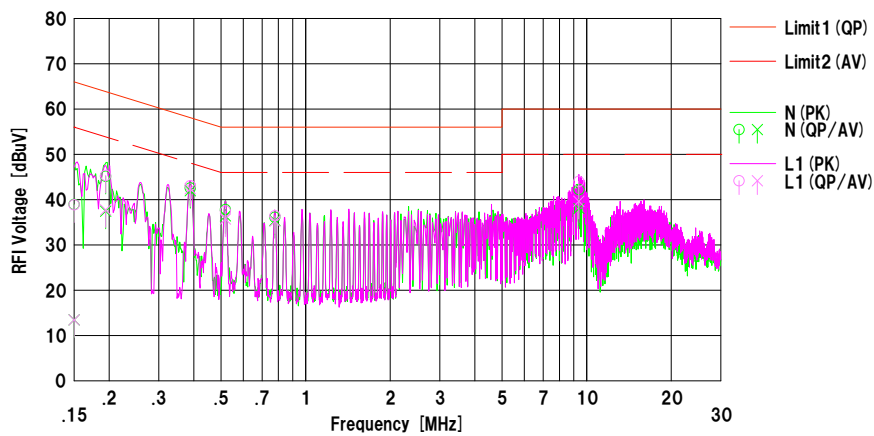

No.	Freq. [MHz]	Reading		C.Fac	Results		Limit		Margin		Phase	Comment
		<QP> [dBuV]	<AV> [dBuV]		<QP> [dBuV]	<AV> [dBuV]	<QP> [dBuV]	<AV> [dBuV]	<QP> [dB]	<AV> [dB]		
1	0.15000	26.60	1.10	12.35	38.95	13.45	66.00	56.00	27.0	42.5	N	
2	0.19420	32.80	25.10	12.34	45.14	37.44	63.85	53.85	18.7	16.4	N	
3	0.38880	30.20	29.60	12.38	42.58	41.98	58.09	48.09	15.5	6.1	N	
4	0.51820	25.40	24.00	12.40	37.80	36.40	56.00	46.00	18.2	9.6	N	
5	0.77710	23.70	23.00	12.42	36.12	35.42	56.00	46.00	19.8	10.5	N	
6	9.38580	29.40	25.20	12.83	42.23	38.03	60.00	50.00	17.7	11.9	N	
7	0.15000	26.50	1.10	12.35	38.85	13.45	66.00	56.00	27.1	42.5	L1	
8	0.19420	33.00	25.40	12.34	45.34	37.74	63.85	53.85	18.5	16.1	L1	
9	0.38880	30.70	30.00	12.38	43.08	42.38	58.09	48.09	15.0	5.7	L1	
10	0.51830	25.10	23.30	12.40	37.50	35.70	56.00	46.00	18.5	10.3	L1	
11	0.77760	24.00	22.80	12.42	36.42	35.22	56.00	46.00	19.5	10.7	L1	
12	9.37350	31.20	26.80	12.83	44.03	39.63	60.00	50.00	15.9	10.3	L1	

Calculation: Result [dBuV] = Reading [dBuV] + C.Fac (LISN+Cable+ATT) [dB]
LISN: SLS-05

DATA OF CONDUCTED EMISSION TEST

UL Japan, Inc. Shonan EMC Lab. No.3 Shielded Room
Date : 2015/10/15

Mode : BLE Tx 2440MHz
Power : DC 3.3 V
Temp./Humi. : 24 deg.C. / 45 %RH

Limit1 : FCC 15C (15.207) QP
Limit2 : FCC 15C (15.207) AV

Engineer : Hiroyuki Morikawa

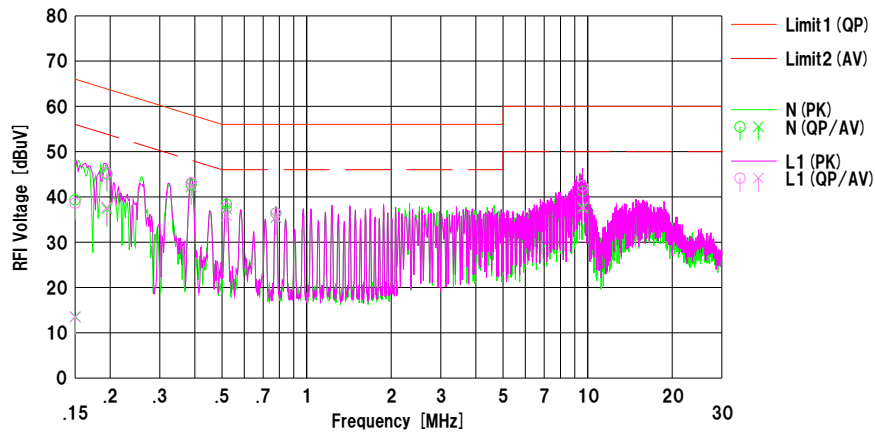

No.	Freq. [MHz]	Reading		C.Fac	Results		Limit		Margin		Phase	Comment
		<QP> [dBuV]	<AV> [dBuV]		<QP> [dBuV]	<AV> [dBuV]	<QP> [dBuV]	<AV> [dBuV]	<QP> [dB]	<AV> [dB]		
1	0.15000	27.00	1.20	12.35	39.35	13.55	66.00	56.00	26.6	42.4	N	
2	0.19480	32.70	25.00	12.34	45.04	37.34	63.83	53.83	18.7	16.4	N	
3	0.38860	30.40	29.80	12.38	42.78	42.18	58.09	48.09	15.3	5.9	N	
4	0.51820	26.00	25.00	12.40	38.40	37.40	56.00	46.00	17.6	8.6	N	
5	0.77670	24.00	23.10	12.42	36.42	35.52	56.00	46.00	19.5	10.4	N	
6	9.58510	28.40	24.60	12.83	41.23	37.43	60.00	50.00	18.7	12.5	N	
7	0.15000	26.30	1.10	12.35	38.65	13.45	66.00	56.00	27.3	42.5	L1	
8	0.19450	33.00	25.40	12.34	45.34	37.74	63.84	53.84	18.5	16.1	L1	
9	0.38870	30.80	30.00	12.38	43.18	42.38	58.09	48.09	14.9	5.7	L1	
10	0.51870	25.20	23.50	12.40	37.60	35.90	56.00	46.00	18.4	10.1	L1	
11	0.77800	24.00	23.10	12.42	36.42	35.52	56.00	46.00	19.5	10.4	L1	
12	9.58480	29.60	25.00	12.83	42.43	37.83	60.00	50.00	17.5	12.1	L1	

Calculation: Result [dBuV] = Reading [dBuV] + C.Fac (LISN+Cable+ATT) [dB]
LISN: SLS-05

DATA OF CONDUCTED EMISSION TEST

UL Japan, Inc. Shonan EMC Lab. No.3 Shielded Room
Date : 2015/10/15

Mode : BLE Tx 2480MHz
Power : DC 3.3 V
Temp./Humi. : 24 deg.C. / 45 %RH

Limit1 : FCC 15C (15.207) QP
Limit2 : FCC 15C (15.207) AV

Engineer : Hiroyuki Morikawa

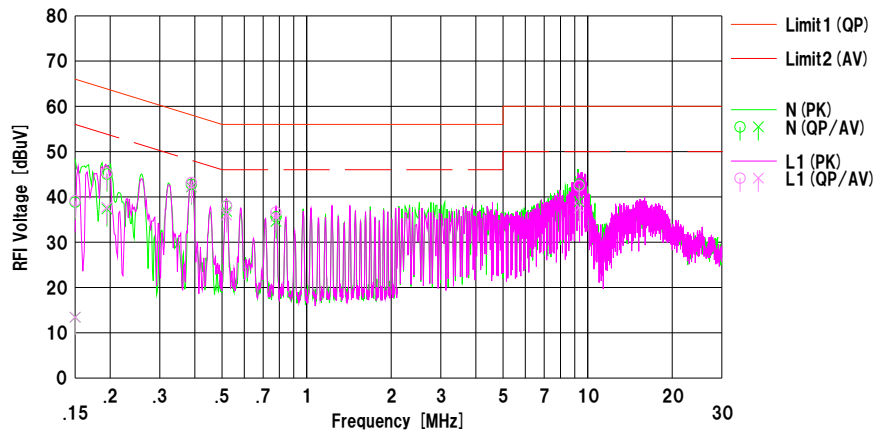

No.	Freq. [MHz]	Reading		C.Fac	Results		Limit		Margin		Phase	Comment
		<QP> [dBuV]	<AV> [dBuV]		<QP> [dBuV]	<AV> [dBuV]	<QP> [dBuV]	<AV> [dBuV]	<QP> [dB]	<AV> [dB]		
1	0.15000	26.50	1.10	12.35	38.85	13.45	66.00	56.00	27.1	42.5	N	
2	0.19470	32.70	25.00	12.34	45.04	37.34	63.83	53.83	18.7	16.4	N	
3	0.38900	30.40	29.80	12.38	42.78	42.18	58.09	48.09	15.3	5.9	N	
4	0.51880	25.60	24.40	12.40	38.00	36.80	56.00	46.00	18.0	9.2	N	
5	0.77840	23.20	22.20	12.42	35.62	34.62	56.00	46.00	20.3	11.3	N	
6	9.32520	30.00	26.10	12.83	42.83	38.93	60.00	50.00	17.1	11.0	N	
7	0.15000	26.80	1.10	12.35	39.15	13.45	66.00	56.00	26.8	42.5	L1	
8	0.19440	33.00	25.40	12.34	45.34	37.74	63.85	53.85	18.5	16.1	L1	
9	0.38910	30.80	30.00	12.38	43.18	42.38	58.08	48.08	14.9	5.7	L1	
10	0.51900	25.70	23.60	12.40	38.10	36.00	56.00	46.00	17.9	10.0	L1	
11	0.77730	24.20	23.30	12.42	36.62	35.72	56.00	46.00	19.3	10.2	L1	
12	9.32460	29.60	24.80	12.83	42.43	37.63	60.00	50.00	17.5	12.3	L1	

Calculation: Result [dBuV] = Reading [dBuV] + C.Fac (LISN+Cable+ATT) [dB]
LISN: SLS-05

S/N: 11

DATA OF CONDUCTED EMISSION TEST

UL Japan, Inc. Shonan EMC Lab. No.3 Shielded Room
Date : 2015/10/15

Mode : BLE Tx 2402MHz
Power : DC 3.3 V
Temp./Humi. : 24 deg.C. / 45 %RH

Limit1 : FCC 15C (15.207) QP
Limit2 : FCC 15C (15.207) AV

Engineer : Hiroyuki Morikawa

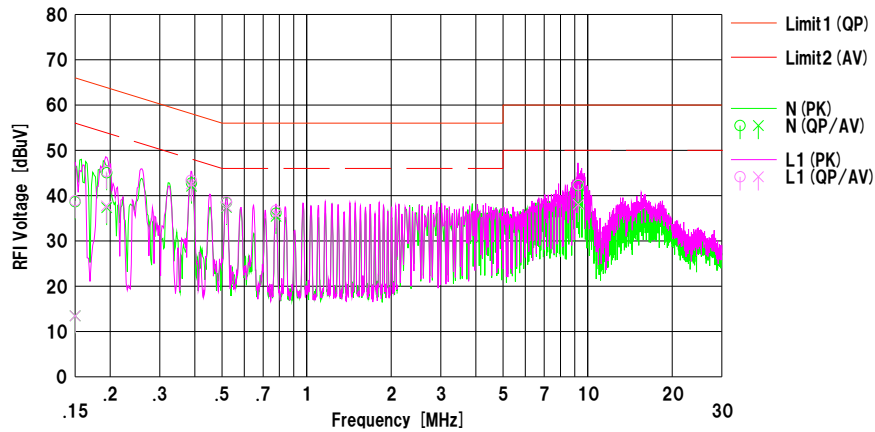

No.	Freq. [MHz]	Reading		C.Fac	Results		Limit		Margin		Phase	Comment
		<QP> [dBuV]	<AV> [dBuV]		<QP> [dBuV]	<AV> [dBuV]	<QP> [dBuV]	<AV> [dBuV]	<QP> [dB]	<AV> [dB]		
1	0.15000	26.30	1.10	12.35	38.65	13.45	66.00	56.00	27.3	42.5	N	
2	0.19440	32.70	25.00	12.34	45.04	37.34	63.85	53.85	18.8	16.5	N	
3	0.38920	30.40	29.70	12.38	42.78	42.08	58.08	48.08	15.3	6.0	N	
4	0.51850	26.10	25.00	12.40	38.50	37.40	56.00	46.00	17.5	8.6	N	
5	0.77790	23.70	23.00	12.42	36.12	35.42	56.00	46.00	19.8	10.5	N	
6	9.26160	29.40	25.50	12.82	42.22	38.32	60.00	50.00	17.7	11.6	N	
7	0.15000	26.50	1.10	12.35	38.85	13.45	66.00	56.00	27.1	42.5	L1	
8	0.19390	33.00	25.40	12.34	45.34	37.74	63.87	53.87	18.5	16.1	L1	
9	0.38860	31.00	30.20	12.38	43.38	42.58	58.09	48.09	14.7	5.5	L1	
10	0.51900	26.20	25.20	12.40	38.60	37.60	56.00	46.00	17.4	8.4	L1	
11	0.77690	24.30	23.50	12.42	36.72	35.92	56.00	46.00	19.2	10.0	L1	
12	9.26280	29.60	25.20	12.82	42.42	38.02	60.00	50.00	17.5	11.9	L1	

Calculation: Result [dBuV] = Reading [dBuV] + C.Fac (LISN+Cable+ATT) [dB]
LISN: SLS-05

DATA OF CONDUCTED EMISSION TEST

UL Japan, Inc. Shonan EMC Lab. No.3 Shielded Room
Date : 2015/10/15

Mode : BLE Tx 2440MHz
Power : DC 3.3 V
Temp./Humi. : 24 deg.C. / 45 %RH

Limit1 : FCC 15C (15.207) QP
Limit2 : FCC 15C (15.207) AV

Engineer : Hiroyuki Morikawa

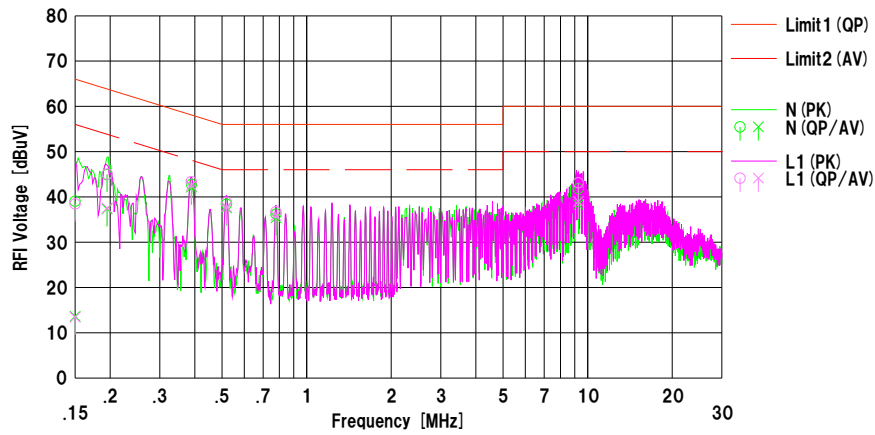

No.	Freq. [MHz]	Reading		C.Fac	Results		Limit		Margin		Phase	Comment
		<QP> [dBuV]	<AV> [dBuV]		<QP> [dBuV]	<AV> [dBuV]	<QP> [dBuV]	<AV> [dBuV]	<QP> [dB]	<AV> [dB]		
1	0.15000	26.70	1.30	12.35	39.05	13.65	66.00	56.00	26.9	42.3	N	
2	0.19480	32.60	25.00	12.34	44.94	37.34	63.83	53.83	18.8	16.4	N	
3	0.38930	30.40	29.80	12.38	42.78	42.18	58.08	48.08	15.3	5.9	N	
4	0.51850	26.00	25.20	12.40	38.40	37.60	56.00	46.00	17.6	8.4	N	
5	0.77780	23.80	23.00	12.42	36.22	35.42	56.00	46.00	19.7	10.5	N	
6	9.26320	29.00	25.50	12.82	41.82	38.32	60.00	50.00	18.1	11.6	N	
7	0.15000	26.10	1.10	12.35	38.45	13.45	66.00	56.00	27.5	42.5	L1	
8	0.19520	32.70	25.20	12.34	45.04	37.54	63.81	53.81	18.7	16.2	L1	
9	0.38890	31.00	30.20	12.38	43.38	42.58	58.09	48.09	14.7	5.5	L1	
10	0.51870	26.40	25.40	12.40	38.80	37.80	56.00	46.00	17.2	8.2	L1	
11	0.77710	24.30	23.50	12.42	36.72	35.92	56.00	46.00	19.2	10.0	L1	
12	9.26240	30.30	26.20	12.82	43.12	39.02	60.00	50.00	16.8	10.9	L1	

Calculation:Result [dBuV] =Reading [dBuV] +C.Fac (LISN+Cable+ATT) [dB]
LISN: SLS-05

DATA OF CONDUCTED EMISSION TEST

UL Japan, Inc. Shonan EMC Lab. No.3 Shielded Room
Date : 2015/10/15

Mode : BLE Tx 2480MHz
Power : DC 3.3 V
Temp./Humi. : 24 deg.C. / 45 %RH

Limit1 : FCC 15C (15.207) QP
Limit2 : FCC 15C (15.207) AV

Engineer : Hiroyuki Morikawa

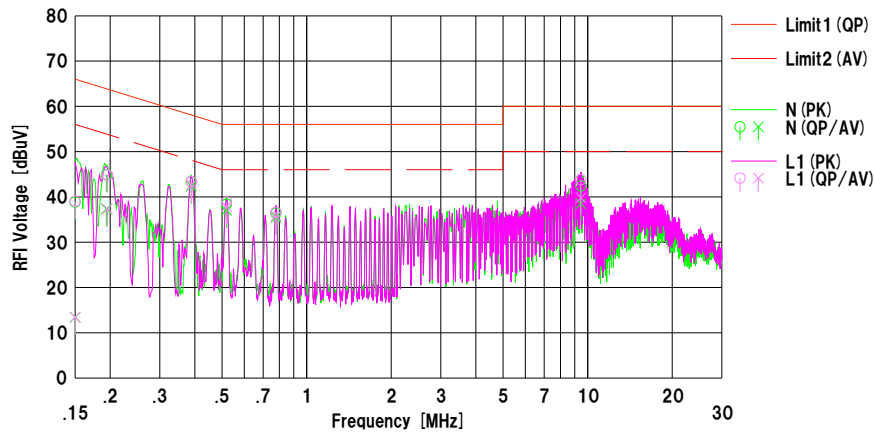

No.	Freq. [MHz]	Reading		C.Fac	Results		Limit		Margin		Phase	Comment
		<QP> [dBuV]	<AV> [dBuV]		<QP> [dBuV]	<AV> [dBuV]	<QP> [dBuV]	<AV> [dBuV]	<QP> [dB]	<AV> [dB]		
1	0.15000	26.50	1.10	12.35	38.85	13.45	66.00	56.00	27.1	42.5	N	
2	0.19390	32.60	25.00	12.34	44.94	37.34	63.87	53.87	18.9	16.5	N	
3	0.38860	31.00	30.00	12.38	43.38	42.38	58.09	48.09	14.7	5.7	N	
4	0.51820	26.00	24.70	12.40	38.40	37.10	56.00	46.00	17.6	8.9	N	
5	0.77790	24.00	23.10	12.42	36.42	35.52	56.00	46.00	19.5	10.4	N	
6	9.45630	29.60	25.70	12.83	42.43	38.53	60.00	50.00	17.5	11.4	N	
7	0.15000	26.70	1.10	12.35	39.05	13.45	66.00	56.00	26.9	42.5	L1	
8	0.19550	32.50	25.00	12.34	44.84	37.34	63.80	53.80	18.9	16.4	L1	
9	0.38910	31.00	30.30	12.38	43.38	42.68	58.08	48.08	14.7	5.4	L1	
10	0.51870	26.50	25.50	12.40	38.90	37.90	56.00	46.00	17.1	8.1	L1	
11	0.77800	24.20	23.40	12.42	36.62	35.82	56.00	46.00	19.3	10.1	L1	
12	9.45720	31.00	27.00	12.83	43.83	39.83	60.00	50.00	16.1	10.1	L1	

Calculation: Result [dBuV] = Reading [dBuV] + C.Fac (LISN+Cable+ATT) [dB]
LISN: SLS-05

6dB Bandwidth

Test place Shonan EMC Lab. No.1 Measurement Room
Report No. 10981928S-A
Date October 1, 2015
Temperature / Humidity 25 deg. C / 48 % RH
Engineer Tomohiro Hara
Mode Tx BT LE

Mode	Frequency [MHz]	6dB Bandwidth [MHz]	Limit [kHz]
BTLE	2402	0.711	> 500
	2440	0.719	> 500
	2480	0.694	> 500

6dB Bandwidth

BTLE

2402 MHz

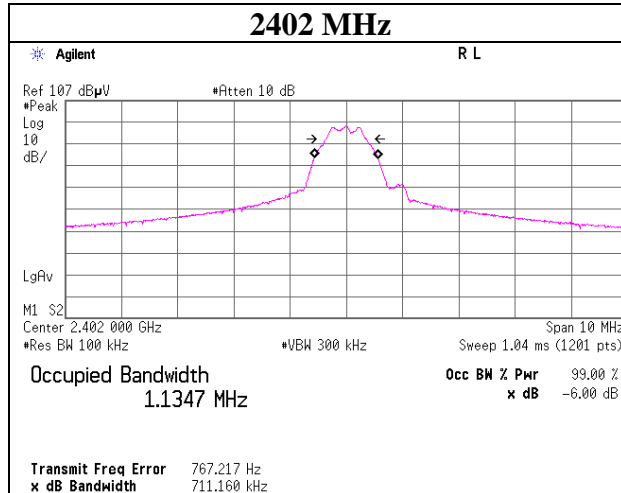

2440 MHz

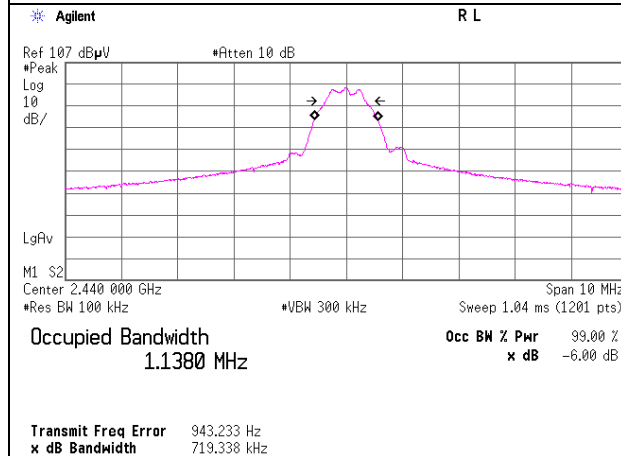

2480 MHz

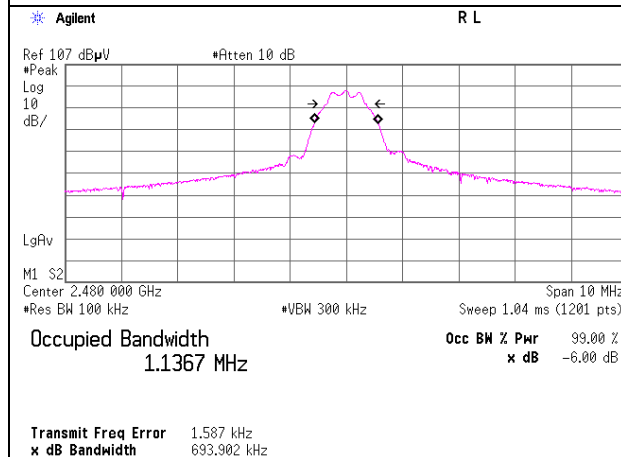

UL Japan, Inc.

Shonan EMC Lab.

1-22-3 Megumigaoka, Hiratsuka-shi, Kanagawa-ken, 259-1220 JAPAN

Telephone : +81 463 50 6400

Facsimile : +81 463 50 6401

Maximum Peak Output Power

Test place Shonan EMC Lab. No.1 Measurement Room
Report No. 10981928S-A
Date October 1, 2015
Temperature / Humidity 25 deg. C / 48 % RH
Engineer Tomohiro Hara
Mode Tx BT LE

Freq. [MHz]	Reading [dBm]	Cable Loss [dB]	Atten. Loss [dB]	Result		Limit		Margin [dB]
				[dBm]	[mW]	[dBm]	[mW]	
2402	-11.65	0.62	9.63	-1.40	0.72	30.00	1000	31.40
2440	-11.74	0.63	9.63	-1.48	0.71	30.00	1000	31.48
2480	-12.03	0.64	9.63	-1.76	0.67	30.00	1000	31.76

Sample Calculation:

Result = Reading + Cable Loss (including the cable(s) customer supplied) + Attenuator Loss

*The equipment and cables were not used for factor 0 dB of the data sheets.

Average Output Power
(Reference data)

Test place Shonan EMC Lab. No.1 Measurement Room
Report No. 10981928S-A
Date October 1, 2015
Temperature / Humidity 25 deg. C / 48 % RH
Engineer Tomohiro Hara
Mode Tx BT LE

BTLE

Freq. [MHz]	Reading [dBm]	Cable Loss [dB]	Atten. Loss [dB]	Result (Frame power)		Duty factor [dB]	Result (Burst power)	
				[dBm]	[mW]		[dBm]	[mW]
2402	-14.03	0.62	9.63	-3.78	0.42	1.42	-2.36	0.58
2440	-14.11	0.63	9.63	-3.85	0.41	1.42	-2.43	0.57
2480	-14.46	0.64	9.63	-4.19	0.38	1.42	-2.77	0.53

Sample Calculation:

Result = Reading + Cable Loss (including the cable(s) customer supplied) + Attenuator Loss

*The equipment and cables were not used for factor 0 dB of the data sheets.

Burst rate confirmation

Test place	Shonan EMC Lab. No.1 Measurement Room
Report No.	10981928S-A
Date	October 1, 2015
Temperature / Humidity	25 deg. C / 48 % RH
Engineer	Tomohiro Hara
Mode	Tx BT LE

BTLE

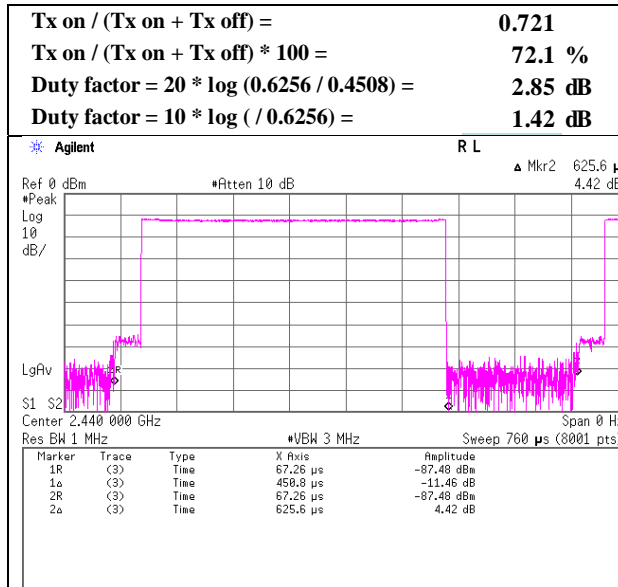

Averaging factor

Test place	Shonan EMC Lab. No.1 Measurement Room
Report No.	10981928S-A
Date	October 1, 2015
Temperature / Humidity	25 deg. C / 48 % RH
Engineer	Tomohiro Hara
Mode	Tx BT LE

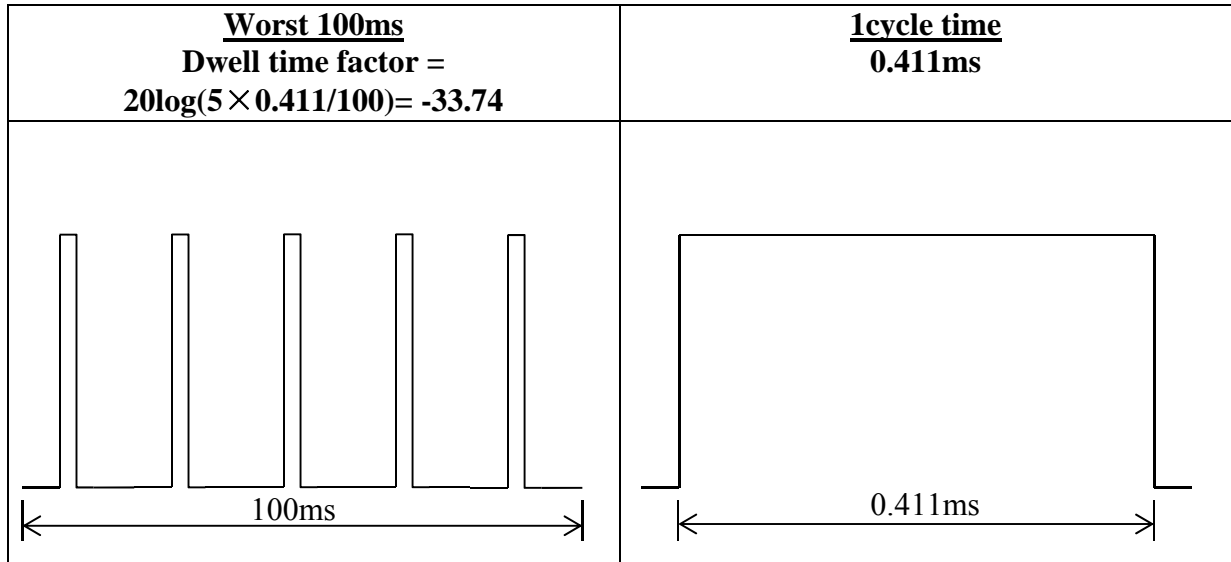

Radiated Spurious Emission

Test place : Shonan EMC Lab. No.3 Semi Anechoic Chamber
Report No. : 10981928S-A
Date : October 9, 2015 October 10, 2015
Temperature / Humidity : 27 deg. C / 40 % RH 25 deg. C / 41 % RH
Engineer : Hiroyuki Morikawa Yasumasa Owaki
 (1-18GHz) (30-1000MHz, 18-25GHz)
Mode : Tx BT LE 2402 MHz, Sample No. 10 + External antenna

(* PK: Peak, AV: Average, QP: Quasi-Peak)

Polarity	Frequency [MHz]	Detector	Reading [dBuV]	Ant. Fac. [dB/m]	Loss [dB]	Gain [dB]	Distance Factor [dB]	Result [dBuV/m]	Limit [dBuV/m]	Margin [dB]	Height [cm]	Angle [deg]	Remark
Hori.	170.219	QP	37.0	15.6	8.0	32.0	0.0	28.6	43.5	14.9	196	38	
Hori.	194.154	QP	39.3	16.3	7.9	32.0	0.0	31.5	43.5	12.0	161	82	
Hori.	2390.000	PK	54.1	27.8	13.7	41.0	3.4	58.0	73.9	15.9	100	0	
Hori.	4804.000	PK	50.6	31.4	5.7	39.6	3.4	51.5	73.9	22.4	100	0	
Hori.	7206.000	PK	50.2	36.9	7.1	40.1	3.4	57.5	73.9	16.4	100	0	
Hori.	9608.000	PK	44.3	38.5	8.2	39.6	3.4	54.8	73.9	19.1	100	0	
Hori.	19216.000	PK	49.3	40.5	11.5	47.9	-9.5	43.9	73.9	30.0	100	211	
Hori.	21618.000	PK	42.6	40.5	12.2	47.2	-9.5	38.6	73.9	35.3	100	240	
Vert.	77.995	QP	47.0	6.3	7.6	32.1	0.0	28.8	40.0	11.2	140	107	
Vert.	80.486	QP	47.7	6.4	7.7	32.1	0.0	29.7	40.0	10.3	135	129	
Vert.	86.759	QP	46.5	7.5	7.7	32.1	0.0	29.6	40.0	10.4	120	138	
Vert.	87.562	QP	46.6	7.7	7.7	32.1	0.0	29.9	40.0	10.1	118	117	
Vert.	2390.000	PK	55.3	27.8	13.7	41.0	3.4	59.2	73.9	14.7	159	137	
Vert.	4804.000	PK	51.3	31.4	5.7	39.6	3.4	52.2	73.9	21.7	100	120	
Vert.	7206.000	PK	53.1	36.9	7.1	40.1	3.4	60.4	73.9	13.5	100	180	
Vert.	9608.000	PK	44.8	38.5	8.2	39.6	3.4	55.3	73.9	18.6	100	0	
Vert.	19216.000	PK	46.9	40.5	11.5	47.9	-9.5	41.5	73.9	32.4	100	206	
Vert.	21618.000	PK	42.4	40.5	12.2	47.2	-9.5	38.4	73.9	35.5	100	141	

Result = Reading + Ant. Fac. + Loss (Cable+(Attenuator or Filter)(below 18 GHz)) - Gain(Amplifier) + Distance factor
Distance factor : 1 GHz - 13 GHz : 20log(4.43 m / 3.0 m) = 3.4 dB
13 GHz - 40 GHz : 20log(1.0 m / 3.0 m) = -9.5 dB

Average measurement value with duty factor

Polarity	Frequency [MHz]	Detector	Reading [dBuV]	Ant. Fac. [dB/m]	Loss [dB]	Gain [dB]	Duty Factor [dB]	Distance Factor [dB]	Averaging Factor [dB]	Result [dBuV/m]	Limit [dBuV/m]	Margin [dB]	Remark
Hori.	2390.000	AV	37.0	27.8	13.7	41.0	2.9	3.4		43.8	53.9	10.1	*1)
Hori.	4804.000	AV	43.4	31.4	5.7	39.6	2.9	3.4	-33.7	13.5	53.9	40.4	
Hori.	7206.000	AV	41.6	36.9	7.1	40.1	2.9	3.4	-33.7	18.1	53.9	35.8	
Hori.	9608.000	AV	35.7	38.5	8.2	39.6	2.9	3.4	-33.7	15.4	53.9	38.5	
Hori.	19216.000	AV	38.5	40.5	11.5	47.9	2.9	-9.5	-33.7	2.3	53.9	51.6	
Hori.	21618.000	AV	34.2	40.5	12.2	47.2	2.9	-9.5	-33.7	-0.6	53.9	54.5	
Vert.	2390.000	AV	37.3	27.8	13.7	41.0	2.9	3.4		44.1	53.9	9.8	*1)
Vert.	4804.000	AV	44.1	31.4	5.7	39.6	2.9	3.4	-33.7	14.2	53.9	39.7	
Vert.	7206.000	AV	45.3	36.9	7.1	40.1	2.9	3.4	-33.7	21.8	53.9	32.1	
Vert.	9608.000	AV	35.7	38.5	8.2	39.6	2.9	3.4	-33.7	15.4	53.9	38.5	
Vert.	19216.000	AV	36.9	40.5	11.5	47.9	2.9	-9.5	-33.7	0.7	53.9	53.2	
Vert.	21618.000	AV	32.7	40.5	12.2	47.2	2.9	-9.5	-33.7	-2.1	53.9	56.0	

Result = Reading + Ant. Fac. + Loss (Cable+(Attenuator or Filter)(below 18 GHz)) - Gain(Amplifier) + Duty factor + Distance factor + Averaging Factor
Distance factor : 1 GHz - 13 GHz : 20log(4.43 m / 3.0 m) = 3.4 dB
13 GHz - 40 GHz : 20log(1.0 m / 3.0 m) = -9.5 dB

Duty factor refer to "Duty factor Calculation chart" sheet.

*1) Not out of band emission (Leakage Power)

20 dBc Data Sheet (RBW 100 kHz, VBW 300 kHz)

Polarity	Frequency [MHz]	Detector	Reading [dBuV]	Ant. Fac. [dB/m]	Loss [dB]	Gain [dB]	Distance Factor [dB]	Result [dBuV/m]	Limit [dBuV/m]	Margin [dB]	Remark
Hori.	2402.000	PK	89.2	27.8	13.7	41.0	3.4	93.1	-	-	Carrier
Hori.	2400.000	PK	51.0	27.8	13.7	41.0	3.4	54.9	73.1	18.2	
Vert.	2402.000	PK	91.7	27.8	13.7	41.0	3.4	95.6	-	-	Carrier
Vert.	2400.000	PK	53.1	27.8	13.7	41.0	3.4	57.0	75.6	18.6	

Result = Reading + Ant. Fac. + Loss (Cable+(Attenuator or Filter)(below 18 GHz)) - Gain(Amplifier) + Distance factor
Distance factor : 1 GHz - 13 GHz : 20log(4.43 m / 3.0 m) = 3.4 dB
13 GHz - 40 GHz : 20log(1.0 m / 3.0 m) = -9.5 dB

UL Japan, Inc.

Shonan EMC Lab.

1-22-3 Megumigaoka, Hiratsuka-shi, Kanagawa-ken, 259-1220 JAPAN

Telephone : +81 463 50 6400

Facsimile : +81 463 50 6401

Radiated Spurious Emission (Reference Plot for band-edge)

Test place	Shonan EMC Lab. No.3 Semi Anechoic Chamber
Report No.	10981928S-A
Date	October 9, 2015
Temperature / Humidity	27 deg. C / 40 % RH
Engineer	Hiroyuki Morikawa (1-13GHz)
Mode	Tx BT LE 2402 MHz, Sample No. 10 + External antenna

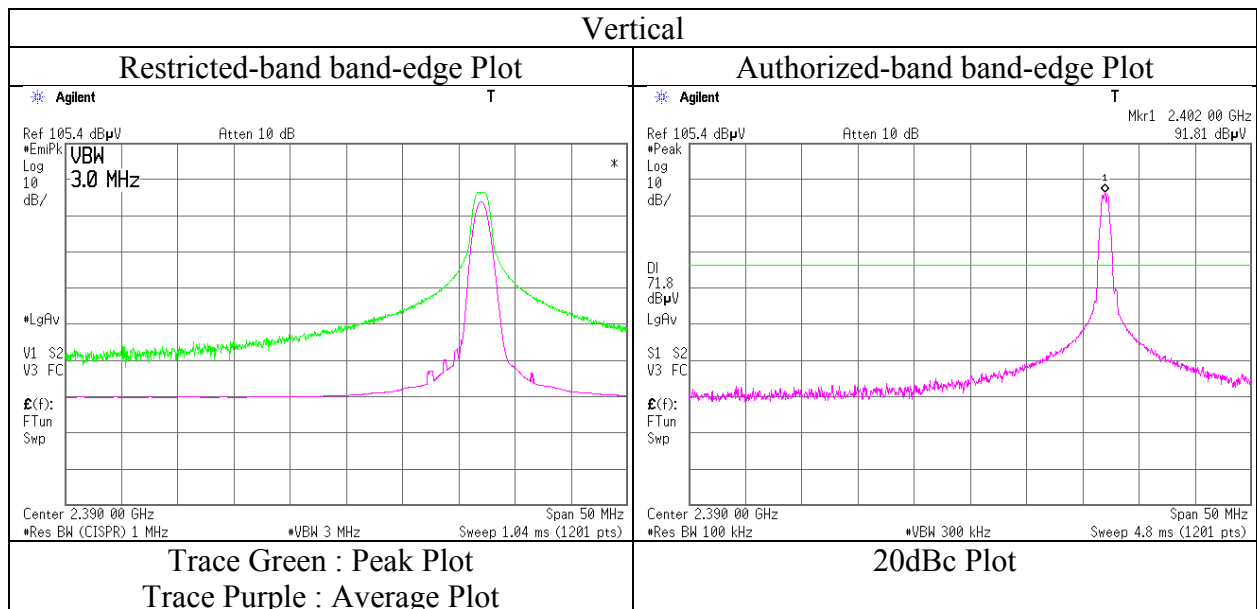
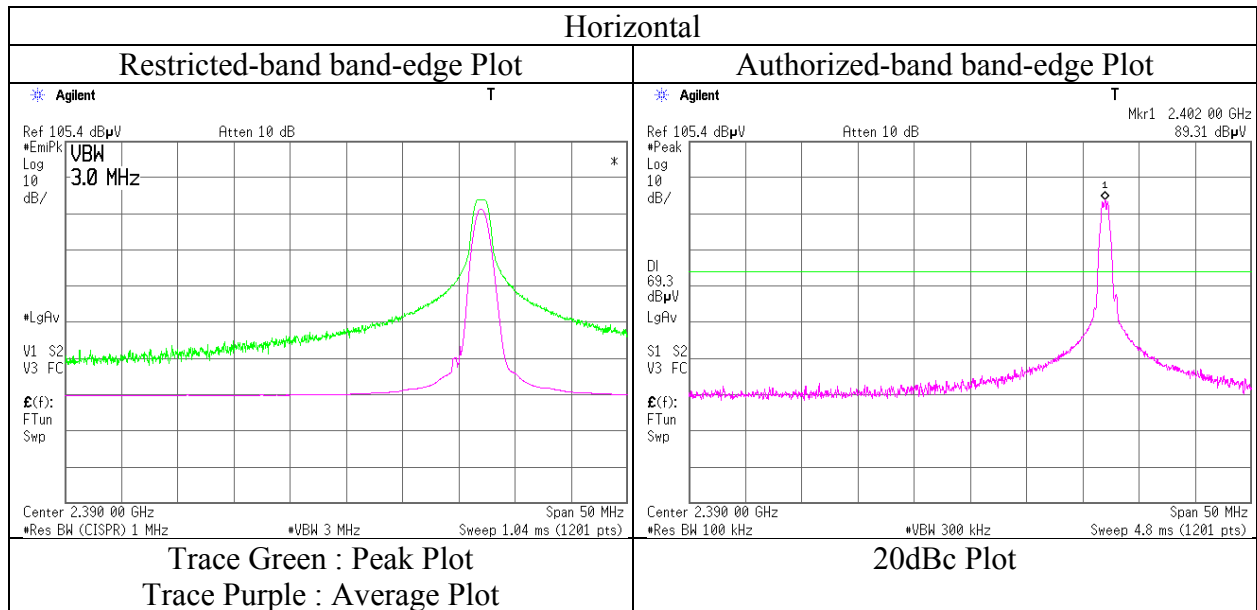

* Final result of restricted band edge was shown in tabular data.

Radiated Spurious Emission

Test place : Shonan EMC Lab. No.3 Semi Anechoic Chamber
Report No. : 10981928S-A
Date : October 9, 2015 October 10, 2015
Temperature / Humidity : 27 deg. C / 40 % RH 25 deg. C / 41 % RH
Engineer : Hiroyuki Morikawa Yasumasa Owaki
 (1-18GHz) (30-1000MHz, 18-25GHz)
Mode : Tx BT LE 2440 MHz, Sample No. 10 + External antenna

(* PK: Peak, AV: Average, QP: Quasi-Peak)

Polarity	Frequency [MHz]	Detector	Reading [dBuV]	Ant.Fac. [dB/m]	Loss [dB]	Gain [dB]	Distance Factor [dB]	Result [dBuV/m]	Limit [dBuV/m]	Margin [dB]	Height [cm]	Angle [deg]	Remark
Hori.	173.324	QP	38.1	15.7	8.0	32.0	0.0	29.8	43.5	13.7	180	19	
Hori.	194.335	QP	38.3	16.3	7.9	32.0	0.0	30.5	43.5	13.0	162	119	
Hori.	4880.000	PK	50.8	31.7	5.8	39.5	3.4	52.2	73.9	21.7	143	1	
Hori.	7320.000	PK	50.4	36.9	7.2	40.2	3.4	57.7	73.9	16.2	174	353	
Hori.	9760.000	PK	44.9	38.5	8.2	39.5	3.4	55.5	73.9	18.4	100	0	
Hori.	19520.000	PK	48.8	40.4	11.6	47.6	-9.5	43.7	73.9	30.2	107	237	
Hori.	21960.000	PK	45.5	40.7	12.4	47.4	-9.5	41.7	73.9	32.2	100	253	
Vert.	81.691	QP	46.3	6.6	7.7	32.1	0.0	28.5	40.0	11.5	130	111	
Vert.	84.235	QP	46.0	7.1	7.7	32.1	0.0	28.7	40.0	11.3	134	98	
Vert.	86.758	QP	46.9	7.5	7.7	32.1	0.0	30.0	40.0	10.0	127	147	
Vert.	87.766	QP	47.5	7.7	7.7	32.1	0.0	30.8	40.0	9.2	116	131	
Vert.	4880.000	PK	51.6	31.7	5.8	39.5	3.4	53.0	73.9	20.9	100	119	
Vert.	7320.000	PK	50.9	36.9	7.2	40.2	3.4	58.2	73.9	15.7	179	151	
Vert.	9760.000	PK	44.9	38.5	8.2	39.5	3.4	55.5	73.9	18.4	100	0	
Vert.	19520.000	PK	46.1	40.4	11.6	47.6	-9.5	41.0	73.9	32.9	100	210	
Vert.	21960.000	PK	41.9	40.7	12.4	47.4	-9.5	38.1	73.9	35.8	100	143	

Result = Reading + Ant.Fac. + Loss (Cable+(Attenuator or Filter)(below 18 GHz)) - Gain(Amplifier) + Distance factor

Distance factor : 1 GHz - 13 GHz : 20log(4.43 m / 3.0 m) = 3.4 dB

13 GHz - 40 GHz : 20log(1.0 m / 3.0 m) = -9.5 dB

Average measurement value with duty factor

Polarity	Frequency [MHz]	Detector	Reading [dBuV]	Ant.Fac. [dB/m]	Loss [dB]	Gain [dB]	Duty Factor [dB]	Distance Factor [dB]	Averaging Factor [dB]	Result [dBuV/m]	Limit [dBuV/m]	Margin [dB]	Remark
Hori.	4880.000	AV	43.5	31.7	5.8	39.5	2.9	3.4	-33.7	14.1	53.9	39.8	
Hori.	7320.000	AV	41.7	36.9	7.2	40.2	2.9	3.4	-33.7	18.2	53.9	35.7	
Hori.	9760.000	AV	36.9	38.5	8.2	39.5	2.9	3.4	-33.7	16.7	53.9	37.2	
Hori.	19520.000	AV	37.4	40.4	11.6	47.6	2.9	-9.5	-33.7	1.5	53.9	52.4	
Hori.	21960.000	AV	35.4	40.7	12.4	47.4	2.9	-9.5	-33.7	0.8	53.9	53.1	
Vert.	4880.000	AV	44.5	31.7	5.8	39.5	2.9	3.4	-33.7	15.1	53.9	38.8	
Vert.	7320.000	AV	42.2	36.9	7.2	40.2	2.9	3.4	-33.7	18.7	53.9	35.2	
Vert.	9760.000	AV	36.0	38.5	8.2	39.5	2.9	3.4	-33.7	15.8	53.9	38.1	
Vert.	19520.000	AV	35.3	40.4	11.6	47.6	2.9	-9.5	-33.7	-0.6	53.9	54.5	
Vert.	21960.000	AV	32.8	40.7	12.4	47.4	2.9	-9.5	-33.7	-1.8	53.9	55.7	

Result = Reading + Ant.Fac. + Loss (Cable+(Attenuator or Filter)(below 18 GHz)) - Gain(Amplifier) + Duty factor + Distance factor + Averaging Factor

Distance factor : 1 GHz - 13 GHz : 20log(4.43 m / 3.0 m) = 3.4 dB

13 GHz - 40 GHz : 20log(1.0 m / 3.0 m) = -9.5 dB

Duty factor refer to "Duty factor Calculation chart" sheet.

*1) Not out of band emission (Leakage Power)

Radiated Spurious Emission

Test place : Shonan EMC Lab. No.3 Semi Anechoic Chamber
Report No. : 10981928S-A
Date : October 9, 2015 October 10, 2015
Temperature / Humidity : 27 deg. C / 40 % RH 25 deg. C / 41 % RH
Engineer : Hiroyuki Morikawa Yasumasa Owaki
 (1-18GHz) (30-1000MHz, 18-25GHz)
Mode : Tx BT LE 2480 MHz, Sample No. 10 + External antenna

(* PK: Peak, AV: Average, QP: Quasi-Peak)													
Polarity	Frequency [MHz]	Detector	Reading [dBuV]	Ant.Fac. [dB/m]	Loss [dB]	Gain [dB]	Distance Factor [dB]	Result [dBuV/m]	Limit [dBuV/m]	Margin [dB]	Height [cm]	Angle [deg]	Remark
Hori.	173.516	QP	37.8	15.7	8.0	32.0	0.0	29.5	43.5	14.0	179	57	
Hori.	195.644	QP	38.2	16.3	8.0	32.0	0.0	30.5	43.5	13.0	158	80	
Hori.	2483.500	PK	62.3	27.9	13.8	41.0	3.4	66.4	73.9	7.5	100	0	
Hori.	4960.000	PK	52.4	32.0	5.8	39.4	3.4	54.2	73.9	19.7	109	13	
Hori.	7440.000	PK	49.3	37.0	7.2	40.4	3.4	56.5	73.9	17.4	121	346	
Hori.	9920.000	PK	45.1	38.4	8.2	39.4	3.4	55.7	73.9	18.2	100	0	
Hori.	19840.000	PK	47.6	40.3	11.7	47.5	-9.5	42.6	73.9	31.3	112	215	
Hori.	22320.000	PK	45.8	40.8	12.5	47.6	-9.5	42.0	73.9	31.9	100	246	
Vert.	77.591	QP	46.7	6.3	7.5	32.1	0.0	28.4	40.0	11.6	125	104	
Vert.	82.160	QP	46.5	6.7	7.7	32.1	0.0	28.8	40.0	11.2	134	121	
Vert.	84.867	QP	47.7	7.2	7.7	32.1	0.0	30.5	40.0	9.5	125	92	
Vert.	86.955	QP	47.1	7.6	7.7	32.1	0.0	30.3	40.0	9.7	113	142	
Vert.	2483.500	PK	62.9	27.9	13.8	41.0	3.4	67.0	73.9	6.9	154	143	
Vert.	4960.000	PK	53.2	32.0	5.8	39.4	3.4	55.0	73.9	18.9	100	120	
Vert.	7440.000	PK	49.6	37.0	7.2	40.4	3.4	56.8	73.9	17.1	100	196	
Vert.	9920.000	PK	44.7	38.4	8.2	39.4	3.4	55.3	73.9	18.6	100	0	
Vert.	19840.000	PK	44.4	40.3	11.7	47.5	-9.5	39.4	73.9	34.5	100	211	
Vert.	22320.000	PK	43.2	40.8	12.5	47.6	-9.5	39.4	73.9	34.5	100	146	

Result = Reading + Ant.Fac. + Loss (Cable+(Attenuator or Filter)(below 18 GHz)) - Gain(Amplifier) + Distance factor

Distance factor : 1 GHz - 13 GHz : 20log(4.43 m / 3.0 m) = 3.4 dB

13 GHz - 40 GHz : 20log(1.0 m / 3.0 m) = -9.5 dB

Average measurement value with duty factor

Polarity	Frequency [MHz]	Detector	Reading [dBuV]	Ant.Fac. [dB/m]	Loss [dB]	Gain [dB]	Duty Factor [dB]	Distance Factor [dB]	Averaging Factor [dB]	Result [dBuV/m]	Limit [dBuV/m]	Margin [dB]	Remark
Hori.	2483.500	AV	40.1	27.9	13.8	41.0	2.9	3.4		47.1	53.9	6.8	*1)
Hori.	4960.000	AV	45.7	32.0	5.8	39.4	2.9	3.4	-33.7	16.7	53.9	37.2	
Hori.	7440.000	AV	40.0	37.0	7.2	40.4	2.9	3.4	-33.7	16.4	53.9	37.5	
Hori.	9920.000	AV	36.4	38.4	8.2	39.4	2.9	3.4	-33.7	16.2	53.9	37.7	
Hori.	19840.000	AV	36.6	40.3	11.7	47.5	2.9	-9.5	-33.7	0.8	53.9	53.1	
Hori.	22320.000	AV	35.8	40.8	12.5	47.6	2.9	-9.5	-33.7	1.2	53.9	52.7	
Vert.	2483.500	AV	40.4	27.9	13.8	41.0	2.9	3.4		47.4	53.9	6.5	*1)
Vert.	4960.000	AV	47.5	32.0	5.8	39.4	2.9	3.4	-33.7	18.5	53.9	35.4	
Vert.	7440.000	AV	41.2	37.0	7.2	40.4	2.9	3.4	-33.7	17.6	53.9	36.3	
Vert.	9920.000	AV	36.3	38.4	8.2	39.4	2.9	3.4	-33.7	16.1	53.9	37.8	
Vert.	19840.000	AV	33.8	40.3	11.7	47.5	2.9	-9.5	-33.7	-2.0	53.9	55.9	
Vert.	22320.000	AV	33.4	40.8	12.5	47.6	2.9	-9.5	-33.7	-1.2	53.9	55.1	

Result = Reading + Ant.Fac. + Loss (Cable+(Attenuator or Filter)(below 18 GHz)) - Gain(Amplifier) + Duty factor + Distance factor + Averaging Factor

Distance factor : 1 GHz - 13 GHz : 20log(4.43 m / 3.0 m) = 3.4 dB

13 GHz - 40 GHz : 20log(1.0 m / 3.0 m) = -9.5 dB

Duty factor refer to "Duty factor Calculation chart" sheet.

*1) Not out of band emission (Leakage Power)

Radiated Spurious Emission
(Reference Plot for band-edge)

Test place : Shonan EMC Lab. No.3 Semi Anechoic Chamber
Report No. : 10981928S-A
Date : October 9, 2015
Temperature / Humidity : 27 deg. C / 40 % RH
Engineer : Hiroyuki Morikawa
(1-13GHz)
Mode : Tx BT LE 2480 MHz, Sample No. 10 + External antenna

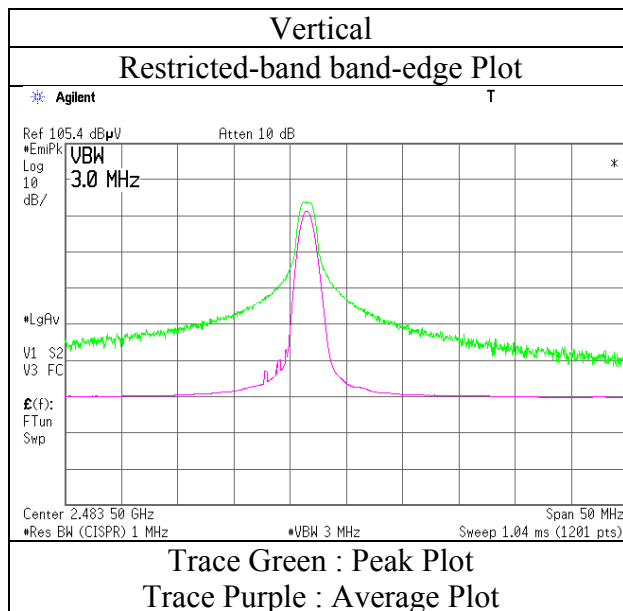
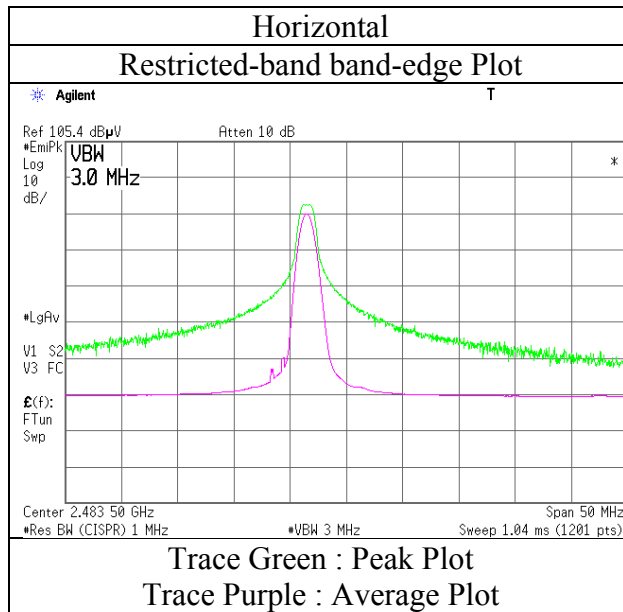

* Final result of restricted band edge was shown in tabular data.

Radiated Spurious Emission

Test place : Shonan EMC Lab. No.3 Semi Anechoic Chamber
Report No. : 10981928S-A
Date : October 9, 2015 October 10, 2015
Temperature / Humidity : 27 deg. C / 40 % RH 25 deg. C / 41 % RH
Engineer : Hiroyuki Morikawa Yasumasa Owaki
 (1-18GHz) (30-1000MHz, 18-25GHz)
Mode : Tx BT LE 2402 MHz, Sample No. 11

(* PK: Peak, AV: Average, QP: Quasi-Peak)

Polarity	Frequency [MHz]	Detector	Reading [dBuV]	Ant. Fac. [dB/m]	Loss [dB]	Gain [dB]	Distance Factor [dB]	Result [dBuV/m]	Limit [dBuV/m]	Margin [dB]	Height [cm]	Angle [deg]	Remark
Hori.	170.629	QP	41.2	15.6	8.0	32.0	0.0	32.8	43.5	10.7	192	192	
Hori.	194.195	QP	36.9	16.3	7.9	32.0	0.0	29.1	43.5	14.4	177	132	
Hori.	2390.000	PK	47.6	27.8	13.7	41.0	3.5	51.6	73.9	22.3	100	341	
Hori.	4804.000	PK	47.0	31.4	5.7	39.6	3.5	48.0	73.9	25.9	150	200	
Hori.	7206.000	PK	49.3	36.9	7.1	40.1	3.5	56.7	73.9	17.2	122	242	
Hori.	9608.000	PK	43.9	38.5	8.2	39.6	3.5	54.5	73.9	19.4	100	0	
Hori.	19216.000	PK	51.9	40.5	11.5	47.9	-9.5	46.5	73.9	27.4	100	341	
Hori.	21618.000	PK	49.3	40.5	12.2	47.2	-9.5	45.3	73.9	28.6	103	327	
Vert.	76.707	QP	45.1	6.3	7.5	32.1	0.0	26.8	40.0	13.2	138	103	
Vert.	81.951	QP	44.7	6.6	7.7	32.1	0.0	26.9	40.0	13.1	139	179	
Vert.	85.473	QP	46.3	7.3	7.7	32.1	0.0	29.2	40.0	10.8	125	183	
Vert.	87.756	QP	45.7	7.7	7.7	32.1	0.0	29.0	40.0	11.0	116	170	
Vert.	2390.000	PK	47.3	27.8	13.7	41.0	3.5	51.3	73.9	22.6	175	70	
Vert.	4804.000	PK	45.9	31.4	5.7	39.6	3.5	46.9	73.9	27.0	100	306	
Vert.	7206.000	PK	46.5	36.9	7.1	40.1	3.5	53.9	73.9	20.0	100	272	
Vert.	9608.000	PK	44.7	38.5	8.2	39.6	3.5	55.3	73.9	18.6	100	0	
Vert.	19216.000	PK	50.4	40.5	11.5	47.9	-9.5	45.0	73.9	28.9	126	276	
Vert.	21618.000	PK	49.1	40.5	12.2	47.2	-9.5	45.1	73.9	28.8	100	232	

Result = Reading + Ant. Fac. + Loss (Cable+(Attenuator or Filter)(below 18 GHz)) - Gain(Amplifier) + Distance factor
Distance factor : 1 GHz - 13 GHz : 20log(4.47 m / 3.0 m) = 3.5 dB
13 GHz - 40 GHz : 20log(1.0 m / 3.0 m) = -9.5 dB

Average measurement value with duty factor

Polarity	Frequency [MHz]	Detector	Reading [dBuV]	Ant. Fac. [dB/m]	Loss [dB]	Gain [dB]	Duty Factor [dB]	Distance Factor [dB]	Averaging Factor [dB]	Result [dBuV/m]	Limit [dBuV/m]	Margin [dB]	Remark
Hori.	2390.000	AV	36.5	27.8	13.7	41.0	2.9	3.5		43.4	53.9	10.5	*1)
Hori.	4804.000	AV	39.0	31.4	5.7	39.6	2.9	3.5	-33.7	9.2	53.9	44.7	
Hori.	7206.000	AV	40.9	36.9	7.1	40.1	2.9	3.5	-33.7	17.5	53.9	36.4	
Hori.	9608.000	AV	35.5	38.5	8.2	39.6	2.9	3.5	-33.7	15.3	53.9	38.6	
Hori.	19216.000	AV	40.9	40.5	11.5	47.9	2.9	-9.5	-33.7	4.7	53.9	49.2	
Hori.	21618.000	AV	38.5	40.5	12.2	47.2	2.9	-9.5	-33.7	3.7	53.9	50.2	
Vert.	2390.000	AV	37.4	27.8	13.7	41.0	2.9	3.5		44.3	53.9	9.6	*1)
Vert.	4804.000	AV	37.7	31.4	5.7	39.6	2.9	3.5	-33.7	7.9	53.9	46.0	
Vert.	7206.000	AV	37.5	36.9	7.1	40.1	2.9	3.5	-33.7	14.1	53.9	39.8	
Vert.	9608.000	AV	35.7	38.5	8.2	39.6	2.9	3.5	-33.7	15.5	53.9	38.4	
Vert.	19216.000	AV	39.3	40.5	11.5	47.9	2.9	-9.5	-33.7	3.1	53.9	50.8	
Vert.	21618.000	AV	37.4	40.5	12.2	47.2	2.9	-9.5	-33.7	2.6	53.9	51.3	

Result = Reading + Ant. Fac. + Loss (Cable+(Attenuator or Filter)(below 18 GHz)) - Gain(Amplifier) + Duty factor + Distance factor
Distance factor : 1 GHz - 13 GHz : 20log(4.47 m / 3.0 m) = 3.5 dB
13 GHz - 40 GHz : 20log(1.0 m / 3.0 m) = -9.5 dB

Duty factor refer to "Duty factor Calculation chart" sheet.

*1) Not out of band emission (Leakage Power)

20 dBc Data Sheet (RBW 100 kHz, VBW 300 kHz)

Polarity	Frequency [MHz]	Detector	Reading [dBuV]	Ant. Fac. [dB/m]	Loss [dB]	Gain [dB]	Distance Factor [dB]	Result [dBuV/m]	Limit [dBuV/m]	Margin [dB]	Remark
Hori.	2402.000	PK	79.3	27.8	13.7	41.0	3.5	83.3	-	-	Carrier
Hori.	2400.000	PK	43.2	27.8	13.7	41.0	3.5	47.2	63.2	16.0	
Vert.	2402.000	PK	77.9	27.8	13.7	41.0	3.5	81.9	-	-	Carrier
Vert.	2400.000	PK	42.0	27.8	13.7	41.0	3.5	46.0	61.9	15.9	

Result = Reading + Ant. Fac. + Loss (Cable+(Attenuator or Filter)(below 18 GHz)) - Gain(Amplifier) + Distance factor + Averaging Factor
Distance factor : 1 GHz - 13 GHz : 20log(4.47 m / 3.0 m) = 3.5 dB
13 GHz - 40 GHz : 20log(1.0 m / 3.0 m) = -9.5 dB

UL Japan, Inc.

Shonan EMC Lab.

1-22-3 Megumigaoka, Hiratsuka-shi, Kanagawa-ken, 259-1220 JAPAN

Telephone : +81 463 50 6400

Facsimile : +81 463 50 6401

Radiated Spurious Emission
(Reference Plot for band-edge)

Test place	Shonan EMC Lab. No3 Semi Anechoic Chamber
Report No.	10981928S-A
Date	October 9, 2015
Temperature / Humidity	27 deg. C / 40 % RH
Engineer	Hiroyuki Morikawa (1-13GHz)
Mode	Tx BT LE 2402 MHz, Sample No. 11

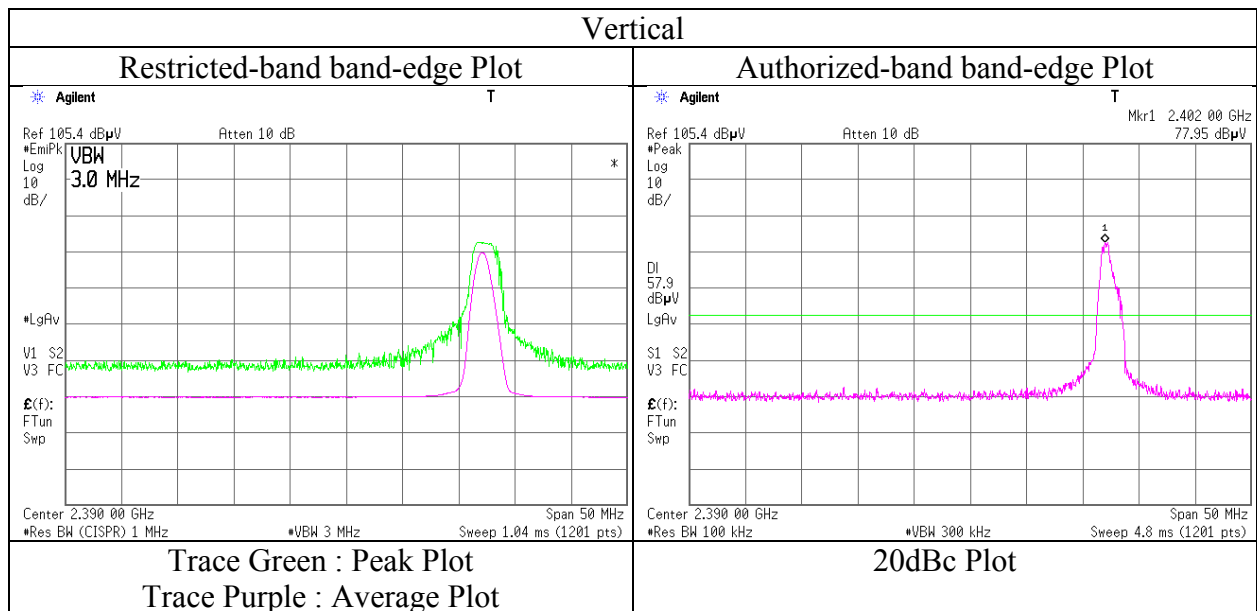
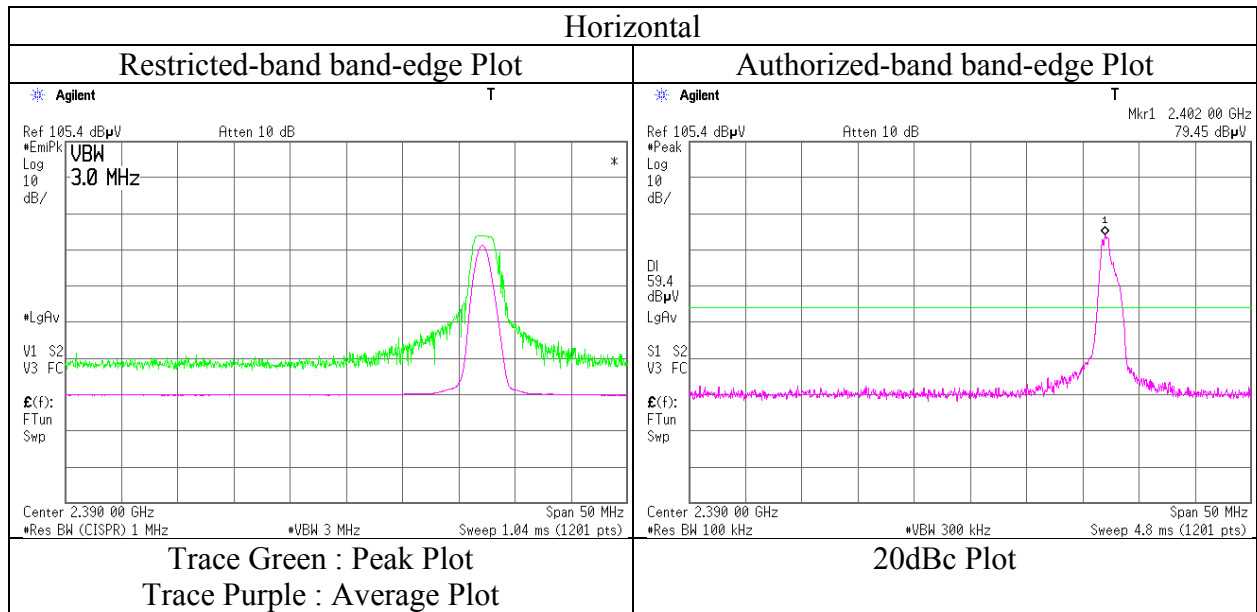

* Final result of restricted band edge was shown in tabular data.

Radiated Spurious Emission

Test place : Shonan EMC Lab. No.3 Semi Anechoic Chamber
Report No. : 10981928S-A
Date : October 9, 2015 October 10, 2015
Temperature / Humidity : 27 deg. C / 40 % RH 25 deg. C / 41 % RH
Engineer : Hiroyuki Morikawa Yasumasa Owaki
 (1-18GHz) (30-1000MHz, 18-25GHz)
Mode : Tx BT LE 2440 MHz, Sample No. 11

(* PK: Peak, AV: Average, QP: Quasi-Peak)

Polarity	Frequency [MHz]	Detector	Reading [dBuV]	Ant.Fac. [dB/m]	Loss [dB]	Gain [dB]	Distance Factor [dB]	Result [dBuV/m]	Limit [dBuV/m]	Margin [dB]	Height [cm]	Angle [deg]	Remark
Hori.	173.324	QP	38.1	15.7	8.0	32.0	0.0	29.8	43.5	13.7	180	19	
Hori.	194.335	QP	38.3	16.3	7.9	32.0	0.0	30.5	43.5	13.0	162	119	
Hori.	4880.000	PK	46.3	31.7	5.8	39.5	3.5	47.8	73.9	26.1	109	262	
Hori.	7320.000	PK	47.7	36.9	7.2	40.2	3.5	55.1	73.9	18.8	109	79	
Hori.	9760.000	PK	44.5	38.5	8.2	39.5	3.5	55.2	73.9	18.7	100	0	
Hori.	19520.000	PK	51.8	40.4	11.6	47.6	-9.5	46.7	73.9	27.2	100	338	
Hori.	21960.000	PK	47.4	40.7	12.4	47.4	-9.5	43.6	73.9	30.3	103	325	
Vert.	81.691	QP	46.3	6.6	7.7	32.1	0.0	28.5	40.0	11.5	130	111	
Vert.	84.235	QP	46.0	7.1	7.7	32.1	0.0	28.7	40.0	11.3	134	98	
Vert.	86.758	QP	46.9	7.5	7.7	32.1	0.0	30.0	40.0	10.0	127	147	
Vert.	87.766	QP	47.5	7.7	7.7	32.1	0.0	30.8	40.0	9.2	116	131	
Vert.	4880.000	PK	45.7	31.7	5.8	39.5	3.5	47.2	73.9	26.7	127	160	
Vert.	7320.000	PK	47.4	36.9	7.2	40.2	3.5	54.8	73.9	19.1	111	122	
Vert.	9760.000	PK	44.8	38.5	8.2	39.5	3.5	55.5	73.9	18.4	100	0	
Vert.	19520.000	PK	49.4	40.4	11.6	47.6	-9.5	44.3	73.9	29.6	108	216	
Vert.	21960.000	PK	46.7	40.7	12.4	47.4	-9.5	42.9	73.9	31.0	100	233	

Result = Reading + Ant.Fac. + Loss (Cable+(Attenuator or Filter)(below 18 GHz)) - Gain(Amplifier) + Distance factor

Distance factor : 1 GHz - 13 GHz : 20log(4.47 m / 3.0 m) = 3.5 dB

13 GHz - 40 GHz : 20log(1.0 m / 3.0 m) = -9.5 dB

Average measurement value with duty factor

Polarity	Frequency [MHz]	Detector	Reading [dBuV]	Ant.Fac. [dB/m]	Loss [dB]	Gain [dB]	Duty Factor [dB]	Distance Factor [dB]	Averaging Factor [dB]	Result [dBuV/m]	Limit [dBuV/m]	Margin [dB]	Remark
Hori.	4880.000	AV	37.6	31.7	5.8	39.5	2.9	3.5	-33.7	8.3	53.9	45.6	
Hori.	7320.000	AV	38.7	36.9	7.2	40.2	2.9	3.5	-33.7	15.3	53.9	38.6	
Hori.	9760.000	AV	36.2	38.5	8.2	39.5	2.9	3.5	-33.7	16.1	53.9	37.8	
Hori.	19520.000	AV	41.2	40.4	11.6	47.6	2.9	-9.5	-33.7	5.3	53.9	48.6	
Hori.	21960.000	AV	36.9	40.7	12.4	47.4	2.9	-9.5	-33.7	2.3	53.9	51.6	
Vert.	4880.000	AV	37.5	31.7	5.8	39.5	2.9	3.5	-33.7	8.2	53.9	45.7	
Vert.	7320.000	AV	38.7	36.9	7.2	40.2	2.9	3.5	-33.7	15.3	53.9	38.6	
Vert.	9760.000	AV	36.0	38.5	8.2	39.5	2.9	3.5	-33.7	15.9	53.9	38.0	
Vert.	19520.000	AV	39.9	40.4	11.6	47.6	2.9	-9.5	-33.7	4.0	53.9	49.9	
Vert.	21960.000	AV	37.1	40.7	12.4	47.4	2.9	-9.5	-33.7	2.5	53.9	51.4	

Result = Reading + Ant.Fac. + Loss (Cable+(Attenuator or Filter)(below 18 GHz)) - Gain(Amplifier) + Duty factor + Distance factor + Averaging Factor

Distance factor : 1 GHz - 13 GHz : 20log(4.47 m / 3.0 m) = 3.5 dB

13 GHz - 40 GHz : 20log(1.0 m / 3.0 m) = -9.5 dB

Duty factor refer to "Duty factor Calculation chart" sheet.

*1) Not out of band emission (Leakage Power)

Radiated Spurious Emission

Test place : Shonan EMC Lab. No.3 Semi Anechoic Chamber
Report No. : 10981928S-A
Date : October 9, 2015 October 10, 2015
Temperature / Humidity : 27 deg. C / 40 % RH 25 deg. C / 41 % RH
Engineer : Hiroyuki Morikawa Yasumasa Owaki
 (1-18GHz) (30-1000MHz, 18-25GHz)
Mode : Tx BT LE 2480 MHz, Sample No. 11

(* PK: Peak, AV: Average, QP: Quasi-Peak)

Polarity	Frequency [MHz]	Detector	Reading [dBuV]	Ant.Fac. [dB/m]	Loss [dB]	Gain [dB]	Distance Factor [dB]	Result [dBuV/m]	Limit [dBuV/m]	Margin [dB]	Height [cm]	Angle [deg]	Remark
Hori.	169.835	QP	41.3	15.6	8.0	32.0	0.0	32.9	43.5	10.6	201	190	
Hori.	194.452	QP	37.9	16.3	7.9	32.0	0.0	30.1	43.5	13.4	168	128	
Hori.	2483.500	PK	55.3	27.9	13.8	41.0	3.5	59.5	73.9	14.4	100	339	
Hori.	4960.000	PK	46.9	32.0	5.8	39.4	3.5	48.8	73.9	25.1	118	153	
Hori.	7440.000	PK	47.9	37.0	7.2	40.4	3.5	55.2	73.9	18.7	137	92	
Hori.	9920.000	PK	45.3	38.4	8.2	39.4	3.5	56.0	73.9	17.9	100	0	
Hori.	19840.000	PK	52.6	40.3	11.7	47.5	-9.5	47.6	73.9	26.3	100	329	
Hori.	22320.000	PK	47.9	40.8	12.5	47.6	-9.5	44.1	73.9	29.8	103	319	
Vert.	73.414	QP	46.0	6.3	7.2	32.1	0.0	27.4	40.0	12.6	118	163	
Vert.	80.290	QP	46.1	6.3	7.7	32.1	0.0	28.0	40.0	12.0	123	118	
Vert.	80.885	QP	46.0	6.5	7.7	32.1	0.0	28.1	40.0	11.9	128	185	
Vert.	83.573	QP	45.9	7.0	7.7	32.1	0.0	28.5	40.0	11.5	130	126	
Vert.	2483.500	PK	53.7	27.9	13.8	41.0	3.5	57.9	73.9	16.0	100	39	
Vert.	4960.000	PK	46.2	32.0	5.8	39.4	3.5	48.1	73.9	25.8	130	239	
Vert.	7440.000	PK	46.9	37.0	7.2	40.4	3.5	54.2	73.9	19.7	127	127	
Vert.	9920.000	PK	45.6	38.4	8.2	39.4	3.5	56.3	73.9	17.6	100	0	
Vert.	19840.000	PK	50.4	40.3	11.7	47.5	-9.5	45.4	73.9	28.5	102	223	
Vert.	22320.000	PK	46.3	40.8	12.5	47.6	-9.5	42.5	73.9	31.4	105	92	

Result = Reading + Ant.Fac. + Loss (Cable+(Attenuator or Filter)(below 18 GHz)) - Gain(Amplifier) + Distance factor
Distance factor : 1 GHz - 13 GHz : 20log(4.47 m / 3.0 m) = 3.5 dB
13 GHz - 40 GHz : 20log(1.0 m / 3.0 m) = -9.5 dB

Average measurement value with duty factor

Polarity	Frequency [MHz]	Detector	Reading [dBuV]	Ant.Fac. [dB/m]	Loss [dB]	Gain [dB]	Duty Factor [dB]	Distance Factor [dB]	Averaging Factor [dB]	Result [dBuV/m]	Limit [dBuV/m]	Margin [dB]	Remark
Hori.	2483.500	AV	38.0	27.9	13.8	41.0	2.9	3.5		45.1	53.9	8.8	*1)
Hori.	4960.000	AV	38.6	32.0	5.8	39.4	2.9	3.5	-33.7	9.7	53.9	44.2	
Hori.	7440.000	AV	39.2	37.0	7.2	40.4	2.9	3.5	-33.7	15.7	53.9	38.2	
Hori.	9920.000	AV	36.2	38.4	8.2	39.4	2.9	3.5	-33.7	16.1	53.9	37.8	
Hori.	19840.000	AV	42.2	40.3	11.7	47.5	2.9	-9.5	-33.7	6.4	53.9	47.5	
Hori.	22320.000	AV	36.8	40.8	12.5	47.6	2.9	-9.5	-33.7	2.2	53.9	51.7	
Vert.	2483.500	AV	37.2	27.9	13.8	41.0	2.9	3.5		44.3	53.9	9.6	*1)
Vert.	4960.000	AV	37.7	32.0	5.8	39.4	2.9	3.5	-33.7	8.8	53.9	45.1	
Vert.	7440.000	AV	38.2	37.0	7.2	40.4	2.9	3.5	-33.7	14.7	53.9	39.2	
Vert.	9920.000	AV	36.2	38.4	8.2	39.4	2.9	3.5	-33.7	16.1	53.9	37.8	
Vert.	19840.000	AV	40.1	40.3	11.7	47.5	2.9	-9.5	-33.7	4.3	53.9	49.6	
Vert.	22320.000	AV	36.2	40.8	12.5	47.6	2.9	-9.5	-33.7	1.6	53.9	52.3	

Result = Reading + Ant.Fac. + Loss (Cable+(Attenuator or Filter)(below 18 GHz)) - Gain(Amplifier) + Duty factor + Distance factor + Averaging Factor
Distance factor : 1 GHz - 13 GHz : 20log(4.47 m / 3.0 m) = 3.5 dB
13 GHz - 40 GHz : 20log(1.0 m / 3.0 m) = -9.5 dB

Duty factor refer to "Duty factor Calculation chart" sheet.

*1) Not out of band emission (Leakage Power)

Radiated Spurious Emission
(Reference Plot for band-edge)

Test place	Shonan EMC Lab. No.3 Semi Anechoic Chamber
Report No.	10981928S-A
Date	October 9, 2015
Temperature / Humidity	27 deg. C / 40 % RH
Engineer	Hiroyuki Morikawa (1-13GHz)
Mode	Tx BT LE 2462 MHz, Sample No. 11

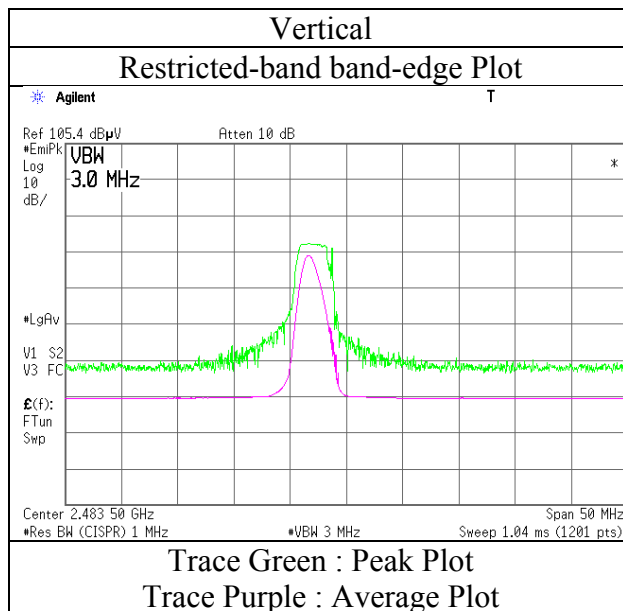
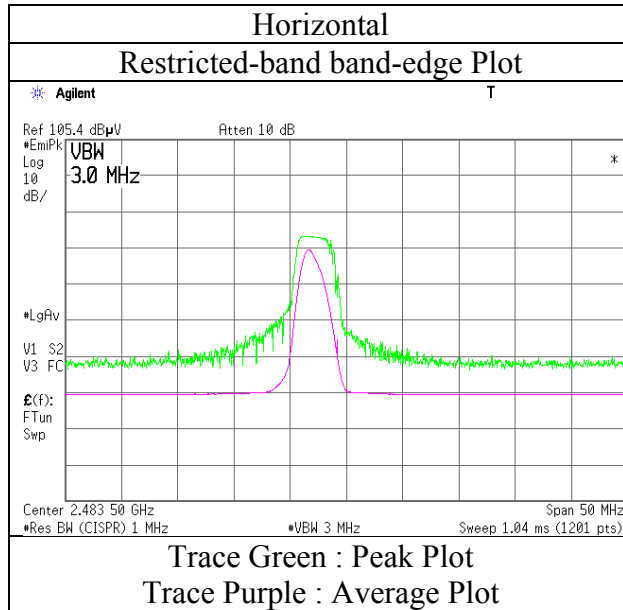

* Final result of restricted band edge was shown in tabular data.

Radiated Spurious Emission (Plot data, Worst case)

Test place	Shonan EMC Lab. No.3 Semi Anechoic Chamber	
Report No.	10981928S-A	
Date	October 9, 2015	October 10, 2015
Temperature / Humidity	27 deg. C / 40 % RH	25 deg. C / 41 % RH
Engineer	Hiroyuki Morikawa	Yasumasa Owaki
	(1-18GHz)	(30-1000MHz, 18-25GHz)
Mode	Tx BT LE 2460 MHz, Sample No. 10 + External antenna	

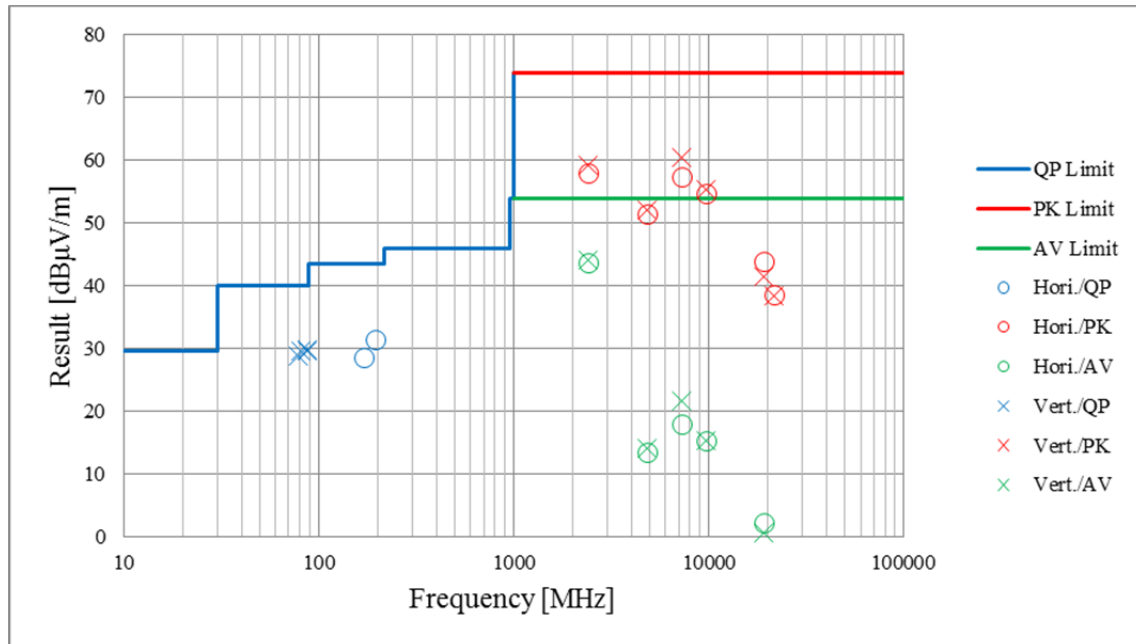

*These plots data contains sufficient number to show the trend of characteristic features for EUT.

Conducted Spurious Emission

Test place	Shonan EMC Lab. No.1 Measurement Room
Report No.	10981928S-A
Date	October 1, 2015
Temperature / Humidity	25 deg. C / 48 % RH
Engineer	Tomohiro hara
Mode	Tx BT LE 2402 MHz

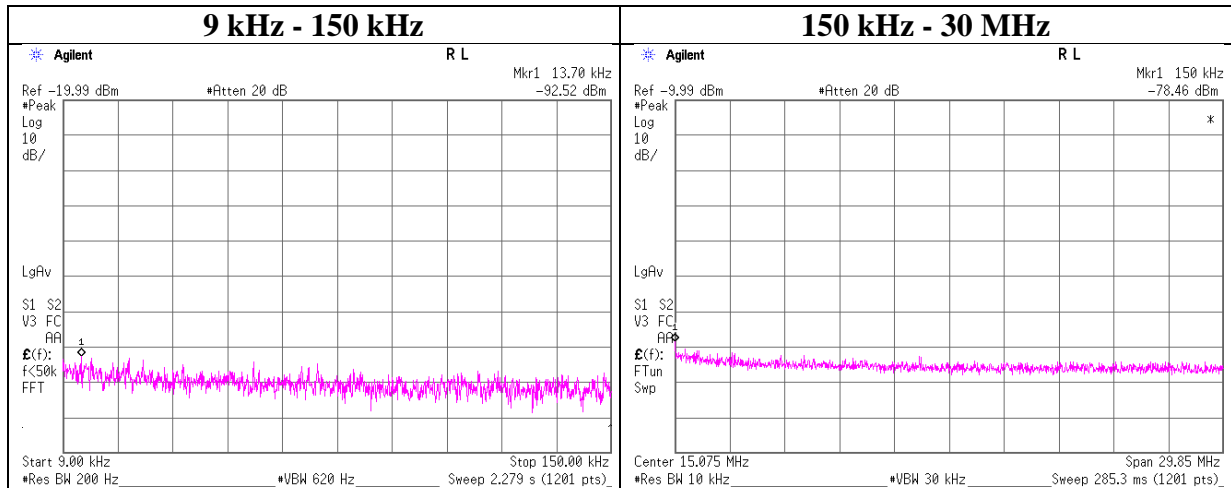

Frequency [kHz]	Reading [dBm]	Cable Loss [dB]	Attenuator Loss [dB]	Antenna Gain [dBi]	N (Number of Output)	EIRP [dBm]	Distance [m]	Ground bounce [dB]	E (field strength) [dBuV/m]	Limit [dBuV/m]	Margin [dB]	Remark
13.70	-92.5	0.01	9.5	2.0	1	-81.0	300	6.0	-19.7	44.8	64.5	
150.00	-78.5	0.01	9.5	2.0	1	-66.9	300	6.0	-5.7	24.0	29.7	

$E = \text{EIRP} - 20 \log(D) + \text{Ground bounce} + 104.8 \text{ [dBuV/m]}$

$\text{EIRP} = \text{Reading} + \text{Cable Loss} + \text{Attenuator Loss} + \text{Antenna Gain} + 10 * \log(N)$

Conducted Spurious Emission

Test place	Shonan EMC Lab. No.1 Measurement Room
Report No.	10981928S-A
Date	October 1, 2015
Temperature / Humidity	25 deg. C / 48 % RH
Engineer	Tomohiro Hara
Mode	Tx BT LE 2440 MHz

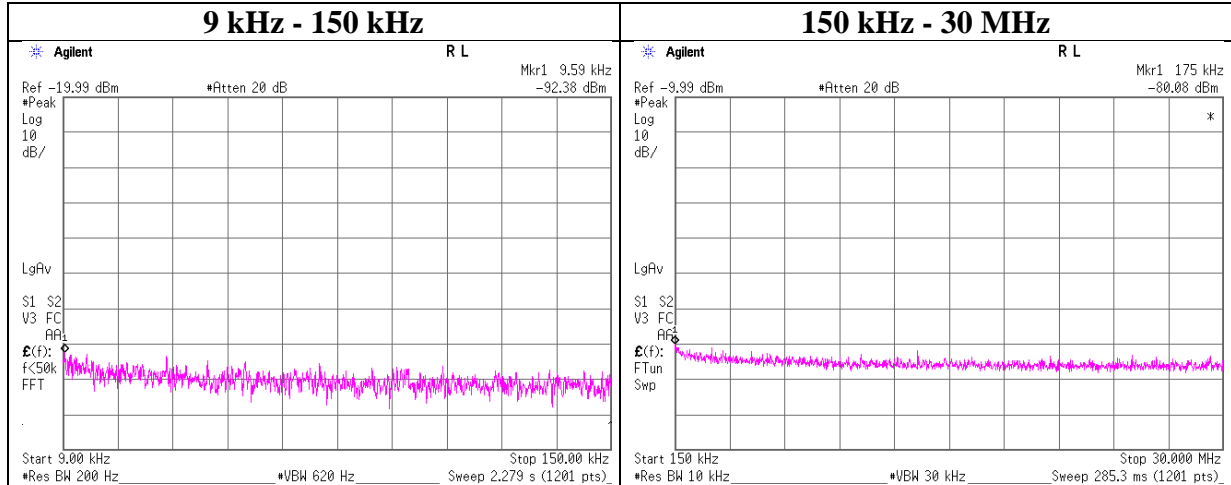

Frequency	Reading	Cable Loss	Attenuator Loss	Antenna Gain	N	EIRP	Distance	Ground bounce	E (field strength)	Limit	Margin	Remark
[kHz]	[dBm]	[dB]	[dB]	[dBi]	(Number of Output)	[dBm]	[m]	[dB]	[dBuV/m]	[dBuV/m]	[dB]	
9.59	-92.4	0.01	9.5	2.0	1	-80.8	300	6.0	-19.6	47.9	67.5	
175.00	-80.1	0.01	9.5	2.0	1	-68.5	300	6.0	-7.3	22.7	30.0	

$E = \text{EIRP} - 20 \log(D) + \text{Ground bounce} + 104.8 \text{ [dBuV/m]}$

$\text{EIRP} = \text{Reading} + \text{Cable Loss} + \text{Attenuator Loss} + \text{Antenna Gain} + 10 * \log(N)$

Conducted Spurious Emission

Test place	Shonan EMC Lab. No.1 Measurement Room
Report No.	10981928S-A
Date	October 1, 2015
Temperature / Humidity	25 deg. C / 48 % RH
Engineer	Tomohiro Hara
Mode	Tx BT LE 2480 MHz

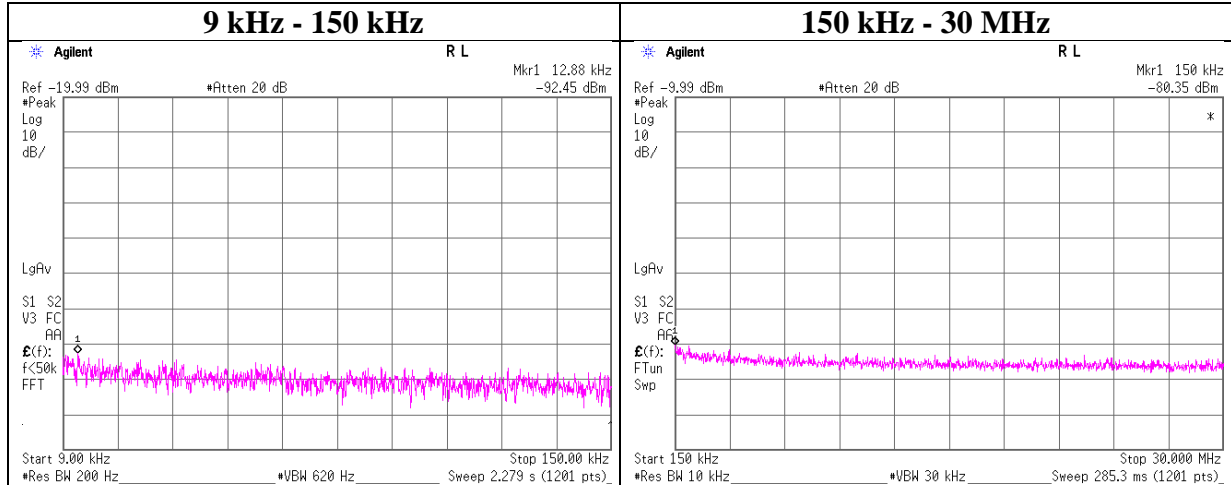

Frequency	Reading	Cable Loss	Attenuator Loss	Antenna Gain	N	EIRP	Distance	Ground bounce	E (field strength)	Limit	Margin	Remark
[kHz]	[dBm]	[dB]	[dB]	[dBi]	(Number of Output)	[dBm]	[m]	[dB]	[dBuV/m]	[dBuV/m]	[dB]	
12.88	-92.5	0.01	9.5	2.0	1	-80.9	300	6.0	-19.7	45.4	65.1	
150.00	-80.4	0.01	9.5	2.0	1	-68.8	300	6.0	-7.6	24.0	31.6	

$$E = \text{EIRP} - 20 \log(D) + \text{Ground bounce} + 104.8 \text{ [dBuV/m]}$$

$$\text{EIRP} = \text{Reading} + \text{Cable Loss} + \text{Attenuator Loss} + \text{Antenna Gain} + 10 * \log(N)$$

Power Density

Test place Shonan EMC Lab. No.1 Measurement Room
Report No. 10981928S-A
Date October 1, 2015
Temperature / Humidity 25 deg. C / 48 % RH
Engineer Tomohiro Hara
Mode Tx BT LE

BTLE

Freq. [MHz]	Reading [dBm]	Cable Loss [dB]	Atten. Loss [dB]	Result [dBm]	Limit [dBm]	Margin [dB]
2412.00	-26.02	0.62	9.63	-15.77	8.00	23.77
2437.00	-26.08	0.63	9.63	-15.82	8.00	23.82
2462.00	-26.58	0.64	9.63	-16.31	8.00	24.31

Sample Calculation:

Result = Reading + Cable Loss + Attenuator

*The equipment and cables were not used for factor 0 dB of the data sheets.

Power Density

BTLE

2402 MHz

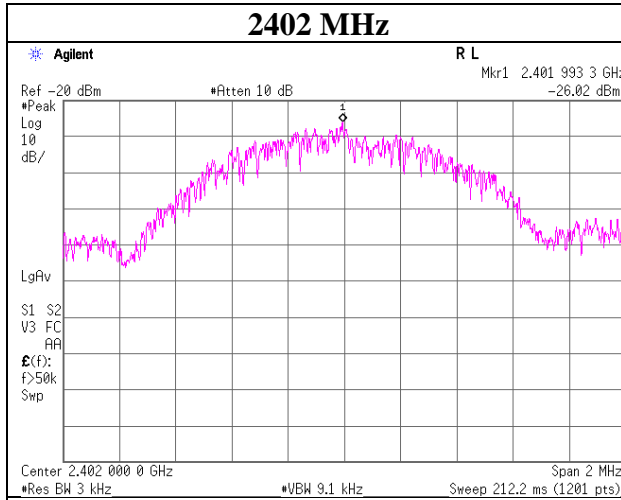

2440MHz

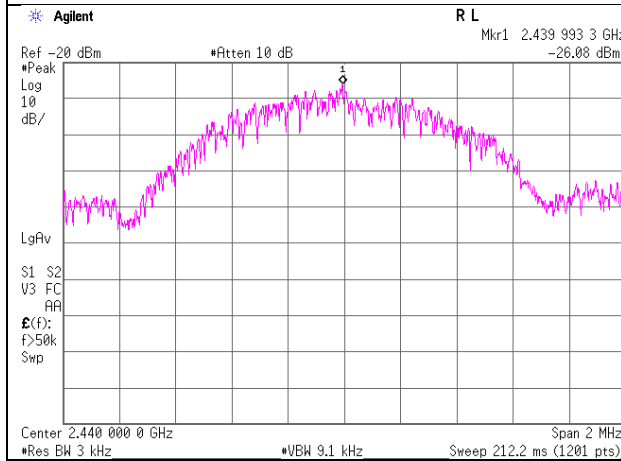

2480MHz

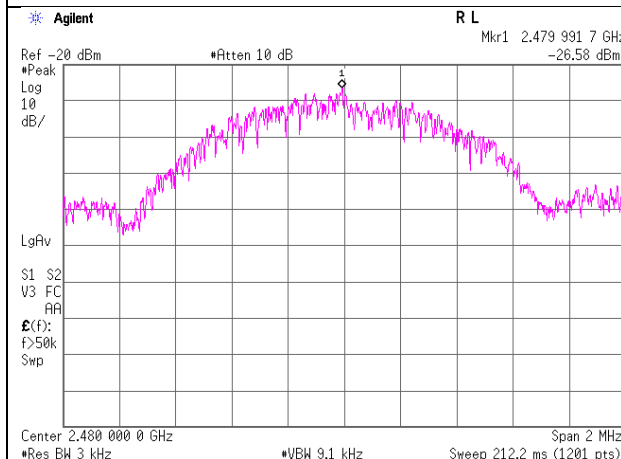

UL Japan, Inc.

Shonan EMC Lab.

1-22-3 Megumigaoka, Hiratsuka-shi, Kanagawa-ken, 259-1220 JAPAN

Telephone : +81 463 50 6400

Facsimile : +81 463 50 6401

99% Occupied Bandwidth

Test place	Shonan EMC Lab. No.1 Measurement Room
Report No.	10981928S-A
Date	October 1, 2015
Temperature / Humidity	25 deg. C / 48 % RH
Engineer	Tomohiro Hara
Mode	Tx BT LE

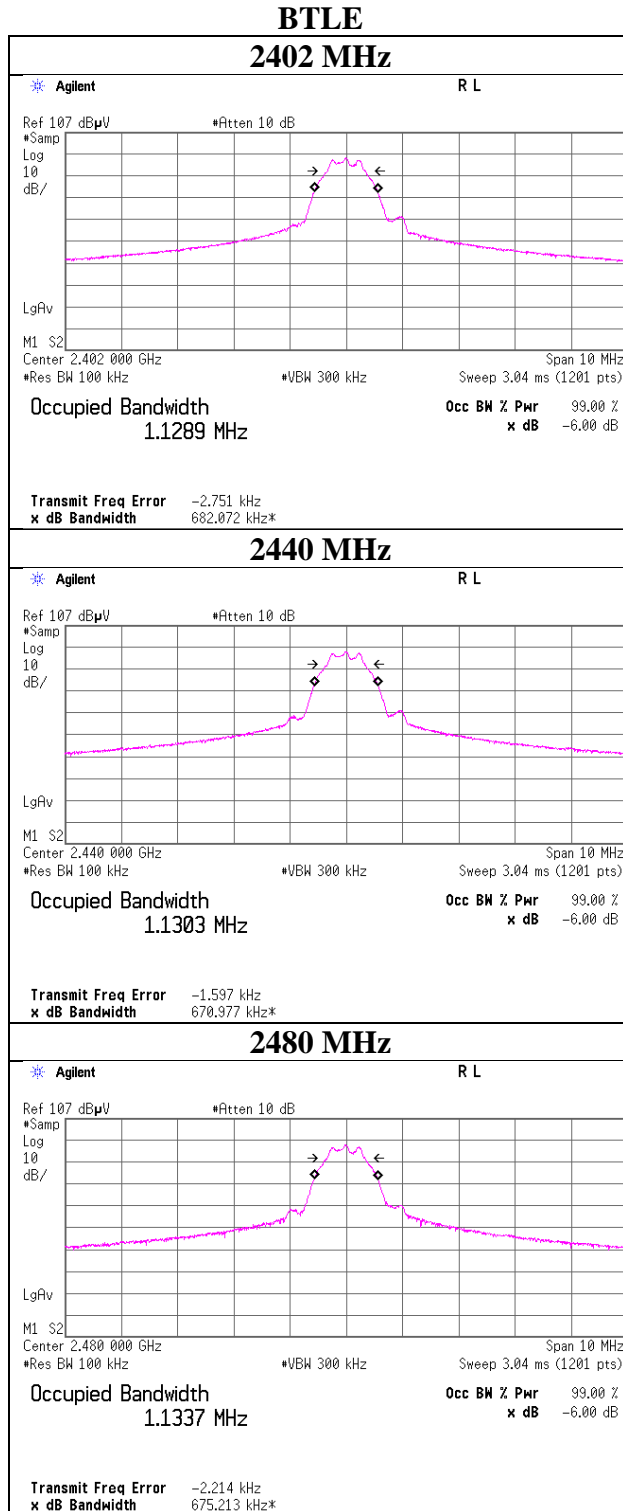

APPENDIX 2: Test instruments

Test equipment

Control No.	Instrument	Manufacturer	Model No	Serial No	Test Item	Calibration Date * Interval(month)
SSA-02	Spectrum Analyzer	Agilent	E4448A	MY48250106	AT	2015/03/26 * 12
SAT10-09	Attenuator	Weinschel Corp.	54A-10	W5692	AT	2014/11/21 * 12
SCC-G31	Coaxial Cable	Junkosha	MWX241-0100 0KMSKMS	OCT-08-13- 046	AT	2015/04/09 * 12
SPM-06	Power Meter	Anritsu	ML2495A	0850009	AT	2015/04/07 * 12
SPSS-03	Power sensor	Anritsu	MA2411B	0917063	AT	2015/04/07 * 12
SOS-13	Humidity Indicator	Custom	CTH-202	Q.C.17	AT	2015/04/28 * 12
SAF-06	Pre Amplifier	TOYO Corporation	TPA0118-36	1440491	RE	2015/05/27 * 12
SCC-G04	Coaxial Cable	Junkosha	J12J102207-00	JUN-12-14- 018	RE	2015/06/08 * 12
SCC-G23	Coaxial Cable	Suhner	SUCOFLEX 104	297342/4	RE	2015/05/19 * 12
SHA-03	Horn Antenna	Schwarzbeck	BBHA9120D	9120D-739	RE	2015/08/11 * 12
SOS-05	Humidity Indicator	A&D	AD-5681	4062518	RE	2014/10/30 * 12
KSA-08	Spectrum Analyzer	Agilent	E4446A	MY4618052 5	RE	2015/03/23 * 12
SJM-15	Measure	ASKUL	-	-	RE,CE	-
SAEC-03(SVS WR)	Semi-Anechoic Chamber	TDK	SAEC-03(SVS WR)	3	RE	2015/08/28 * 12
COTS-SEMI-1	EMI Software	TSJ	TEPTO-DV(RE ,CE,RFI,MF)	-	RE,CE	-
SAT10-06	Attenuator	Agilent	8493C-010	74865	RE	2014/11/21 * 12
SFL-18	Highpass Filter	MICRO-TRONICS	HPM50111	119	RE	2015/04/09 * 12
SAEC-03(NSA)	Semi-Anechoic Chamber	TDK	SAEC-03(NSA)	3	RE	2015/07/16 * 12
SHA-04	Horn Antenna	ETS LINDGREN	3160-09	LM3640	RE	2015/03/17 * 12
SAF-08	Pre Amplifier	TOYO Corporation	HAP18-26W	00000019	RE	2015/03/23 * 12
SCC-G15	Coaxial Cable	Suhner	SUCOFLEX 102	32703/2	RE	2015/03/11 * 12
SBA-02	Biconical Antenna	Schwarzbeck	BBA9106	91032665	RE	2014/11/22 * 12
SLA-02	Logperiodic Antenna	Schwarzbeck	UHALP9108A	UHALP 9108-A 0893	RE	2014/11/22 * 12
SAT6-08	Attenuator	HIROSE ELECTRIC CO.,LTD.	AT-406(40)	-	RE	2015/08/31 * 12
SCC-C1/C2/C3/ C4/C5/C10/SRS E-03	Coaxial Cable&RF Selector	Fujikura/Fujikura/Suhner/ Suhner/Suhner/Suhner/ TOYO	8D2W/12DSFA /141PE/141PE/ 141PE/141PE/ NS4906	-/0901-271(RF Selector)	RE	2015/04/17 * 12
SAF-03	Pre Amplifier	SONOMA	310N	290213	RE	2015/02/18 * 12
STR-06	Test Receiver	Rohde & Schwarz	ESCI	101259	RE,CE	2015/03/24 * 12
SCC-C9/C10/S RSE-03	Coaxial Cable&RF Selector	Suhner/Suhner/TOYO	RG223U/141P E/NS4906	-/0901-271(RF Selector)	CE	2015/04/17 * 12
SLS-05	LISN	Rohde & Schwarz	ENV216	100516	CE(EUT)	2015/02/24 * 12
SAT3-07	Attenuator	JFW	50HF-003N	-	CE	2015/09/18 * 12
SOS-06	Humidity Indicator	A&D	AD-5681	4062118	CE	2014/12/24 * 12
STS-03	Digital Hitester	Hioki	3805-50	080997823	RE,CE	2014/11/11 * 12

The expiration date of the calibration is the end of the expired month.

All equipment is calibrated with valid calibrations. Each measurement data is traceable to the national or international standards.

As for some calibrations performed after the tested dates, those test equipment have been controlled by means of an unbroken chains of calibrations.

Test Item: **CE: Conducted Emission test**
 RE: Radiated Emission test
 AT: Antenna Terminal Conducted test

UL Japan, Inc.

Shonan EMC Lab.

1-22-3 Megumigaoka, Hiratsuka-shi, Kanagawa-ken, 259-1220 JAPAN

Telephone : +81 463 50 6400

Facsimile : +81 463 50 6401