



Canada

EMC & RF Test Report

As per

RSS-213 Issue 3:2015 & FCC Part 15 Subpart D:2017

Unlicensed Intentional Radiators

on the

SIP-DECT Base Station RFP 48

Issued by: **TÜV SÜD Canada Inc.**
11 Gordon Collins Dr,
Gormley, ON, L0H 1G0
Canada
Ph: (905) 883-7255

Testing produced for

Prepared by:
Scott Drysdale,
Test Personnel



Reviewed by:

Min Xie,
Sr. Project
Engineer

See Appendix A for full client & EUT details.



Registration #
6844A-3



Testing Laboratory
Certificate #2955.02



Registration #
CA6844



Client	Mitel Networks Corporation	
Product	SIP-DECT Base Station RFP 48	
Standard(s)	RSS-213 Issue 3:2015& FCC Part 15 Subpart D:2017	

Table of Contents

Table of Contents	2
Report Scope	3
Summary	4
Test Results Summary	5
Notes, Justifications, or Deviations	7
Sample Calculation(s)	7
Applicable Standards, Specifications and Methods	8
Document Revision Status	9
Definitions and Acronyms	10
Testing Facility	11
Calibrations and Accreditations	11
Testing Environmental Conditions and Dates	12
Detailed Test Results Section	13
Power Line Conducted Emissions	14
Spurious Radiated Emissions.....	20
Peak Power and Antenna Gain reduction	30
Power Spectral Density.....	34
Automatic discontinue of information	38
Emission Bandwidth	39
Monitoring Threshold & Least interfered channel	46
Acknowledgements, Test interval and functional test	48
Threshold monitoring bandwidth.....	50
Out of Band Unwanted Emissions, antenna conducted	51
In Band Emission Mask, antenna conducted	56
Frame repetition stability, Frame period and jitter	60
Frequency stability	61
Appendix A – EUT Summary.....	62
Appendix B – EUT and Test Setup Photos.....	68

Client	Mitel Networks Corporation	
Product	SIP-DECT Base Station RFP 48	
Standard(s)	RSS-213 Issue 3:2015& FCC Part 15 Subpart D:2017	

Report Scope

This report addresses the EMC verification testing and test results of the SIP-DECT Base Station RFP 48, and is herein referred to as EUT (Equipment Under Test). The EUT was tested for compliance against the following standards:

RSS-213 Issue 3:2015&
FCC Part 15 Subpart D:2017

Test procedures, results, justifications, and engineering considerations, if any, follow later in this report.

This report does not imply product endorsement by any government, accreditation agency, or TÜV SÜD Canada Inc.

Opinions or interpretations expressed in this report, if any, are outside the scope of TÜV SÜD Canada Inc. accreditations. Any opinions expressed do not necessarily reflect the opinions of TÜV SÜD Canada Inc., unless otherwise stated.

Client	Mitel Networks Corporation	
Product	SIP-DECT Base Station RFP 48	
Standard(s)	RSS-213 Issue 3:2015& FCC Part 15 Subpart D:2017	

Summary

The results contained in this report relate only to the item(s) tested.

EUT:	RFP 48
FCC Certification #, FCC ID:	EHTRFP48
Industry Canada Certification #, IC:	173A-RFP48
EUT passed all tests performed	Yes
Tests conducted by	Scott Drysdale

For testing dates, see "Testing Environmental Conditions and Dates".

Client	Mitel Networks Corporation	
Product	SIP-DECT Base Station RFP 48	
Standard(s)	RSS-213 Issue 3:2015& FCC Part 15 Subpart D:2017	

Test Results Summary

Standard	Description	Class/Limit	Result
FCC 15.203 RSS-GEN 6.8	Antenna Requirement	Unique	Pass See Justification
FCC 15.205 RSS-GEN 8.10	Restricted Bands for Intentional Operation	No Tx.	Pass
FCC 15.207 RSS-213 6.3 RSS-GEN 7.2.2	Power Line Conducted Emissions	QuasiPeak Average	Pass
FCC 15.209 FCC 15.319(g) RSS-GEN 7.2.3 RSS-213 6.8	Spurious Radiated Emissions	QuasiPeak Average	Pass
FCC 15.319(b) RSS-GEN 6.1	Digital Modulation Techniques requirement	Yes/No	Pass See Justification
FCC 15.319(c) FCC 15.319(e) RSS-213 6.5	Peak Power and Antenna Gain reduction	$\leq 100 \mu\text{W} * \sqrt{(\text{EBW}^1)}$	Pass
FCC 15.319(d) RSS-213 4.3.2.1	Power Spectral Density	$\leq 3 \text{ mW in } 3 \text{ kHz}$	Pass
FCC 15.319(f) RSS-213 4.3.4(a)	Automatic discontinue of information	Yes/No	Pass
FCC 15.323(a) RSS-213 6.4	Emission Bandwidth	50 kHz to 2.5 MHz	Pass
FCC 15.323(c)(1) RSS-213 4.3.4	Monitoring of intended tx window and max reaction time	$> 10 \text{ mS}$ or $> 20 \text{ mS}$ (depending on frame period)	Pass See Justification
FCC 15.323(c)(2)(5)(9) RSS-213 4.3.4 (b)	Monitoring Threshold Least interfered channel	$< 30 \text{ dB}$ above thermal noise power	Pass
FCC 15.323(c)(3)	Transmission Duration	8 hours	N/A ²
FCC 15.323(c)(4)(6) RSS-213 4.3.4	Acknowledgements Access Criteria Test interval and functional test	$< \text{every } 30 \text{ seconds}$	Pass
FCC 15.323(c)(7) RSS-213 4.3.4	Threshold monitoring bandwidth	$> \text{EBW}$ In greater of 50uSec or 50xSQRT (1.25/EBW/1000000)	Pass
15.323(c)(10)(11) RSS-213 4.3.4	Dual access criteria Alternative monitoring interval	Duplex operation	N/A ^{2,3}

Continued next page

Client	Mitel Networks Corporation	
Product	SIP-DECT Base Station RFP 48	
Standard(s)	RSS-213 Issue 3:2015& FCC Part 15 Subpart D:2017	

Standard	Description	Class/Limit	Result
15.323(d) RSS-213 6.7.1	Spurious antenna conducted Emissions Mask	Tighter of the below -9.5 dBm from 0 to 1.25 MHz out of band -29.5 dBm from 1.25 MHz to 2.5 MHz out of band -39.5 dBm 2.5 MHz or more out of band 1B to 2B -> 30dB below power 2B to 3B -> 50 dB below power 3B to band edge -> 60 dB below power See note 4.	Pass
15.323(e) RSS-213 4.3.4(c)	Frame repetition stability Frame period and jitter	< 10 ppm < 20 uSec	Pass
15.323(f) RSS 213 6.2	Frequency stability	< 10 ppm -20C to +50C 85% to 115% Vac	Pass
Overall Result			Pass

Note 1: EBW is the emission bandwidth in Hertz.

Note 2: Only applicable to EUT that can initiate a communication link.

Note 3: The client declares that the EUT does not implement this provision

Note 4: B is the emission EBW of the device, measured to be 1346153 Hz.

If the product as tested or otherwise complies with the specification, the EUT is deemed to comply with the requirement and is deemed a 'PASS' grade. If not applicable, an 'N/A' will be issued. If the requirement is applicable and cannot be met, a 'FAIL' grade will be issued. Note that 'PASS' / 'FAIL' grade is independent of any measurement uncertainties. A 'PASS' / 'FAIL' grade within measurement uncertainty is marked with a '*'.

Client	Mitel Networks Corporation	
Product	SIP-DECT Base Station RFP 48	
Standard(s)	RSS-213 Issue 3:2015& FCC Part 15 Subpart D:2017	

Notes, Justifications, or Deviations

The following notes, justifications for tests not performed or deviations from the above listed specifications apply:

For antenna requirements, this device either has an integral antenna or complies with the professional installation requirements as listed in 15.203.

For digital modulation requirements, the EUT applies only digital modulations, (Gaussian Frequency Shift Keying)

During radiated emissions, applicable in-band filters were employed on the receiving equipment to filter the intentional RF signal.

For the 15.323(c)(1), Reaction Time and Monitoring Interval, this test is only applicable for EUTs that can be an initiating device and does not apply.

For the Dual Access requirements in 15.232(c)(7) This test is only applicable for EUTs that can be an initiating device.

For 15.205, Restricted Bands of operation, the EUT is designed to only operate between 1920 MHz and 1930 MHz.

For radiated emissions, the EUT was mounted in three orthogonal axis. Worst case results were obtained with the EUT in the X-axis. Worst case results are presented. See Appendix B for axis details.

Sample Calculation(s)

Radiated Emission Test

Margin = Limit – (Received Signal + Antenna Factor + Cable Loss – Pre-Amp Gain)

Margin = 50.5dB μ V/m – (50dB μ V + 10dB + 2.5dB – 20dB)

Margin = 8.0 dB (pass)

Power Line Conducted Emission Test

Margin = Limit – (Received Signal + Attenuation Factor + Cable Loss + LISN Factor)

Margin = 73.0dB μ V – (50dB μ V + 10dB + 2.5dB + 0.5dB)

Margin = 10.0 dB (pass)

Client	Mitel Networks Corporation	
Product	SIP-DECT Base Station RFP 48	
Standard(s)	RSS-213 Issue 3:2015& FCC Part 15 Subpart D:2017	

Applicable Standards, Specifications and Methods

ANSI C63.4:2014	Methods of Measurement of Radio-Noise Emissions from Low-Voltage Electrical and Electronic Equipment in the Range of 9 kHz to 40 GHz
ANSI C 63.17:2013	American National Standard Methods of Measurement of the Electromagnetic and Operational Compatibility of Unlicensed Personal Communications Services (UPCS) Devices
CFR 47 FCC 15 Subpart D:2017	Code of Federal Regulations – Radio Frequency Devices, Intentional Radiators
ICES-003 Issue 6 2017	Digital Apparatus - Spectrum Management and Telecommunications Policy Interference-Causing Equipment Standard
RSS-GEN Issue 5 2018	General Requirements and Information for the Certification of Radio Apparatus
RSS-213 Issue 3:2017	2 GHz Licence-Exempt Personal Communications Services (LE-PCS) Devices
ISO/IEC 17025:2005	General Requirements for the Competence of Testing and Calibration Laboratories

Client	Mitel Networks Corporation	
Product	SIP-DECT Base Station RFP 48	
Standard(s)	RSS-213 Issue 3:2015& FCC Part 15 Subpart D:2017	

Document Revision Status

Revision 000 - August 30, 2018
Initial Release

Revision 001 – Sept 23, 2018
Minor corrections prior to TCB submission

Revision 002 – Oct 2, 2018
Minor corrections prior to TCB submission

Client	Mitel Networks Corporation	
Product	SIP-DECT Base Station RFP 48	
Standard(s)	RSS-213 Issue 3:2015& FCC Part 15 Subpart D:2017	

Definitions and Acronyms

The following definitions and acronyms are applicable in this report.
See also ANSI C63.14.

DTS – Digital Transmission System
LISN – Line Impedance Stabilization Network
NCR – No Calibration Required
NSA – Normalized Site Attenuation
N/A – Not Applicable
RF – Radio Frequency

AE – Auxiliary Equipment. A digital accessory that feeds data into or receives data from another device (host) that in turn, controls its operation.

Antenna Port – Port, other than a broadcast receiver tuner port, for connection of an antenna used for intentional transmission and/or reception of radiated RF energy.

BW – Bandwidth. Unless otherwise stated, this refers to the 6 dB bandwidth.

EMC – Electro-Magnetic Compatibility. The ability of an equipment or system to function satisfactorily in its electromagnetic environment without introducing intolerable electromagnetic disturbances to anything in that environment.

EMI – Electro-Magnetic Immunity. The ability to maintain a specified performance when the equipment is subjected to disturbance (unwanted) signals of specified levels.

EUT – Equipment Under Test. A device or system being evaluated for compliance that is representative of a product to be marketed.

ITE – Information Technology Equipment. Has a primary function of entry, storage, display, retrieval, transmission, processing, switching, or control of data and/or telecommunication messages and which may be equipped with one or more ports typically for information transfer.

Client	Mitel Networks Corporation	
Product	SIP-DECT Base Station RFP 48	
Standard(s)	RSS-213 Issue 3:2015& FCC Part 15 Subpart D:2017	

Testing Facility

Testing for EMC on the EUT was carried out at TÜV SÜD Canada labs in Laval, QC as a satellite lab and listed under scope of accreditation. The testing lab consists of a 3m semi-anechoic chamber calibrated to be able to allow measurements on a EUT that has a maximum width or length of up to 2m and a height of up to 3m. The chamber is equipped with a turntable that is capable of testing devices up to 3300lb in weight. This facility is capable of testing products that are rated for 120Vac and 240Vac single phase, or devices that are rated for a 208Vac 3 phase input. DC capability is also available for testing. The chamber is equipped with a mast that controls the polarization and height of the antenna. Control of the mast occurs in the control room adjoining the shielded chamber. Radiated emission measurements are performed using a BiLog antenna and a Horn antenna where applicable. Conducted emissions, unless otherwise stated, are performed using a LISN and using the Vertical Ground plane if applicable.

Calibrations and Accreditations

The 3m semi-anechoic chamber is registered with Federal Communications Commission (FCC, CA6844), Industry Canada (IC, 6844A-4). This chamber was calibrated for Normalized Site Attenuation (NSA) using test procedures outlined in ANSI C63.4 "Methods of Measurement of Radio-Noise Emissions from Low-Voltage Electrical and Electronic Equipment in the Range of 9 kHz to 40 GHz". The chamber is lined with ferrite tiles and absorption cones to minimize any undesired reflections. The NSA data is kept on file at TÜV SÜD Canada. For radiated susceptibility testing, a 16 point field calibration has been performed on the chamber. The field uniformity data is kept on file at TÜV SÜD Canada. TÜV SÜD Canada Inc. is accredited to ISO/IEC 17025 by A2LA with Testing Certificate #2555.01. The laboratory's current scope of accreditation listing can be found as listed on the A2LA website. All measuring equipment is calibrated on an annual or bi-annual basis as listed for each respective test.

Client	Mitel Networks Corporation	
Product	SIP-DECT Base Station RFP 48	
Standard(s)	RSS-213 Issue 3:2015& FCC Part 15 Subpart D:2017	

Testing Environmental Conditions and Dates

Following environmental conditions were recorded in the facility during time of testing

Date	Test	Initials	Temperature (°C)	Humidity (%)	Pressure (kPa)
Aug 13 – 18, 2018	Radiated Emissions	SD.	20-25	35-55	96-104
July 23 – Aug 3, 2018	Antenna Conducted Emissions	SD	20-25	35-55	96-104
July 23 – Aug 3, 2018	Power Line Conducted Emissions	SD	20-25	35-55	96-104

SD = Scott Drysdale

Client	Mitel Networks Corporation	 Canada
Product	SIP-DECT Base Station RFP 48	
Standard(s)	RSS-213 Issue 3:2015& FCC Part 15 Subpart D:2017	

Detailed Test Results Section

Client	Mitel Networks Corporation	
Product	SIP-DECT Base Station RFP 48	
Standard(s)	RSS-213 Issue 3:2015& FCC Part 15 Subpart D:2017	

Power Line Conducted Emissions

Purpose

The purpose of this test is to ensure that the RF energy unintentionally emitted from the EUT's power line does not exceed the limits listed below as defined in the applicable test standard and measured from a LISN. This helps protect lower frequency radio services such as AM radio, shortwave radio, amateur radio, maritime radio, CB radio, and so on, from unwanted interference.

Limits & Method

The limits and method are as defined in, 47 CFR FCC Part 15 Section 15.107, and ICES-003 Issue 6 Section 6.1, FCC part 15.207.

CLASS B

Average Limits		Quasi-Peak Limits	
150 kHz – 500 kHz	56 to 46* dB μ V	150 kHz – 500 kHz	66 to 56* dB μ V
500 kHz – 5 MHz	46 dB μ V	500 kHz – 5 MHz	56 dB μ V
5 MHz – 30 MHz	50 dB μ V	5 MHz – 30 MHz	60 dB μ V

* Decreases linearly with the logarithm of the frequency

Both Quasi-Peak and Average limits are applicable and each is specified as being measured with a resolution bandwidth of 9 kHz. For Quasi-Peak, a video bandwidth at least three times greater than the resolution bandwidth is used.

Based on ANSI C63.4 Section 4.2, if the Peak or Quasi-Peak detector measurements do not exceed the Average limits, then the EUT is deemed to have passed the requirements.

Client	Mitel Networks Corporation	
Product	SIP-DECT Base Station RFP 48	
Standard(s)	RSS-213 Issue 3:2015& FCC Part 15 Subpart D:2017	

Typical Setup Diagram

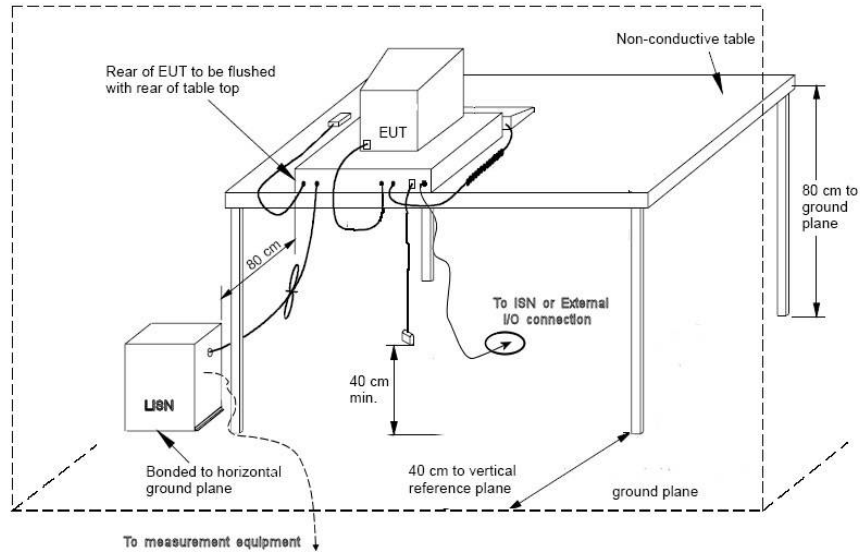

Measurement Uncertainty

The expanded measurement uncertainty is calculated in accordance with CISPR 16-4-2 and is $\pm 2.91\text{dB}$ with a 'k=2' coverage factor and a 95% confidence level.

Preliminary Graphs

The graphs shown below are maximized peak measurement graphs measured with a resolution bandwidth greater than or equal to the final required detector. This peaking process is done as a worst case measurement and enables the detection of frequencies of concern for final measurement. For final measurements with the appropriate detector, where applicable, please refer to the tables under Final Measurements.

Client	Mitel Networks Corporation	
Product	SIP-DECT Base Station RFP 48	
Standard(s)	RSS-213 Issue 3:2015& FCC Part 15 Subpart D:2017	

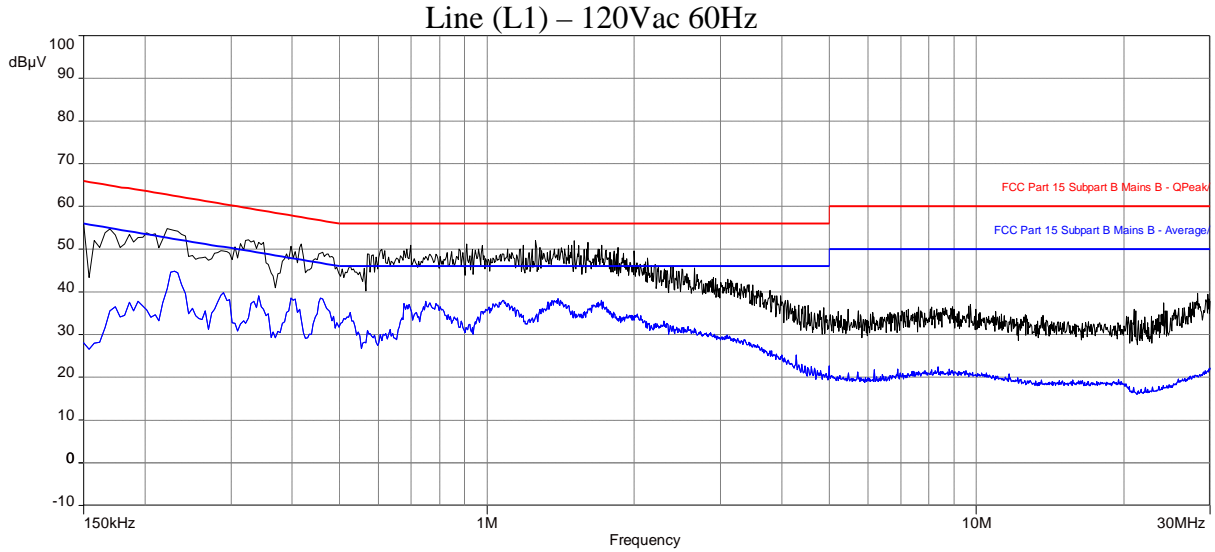

Automatic (42)

Frequency (MHz)	SR	Level Average (dBµV)	Level QP (dBµV)	Level Peak (dBµV)	Margin AVG (dBµV)	Margin QP (dBµV)	Margin - Peak to AVG (dBµV)	Limit AVG (dBµV)	Limit QP (dBµV)	Correction (dB)
0.15	1	28.27	48.10	58.38	-27.73	-17.90	2.38	56.00	66.00	9.86
0.166	1	32.78	50.81	57.56	-22.38	-14.35	2.40	55.16	65.16	9.85
0.174	1	36.76	50.76	54.47	-18.01	-14.01	-0.30	54.77	64.77	9.85
0.186	1	37.04	50.21	56.23	-17.18	-14.00	2.02	54.21	64.21	9.84
0.194	1	38.34	51.36	55.31	-15.52	-12.50	1.45	53.86	63.86	9.84
0.218	1	37.71	49.48	54.99	-15.19	-13.42	2.10	52.89	62.89	9.83
0.226	1	45.07	53.14	55.13	-7.52	-9.46	2.53	52.60	62.60	9.83
0.23	1	46.25	53.08	54.99	-6.20	-9.37	2.54	52.45	62.45	9.83
0.234	1	45.21	52.71	54.87	-7.10	-9.60	2.56	52.31	62.31	9.83
0.242	1	39.23	49.77	53.88	-12.80	-12.25	1.85	52.03	62.03	9.82
0.266	1	33.21	44.80	49.27	-18.03	-16.44	-1.97	51.24	61.24	9.82
0.286	1	40.23	48.11	50.16	-10.41	-12.53	-0.48	50.64	60.64	9.82
0.29	1	40.05	48.05	50.30	-10.47	-12.48	-0.22	50.52	60.52	9.82
0.306	1	33.72	47.15	52.91	-16.36	-12.93	2.84	50.08	60.08	9.82
0.33	1	35.99	49.07	52.81	-13.46	-10.38	3.36	49.45	59.45	9.82
0.342	1	38.69	48.14	52.76	-10.46	-11.01	3.61	49.15	59.15	9.82
0.358	1	32.56	42.12	46.17	-16.21	-16.65	-2.60	48.77	58.77	9.82
0.382	1	32.61	44.54	51.98	-15.62	-13.69	3.74	48.24	58.24	9.81
0.402	1	38.74	46.85	52.10	-9.08	-10.96	4.28	47.81	57.81	9.81
0.406	1	38.17	46.52	52.36	-9.56	-11.21	4.63	47.73	57.73	9.81
0.414	1	35.13	45.52	52.02	-12.44	-12.05	4.45	47.57	57.57	9.81
0.454	1	37.64	46.97	50.08	-9.16	-9.83	3.28	46.80	56.80	9.81
0.466	1	38.82	47.29	50.30	-7.77	-9.30	3.72	46.58	56.58	9.81
0.526	1	33.89	42.36	46.58	-12.11	-13.64	0.58	46.00	56.00	9.81
0.586	1	29.93	44.41	49.86	-16.07	-11.59	3.86	46.00	56.00	9.80
0.678	1	36.19	45.77	50.47	-9.81	-10.23	4.47	46.00	56.00	9.81

Client	Mitel Networks Corporation	
Product	SIP-DECT Base Station RFP 48	
Standard(s)	RSS-213 Issue 3:2015& FCC Part 15 Subpart D:2017	

0.75	1	37.32	45.39	49.69	-8.68	-10.61	3.69	46.00	56.00	9.81
0.814	1	36.09	43.71	48.54	-9.91	-12.29	2.54	46.00	56.00	9.81
0.87	1	33.41	43.99	49.41	-12.59	-12.01	3.41	46.00	56.00	9.81
0.974	1	35.17	44.95	49.95	-10.83	-11.05	3.95	46.00	56.00	9.81
1.078	1	37.77	44.57	50.26	-8.23	-11.43	4.26	46.00	56.00	9.81
1.362	1	37.81	44.97	51.64	-8.19	-11.03	5.64	46.00	56.00	9.81
1.714	1	36.99	44.42	51.73	-9.01	-11.58	5.73	46.00	56.00	9.81
2.002	1	34.40	41.63	49.94	-11.60	-14.37	3.94	46.00	56.00	9.81
2.118	1	32.26	39.60	47.87	-13.74	-16.40	1.87	46.00	56.00	9.81
2.654	1	30.96	39.25	47.15	-15.04	-16.75	1.15	46.00	56.00	9.81
3.506	1	27.25	34.39	41.67	-18.75	-21.61	-4.33	46.00	56.00	9.81
4.286	1	24.18	30.26	38.02	-21.82	-25.74	-7.98	46.00	56.00	9.81
5.002	1	20.92	28.11	36.41	-29.08	-31.89	-13.59	50.00	60.00	9.81
20.95	1	16.44	24.61	36.89	-33.56	-35.39	-13.11	50.00	60.00	9.95
24.046	1	17.15	23.96	36.69	-32.85	-36.04	-13.31	50.00	60.00	10.02
29.998	1	21.57	28.19	40.86	-28.43	-31.81	-9.14	50.00	60.00	10.12

Neutral (L2) – 120Vac 60Hz

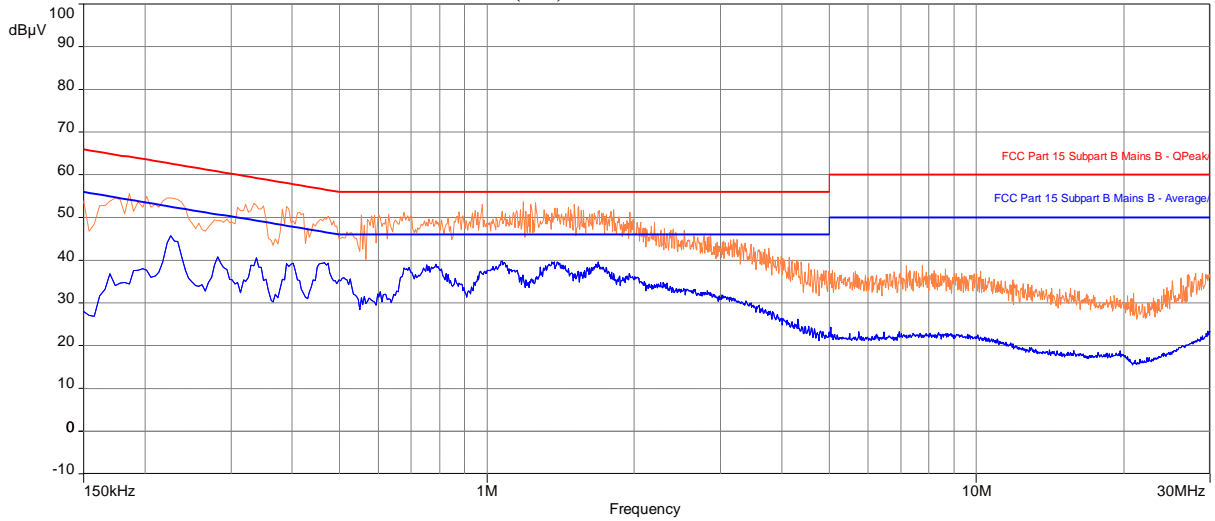

Frequency (MHz)	SR	Level Average (dBµV)	Level QP (dBµV)	Level Peak (dBµV)	Margin AVG (dB) (dBµV)	Margin QP (dB) (dBµV)	Margin - Peak to AVG (dB) (dBµV)	Limit AVG (dBµV)	Limit QP (dBµV)	Correction (dB)
0.15	1	26.94	43.78	55.36	-29.06	-22.22	-0.64	56.00	66.00	9.87
0.162	1	30.11	46.65	53.76	-25.25	-18.71	-1.60	55.36	65.36	9.85
0.17	1	35.26	50.91	54.92	-19.70	-14.05	-0.04	54.96	64.96	9.84
0.19	1	38.24	52.05	57.06	-15.80	-11.99	3.02	54.04	64.04	9.84
0.198	1	38.57	51.58	56.33	-15.13	-12.11	2.63	53.69	63.69	9.84
0.218	1	39.60	50.82	55.15	-13.30	-12.08	2.25	52.89	62.89	9.84
0.222	1	43.23	52.74	55.25	-9.51	-10.01	2.51	52.74	62.74	9.84
0.226	1	45.82	53.26	55.32	-6.78	-9.33	2.72	52.60	62.60	9.83
0.234	1	45.32	52.81	54.98	-6.99	-9.49	2.67	52.31	62.31	9.83

Client	Mitel Networks Corporation	
Product	SIP-DECT Base Station RFP 48	
Standard(s)	RSS-213 Issue 3:2015& FCC Part 15 Subpart D:2017	

0.242	1	38.85	49.41	53.57	-13.18	-12.62	1.55	52.03	62.03	9.83
0.258	1	33.98	45.30	49.81	-17.52	-16.19	-1.69	51.50	61.50	9.83
0.278	1	38.13	47.56	49.85	-12.75	-13.32	-1.03	50.88	60.88	9.82
0.282	1	40.02	48.09	50.16	-10.74	-12.66	-0.59	50.76	60.76	9.82
0.294	1	38.94	47.68	50.54	-11.48	-12.73	0.13	50.41	60.41	9.82
0.322	1	35.60	49.41	53.60	-14.05	-10.24	3.95	49.66	59.66	9.82
0.334	1	38.75	50.43	53.87	-10.60	-8.92	4.52	49.35	59.35	9.82
0.338	1	39.55	50.12	53.88	-9.70	-9.13	4.63	49.25	59.25	9.82
0.354	1	35.51	44.93	50.82	-13.36	-13.94	1.96	48.87	58.87	9.82
0.382	1	34.45	45.13	52.80	-13.79	-13.11	4.57	48.24	58.24	9.81
0.394	1	39.13	47.72	53.49	-8.85	-10.26	5.51	47.98	57.98	9.81
0.402	1	39.62	47.84	53.17	-8.19	-9.97	5.35	47.81	57.81	9.81
0.414	1	35.79	46.51	53.22	-11.78	-11.06	5.65	47.57	57.57	9.81
0.438	1	32.84	43.34	48.10	-14.26	-13.76	1.00	47.10	57.10	9.82
0.45	1	38.35	47.62	50.76	-8.52	-9.25	3.89	46.88	56.88	9.82
0.466	1	40.01	48.32	51.70	-6.57	-8.27	5.12	46.58	56.58	9.82
0.474	1	38.45	47.51	51.56	-7.99	-8.93	5.12	46.44	56.44	9.82
0.526	1	34.98	43.57	48.25	-11.02	-12.43	2.25	46.00	56.00	9.81
0.558	1	30.56	42.67	51.01	-15.44	-13.33	5.01	46.00	56.00	9.81
0.606	1	30.94	46.27	51.74	-15.06	-9.73	5.74	46.00	56.00	9.81
0.666	1	35.65	46.45	52.26	-10.35	-9.55	6.26	46.00	56.00	9.81
0.694	1	38.43	46.66	50.94	-7.57	-9.34	4.94	46.00	56.00	9.81
0.754	1	38.93	46.50	51.49	-7.07	-9.50	5.49	46.00	56.00	9.80
0.786	1	38.63	45.97	51.23	-7.37	-10.03	5.23	46.00	56.00	9.81
0.834	1	36.06	45.15	51.80	-9.94	-10.85	5.80	46.00	56.00	9.81
0.862	1	35.45	44.52	50.27	-10.55	-11.48	4.27	46.00	56.00	9.81
0.97	1	36.56	45.29	51.27	-9.44	-10.71	5.27	46.00	56.00	9.81
1.074	1	39.64	46.62	52.74	-6.36	-9.38	6.74	46.00	56.00	9.81
1.154	1	37.45	45.94	52.50	-8.55	-10.06	6.50	46.00	56.00	9.81
1.286	1	37.53	45.60	51.77	-8.47	-10.40	5.77	46.00	56.00	9.81
1.358	1	39.53	46.51	53.10	-6.47	-9.49	7.10	46.00	56.00	9.81
1.466	1	38.64	48.50	55.26	-7.36	-7.50	9.26	46.00	56.00	9.81
1.686	1	39.17	46.27	53.55	-6.83	-9.73	7.55	46.00	56.00	9.81
1.954	1	36.48	43.86	52.24	-9.52	-12.14	6.24	46.00	56.00	9.81
2.194	1	34.14	41.43	48.56	-11.86	-14.57	2.56	46.00	56.00	9.81
2.526	1	33.42	40.22	47.58	-12.58	-15.78	1.58	46.00	56.00	9.81
2.818	1	32.43	39.42	46.18	-13.57	-16.58	0.18	46.00	56.00	9.81
3.018	1	31.25	38.00	45.07	-14.75	-18.00	-0.93	46.00	56.00	9.81
3.39	1	30.14	37.24	44.04	-15.86	-18.76	-1.96	46.00	56.00	9.81
27.574	1	20.47	27.11	38.79	-29.53	-32.89	-11.21	50.00	60.00	10.10
29.702	1	22.14	27.93	39.24	-27.86	-32.07	-10.76	50.00	60.00	10.20

See 'Appendix B – EUT, Peripherals and Test Setup Photos' for photos showing the test set-up for the highest line conducted emission.

Client	Mitel Networks Corporation	
Product	SIP-DECT Base Station RFP 48	
Standard(s)	RSS-213 Issue 3:2015& FCC Part 15 Subpart D:2017	

Test Equipment List

Description	Make	Model number	Asset ID	Calibration date	Calibration due
Impedance Stabilization Network	TESEQ	ISN T8-Cat6	SSG013730	2017-10-19	2018-10-19
Termination	Narda	374BNM	SSG012451	2017-10-03	2018-10-03
Termination	Narda	370BNF	SSG012766	2017-09-27	2018-09-27
Line Impedance Stabilization Network	Emco	3825/2	SSG011780	2017-11-02	2018-11-02
Transient Limiter	Hewlett Packard	11947A	SSG012403	2018-01-05	2019-01-06
EMI Receiver	Rohde & Schwarz	ESCI	SSG013727	2017-12-14	2018-12-14
Coaxial Cable	Huber & Suhner	104PEA	SSG013078	2018-01-05	2019-01-06
Current Probe	Ailtech	94111-1	SSG012043	2017-09-22	2018-09-22
Decoupling Clamp	Luthi	FTC 101	SSG012722	not required	not required

This report module is based on report template 'CISPR32-FCC_PLCE_Rev1'

Client	Mitel Networks Corporation	
Product	SIP-DECT Base Station RFP 48	
Standard(s)	RSS-213 Issue 3:2015& FCC Part 15 Subpart D:2017	

Spurious Radiated Emissions

Purpose

The purpose of this test is to ensure that the RF energy unintentionally emitted from the EUT does not exceed the limits listed below as defined in the applicable test standard and measured from a receiving antenna. This helps protect broadcast radio services such as television, FM radio, pagers, cellular telephones, emergency services, and so on, from unwanted interference.

Limits & Method

The limits and method are as defined in ANSI C63.4, FCC Part 15 Section 15.109, 15.209, and ICES-003 Issue 6 Section 6.2 and RSS-GEN.

Frequency	Limit
0.009 MHz – 0.490 MHz	2400/F(kHz) uV/m at 30m ¹
0.490 MHz – 1.705 MHz	24000/F(kHz) uV/m at 30m ¹
1.705 MHz – 30 MHz	30 uV/m at 30m ¹
30 MHz – 88 MHz	100 uV/m (40.0 dBuV/m ¹) at 3m
88 MHz – 216 MHz	150 uV/m (43.5 dBuV/m ¹) at 3m
216 MHz – 960 MHz	200 uV/m (46.0 dBuV/m ¹) at 3m
Above 960 MHz	500 uV/m (54.0 dBuV/m ¹) at 3m
Above 1000 MHz	500 uV/m (54 dBuV/m ²) at 3m
Above 1000 MHz	500 uV/m (74 dBuV/m ³) at 3m

¹Limit is with Quasi Peak detector with bandwidths as defined in CISPR-16-1-1

²Limit is with 1 MHz measurement bandwidth and using an Average detector

³Limit is with 1 MHz measurement bandwidth and using a Peak detector

Based on ANSI C63.4 Section 4.2 if the Peak detector measurements do not exceed the Quasi-Peak limits, where defined, then the EUT is deemed to have passed the requirements.

Client	Mitel Networks Corporation	
Product	SIP-DECT Base Station RFP 48	
Standard(s)	RSS-213 Issue 3:2015& FCC Part 15 Subpart D:2017	

Typical Radiated Emissions Setup

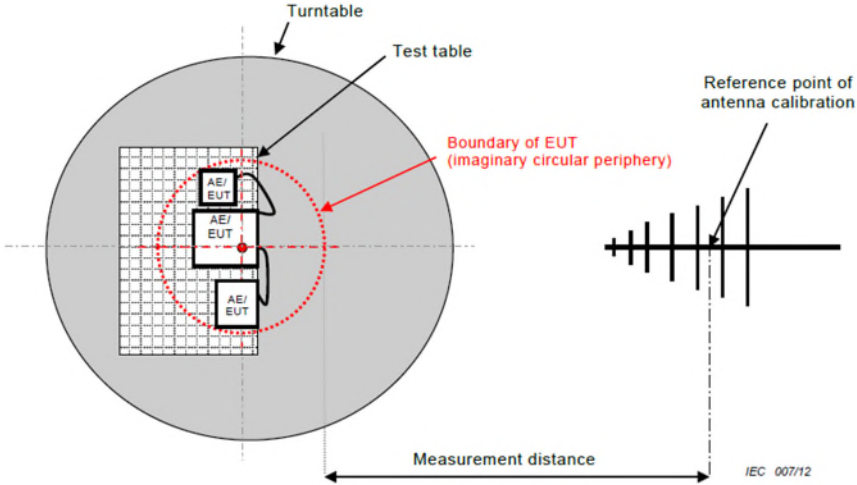

Note: testing was performed at a 3 meter test distance below 1 GHz and 10 meter below 1 GHz.

Measurement Uncertainty

The expanded measurement uncertainty is calculated in accordance with CISPR 16-4-2 and is $\pm 4.25\text{dB}$ for 30MHz – 1GHz and $\pm 4.93\text{dB}$ for 1GHz – 18GHz with a 'k=2' coverage factor and a 95% confidence level.

Preliminary Graphs

The graphs shown below are maximized peak measurement graphs measured with a resolution bandwidth greater than or equal to the final required detector over a full 0-360°. This peaking process is done as a worst case measurement and enables the detection of frequencies of concern for final measurement. For final measurements with the appropriate detector, where applicable, please refer to the tables under Final Measurements.

© TÜV SÜD Canada Inc. This test report shall not be reproduced except in full, without written approval of TÜV SÜD Canada Inc.

Client	Mitel Networks Corporation	
Product	SIP-DECT Base Station RFP 48	
Standard(s)	RSS-213 Issue 3:2015& FCC Part 15 Subpart D:2017	

Peak Emissions Graph 9k to 150k

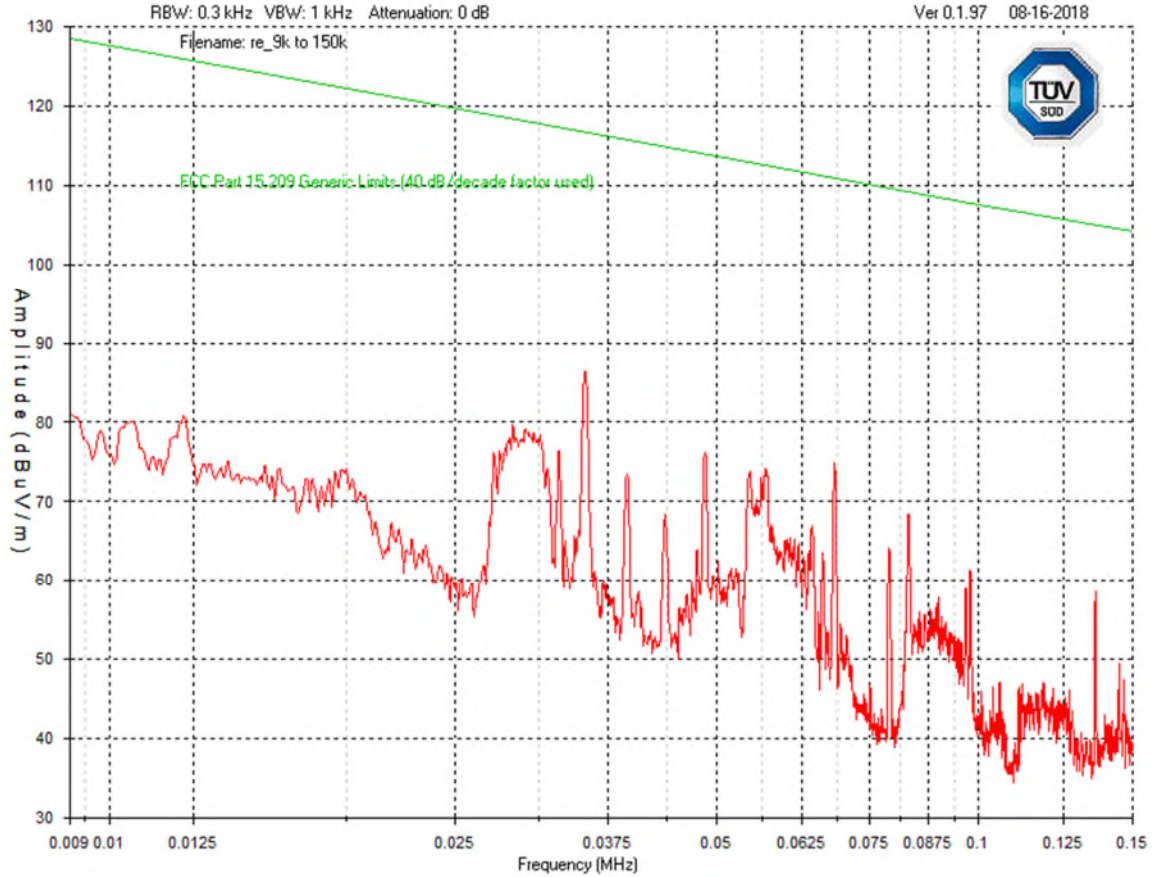

Client	Mitel Networks Corporation	
Product	SIP-DECT Base Station RFP 48	
Standard(s)	RSS-213 Issue 3:2015& FCC Part 15 Subpart D:2017	

Peak Emissions Graph
150k to 30 MHz

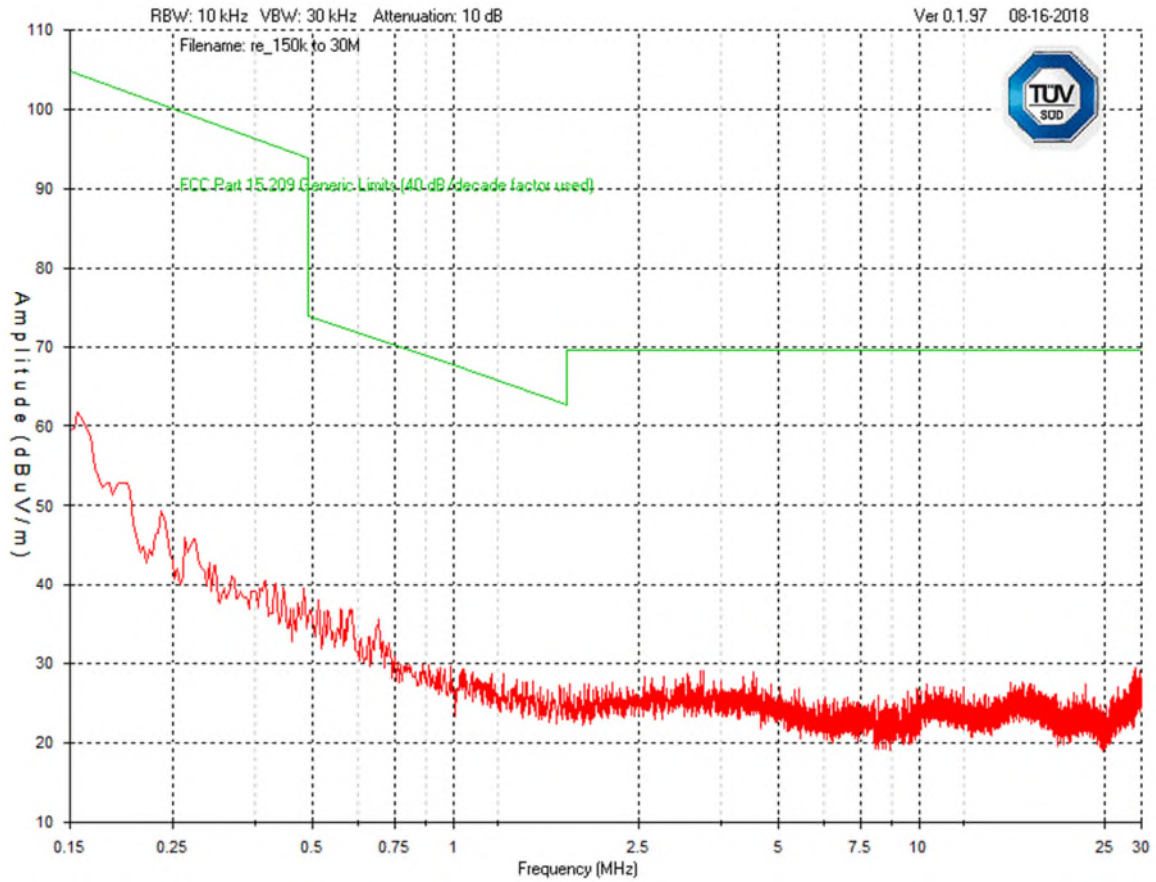

Client	Mitel Networks Corporation	
Product	SIP-DECT Base Station RFP 48	
Standard(s)	RSS-213 Issue 3:2015& FCC Part 15 Subpart D:2017	

Peak Emissions Graph
30MHz - 1GHz

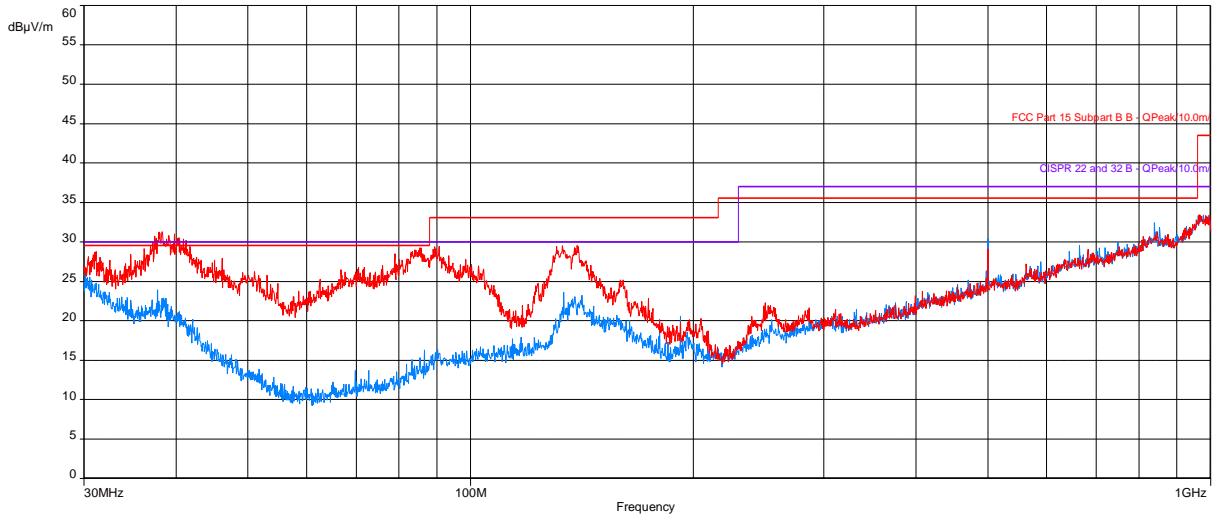

Red=Vertical, Blue=Horizontal
QuasiPeak (PASS) (7)

Frequency (MHz)	SR	Level (dBµV/m)	Limit (dBµV/m)	Margin (dB)	Azimuth (°)	Height (m)	Pol.	Meas. Time (s)	PeakFinnal	Correction (dB)
38.19439777	1	25.75	29.54	-3.79	228.25	1.64	Vertical	15.00	31.14	-4.61
500.0000544	2	30.15	35.56	-5.41	131.50	1.59	Horizontal	15.00	32.77	-0.36
139.2384646	1	24.01	33.06	-9.05	53.25	1.06	Vertical	15.00	29.69	-8.23
90.61013495	1	23.89	33.06	-9.17	235.50	2.80	Vertical	15.00	31.33	-11.61
30.11507018	2	20.05	29.54	-9.49	146.00	2.51	Horizontal	15.00	25.87	-0.85
839.7436603	2	24.98	35.56	-10.58	328.00	3.60	Horizontal	15.00	31.36	6.67
133.4938718	2	16.46	33.06	-16.60	292.50	3.94	Horizontal	15.00	22.34	-8.22

Client	Mitel Networks Corporation	
Product	SIP-DECT Base Station RFP 48	
Standard(s)	RSS-213 Issue 3:2015& FCC Part 15 Subpart D:2017	

Peak Emissions Graph
1GHz - 10GHz

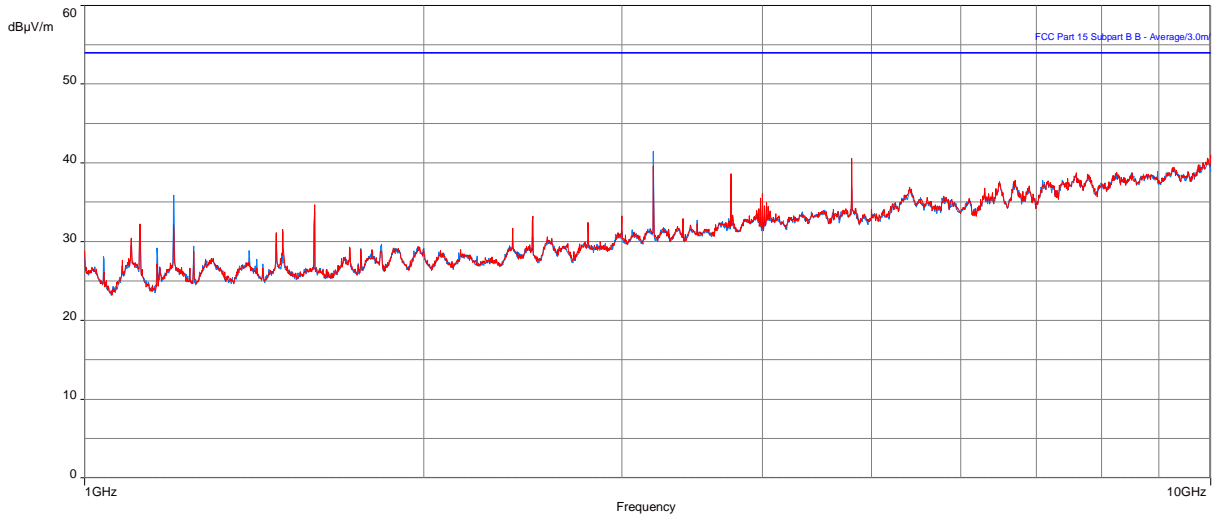

Note: A filter from 1920 MHz to 1930 MHz and from 2.4GHz to 2.4835 GHz was employed

Client	Mitel Networks Corporation	
Product	SIP-DECT Base Station RFP 48	
Standard(s)	RSS-213 Issue 3:2015& FCC Part 15 Subpart D:2017	

Avg (PASS) (4)

Frequency (MHz)	SR	Level (dBµV/m)	Limit (dBµV/m)	Margin (dB)	Azimuth (°)	Height (m)	Pol.	Meas. Time (s)	Correction (dB)
4800.000641	1	39.16	59.96	-20.80	198.75	2.60	Vertical	15.00	-3.43
9940.742949	1	37.23	59.96	-22.73	289.50	3.69	Vertical	15.00	6.39
3200.000962	2	41.26	59.96	-18.70	277.25	3.55	Horizontal	15.00	-6.75
9942.135256	2	37.15	59.96	-22.81	339.00	3.69	Horizontal	15.00	6.39

Peak (PASS) (4)

Frequency (MHz)	SR	Level (dBµV/m)	Margin (dB)	Azimuth (°)	Height (m)	Pol.	Meas. Time (s)	Correction (dB)
4800.000641	1	47.99	-11.97	198.75	2.60	Vertical	15.00	-3.43
9940.742949	1	50.66	-9.30	289.50	3.69	Vertical	15.00	6.39
3200.000962	2	46.94	-13.02	277.25	3.55	Horizontal	15.00	-6.75
9942.135256	2	50.54	-9.42	339.00	3.69	Horizontal	15.00	6.39

Client	Mitel Networks Corporation	
Product	SIP-DECT Base Station RFP 48	
Standard(s)	RSS-213 Issue 3:2015& FCC Part 15 Subpart D:2017	

Peak Emissions Graph
10GHz - 18GHz

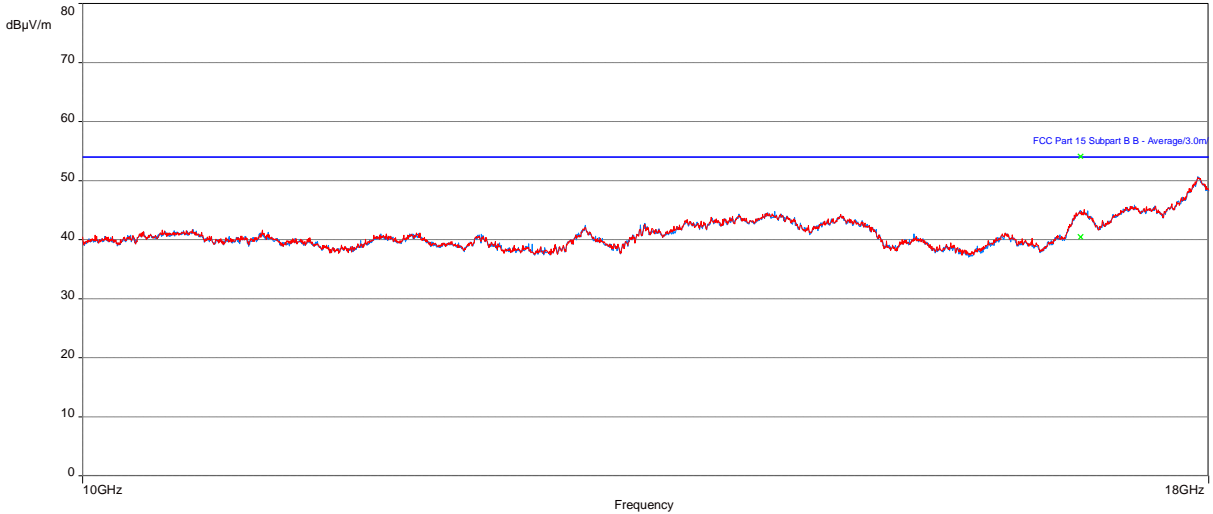

Note: No emissions were detected and the system noise floor was below the limit.

Peak Emissions Graph
18GHz - 26GHz

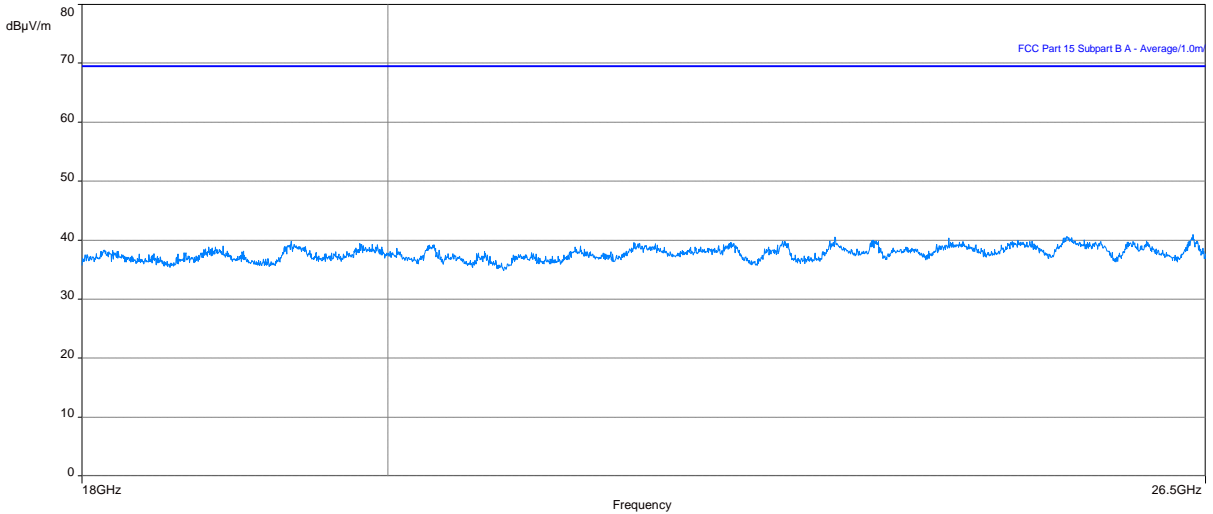

Note: No emissions were detected and the system noise floor was below the limit.

Client	Mitel Networks Corporation	
Product	SIP-DECT Base Station RFP 48	
Standard(s)	RSS-213 Issue 3:2015& FCC Part 15 Subpart D:2017	

Peak Emissions Graph
26GHz - 40GHz

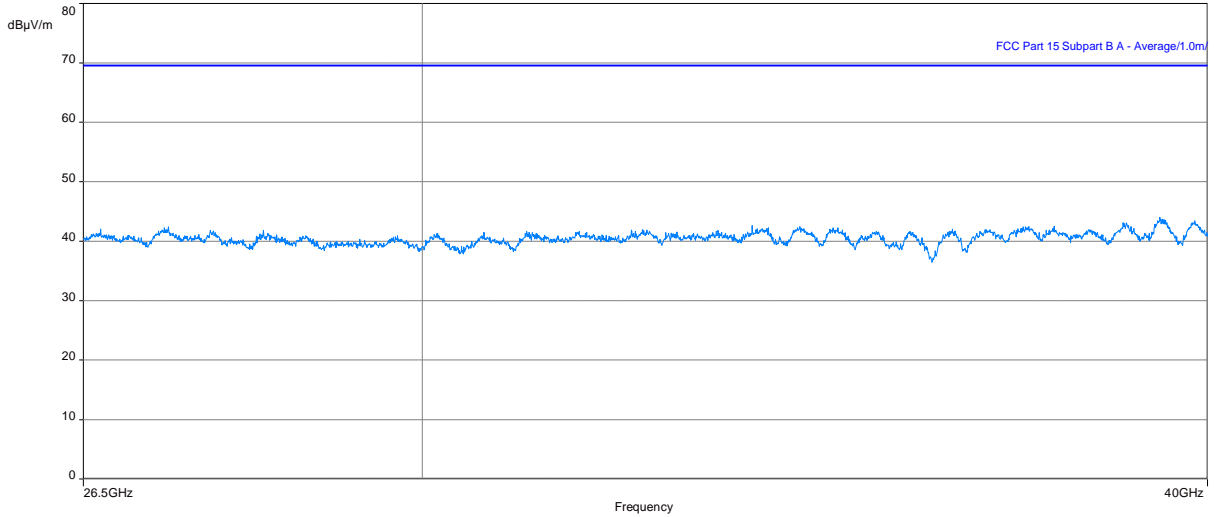

Note: No emissions were detected and the system noise floor was below the limit.

See 'Appendix B – EUT, Peripherals, and Test Setup Photos' for photos showing the test set-up for the highest radiated emission.

Client	Mitel Networks Corporation	
Product	SIP-DECT Base Station RFP 48	
Standard(s)	RSS-213 Issue 3:2015& FCC Part 15 Subpart D:2017	

Test Equipment List

Description	Make	Model number	Asset ID	Calibration date	Calibration due
Bilog Antenna	Chase	CBL6111	SSG012564	2018-02-01	2019-02-01
Coaxial Cable	Huber & Suhner	104PEA	SSG012041	2018-01-05	2019-01-06
Coaxial Cable	Huber & Suhner	106A	SSG012455	2018-01-05	2019-01-06
Coaxial Cable	Huber & Suhner	ST18/Nm/Nm/36	SSG012786	2018-01-05	2019-01-06
Coaxial Cable	Micro-Coax	UFA 210B-1-1500-504504	SSG012376	2018-01-05	2019-01-06
Coaxial Cable	Huber & Suhner	101 PEA, Sucoflex	SSG012290	2017-09-25	2018-09-25
Coaxial Cable	Huber & Suhner	106A	SSG012711	2018-01-05	2019-01-06
Double Ridged Horn Antenna	Emco	3115	SSG012508	2017-12-21	2018-12-21
EMC Automation Software	Nexio	BAT-EMC	F0163649	not required	not required
EMI Receiver	Rohde & Schwarz	ESU26	SSG013729	2018-02-13	2019-02-13
EMI Receiver	Rohde & Schwarz	ESU40	SSG013672	2017-11-28	2018-11-28
Horn Antenna (18 - 26.5 GHz)	Emco	3160-09	SSG012292	2018-01-02	2019-01-02
Horn Antenna (26.5 - 40 GHz)	Emco	3160-10	SSG012294	2018-01-02	2019-01-02
Pre-Amplifier	BNR	LNA	SSG012360	2017-09-28	2018-09-28
RF Amplifier	Hewlett Packard	8447D	SSG013045	2018-01-05	2019-01-06

This report module is based on report template 'CISPR32-FCC_RE-B_Rev1'

Client	Mitel Networks Corporation	
Product	SIP-DECT Base Station RFP 48	
Standard(s)	RSS-213 Issue 3:2015& FCC Part 15 Subpart D:2017	

Peak Power and Antenna Gain reduction

Measurement Procedure:

ANSI C63.17, clause 6.1.2.

Test Results:

Pass

Limit:

$100 \mu\text{W} \times \text{SQRT}(B)$ where B is the (lowest) measured Emission Bandwidth in Hz

$B=1346153$

$\text{SQRT}(B)=1160.24$

$100 \mu\text{W} * 1160.24 = 116023.83 \mu\text{W} = 116.023 \text{ mW} = 20.6 \text{ dBm}$

Measurement Data:

Maximum Output Power

Channel	Frequency (MHz)	Maximum Conducted Output power (dBm)	Maximum EiRP (dBm)	Calculated Antenna Gain (dBi)	Result
4	1921.536	19.9	19.3	-0.6	Pass
2	1924.992	19.8	19.4	-0.4	Pass
0	1928.448	19.7	19.1	-0.6	Pass

For this test it the input voltage was varied between 85% and 115% of nominal value, and no effect was observed.

No effect on power was observed when the temperature was varied from -20C to 50C.

The antenna gain is below 3 dBi, so no reduction in the limit is necessary.

Client	Mitel Networks Corporation	
Product	SIP-DECT Base Station RFP 48	
Standard(s)	RSS-213 Issue 3:2015& FCC Part 15 Subpart D:2017	

Low Channel

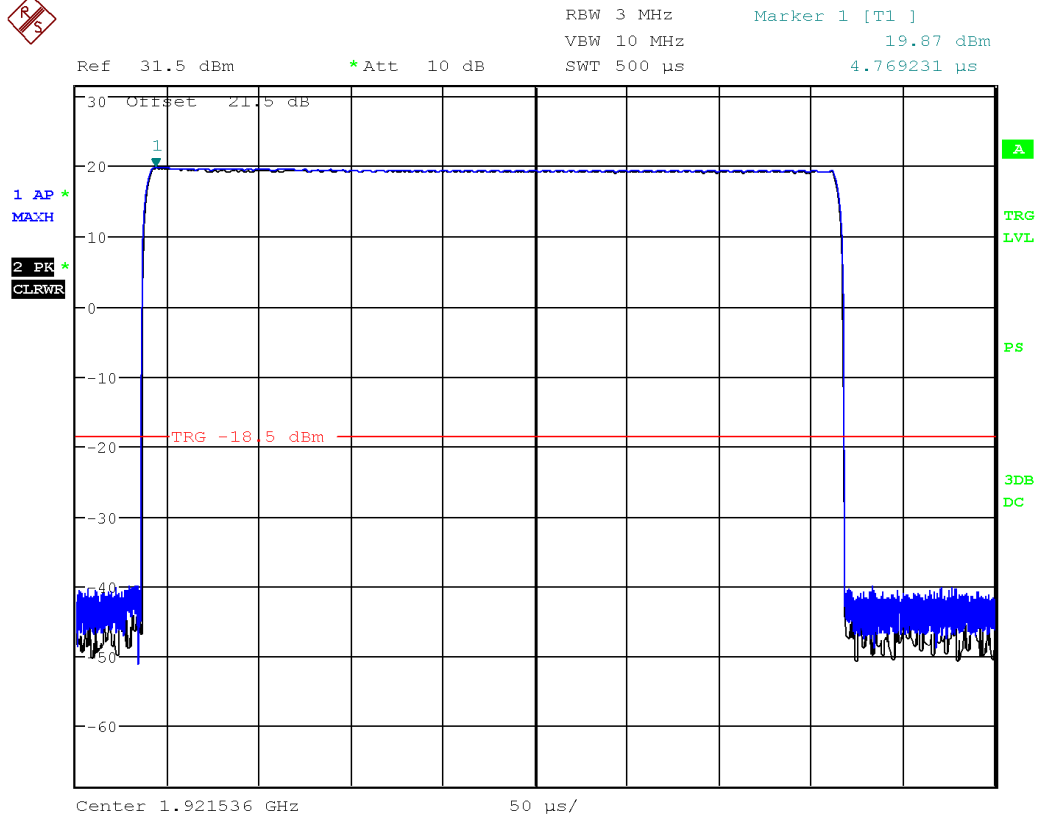

Date: 25.JUL.2018 21:09:48

Client	Mitel Networks Corporation	
Product	SIP-DECT Base Station RFP 48	
Standard(s)	RSS-213 Issue 3:2015& FCC Part 15 Subpart D:2017	

Mid Channel

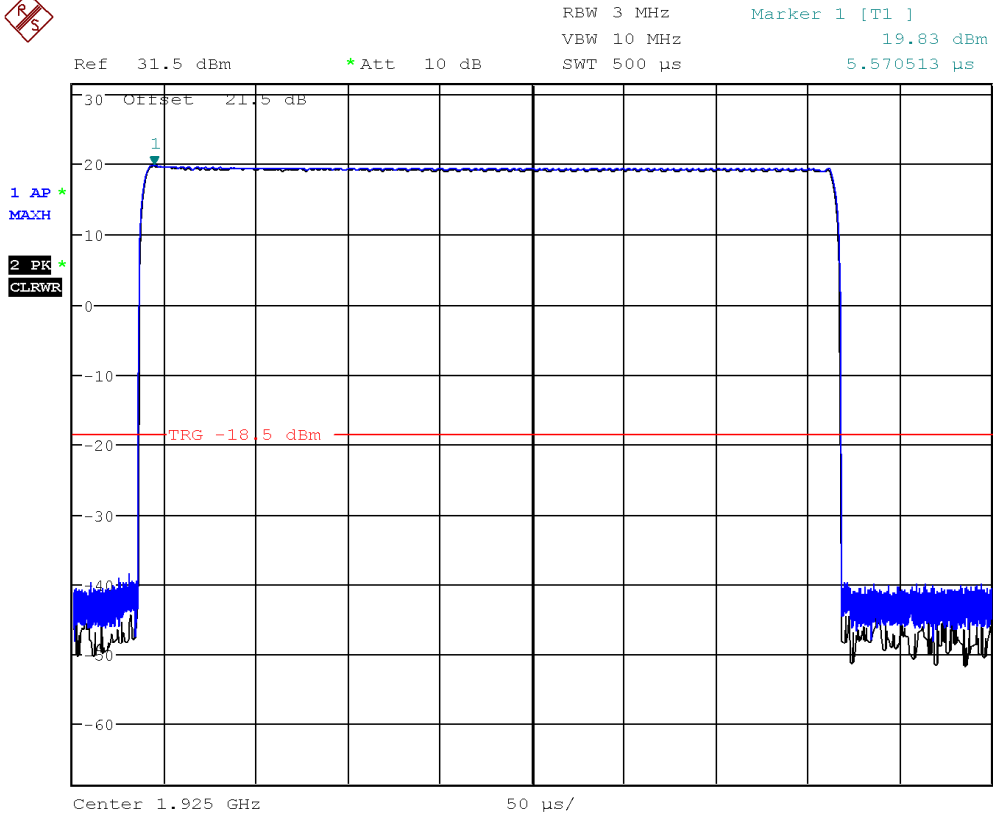

Date: 25.JUL.2018 21:06:19

Client	Mitel Networks Corporation	
Product	SIP-DECT Base Station RFP 48	
Standard(s)	RSS-213 Issue 3:2015& FCC Part 15 Subpart D:2017	

High Channel

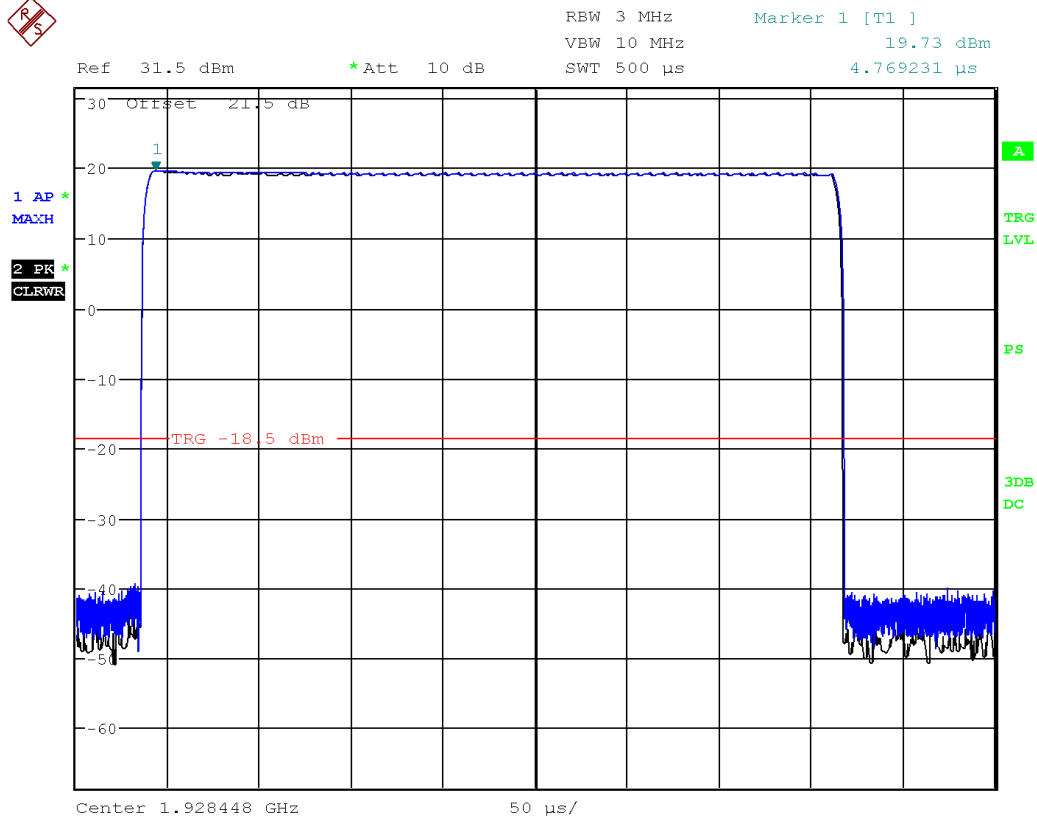

Date: 25.JUL.2018 21:01:21

Client	Mitel Networks Corporation	
Product	SIP-DECT Base Station RFP 48	
Standard(s)	RSS-213 Issue 3:2015& FCC Part 15 Subpart D:2017	

Power Spectral Density

Measurement Procedure:

ANSI C63.17, clause 6.1.5.

Limit

The Power Spectral Density shall be less than 3 mW (4.77 dBm).

Test Results:

Pass

Measurement Data:

Channel	Frequency (MHz)	dBm	mW
4	1921.536	1.48	1.41
2	1924.992	1.21	1.33
0	1928.448	1.45	1.40

Client	Mitel Networks Corporation	 Canada
Product	SIP-DECT Base Station RFP 48	
Standard(s)	RSS-213 Issue 3:2015& FCC Part 15 Subpart D:2017	

Low



Ref 31.5 dBm *Att 10 dB RBW 3 kHz Marker 1 [T1]
 VBW 30 kHz 1.48 dBm
 SWT 2 ms 247.000000 µs

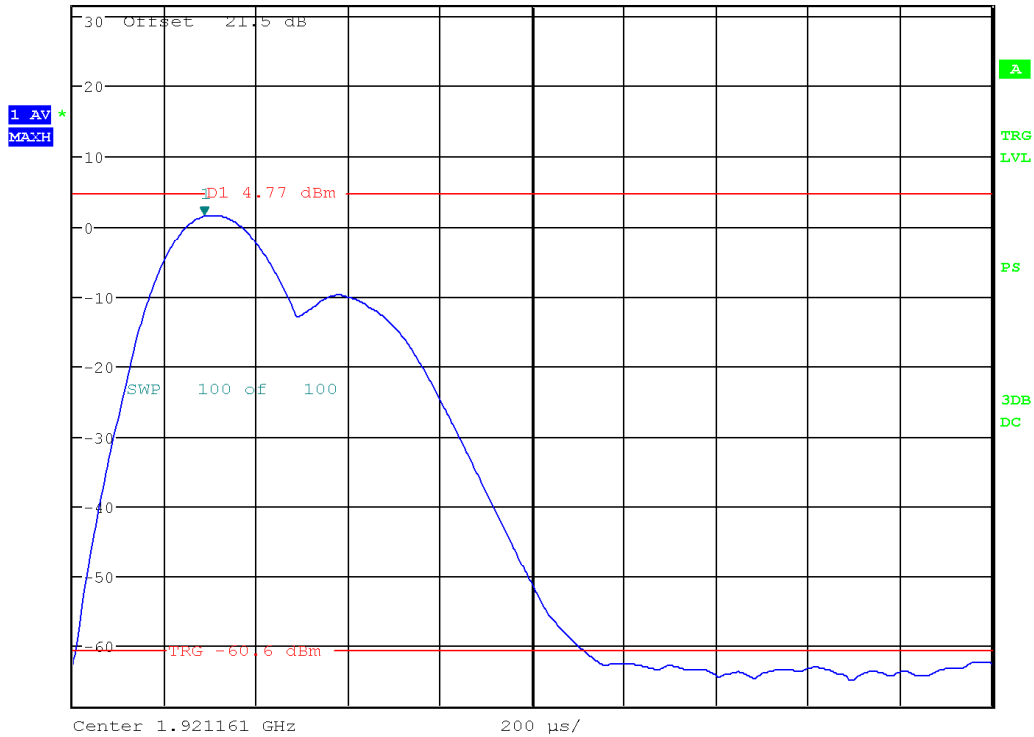

Date: 25.JUL.2018 21:35:33

Middle

Client	Mitel Networks Corporation	
Product	SIP-DECT Base Station RFP 48	
Standard(s)	RSS-213 Issue 3:2015& FCC Part 15 Subpart D:2017	

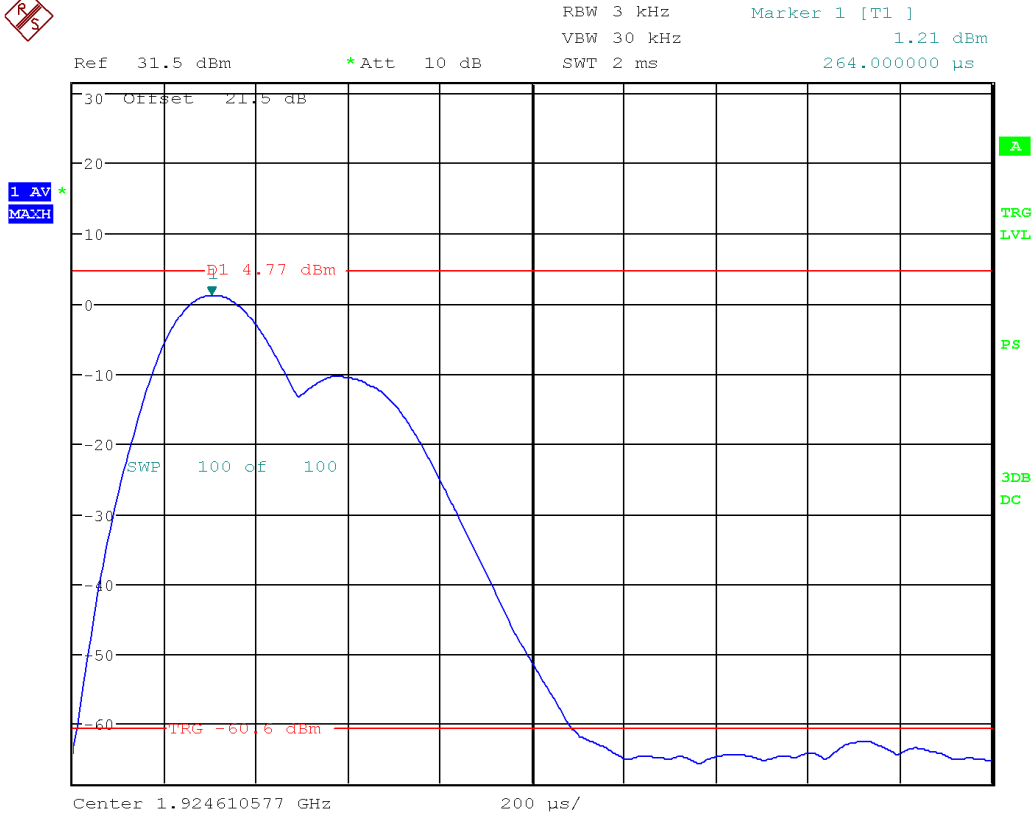

Date: 25.JUL.2018 21:37:34

Client	Mitel Networks Corporation	 Canada
Product	SIP-DECT Base Station RFP 48	
Standard(s)	RSS-213 Issue 3:2015& FCC Part 15 Subpart D:2017	

High



Ref 31.5 dBm *Att 10 dB RBW 3 kHz Marker 1 [T1]
 VBW 10 kHz 1.45 dBm
 SWT 2 ms 264.000000 μs

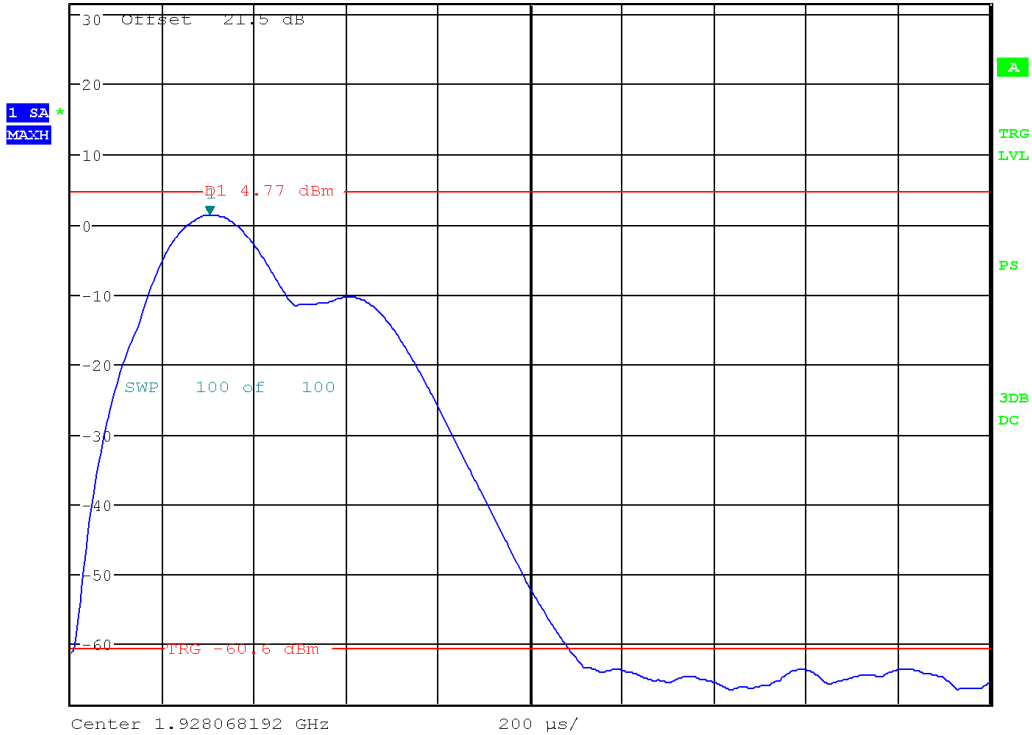

Date: 25.JUL.2018 21:39:56

Client	Mitel Networks Corporation	
Product	SIP-DECT Base Station RFP 48	
Standard(s)	RSS-213 Issue 3:2015& FCC Part 15 Subpart D:2017	

Automatic discontinue of information

Limit:

The device shall automatically discontinue transmission in case of either absence of information to transmit or operational failure. This provision is not intended to preclude transmission of control and signaling information or use or repetitive code used by certain digital modulation technologies to complete frame or burst intervals.

Test Result:

Pass

The EUT transmits control and Signaling Information.

The EUT is a responding device only. The following tests simulate the reaction of the EUT in case of either absence of information to transmit or operational failure after a connection with the companion device is established.

Test	EUT Result	Pass/Fail
Power removed from EUT	Connection lost, all transmissions stop	Pass
Not Applicable the EUT does not have an on/off switch	Not Applicable the EUT does not have an on/off switch	N/A
Hook on by companion device	Connection lost, EUT transmits control and signal information only	Pass
Hook on by EUT	EUT can not perform Hook-on	N/A
Power removed from companion device	Connection lost, EUT transmits control and signal information only	Pass
Companion device switched Off	Connection lost, EUT transmits control and signal information only	Pass

Client	Mitel Networks Corporation	
Product	SIP-DECT Base Station RFP 48	
Standard(s)	RSS-213 Issue 3:2015& FCC Part 15 Subpart D:2017	

Emission Bandwidth

Measurement Procedure:

ANSI C63.17, clause 6.1.3.

Limit:

The 26 dB Bandwidth B shall be larger than 50 kHz and less than 2.5 MHz.

Test Results:

Pass

Measurement Data:

Channel	Frequency (MHz)	26 DB Bandwidth MHz	Occupied Bandwidth (OBW = 99%) MHz
4	1921.536	1.467	1.212
2	1924.992	1.404	1.216
0	1928.448	1.347	1.207

Note: For the purposes of EBW the lowest emission bandwidth was measured to be 1346153 Hz.

Client	Mitel Networks Corporation	
Product	SIP-DECT Base Station RFP 48	
Standard(s)	RSS-213 Issue 3:2015& FCC Part 15 Subpart D:2017	

Low 26 dB BW

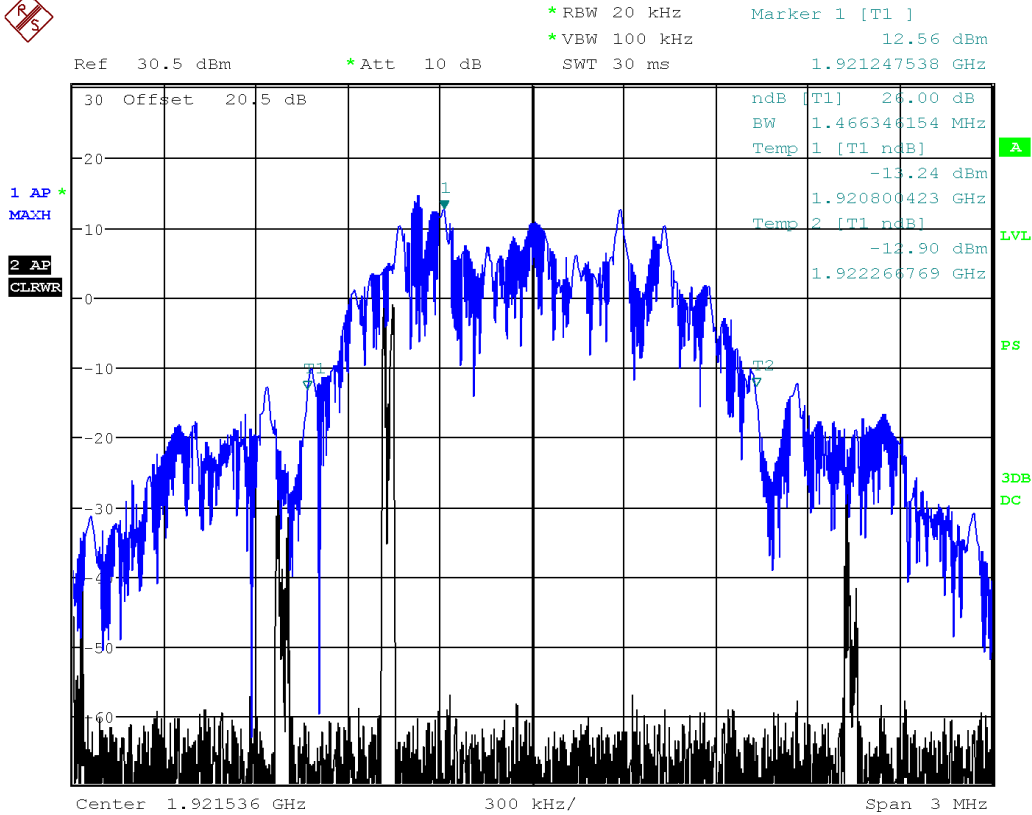

Date: 25.JUL.2018 20:17:03

Client	Mitel Networks Corporation	
Product	SIP-DECT Base Station RFP 48	
Standard(s)	RSS-213 Issue 3:2015& FCC Part 15 Subpart D:2017	

Low OBW

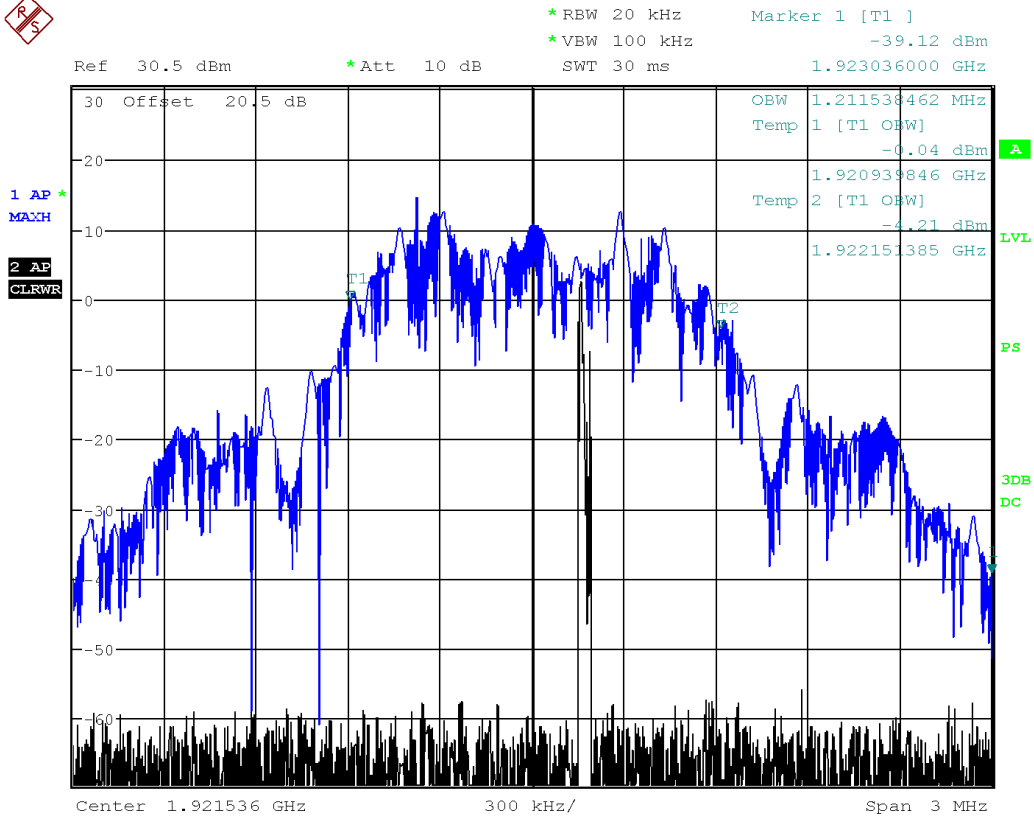

Date: 25.JUL.2018 20:36:58

Client	Mitel Networks Corporation	
Product	SIP-DECT Base Station RFP 48	
Standard(s)	RSS-213 Issue 3:2015& FCC Part 15 Subpart D:2017	

Mid 26 dB BW

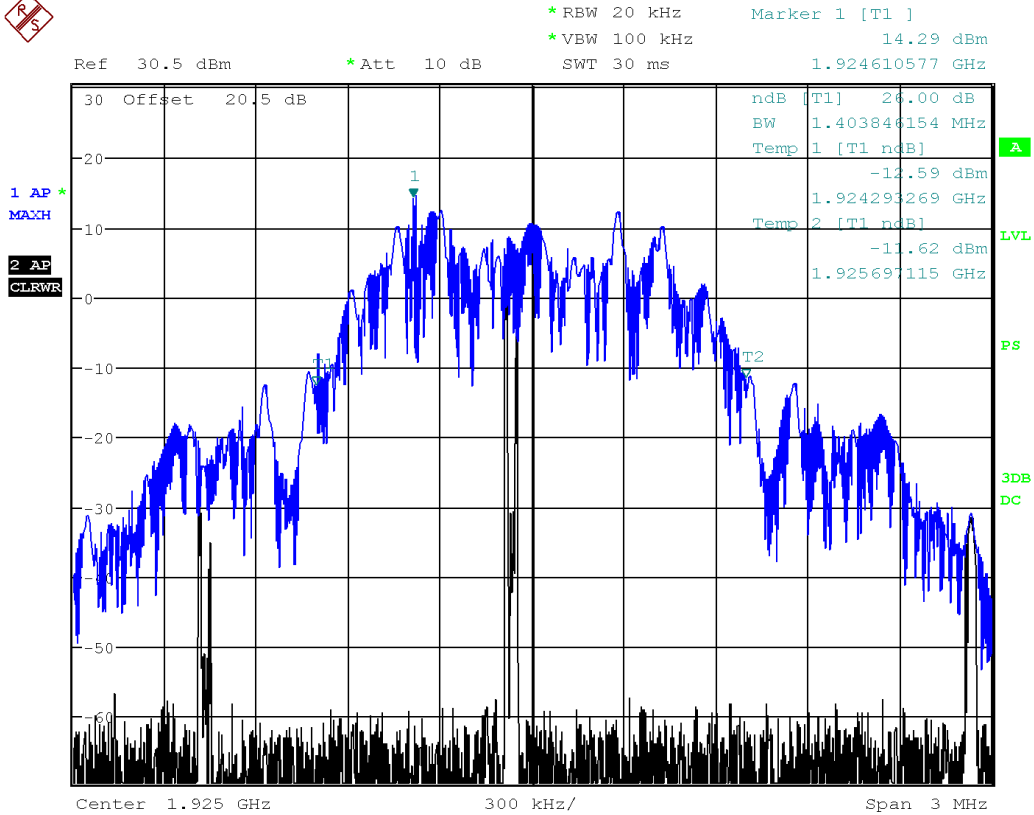

Date: 25.JUL.2018 20:38:33

Client	Mitel Networks Corporation	
Product	SIP-DECT Base Station RFP 48	
Standard(s)	RSS-213 Issue 3:2015& FCC Part 15 Subpart D:2017	

Mid OBW

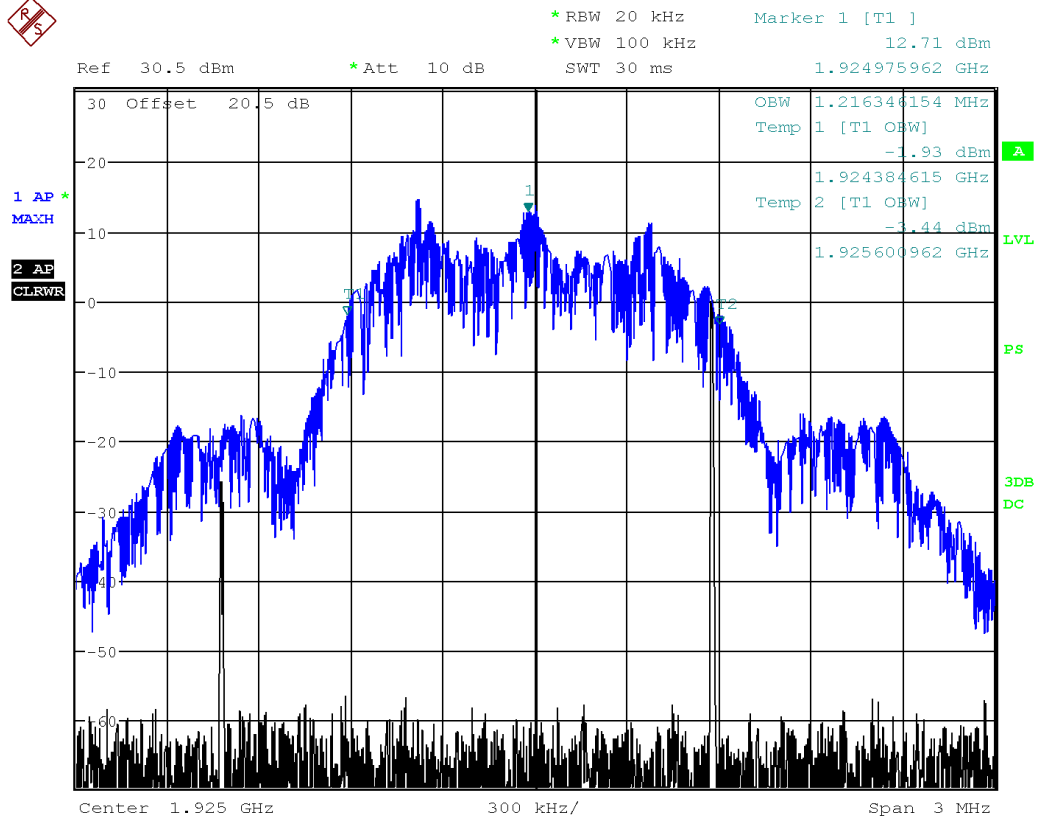

Date: 25.JUL.2018 20:28:34

Client	Mitel Networks Corporation	
Product	SIP-DECT Base Station RFP 48	
Standard(s)	RSS-213 Issue 3:2015& FCC Part 15 Subpart D:2017	

High 26 dB BW

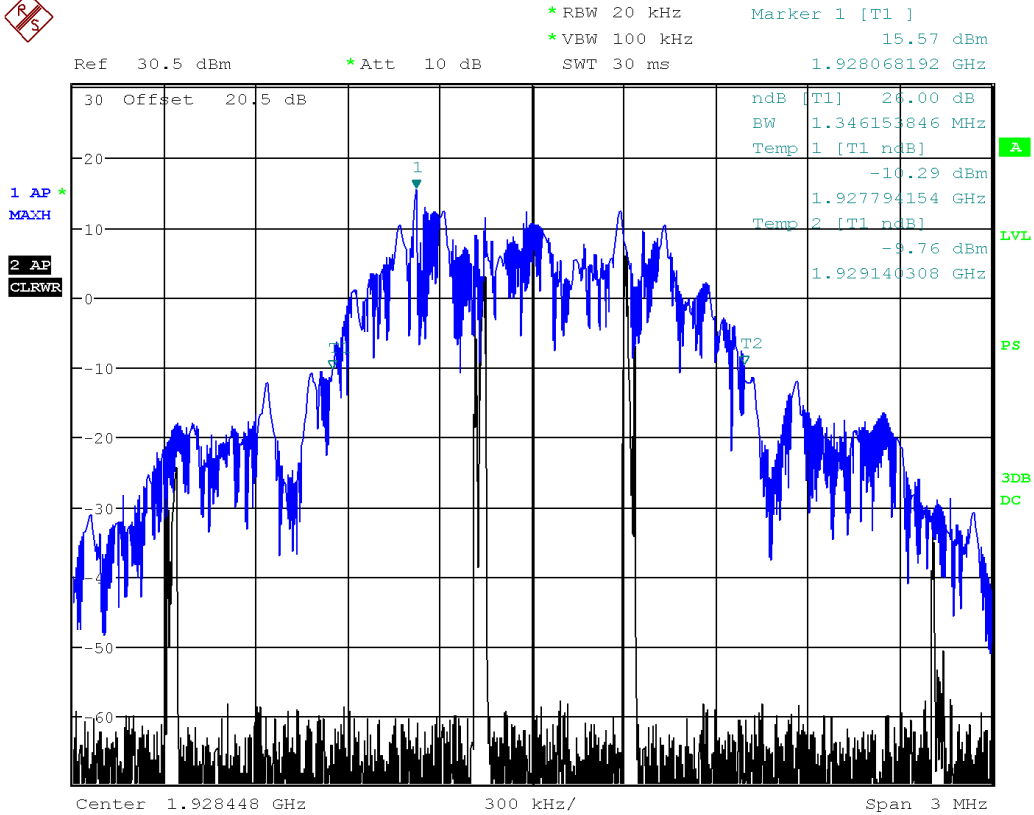

Date: 25.JUL.2018 20:44:25

Client	Mitel Networks Corporation	
Product	SIP-DECT Base Station RFP 48	
Standard(s)	RSS-213 Issue 3:2015& FCC Part 15 Subpart D:2017	

High OBW

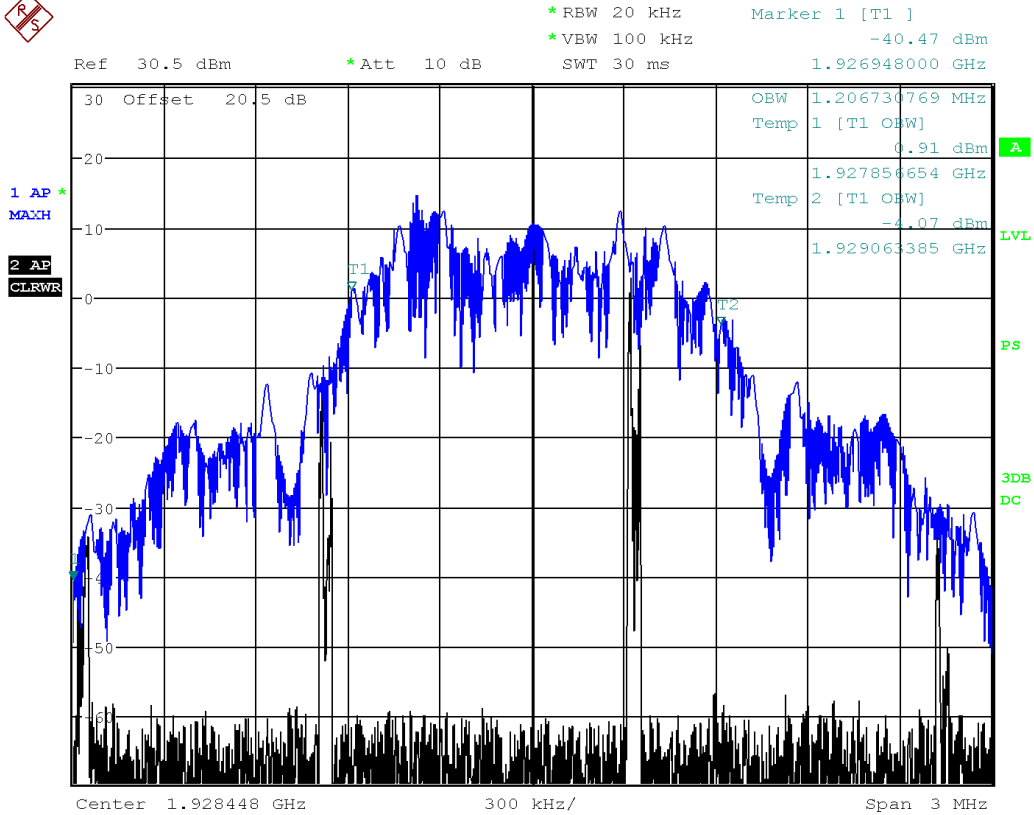

Date: 25.JUL.2018 20:32:10

Client	Mitel Networks Corporation	
Product	SIP-DECT Base Station RFP 48	
Standard(s)	RSS-213 Issue 3:2015& FCC Part 15 Subpart D:2017	

Monitoring Threshold & Least interfered channel

Measurement Procedure:

The Upper Threshold is found by the procedure defined in ANSI C63.17 clause 7.3.1 or 7.3.2.

Limit:

Upper Threshold:

$$TU = 15 \log B - 184 + 50 - PEUT \text{ (dBm)}$$

B is measured Emission Bandwidth in Hz = 1346153

PEUT is measured Transmitter Power in dBm = 19.9

$$TU = 15 \text{ Log}(1346153) - 184 + 50 - 19.9$$

$$TU = 91.94 - 184 + 50 - 19.9$$

$$TU = -61.96 \text{ dBm}$$

The Upper Threshold is applicable for systems with more than 40 duplex systems access channels and that implements the Least Interfered Channel Procedure (LIC). FCC 15.323(b), (c)(2) and (c)(5)

Least Interfered Channel Procedure used with an Upper Threshold -61.96 dBm

Test Results

Least Interfered Channel (LIC) Procedure Test, ANSI C63.17 clause 7.3.3 ref. Observation Verdict

- a) f1 TL + 13 dB, f2 TL + 6 dB Transmission always on f2 Pass
- b) f1 TL + 6 dB, f2 TL + 13 dB Transmission always on f1 Pass
- c) f1 TL + 7 dB, f2 TL Transmission always on f2 Pass
- d) f1 TL, f2 at TL+ 7 dB Transmission always on f1 Pass

Selected Channel Confirmation, FCC 15.323(c)(1) and (5)

ANSI C63.17 clause 7.3.4 ref. Observation Verdict

- a) Shall not transmit on f1 EUT transmits on f2 Pass
- b) Shall not transmit on f2 EUT transmits on f1 Pass

Limits:

Upper Threshold + 6 dB margin -55.96 dBm

Client	Mitel Networks Corporation	 Canada
Product	SIP-DECT Base Station RFP 48	
Standard(s)	RSS-213 Issue 3:2015& FCC Part 15 Subpart D:2017	

Graph

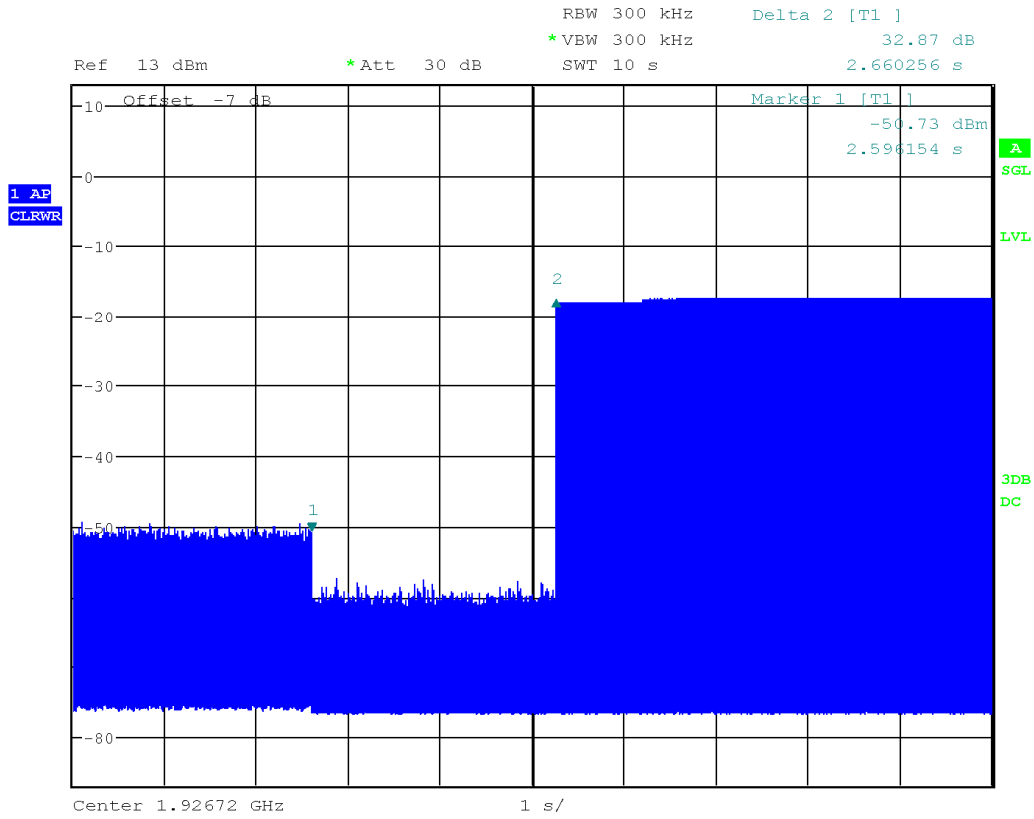

Date: 20.JUL.2018 15:23:37

Selected Channel Confirmation, connection 2.66 sec after interferer removed

Client	Mitel Networks Corporation	
Product	SIP-DECT Base Station RFP 48	
Standard(s)	RSS-213 Issue 3:2015& FCC Part 15 Subpart D:2017	

Acknowledgements, Test interval and functional test

Acknowledgments: ANSI C63.17, clause 8.2.1

During the test initial transmission without acknowledgments the signal from the EUT to the companion device is blocked by circulators in addition to the tunable attenuator. The test Transmission time after loss of acknowledgments is performed by cutting-off the signal from the companion device by a RF switch the time until the EUT stops transmitting.

The Transmission Duration test is performed by monitoring the slot in use and measuring the time until the EUT changes to a different slot.

Limits:

FCC 15.323(c)(3) and (4)

Occupation of the same combined time and spectrum windows by a device or group of cooperating devices continuously over a period of time longer than 8 hours is not permitted without repeating the access criteria. This is not applicable as the only for initiating device that controls which time slot is used.

Once access to specific combined time and spectrum windows is obtained an acknowledgment from a system participant must be received by the initiating transmitter within one second or transmission must cease.

Periodic acknowledgments must be received at least every 30 seconds or transmission must cease.

Channels used exclusively for control and signaling information may transmit continuously for 30 seconds without receiving an acknowledgement, at which the time access criteria must be repeated.

Test Result

Acknowledgments

Test ref. to ANSI C63.17 clause 8.2.1	Result	Pass/Fail
a) Initial transmission without acknowledgments	Only for initiating device	N/A
c) Transmission time after loss of acknowledgments	5 s	Pass

Client	Mitel Networks Corporation	
Product	SIP-DECT Base Station RFP 48	
Standard(s)	RSS-213 Issue 3:2015& FCC Part 15 Subpart D:2017	

Graph

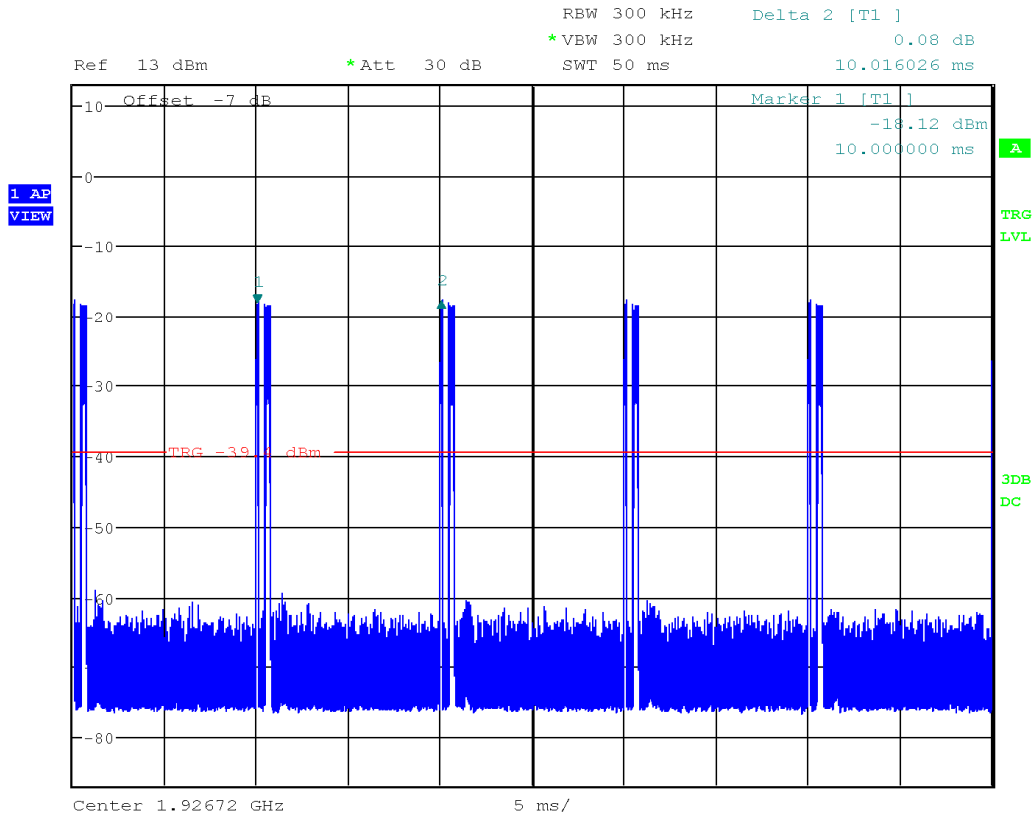

Date: 20.JUL.2018 15:37:45

Client	Mitel Networks Corporation	
Product	SIP-DECT Base Station RFP 48	
Standard(s)	RSS-213 Issue 3:2015& FCC Part 15 Subpart D:2017	

Threshold monitoring bandwidth

This test is only required if a dedicated monitoring receiver is used. If the test is not carried out the manufacturer shall declare and provide evidence that the monitoring is made through the radio receiver used for communication.

Measurement Procedure:

Simple Compliance Test, ANSI C63.17, clause 7.4.1

The test is passed if either the Simple Compliance Test or the More Detailed Test is passed. During this test the spectrum analyzer is observed visually to see if the EUT transmits or not.

Limits:

FCC 15.323(c)(7):

The monitoring system bandwidth must be equal to or greater than the emission bandwidth of the intended transmission.

Test Results:

Simple Compliance Test, at $\pm 30\%$ of B was applied, No transmissions occurred and this was deemed a Pass

Client	Mitel Networks Corporation	
Product	SIP-DECT Base Station RFP 48	
Standard(s)	RSS-213 Issue 3:2015& FCC Part 15 Subpart D:2017	

Out of Band Unwanted Emissions, antenna conducted

Measurement Procedure:

ANSI C63.17, clause 6.1.6.1.

Limit

Requirement: FCC 15.323(d)

-9.5 dBm from 0 to 1.25 MHz out of band

-29.5 dBm from 1.25 MHz to 2.5 MHz out of band

-39.5 dBm 2.5 MHz or more out of band

Test Result

Pass

Measurement Data

See Graphs

Client	Mitel Networks Corporation	 Canada
Product	SIP-DECT Base Station RFP 48	
Standard(s)	RSS-213 Issue 3:2015& FCC Part 15 Subpart D:2017	



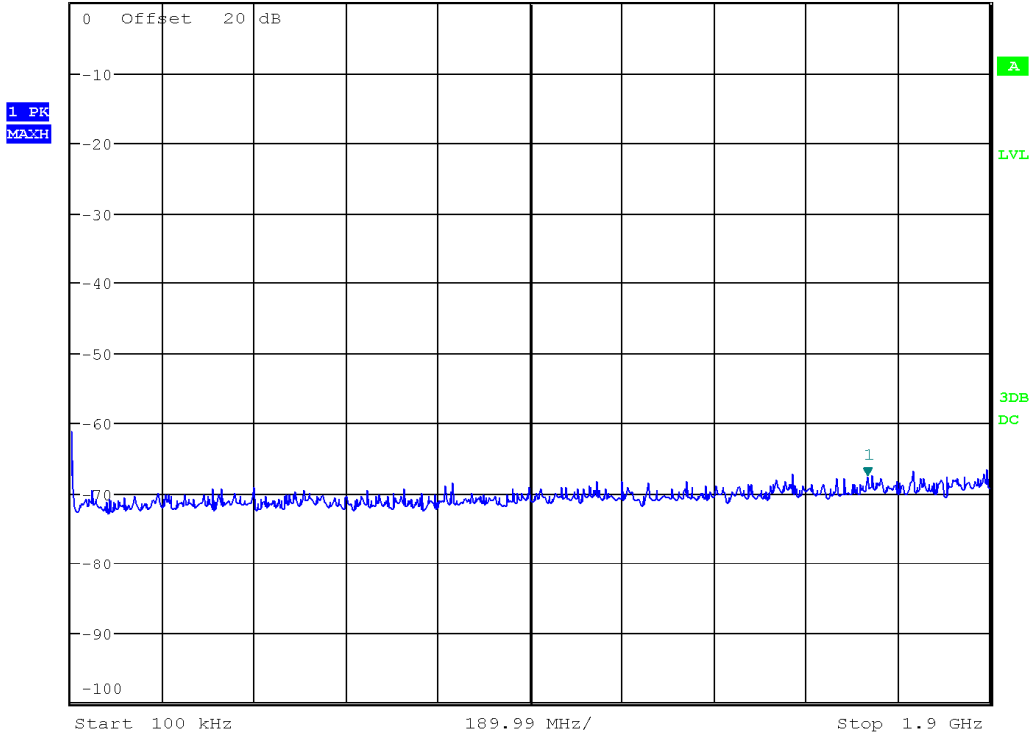

*RBW 20 kHz Marker 1 [T1]
 *VEW 100 kHz -67.49 dBm
 Ref 0 dBm Att 10 dB SWT 4.8 s 1.647288942 GHz



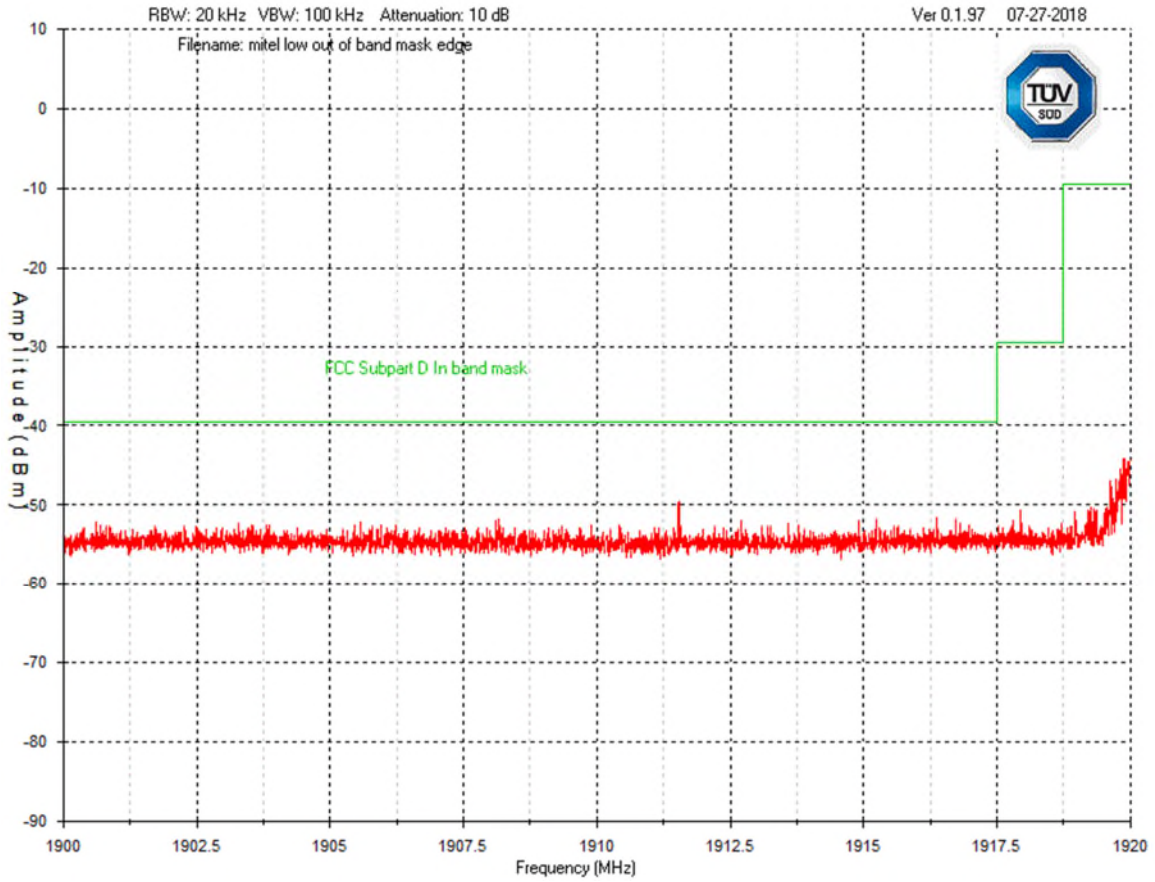

Date: 27.JUL.2018 20:39:02

Client	Mitel Networks Corporation	
Product	SIP-DECT Base Station RFP 48	
Standard(s)	RSS-213 Issue 3:2015& FCC Part 15 Subpart D:2017	

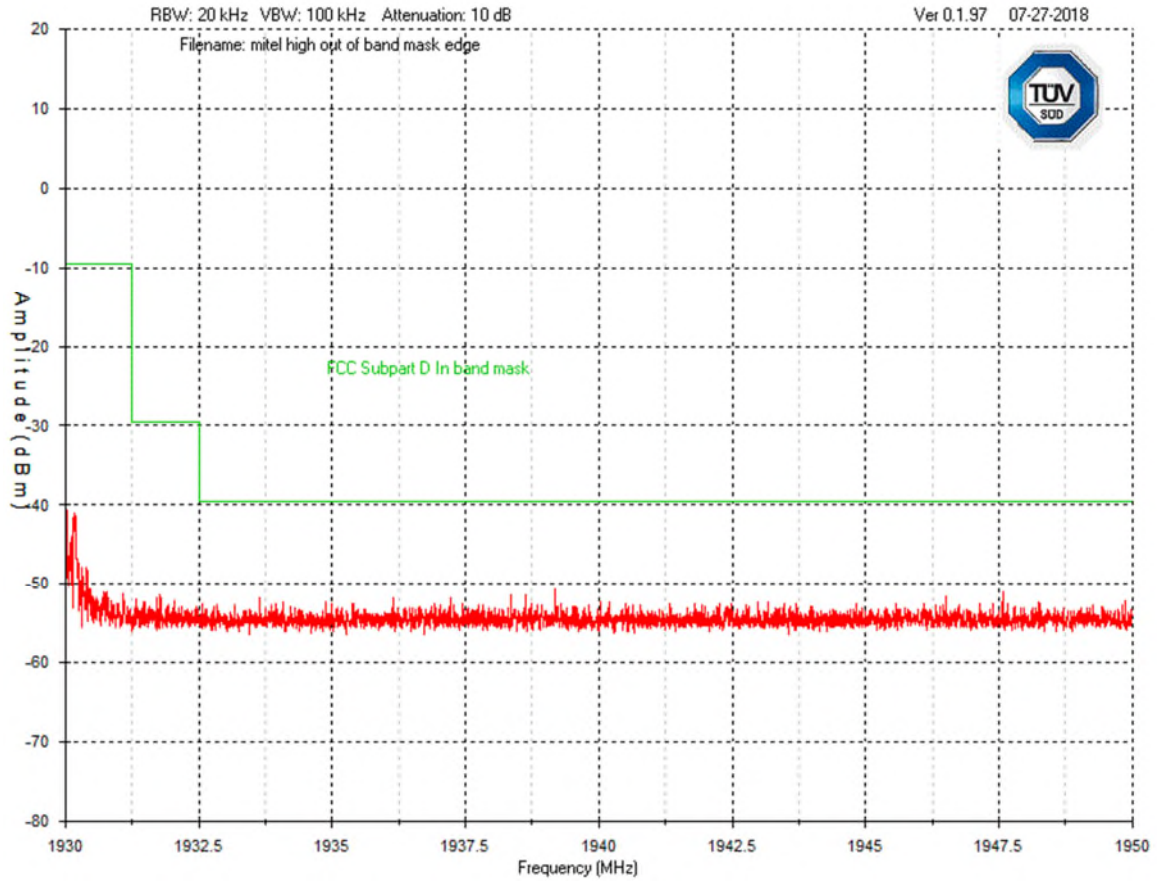

Client	Mitel Networks Corporation	
Product	SIP-DECT Base Station RFP 48	
Standard(s)	RSS-213 Issue 3:2015& FCC Part 15 Subpart D:2017	



Client	Mitel Networks Corporation	 Canada
Product	SIP-DECT Base Station RFP 48	
Standard(s)	RSS-213 Issue 3:2015& FCC Part 15 Subpart D:2017	

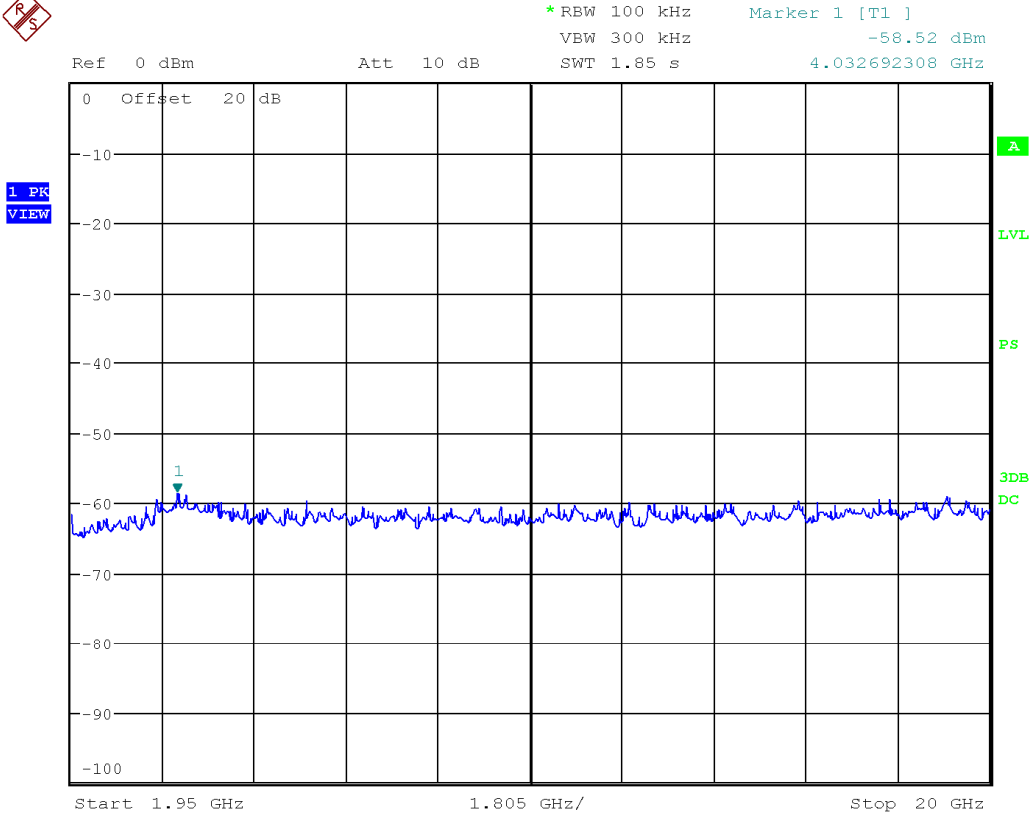

Date: 27.JUL.2018 20:33:49

Client	Mitel Networks Corporation	
Product	SIP-DECT Base Station RFP 48	
Standard(s)	RSS-213 Issue 3:2015& FCC Part 15 Subpart D:2017	

In Band Emission Mask, antenna conducted

Measurement Procedure:

ANSI C63.17, clause 6.1.6.1.

Limit

Requirement: FCC 15.323(d)

1B to 2B -> 30dB below power

2B to 3B -> 50 dB below power

3B to band edge -> 60 dB below power

B=1346153 Hz, Power = 19.7 dBm

Client	Mitel Networks Corporation	
Product	SIP-DECT Base Station RFP 48	
Standard(s)	RSS-213 Issue 3:2015& FCC Part 15 Subpart D:2017	

Low

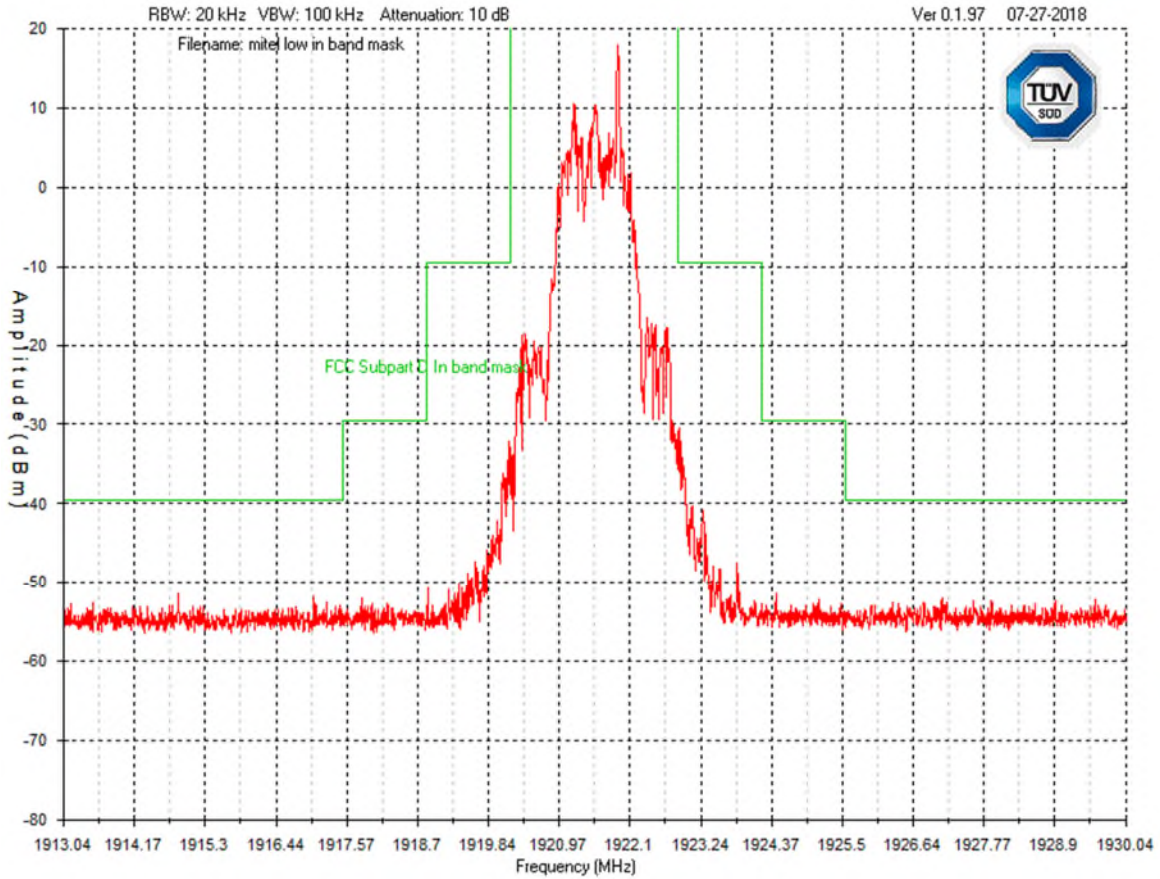

Client	Mitel Networks Corporation	
Product	SIP-DECT Base Station RFP 48	
Standard(s)	RSS-213 Issue 3:2015& FCC Part 15 Subpart D:2017	

Mid

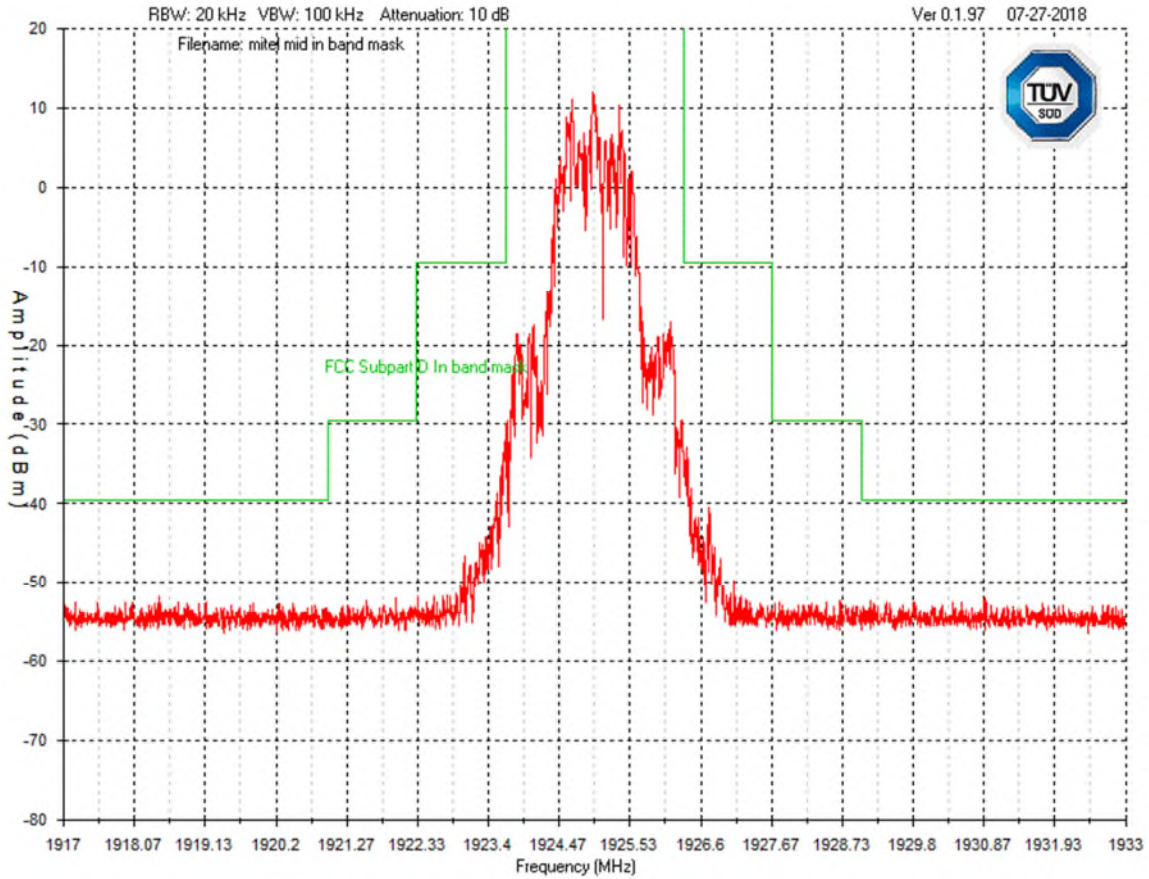

Client	Mitel Networks Corporation	
Product	SIP-DECT Base Station RFP 48	
Standard(s)	RSS-213 Issue 3:2015& FCC Part 15 Subpart D:2017	

High

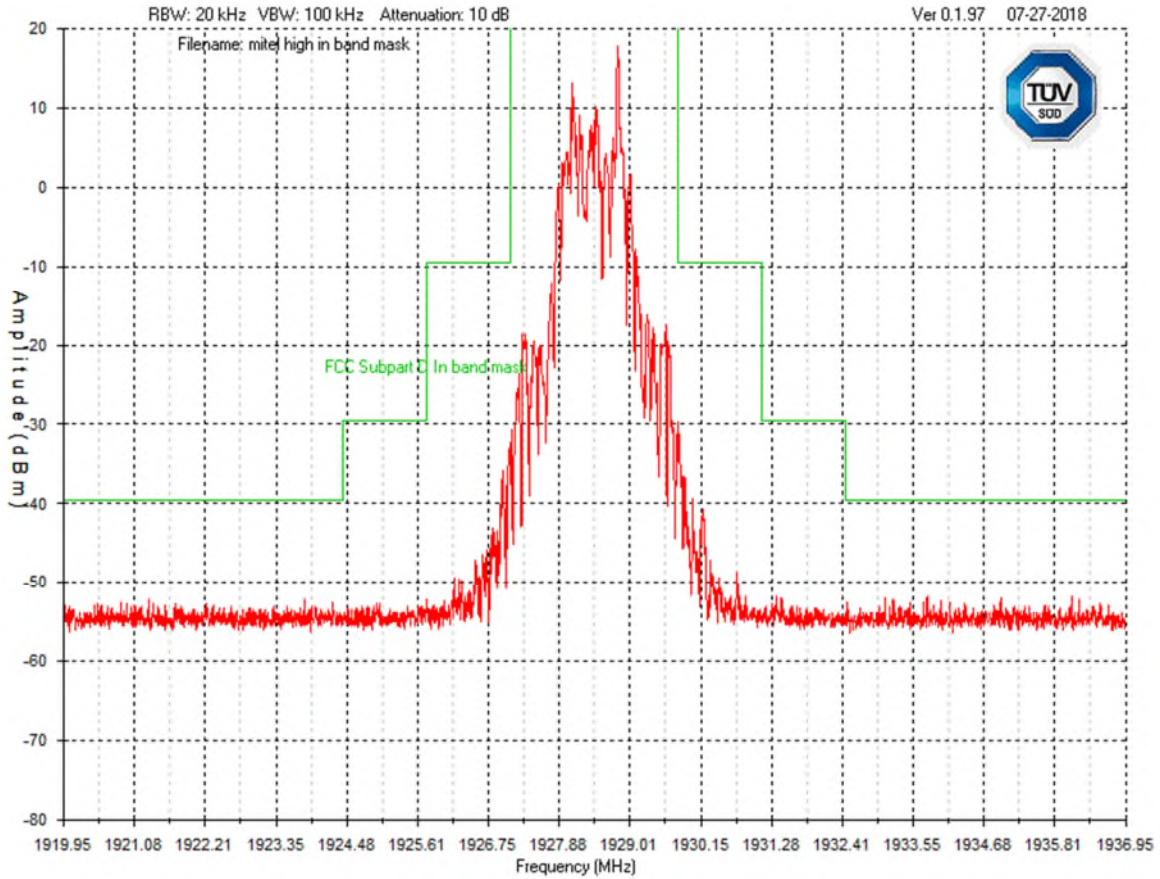

Client	Mitel Networks Corporation	
Product	SIP-DECT Base Station RFP 48	
Standard(s)	RSS-213 Issue 3:2015& FCC Part 15 Subpart D:2017	

Frame repetition stability, Frame period and jitter

Measurement Procedure:

ANSI C63.17, clause 6.2.2 and 6.2.3

Limit:

Frame Repetition Stability ± 10 ppm (TDMA)

Max Jitter = 25 uS or 3 times St.Dev. of Jitter = 12.5 uS

Test Results:

Pass. Note at as the device more than met ppm and jitter with the worst case results, standard deviation was not applied.

Measurement Data:

The Frame Repetition Stability is measured with the CMD60. The Frame Repetition Stability is 3 times the standard deviation.

Carrier Frequency	Worst case (Hz)
1924.992 MHz	123.00000

Carrier Frequency	Frame Period	Worst Case Max Jitter (uS)	3xStandard Deviation of Jitter (μ s)
1924.992 MHz	10 mS	-0.005	0.006

Client	Mitel Networks Corporation	
Product	SIP-DECT Base Station RFP 48	
Standard(s)	RSS-213 Issue 3:2015& FCC Part 15 Subpart D:2017	

Frequency stability

Measurement Procedure:

ANSI C63.17, clause 6.2.1.

Limit

Over the temperature range of -20C to +50C, 10 ppm

Over the voltage range of +/- 15% of the nominal voltage (115 Vac), 10 ppm.

Test result

Pass. See data below

Data

The Carrier Frequency Stability over power Supply Voltage and over Temperature is measured also with the CMD60.

Temperature	Measured Carrier Frequency (MHz)	Difference (kHz)	Deviation (ppm)	Pass/Fail
20C	1924.989	ref	N/A	N/A
-20C	1924.992	3	1.6	Pass
+50C	1924.991	2	1.0	Pass

Deviation ppm = ((Mean – Measured frequency) / Mean) x 10⁶

Over the Voltage range of 95Vac to 140 Vac (exceeding the requirements) there was no measureable difference in frequency.

Client	Mitel Networks Corporation	
Product	SIP-DECT Base Station RFP 48	
Standard(s)	RSS-213 Issue 3:2015& FCC Part 15 Subpart D:2017	

Appendix A – EUT Summary

Client	Mitel Networks Corporation	
Product	SIP-DECT Base Station RFP 48	
Standard(s)	RSS-213 Issue 3:2015& FCC Part 15 Subpart D:2017	

For further details for filing purposes, refer to filing package.

General EUT Description

Client Details	
Organization / Address	Mitel Networks Corp 350 Legget Drive, Kanata, Ontario, Canada, K2K 2W7
Contact	Paul Scott
Phone	(613) 592 2122
Email	Paul.Scott@Mitel.com
EUT (Equipment Under Test) Details	
EUT Name (for report title)	SIP-DECT Base Station RFP 48
EUT revision	New product Original Version
Software version	SIP-DECT 8.0TC12
Equipment category	DECT base station/WiLAN access point
EUT is powered using	DC Power over Ethernet 48Vdc
If mains powered, how many plugs?	N/A
Input voltage range(s) (V)	48Vdc over POE adaptor
Frequency range(s) (Hz)	n/a
Rated input current (A)	310mA
Nominal power consumption (W)	17W
Number of power supplies in EUT	1
Transmits RF energy? (describe)	Yes 100mW
Basic EUT functionality description	DECT base station and WiLAN access point
High level block diagram of EUT (attachment)	Provided PDF file Name:EXHIBIT4- RFP 48 BLOCK DIAGRAMs.pdf
Modes of operation	DECT base station/2.4
Step by step instructions for setup and operation	Just POWER ON
Customer to setup EUT on site?	Yes
EUT response time (ms)	<= 0.5ms
EUT setup time (min)	5ms
Frequency of all clocks present in EUT	25MHZ

Client	Mitel Networks Corporation	
Product	SIP-DECT Base Station RFP 48	
Standard(s)	RSS-213 Issue 3:2015& FCC Part 15 Subpart D:2017	

I/O cable description Specify length and type	CAT5 10Meter
Available connectors on EUT	NO
Peripherals required to exercise EUT Ex. Signal generator	Ehternet HUB with POE and an external Laptop or PC and DECT phones QTY 2 model Mitel M6xxD
Dimensions of product	L 175mm W 175mm H 40mm
Method of monitoring EUT and description of failure for immunity.	Laptop to monitor "ping" and 2xDECT handsets

Note the EUT is considered to have been received the date of the commencement of the first test, unless otherwise stated. For a close-up picture of the EUT, see ‘Appendix B – EUT and Test Setup Photos’.

Client	Mitel Networks Corporation	
Product	SIP-DECT Base Station RFP 48	
Standard(s)	RSS-213 Issue 3:2015& FCC Part 15 Subpart D:2017	

EUT Functional Description

The Mitel RFP 48 product is used as a DECT Base station and access point WLAN as well as IP telephony

EUT Configuration

Please see Appendix B for a picture of the unit running under normal conditions. Cables were connected as per manufacturer 's specification.

Client	Mitel Networks Corporation	
Product	SIP-DECT Base Station RFP 48	
Standard(s)	RSS-213 Issue 3:2015& FCC Part 15 Subpart D:2017	

<u>Test</u>	<u>Component</u>	<u>Model</u>	<u>Serial#</u>
Power Line Conducted Emissions	RFP 48 DECT Base Station	Mitel 501029501	3C2FW1833A1212M MAC: 08:00:0F:C3:DE:91
	POE AC adaptor	MITEL 51015131	710980564422
	LAPTOP1 (LAN)	DELL VOSTRO 3300	43155266365

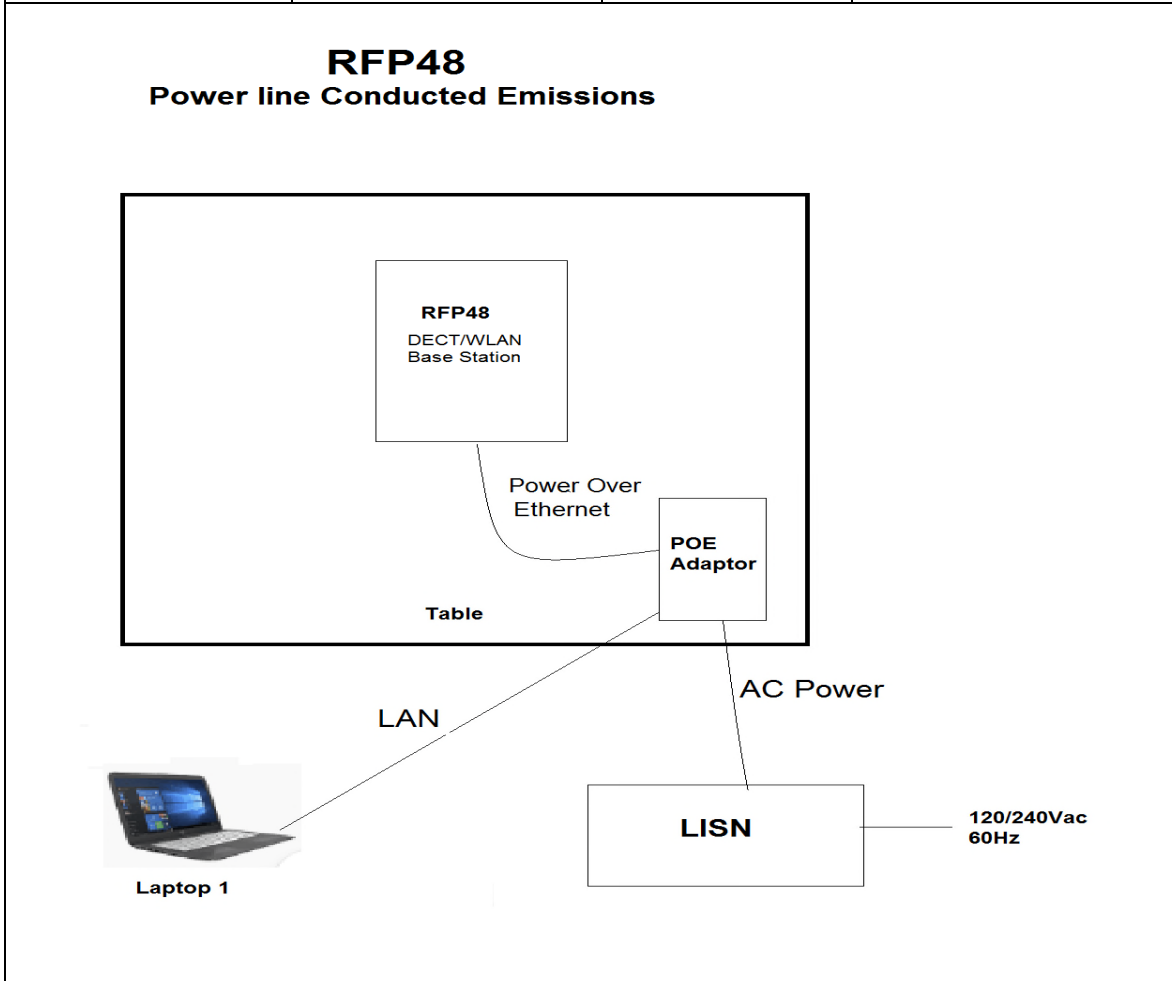

Client	Mitel Networks Corporation	
Product	SIP-DECT Base Station RFP 48	
Standard(s)	RSS-213 Issue 3:2015& FCC Part 15 Subpart D:2017	

Telecom Line Conducted Emissions	RFP 48 DECT Base Station	Mitel 501029501	3C2FW1833A1212M MAC: 08:00:0F:C3:DE:91
	POE AC adaptor	MITEL 51015131	710980564422
	LAPTOP1	DELL VOSTRO 3300	43155266365

RFP48
Telecom Line Conducted Emissions

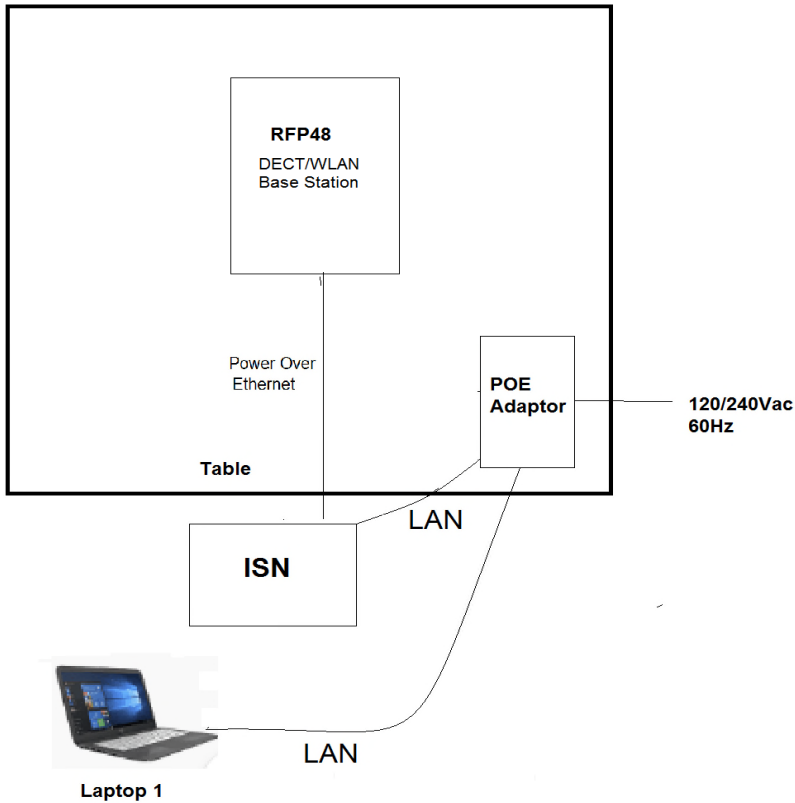

Client	Mitel Networks Corporation	 Canada
Product	SIP-DECT Base Station RFP 48	
Standard(s)	RSS-213 Issue 3:2015& FCC Part 15 Subpart D:2017	

Appendix B – EUT and Test Setup Photos

For information only. Refer to the photo exhibit separate from this test report

Client	Mitel Networks Corporation	
Product	SIP-DECT Base Station RFP 48	
Standard(s)	RSS-213 Issue 3:2015& FCC Part 15 Subpart D:2017	

Power Line Conducted Emissions

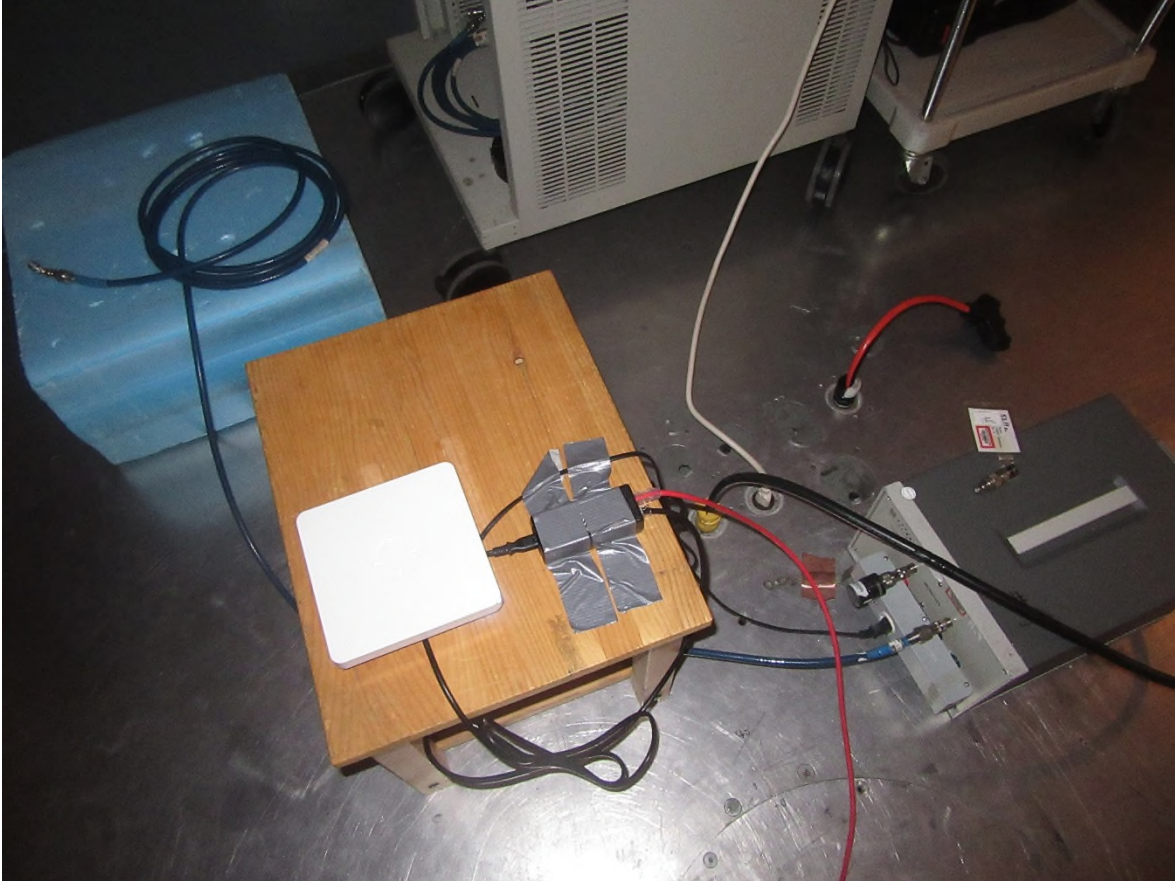

Client	Mitel Networks Corporation	 Canada
Product	SIP-DECT Base Station RFP 48	
Standard(s)	RSS-213 Issue 3:2015& FCC Part 15 Subpart D:2017	

Radiated Emissions – 9kHz to 30 MHz





Client	Mitel Networks Corporation	
Product	SIP-DECT Base Station RFP 48	
Standard(s)	RSS-213 Issue 3:2015& FCC Part 15 Subpart D:2017	

Radiated Emissions – 30 MHz to 1 GHz



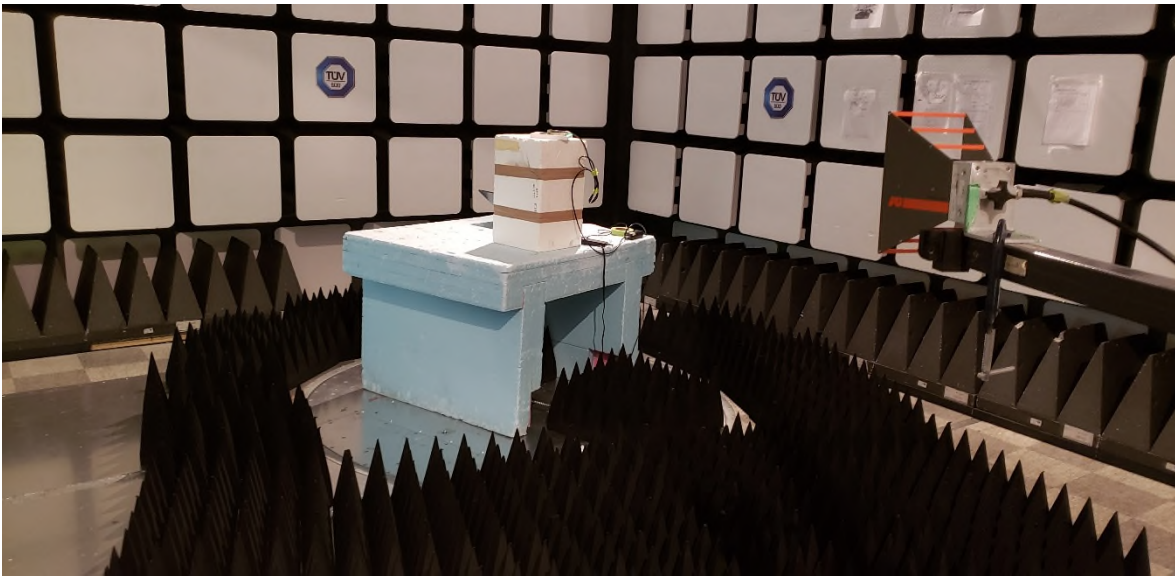

Radiated Emissions – 1GHz to 40 GHz

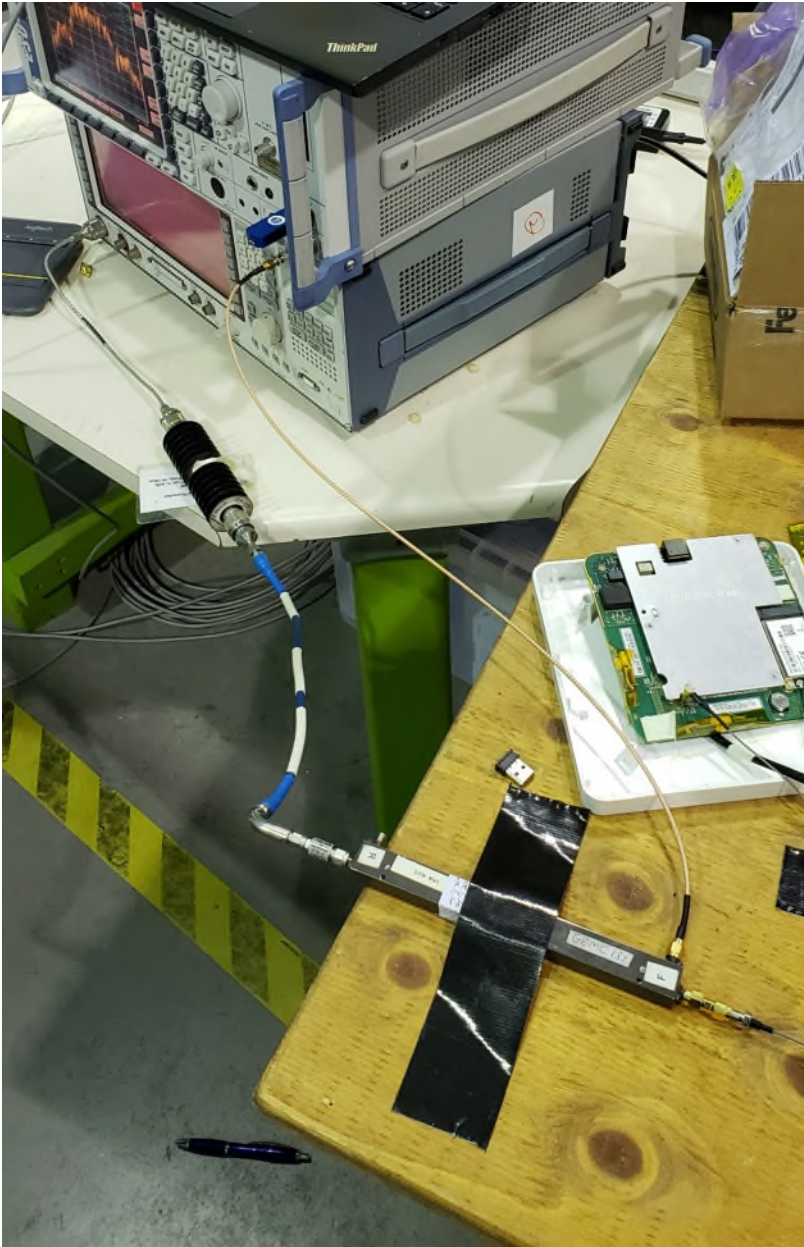

Client	Mitel Networks Corporation	
Product	SIP-DECT Base Station RFP 48	
Standard(s)	RSS-213 Issue 3:2015& FCC Part 15 Subpart D:2017	

Antenna Conducted Measurements



Client	Mitel Networks Corporation	
Product	SIP-DECT Base Station RFP 48	
Standard(s)	RSS-213 Issue 3:2015& FCC Part 15 Subpart D:2017	

Monitoring and threshold Setup

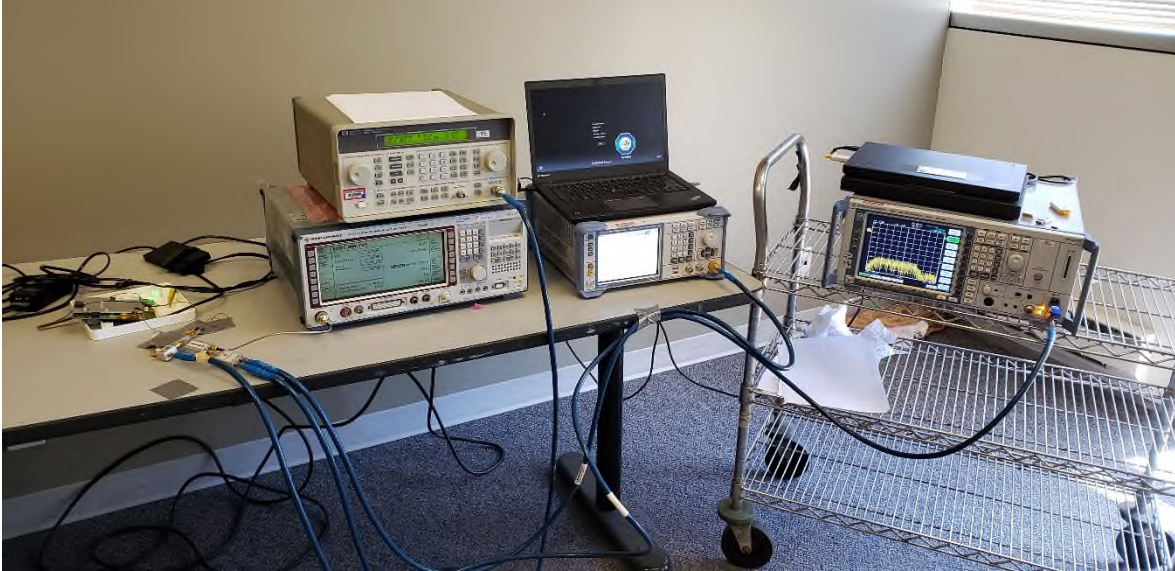

Frequency Stability

