

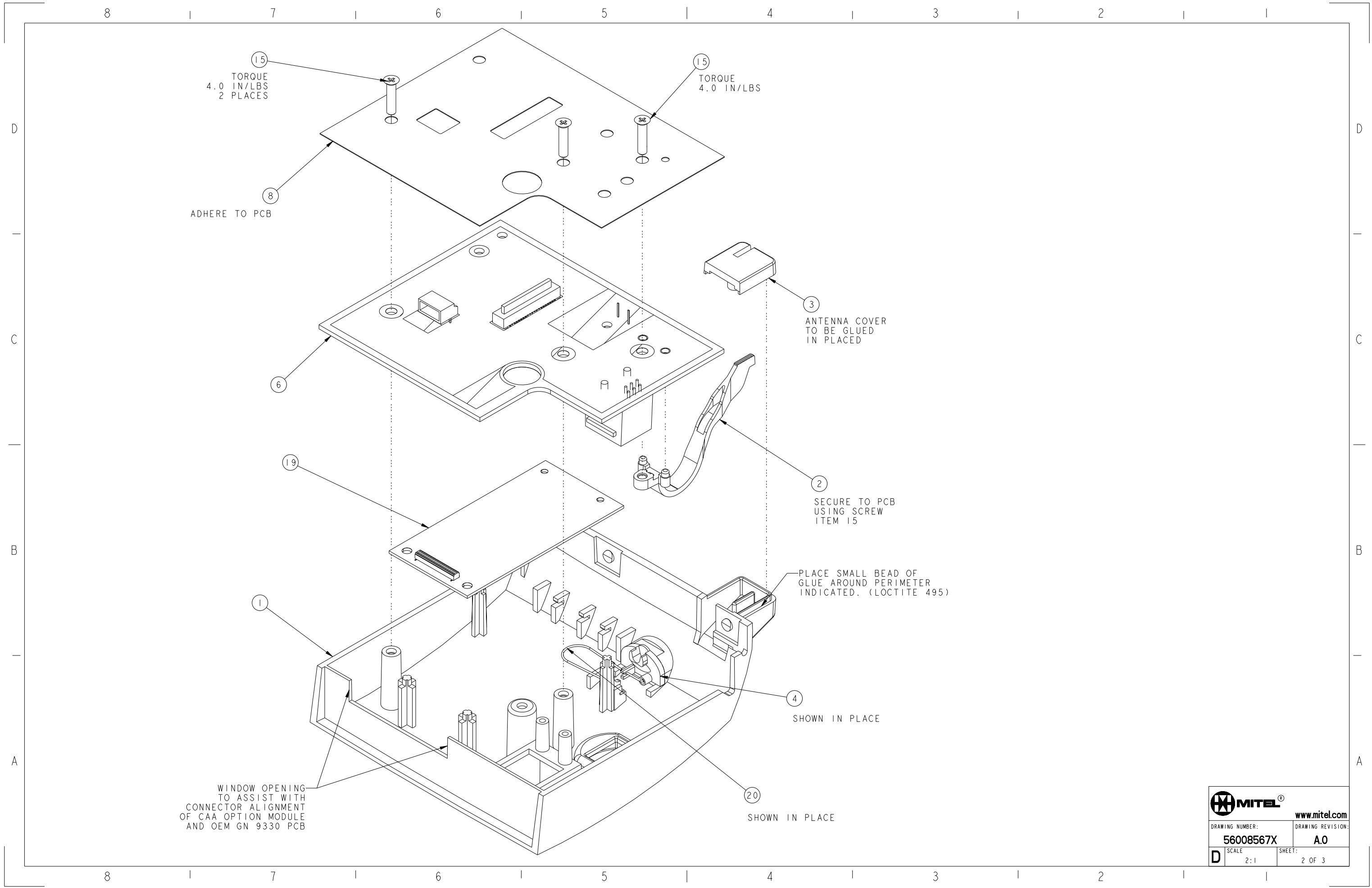

VARIANT TABLE			
PART NUMBER	REV	REFERENCE MODEL	DESCRIPTION
56008567A	A	56008567X	CORDLESS MODULE (NA)
56008567B	A	56008567X	CORDLESS MODULE (EU)
REASON FOR DRAWING UPDATE:			

NOTES:

1. DRAWING IS FOR ASSEMBLY REFERENCE. REFER TO BOM FOR PART NUMBERS AND QUANTITIES.
2. REFER TO BOM NOTES FOR PACKAGING REQUIREMENTS AND GENERAL INSTRUCTIONS.
2. ALL MATERIALS USED AND SUPPLIED IN ACCORDANCE WITH THIS SPECIFICATION SHALL COMPLY WITH DIRECTIVE 2002/95/EC OF THE EUROPEAN PARLIAMENT AND OF THE COUNCIL, ON THE RESTRICTION OF THE USE OF CERTAIN HAZARDOUS SUBSTANCES IN ELECTRICAL AND ELECTRONIC EQUIPMENT (ROHS DIRECTIVE).

ALL DIMENSIONS IN MILLIMETERS. UNLESS OTHERWISE NOTED, TOLERANCES	 MITEL [®] www.mitel.com		
x.x ± 0.4	CORDLESS MODULE		
x.xx ± 0.10			
ANGLES ± 1/2 DEG.	DRAWING NUMBER: 56008567X	DRAWING REVISION: A.0	
THIRD ANGLE PROJECTION	DRAWN BY: TIM MOMBOURQUETTE	DATE: 07-MAR-07	
DO NOT SCALE DRAWING	SCALE: D 2:1	SHEET: 1 OF 3	ECO: 17603
THESE DRAWINGS AND SPECIFICATIONS ARE THE PROPERTY OF MITEL NETWORKS AND SHALL NOT BE REPRODUCED, COPIED, OR USED AS THE BASIS FOR THE MANUFACTURE, OR SALE OF APPARATUS WITHOUT THE WRITTEN PERMISSION OF MITEL NETWORKS.			



 MITEL®		www.mitel.com
DRAWING NUMBER: 56008567X		DRAWING REVISION: A.0
D SCALE 2:1	SHEET: 2 OF 3	

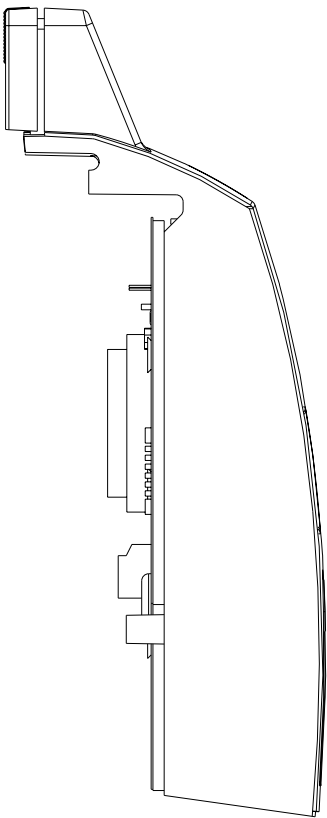
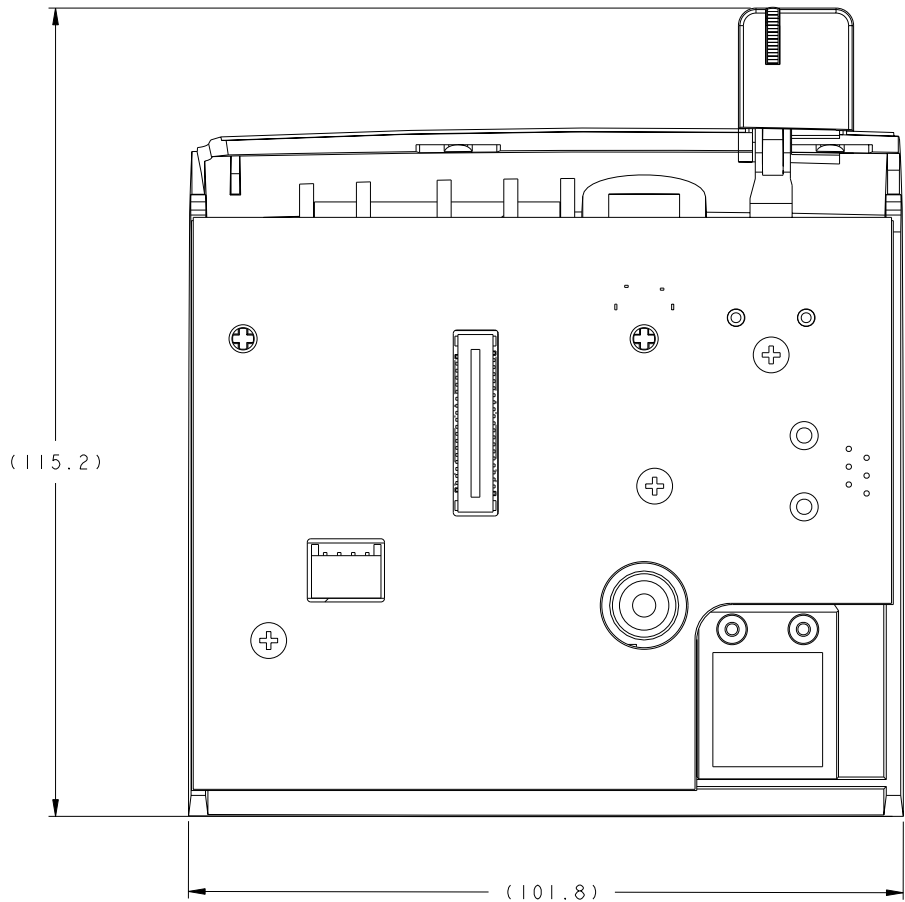
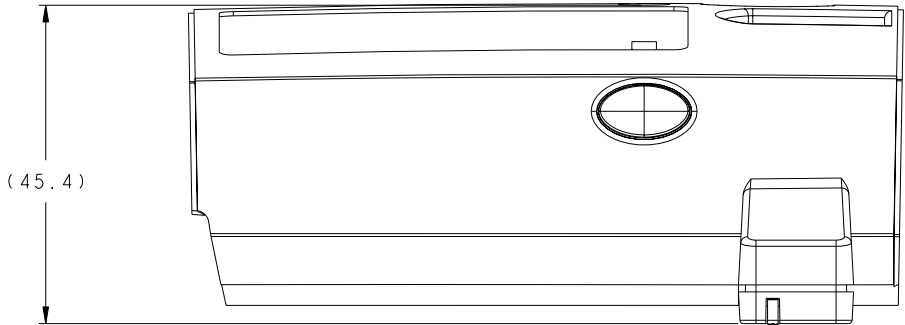
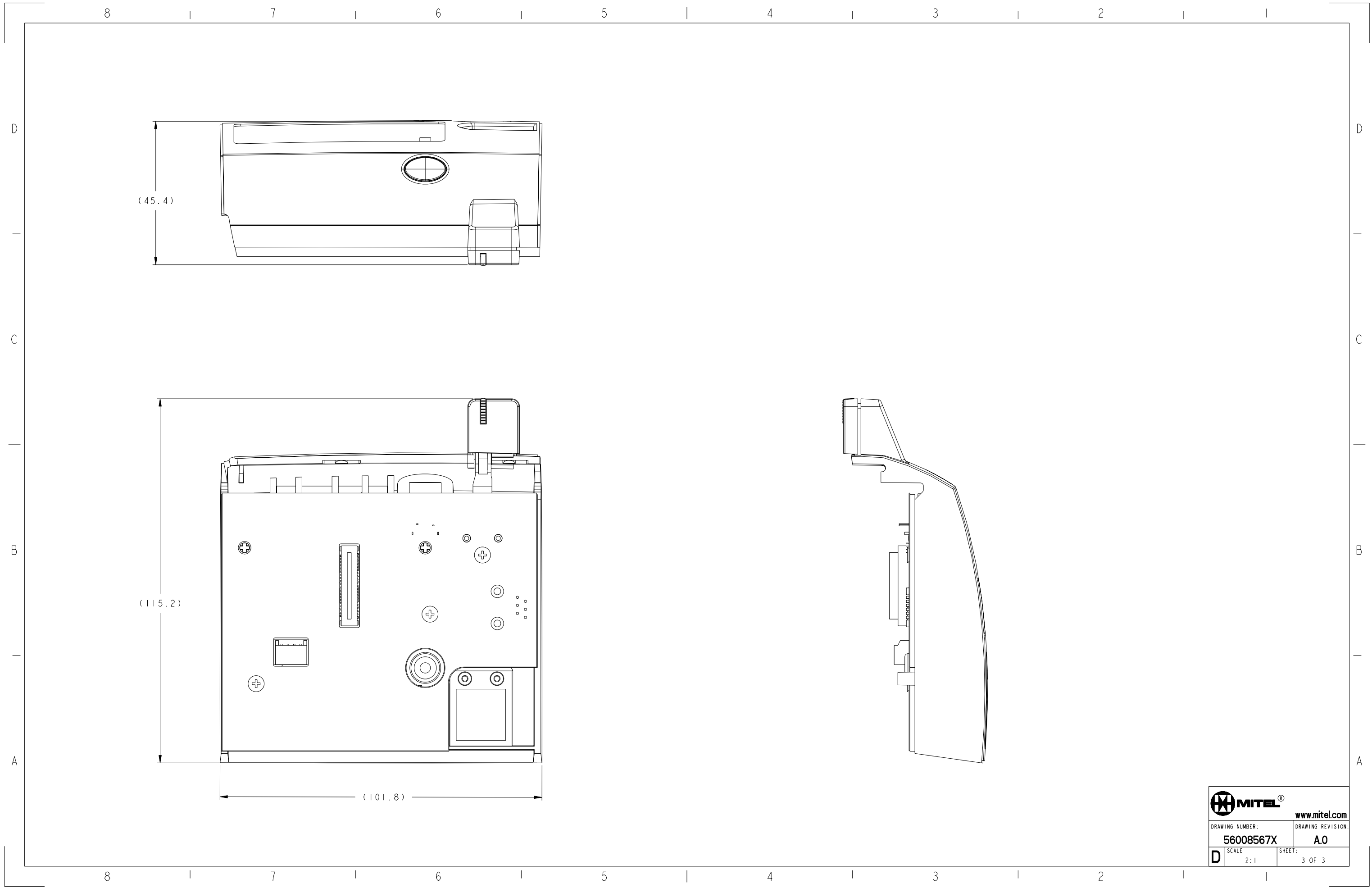

 MITEL®		www.mitel.com	
DRAWING NUMBER:		DRAWING REVISION:	
56008567X		A.0	
D	SCALE	SHEET:	
	2:1	3 OF 3	