



## Certification Report on

Specific Absorption Rate (SAR)  
Experimental Analysis

Intermec Technologies Corporation

6110 Hand-Held terminal

Test Date: 09 July, 2000



INTB-6110 Hand-Held Terminal-3445

51 Spectrum Way Nepean ON K2R 1E6  
Tel: (613) 820-2730 Fax: (613) 820-4161  
email: [info@aprel.com](mailto:info@aprel.com)

## CERTIFICATION REPORT

Subject: **Specific Absorption Rate (SAR) Experimental Analysis**

Product: Hand-Held Terminal with a Research in Motion R902M Radio Modem  
(Mobitex Network)

Model: 6110

Client: Intermec Technologies Corporation

Address: 550 Second Stree S.E.  
Cedar Rapids, IA 52401  
U.S.A.

Project #: INTB-6110 Hand-Held Terminal-3445

Prepared by: APREL Laboratories  
51 Spectrum Way  
Nepean, Ontario  
K2R 1E6



Tested by *Dr. Paul G. Cardinal* Date: *21 July 00*  
Dr. Paul G Cardinal

Submitted by *Dr. Paul G. Cardinal* Date: *21 July 00*  
Dr. Paul G. Cardinal  
Director, Laboratories

Approved by *Dr. Jacek J. Wojcik* Date: *July 21/2000*  
Dr. Jacek J. Wojcik, P. Eng.



FCC ID: EHAWANRIM902-6100  
Applicant: Intermec Technologies Corporation  
Equipment: Hand-Held Terminal  
Model: 6110 with a Research in Motion R902M radio modem  
Standard: FCC 96 –326, Guidelines for Evaluating the Environmental Effects of Radio-Frequency Radiation

## ENGINEERING SUMMARY

This report contains the results of the engineering evaluation performed on a Intermec Technologies Corporation model 6110 Hand-Held Terminal with a Research in Motion R902M Radio Modem (Mobitex Network). The measurements were carried out in accordance with FCC 96-326. The Hand-Held Terminal was evaluated at its maximum nominal power level of 2 W (33 dBm). The duty factor of the production devices will be controlled to be intrinsically restricted to 25% (see Appendix F).

The Hand-Held Terminal was tested at high, middle, and low frequencies on the keyboard, battery, antenna and left side. The maximum SAR was found to coincide with the peak performance RF output power of channel 0880 (high, 896 MHz) for the antenna side of the device. Test data and graphs are presented in this report.

Based on the test results it is certified that the product meets the requirements as set forth in the above specifications, for an uncontrolled RF exposure environment for extremities (hand).

The manual for this unit will require a warning to keep the antenna at least 21 mm away from any part of the body other than the extremities of either users or bystanders, and to warn the user against putting his hand on the antenna. Using the product in its Holster will satisfy these requirements for the user's body.

The results presented in this report relate only to the sample tested.



## TABLE OF CONTENTS

1. Introduction.....	4
2. Applicable Documents .....	4
3. Equipment Under Test .....	4
4. Test Equipment .....	5
5. Test Methodology .....	5
6. Test Results.....	6
6.1. Transmitter Characteristics .....	6
6.2. SAR Measurements.....	7
7. Analysis for Bystander.....	10
8. Conclusions .....	11
Appendix A.....	12
Appendix B.....	18
Appendix C .....	19
Appendix D.....	20
Appendix E.....	23
Appendix F.....	24



## 1. INTRODUCTION

Tests were conducted to determine the Specific Absorption Rate (SAR) of a sample of an Intermec Technologies Corporation model 6110 Hand-Held Terminal, which incorporates a Research in Motion R902M-2-0 radio modem. These tests were conducted at APREL Laboratories' facility located at 51 Spectrum Way, Nepean, Ontario, Canada. A view of the SAR measurement setup can be seen in Appendix A Figure 1. This report describes the results obtained.

## 2. APPLICABLE DOCUMENTS

The following documents are applicable to the work performed:

- 1) FCC 96-326, Guidelines for Evaluating the Environmental Effects of Radio-Frequency Radiation
- 2) ANSI/IEEE C95.1-1992, IEEE Standard for Safety Levels with Respect to Human Exposure to Radio Frequency Electromagnetic Fields, 3 kHz to 300 GHz.
- 3) ANSI/IEEE C95.3-1992, IEEE Recommended Practice for the Measurement of Potentially Hazardous Electromagnetic Fields – RF and Microwave.
- 4) OET Bulletin 65 (Edition 97-01) Supplement C (Edition 97-01), "Evaluating Compliance with FCC Guidelines for Human Exposure to Radio Frequency Electromagnetic Fields".

## 3. EQUIPMENT UNDER TEST

- Intermec Technologies Corporation 6110 Hand-Held Terminal with a Research in Motion R902M Radio Modem (Mobitex Network), ESN 031/11/003802, received on May 15, 2000.

The Hand-Held Terminal will be called DUT (Device Under Test) in the following.

Two antennas are available for this device: a  $\frac{1}{4} \lambda$  end fed stub antenna and a  $\frac{1}{2} \lambda$  end fed dipole whip antenna. The antennas are omni-directional. A photograph of the DUT,



carrying case and antennas can be found in Appendix B. See the manufacturer's submission documentation for drawings and more design details.

#### 4. TEST EQUIPMENT

- APREL Triangular Dosimetric Probe Model E-009, s/n 115, Asset # 301420
- CRS Robotics A255 articulated robot arm, s/n RA2750, Asset # 301335
- CRS Robotics C500 robotic system controller, s/n RC584, Asset # 301334
- R&S NRVS power meter, s/n 864268/017, Asset # 100851
- R&S NRV-Z7 power sensor, s/n 862 509/006, Asset # 100852
- APREL F-1, flat manikin, s/n 001
- Tissue Recipe and Calibration Requirements, APREL procedure SSI/DRB-TP-D01-033
- HP 8920A, 0.4 – 1000 MHz RF Communications Test Set, s/n 3344A03488, Asset # 301289
- APREL D-835S Dipole Antenna, s/n 101
- RIM Wireless Typetest Tool
- RIM 2181 DSP Card

#### 5. TEST METHODOLOGY

1. The test methodology utilised in the certification of the DUT complies with the requirements of FCC 96-326 and ANSI/IEEE C95.3-1992.
2. The E-field is measured with a small isotropic probe (output voltage proportional to  $E^2$ ).



3. The probe is moved precisely from one point to the next using the robot (10 mm increments for wide area scanning, 5 mm increments for zoom scanning, and 2.5 mm increments for the final depth profile measurement).
4. The probe travels in the homogeneous liquid simulating human tissue. Appendix D contains information about the recipe and properties of the simulated tissue used for these measurements.
5. The liquid is contained in a manikin simulating a portion of the human body.
6. The DUT is positioned in such a way that it touches the bottom of the phantom with its top, bottom, or sides.
7. All tests were performed with the highest power available from the sample DUT, under transmit conditions.

More detailed descriptions of the test method is given in Section 6 when appropriate.

## 6. TEST RESULTS

### 6.1. TRANSMITTER CHARACTERISTICS

The battery-powered DUT will consume energy from its batteries, which may affect the DUT's transmission characteristics. In order to gage this effect the output of the transmitter is sampled before and after each SAR run. In the case of this DUT, the conducted power was sampled. A power meter was connected to the output connector on the internal R902M radio modem. The following table shows the radiated RF power sampled before and after each of the six sets of data used for the worst case SAR in this report.



Scan		Conducted Power Readings (dBm)		D (dB)	Battery #
Type	Height (mm)	Before	After		
Area	2.5	12.62	12.65	+0.03	2
Area	12.5	12.53	12.69	+0.16	3
Zoom	2.5	12.67	-	-	4
Zoom	7.5	-	-	-	4
Zoom	12.5	-	12.67	+0.00	4
Depth	2.5 – 22.5	12.67	12.57	-0.10	5

## 6.2. SAR MEASUREMENTS

- 1) RF exposure is expressed as a Specific Absorption Rate (SAR). SAR is calculated from the E-field, measured in a grid of test points as shown in Appendix A Figure 2. SAR is expressed as RF power per kilogram of mass, averaged in 10 grams of tissue for the extremities and 1 gram of tissue elsewhere.
- 2) The DUT was put into test mode for the SAR measurements via communications software supplied by the radio modem manufacturer running on a PC to control the channel and the maximum operating power (nominally 33 dBm).
- 3) Figure 3 in Appendix A shows a contour plot of the SAR measurements for the DUT with its antenna side placed against the bottom of the phantom, using the  $\frac{1}{2} \lambda$  antenna and transmitting on the high channel (0880<sub>h</sub>, 901 MHz). The presented values were taken 2.5 mm into the simulated tissue from the flat phantom's solid inner surface. Figures 1 and 2 in Appendix A show the phantom used in the measurements. A grid is shown inside of the phantom indicating the orientation of the x-y grid used, with the co-ordinates (0,0) on the top left (orange dot). The y-axis is positive towards the right and the x-axis is positive towards the bottom.

A different presentation of the same data is shown in Appendix A Figure 4.





This is a surface plot, where the measured SAR values provide the vertical dimension, which is useful as a visualisation aid.

Similar data was obtained 12.5 mm into the simulated tissue. These measurements are presented as a contour plot in Appendix A Figure 5 and surface plot in Figure 6.

Figure 10 in Appendix A shows an overlay of the DUT’s outlines, superimposed onto a contour plot similar to that previously shown as Figure 3.

Figures 3 through 6 in Appendix A show that there is a dominant peak, in the contour plots, that diminishes in magnitude with depth into the tissue simulation.

- 4) Wide area scans were performed for the low channel (0480<sub>h</sub>, 896 MHz) with the DUT’s keyboard, battery, antenna and left side facing the tissue and both offered antennas. Wide area scans were also performed for the middle (0720<sub>h</sub>, 899 MHz) and high (0880<sub>h</sub>, 901 MHz) channels with the worst case antenna and side of the device facing the tissue. These scans were done at 25% duty factor. The peak single point SAR for the scans were:

DUT Orientation	Antenna S/L	Channel			Highest SAR	
		L/M/H	#	Frequency [MHz]	Value	Location
					[W/kg]	Handset / Antenna
Keyboard side	L	L	0480 <sub>h</sub>	896	2.02	A
Battery side	L	L	0480 <sub>h</sub>	896	0.25	H
Antenna side	L	L	0480 <sub>h</sub>	896	2.03	A
Other side	L	L	0480 <sub>h</sub>	896	0.10	H
Keyboard side	S	L	0480 <sub>h</sub>	896	0.59	H
Battery side	S	L	0480 <sub>h</sub>	896	0.12	H
Antenna side	L	M	0720 <sub>h</sub>	899	2.07	A
<b>Antenna side</b>	<b>L</b>	<b>H</b>	<b>0880<sub>h</sub></b>	<b>901</b>	<b>2.13</b>	<b>A</b>

Since SAR values exceeding the FCC guideline of 1.6 W/kg only occur on the antenna, the user’s hand (extremity) will not be exposed to exposure



levels that exceed the FCC guideline of 4 W/kg for uncontrolled exposure of extremities. Consequently, all subsequent testing was performed to explore the exposure of other parts of the body of the user or bystanders to the device. Further testing of the DUT was conducted with the long antenna and the antenna side of the DUT against the phantom, with the DUT operating with a 25% duty factor.

- 5) Wide area scans were also performed for the high channel (0880<sub>h</sub>, 901 MHz) versus separation. The peak single point SAR for the scans were:

Channel			Antenna axis to phantom's inner surface separation	Highest local SAR
	#	MHz		
			mm	W/kg
High	0880 <sub>h</sub>	901	17.5	2.14
			22.5	1.29
			27.5	0.66
			32.5	0.47
<b>DUT in Holster</b>				
High	0880 <sub>h</sub>	901	27.25	0.79

Figure 12 in Appendix A shows the data plotted as a function of separation and the exponential curve fit to them.

- 6) The high channel (0880<sub>h</sub>, 901 MHz) SAR peak was then explored on a refined 5 mm grid in three dimensions. Figures 7, 8, and 9 show the measurements made at 2.5, 7.5 and 12.5 mm respectively. The SAR value averaged over 1 gram was determined from these measurements by averaging the 27 points (3x3x3) comprising a 1 cm cube. The maximum SAR value measured averaged over 1 gram was determined from these measurements to be 1.328 W/kg.
- 7) To extrapolate the maximum SAR value averaged over 1 gram to the inner surface of the phantom a series of measurements were made at a few (x,y) coordinates within the refined grid as a function of depth, with 2.5 mm spacing. Figure 11 in Appendix A shows the data gathered and the exponential curves



fit to them. The average exponential coefficient was determined to be  $(-0.0738 \pm 0.0008) / \text{mm}$ .

The distance from the probe tip to the inner surface of the phantom for the lowest point is 2.5 mm. The distance from the probe tip to the tip of the measuring dipole within the APREL Triangular Dosimetric Probe Model E-009 is 2.3 mm. The total extrapolation distance is 4.8 mm, the sum of these two.

Applying the exponential coefficient over the 4.8 mm to the maximum SAR value averaged over 1 gram that was determined previously, we obtain **the maximum SAR value at the surface averaged over 1 gram** of 1.893 W/kg.

## 7. ANALYSIS FOR BYSTANDER

The measurements of highest local SAR versus separation of the antenna housing from the bottom of the phantom (Section 6.2.5) will enable the maximum 1 gram SAR for a separation of 15 mm (previous section) to be interpolated for other separations.

If the data for Figure 12 is fitted to an exponential equation we get:

$$\text{Peak Local SAR} = 12.947 e^{-0.104 * (\text{separation})}$$

A similar equation will exist for the maximum 1 g SAR versus separation:

$$\text{Maximum 1 g SAR} = k e^{-0.104 * (\text{separation})}$$

Using this equation with the previous section's data:

Maximum 1 g SAR at the surface = 1.893 W/kg  
Tissue – antenna housing separation = 17.5 mm,

results in a  $k = 11.688 \text{ W/kg}$ , which corresponds to the maximum 1 g SAR when the separation is 0 mm. A conservative maximum 1 g SAR of 1.42 W/kg (1.6 W/kg reduced by our measurement uncertainty) would occur for a separation of 20.27 mm.



## 8. CONCLUSIONS

The maximum Specific Absorption Rate (SAR) averaged over 1 gram, determined at 901 MHz (high channel, # 0880), of a Intermec Technologies Corporation model 6110 Hand-Held Terminal with a Research in Motion R902M Radio Modem (Mobitex Network), is 1.893 W/kg. The overall margin of uncertainty for this measurement is  $\pm 11.4\%$  (Appendix C). The SAR limit given in the FCC 96-326 safety guideline is 1.6 W/kg.

The location of this maximum 1 gram SAR is over the antenna. Consequently a user's extremities will be exposed to much lower levels of SAR than this, i.e. below the FCC 96-326 safety guideline of 4 W/kg for uncontrolled exposure of extremities. However, to prevent a bystander (or user) from exposing a part of the body other than the extremities to levels above the SAR limit given in the FCC 96-326 safety guideline of 1.6 W/kg a minimum separation distance of 20.27 mm will be required between the bystander and the antenna (or parts of the user other than the extremities). Using the Hand-Held Terminal in its Holster will satisfy these requirements for the user's body.

Considering the above, this unit as tested, and as it will be marketed and used (with a warning in the manual to keep bystanders at least 20.27 mm from the central portion of the antenna) is found to be compliant with this requirement.



## APPENDIX A

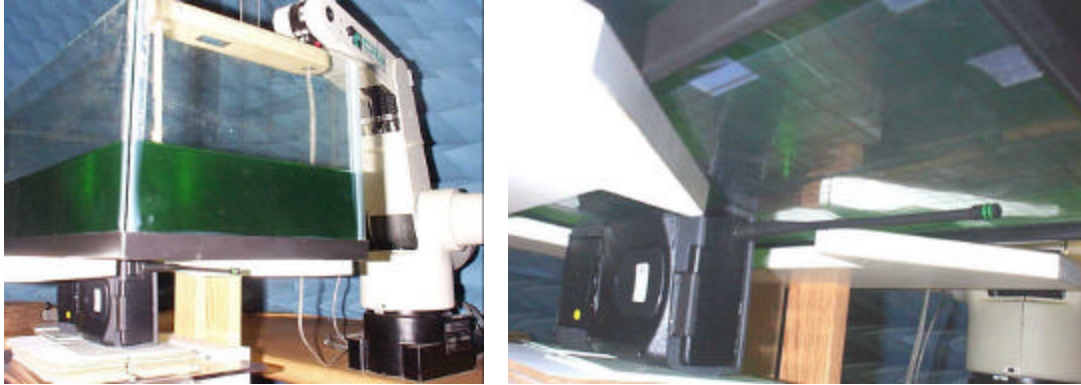

Figure 1



Figure 2



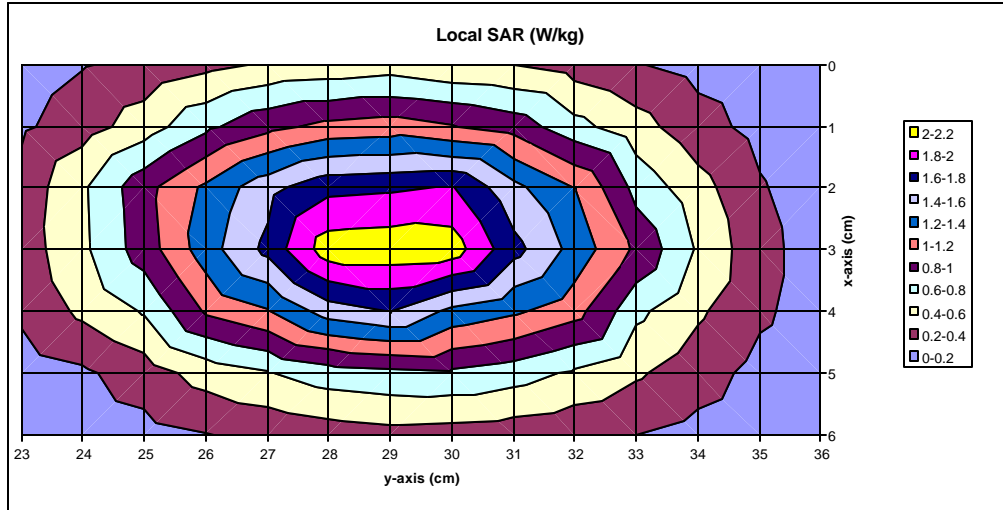

Figure 3. Area Scan 2.5mm Above Surface

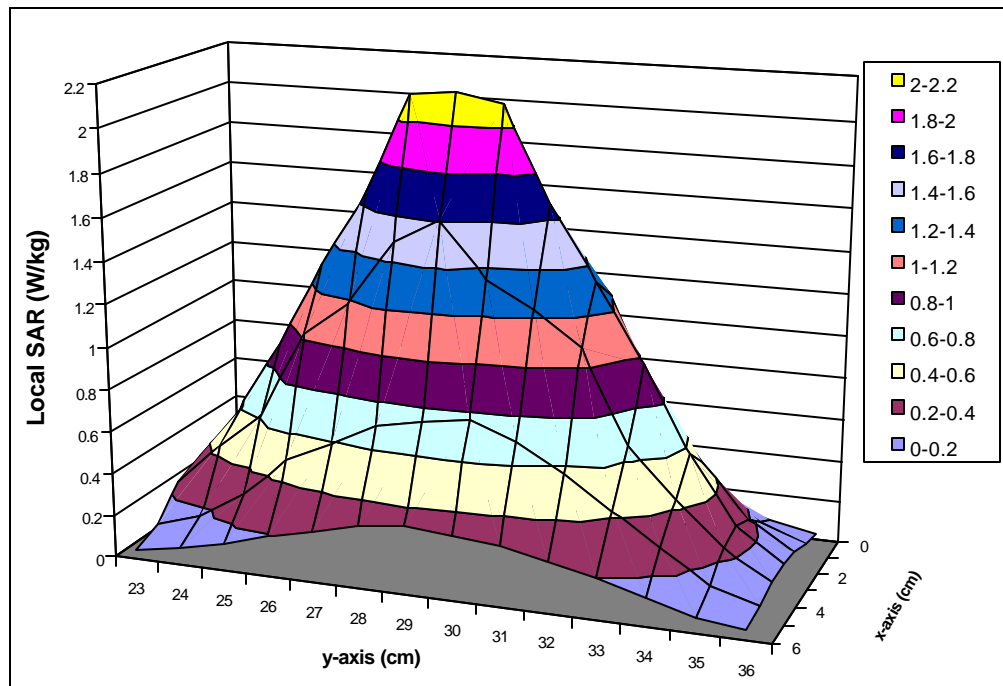

Figure 4. Area Scan 2.5mm Above Surface



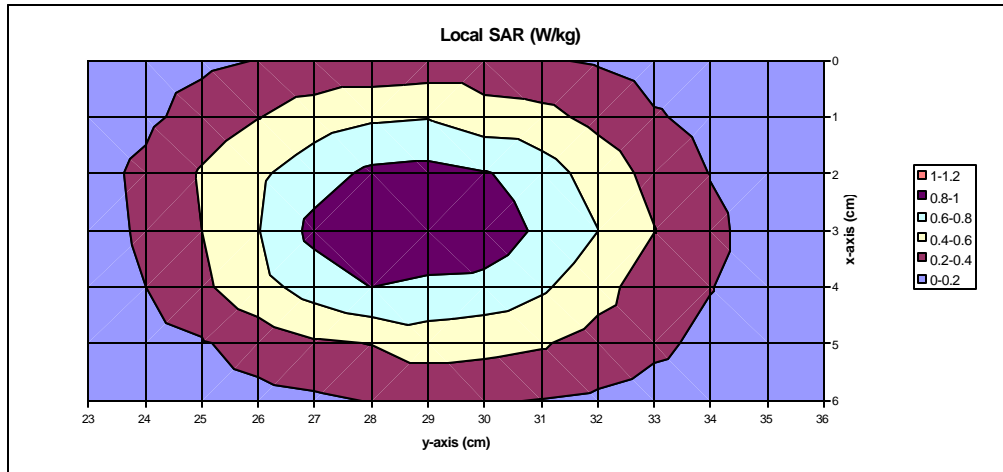

Figure 5. Area Scan 12.5mm Above Surface

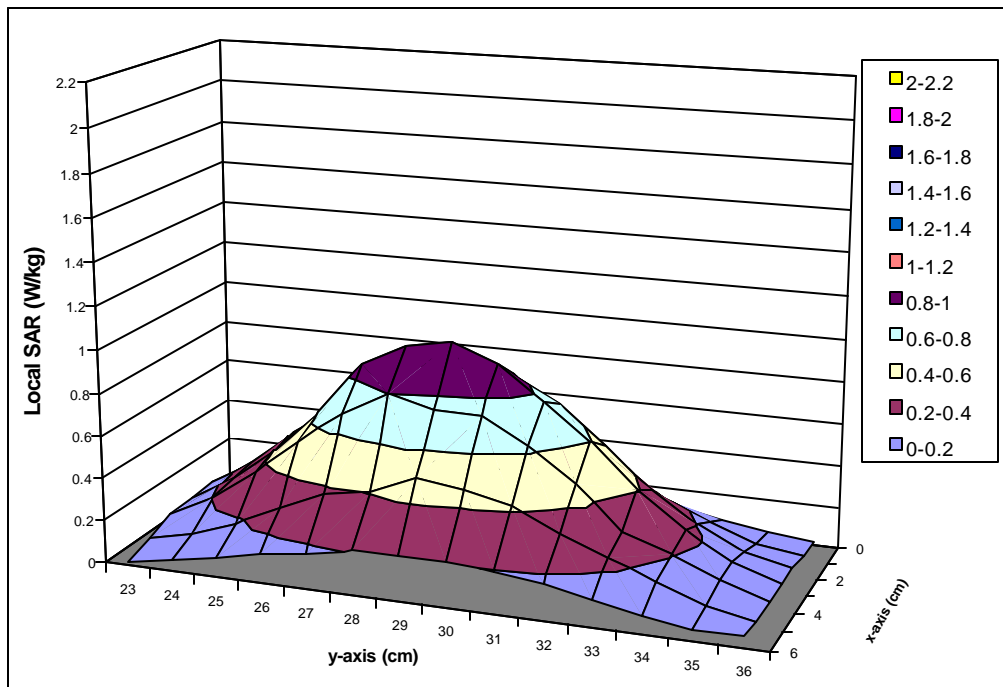

Figure 6. Area Scan 12.5mm Above Surface



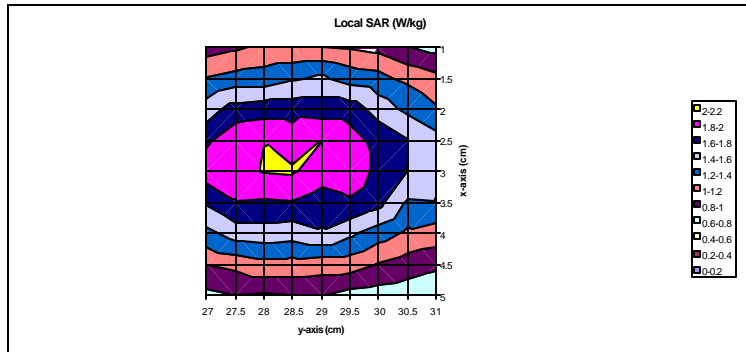

Figure 7. Zoom Scan 2.5mm Above Surface

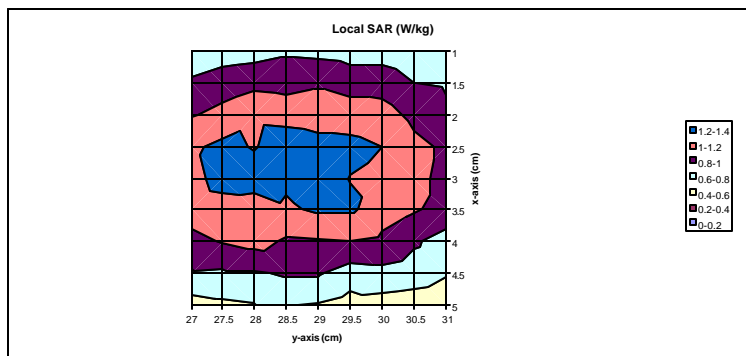

Figure 8. Zoom Scan 7.5mm Above Surface

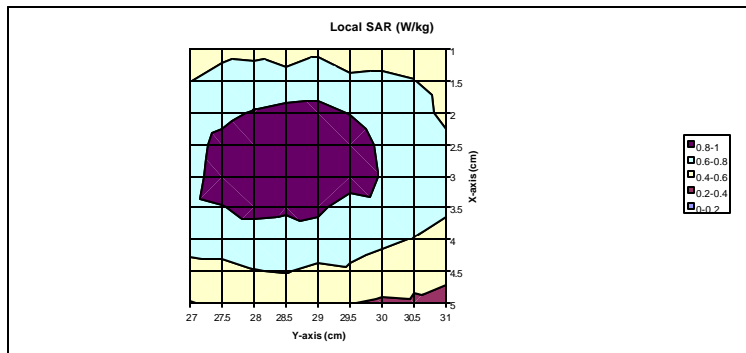

Figure 9. Zoom Scan 12.5mm Above Surface





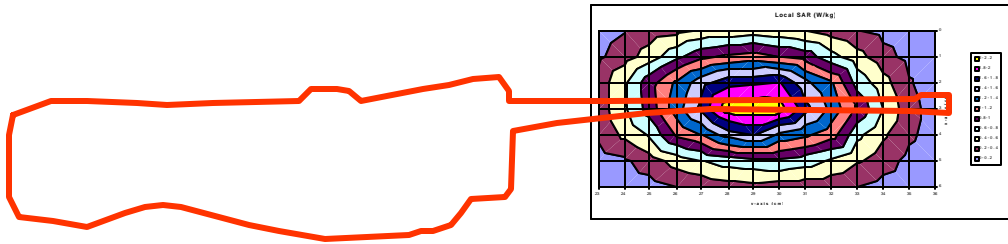

Figure 10

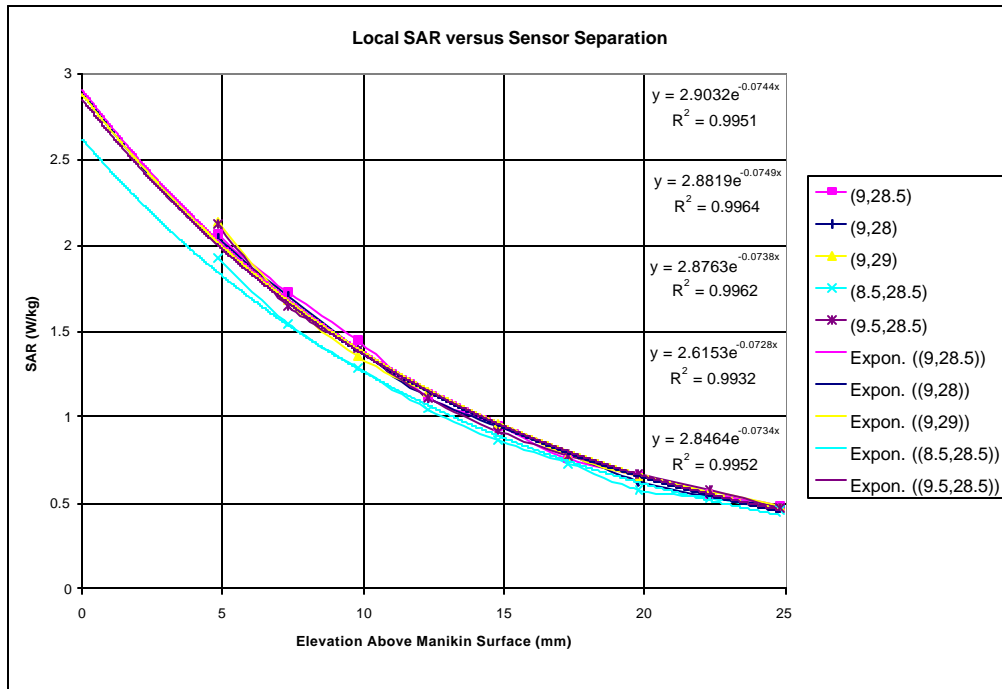

Figure 11



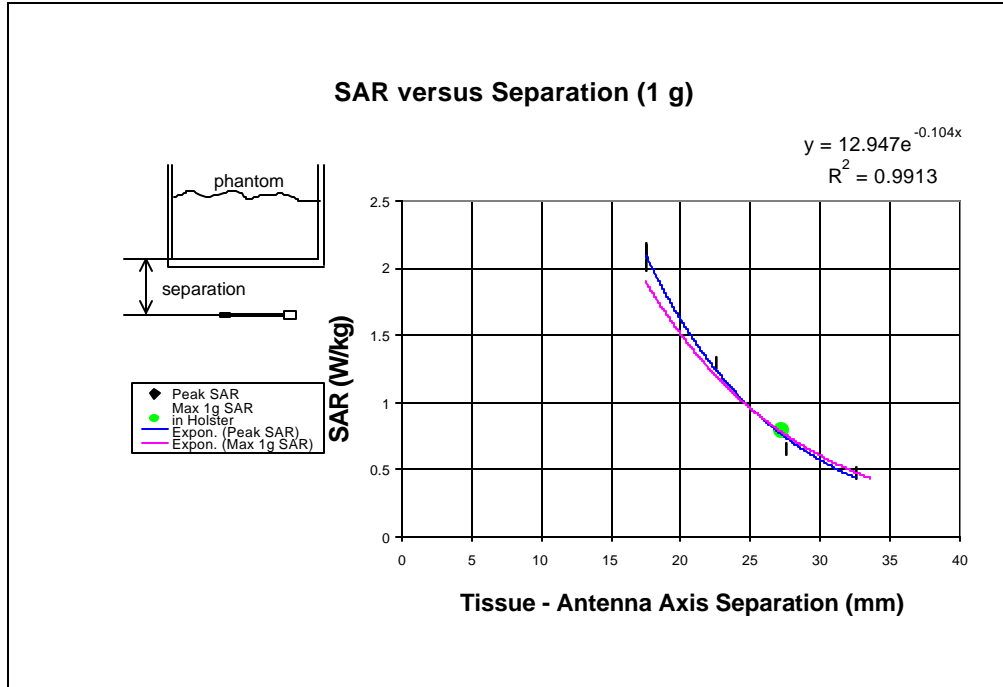

Figure 12



## APPENDIX B

### Manufacturer's Antenna Specifications



Scanner



Scanner in Holster



Antennas Offered

	SHORT ANTENNA	LONG ANTENNA
<b>Manufacturer</b>	Mobile Mark	Centurion
<b>Mfg Part #</b>	PSTN2-899CI	CAF28766
<b>Intermec Part #</b>	805-572-002	805-490-004
<b>Description</b>	¼ λ end fed omni directional antenna	½ λ end fed omni directional whip dipole
<b>Gain</b>	-1.2 dBd	-2.5 dBd
<b>VSWR</b>	2.0-2.5:1	1.5:1
<b>Connector</b>	SMA	SMA
<b>Length</b>	3.5" / 9 cm	7" / 17.8 cm

(See manufacturer's submission documentation for drawings and more design details)



## APPENDIX C

### Uncertainty Budget

<b>Uncertainties Contributing to the Overall Uncertainty</b>		
<b>Type of Uncertainty</b>	<b>Specific to</b>	<b>Uncertainty</b>
Power variation due to battery condition	phone	1.2%
Extrapolation due to curve fit of SAR vs depth	phone	2.2%
Extrapolation due to depth measurement	setup	3.6%
Conductivity	setup	6.0%
Density	setup	2.6%
Tissue enhancement factor	setup	7.0%
Voltage measurement	setup	2.4%
Probe sensitivity factor	setup	3.5%
		<b>11.4% RSS</b>



## APPENDIX D

### Simulated Tissue Material and Calibration Technique

The mixture used was based on that presented SSI/DRB-TP-D01-033, “Tissue Recipe and Calibration Requirements”.

De-ionised water	52.8 %
Sugar	45.3 %
Salt	1.5 %
HEC	0.3 %
Bactericide	0.1 %

Mass density,  $\rho$  1.30 g/ml  
 (The density used to determine SAR from the measurements was the recommended 1040 kg/m<sup>3</sup> found in Appendix C of Supplement C to OET Bulletin 65, Edition 97-01)

Dielectric parameters of the simulated tissue material were determined using a Hewlett Packard 8510 Network Analyser, a Hewlett Packard 809B Slotted Line Carriage, and an APREL SLP-001 Slotted Line Probe.

The dielectric properties are:

@ 899 MHz	APREL	OET 65 Supplement	$\Delta$ / % (OET)
Dielectric constant, $\epsilon_r$	57.2	55.96	+2.2%
Conductivity, $\sigma$ / [S/m]	1.14	0.969	+17.1%
Tissue Conversion Factor, $\gamma$	9.6	-	-



SIMULATION FLUID # 981126-M  
 CALIBRATION DATE 26-May-00  
 CALIBRATED BY Della Zapata  
 Frequency Range 100MHz-1GHz  
 Frequency Calibrated 899 MHz  
 Tissue Type Muscle

Position [cm]	Amplitude		Phase	
	[dBm]	[deg]	[deg]	[deg]
0	-41.893	163.2	163.2	163.2
0.5	-43.293	121.11	121.11	121.11
1	-44.443	81.551	81.551	81.551
1.5	-45.617	41.033	41.033	41.033
2	-46.803	2.292	2.292	2.292
2.5	-48.199	-38.559	-38.559	-38.559
3	-49.568	-77.711	-77.711	-77.711
3.5	-50.736	-120.22	-120.22	-120.22
4	-51.861	-161.11	-161.11	-161.11
4.5	-52.951	-159.53	-159.53	-200.47
5	-54.133	119.07	-240.93	
5.5	-55.504	79.812	-280.188	
6	-56.223	37.168	-322.832	
$\Delta$ dB <sub>1</sub>	-7.675	$\Delta$ deg <sub>1</sub>	-240.911	
$\Delta$ dB <sub>2</sub>	-7.443	$\Delta$ deg <sub>2</sub>	-241.33	
$\Delta$ dB <sub>3</sub>	-7.418	$\Delta$ deg <sub>3</sub>	-242.661	
$\Delta$ dB <sub>4</sub>	-7.334	$\Delta$ deg <sub>4</sub>	-241.503	
$\Delta$ dB <sub>5</sub>	-7.33	$\Delta$ deg <sub>5</sub>	-243.222	
$\Delta$ dB <sub>6</sub>	-7.305	$\Delta$ deg <sub>6</sub>	-241.629	
$\Delta$ dB <sub>7</sub>	-6.655	$\Delta$ deg <sub>7</sub>	-245.121	
$\Delta$ dB <sub>avg</sub> [dB]	-7.31	Ddeg <sub>avg</sub> [deg]	-242.3395714	
$d\beta_{avg}(\alpha_{avg})$ [dB/cm]	-2.44	$d\beta_{avg}(\beta_{avg})$ [deg/cm]	-80.77985714	
$(\epsilon_{avg})$ [Np/cm]	-0.280476794	$(\theta_{avg})$ [rad/cm]	-1.403874476	
$f$ [Hz]	8.99E+08			
$\mu$ [H/cm]	1.25664E-08			
$\epsilon_r$ [F/cm]	8.854E-14			
$\epsilon_r$	538		-3.9%	
$\epsilon_{r\text{effective}}$	1.11	S/m	15.0%	

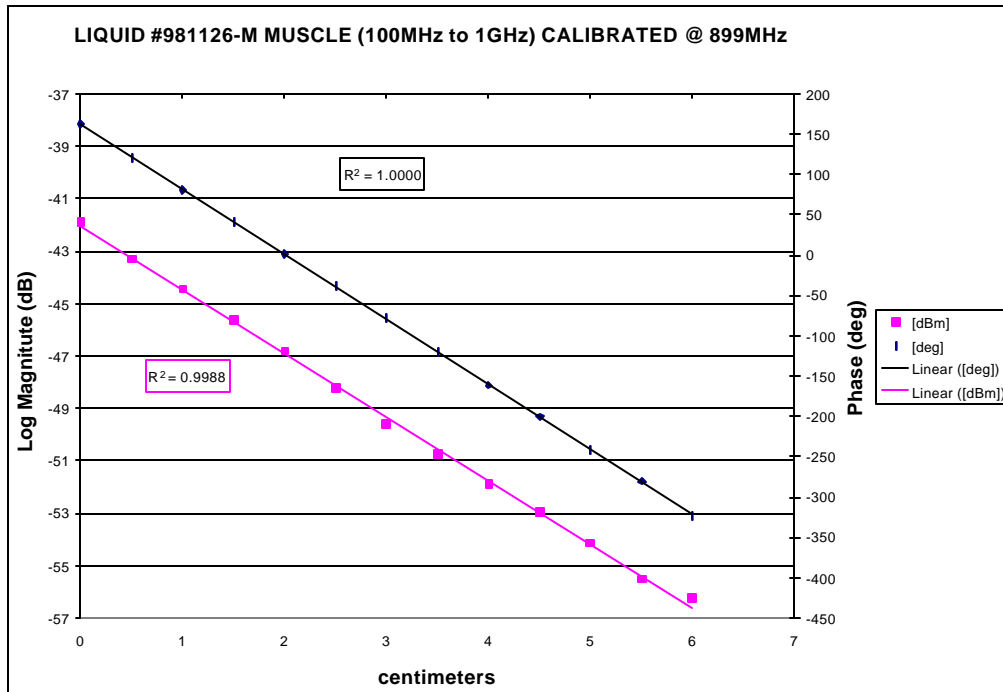

89 MHz Data (Tony & Hake) MUSCLE with E115

RF Power	Ch0	Ch1	Ch2	delta T	Sum	Thermal		
W	dBm	R&S	uV	uV	uV	SAR		
0072611	1861	-2674	317	708	1831	00003	11735	0.31
0090991	1858	-2576	342	880	2246	00028	14045	0.26
0115345	2032	-2473	391	1001	2808	00094	17259	0.31
0143548	2157	-2378	439	1221	3418	0006	23667	0.56
0179887	2258	-228	513	1465	4224	0007	25487	0.66
0224805	2362	-2183	610	1807	5225	00098	31404	0.89
0263992	2453	-2082	732	2222	6421	00122	36526	1.13
0303183	2548	-1987	854	2710	7861	0015	4365	1.39
042388	2646	-1888	1025	3345	9717	00184	57889	1.70
0549277	2738	-1796	1221	4077	11719	0022	69928	2.08
067642	2831	-1704	1489	5005	14233	00278	85172	2.54
083752	2922	-1612	1782	6079	17114	00334	10263	3.09
109528	3016	-1518	2173	7422	20805	0042	12408	3.89
1264733	3102	-1433	2612	8936	24380	00503	14767	4.71
1538155	3187	-1348	3149	10833	28711	00614	17485	5.71

Directional Coupler factor 2535 dB (Asset 100251 cal file data (Janusz, 21 Jul 96))  
 Additional in line attenuation 20 dB

Sensitivity (e) 1619 1633 1619 - Sensor Sensitivity in mV/(mW/cm<sup>2</sup>) 89MHz cal (HW, 2 Jul 99)  
 n=1.50 e 24285 24485 24285

Density 1.3 gm<sup>3</sup> 1300 kg/m<sup>3</sup> - March, summer 97  
 Conductivity 11.7 mS/m 1.17 S/m - Hake 19 Apr 99  
 Heat Capacity (c) 2775 J/Cg 2775 J/Cg - average of Batzoni (27) and Kuster (285) values  
 Exposure Time 30 seconds 30 seconds  
 Slope of Measure Voltage (m) 11257 uV/W 00113 V/W  
 -standard error m<sub>y</sub> 1262 uV/W 00001 V/W 1.1%  
 Slope of Measure Temp Change (m) 00402 C/W 00402 C/W  
 -standard error m<sub>y</sub> 00003 C/W 00003 C/W 0.9%

Tissue Conversion Factor (g) 96

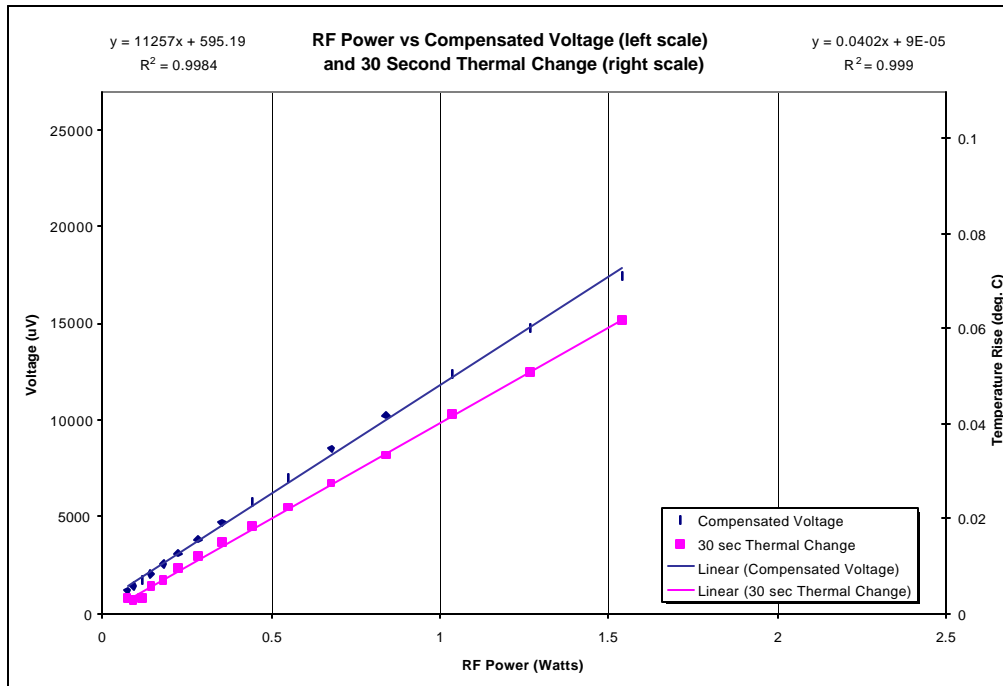

## APPENDIX E

### Validation Scans

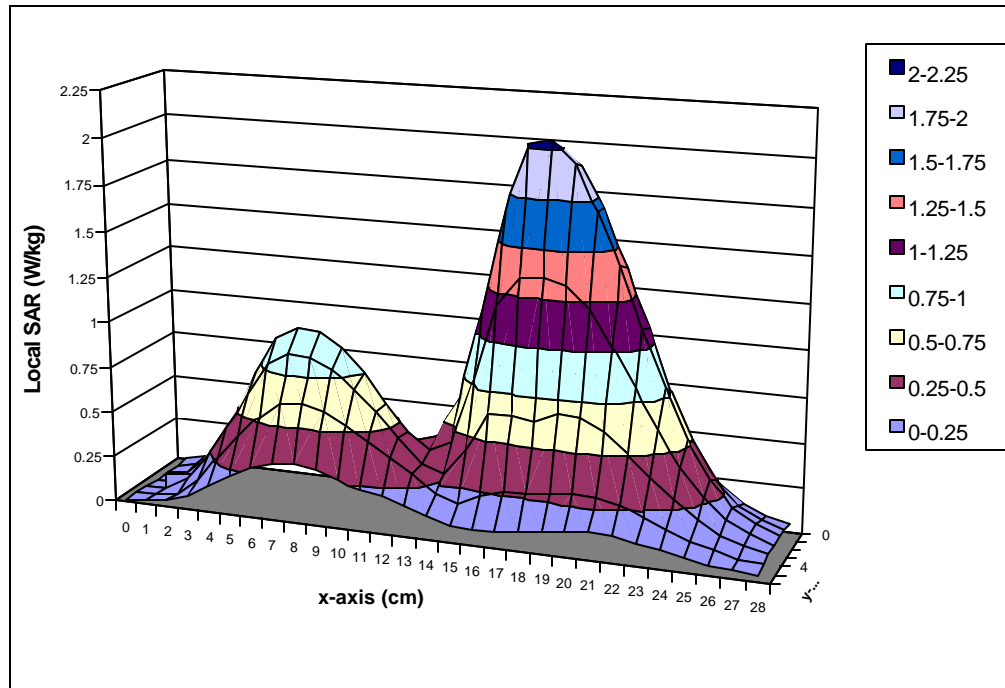
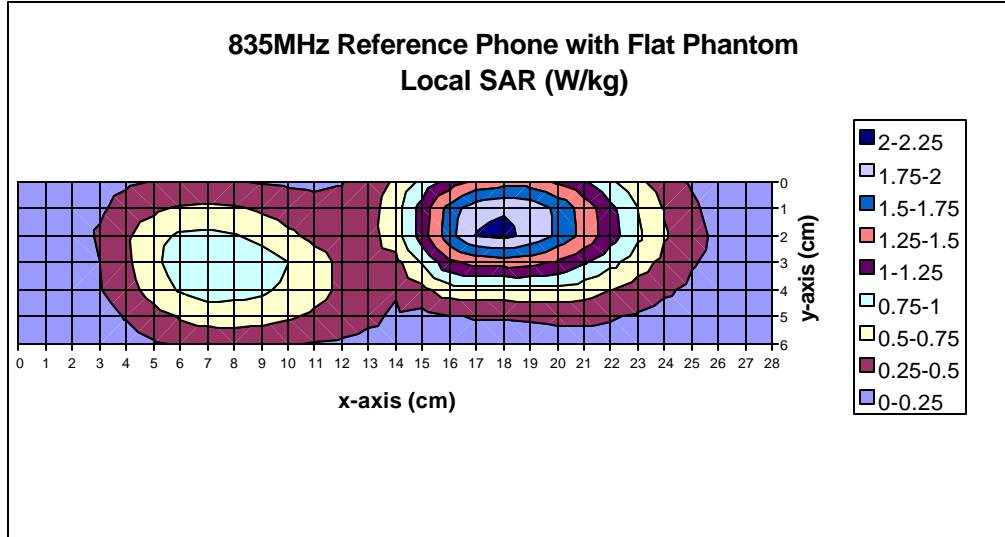



## APPENDIX F

### Duty Factor Limiting Algorithm for the OEM Radio Module R902M-2-O

The duty factor limiting algorithm for the OEM radio module R902M-2-O is a firmware algorithm that directly inhibits the radio firmware that generates transmit pulses. This algorithm will be permanently integrated with the radio firmware and installed at time of manufacture in the production facility. The algorithm cannot be modified or disabled by the user.

The radio module operates on a packet data network. The network controls the timing of most aspects of the radio signalling protocol. The shortest transmit event over which the mobile device has timing control is an entire uplink (transmit) transaction which is a series of transmit pulses. From the perspective of the mobile device this is an “atomic” event, i.e. the network controls the timing of the signalling within the transaction and the transaction can not be broken into smaller independent sub-parts.

Research in Motion Ltd. has implemented and tested a duty factor limiting algorithm for the radio module to comply with the requirement for limiting the duty factor at all times. To limit the duty factor at all times the algorithm controls the timing of when uplink (transmit) transactions are initiated. When an uplink (transmit) transaction occurs the algorithm accrues the actual transmit time. The algorithm ensures that the idle (transmitter off) time is sufficient to ensure the duty factor is less than the limit (25%) before the next uplink (transmit) transaction is initiated. This ensures that the duty factor is limited to the maximum allowable over all times.



---

# Spectrum Sciences Institute RF Dosimetry Research Board

---



Attention: all comments, suggestions, and inquiries should be addressed to  
Dr. Jack J. Wojcik or Dr. Paul G. Cardinal  
51 Spectrum Way, Nepean, Ontario, K2R 1E6, Canada. tel.:(613)820-2730, fax:(613)820-4161  
e-mail: [inform@spectrum-sciences.org](mailto:inform@spectrum-sciences.org)

## Phantom Design Requirements SSI/DRB-TP-D01-031



## PART of SAR Measurements Requirements SSI/DRB-TP-D01-030

**DRAFT**

*Prepared jointly with:*

**APREL**  
*Laboratories*

**Near Field Measurements Laboratory**

March 1998

- NOTICE -

This draft was prepared to assist the Dosimetry Research Board of SPECTRUM SCIENCES INSTITUTE and specifically the Working Group on SAR Measurements. It is submitted as a basis for discussion only, and is not binding on APREL Inc. Subsequent study may lead to revisions of the document, both in numerical values and/or form, and after continuing study and analysis, APREL Inc. specifically reserves the right to add to, or amend the content of this contribution.



## TABLE OF CONTENTS

<b>1.0</b>	<b>Introduction</b>	<b>3</b>
<b>1.1</b>	<b>Purpose And Scope Of The Standard</b>	<b>3</b>
<b>1.2</b>	<b>Test Facilities</b>	<b>3</b>
<b>1.3</b>	<b>Test Personnel</b>	<b>3</b>
<b>1.4</b>	<b>Standard Environmental Conditions</b>	<b>3</b>
<b>2.0</b>	<b>Background</b>	<b>4</b>
<b>3.0</b>	<b>References</b>	<b>5</b>
<b>4.0</b>	<b>Definitions</b>	<b>6</b>
<b>5.0</b>	<b>Phantoms</b>	<b>6</b>
<b>5.1</b>	<b>Universal Head-Arm (Unihead) Phantom</b>	<b>6</b>
<b>5.1.1</b>	<b>Head Simulator</b>	<b>6</b>
<b>5.1.2</b>	<b>Arm And Hand Simulator</b>	<b>10</b>
<b>5.1.3</b>	<b>Materials</b>	<b>10</b>
<b>5.2</b>	<b>Flat Phantom</b>	<b>13</b>
<b>5.3</b>	<b>Insulated Flat Phantom</b>	<b>13</b>
<b>6.0</b>	<b>Sar Laboratory Setup</b>	<b>13</b>
<b>7.0</b>	<b>Test configurations using the Uni-Head</b>	<b>15</b>



## 1.0 INTRODUCTION

### 1.1 Purpose and Scope of the Standard

The purpose of this document is to standardize the phantom(s) required for Specific Absorption Rate (SAR) testing associated with SAR measuring systems. This document defines the parts and dimensions of the phantom, in accordance with industry standards and practices.

This Standard defines:

- the methodology and procedures used to define a reproducible representation of the human head, hand and arm
- the dimensions on the canonical shapes used, and the materials required
- the hardware required and the proper setup

This Standard is part of a Certification Program Methodology as described in a separate document entitled "SSI/DBR TP-D01-030, Specific Absorption Rate (SAR) Standard For Portable Telecommunications Devices, March 1998". SSI/DBR TP-D01-031 contains specific criteria that must be met for SAR certification.

### 1.2 Test Facilities

All calibration work as described in this Standard shall be performed at an ISO/IEC Guide 25 accredited laboratory.

### 1.3 Test Personnel

Personnel performing the calibration will be experienced in relevant measurements (e.g. physical properties or RF characteristics) and supervised by a person proficient in SAR measurements.

### 1.4 Standard Environmental Conditions

All measurements and calibration should be performed under normal laboratory conditions for physical properties and electrical characteristics as stipulated by ISO/IEC Guide 25. The nominal temperature for physical property measurements and for electrical characterization are 20°C and 23°C, respectively.



## 2.0 BACKGROUND

Portable communication devices used by consumers typically operate over the range of several watts to a milliwatt, or less, using either analog or digital modulation techniques. Most portable telephones have antennas that radiate within a few centimeters of the user's head. The field strength and field distribution near the antenna are highly dependent on the location, orientation and electromagnetic characteristics of adjacent objects. The head and hand are normally in the reactive near-field region of the antenna where the electromagnetic field is non-propagating. The energy absorbed in the head and hand is mainly due to electric fields induced by the magnetic fields generated by currents flowing through the feedpoint, along the antenna and body of the portable device. The RF energy is scattered and attenuated as it propagates through the tissues of the head, and maximum energy absorption is expected in the more absorptive high water-content tissues near the surface of the head or hand. To account for near-field effects portable devices are evaluated with realistic head models called a phantom.

A phantom is a device that simulates the size, contours, and electrical characteristics of human tissue at normal body temperature. It is composed of a manikin (solid shell) and a tissue-equivalent synthetic material solution (see SSI/DRB-TP-D01-033).

The solid manikin shell is made of a dielectric material, which is transparent to RF energy (i.e. has very low RF absorption), and is as thin as possible while maintaining the strength necessary to hold the mass of simulated tissue.

Current phantoms in use are:

- Universal Head-arm (UniHead) Phantom for ear independent evaluation of the RF exposure in the head of users by telephone-type devices, as well as RF exposure in the head of users of hand held radios positioned in front of the face, and in the hand of users of hand held portable devices
- Flat Phantom for evaluating the RF exposure of other parts of the user body by wireless devices that are not normally used in the vicinity of the head and cannot be accommodated by the UniHead, as well as for experimental investigations. (Such devices would include wireless LAN PCMCIA cards installed in laptop personal computers)
- Insulated Flat Phantom used for the determination of the enhancement factor of synthetic tissue in the calibration of the miniature isotropic electric field (E-field) probes



### 3.0 REFERENCES

- Considerations for Human Exposure to EMFs from Mobile Telecommunication Equipment (MTE) in the frequency range 30 MHz – 6GHz, 1997, CENELEC European Committee for Electrotechnical Standardization, Secretariat SC211/B, WGMTE.
- "Numerical and Experimental Near Field Evaluation of a DCS 1800 Mobile Phone", A.Bahr, R.Kastle, S.G.Pan, T.Schmid, T.Becks, and N.Kuster, 1997, part of: "Suggestions Prepared Following the CENELEC Document", N. Kuster et al, Attachment 9, Minutes IEEE Standards Coordinating Committee –34, Subcommittee – 2, May 2, 1997 meeting.
- "Electromagnetic Energy Exposure of Simulated Users of Portable Cellular Telephones", Q. Balzano, O. Garay, T.J. Manning, Jr, 1995, IEEE Transactions on Vehicular Technology, 44:390-403.
- "EM Absorption in the Human Head and Neck for Mobile Telephones at 835 and 1900MHz", O. Gandhi, G. Lazzi, and C. Furse, 1996, IEEE Transactions on Microwave Theory and Techniques, 44:1884-1897.
- "The Dependence of EM Energy Absorption Upon Human Head Modeling at 900 MHz.", V.Hombach, K.Meier, M.Burkhardt, E.Kuhn, and N.Kuster, 1996, IEEE Transactions on Microwave Theory and Techniques, 44:1865 – 1873.
- "Dosimetric Evaluation of Handheld Mobile Communications Equipment with Known Precision", N.Kuster, R.Kastle, and T.Schmid, 1997, IEICE Transactions. E80-A:1 – 8.
- "Soft and Dry Phantom Modeling Material Using Silicone Rubber with Carbon Fiber", Y. Nikawa, M. Chino, and K. Kikuchi, 1996, IEEE Transactions on Microwave Theory and Techniques, 44:1949 – 1953.
- Fields of a Portable Radio Handset Near the Human Head – Phase I, C.W. Trueman, S.J. Kubina, and M. Danesh, 1996, TN-EMC-96-01 Final Report, EMC Laboratory, Department of Electrical and Computer Engineering, Concordia University, Montreal, Quebec, Canada, 70–99.
- Provisional Head and Torso Simulator for Acoustic Measurements of Air Conduction Hearing Aids, International Electrotechnical Commission 60959 TR0 Ed. 1.0 (7 July 1989)



## 4.0 DEFINITIONS

**manikin:** an RF transparent shell for the phantom

**phantom:** a device that simulates the size, contours, and electrical characteristics of human tissue

## 5.0 PHANTOMS

### 5.1 Universal Head-Arm (UniHead) Phantom

IEC 60959 (TR0 Ed.1.0, 1989, Provisional Head and Torso Simulator for Acoustic Measurements of Air Conduction Hearing Aids) tabulates standard ergonomic data for the human head and torso. A manikin generated from these measurements represents the 95<sup>th</sup> percentile of the population.

#### 5.1.1 Head Simulator

The principle dimensions of the head and torso simulator are shown in Figures 5.1 and 5.2 are listed in Table 5.1.

Table 5.1

A	HEAD BREADTH	152 mm
B	HEAD HEIGHT	141 mm
C	BITRAGON DIAMETER	110 mm
D	NECK DIAMETER	103 mm
E	SHOULDER BREADTH	440 mm
F	CHEST BREADTH	279 mm
G	HEAD LENGTH	199 mm
H	TRAGON TO WALL	97 mm
I	CHIN-VERTEX LENGTH	243 mm
J	TRAGON TO SHOULDER	165 mm
K	SHOULDER DEPTH	116 mm
L	CHEST DEPTH	225 mm
M	SHOULDER POSITION	125 mm

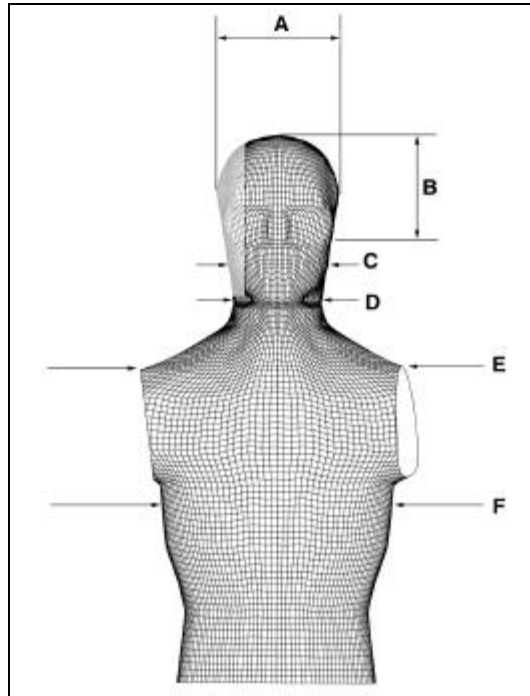

Figure 5.1

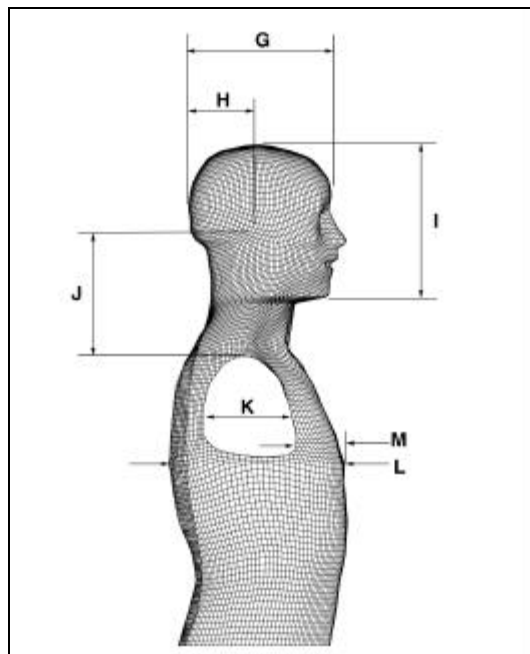

Figure 5.2

Comments and inquiries should be addressed to:

RF Dosimetry Research Board (DRB)  
Spectrum Sciences Institute  
51 Spectrum Way, Nepean, Ontario, Canada K2R 1E6  
Tel. (613) 820-6471 Fax (613) 820-4161  
e-mail: [inform@spectrum-sciences.org](mailto:inform@spectrum-sciences.org)

Ref: Project U404-7-0016 -1997





An engineering approximation for a human head simulator can be made from this ergonomic data using basic canonical shapes. If we define one cylinder with the diameter of the head's breadth (A) and a second with the diameter of the chin's diameter (C) and join the two cylinder with a plane tangent to both cylinders and with a contact separation of  $(I - (A+C)/2)$  we have the basic shape of the head simulator shown in Figure 5.3. This plane defines the "cheek" of the head simulator. The width of the head simulator can be defined by the length of the head (G).

The head simulator is therefore defined by two quarter cylinders, the plane joining these two sections, for an overall length of 243 mm, and limited to a width of 199 mm.

Figure 5.4 shows an alignment aid for positioning a portable communication device. This applique is defined by the positions of the ears and the eyes within the head. By recognizing that both ears are in the center of their respective sides of the head and that the tip of the pinna of the compressed ear coincides with the beginning of the roll-off of the skull cylinder section, we can define a symmetric, ear independent, reference point at (0,0). This is the tip of the composite pinna. Furthermore, the two shaded spots at (0,-7 cm) and (0,+7 cm) correspond to the positions of the humans eyes relative to the ears.

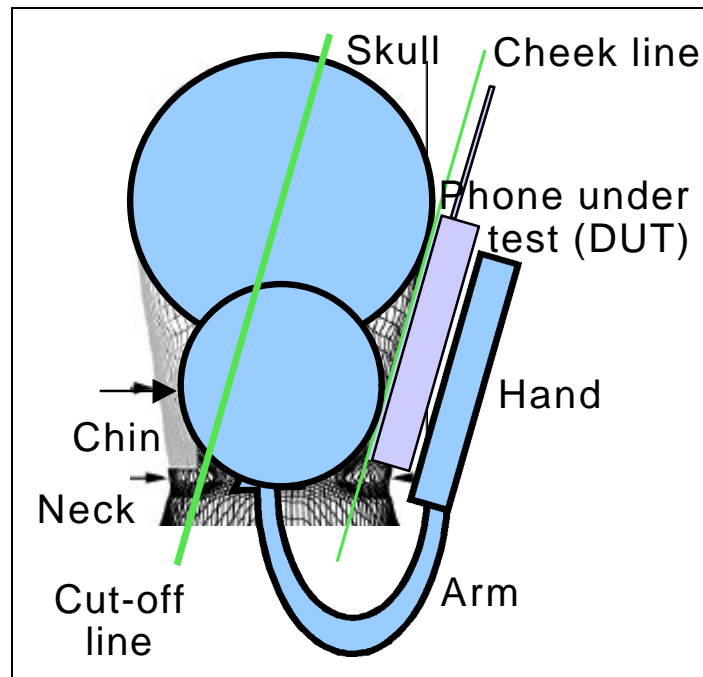

Figure 5.3

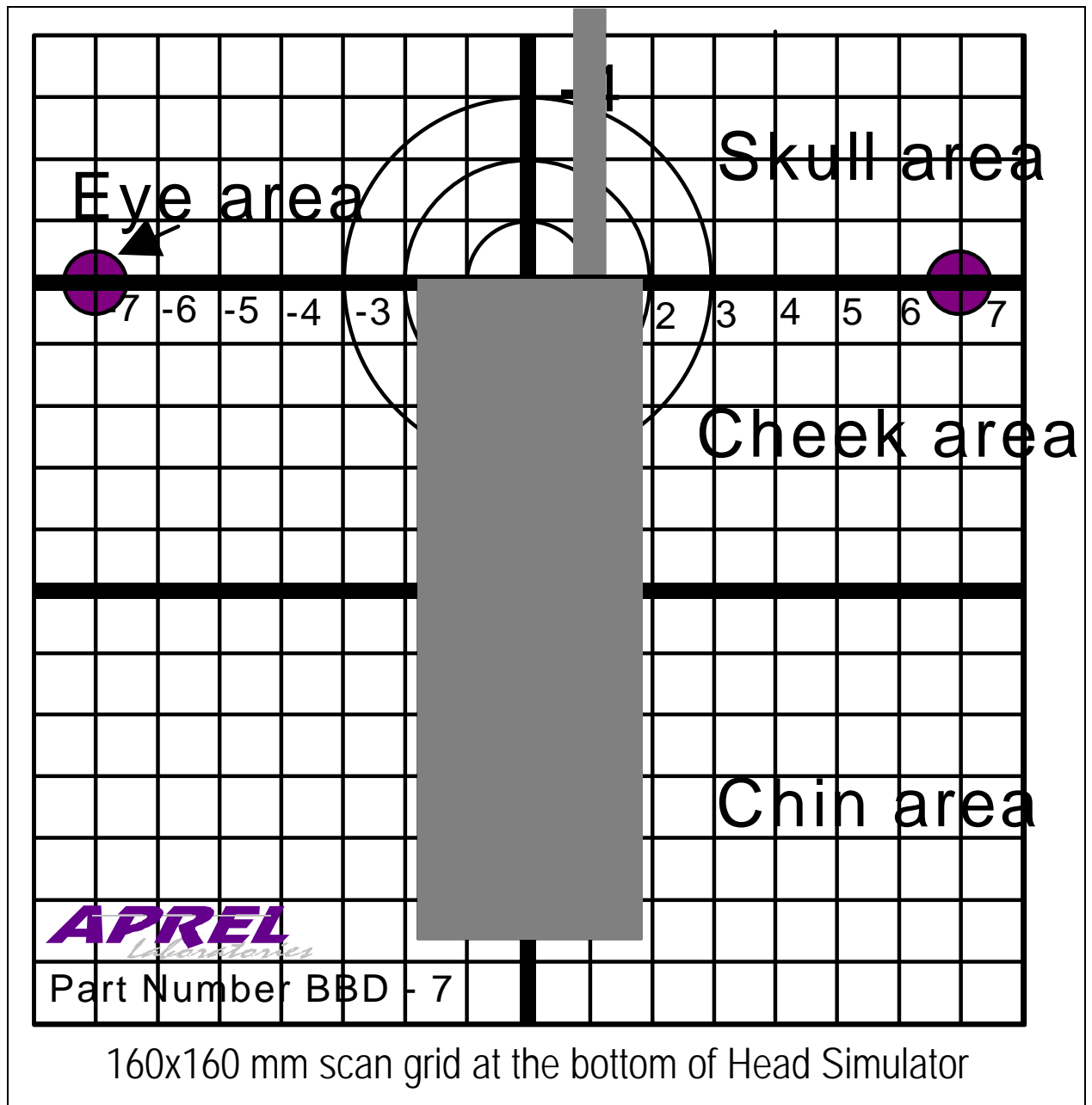

Figure 5.4

Comments and inquiries should be addressed to:

RF Dosimetry Research Board (DRB)  
Spectrum Sciences Institute  
51 Spectrum Way, Nepean, Ontario, Canada K2R 1E6  
Tel. (613) 820-6471 Fax (613) 820-4161  
e-mail: [inform@spectrum-sciences.org](mailto:inform@spectrum-sciences.org)

Ref: Project U404-7-0016 -1997



## 5.1.2 Arm and Hand Simulator

The principal dimensions of the arm and hand are listed in Table 5.2. The hand is represented with a parallelepipedic volume having the dimensions 36x90x110mm. The hand simulator is attached to the head simulator by means of a flexible arm that is attached to a valved nipple. This can provide a continuous conducting link between the liquid in the head where the measurements are taking place and the hand where the handset is being held. Alternatively, with the valve shut, muscle simulating synthetic tissue can be placed in the hand and arm simulator, at the expense of the continuous conducting link.

Table 5.2

	SHOULDER –ELBOW LENGTH	365 mm
	FOREARM-HAND LENGTH	440 mm
	HAND THICKNESS	36 mm
	HAND LENGTH	200 mm
	HAND BREADTH AT THUMB	112 mm
	HAND BREADTH AT METACARPAL	90 mm

Figure 5.5 shows an alignment aid for positioning a portable communication device. This applique is symmetric with respect to the center of the hand simulator. The upper surface of the hand simulator is longer than the defined parallelepipedic volume in order for a dielectric alignment pin to be screwed in to act as a stop for positioning the phone on the hand. In addition, the upper surface is also wider to allow notches to be placed on either side to which an elastic restraint can be attached to hold the portable device in place.

## 5.1.3 Materials

The materials used for the fabrication of the Universal Head–arm (UH-a) are non-metallic. The support platform and base are constructed of laminated wood for easy cleaning (see Figure 5.6 and Table 5.3). The vertical guides are constructed of hard wood giving precision of vertical movement to the measuring gauge and the hand guide. The head- and hand-simulating volumes are made of Plexiglas. The head simulation has the top edge raised above the platform for easy wrapping and removal for storage when containing tissue-simulating liquid. This allows a substitution of phantoms representing different frequencies. Tissue-simulating liquid contained in the hand volume is connected to tissue simulating liquid contained in the head volume by a flexible arm that can be detached for cleaning and storage. The Plexiglas volume of head is formed and terminally stabilized to its exact characteristics. Plexiglas does not include additives for reinforcement. The manufacturing process for the Universal Head-arm allows precise duplication of

*Comments and inquiries should be addressed to:*

RF Dosimetry Research Board (DRB)  
Spectrum Sciences Institute  
51 Spectrum Way, Nepean, Ontario, Canada K2R 1E6  
Tel. (613) 820-6471 Fax (613) 820-4161  
e-mail: [inform@spectrum-sciences.org](mailto:inform@spectrum-sciences.org)

*Ref: Project U404-7-0016 -1997*



geometrical and dielectric properties of the setup. Bonding with adhesives and solvents is used. Nylon screws are used to secure some elements. Clear gloss materials and appropriate grids allow verification of proper location and function of the phone under test.

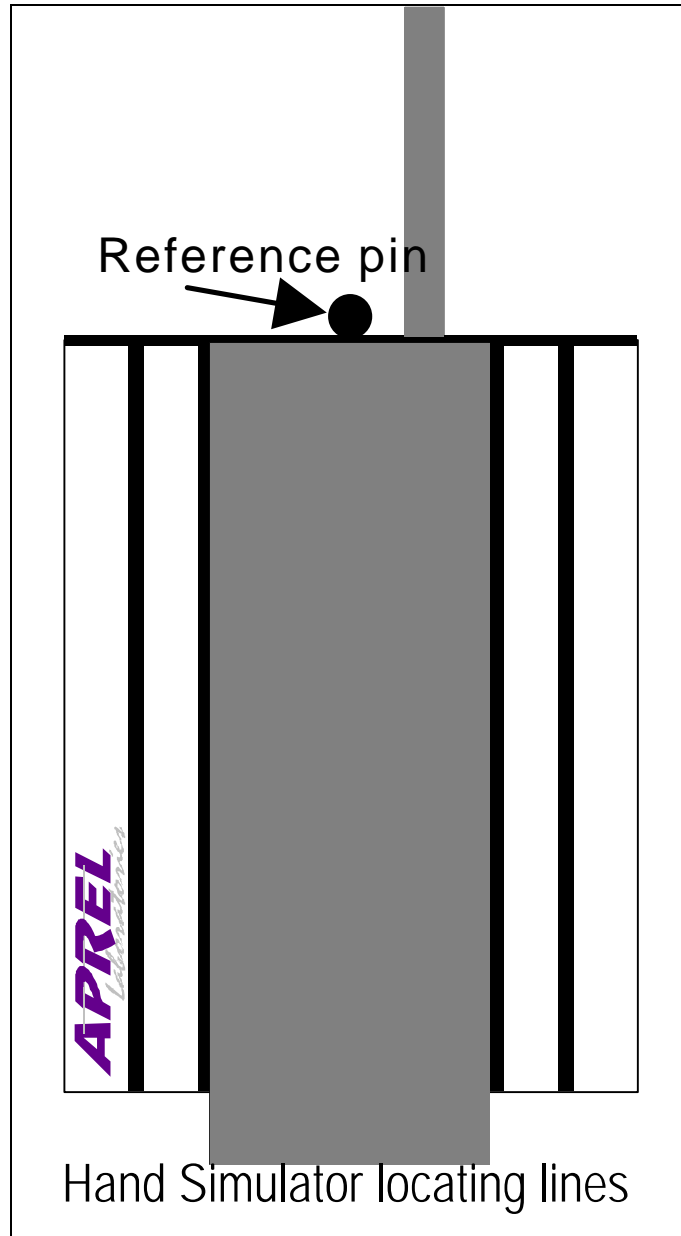

Figure 5.5

Comments and inquiries should be addressed to:

RF Dosimetry Research Board (DRB)  
Spectrum Sciences Institute  
51 Spectrum Way, Nepean, Ontario, Canada K2R 1E6  
Tel. (613) 820-6471 Fax (613) 820-4161  
e-mail: [inform@spectrum-sciences.org](mailto:inform@spectrum-sciences.org)

Ref: Project U404-7-0016 -1997

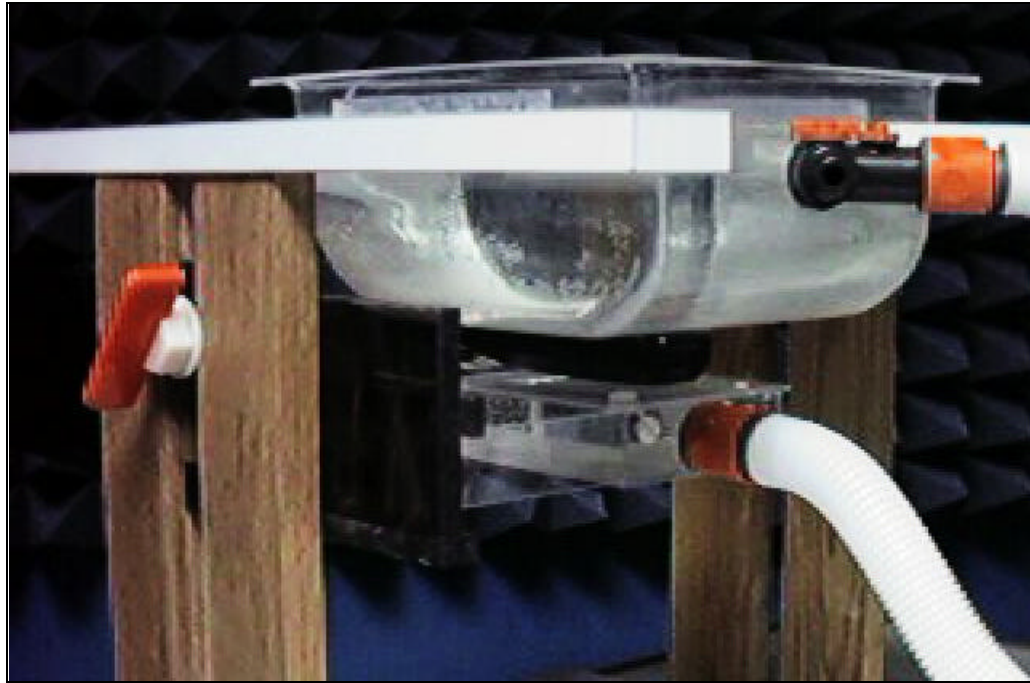

Figure 5.6

Table 5.3

<b>Specifications</b>	
Model	UH-1
Frequency	tissue dependant
Head cut-off section	190 mm x 240 mm
Hand surface	95 mm x 115 mm
Basic scan area	160 mm x 160 mm
Hand position	self-locking
Head-arm-hand connections	fast release type
Dimensions	
-height	410 mm
-length	580 mm
-width	500 mm
Weight	approx. 12 kg

Comments and inquiries should be addressed to:

RF Dosimetry Research Board (DRB)  
Spectrum Sciences Institute  
51 Spectrum Way, Nepean, Ontario, Canada K2R 1E6  
Tel. (613) 820-6471 Fax (613) 820-4161  
e-mail: [inform@spectrum-sciences.org](mailto:inform@spectrum-sciences.org)

Ref: Project U404-7-0016 -1997



## 5.2 Flat Phantom

An acrylic flat phantom with a parallelepipedic volume of 47mm x 14mm x 7mm is used for evaluating the RF exposure of other parts of the user body by wireless devices that are not normally used in the vicinity of the head and cannot be accommodated by the UniHead. (Such devices would include wireless LAN PCMCIA cards installed in laptop personal computers). It can also be suitable for experiment where a larger flat surface is desired that is provided by the UniHead phantom.

## Insulated Flat Phantom

A styrofoam flat phantom with a parallelepipedic volume of 32mm x 21mm x 18 mm is used for the determination of the enhancement factor of synthetic tissue in the calibration of the miniature isotropic electric field (E-field) probes.

## 6.0 SAR LABORATORY SETUP

The phantom is typically setup in relation to the other SAR measurement system equipment as shown in Figure 6.1. The major pieces of equipment for this setup are shown in the Table 6.1.

The articulated robot arm is usually located at one edge or corner of the laboratory space, situated in an RF anechoically damped area. The miniature isotropic E-field probe is attached to the end of the robot arm by means of a dielectric holder which serves the purpose of displacing the probe from the metal of the robot arm that could perturb the RF fields from the portable communication device under test. The phantom is placed in front of the robot arm, on the phantom support fixture, at a distance as far as possible from the robot, but close enough that the E-field probe can explore the entire interior region of the phantom. Again, this is to minimize the perturbations of the RF fields from the portable communication device under test in the vicinity of the robot arm.

The E-field probe is connected to a data acquisition card inside a computer by means of shielded cables. The computer controls the SAR measurement system by controlling the movement of the robot by communicating with its controller, and recording data from the data acquisition card.

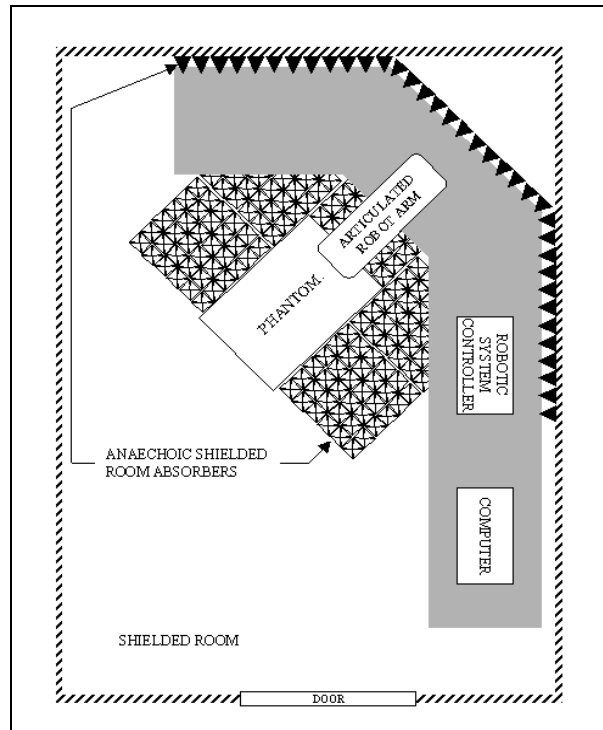

Figure 6.1

Table 6.1

Description	Manufacturer	Model
Articulated Robot Arm	CRS Robotics	A255
Robotic System Controller	CRS Robotics	C500
Phantom	APREL	various
Phantom support fixture	APREL	various
Synthetic Tissue Mixture	APREL	SSI/DRB-TP-D01-033
Miniature E-field probe	Narda	8021B
Probe support fixture	APREL	N/A
Computer	Northern Micro	Pentium 75
Software	Microsoft	Office 97 Pro
Software	APREL	SAR Measurement
Data acquisition card	ComputerBoards	CIO-DAS08-PGH
Miscellaneous Cables	N/A	N/A

Comments and inquiries should be addressed to:

RF Dosimetry Research Board (DRB)  
Spectrum Sciences Institute  
51 Spectrum Way, Nepean, Ontario, Canada K2R 1E6  
Tel. (613) 820-6471 Fax (613) 820-4161  
e-mail: inform@spectrum-sciences.org

Ref: Project U404-7-0016 -1997



## 7.0 TEST CONFIGURATIONS USING THE UNI-HEAD

The Universal Head (Uni-Head) had been originally designed by APREL Laboratories for studies of antenna structures and for optimization of radiating characteristics of handsets. In addition of being a design tool, the Uni-Head may be used for most of measurements required in dosimetry. The figure 7.1 below illustrates some typical scenarios using the Uni-head for various devices under test (DUT).

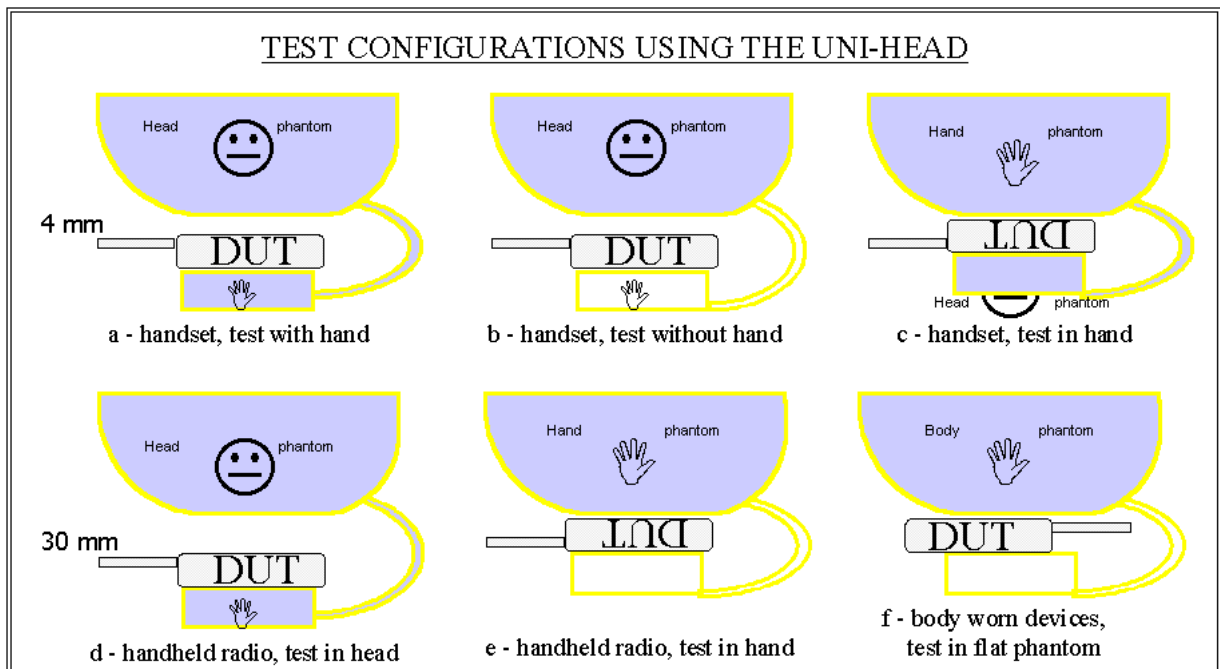

Figure 7.1 (not to scale)



---

# Spectrum Sciences Institute RF Dosimetry Research Board

---



Attention: all comments, suggestions, and inquiries should be addressed to  
Dr. Jack J. Wojcik or Dr. Paul G. Cardinal  
51 Spectrum Way., Nepean Ontario, K2R 1E6, Canada. tel.:(613)820-2730, fax:(613)820-4161  
e-mail: inform@spectrum-sciences.org

## Probe Design and Calibration Requirements

### SSI/DRB-TP-D01-032



**PART of SAR Measurements Requirements**

**SSI/DRB-TP-D01-030**

**DRAFT**

*Prepared jointly with:*

**APREL**  
*Laboratories*

**Near Field Measurements Laboratory**

March 1998

- NOTICE -

This draft was prepared to assist the Dosimetry Research Board of SPECTRUM SCIENCES INSTITUTE and specifically the Working Group on SAR Measurements. It is submitted as a basis for discussion only, and is not binding on APREL Inc. Subsequent study may lead to revisions of the document, both in numerical values and/or form, and after continuing study and analysis, APREL Inc. specifically reserves the right to add to, or amend the content of this contribution.



## TABLE OF CONTENTS

<b>1.0 Introduction</b>	<b>3</b>
<b>2.0 Background</b>	<b>4</b>
<b>3.0 Electric-Field Probe Measurement System Calibration</b>	<b>6</b>
<b>3.1 Determining E-Field Probe Sensitivities at Frequencies up to 1 GHz</b>	<b>6</b>
<b>3.1.1 References</b>	<b>6</b>
<b>3.1.2 Definition</b>	<b>7</b>
<b>3.1.3 3.1.3 Minimum Standard</b>	<b>7</b>
<b>3.1.4 3.1.4 Test Equipment</b>	<b>7</b>
<b>3.1.5 Test Configuration</b>	<b>8</b>
<b>3.1.6 Test Procedure</b>	<b>8</b>
<b>3.1.7 Test Data Table</b>	<b>9</b>
<b>3.2 Determining E-Field Probe Sensitivities at Frequencies Above 1 GHz</b>	<b>9</b>
<b>3.2.1 References</b>	<b>9</b>
<b>3.2.2 Definition</b>	<b>10</b>
<b>3.2.3 Minimum Standard</b>	<b>10</b>
<b>3.2.4 Test Equipment</b>	<b>10</b>
<b>3.2.5 Test Configuration</b>	<b>11</b>
<b>3.2.6 Test Procedure</b>	<b>11</b>
<b>3.2.7 Test Data Table</b>	<b>12</b>
<b>4.0 Determining the Enhancement Factor of Simulated Tissue</b>	<b>12</b>
<b>4.1 Background</b>	<b>12</b>
<b>4.2 References</b>	<b>12</b>
<b>4.3 Definition</b>	<b>12</b>
<b>4.4 Minimum Standard</b>	<b>13</b>
<b>4.5 Test Equipment</b>	<b>13</b>
<b>4.6 Test Configuration</b>	<b>14</b>
<b>4.7 Test Procedure</b>	<b>14</b>
<b>4.8 Test Data Table</b>	<b>15</b>
<b>4.9 Test Data Analysis</b>	<b>15</b>



## 1.0 INTRODUCTION

### 1.1 Purpose and Scope

The purpose of this document is to standardize the test procedures to be followed in calibrating miniature isotropic electric-field (E-Field) probes. This Standard includes the methodology and procedures to be followed in calibrating E-field probes to be used for Specific Absorption Rate (SAR) measurements, in accordance with industry standards and practices.

This Standard defines:

- the methodology and procedures to be followed in the laboratory calibration of the miniature isotropic E-field probes.
- the hardware and software required, the test procedures, and, where applicable, the required limits for calibration of the miniature isotropic E-field probes.

This Standard includes tests to determine the following parameters:

1. Sensor Sensitivity
2. Simulated Tissue Enhancement Factor

This Standard is part of a Certification Program Methodology as described in a separate document entitled "SSI/DBR TP-D01-030, Specific Absorption Rate (SAR) Standard For Portable Telecommunications Devices, March 1998". SSI/DBR TP-D01-032 contains specific criteria that must be met for SAR certification.

### 1.2 Test Facilities

All calibration work as described in this Standard shall be performed at an ISO/IEC Guide 25 accredited laboratory.

### 1.3 Test Personnel

Personnel performing the calibration will be experienced in relevant measurements (eg physical properties or RF characteristics) and supervised by a person proficient in SAR measurements.

*Comments and inquiries should be addressed to:*

RF Dosimetry Research Board (DRB)  
Spectrum Sciences Institute  
51 Spectrum Way, Nepean, Ontario, Canada K2R 1E6  
Tel. (613) 820-6471 Fax (613) 820-4161  
e-mail: [inform@spectrum-sciences.org](mailto:inform@spectrum-sciences.org)

*Ref: Project U404-7-0016 -1997*



## 1.4 Test Equipment

The required test equipment, hardware and software, is identified in each individual procedure. Equipment may be substituted or updated from time to time. Should this occur, such change shall be noted in the test report. Equipment shall be calibrated to standards traceable to International Standards.

## 1.5 Standard Environmental Conditions

All measurements and calibration should be performed under normal laboratory conditions for physical properties and electrical characteristics as stipulated by ISO/IEC Guide 25. The nominal temperature for physical property measurements and for electrical characterization are 20°C and 23°C, respectively.

## 2.0 BACKGROUND

The miniature isotropic electric-field (E-field) probe (Fig. 2.1) is a three-channel device used to measure RF electric fields. The sensors are three mutually-orthogonal dipoles, each 2.5 mm, or less, in length. For each channel of the probe, the dipole and two high-impedance lines are deposited on a planar substrate. Located at the center of the dipole is a Schottky diode (shown in Fig. 2.1). The three substrates are assembled to form a beam. Along the substrate are three pairs of high impedance conductors that connect the dipoles to a single output connector. The probe is enclosed in a protective sleeve to avoid contact with the corrosive elements of the simulated tissue. The total length of the probe is approximately 25 cm. The probe does not perturb significantly the field being measured. It is isotropic so that no matter how the probe is positioned relative to the electric field, the sum of the outputs of the three channels always gives the same value. The probe is very fragile, can be damaged by mechanical shock, and should be safely stored when not in use.

In the case of the triangular probe, because of the geometry of the probe elements, if the probe axis is aligned perpendicular to the E-field, and the probe is rotated so that the output of Channel x is maximized, then Channel x's dipole will form a 35.3° angle with the E-field. The relationship between the sensitivity of each channel with the probe axis perpendicular to the electric field ( $\epsilon$ ) to the sensitivity for the E-field tangential to the dipole ( $\eta$ ) is then:

*Comments and inquiries should be addressed to:*

*Ref: Project U404-7-0016 -1997*

RF Dosimetry Research Board (DRB)  
Spectrum Sciences Institute  
51 Spectrum Way, Nepean, Ontario, Canada K2R 1E6  
Tel. (613) 820-6471 Fax (613) 820-4161  
e-mail: [inform@spectrum-sciences.org](mailto:inform@spectrum-sciences.org)



$$\eta = e/\cos^2(35.3^\circ) = 1.50e$$

Free space calibration of E-field probes can be performed using a TEM cell with operating frequency at or below 1 GHz. Free space calibration of E-field probes can be performed in an open area test site (OATS) or in a RF shielded enclosure for operating frequency at or above 1 GHz.

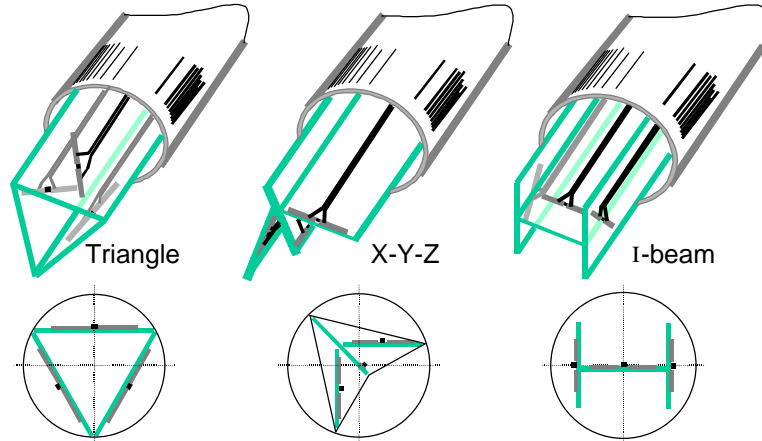

Figure 2.1

The following plots show the output of an E-field probe versus angular position for rotation in a vertical plane in a TEM cell.

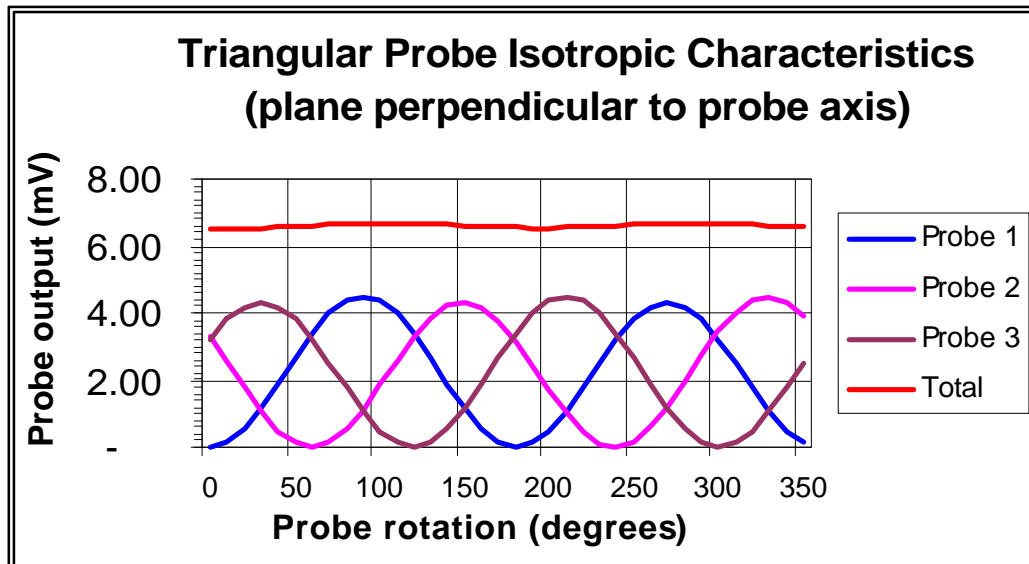

Figure 2.2

Comments and inquiries should be addressed to:

RF Dosimetry Research Board (DRB)  
Spectrum Sciences Institute  
51 Spectrum Way, Nepean, Ontario, Canada K2R 1E6  
Tel. (613) 820-6471 Fax (613) 820-4161  
e-mail: [inform@spectrum-sciences.org](mailto:inform@spectrum-sciences.org)

Ref: Project U404-7-0016 -1997



### 3.0 ELECTRIC-FIELD PROBE MEASUREMENT SYSTEM CALIBRATION

This section describes the tasks necessary to characterize the electrical performance of the E-field probe. Note that two types of calibration are specified. Section 3.1 describes calibration below or at 1 GHz. Section 3.2 describes calibration at frequencies above 1 GHz.

The E-field probe measurement system has two main components: a) the probe, which is connected to the inputs of b) the data acquisition card that is installed in a computer. The probe is connected to the data acquisition card by means of shielded cables. The system is calibrated as one unit, not as individual components. If any component is modified or replaced, the system must be re-calibrated.

The system calibration is performed by determination of the free space E-field from the probe outputs in a test RF field.

#### 3.1 Determining E-Field Probe Sensitivities at Frequencies up to 1 GHz

##### 3.1.1 References

- SAR Measurement Operational Guide, O.M. Garay and Q. Balzano, 1995, Motorola, Florida Corporate Electromagnetics Research Laboratory, Fort Lauderdale, Florida.
- “Calibration of Low Frequency Electric and Magnetic Field Probes”, W. Köhler, EMC '96, International Symposium on Electromagnetic Compatibility, Rome, Italy, September 1996
- “Calibration of Electromagnetic Field Probes in Different Measurement Sites: Comparison of Results”, G. Agnello, P. Bertotto, M. Borsero, G. Pierucci, V. Squizzato, EMC '96, International Symposium on Electromagnetic Compatibility, Rome, Italy, September 1996
- “Electric Field Probes for Cellular Phone Dosimetry”, H.I. Bassen, Center for Devices and Radiological Health, FDA, Attachment 6a, Minutes IEEE Standards Coordinating Committee - 34, Subcommittee – 2 (Certification of Wireless Handsets), Qualcomm, La Jolla, California, 3&4 December, 1997.
- “New Perspective in Broad Band Sensors Calibration”, Licitra, Francia, Giusti, Poci, EMC '96, International Symposium on Electromagnetic Compatibility, Rome, Italy, September 1996

Comments and inquiries should be addressed to:

RF Dosimetry Research Board (DRB)  
Spectrum Sciences Institute  
51 Spectrum Way, Nepean, Ontario, Canada K2R 1E6  
Tel. (613) 820-6471 Fax (613) 820-4161  
e-mail: [inform@spectrum-sciences.org](mailto:inform@spectrum-sciences.org)

Ref: Project U404-7-0016 -1997



### 3.1.2 Definition

The sensitivity of each of the three probe channels is a DC voltage produced at the outputs with the probes exposed to a specified free space electrical field.

### 3.1.3 Minimum Standard

The sensitivity of the probes depends on the manufacturer of the probes and individual components used to manufacture the probes. As such, there is no minimum requirement for sensitivity of the probes.

### 3.1.4 Test Equipment

Description	Manufacturer	Model
RF Signal Generator	Hewlett Packard	8662A
RF Amplifier 0.5 – 1 GHz	APREL	RFPA-1000
TEM Test Cell	Fischer Custom Communications	FCC-TEM-JM1
RF Power Meter	Rohde & Schwarz	NRVS
Miniature E-field probe	Narda	8021B
Probe support fixture	APREL	N/A
Computer	Northern Micro	Pentium 75
Software	Microsoft	Office 97 Pro
Software	APREL	SAR Measurement
Data acquisition card	ComputerBoards	CIO-DAS08-PGH
Miscellaneous Cables	N/A	N/A



### 3.1.5 Test Configuration

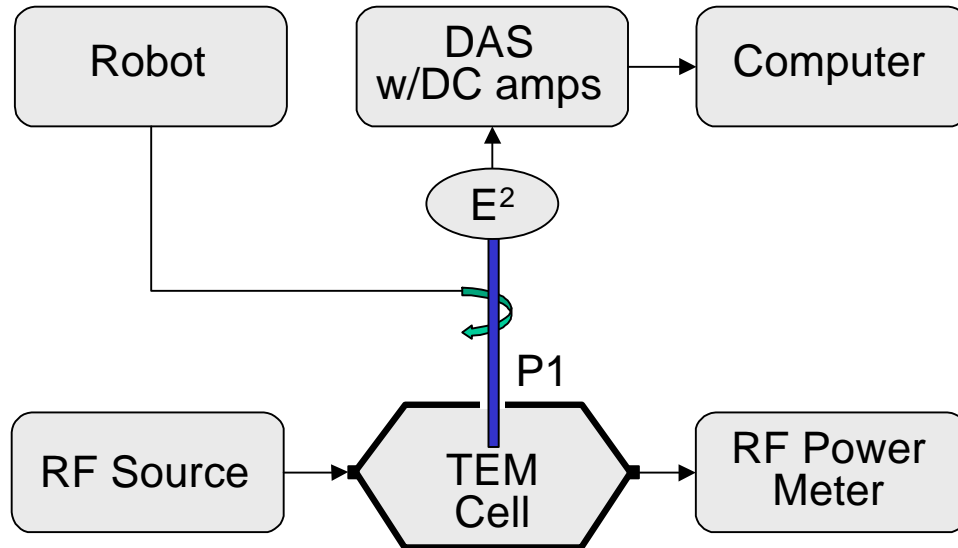

Figure 3.1

### 3.1.6 Test Procedure

1. Connect the equipment as shown in the test configuration.
2. Set the RF generator frequency to 1GHz.
3. Adjust the RF generator output so that the power density inside the TEM Cell is 1mW/cm<sup>2</sup>. (For the FCC Model FCC-TEM-JM1 Cell, the correct power level is 153 mW.)
4. Mount the probe of the system to be calibrated in the support fixture.
5. Insert the probe through the side aperture of the TEM Cell. The probe handle should be at the geometric center of the aperture, i.e. midway between the septum and the upper surface, and orthogonal to the side of the Cell. The sensing portion of the probe should be located at a point halfway across the depth of the cell (volumetric center).
6. Once the prescribed position is obtained, it must be maintained during the rest of the measurement. The only movement of the probe allowed is rotation on its axis to position the dipoles in the plane of E-field.
7. Verify that the RF power level remains constant throughout the measurement. While the probe is being rotated through 360 degrees, record the maximum measured on each channel.

Comments and inquiries should be addressed to:

RF Dosimetry Research Board (DRB)  
Spectrum Sciences Institute  
51 Spectrum Way, Nepean, Ontario, Canada K2R 1E6  
Tel. (613) 820-6471 Fax (613) 820-4161  
e-mail: [inform@spectrum-sciences.org](mailto:inform@spectrum-sciences.org)

Ref: Project U404-7-0016 -1997





8. Set the RF generator to a desired calibration frequency and repeat steps 4 through 7.

### 3.1.7 Test Data Table

The sensitivities in mV/ (mW/cm<sup>2</sup>) for each channel can be recorded in the following table:

Frequency (MHz)	Channel 0 (Pins 6 & 1)		Channel 1 (Pins 2 & 3)		Channel 2 (Pins 4 & 5)	
	e	$\eta$	e	$\eta$	e	$\eta$
835						
1000						

## 3.2 Determining E-Field Probe Sensitivities at Frequencies above 1 GHz

### 3.2.1 References

- “Calibration of Low Frequency Electric and Magnetic Field Probes”, W. Köhler, EMC '96, International Symposium on Electromagnetic Compatibility, Rome, Italy, September 1996
- “Calibration of Electromagnetic Field Probes in Different Measurement Sites: Comparison of Results”, G. Agnello, P. Bertotto, M. Borsero, G. Pierucci, V. Squizzato, EMC '96, International Symposium on Electromagnetic Compatibility, Rome, Italy, September 1996
- “Electric Field Probes for Cellular Phone Dosimetry”, H.I. Bassen, Center for Devices and Radiological Health, FDA
- “New Perspective in Broad Band Sensors Calibration”, Licitra, Francia, Giusti, Poci, EMC '96, International Symposium on Electromagnetic Compatibility, Rome, Italy, September 1996



### 3.2.2 Definition

The sensitivity of each of the three probe channels is a DC voltage produced at the outputs with the probes exposed to a free space electrical field at frequencies greater than or equal to 1 GHz.

### 3.2.3 Minimum Standard

The sensitivity of the probes depends on the manufacturer of the probes and individual components used to manufacture the probes. As such, there is no minimum requirement for sensitivity of the probes.

### 3.2.4 Test Equipment

Description	Manufacturer	Model
RF Signal Generator	Hewlett Packard	8340B
TWT Amplifier (1.4 – 2.4 GHz)	Hughes	1177H-10F000
Anechoic Shielded Room	APREL	N/A
Horn Antenna (1 – 18 GHz)	APREL	AA-118
RF Power Meter	Rohde & Schwarz	NRVS
Miniature E-field probe	Narda	8021B
Probe support fixture	APREL	N/A
Computer	Northern Micro	Pentium 75
Software	Microsoft	Office 97 Pro
Software	APREL	SAR Measurement
Data acquisition card	ComputerBoards	CIO-DAS08-PGH
Miscellaneous Cables	N/A	N/A

Comments and inquiries should be addressed to:

RF Dosimetry Research Board (DRB)  
Spectrum Sciences Institute  
51 Spectrum Way, Nepean, Ontario, Canada K2R 1E6  
Tel. (613) 820-6471 Fax (613) 820-4161  
e-mail: [inform@spectrum-sciences.org](mailto:inform@spectrum-sciences.org)

Ref: Project U404-7-0016 -1997



### 3.2.5 Test Configuration

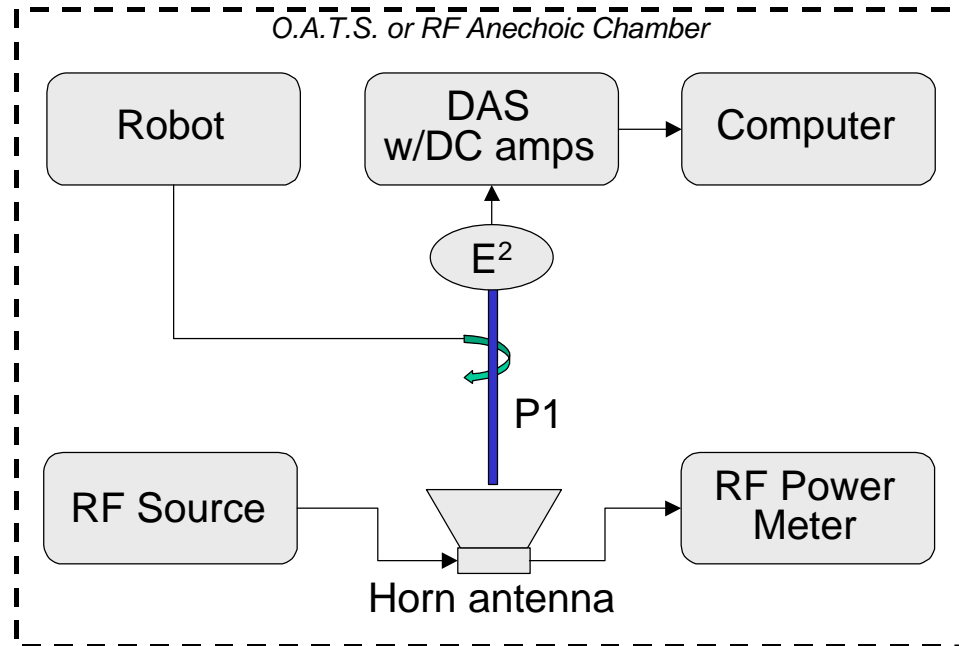

Figure 3.2

### 3.2.6 Test Procedure

1. Mount the miniature RF probe of the system to be calibrated in a support fixture.
2. Setup the equipment so that the horn antenna is coaxial with, and separated from the probe by 1 m.
3. Set the RF generator output at 1GHz.
4. Adjust the RF generator output so that the power density at the miniature RF probe is  $1\text{mW}/\text{cm}^2$
5. Once the prescribed position is obtained, it must be maintained during the rest of the measurement. The only movement of the probe allowed is rotation on its axis to position the dipoles in the plane of E-field.
6. While the probe is being rotated through 360 degrees, record the maximum measured on each channel.
7. Verify the 1 GHz results against those obtained with the TEM cell at the same frequency before proceeding
8. Set the RF generator to a desired calibration frequency and repeat steps 4 through 6.

Comments and inquiries should be addressed to:

RF Dosimetry Research Board (DRB)  
Spectrum Sciences Institute  
51 Spectrum Way, Nepean, Ontario, Canada K2R 1E6  
Tel. (613) 820-6471 Fax (613) 820-4161  
e-mail: [inform@spectrum-sciences.org](mailto:inform@spectrum-sciences.org)

Ref: Project U404-7-0016 -1997



### 3.2.7 Test Data Table

The sensitivities in mV/ (mW/cm<sup>2</sup>) for each channel can be recorded in the following table:

Frequency (GHz)	Channel 1 (Pins 6 & 1)		Channel 2 (Pins 2 & 3)		Channel 3 (Pins 4 & 5)	
	e	$\eta$	e	$\eta$	e	$\eta$
1.0						

## 4.0 DETERMINING THE ENHANCEMENT FACTOR OF SIMULATED TISSUE

### 4.1 Background

The enhancement factor describes the ratio of the sensitivity of the probe sensors in different media to their sensitivity in air. The calibration factor needs only be calculated once for each probe type

### 4.2 References

- SAR Measurement Operational Guide, O.M. Garay and Q. Balzano, 1995, Motorola, Florida Corporate Electromagnetics Research Laboratory, Fort Lauderdale, Florida.
- “Broadband Calibration of E-Field Probes in Lossy Media”, K. Meier, M. Burkhardt, T. Schmid, and N. Kuster, 1996, IEEE Transactions on Microwave Theory and Techniques, 44:1954-1962.

### 4.3 Definition

**enhancement factor:** the ratio of the sensitivity of the probe sensors in different media to their sensitivity in air.

Comments and inquiries should be addressed to:

RF Dosimetry Research Board (DRB)  
Spectrum Sciences Institute  
51 Spectrum Way, Nepean, Ontario, Canada K2R 1E6  
Tel. (613) 820-6471 Fax (613) 820-4161  
e-mail: inform@spectrum-sciences.org

Ref: Project U404-7-0016 -1997



#### 4.4 Minimum Standard

The enhancement factor of the probes depends on the simulated tissue formulation. As such, there is no minimum requirement for the enhancement factor of the probes.

#### 4.5 Test Equipment

Description	Manufacturer	Model
Precision Thermistor	Omega	ON-901-44004
Precision Dual-Channel Thermometer	Guildline	5150
Insulated Flat Phantom	APREL	
Synthetic Tissue Mixture	APREL	SSI/DRB-TP-D01-033
Reference Half-Wave Dipole	APREL	various
RF Signal Generator	Hewlett Packard	8340B
Amplifier	various	various
RF Power Meter	Rohde & Schwarz	NRVS
Miniature E-field probe	Narda	8021B
Probe support fixture	APREL	N/A
Computer	Northern Micro	Pentium 75
Software	Microsoft	Office 97 Pro
Software	APREL	SAR Measurement
Data acquisition card	ComputerBoards	CIO-DAS08-PGH
Miscellaneous Cables	N/A	N/A

Comments and inquiries should be addressed to:

RF Dosimetry Research Board (DRB)  
Spectrum Sciences Institute  
51 Spectrum Way, Nepean, Ontario, Canada K2R 1E6  
Tel. (613) 820-6471 Fax (613) 820-4161  
e-mail: [inform@spectrum-sciences.org](mailto:inform@spectrum-sciences.org)

Ref: Project U404-7-0016 -1997



## 4.6 Test Configuration

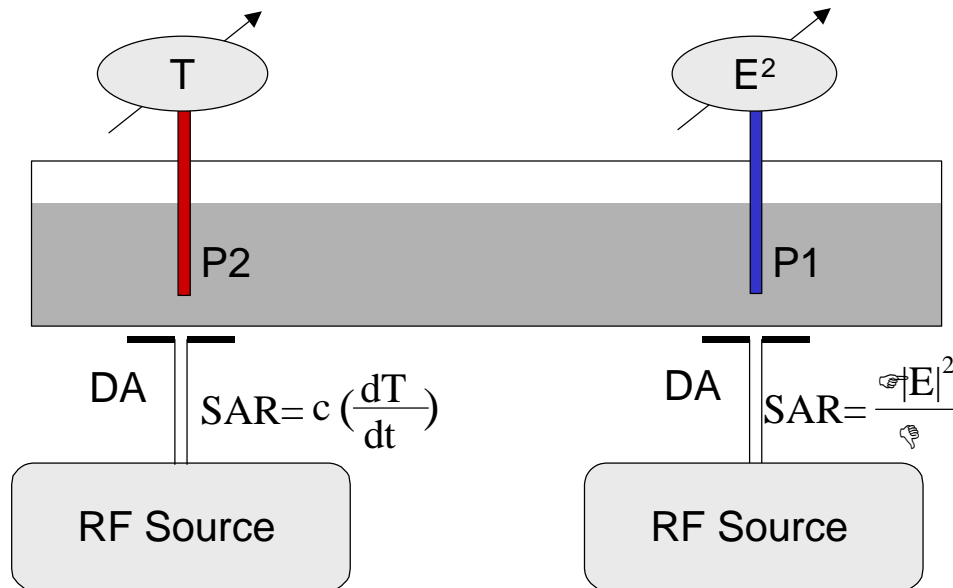

Figure 4.1

## 4.7 Test Procedure

1. A RF-transparent thermistor-based temperature probe (used with the Guildline 5150 Precision Dual-Channel Thermometer) and an isotropic E-field probe are placed side-by-side in a planar phantom while both are exposed to RF energy from a half wave dipole antenna located below the phantom (See Fig. 4.1). The E-field probe and data acquisition system was previously calibrated (see Section 3.0).
2. First, the location of the maximum E-field close to the phantom's bottom is determined as a function of power into the dipole.
3. Then, the E-field probe is moved sideways so that the temperature probe, while affixed to the E-field probe, is placed at the previous location of the E-field probe.
4. Finally, temperature changes for 30-second exposures at the same RF power levels used for the E-field measurement are recorded.
5. Care is taken to allow cooling to the original temperature and temperature stabilization between tests. (The heated region of the mixture is briefly stirred to accelerate the process).



### 4.8 Test Data Table

Frequency: (MHz)				Date:
RF Power	E-Field Measurement μV Sensor			Temperature change Measurement (°C)
Watts	1	2	3	30 Seconds

### 4.9 Test Data Analysis

The data from the insulated flat phantom measurements are used to determine the enhancement factor (γ) of the simulated tissue from the following relationships:

$$SAR = C \frac{\Delta T}{\Delta t} \quad (1)$$

$$SAR = \frac{s |E|^2}{r} \quad (2)$$

or

$$SAR = 3.77 \times 10^{-4} \frac{s}{rg} \sum_1^3 \frac{V_i}{h_i} \quad (3)$$

where C is the heat capacity of the simulated tissue (see SSI/DRB-TP-D01-033)  
 ΔT is the temperature rise in °C measured for an elapsed time of Δt seconds  
 (30s)

Comments and inquiries should be addressed to:

Ref: Project U404-7-0016 -1997

RF Dosimetry Research Board (DRB)  
 Spectrum Sciences Institute  
 51 Spectrum Way, Nepean, Ontario, Canada K2R 1E6  
 Tel. (613) 820-6471 Fax (613) 820-4161  
 e-mail: inform@spectrum-sciences.org



$|E|^2$  is the total RMS E-field level (V/m) induced within the exposed tissue  
 $\sigma$  is the conductivity of the simulated tissue (see SSI/DRB-TP-D01-033)  
 $\rho$  is the density of the simulated tissue (see SSI/DRB-TP-D01-033)  
 $V_i$  are the rectified signal voltages measured on each of the three sensors in the probe  
 $\eta_i$  are the sensor sensitivities relating the signal from a single sensor and the field component in the direction of the sensor  
 $\gamma$  is the tissue enhancement factor which related the sensitivity of the probe in different media to their sensitivity in air.

Taking the derivative of equations (1) and (3) with respect to the RF power (P) delivered to the dipole:

$$\frac{d(SAR)}{dP} = \frac{C}{\Delta t} \frac{d\Delta T}{dP} \quad (4)$$

$$\frac{d(SAR)}{dP} = 3.77 \times 10^{-4} \frac{\mathbf{s}}{\mathbf{rg}} \frac{d}{dP} \left( \sum_1^3 \frac{V_i}{\mathbf{h}_i} \right) \quad (5)$$

Let  $m_T = \frac{d\Delta T}{dP}$  which is the slope of a temperature change ( $\Delta T$ ) versus power (P) graph;

and  $m_V = \frac{d}{dP} \left( \sum_1^3 \frac{V_i}{\mathbf{h}_i} \right)$  which is the slope of the total compensated measured voltage  $\left( \sum_1^3 \frac{V_i}{\mathbf{h}_i} \right)$  versus power (P) graph.

Setting equations 4 and 5 equal to each other and solving for  $\gamma$  we get:

$$\mathbf{g} = 3.77 \times 10^{-4} \frac{\mathbf{s}}{\mathbf{r}} \frac{\Delta t}{C} \frac{m_V}{m_T}$$



---

Spectrum Sciences Institute  
RF Dosimetry Research Board

---



Attention: all comments, suggestions, and inquiries should be addressed to  
Dr. Jack J. Wojcik or Dr. Paul G. Cardinal  
51 Spectrum Way., Nepean Ontario, K2R 1E6, Canada. tel.:(613)820-2730, fax:(613)820-4161  
e-mail: inform@spectrum-sciences.org

**Tissue Recipe and Calibration Requirements**  
**SSI/DRB-TP-D01-033**



**PART of SAR Measurements Requirements**  
**SSI/DRB-TP-D01-030**

**DRAFT**

*Prepared jointly with:*

**APREL**  
*Laboratories*  
**Near Field Measurements Laboratory**

March 1998

- NOTICE -

This draft was prepared to assist the Dosimetry Research Board of SPECTRUM SCIENCES INSTITUTE and specifically the Working Group on SAR Measurements. It is submitted as a basis for discussion only, and is not binding on APREL Inc. Subsequent study may lead to revisions of the document, both in numerical values and/or form, and after continuing study and analysis, APREL Inc. specifically reserves the right to add to, or amend the content of this contribution.



## TABLE OF CONTENTS

<b>1.0</b>	<b>Introduction</b>	<b>3</b>
1.1	Purpose And Scope Of The Standard	3
1.2	Test Facilities	3
1.3	Test Personnel	3
1.4	Test Equipment	4
1.5	Standard Environmental Conditions	4
2.0	Background	4
3.0	References	5
4.0	Recipe And Preparation	5
4.1	Ingredients	5
4.2	Equipment	6
4.3	Preparation	7
5.0	Measurement of the Dielectric Constant and Conductivity of Simulated Tissue	7
5.1	Test Purpose	7
5.2	References	7
5.3	Definitions	8
5.4	Standard Values Required	8
5.5	Test Equipment	9
5.6	Test Configuration	9
5.7	Test Procedure	9
5.8	Test Data Table	11
5.9	Test Data Analysis	13
6.0	Measurement of the Specific Heat Capacity of Simulated Tissue	15
6.1	Test Purpose	15
6.2	References	15
6.3	Definition	15
6.4	Standard Value	16
6.5	Test Equipment	16
6.6	Test Procedure	16
6.7	Test Data Table	17
6.8	Test Data Analysis	17
6.9	Rationale	18
7.0	Measurement of the Density of Simulated Tissue	19
7.1	Test Purpose	19
7.2	References	19
7.3	Definition	19
7.4	Standard Value	19
7.5	Test Equipment	19
7.6	Test Procedure	20
7.7	Test Data Table	20
7.8	Test Data Analysis	21



## 1.0 INTRODUCTION

### 1.1 Purpose and Scope of the Standard

The purpose of this document is to standardize the recipe for simulated muscle and brain tissue, and the calibration of the simulated tissue. This Standard includes procedures to be followed in making and calibrating simulated biological tissues to be used for Specific Absorption Rate (SAR) measurements.

This Standard defines:

- the methodology and procedures to be followed in the laboratory calibration of the simulated tissues
- the hardware and software required, the test procedures, and, where applicable, the required limits for calibration of simulated tissues.

In addition to recipes for simulated brain and muscle tissues, this Standard also includes tests to determine the following parameters:

1. Density
2. Heat Capacity
3. Dielectric Constant and Conductivity

This Standard is part of a Certification Program Methodology as described in a separate document entitled "SSI/DBR TP-D01-030, Specific Absorption Rate (SAR) Standard For Portable Telecommunications Devices, March 1998". SSI/DBR TP-D01-033 contains specific criteria that must be met for SAR certification.

### 1.2 Test Facilities

All calibration work as described in this Standard shall be performed at an ISO/IEC Guide 25 accredited laboratory.

### 1.3 Test Personnel

Personnel performing the calibration will be experienced in relevant measurements (eg physical properties or RF characteristics) and supervised by a person proficient in SAR measurements.



## 1.4 Test Equipment

The required test equipment, hardware and software, is identified in each individual procedure. Equipment may be substituted or updated from time to time. Should this occur, such change shall be noted in the test report. Equipment shall be calibrated to standards traceable to International Standards.

## 1.5 Standard Environmental Conditions

All measurements and calibration should be performed under normal laboratory conditions for physical properties and electrical characteristics as stipulated by ISO/IEC Guide 25. The nominal temperature for physical property measurements and for electrical characterization are 20°C and 23°C, respectively.

## 2.0 BACKGROUND

In order to perform measurements of specific absorption rates (SAR) of electromagnetic energy in human brain tissue, it is necessary to use models that simulate the electrical properties of real tissue. It is also important that those models are reproducible, long lasting, non-corrosive, and easy to produce and use. Mixtures have been developed that simulate the electrical properties of various biological tissues for various frequency ranges between 100 – 2,450 MHz. This mixture is a practical simulation of biological tissue, however, requires different proportions of sugar, water, salt, hydroxyethylcellulose (HEC) and a bactericide, for different frequency ranges. The solution is easy to produce, and fairly inexpensive. Its electrical properties can be altered to match many tissue types, at different frequencies. For certain frequency ranges, the conductivity of the mixture, even without the presence of salt, will be higher than some of the biological tissues. This will lead to a conservative overestimation of the SAR value. Another advantage of the solution is that its liquid form allows easy positioning of the E-field probe within the phantom. The shelf life of such simulated tissue is reasonably long (weeks) with the addition of the bactericide. Additional precautions (covering, stirring, filtering) may extend the useful life to over six months.



### 3.0 REFERENCES

- “Simulated Biological Materials for Electromagnetic Radiation Absorption Studies”, G.W. Hartsgrove et al, Bioelectromagnetics, vol. 8, pp. 29-36, 1987.
- “Suggestions Prepared Following the CENELEC Document”, N. Kuster et al, Attachment 9, Minutes IEEE Standards Coordinating Committee –34, Subcommittee – 2, May 2, 1997 meeting.
- “Calibration for Implantable E-field Probes in Human Equivalent Material”, Narda Microwave Corporation, Feb. 11, 1997.
- Private communication, Motorola, Fort Lauderdale, FL and Libertyville, IL, 1997.
- “Compilation of the Dielectric Properties of Body Tissue at RF and Microwave Frequencies”, C. Gabriel, Brooks Air Force Technical Report AL/OE-TR-1996-0037.

### 4.0 RECIPE AND PREPARATION

#### 4.1 Ingredients

The following table contains recipes for simulated muscle and brain tissues for 100 MHz – 1GHz. This gives approximate quantities required to achieve electrical parameters specified in section in Section 5

Table 4.1

Simulated Tissue Ingredients		
Ingredient	Muscle Mixture	Brain Mixture
Water	52.4 %	40.6 %
Sugar	45.0 %	58.0 %
Salt	1.5 %	1.0 %
HEC	1.0 %	0.3 %
Bactericide	0.1 %	0.1 %



The following table contains recipes for simulated muscle and brain tissues for 1.5 –2.5 GHz. This gives approximate quantities required to achieve electrical parameters specified in section in Section 5

Table 4.2

Simulated Tissue Ingredients	
Ingredient	Brain & Muscle Mixture
Water	45.3 %
Sugar	54.3 %
Salt	0.0 %
HEC	0.3 %
Bactericide	0.1 %

Common household salt and sugar are typically used.

## 4.2 Equipment

The following equipment will be needed to make the simulated tissue.

Table 4.3

Description	Manufacturer	Model
Graduated Cylinder	BOMEX	2000 ml
Storage Container	Various sources	20 l
Weight Scale	Pennsylvania Scale Co.	2 kg
Handling Containers	Various sources	various
Corrosion Resistant Mixing Device		



### 4.3 Preparation

1. Select the appropriate simulated tissue type: Muscle or Brain.
2. From the Tables 4.1 or 4.2 above, determine the percentage of each ingredient for the volume of 20 liters, calculate the mass of each ingredient assuming that the density of the final solution is  $1300 \text{ kg/m}^3$ .
3. Verify that the storage container in which the ingredients will be mixed is clean.
4. Obtain the calculated amount of reverse-osmosis or de-ionized water.
5. Pour about 25% of the water into a glass beaker, heat it on a hot plate to almost boiling, and then add it to the cold water. The objective is to increase the temperature of the water to approximately  $40^\circ \text{C}$  ( $100\text{-}105^\circ \text{F}$ ).
6. Prepare the appropriate quantities of the dry ingredients in separate containers.
7. When the water is ready, slowly add salt and bactericide while stirring at low speed.
8. After the salt and bactericide is dissolved start adding sugar to the container while stirring continuously at low speed until totally dissolved.
9. Add the HEC slowly to avoid clumping. Continue to stir until the solution thickens.
10. Total stirring time should be 30-35 minutes.

## 5.0 MEASUREMENT OF THE DIELECTRIC CONSTANT AND CONDUCTIVITY OF SIMULATED TISSUE

### 5.1 Test Purpose

Before a batch of simulated tissue can be used for SAR measurements, its electrical characteristics (dielectric constant and conductivity) must be determined to ensure that the simulated tissue was properly made and will simulate the desired human characteristics. A coaxial slotted line with probe is used to measure RF amplitude and phase changes versus distance in the simulated tissue as shown below.

### 5.2 References

- "A Comparative Study of Four Open-Ended Coaxial Probe Models for Permittivity Measurements of Lossy Dielectric/Biological Materials at Microwave Frequencies" D.Berube, F.M.Ghannouchi, and P.Savard, 1996, IEEE Transactions on Microwave Theory and Technique 44:1928-34.
- "Broadband Calibration of E-Field Probes in Lossy Media." K.Meier, M.Burkhardt, T.Schmid, and N.Kuster, 1996, IEEE Transactions on Microwave Theory and Techniques. 44:1954-1962.



- “Coaxial Line Reflection Methods for Measuring Dielectric Properties of Biological Substances at Radio and Microwave Frequencies – A Review”, M.A. Stuchly and S.S. Stuchly, 1980, IEEE Transactions of Instrumentation and Measurement, 29:176-183.
- SAR Measurement Operational Guide, O.M. Garay and Q. Balzano, 1995, Motorola, Florida Corporate Electromagnetics Research Laboratory, Fort Lauderdale, Florida.
- FCC Dielec.exe computer program.
- CRC Handbook of Chemistry and Physics, R.C.Weast, M.J.Astle, and W.H.Beyer (Eds.), 1996, CRC Press Inc., Boca Raton, Florida.

### 5.3 Definitions

**dielectric constant:** the ratio of the capacity of a condenser with that substance as dielectric to the to the capacity of the same condenser with a vacuum for dielectric. It is a measure of the amount of electrical charge a given substance can withstand at a given electric field strength.

**conductivity:** the quantity of electricity transferred across unit area, per unit potential gradient, per unit time.

### 5.4 Standard Values Required

The dielectric constant and conductivity of simulated brain tissue should be 46.1 and 0.74 S/m<sup>2</sup>, respectively.

Table 5.1

<b>Tissue Ingredients</b>			
Frequency (MHz)	Tissue Type	Dielectric Constant $\epsilon_r$	Conductivity $\sigma$ (S/m)
835	Brain	41.2	0.90
	Muscle	54.7	1.38
915	Brain		
	Muscle		
1900	Combined	41.0	1.70
2450	Combined		

Comments and inquiries should be addressed to:

RF Dosimetry Research Board (DRB)  
Spectrum Sciences Institute  
51 Spectrum Way, Nepean, Ontario, Canada K2R 1E6  
Tel. (613) 820-6471 Fax (613) 820-4161  
e-mail: inform@spectrum-sciences.org

Ref: Project U404-7-0016 -1997





## 5.5 Test Equipment

Table 5.2

Description	Manufacturer	Model
Network Analyzer	Hewlett Packard	8510B
Slotted Line Carriage	Hewlett Packard	809B
Coaxial Termination	Hewlett Packard	908B
Slotted Line Probe	APREL	SLP-001
Miscellaneous Cables and Adapters	N/A	N/A

## 5.6 Test Configuration

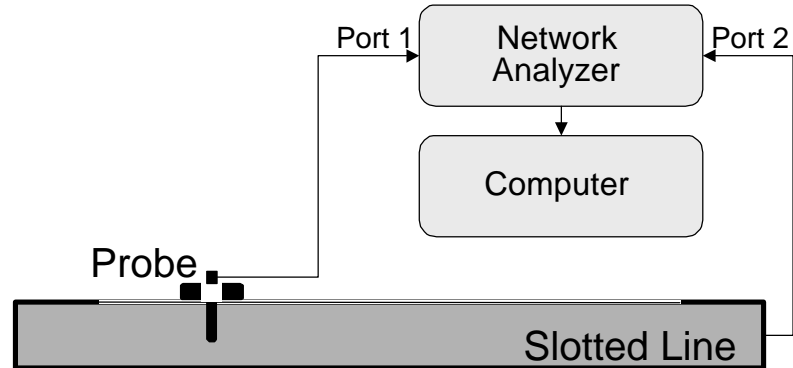

Figure 5.1

## 5.7 Test Procedure

1. Before using the slotted line, inspect it carefully to be sure the inside is clean and free of foreign matter.
2. Clean the area about 1 cm wide along each side of the slot. Similarly, clean the underside of the probe outer structure to ensure a good noise-free contact with the slotted line. Take care to avoid damage to the probe center conductor.

Comments and inquiries should be addressed to:

RF Dosimetry Research Board (DRB)  
Spectrum Sciences Institute  
51 Spectrum Way, Nepean, Ontario, Canada K2R 1E6  
Tel. (613) 820-6471 Fax (613) 820-4161  
e-mail: [inform@spectrum-sciences.org](mailto:inform@spectrum-sciences.org)

Ref: Project U404-7-0016 -1997



3. Using a large syringe, draw up a sample of room temperature simulated tissue. Ensure that the sample is as free as possible of air bubbles, and inject the simulated tissue into the slot. Make sure that the slot is full of simulated tissue and free of air bubbles.
4. Connect Port 1 of the network analyzer to the probe, and Port 2 to the slotted line.
5. Insert the slotted line probe into the probe holder and tighten the thumbscrew.
6. Move the holder to the end nearest the input connector, making sure that the simulated tissue is flush with the outside surface of the line. Align one end of the probe marker with a line on the centimeter scale.
7. Set the network analyzer's frequency range to cover the measurement frequencies and select the  $S_{12}$  parameter.
8. Select port-to-port loss measurement and select averaging over a sufficient number of samples.
9. After averaging, place the marker at a frequency of interest and record the level in the table (one table per frequency) to the nearest 0.1dB.
10. Select phase measurement (averaging should be left on). Place the marker at a frequency of interest and record in the phase in the table (one per frequency) to the nearest  $0.1^\circ$ .
11. Move the probe 0.5cm toward the far end of the line.
12. Repeat steps 7 through 11 until 13 data points (corresponding to 6 cm) have been measured.



## 5.8 Test Data Table

1. The level and phase can be recorded in the following table (use one copy per frequency):

Table 5.3

Frequency:		Date:	
Position (cm)	Level (dB)	Phase (°)	
0.0			
0.5			
1.0			
1.5			
2.0			
2.5			
3.0			
3.5			
4.0			
4.5			
5.0			
5.5			
6.0			

- Execute the Fluid Calibration with Slotted Line.xls spreadsheet and enter the measured amplitude and phase data as recorded in the table(s). When the data are plotted (eg Figure 5.2), examine the linearity of the curves to judge the validity of the calculated dielectric constant and conductivity (eg Table 5.4). If only one point on a curve is out of line, re-measure just that point. If more than one point is wrong, repeat the entire measurement. Once the data are satisfactory, the calculated values should be compared with the values in Table 5.1.
- The measured data, calculated values, and plot must be identified with the type of simulated tissue, date it was prepared, frequency, date and name of person conducting the measurements, and kept in a file.
- The simulated tissue should be used soon after preparation and characterization of the dielectric properties, and stored so as to prevent evaporation of the water. After prolonged use, a sample should be taken for dielectric measurement to assure there has been no change in properties. In the absence of biological degradation and significant evaporation, the simulated tissue can be used for several months.

Comments and inquiries should be addressed to:

RF Dosimetry Research Board (DRB)  
Spectrum Sciences Institute  
51 Spectrum Way, Nepean, Ontario, Canada K2R 1E6  
Tel. (613) 820-6471 Fax (613) 820-4161  
e-mail: [inform@spectrum-sciences.org](mailto:inform@spectrum-sciences.org)

Ref: Project U404-7-0016 -1997



Table 5.4

02-Feb-98		Rob Acorn	
Brain Mixture @		835 MHz	
Position [cm]	Amplitude [dBm]	Phase [deg]	
0	-37.9	-74.4	
0.5	-39.2	-106.6	
1	-40.6	-140.8	
1.5	-41.9	-174.3	
2	-43.2	152.4	
2.5	-44.6	117.7	
3	-45.9	83.8	
3.5	-47.2	51.4	
4	-48.6	18	
4.5	-50.1	-16.2	
5	-51.5	-49.5	
5.5	-52.7	-84.6	
6	-53.9	-115.7	
$\epsilon_r$	41.73		
$\sigma_{\text{effective}}$ [S/cm]	1.103E-02		

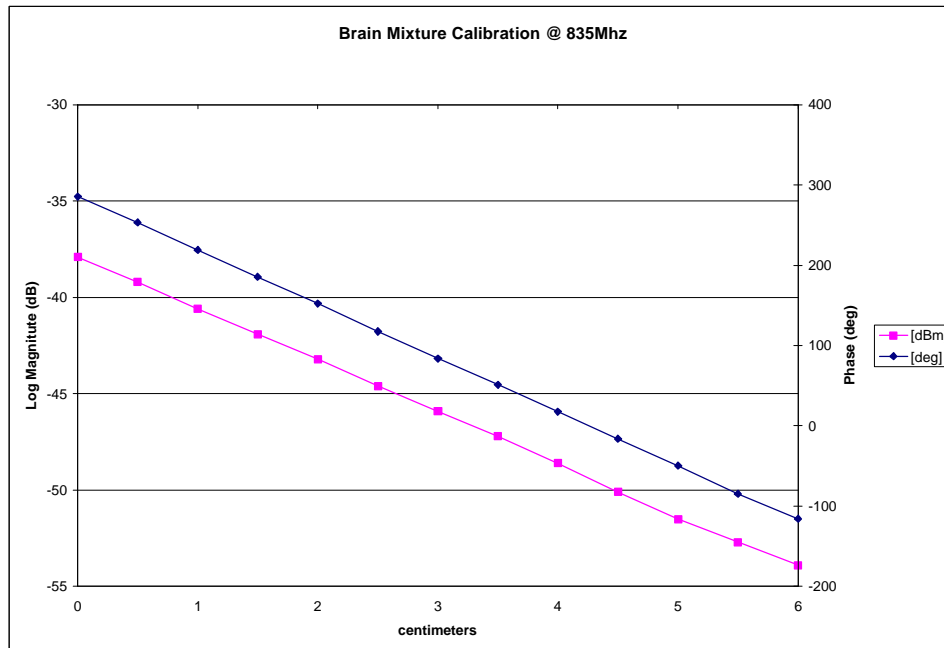

Figure 5.2

Comments and inquiries should be addressed to:

RF Dosimetry Research Board (DRB)  
Spectrum Sciences Institute  
51 Spectrum Way, Nepean, Ontario, Canada K2R 1E6  
Tel. (613) 820-6471 Fax (613) 820-4161  
e-mail: [inform@spectrum-sciences.org](mailto:inform@spectrum-sciences.org)

Ref: Project U404-7-0016 -1997



## 5.9 Test Data Analysis

The data from the slotted line are used to determine the relative dielectric constant and effective conductivity (that includes contributions from both dielectric and ohmic processes) from the following relationships:

$$\epsilon_r = \frac{b^2 - a^2}{w^2 \pi \epsilon_0} \quad (1)$$

$$s_{\text{effective}} = \frac{2ab}{wm} \quad (2)$$

$\alpha$  and  $\beta$  are determined by averaging, respectively, the attenuation (dB/cm) and phase shift (deg/cm) over the length of the slotted line. The attenuation and phase shift are each determined for seven pairs of points. Each of the pairs of points is from measurements separated by 3 cm. For example (using the data in Table 5.4), the attenuations and phase shifts at  $z=1$  cm and  $z=6$  cm define  $\Delta\text{dB}_1$  and  $\Delta\text{deg}_1$ :

$$\begin{aligned} \Delta\text{dB}_1 &= \text{Mag}(z = 3 \text{ cm}) - \text{Mag}(z = 0 \text{ cm}) \\ &= -45.9 \text{ dB}_m - (-37.9 \text{ dB}_m) = -8.0 \text{ dB}, \text{ and} \end{aligned}$$

$$\begin{aligned} \Delta\text{deg}_1 &= \text{Phase}(z = 3 \text{ cm}) - \text{Phase}(z = 0 \text{ cm}) \\ &= 83.8 \text{ deg} - (285.6) \text{ deg} = -201.8 \text{ deg}. \end{aligned}$$

In a similar fashion, obtain data for  $\Delta\text{dB}_2$  to  $\Delta\text{dB}_6$  and  $\Delta\text{deg}_2$  to  $\Delta\text{deg}_6$  and then average each series to get

$$\begin{aligned} \mathbf{a}_{\text{avg}} \text{ (dB/cm)} &= \frac{\sum_{n=1}^7 \Delta\text{dB}_n}{7 \cdot 3}, \text{ and} \\ \mathbf{b}_{\text{avg}} \text{ (deg/cm)} &= \frac{\sum_{n=1}^7 \Delta\text{deg}_n}{7 \cdot 3} \end{aligned}$$



The values of  $\alpha_{\text{avg}}$  and  $\beta_{\text{avg}}$  must be converted to units of (Np/cm) and (rad/cm) using these relations:

$$\mathcal{E}_{\text{avg}} \text{ (Np/cm)} = \frac{\ln(10) \cdot \mathcal{E}_{\text{avg}} \text{ (dB/cm)}}{20}, \text{ and}$$

$$\hat{\alpha}_{\text{avg}} \text{ (rad/cm)} = \frac{\hat{\alpha}_{\text{avg}} \text{ (deg/cm)} \cdot \delta}{20}$$

Finally, use (1) and (2) to obtain  $\epsilon_r$  and  $\sigma_{\text{effective}}$  from  $\alpha_{\text{avg}}$ ,  $\beta_{\text{avg}}$ , and  $\omega = 2\pi f$ , where  $f$  is the frequency of the RF field.



## 6.0 MEASUREMENT OF THE SPECIFIC HEAT CAPACITY OF SIMULATED TISSUE

### 6.1 Test Purpose

The specific heat capacity of the synthetic tissue liquid is required in the calibration of the miniaturized isotropic E-field probes used to measure the Specific Absorption Rate (SAR). A sample of the liquid is exposed to the known field of an RF radiation for a specific length of time. The liquid will be heated and this heat can be propagated by conduction, convection, and radiation. In the case of liquids heated from below, gravity convection is the main and predominant heating mechanism of the fluid mass.

### 6.2 References

- Introduction to Physics for Scientists and Engineers, F.J. Bueche, McGraw-Hill Book Company, New York, 1980.
- “The Specific Heats of Aqueous Sucrose Solutions”, F.T. Gucker and F.D. Ayres, 1937, American Journal of Chemistry, 59:447-452.
- “Electromagnetic Energy Exposure of Simulated Users of Portable Cellular Telephones”, Q. Balzano, O.M. Garay, and T.J. Manning, 1995, IEEE Transactions on Vehicular Technology, 44:390-403.
- “Broadband Calibration of E-Field Probes in Lossy Media”, K. Meier, M. Burkhardt, T. Schmid, and N. Kuster, 1996, IEEE Transactions on Microwave Theory and Techniques, 44:1954-1962.
- SAR Measurement Operational Guide, O.M. Garay and Q. Balzano, 1995, Motorola, Florida Corporate Electromagnetics Research Laboratory, Fort Lauderdale, Florida.

### 6.3 Definition

**specific heat capacity:** the quantity of energy needed to raise the temperature of a unit mass by one degree.



## 6.4 Standard Value

For brain tissue simulating liquids the heat capacity should be 2.8 J/K/g  $\pm$ 5%.

## 6.5 Test Equipment

Table 6.1

Description	Manufacturer	Model
Differential Thermometer		
Containers (2)		500 ml
Thermally Insulated Vessel		
Weigh Scale	Pennsylvania Scale Co.	2 kg
Graduated Cylinder	BOMEX	2000 ml
Data Recorder		

## 6.6 Test Procedure

1. Obtain two containers that can be rapidly heated (e.g., glass or suitable plastic).
2. Fill one container with 250 ml of water; the other with the same mass of simulated tissue. The initial temperature of the water should be the same as that of the simulated tissue ( $\pm 1^\circ\text{C}$ ). Since we are dealing with heating by electromagnetic sources at ambient temperature, it is essential that we eliminate the chance of any direct infrared heating of the temperature sensor.
3. To ensure this, position the tip of the sensor 2mm from the bottom of the center of the container.
4. Turn on the heat source and wait at least 5 minutes for its temperature to stabilize.
5. Record the initial temperature of the water.
6. Place the container of water 5mm above the center of the hot plate and monitor the temperature increase.
7. After 30 seconds of heating, the water temperature should have increased by at least  $5^\circ\text{C}$ . Record the time and temperature.
8. Remove the container from the heat source and place it in the thermally insulated vessel.





9. Stir the liquid thoroughly and record the steady-state temperature 1-2 minutes after stirring.
10. Repeat the above procedure using the container of simulated tissue. Ensure that the container is placed on the same area of the hot plate, is heated for the identical length of time, and the steady-state temperature is recorded after the identical time interval.

## 6.7 Test Data Table

The temperatures can be recorded below.

Table 6.2

Trial	Water (°C)			Tissue (°C)		
	Initial Temp	30 seconds	120 seconds	Initial Temp	30 seconds	120 seconds
1						
2						
3						
4						
5						
6						
7						
8						
9						
10						

## 6.8 Test Data Analysis

Since the heat capacity of water is  $C_w = 1 \text{ cal/}^\circ\text{C/g}$  with excellent approximation ( $\sim 1 \%$ ) in the temperature range of interest, the heat capacity ( $C_s$ ) of the solution is given by

$$C_s = C_w \frac{\Delta T_w}{\Delta T_s}$$

where  $\Delta T_w$  is the temperature increase of water and  $\Delta T_s$  the temperature increase of the solution. The ratio of the values,  $\Delta T_w/\Delta T_s$ , should be the same (within the sensitivity of

Comments and inquiries should be addressed to:

RF Dosimetry Research Board (DRB)  
Spectrum Sciences Institute  
51 Spectrum Way, Nepean, Ontario, Canada K2R 1E6  
Tel. (613) 820-6471 Fax (613) 820-4161  
e-mail: [inform@spectrum-sciences.org](mailto:inform@spectrum-sciences.org)

Ref: Project U404-7-0016 -1997



the thermometer) at the end of the heating and stirring. This ensures that the liquids have been uniformly heated.

## 6.9 Rationale

$C \Delta T = \text{Heat flow} \times \text{time} = \text{Total Heating Energy}$

If the heat flow, sample mass, and absorption (heat transfer) are the same for both liquids, then

$$C_w \Delta T_w = C_s \Delta T_s$$

The heat flow and total heating are kept constant by using the same source for the same amount of time. If the heat transfer mechanisms for the two liquids are about the same, with insignificant differences in convective and conductive characteristics, then any differences in temperature increase are a direct measure of the specific heat capacity,  $C$ .



## 7.0 MEASUREMENT OF THE DENSITY OF SIMULATED TISSUE

### 7.1 Test Purpose

Before a batch of simulated tissue can be used for SAR measurements, its density must be determined to ensure that the simulated tissue was properly made and will simulate the desired human characteristics.

### 7.2 References

- Introduction to Physics for Scientists and Engineers, F.J. Bueche, 1980, McGraw-Hill Book Company, New York.
- “Electromagnetic Energy Exposure of Simulated Users of Portable Cellular Telephones”, Q. Balzano, O.M. Garay, and T.J. Manning, 1995, IEEE Transactions on Vehicular Technology, 44:390-403.
- “Broadband Calibration of E-Field Probes in Lossy Media”, K. Meier, M. Burkhardt, T. Schmid, and N. Kuster, 1996, IEEE Transactions on Microwave Theory and Techniques, 44:1954-1962.

### 7.3 Definition

**density:** a measure of the mass contained in a unit volume of the substance.

### 7.4 Standard Value

For brain tissue simulating liquids the density should be  $1.28 \text{ g/cm}^3 \pm 2\%$ .

### 7.5 Test Equipment

Description	Manufacturer	Model
Weigh Scale	Pennsylvania Scale Co.	2 kg
Graduated Cylinder	BOMEX	2000 ml



## 7.6 Test Procedure

1. Obtain a clean, dry graduated cylinder.
2. Place the cylinder on a scale and record its mass when empty.
3. Pour a sample of the simulated tissue into the cylinder.
4. Weigh the cylinder with the simulated tissue to obtain a total mass.
5. Subtract the cylinder mass from the total mass to obtain the mass of the tissue.
6. Record the tissue volume and mass in the table below.
7. Clean and dry the cylinder and repeat this process for a total of 10 trials.

## 7.7 Test Data Table

- 1 The volume and mass can be recorded in the following table:

<b>Mixture Frequency (MHz):</b>		<b>Date:</b>	
<b>Empty Measuring Container Mass (g):</b>			
<b>Trial</b>	<b>Volume (ml)</b>	<b>Mass (g)</b>	<b>Density (g/ml)</b>
1			
2			
3			
4			
5			
6			
7			
8			
9			
10			



## 7.8 Test Data Analysis

The data are used to determine the density of the simulated tissue by means of the following relation:

$$r = \frac{m - m_c}{v}$$

where  $\rho$  is the density ( $\text{g/cm}^3$ , Note:  $1 \text{ g/cm}^3 = 1000 \text{ kg/m}^3$ )  
 $m$  is the mass of the container filled with simulated tissue (g)  
 $m_c$  is the mass of the empty container (g)  
 $v$  is the volume of the simulated tissue ( $1 \text{ cm}^3 \equiv 1 \text{ ml}$ ).

---

# Spectrum Sciences Institute RF Dosimetry Research Board

---



Attention: all comments, suggestions, and inquiries should be addressed to  
Dr. Jack J. Wojcik or Dr. Paul G. Cardinal  
51 Spectrum Way., Nepean Ontario, K2R 1E6, Canada. tel.:(613)820-2730, fax:(613)820-4161  
e-mail: inform@spectrum-sciences.org

## **Positioning and Scanning Requirements**

### **SSI/DRB-TP-D01-034**



### **PART of SAR Measurements Requirements**

#### **SSI/DRB-TP-D01-030**

***DRAFT***

***Prepared jointly with:***

***APREL***  
*Laboratories*

**Near Field Measurements Laboratory**

March 1998

- NOTICE -

This draft was prepared to assist the Dosimetry Research Board of SPECTRUM SCIENCES INSTITUTE and specifically the Working Group on SAR Measurements. It is submitted as a basis for discussion only, and is not binding on APREL Inc. Subsequent study may lead to revisions of the document, both in numerical values and/or form, and after continuing study and analysis, APREL Inc. specifically reserves the right to add to, or amend the content of this contribution.



## TABLE OF CONTENTS

<b>1.0</b>	<b>Introduction</b>	<b>3</b>
<b>1.1</b>	<b>Purpose and Scope of the Standard</b>	<b>3</b>
<b>1.2</b>	<b>Test Facilities</b>	<b>3</b>
<b>1.3</b>	<b>Test Personnel</b>	<b>3</b>
<b>1.5</b>	<b>Standard Environmental Conditions</b>	<b>4</b>
<b>2.0</b>	<b>Background</b>	<b>4</b>
<b>2.1</b>	<b>Positioning of the Device Under Test (DUT)</b>	<b>4</b>
<b>2.2</b>	<b>Area Scanning</b>	<b>5</b>
<b>2.3</b>	<b>Zoom Scanning and 1g or 10g Averaging</b>	<b>6</b>
<b>3.0</b>	<b>References</b>	<b>7</b>
<b>4.0</b>	<b>Device Under Test (DUT) Positioning Procedures</b>	<b>8</b>
<b>4.1</b>	<b>DUTs Held Against the Ear</b>	<b>8</b>
<b>4.2</b>	<b>DUTs Held In Front of the Mouth (e.g. PPT radio like handset)</b>	<b>11</b>
<b>4.3</b>	<b>DUTs Used in the Hand Away from the Body (e.g. point of sale device)</b>	<b>11</b>
<b>4.4</b>	<b>DUTs Carried Next to the Body</b>	<b>12</b>
<b>5.0</b>	<b>Area Scanning Procedure</b>	<b>13</b>
<b>5.1</b>	<b>Definition</b>	<b>13</b>
<b>5.2</b>	<b>Test Equipment</b>	<b>14</b>
<b>5.3</b>	<b>Test Procedure</b>	<b>14</b>
<b>6.0</b>	<b>Zoom Scanning And 1 Or 10 Gram Averaging Procedures</b>	<b>16</b>
<b>6.1</b>	<b>Definitions</b>	<b>17</b>
<b>6.2</b>	<b>Zoom Scanning Procedure</b>	<b>17</b>
<b>6.3</b>	<b>1g and 10 g averaging</b>	<b>18</b>



## 1.0 INTRODUCTION

### 1.1 Purpose and Scope of the Standard

The purpose of this document is to standardize the portable transmitter positioning and E-field scanning inside the phantom that simulates parts of the human body for Specific Absorption Rate (SAR) measurements.

This Standard defines:

- the methodology and procedures to be followed in the laboratory to setup the portable handset
- the procedure to define the E-field area scanning
- the procedure to determine zoom scan to derive the 1 or 10 gram average SAR.

This Standard is part of a Certification Program Methodology as described in a separate document entitled "SSI/DBR TP-D01-030, Specific Absorption Rate (SAR) Standard For Portable Telecommunications Devices, March 1998". SSI/DBR TP-D01-034 contains specific criteria that must be met for SAR certification.

### 1.2 Test Facilities

All calibration work as described in this Standard shall be performed at an ISO/IEC Guide 25 accredited laboratory.

### 1.3 Test Personnel

Personnel performing the calibration will be experienced in relevant measurements (eg physical properties or RF characteristics) and supervised by a person proficient in SAR measurements.

### 1.4 Test Equipment

The required test equipment, hardware and software, is identified in each individual procedure. Equipment may be substituted or updated from time to time. Should this





occur, such change shall be noted in the test report. Equipment shall be calibrated to standards traceable to International Standards.

## 1.5 Standard Environmental Conditions

All measurements and calibration should be performed under normal laboratory conditions for physical properties and electrical characteristics as stipulated by ISO/IEC Guide 25. The nominal temperature for physical property measurements and for electrical characterization are 20°C and 23°C, respectively.

## 2.0 BACKGROUND

### 2.1 Positioning of the Device Under Test (DUT)

In positioning a portable communication device with respect to the simulated human body, we are interested in obtaining the worst coupling between the device and the head while ensuring that such a position is a reasonable approximation of a common usage position.

SAR inside the head is predominantly attributable to the H-fields produced by the currents inside the handset or along its antenna. These H-fields cause currents in the boundary of the phantom, which in turn induce E-fields within the simulated tissue. These E-fields give rise to the measured SAR within the portion of the simulated human body being exposed.

The exact sources of the highest H-fields within the phone are not usually known. However, the antenna feedpoint area is normally the prime suspect. The coupling of a high current producing area with the simulated tissue causes deposition of energy into the simulated tissue as well as modifications to characteristics of the transmitting source itself.

If a large plastic case, with various internal components, is coupled to simulated tissue, and the coupled area does not carry current, or the current carrying area is remote (in relative terms), there will be no significant SAR deposited in the tissue, nor will there be any significant change of the source.

The purpose of various standards (e.g. CENELEC), or industry practices, is to position the handset with respect to an arbitrary shape of the head in such a way that the coupling between the tissue and the current source is the strongest.

The Universal Head-arm (UniHead) is engineered in such a way that the maximum coupling can be found without maneuvering the handset through various positions. This is



achieved by placing the handset at a constant position and a constant displacement relative to the phantom. Thus the SAR generating area, wherever it is in the handset, will always couple to the simulated tissue. This makes maneuvering of the handset (3 angles, left-right ear, 3 point contact, etc.) redundant.

The commonly accepted distance between the tissue boundary and the handset is 6 mm (2 mm shell + 4 mm for the compressed human ear).

In the practice of measuring SAR a plastic layer forms part of the space between the tissue boundary and the phone. The dielectric and conductive characteristics of this layer of plastic are relatively close to those of air in comparison to those of the simulated tissue. It is believed in today's practice that this layer does not have any other role than creating a distance between the device surface and the tissue boundary. However, an investigation of the measuring uncertainty produced by the presence of plastic is not very complete. In the UniHead, for the sake of precision and repeatability, the only layer which is introduced is the one that is needed to contain the tissue simulation and no additional arbitrarily shaped space is introduced.

In the research carried out by APREL Laboratories for Spectrum Sciences Institute, much of which was witnessed by industry, it was demonstrated that when the current was flowing in the parts of the phone closer to the head than the hand simulation, there was essentially no impact on the SAR distribution or the peak SAR value (< 10% difference). However, in instances when the current carrying components are closer to the hand than to the head, the impact on the handset performance and peak SAR value is significant, and should not be neglected.

In the instances where there is a requirement for measurement without the hand, the Universal Head is engineered in such a way that the simulated tissue can be easily removed from the hand simulation and thus becomes a positioning bracket with marginal quantities of plastic with a marginal impact on the radiated fields.

## 2.2 Area Scanning

A head model is usually placed on its side, which allows a handset to be placed underneath the head to facilitate field measurements. The field probe is inserted into the liquid from above and measurements can then be made on the inside surface of the head next to the phone. SAR measurements usually start with a coarse measurement at 1-2 cm resolution where the electric field probe is scanned throughout the entire region of tissues next to the handset and its antenna. This provides a SAR distribution near the surface of the phantom, closest to the phone, where the approximate location of the peak SAR can be identified.



### 2.3 Zoom Scanning and 1g or 10g Averaging

A smaller region centered on the peak SAR location is then scanned with a 1-5 mm finer resolution to determine the one-gram average SAR. The measurements obtained from this fine resolution scan are averaged over a 1-cm<sup>3</sup> volume in the shape of a cube to determine the one-gram average SAR. A 10-cm<sup>3</sup> volume for a ten-gram average SAR is appropriate for the extremities in North America, or for all requirements in Europe or Japan. The average density of most high water-content tissues is about 1020-1040 kg/m<sup>3</sup>, which requires the tissue volume to be about 1 cm long on each side. For a 10-gram average SAR a tissue volume of 2 cm long on each side can be used produce a conservative overestimate of the SAR value (the actual side length should be 2.125 cm). The number of measurement points required in the fine scan to provide accurate one-gram average SAR is dependent on the field gradients at the peak SAR location. In smooth gradients, the one-gram average SAR can be correctly predicted with only a few measurement points. When steep field gradients exist, many measurement points evenly distributed within a cubic centimeter of the tissue material may be required to correctly predict the one-gram average SAR. To overcome this problem, a curve-fitting process may be applied to the measured data to allow more points to be used in the average.

The measurements provided by electric field probe normally do not correspond to the location at the tip of a probe because the detectors are located behind the tip. For homogeneous phantoms, the peak field values are at the surface of the phantom, but the detectors of the probe are generally 2.5-7.0 mm behind the tip of the probe. Therefore the field measurements must be extrapolated to the surface of the phantom to compensate for field attenuation introduced by this offset distance. This can be done by taking a number of measurement points in a straight line perpendicular to the phantom surface at the peak SAR location and applying a curve-fitting process for the extrapolation.

If measurements in the immediate vicinity of the phantom surface are included in the extrapolation routine, the boundary effect of the probe must be considered. The boundary effect results in an increased sensitivity of the probe and is caused by the interaction of the field disturbance around the probe with the boundary. The strength of the overestimation depends on the probe dimensions, the probe distance from the surface, the boundary curvature, the probe angle to the surface and the field decay in the solution. If the boundary effect is not completely compensated for in the software, a positive error offset (overestimation) of the spatial peak SAR will occur. An alternative approach is to dismiss all measurements near the surface and extrapolate over a longer distance. This will eliminate the offset error, but largely increase the error due to extrapolation uncertainty.



The actually assessed cube is a surface adapted "cube" as opposed to a geometrical cube. This is partially due to the missing definition of the cube placement and partially due to the mechanics of the data acquisition systems which operate in a Cartesian coordinate system.

### 3.0 REFERENCES

- SAR Measurement Operational Guide, O.M. Garay and Q. Balzano, 1995, Motorola, Florida Corporate Electromagnetics Research Laboratory, Fort Lauderdale, Florida.
- "Electromagnetic Energy Exposure of Simulated Users of Portable Cellular Telephones", Q. Balzano, O.M. Garay, and T.J. Manning, 1995, IEEE Transactions on Vehicular Technology, 44:390-403.
- "The Dependence of EM Energy Absorption upon Human Head Modeling at 900MHz", V. Hombach, K. Meier, M. Burkhardt, E. Kuhn and N. Kuster, 1996, IEEE Transactions on Microwave Theory and Techniques, 44:1865-1873.
- "Robust Setup for Precise Calibration of E-Field Probes in Tissue Simulating Liquids at Mobile Communications Frequencies", K. Pokovic, T. Schmid and Niels Kuster, 1997, ICECOM '97, Dubrovnik, October 15-17, pp.120-124.
- "The Dependence of EM Energy Absorption upon Human Head Modeling at 1800 MHz", K. Meier, R. Kastle, V. Hombach, R. Tay and N. Kuster, 1997, IEEE Transactions on Microwave Theory and Techniques, 45:2058-2062.
- "Differences in Energy Absorption between Heads of Adults and Children in the Near Field of Sources", F. Schonborn, M. Burkhardt and N. Kuster, 1998, Health Physics, 74:160-168.
- Evaluating Compliance with FCC Guidelines for Human Exposure to Radiofrequency Electromagnetic Fields: Additional Information for Evaluating Compliance of Mobile and Portable Devices with FCC Limits for Human Exposure to Radiofrequency Emissions, K. Chan, R.F. Cleveland, Jr., and D.L. Means, 1997, OET Bulletin 65 (97-01), Supplement C (97-01), FCC, Office of Engineering and Technology.
- CENELEC, prES 59005, "Considerations for human exposure to electromagnetic fields from mobile telecommunication equipment (MTE) in the frequency range 30MHz - 6 Ghz", December 1997



## 4.0 DEVICE UNDER TEST (DUT) POSITIONING PROCEDURES

### 4.1 DUTs Held Against the Ear

1. Select the simulated tissue appropriate for the type of tissue being tested, and the operating frequency of the DUT, and fill the Universal Head-arm (UniHead) with it.
2. Allow sufficient time for all air bubbles to escape before performing a scan.
3. Lift up the measurement slide (see Figure 4.1) and place the DUT face-up under it. Lower the measurement slide so that it rests on the DUT and record the height on the scale to the left of the slide using the lower edge of the slide as reference.
4. Add 4 mm to this height to account for the spacing provided by a compressed human ear and record the value.



Figure 4.1

5. Put the DUT into test mode at the highest rated power, and operating on either the maximum performance frequency or one of the low, middle and high channels.
6. Loosen the bolt (on the right side of the UniHead stand) holding the hand simulator support, using the orange finger tab, and lower whole structure. Pull out the sliding support, using its orange finger tab (Figure 4.2), so that the DUT simulator is easily accessible.
7. Position the DUT on top of the hand simulator, butting the top of it up against the reference pin, and centered within the locating lines (see Figure 4.3).



8. Use a rubber band (elastic) to hold the DUT in place making use of the two notches on either side of the hand simulator (see Figure 4.2).

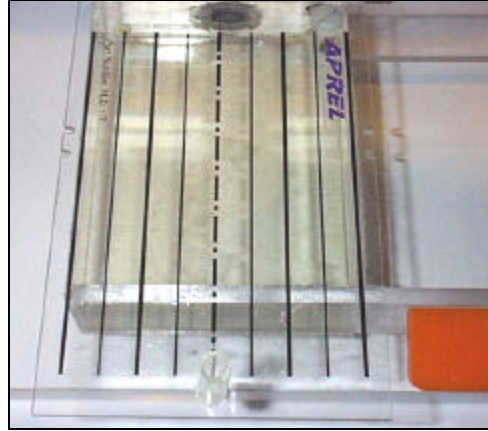
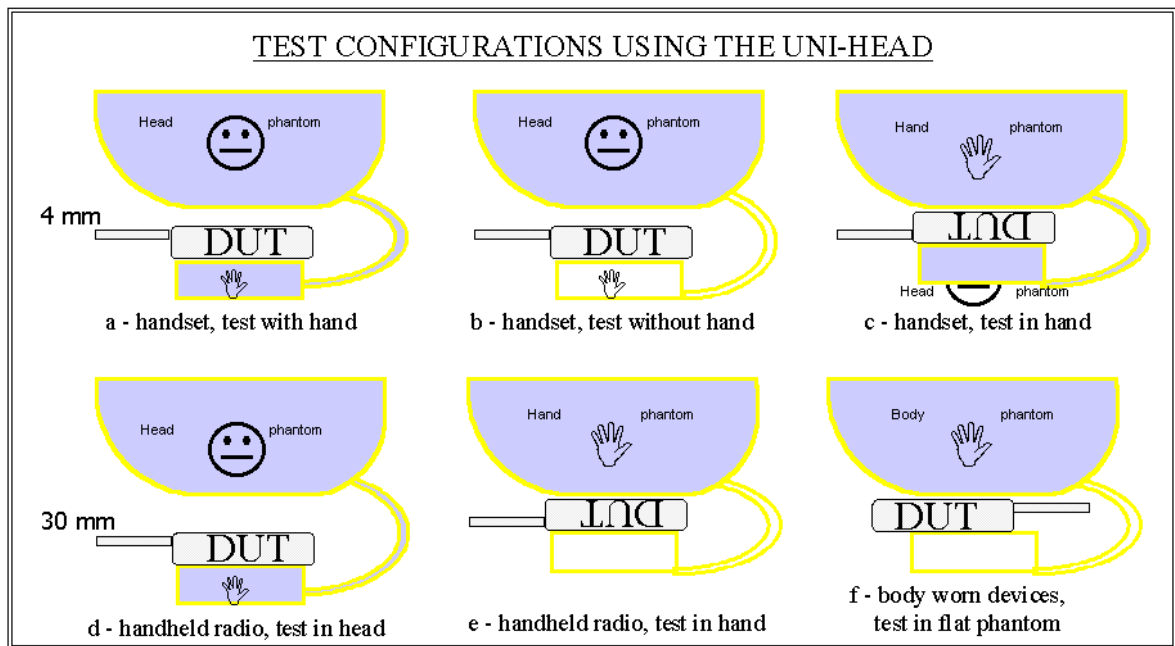

Figure 4.2

9. Slide the hand simulator back under the UniHead until it stops against the mechanical stop. This will locate the device properly in a horizontal plane in relation to the head simulator.
10. Slide the hand simulator support up until the top or the support lines up with the height determined in step 4 above.
11. Looking from above the device should be lined up as shown in Figure 4.4



Comments and inquiries should be addressed to:

RF Dosimetry Research Board (DRB)  
Spectrum Sciences Institute  
51 Spectrum Way, Nepean, Ontario, Canada K2R 1E6  
Tel. (613) 820-6471 Fax (613) 820-4161  
e-mail: [inform@spectrum-sciences.org](mailto:inform@spectrum-sciences.org)

Ref: Project U404-7-0016 -1997

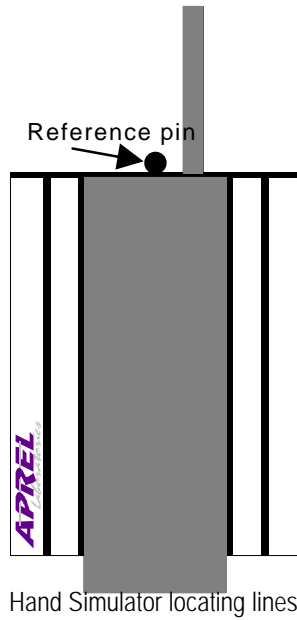

Figure 4.3

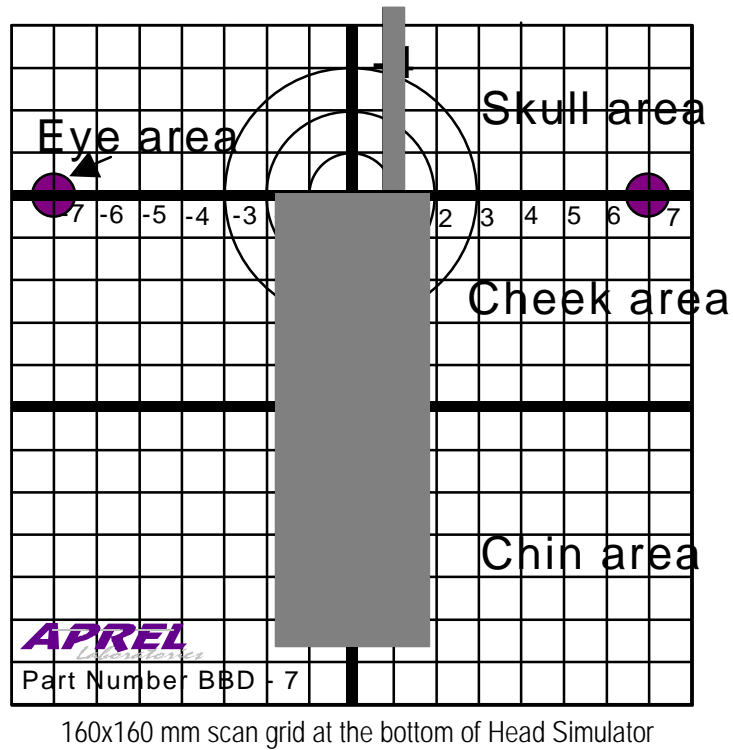

Figure 4.4

Comments and inquiries should be addressed to:

RF Dosimetry Research Board (DRB)  
Spectrum Sciences Institute  
51 Spectrum Way, Nepean, Ontario, Canada K2R 1E6  
Tel. (613) 820-6471 Fax (613) 820-4161  
e-mail: [inform@spectrum-sciences.org](mailto:inform@spectrum-sciences.org)

Ref: Project U404-7-0016 -1997



## 4.2 DUTs Held In Front of the Mouth (e.g. PPT radio like handset)

1. Perform steps 1 through 9 as in Section 4.1.
2. Lower the device by 30 mm to account for the spacing provided by a human nose.
3. Looking from above the device should be lined up as shown in Figure 4.4

## 4.3 DUTs Used in the Hand Away from the Body (e.g. point of sale device)

The head simulator can be used as a substitute for the hand when performing a SAR evaluation for a device that is normally held in the hand but is not used in the vicinity of the head or the body. In this case the hand simulator should be empty (i.e. it will not contain simulated tissue) and will act strictly as a support to hold the DUT. The hand substitute (i.e. the head simulator) should be filled with simulated muscle tissue.

1. Close the valve between the head simulator and the hand simulator. This will ensure that the hand simulator remains empty and will serve only as a support for the DUT (if the hand is full of simulated tissue from a previous procedure, disconnect and empty it).
2. Select the simulated tissue appropriate for the type of tissue being tested, and the operating frequency of the DUT, and fill the head simulator portion of the UniHead with it.
3. Allow sufficient time for all air bubbles to escape before performing a scan.
4. Lift up the measurement slide (see Figure 4.1) and place the DUT face-up under it. Lower the measurement slide so that it rests on the DUT and record the height on the scale to the left of the slide using the lower edge of the slide as reference.
5. Add 30 mm to this height to account for the spacing provided by a human nose and record the value.
6. Put the DUT into test mode at the highest rated power, and operating on either the maximum performance frequency or one of the low, middle and high channels.
7. Loosen the bolt (on the right side of the UniHead stand) holding the hand simulator support, using the orange finger tab, and lower whole structure. Pull out the sliding support, using its orange finger tab (Figure 4.2), so that the DUT simulator is easily accessible.
8. Position the DUT upside-down on top of the hand simulator, butting the top of it up against the reference pin, and centered within the locating lines (see Figure 4.3).
9. Use a rubber band (elastic) to hold the DUT in place making use of the two notches on either side of the hand simulator (see Figure 4.2).
10. Slide the hand simulator back under the UniHead until it stops against the mechanical stop. This will locate the device properly in a horizontal plane in relation to the head simulator.





11. Slide the hand simulator support up until the top or the support lines up with the height determined in step 5 above.
12. Looking from above the device should be lined up as shown in Figure 4.4

#### 4.4 DUTs Carried Next to the Body

The head simulator can be used as a substitute for the body, or thighs, when performing a SAR evaluation for a device that is normally positioned against the body. These devices include backpack, shoulder strap or belt mounted portable communication gear as well as those installed into laptop computers. In this case the hand simulator should be empty (i.e. it will not contain simulated tissue) and will act strictly as a support to hold the DUT. The body or thigh substitute (i.e. the head simulator) should be filled with simulated muscle tissue.

- 1 Close the valve between the head simulator and the hand simulator. This will ensure that the hand simulator remains empty and will serve only as a support for the DUT (if the hand is full of simulated tissue from a previous procedure, disconnect and empty it).
- 2 Select the simulated tissue appropriate for the type of tissue being tested, and the operating frequency of the DUT, and fill the head simulator portion of the UniHead with it.
- 3 Allow sufficient time for all air bubbles to escape before performing a scan.
- 4 Lift up the measurement slide (see Figure 4.1) and place the DUT face-up under it. Lower the measurement slide so that it rests on the DUT and record the height on the scale to the left of the slide using the lower edge of the slide as reference.
- 5 Add 30 mm to this height to account for the spacing provided by a human nose and record the value.
- 6 Put the DUT into test mode at the highest rated power, and operating on either the maximum performance frequency or one of the low, middle and high channels.
- 7 Loosen the bolt (on the right side of the UniHead stand) holding the hand simulator support, using the orange finger tab, and lower whole structure. Pull out the sliding support, using its orange finger tab (Figure 4.2), so that the DUT simulator is easily accessible.
- 8 Position the DUT upside-down on top of the hand simulator, butting the top of it up against the reference pin, and centered within the locating lines (see Figure 4.3).
- 9 Use a rubber band (elastic) to hold the DUT in place making use of the two notches on either side of the hand simulator (see Figure 4.2).
- 10 Slide the hand simulator back under the UniHead until it stops against the mechanical stop. This will locate the device properly in a horizontal plane in relation to the head simulator.



- 11 Slide the hand simulator support up until the top or the support lines up with the height determined in step 5 above.
- 12 Looking from above the device should be lined up as shown in Figure 4.4

## 5.0 AREA SCANNING PROCEDURE

Once the DUT is properly positioned with respect to the UniHead, a coarse scan of the electric field generated by the DUT can be made using a miniature isotropic E-field probe, throughout the entire region of tissues next to the handset and its antenna. This provides a SAR distribution near the surface of the phantom, closest to the phone, where the approximate location of the peak SAR can be identified.

### 5.1 Definition

**area scan:** measurement of the electric field inside the simulated tissue, over an array of positions following the inside surface of the phantom, and covering the entire region. The resolution of the scan is usually 1-3 cm.



## 5.2 Test Equipment

Table 5.1

Description	Manufacturer	Model
Articulated Robot Arm	CRS Robotics	A255
Robotic System Controller	CRS Robotics	C500
Phantom	APREL	UniHead
Phantom support fixture	APREL	various
Synthetic Tissue Mixture	APREL	SSI/DRB-TP-D01-033
Miniature E-field probe	Narda	8021B
Probe support fixture	APREL	N/A
Computer	Northern Micro	Pentium 75
Software	CRS Robotics	RobComm
Software	Microsoft	Office 97 Pro
Software	APREL	SAR Measurement
Data acquisition card	ComputerBoards	CIO-DAS08-PGH
Miscellaneous Cables	N/A	N/A

## 5.3 Test Procedure

1. Ensure that the UniHead is level.
2. Start RobComm, open FLATSAR.TXT, and start Dashboard. Use the mouse to push RESET button and then the GO button. This will place the miniature E-field probe above the UniHead in its start position.
3. Close Dashboard and put RobComm in Terminal mode.
4. Type STATUS and check that the tool transform in effect is REF25.
5. Move the probe to (x,y) coordinates (12,8) on the grid (see Figure 5.1).
6. Adjust the probe height so that it is 2.5 mm above the phantom surface.
7. Set the position BEGIN to this probe location.
8. Move the probe 12 cm along the x-axis. If the probe does not follow the grid line, move the probe back 12 cm, and then readjust the UniHeads position and try again by moving the probe 16 cm along the y-axis. If the probe still does not follow a

Comments and inquiries should be addressed to:

RF Dosimetry Research Board (DRB)  
Spectrum Sciences Institute  
51 Spectrum Way, Nepean, Ontario, Canada K2R 1E6  
Tel. (613) 820-6471 Fax (613) 820-4161  
e-mail: inform@spectrum-sciences.org

Ref: Project U404-7-0016 -1997



grid line, move the probe back 16 cm along the y-axis, and readjust the UniHead position again.

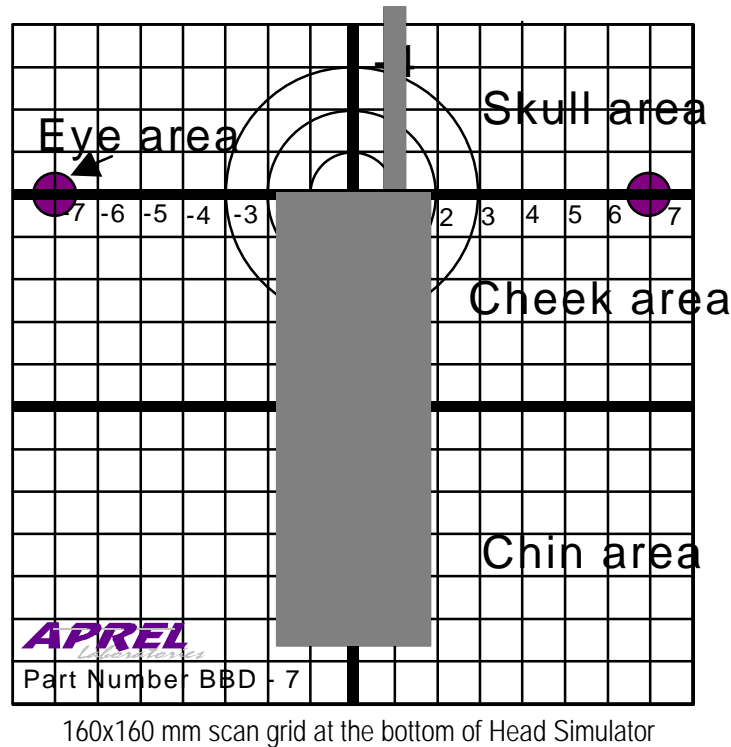

Figure 5.1

9. Repeat step 7 until the robot's x- and y-axes coincide with the UniHead's.
10. Exit Terminal Mode and restart Dashboard. Use the mouse to push RESET button and then the GO button. This will place the miniature E-field probe above the UniHead in its start position.
11. From the Application Menu select FLATSAR.XLS. Microsoft Excel will open this file automatically.
12. Enter a name for the spreadsheet that will be created with the measurement data. The file name should include the DUT model number, measurement height, "area" and date.
13. Select the scan resolution of 10 mm. The default scan resolutions available are 10 mm and 5 mm. The default x and y spans are 16 cm and 8 cm, for 10 and 5 mm resolutions, respectively. (The x-axis is along the DUT and y-axis is across the DUT). If other scan resolutions or spans are desired, then the Visual Basic code will have to be edited.
14. Start the scan by pushing the ACQUIRE DATA button with the mouse pointer. The application will now run automatically and acquire the data.



15. Once the application has stopped, quit the application. Reenter Terminal mode and change the tool transform to REF125. Type STATUS and verify that the tool transform in effect is REF125.
16. Repeat steps 10-14. This creates a spreadsheet with a second scan data set 1 cm further away from the surface of the phantom.
17. Once the application has stopped, quit the application. Print out the surface and contour plots for each of the 2 spreadsheets.

## **6.0 ZOOM SCANNING AND 1 OR 10 GRAM AVERAGING PROCEDURES**

A smaller region centered on the peak SAR location identified with the area scan is then scanned with a 5 mm finer resolution to determine the one-gram, or ten-gram, average SAR. The measurements obtained from this fine resolution scan are averaged over a 1-cm<sup>3</sup> volume in the shape of a cube to determine the one-gram average SAR, or an 8-cm<sup>3</sup> volume for a ten-gram average SAR.

The spatial peak SAR is calculated from a large number of values (27); measured in a volume of 80 x 80 x 10 mm around the maximum local SAR (867 values in total). A numerical procedure then searches for the 1-cm<sup>3</sup> or 8-cm<sup>3</sup> cube with the highest average SAR within this data array.

An exponential extrapolation to the surface is then applied based on measurements made on 4 or 5 grid locations, at 2.5 mm intervals between 2.5 and 17.5 mm from the inside surface of the phantom.

An exponential extrapolated to the surface of the phantom is then applied to compensate for the field attenuation introduced by the 7 mm offset distance between the E-field detectors to the tip of the probe and the 2.5 mm distance from the lowest measurements to the surface. The extrapolation is calculated from 5 sets of data taken in a straight line perpendicular to the phantom surface at the peak SAR location and applying an exponential curve-fitting routine for the extrapolation. The location of these sets is at the center of the peak SAR cube and the 4 next nearest (x,y) coordinates.



## 6.1 Definitions

**zoom scan:** measurement of the electric field inside the simulated tissue, over an array of positions following the inside surface of the phantom, and covering a region in the vicinity of the peak(s) identified with an area scan. The resolution of the scan is usually 1-5 mm.

**1-g average:** the peak energy absorption rate averaged over the 1 g of tissue in the shape of a cube. Since the average density of simulated muscle or brain tissue is 1020-1040 kg/m<sup>3</sup> this ideally corresponds to a side length of 0.987 – 0.993 cm. In practice, 1 cm sides are normally used.

**10-g average:** the peak energy absorption rate averaged over the 10 g of tissue in the shape of a cube. Since the average density of simulated muscle or brain tissue is 1020-1040 kg/m<sup>3</sup> this ideally corresponds to a side length of 2.126 - 2.140 cm. In practice, 2 cm sides are normally used.

## 6.2 Zoom Scanning Procedure

1. Review the plots obtained from the area scan and determine one set of grid coordinates ( $x_m$ ,  $y_m$ ) that is closest to the maximum SAR value measured on each of the two sets of area scans. The maximums on the two levels are usually at the same coordinates, or with a cm or so of each other.
2. Close Dashboard, put RobComm in Terminal mode and change the tool transform to REF25. Type STATUS and verify that the tool transform in effect is REF25.
3. Move the probe to (x,y) coordinates ( $x_m+4\text{cm}$ ,  $y_m+4\text{cm}$ ) on the grid (see Figure 5.1).
4. Set the position BEGIN to this probe location.
5. Exit Terminal Mode and restart Dashboard. Use the mouse to push RESET button and then the GO button. This will place the miniature E-field probe above the UniHead in its start position.
6. From the Application Menu select FLATSAR.XLS. Microsoft Excel will open this file automatically.
7. Enter a name for the spreadsheet that will be created with the measurement data. The file name should include the DUT model number, measurement height, “zoom” and date.
8. Select the scan resolution of 5 mm. The default x and y spans are 8 cm. If other scan resolutions or spans are desired, then the Visual Basic code will have to be edited.
9. Start the scan by pushing the ACQUIRE DATA button with the mouse pointer. The application will now run automatically and acquire the data.



10. Once the application has stopped, quit the application. Reenter Terminal mode and change the tool transform to REF75. Type STATUS and verify that the tool transform in effect is REF75.
11. Repeat steps 5-9. This create a spreadsheet with a second scan data set 0.5 cm further away from the surface of the phantom.
12. Once the application has stopped, quit the application. Reenter Terminal mode and change the tool transform to REF125. Type STATUS and verify that the tool transform in effect is REF125.
13. Repeat steps 5-9. This creates another spreadsheet with a third scan data set an additional 0.5 cm further away from the surface of the phantom. Once the application has stopped, quit the application.
14. Print out the surface and contour plots for each of the 3 spreadsheets.

### 6.3 1g and 10 g averaging

1. Open the PEAK SAR.XLS template and resave it with a new name that should include the DUT model number, “peak SAR“ and date
2. Modify the formulas in the 1g and 10 g averaging sheets to gather data from the 3 zoom scan spreadsheets. A numerical procedure will then search for the 1-cm<sup>3</sup> or 8-cm<sup>3</sup> cube with the highest average SAR within this data array.
3. Note the location of the peak 1g or 10 g SAR and the (x,y) coordinates of the center and the 4 edges.
4. Use the mouse pointer to push RESET button on Dashboard and then the GO button. This will place the miniature E-field probe above the UniHead in its start position.
5. From the Application Menu select FLATSAR.XLS. Microsoft Excel will open this file automatically. Enter the name “TEMP” for the spreadsheet that will be created.
6. Use <ALT>-<TAB> to switch to back to RobComm.
7. Close Dashboard, put RobComm in Terminal mode and change the tool transform to REF25. Type STATUS and verify that the tool transform in effect is REF25.
8. Move the probe to the (x,y) coordinates corresponding to the center of the peak SAR cube.
9. Use <ALT>-<TAB> to switch to back to TEMP.XLS
10. Use the mouse pointer to push the “Single Point” button. Record the values displayed in the last 3 columns for the 3 probe sensors.
11. Use <ALT>-<TAB> to switch to back to RobComm.
12. Move the probe to the next (x,y) coordinates corresponding to the east edge of the peak SAR cube.
13. Repeat steps 9-11.
14. Move the probe to the next (x,y) coordinates corresponding to the south edge of the peak SAR cube.



15. Repeat steps 9-11.
16. Move the probe to the next (x,y) coordinates corresponding to the west edge of the peak SAR cube.
17. Repeat steps 9-11.
18. Move the probe to the next (x,y) coordinates corresponding to the north edge of the peak SAR cube.
19. Repeat steps 9-11.
20. Use <ALT>-<TAB> to switch back to RobComm.
21. Change the tool transform to REF50. Type STATUS and verify that the tool transform in effect is REF50.
22. Repeat steps 8 through 20.
23. Change the tool transform to REF50. Type STATUS and verify that the tool transform in effect is REF50.
24. Repeat steps 8 through 20.
25. Change the tool transform to REF75. Type STATUS and verify that the tool transform in effect is REF75.
26. Repeat steps 8 through 20.
27. Change the tool transform to REF100. Type STATUS and verify that the tool transform in effect is REF100.
28. Repeat steps 8 through 20.
29. Change the tool transform to REF125. Type STATUS and verify that the tool transform in effect is REF125.
30. Repeat steps 8 through 20.
31. Change the tool transform to REF150. Type STATUS and verify that the tool transform in effect is REF150.
32. Repeat steps 8 through 20.
33. Change the tool transform to REF175. Type STATUS and verify that the tool transform in effect is REF175.
34. Repeat steps 8 through 20.
35. Quit TEMP.XLS.
36. Enter the data obtained above into sheets Sensor1, 2 and 3 of the spreadsheet created in step 1.
37. A numerical procedure will process the data create a chart of the 5 exponential curve such as shown in Figure 6.1. The average of the exponential coefficients is then used to extrapolate the 1 g or 10 g peak SAR to the surface.



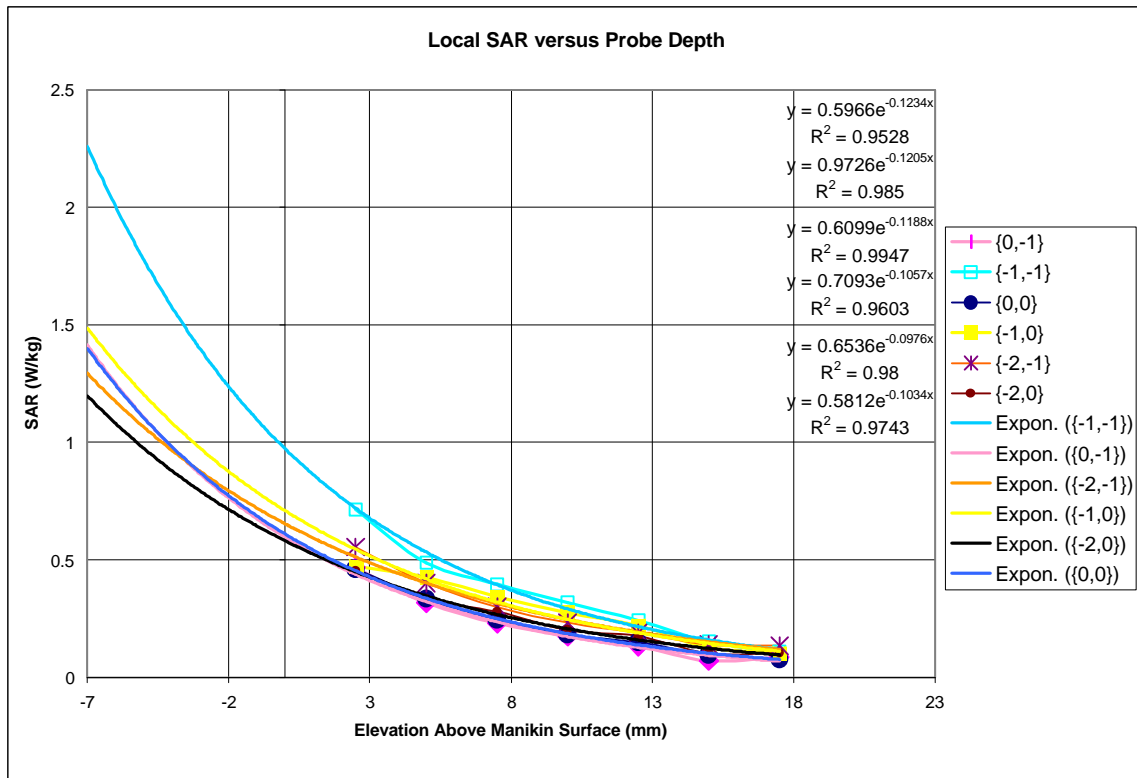

Figure 6.1