



**Intermec**



**User's Manual**



**CV60 Vehicle Mount  
Computer**

Intermec Technologies Corporation

Corporate Headquarters	Cedar Rapids Technical Communications Department
6001 36th Ave. W.	550 Second Street SE
Everett, WA 98203	Cedar Rapids, IA 52401
U.S.A.	U.S.A.

[www.intermec.com](http://www.intermec.com)

The information contained herein is proprietary and is provided solely for the purpose of allowing customers to operate and service Intermec-manufactured equipment and is not to be released, reproduced, or used for any other purpose without written permission of Intermec.

Information and specifications contained in this document are subject to change without prior notice and do not represent a commitment on the part of Intermec Technologies Corporation.

© 2003 by Intermec Technologies Corporation. All rights reserved.

The word Intermec, the Intermec logo, Norand, ArciTech, CrossBar, Data Collection Browser, dcBrowser, Duratherm, EasyCoder, EasyLAN, Enterprise Wireless LAN, EZBuilder, Fingerprint, i-gistics, INCA (under license), InterDriver, Intermec Printer Network Manager, IRL, JANUS, LabelShop, Mobile Framework, MobileLAN, Nor\*Ware, Pen\*Key, Precision Print, PrintSet, RoutePower, TE 2000, Trakker Antares, UAP, Universal Access Point, and Virtual Wedge are either trademarks or registered trademarks of Intermec Technologies Corporation.

Throughout this manual, trademarked names may be used. Rather than put a trademark (™ or ®) symbol in every occurrence of a trademarked name, we state that we are using the names only in an editorial fashion, and to the benefit of the trademark owner, with no intention of infringement.

There are U.S. and foreign patents pending.

Wi-Fi is a registered certification mark of the Wi-Fi Alliance.

Microsoft, Windows, and the Windows logo are registered trademarks of Microsoft Corporation in the United States and/or other countries.

Bluetooth is a trademark of Bluetooth SIG, Inc., U.S.A.

# Contents

Before You Begin .....	ix
Safety Summary .....	ix
Do not repair or adjust alone .....	ix
First aid .....	ix
Resuscitation .....	ix
Energized equipment .....	ix
Safety Icons .....	x
Global Services and Support .....	xi
Warranty Information .....	xi
Web Support .....	xi
Telephone Support .....	xi
Who Should Read this Manual? .....	xii
Related Documents .....	xii

## **1** Introduction ..... 1

Introducing the CV60 Vehicle Mount Computer .....	2
Features .....	3
Unpacking the CV60 Vehicle Mount Computer .....	4
Accessories for the CV60 Vehicle Mount Computer .....	5
Locating the Data Collection PC Connectors .....	6
Card/Drive Slot .....	8
Hard Drive/Memory Location .....	9
SODIMM Memory Slot .....	9
AC-DC Power Supply .....	10
DC-DC Power Supplies .....	10
Maintenance .....	11
Cleaning .....	11
Daily Checks .....	11
Specifications .....	12
Size .....	12
Environmental .....	12
Processor/Memory/Storage .....	12
System Software .....	12
Power System .....	13
Wired Connectivity .....	13
Wireless Connectivity .....	13
Peripherals/Accessories .....	13
FCC Notice .....	14

<b>2</b>	<b>Operation</b> .....	15
	Startup Requirements .....	16
	Startup Sequence .....	16
	Options .....	17
	Hard Drive Installation .....	17
	Solid State Drive Installation .....	18
	SODIMM Slot .....	18
	Card/Drive Slot .....	19
	PC Card Installation .....	19
	Radio Installation Options .....	20
	802.11 Radio .....	20
	Wireless Printing Radio Module .....	20
	PicoLink Radio .....	21
	Setting up the Cordless Scanner .....	21
	External Antenna Connection .....	22
	Patch Antenna .....	22
	Desktop Mounting Options .....	23
	Removing PC Cards .....	23
	Start-Up .....	23
	Restart (or, "Reboot") .....	24
	Warm Restart .....	24
	Cold Restart .....	24
	Setting up for Data Collection .....	25
	Device Configuration .....	25

**3 PhoenixBIOS Setup Utility** ..... 27

    General Information ..... 28

    Main ..... 29

        System Time ..... 29

        System Date ..... 29

        Primary Master ..... 30

            Auto ..... 30

            None ..... 30

            CD-ROM ..... 30

            IDE Removable ..... 30

            ATAPI Removable ..... 31

            Other ATAPI ..... 31

            User ..... 32

        Secondary Master ..... 32

            Auto ..... 32

            None ..... 32

            CD-ROM ..... 32

            IDE Removable ..... 33

            ATAPI Removable ..... 33

            Other ATAPI ..... 34

            User ..... 34

        Memory Cache ..... 35

            Memory Cache ..... 35

            Cache System/Video BIOS Areas ..... 35

            Cache Base 0–512k, 512k–640k, Extended Memory Area ..... 35

        Boot Features ..... 35

            Summary Screen ..... 35

            Boot-Time Diagnostic Screen ..... 35

            QuickBoot Mode ..... 35

    Advanced ..... 36

        Advanced Chipset Control ..... 36

            Video Boot Type ..... 36

            Enable Memory Gap ..... 36

            Frequency Ratio ..... 36

        I/O Device Configuration ..... 36

            Serial Ports ..... 36

            Panel Heater ..... 36

            Picolink ..... 36

        Legacy USB Support ..... 37

        Reset Configuration Data ..... 37

        FirstWare Authentication Level ..... 37

        PC Card Boot Support ..... 37

    Security ..... 38

        Set Supervisor Password ..... 38

    Boot ..... 39

## Contents

Exit .....	40
Exit Saving Changes .....	40
Exit Discarding Changes .....	40
Load Setup Defaults .....	40
Discard Changes .....	40
Save Changes .....	40
Reflash Procedure .....	41
Windows CE .....	41
Windows XP .....	41

**4 Windows Device Configurations** ..... 43

    AutoIP/DHCP ..... 44

    CV60 Settings ..... 45

        Windows CE ..... 45

            Display ..... 45

            Com Ports ..... 45

            UPS ..... 46

            System ..... 46

            Versions ..... 46

        Windows XP ..... 47

            Brightness Status ..... 47

            Device Status ..... 48

            UPS Service ..... 48

    Network Adapters ..... 49

        802.11b/g Communications ..... 49

        Wireless Printing ..... 49

            Windows CE ..... 50

            Windows XP ..... 53

        Picolink Radio ..... 54

    Stylus ..... 55

        Windows CE ..... 55

            Double-Tap ..... 55

            Calibration ..... 55

        Windows XP ..... 57

            Double-Tap ..... 57

            Calibration ..... 57

    TCP/IP ..... 60

        Windows CE ..... 60

        Windows XP ..... 61

    Tethered Scanner ..... 63

        Enabling and Disabling ..... 63

        Scanner Cabling ..... 63

        Limitations and Capabilities ..... 63

## 5 Developing and Installing Applications ..... 65

Developing Applications for the CV60 .....	66
Developing a New Application for the CV60 .....	66
Converting a Trakker Antares Application to a CV60 CE Application .....	67
Developing a Web-Based Application .....	67
Installing Applications on the CV60 .....	68
All CV60: .....	68
Installing Applications Using Wavelink Avalanche .....	68
To use Avalanche to remotely manage the CV60 .....	68
CV60 CE only: .....	68
Using ActiveSync to Install Applications .....	68
Installing ActiveSync and Establishing a Partnership .....	69
To install ActiveSync and establish a partnership .....	69
The Microsoft ActiveSync Screen .....	70
Using ActiveSync to Copy Files and Install Applications .....	70
To install an application on the CV60 CE using ActiveSync .....	70
CV60 XP/XPE: .....	71
Mapping a network drive: .....	71

## 6 Connector Pinouts ..... 73

Connectors .....	74
Connectors .....	74
COM Port Pinout .....	75
Keyboard PS/2 .....	76
Ethernet .....	77
.....	77
USB Connectors .....	78
Audio Connections .....	78
Microphone / Headphone .....	78
Power Connector Pin out .....	79



## **Before You Begin**

This section provides you with safety information, technical support information, and sources for additional product information.

### **Safety Summary**

Your safety is extremely important. Read and follow all warnings and cautions in this document before handling and operating Intermec equipment. You can be seriously injured, and equipment and data can be damaged if you do not follow the safety warnings and cautions.

#### **Do not repair or adjust alone**

Do not repair or adjust energized equipment alone under any circumstances. Someone capable of providing first aid must always be present for your safety.

#### **First aid**

Always obtain first aid or medical attention immediately after an injury. Never neglect an injury, no matter how slight it seems.

#### **Resuscitation**

Begin resuscitation immediately if someone is injured and stops breathing. Any delay could result in death. To work on or near high voltage, you should be familiar with approved industrial first aid methods.

#### **Energized equipment**

Never work on energized equipment unless authorized by a responsible authority. Energized electrical equipment is dangerous. Electrical shock from energized equipment can cause death. If you must perform authorized emergency work on energized equipment, be sure that you comply strictly with approved safety regulations.

## **Safety Icons**

This section explains how to identify and understand dangers, warnings, cautions, and notes that are in this manual. You may also see icons that tell you when to follow ESD procedures and when to take special precautions for handling optical parts.



A warning alerts you of an operating procedure, practice, condition, or statement that must be strictly observed to avoid death or serious injury to the persons working on the equipment.

**Avertissement:** Un avertissement vous avertit d'une procédure de fonctionnement, d'une méthode, d'un état ou d'un rapport qui doit être strictement respecté pour éviter l'occurrence de mort ou de blessures graves aux personnes manipulant l'équipement.



A caution alerts you to an operating procedure, practice, condition, or statement that must be strictly observed to prevent equipment damage or destruction, or corruption or loss of data.

**Attention:** Une précaution vous avertit d'une procédure de fonctionnement, d'une méthode, d'un état ou d'un rapport qui doit être strictement respecté pour empêcher l'endommagement ou la destruction de l'équipement, ou l'altération ou la perte de données.



**Note:** Notes either provide extra information about a topic or contain special instructions for handling a particular condition or set of circumstances.

## Global Services and Support

### Warranty Information

To understand the warranty for your Intermec product, visit the Intermec web site at <http://www.intermec.com> and click **Service & Support**. The Intermec Global Sales & Service page appears. From the **Service & Support** menu, move your pointer over **Support**, and then click **Warranty**.

Disclaimer of warranties: The sample code included in this document is presented for reference only. The code does not necessarily represent complete, tested programs. The code is provided “as is with all faults.” All warranties are expressly disclaimed, including the implied warranties of merchantability and fitness for a particular purpose.

### Web Support

Visit the Intermec web site at <http://www.intermec.com> to download our current manuals in PDF format. To order printed versions of the Intermec manuals, contact your local Intermec representative or distributor.

Visit the Intermec technical knowledge base (Knowledge Central) at <http://intermec.custhelp.com> to review technical information or to request technical support for your Intermec product.

### Telephone Support

These services are available from Intermec Technologies Corporation.

<b>Service</b>	<b>Description</b>	<b>In the U.S.A. and Canada call 1-800-755-5505 and choose this option</b>
Factory Repair and On-site Repair	Request a return authorization number for authorized service center repair, or request an on-site repair technician.	1
Technical Support	Get technical support on your Intermec product.	2
Service Contract Status	Inquire about an existing contract, renew a contract, or ask invoicing questions.	3
Schedule Site Surveys or Installations	Schedule a site survey, or request a product or system installation.	4
Ordering Products	Talk to sales administration, place an order, or check the status of your order.	5

Outside the U.S.A. and Canada, contact your local Intermec representative. To search for your local representative, from the Intermec web site, click **Contact**.

## **Who Should Read this Manual?**

This guide provides you with information about the features of the CV60 Vehicle Mount Computer, and how to install, configure, operate, maintain, and troubleshoot it.

Before you install and configure the CV60, you should be familiar with Windows XP or Windows CE, your network and general networking terms, such as IP address and network naming conventions.

## **Related Documents**

<b>Document Title</b>	<b>Part Number</b>
<i>CV60 QuickStart Guide</i>	962-054-072
<i>Intermec Computer Command Reference</i>	073529
<i>CV60 Vehicle Power Supply Installation Guide</i>	962-054-076

The Intermec web site at <http://www.intermec.com> contains many of our documents that you can download in PDF format.

To order printed versions of the Intermec manuals, contact your local Intermec representative or distributor.

### Patent Information

Product is covered by one or more of the following patents:

4,455,523; 5,627,360; 4,553,081; 5,657,317; 4,709,202; 5,671,436;  
4,845,419; 5,684,290; 4,961,043; 5,777,309; 5,195,183; 5,793,604;  
5,216,233; 5,805,807; 5,218,187; 5,818,027; 5,218,188; 5,821,523;  
5,227,614; 5,828,052; 5,241,488; 5,831,819; 5,278,487; 5,834,753;  
5,322,991; 5,841,121; 5,331,136; 5,844,222; 5,331,580; 5,883,492;  
5,349,678; 5,883,493; 5,397,885; 5,886,338; 5,371,858; 5,889,386;  
5,373,478; 5,898,162; 5,410,141; 5,969,328; 5,488,575; 5,986,435;  
5,500,516; 6,075,340; 5,504,367; 6,109,528; 5,508,599; 6,158,661;  
5,530,619; 6,234,395; 5,567,925; 6,244,512; 5,568,645; 6,330,975;  
5,592,512; 6,431,451; 5,598,007; 6,497,368; 5,617,343; 6,538,413.

There may be other U.S. and foreign patents pending.



---

# 1 Introduction

This chapter outlines the features and specifications of the CV60 Vehicle-Mount Computer.

## Introducing the CV60 Vehicle-Mount Computer

The CV60 Vehicle-Mount Computer is a rugged PC computing device consisting of a 12.1-inch color, SVGA LCD display with touch screen for data input and menu navigation.

Communication options include connectivity through two RS-232 serial ports, USB (host), and Ethernet. Wireless network connectivity is enabled through multiple LAN radio options.

Peripherals supported include PS/2 keyboard, USB mouse, external headset, wired RS-232 scanners, wireless scanners via proprietary wireless base station, wireless printers, and USB data recovery drives.

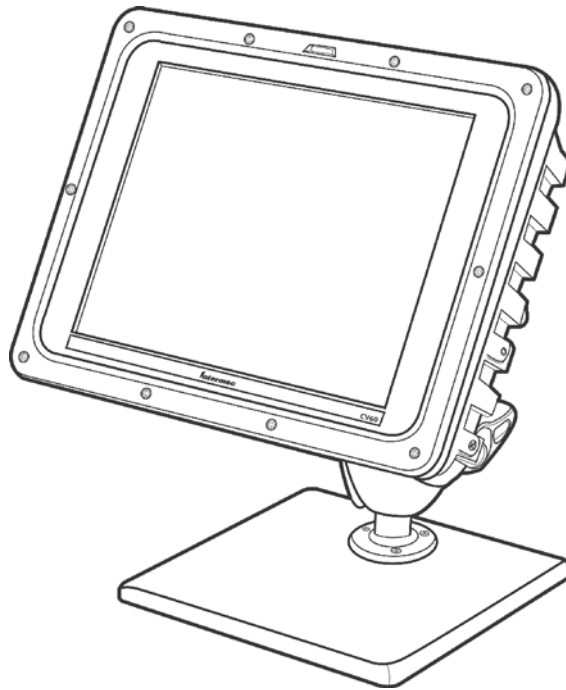

*CV60 Vehicle-Mount Computer*

## **Features**

- Wi-Fi certified for interoperability with other 802.11g wireless LAN devices.
- Operating Systems: Windows CE. NET (4.2), Windows XP Embedded, Windows XP Professional Edition
- Intel® Pentium® III 800 MHz embedded
- 128MB base SDRAM memory 256/384 MB optional upgrade
- Display: 12.1” TFT 800\*600 SVGA
- Resistive touch panel
- Rotating or solid-state IDE hard drive
- Solid-State PCMCIA Type II flash storage card
- Wireless Printing for cordless accessories and printing
- Integrated antennas
- Recovery CD provided by Intermec
- External USB boot support
- External headset jack
- Speaker
- Locking I/O connectors
- Heater option for low temperature operation

## Unpacking the CV60 Vehicle-Mount Computer

When you remove the data collection PC from its box, save the box and shipping material in case you need to ship or store the data collection PC. Check the contents of the box against the invoice for completeness and contact your local Intermec service representative if there is a problem.

The CV60 shipping box contains:

- CV60 Vehicle-Mount Computer (P/N 245-232-101)
- Documentation (P/N 962-054-072)

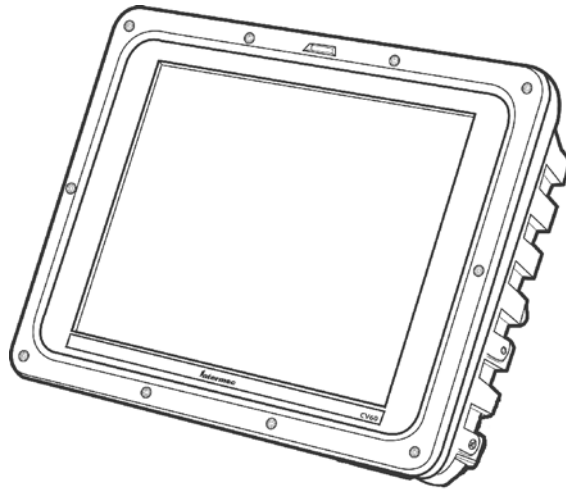

The CV60 display allows user input and menu navigation via resistive touchscreen. The touch panel is field replaceable.

Refer to the *CV60 Touch Panel Replacement Instructions* (P/N 962-054-078) for information on replacing the touch panel.



## Accessories for the CV60 Vehicle-Mount Computer

You can use these accessories (sold and ordered separately) with the CV60 Vehicle-Mount Computer:

- **AC power supply** Use the AC power supply (P/N 851-070-001) to power the data collection PC when it is in the desktop mounting stand. The AC power supply is only for use in clean, dry, office-like environments with temperatures from 10° C to 40° C (50° F to 104° F). The power supply comes with a North American power cord. If you are using the data collection PC outside North America, you need to purchase the appropriate power cord for your local power source.
- **DC power supply** There are two DC power supply kits that you can use to power the data collection PC when it is mounted to a vehicle:
- **Heater option kit (15-96 VDC)** (P/N 203-665-002) or (12-72VDC) (P/N 203-669-002).
- **Desktop mounting stand** The desktop mounting stand (P/N 203-664-001) attaches to your data collection PC to provide a stable desktop platform. The desktop mounting stand is useful when you have the data collection PC connected to your PC to develop applications.
- **Keyboard** The alphanumeric keyboard is backlit for view in low lighting conditions (P/N 850-537-002) and supports a subset of the available keys on a PC-AT keyboard. The CV60 ships with a keyboard overlay to match the application or language you ordered: English, Western European, or one of the three TE 2000 terminal emulation options. You must use the keyboard accessory with the Intermec TE 2000 terminal emulation applications.
- **Scanner cables** Use the scanner cables to connect a scanning device such as the 1550 and 1551 and 1553 laser scanners.
- **Keyboard tray mount** The keyboard tray (P/N G9A-KB000-01) is an orderable option which allows mounting the CV60 keyboard directly to the device.
- **Remote keyboard mounting kit** (P/N 203-564-001)

## Locating the Data Collection PC Connectors

You connect power, a keyboard, scanner, and RS-232 serial devices to the data collection PC ports that are located on the bottom panel of the CV60.

### Connectors

The On/Off switch and all connectors are located on the bottom of the CV60.

These include a power connector, two standard serial I/O connectors (COM1 and COM2), a USB keyboard (USB) connector, and a network (NET) connector.

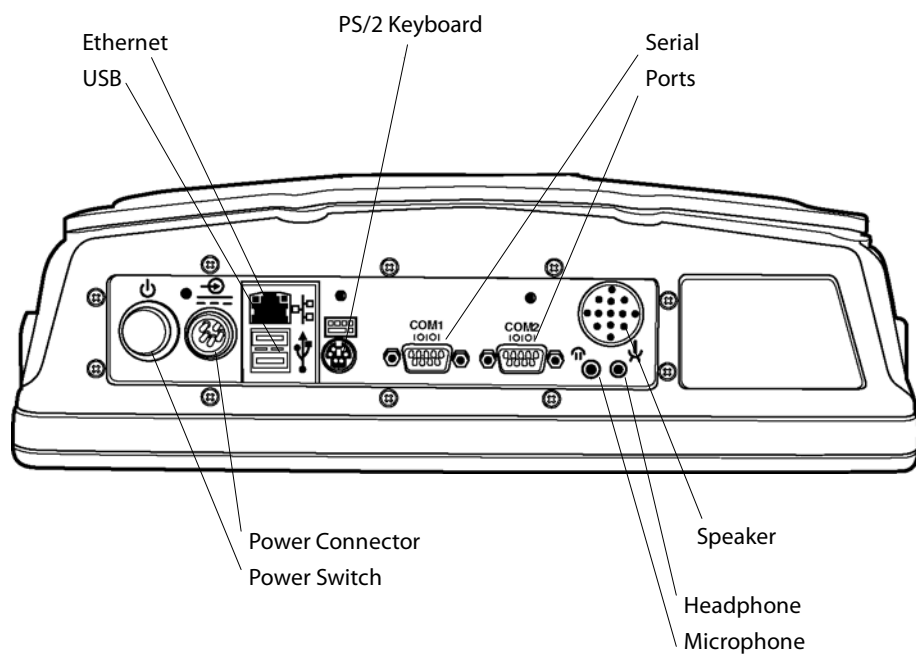

### Speaker

A speaker is provided to allow standard PC sounds, as well as business audio playback and record.

### Microphone

This 2.5 mm connector accepts an external microphone.

### USB Serial Port

The USB serial port accommodates an external USB standard mouse and keyboard. Other USB devices which do not have locking connectors can be used, provided the CV60 is used only as a fixed mount terminal.

### DC Power Input

This is a 5-pin circular power connector with a locking collar.

A regulated +12 volt power supply/converter is required.

### PS/2 Keyboard

This is a standard keyboard connector for use with PS/2-type keyboards.

### On/Off Switch

This switch is located on the bottom of the device next to the DC power input connector.



**Note:** ALWAYS perform a proper system (or Windows) shut-down before shutting the computer OFF.

### COM1, COM2 (Serial Ports)

Each port has its own address and a 9-pin male connector to attach RS-232 serial devices. COM ports can provide 5 volts dc to support a decoding type tethered scanner.



**Note:** Picolink uses the COM2 serial port, so you have COM1 left for scanner or serial connection use. CV60 computers with the Picolink radio option installed will have a cover plate over the COM2 serial port.

### Headphone

This 3.5 mm connector accepts an external headphone.

### Network Connection (NET)

The CV60 Vehicle-Mount Computer has Ethernet (10BASE-T, RJ-45 jack) on board.



**Caution:** The Lithium-ion (Li-Ion) backup battery is not user-replaceable. Refer to the “*Before You Begin*” section of this user guide for information on where to send your CV60 Vehicle-Mount Computer for service and warranty repairs.

## Card/Drive Slot

Remove the radome cover to access the PCMCIA card/drive slot. When reinstalling the cover, carefully route the antenna cables near the slot to avoid damage.

### PC Card Slot (PCMCIA)

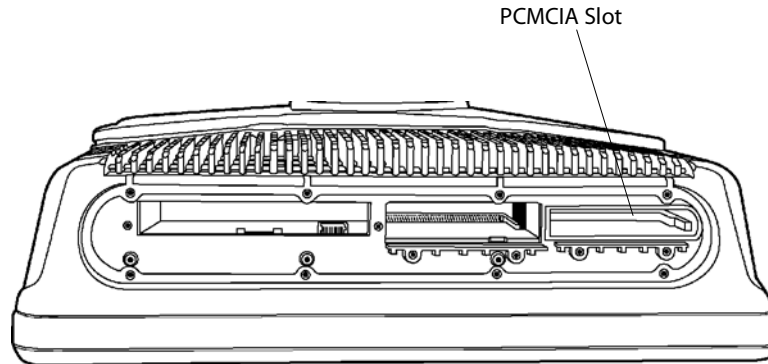

CV60 Top View (Radome Cover Removed)

This user-accessible slot is for PC Card devices. The 68-pin slot can accommodate a Type I or Type II device.



**Note:** Use spinning media for fixed-mount applications only.



**Warning:** Both edges of PC cards must be in the correct grooves in the drive to avoid damage to the card or to the computer. Do NOT force PC cards into their respective slots.

## Hard Drive/Memory Location

Remove the rear cover to access the hard drive/memory slot. When reinstalling the cover, take care not to drop screws or other metallic objects into the compartment.

### Hard Drive Location

This user-accessible compartment is for the hard drive, mounting bracket and SODIMM memory slot.

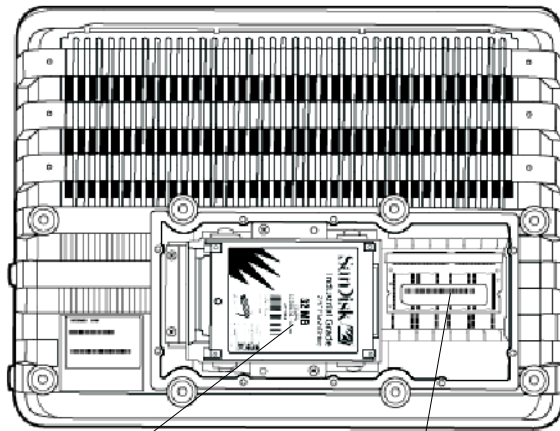

Hard drive and bracket

SODIMM Memory Slot

## SODIMM Memory Slot

The SODIMM slot (Single Outline Dual Inline Memory Module) allows upgrading the base memory from 128MB to 384MB with an Intermec approved SDRAM card.

## AC-DC Power Supply



**Note:** The AC power supply shown below does NOT have an On/Off switch. To disable power to a fixed-mount CV60, use the On/Off switch on the computer itself or unplug the AC power cable from the wall outlet.

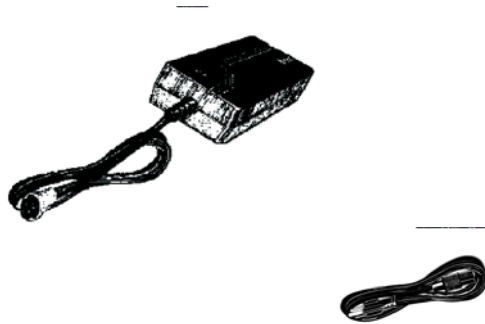

*AC Power Supply with U.S. Power Cord*

## DC-DC Power Supplies



**Warning:** Make sure you have the correct power converter for your application. See Specifications for input voltage ranges.

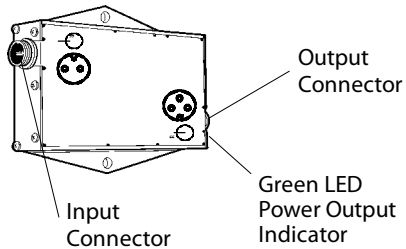

*P/N 851-041-001*

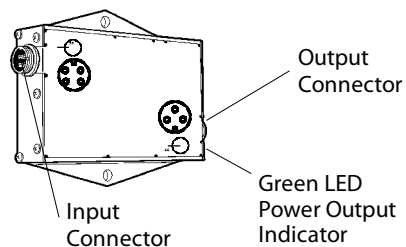

*P/N 851-040-001*

## Maintenance

Your terminal requires very little maintenance. Clean the terminal and the display periodically, and perform the daily checks listed below. If a failure message appears on the display, the computer may need to be sent to an authorized service facility for repair or adjustment.

## Cleaning

A recommended cleaner for the exterior of the CV60 Vehicle-Mount Computer display is MICRO-CLEAN II Cleaner, made by Foresight International, Inc., 4887 F Street, Omaha, Nebraska 68127-0205 (phone: 1-800-637-1344).



**Caution: Do not pour any cleaner directly on the display.**



**Caution: Do NOT use a water-based cleaner on the display.**



**Caution: Use ethanol-based cleaners ONLY on the display.**



**Note:** Keep the display area clean and free of dust, dirt, grime, or smudges. Failure to do so can result in unreliable touch entries. Use a soft, lint-free cloth dampened with ethanol alcohol to remove dirt or finger smudges from the display area.

## Daily Checks

Each work day you should check to make sure that:

- All mounting knobs are tight.
- The power cable is secure.
- The scanner cable is secure.
- The keyboard cable is secure.

## Specifications

### CV60 Vehicle-Mount Computer

#### Physical/Environmental

- Weight: 5.0 kg (11.02 lbs) for base unit

#### Size

- Height: 26 cm (9.44 in)
- Width: 34 cm (13.38 in)
- Depth: 9.5 cm (3.74 in)

#### Environmental

- Recommended Operating Temperature Range (Solid State Drive):  
–20° C to 50° C (–4° to 122° F)
- Recommended Operating Temperature Range (Rotating Drive): 0° C  
to 50° C (32° to 122° F)
- Recommended Operating Temperature Range (Heater Option): –30°  
C to 50° C (–22° to 122° F)
- Recommended Storage Temperature Range: –30° C to 70° C (–22° to  
158° F)

#### Processor/Memory/Storage

- Intel P-III 800Mhz embedded processor
- 128MB base memory with upgrade to 384MB SDRAM
- 512KB FLASH.
- Removable IDE rotating media or solid state drive or PC Card solid  
state memory
- Resistive display/touch Screen
- 12.1 Inch, Color TFT 800 X 600 SVGA

#### System Software

- Windows XP, Embedded
- Windows XP Professional
- Windows CE.NET



### **Power System**

- 6-36 VDC DC/DC converter for 12 V vehicle systems
- 15-96 VDC DC/DC converter for 24-72 V vehicle systems
- Typical current consumption -
- AC/DC adapter that supports international power requirements
- Optional Uninterruptible Power Supply

### **Wired Connectivity**

- Two RS-232 ports, supporting external tethered scanners
- 2 USB host ports
- 10BaseT/100BaseT Ethernet

### **Wireless Connectivity**

- 802.11g
- Embedded wireless scanning option
- Wireless Printing radio module

### **Peripherals/Accessories**

- External alpha/numeric keyboard, PS/2
- Tethered barcode scanners
- Mounting brackets to meet a wide range of vehicles.

### **Intermec Scanners:**

Sabre (1551, 1552, 1553)

Vista (1400, 1800)

### **External Keyboards**

PS/2 interface with locking connector.

### **External mouse**

Off-the-shelf USB mouse.

## **FCC Notice**

The user(s) of this product are cautioned to use accessories and peripherals approved by Intermec Technologies Corporation. The use of accessories other than those recommended, or changes to this product that are not approved by Intermec Technologies Corporation, may void the compliance of this product and may result in the loss of the users authority to operate the equipment.

This device complies with Part 15 of the FCC Rules. Operation is subject to the following two conditions: (1) this device may not cause harmful interference, and (2) this device must accept any interference received, including interference that may cause undesired operation.

FCC regulations limit exposure to radio frequency (RF) radiation. To comply with these regulations, operators of this device and nearby persons must maintain a distance of at least 20 cm. (8 inches) from the antenna assembly. While the device is on, the operator's body and parts of the body such as eyes, hands, or head, must be 20 cm. (8 inches) or farther from the antenna assembly.

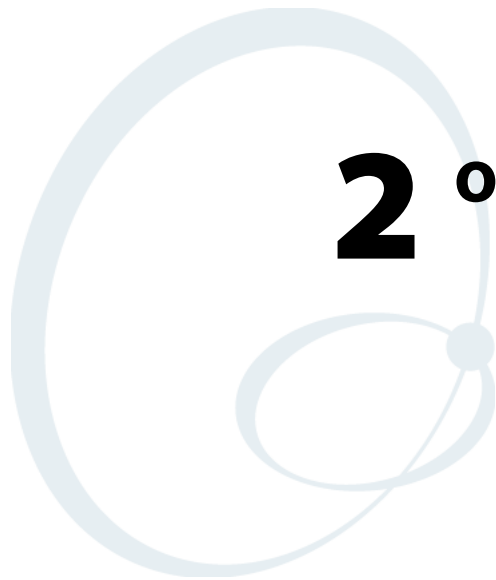

# **2** Operation

This chapter tells you how to prepare the computer for first time operation and includes instructions for attaching or installing certain options or peripheral equipment. Once the computer has successfully booted to the operating system, you may need to load an application program or data.

## Startup Requirements

Before powering up the computer for the first time, be sure it is securely mounted, that all cable connections are secure, and that the DC power input cable is firmly attached.

The computer begins its boot (start up) sequence when power is supplied to the DC power input connector and the On/Off switch is ON (press the switch briefly).

In the case of an AC-powered (fixed-mount) computer, the power supply must be connected to the computer and plugged into a wall outlet.

Vehicle mounts require that the DC-DC power converter be properly connected to the vehicle batteries and to the computer.

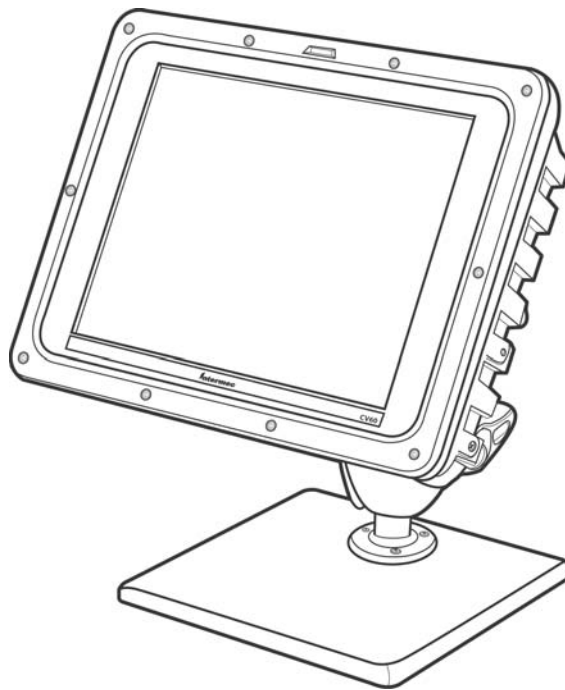

*CV60 Vehicle-Mount Computer*

## Startup Sequence

Your computer should start up after all connections have been made, power has been applied, and the On/Off switch has been pressed.

During startup, the computer (1) performs a power-on self-test, (2) runs the hardware initialization program, and (3) boots the operating system. Once the computer “boots” (starts up) successfully, you may load additional application software if this has not already been done for you. If you install a radio or other optional device, you may have to install driver software or make new system setups for the device(s) to work properly.

## Options

The CV60 can accommodate a 2.5 inch hard drive (or a solid state drive) plus one PC card. The instructions and illustrations that follow will help you perform these installations if they have not already been done.

### Hard Drive Installation

Attach the media drive to the bracket before use. Refer to the accompanying illustrations and the instructions to attach the bracket to your drive.

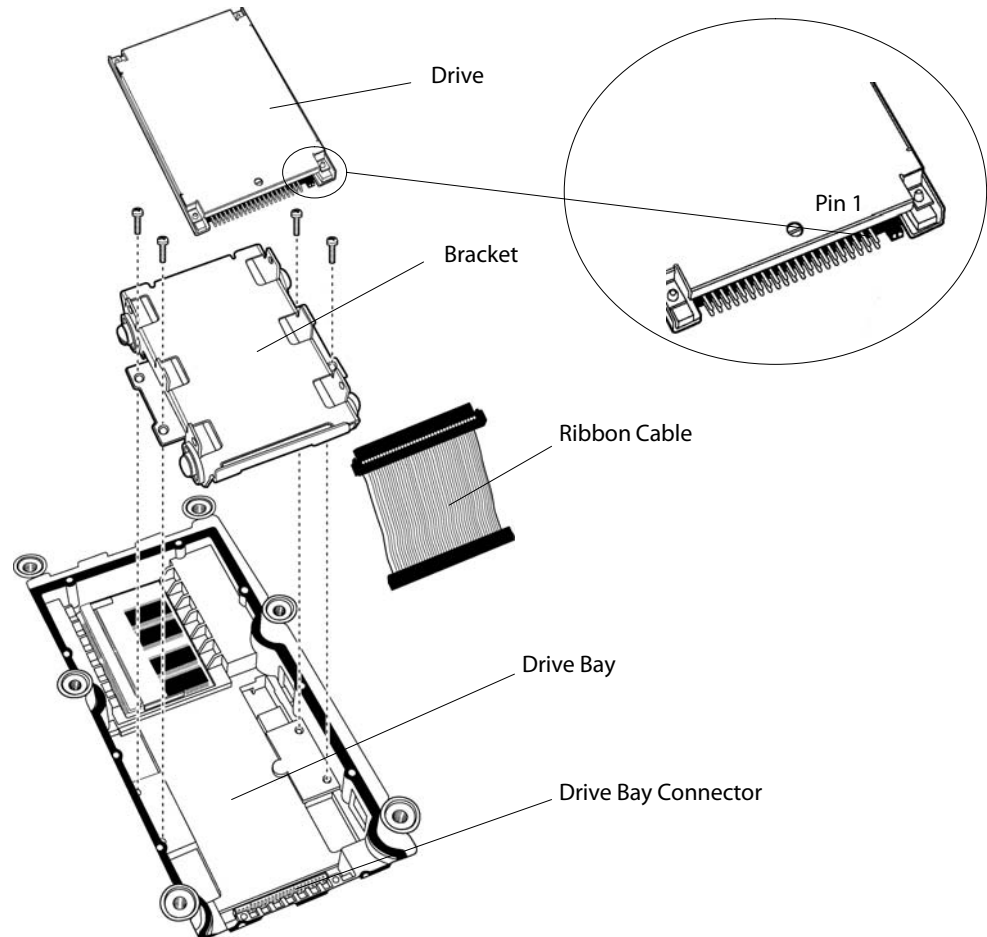

- 1 Insert the ribbon cable through the bracket.
- 2 Connect the ribbon cable to the drive, noting pin 1 position.
- 3 Align the connector-end of the drive and the bracket.
- 4 Use four screws to secure the drive to the bracket.
- 5 Connect the ribbon cable to the drive bay connector.
- 6 Use an additional four screws to secure the bracket to the drive bay.

## Solid State Drive Installation

A bracket is also required to install a solid state drive. Installation is the same as on the previous page. If your computer is set up so that a solid state drive will be the boot disk, then it requires a jumper. If your computer will boot from some other source, the solid state media drive must be jumpered.

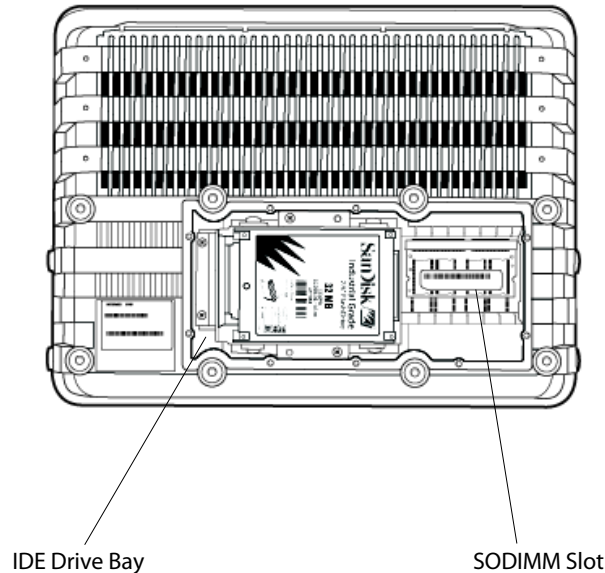

CV60 Rear View (Mounting Bracket Removed)

- 1 If the solid state media is not the boot drive, install the jumper as shown.
- 2 Place the solid state media drive in the bracket as shown.
- 3 Align the connector-end of the drive and the bracket.
- 4 Use four screws to secure the drive.
- 5 Connect the ribbon cable to the drive bay connector.
- 6 Use an additional four screws to secure the bracket to the drive bay.

## SODIMM Slot

Your CV60 contains 128MB of base memory. You can upgrade the memory to 384MB maximum via the SODIMM (Single Outline Dual Inline Memory Module) slot depending on the operating system.

Consult your Intermec Sales Representative about the memory options available for your device.



**Note:** Use of unapproved SODIMM modules may void your warranty.

## Card/Drive Slot

### PC Card Installation

The PC Card drive (“slot”) is located on the top of the computer. Use a Phillips screwdriver to remove the radome cover to access the PC card slot.

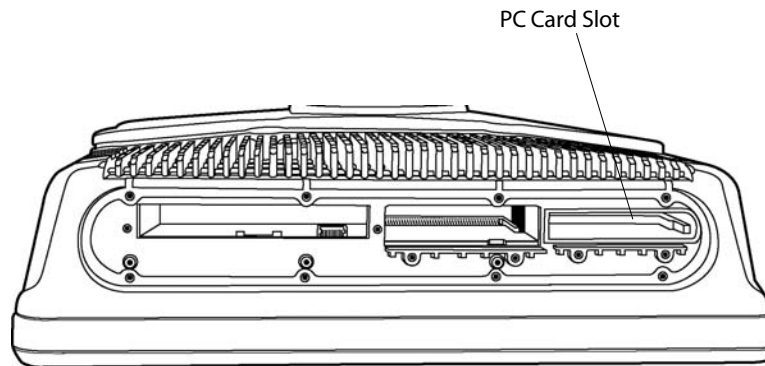

To install a PC Card, follow these steps:

- 1 Remove the radome cover.
- 2 Hold the PC Card with the connector facing into the computer.



Caution

**Caution: Do NOT force a PC card into its slot.**

- 3 Slide the PC Card into the slot.
- 4 If you encounter resistance, you may need to flip the card over and repeat Step 3. The card is fully seated when the card ejector is extended.
- 5 Use Program Manager to check the Card View icon. It will identify which slot contains a PC Card. PC Cards are identified as drive D:\ or E:\.
- 6 Reinstall the radome cover.



**Note:** Use spinning-media for fixed-mount applications only.

**Note:** The Windows CE OS option uses a PC card. It does not install in the IDE Drive Bay.



Warning

**Warning:** Both edges of PC cards must be in the correct grooves in the drive to avoid damage to the card or to the computer. Do NOT force PC cards or the IDE drive into their respective slots.

## Radio Installation Options

Your CV60 Vehicle-Mount Computer is configured for radio options at the factory.

### 802.11 Radio

The 802.11 radio is a factory-installed option. The operating system automatically installs and configures the drivers for use.

### Wireless Printing Radio Module

The Wireless Printing radio module is factory-installed. The operating system automatically installs and configures the drivers for use.

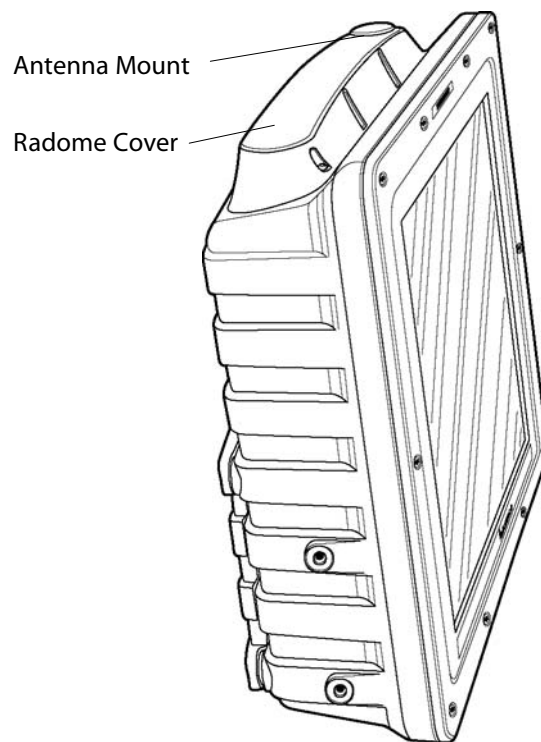



### **PicoLink™ Radio**

Intermec's PicoLink radio uses an unlicensed 2.4 GHz radio frequency (RF) hopping design that has global regulatory acceptance and interference immunity to other narrow band RF sources.

The Sabre™ 1552 wireless scanner connects by “associating” to the CV60 via wireless link for identification.

### **Setting up the Cordless Scanner**

Fully charge the cordless scanner battery before using the scanner.

Refer to the user documentation included with your cordless scanner for more information.

Scan the barcode located on the side of the CV60 to associate the scanner with its data collection device.

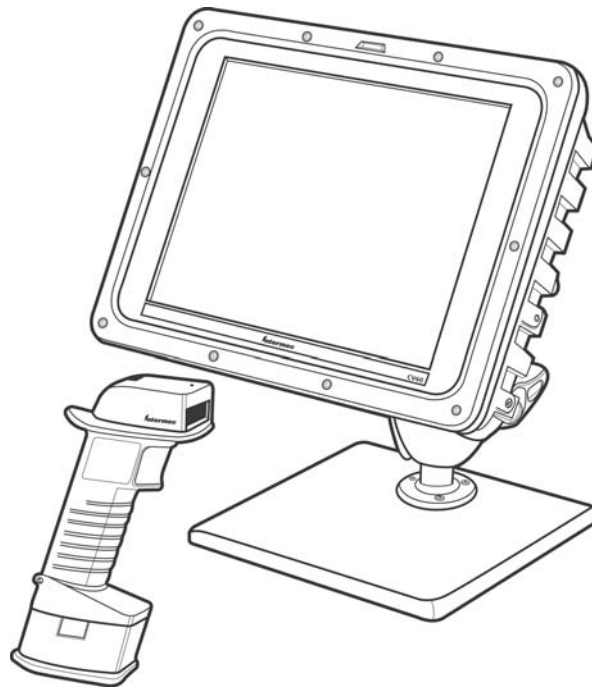

*CV60 with Sabre 1552 Cordless Scanner*

## External Antenna Connection

The external antenna mounts on the “radome assembly” on the top of the computer. Refer to the illustration below for connection information.

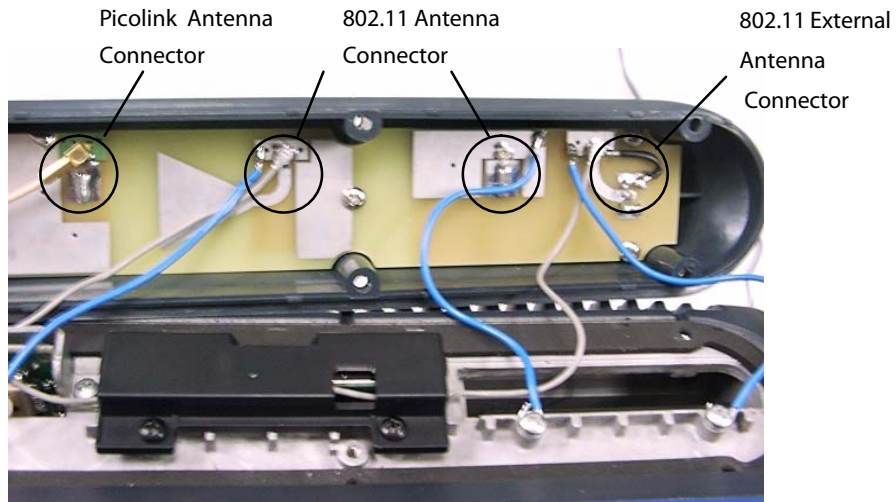

## Patch Antenna

The 2.4 GHz “patch” antenna can be mounted on a wall using either screws or small patches of adhesive-backed hook and loop fastener material. Since system performance and antenna polarization are site-dependent, a permanent mounting location and orientation may require some experimentation. In most fixed installations the antenna should be mounted initially in a vertically polarized position, with the cable from the antenna parallel to the floor/ceiling.

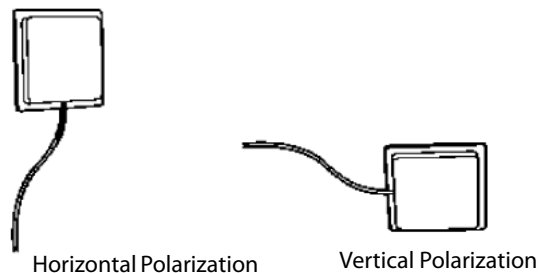

In mobile installations, best performance will be achieved by mounting the antenna flat, on top of the operator safety cage. Use at least two screws to hold the antenna in place.

## Desktop Mounting Options

This computer can be used as a stationary computer on a desktop or other work surface. An optional weighted baseplate and adjustable twin-ball pedestal are available, as shown below.

An AC power supply is required to power the computer for desktop use.

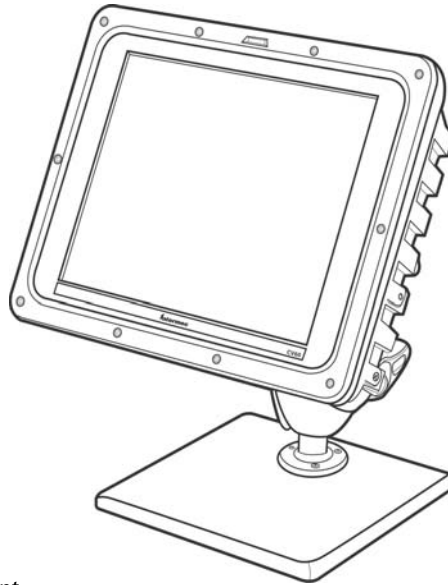

*Desktop Mount*

## Removing PC Cards

The CV60 allows the use of one PCMCIA Type II PC Card. Instructions for installing PC cards are provided earlier in this chapter.

To remove a PC Card, follow these steps:

- 1 Remove the radome cover.
- 2 Press inward on the ejector to release the PC Card.
- 3 Grasp the edge of the card to remove it.
- 4 Reinstall the radome cover that you removed in Step 1.

## Start-Up

All options and accessories must be connected or installed, and the power supply connected to the computer. It will start up (“boot”) to a factory-configured operating system when you move the On/Off switch to the ON position. If the computer does not, it may be necessary to install an operating system or application software.

Factory-configured operating systems currently available:

- Windows XP Professional
- Windows XP embedded
- Windows CE.NET

## Restart (or, “Reboot”)



**Note:** Make sure that a keyboard is attached to the CV60 *BEFORE* attempting to perform a warm restart.

If the system locks up during normal operations, you can reset it by performing either a “warm” or a “cold” restart. Use the warm restart to clear the system memory to run another program but not perform a self-test. When a warm restart does not restore operation, perform a cold restart.

### Warm Restart

If your operating system is Windows CE, exit the current application, then do the following to perform a warm restart:

- 1 Press Ctrl+Alt+Del on the keyboard to restart
- 2 Load, or reload, the desired software application.
- 3 Resume normal operation.
- 4 If your operating system is Windows XP, select **Start > Shut Down** from the Windows desktop, then select **Restart** to perform a restart or tap **Restart** on the display.

### Cold Restart

Perform a proper system shutdown, then toggle the On/Off switch on the bottom of the computer to the Off position. Wait one second, then toggle the switch back to the On position. If the On/Off switch is inaccessible, then do one of the following: For fixed-mount units, unplug the AC power supply from the wall outlet for a few seconds. Be sure to plug it back in.

For vehicle-mounted units, interrupt power to the DC/DC power converter for a few seconds.

## Setting up for Data Collection

### Device Configuration

Scanner settings for the CV60 Vehicle-Mount Computer can be configured via the Intermec Settings control panel applet. From the CV60 Vehicle-Mount Computer, tap **Start > Settings > Control Panel > Intermec Settings**.

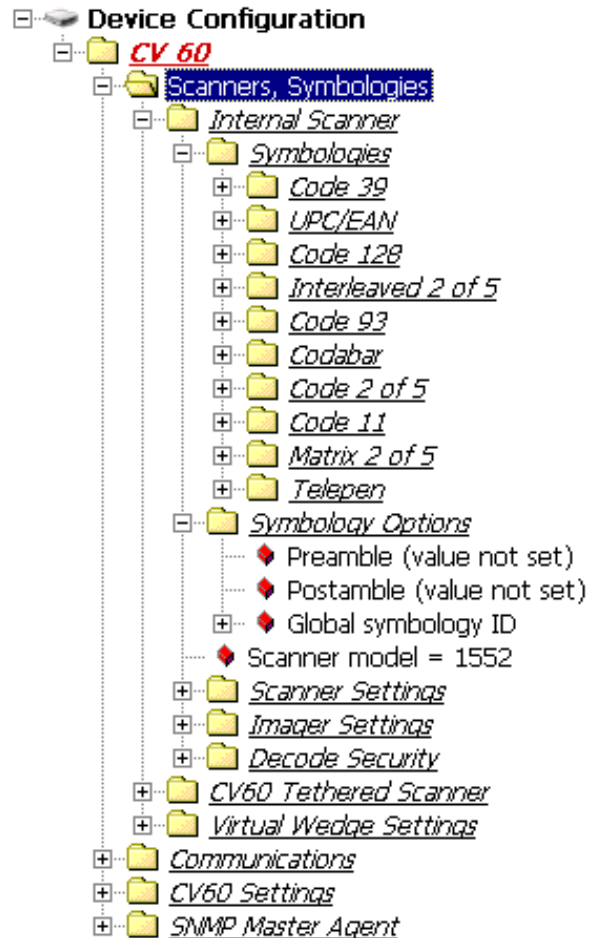

The Intermec Settings utility creates the schema and map files used for the Device Configuration tree.

For more information, see the *Intermec SDK User's Manual* and *CV60 XP SDK User's Manual*.

The SDK is part of the Intermec Developer's Library (IDL) and is available on CD (P/N 235-114-001) or as a download from the Intermec web site at [www.intermec.com](http://www.intermec.com).





# 3 PhoenixBIOS Setup Utility

A PS/2-compatible keyboard is required to configure the PhoenixBIOS Setup Utility (PSU). Turn off the CV60 Vehicle-Mount Computer before attaching the keyboard, if one is not attached already.

Reboot the CV60. Be ready to press the [F2] keys when the following prompt appears on the bottom, left side of the Intermec screen:

**Press F2 for System Utilities**

When you see this prompt, you have approximately eight seconds to press the [F2] key to enter the PSU, otherwise the computer proceeds to boot up.



**Note:** Any changes made to the PSU are not effective until they are saved and the CV60 is rebooted. Select **Exit > Exit Saving Changes** to save the changes.

Press **<Esc>** to exit any window without changes.

## General Information

This page contains the same information as given in the General Help, available when you press [F1].

Setup changes system behavior by modifying the BIOS configuration. Selecting incorrect values may cause system boot failure, if so, then press [F9] to load setup default values to recover the system.

- Press the up or down arrow keys < ↑ ↓ > to select fields in the current menu.
- Press the <Page Up> or <Page Down> keys to move to the previous or next page of scrollable menus.
- Press the <Home> or <End> keys to move to the top or bottom item of the current menu.
- Within a field, press [F5] or < - > (dash) to decrease the value, or press [F6] or < + > (plus symbol) to increase the value.
- Press the left or right arrow keys < ← / → > to move between menus.
- Press <Enter> to display more options for items marked with ►.
- Press [F9] to load factory-installed Setup Default values.
- Press [F10] to save the current settings and exit the PSU.
- Press either <Esc> or <Alt> [X] to exit the Setup or to return to the previous menu.
- Press [F1] or <Alt> [H] to display General Help information. Press [F1] or <Enter> to close the General Help screen.

PhoenixBIOS Setup Utility				
Main	Advanced	Security	Boot	Exit
System Time				[16:19:20]
System Date:				[03/02/1994]
► Primary Master				6449 MB
► Secondary Master				CD-ROM
► Memory Cache				
► Boot Features				
System Memory				640 kB
Extended Memory				31744 kB
Item Specific Help				
<Tab>, <Shift-Tab>, or <Enter> selects field				
F1 Help	↓ Select Item	-/+ Change Values		F9 Setup Defaults
ESC Exit	← Select Menu	Enter Select	► Sub-Menu	F10 Save and Exit



## Main

Use this menu to adjust the PC's date and time, primary and secondary masters, set the state of the memory cache, select boot features, and view the system memory and extended memory values. Press the up or down arrow keys < ↑ ↓ > to move the cursor between fields. Press the left or right arrow keys < ← □ □ → > to move the cursor to another menu.

## System Time

System Time is of the military hour, minute, and second format.

Press <Tab> or <Enter> to move the cursor to the right, <Shift><Tab> to move the cursor to the left. Enter the correct number, then move the cursor to the next field. The system does not recognize characters other than numbers, and only recognizes the following values:

- Hour: 0–23
- Minute: 0–59
- Second: 0–59



**Note:** If you have entered an incorrect number, move the cursor off the field, then back on, to enter the correct number,

## System Date

System Date is of the month, day, and year format.

Press <Tab> or <Enter> to move the cursor to the right, <Shift><Tab> to move the cursor to the left. Enter the correct number, then move the cursor to the next field. The system does not recognize characters other than numbers, and only recognizes the following values:

- Month: 1–12
- Day: 1–31
- Year: 1981–2099 (*defaults to 1981 if entry was not valid*)



**Note:** If you have entered an incorrect number, move the cursor off the field, then back on, to enter the correct number,

## Primary Master

Press [**Enter**] to access the Primary Master menu. Press [**Esc**] to return to the Main menu.

At the **Type** field, press the plus (+) or minus (-) key to change the value to one of the following. The value selected dictates what configurable information is presented. *Default is None.*

### Auto

Select this to automatically set the hard-disk drive installed. Press the up or down arrow keys < ↑ ↓ > to move the cursor to the following field:

- **32 Bit I/O:** Press the plus (+) or minus (-) key to enable or disable 32-bit IDE data transfers. *Default is disabled.*

### None

Select this if there is no hard-disk drive.

### CD-ROM

This indicates that a CD-ROM drive is the drive installed. Press the up or down arrow keys < ↑ ↓ > to move the cursor between the following fields:

- **Multi-Sector Transfers:** Press the plus (+) or minus (-) key to select between 2, 4, 8, or 16 sectors per block for multiple sector transfers or to disable the transfer. *Default is disabled.*
- **LBA Mode Control:** Press the plus (+) or minus (-) key to enable or disable the use of the Logical Block Addressing (LBA) in place of cylinders, heads, and sectors. *Default is disabled.*
- **32 Bit I/O** Press the plus (+) or minus (-) key to enable or disable 32-bit IDE data transfers. *Default is disabled.*
- **Transfer Mode:** Press the plus (+) or minus (-) key to select between seven methods by which to move data to and from the drive. *Default is Standard.*
- **Ultra DMA Mode:** Press the plus (+) or minus (-) key to select between six ultra DMA modes by which to move data to and from the drive or to disable the movement. *Default is Disabled.*

### IDE Removable

This indicates the removable disk drive is installed in the IDE sector. Press the up or down arrow keys < ↑ ↓ > to move the cursor between the following fields:

- **Multi-Sector Transfers:** Press the plus (+) or minus (-) key to select between 2, 4, 8, or 16 sectors per block for multiple sector transfers or to disable the transfer. *Default is disabled.*
- **LBA Mode Control:** Press the plus (+) or minus (-) key to enable or disable the use of the Logical Block Addressing (LBA) in place of cylinders, heads, and sectors. *Default is disabled.*
- **32 Bit I/O** Press the plus (+) or minus (-) key to enable or disable 32-bit IDE data transfers. *Default is disabled.*

- **Transfer Mode:** Press the plus (+) or minus (-) key to select between seven methods by which to move data to and from the drive. *Default is Standard.*
- **Ultra DMA Mode:** Press the plus (+) or minus (-) key to select between six ultra DMA modes by which to move data to and from the drive or to disable the movement. *Default is Disabled.*

### ATAPI Removable

This indicates the removable disk drive is installed in the ATAPI sector. Press the up or down arrow keys < ↑ ↓ > to move the cursor between the following fields:

- **Multi-Sector Transfers:** Press the plus (+) or minus (-) key to select between 2, 4, 8, or 16 sectors per block for multiple sector transfers or to disable the transfer. *Default is disabled.*
- **LBA Mode Control:** Press the plus (+) or minus (-) key to enable or disable the use of the Logical Block Addressing (LBA) in place of cylinders, heads, and sectors. *Default is disabled.*
- **32 Bit I/O** Press the plus (+) or minus (-) key to enable or disable 32-bit IDE data transfers. *Default is disabled.*
- **Transfer Mode:** Press the plus (+) or minus (-) key to select between seven methods by which to move data to and from the drive. *Default is Standard.*
- **Ultra DMA Mode:** Press the plus (+) or minus (-) key to select between six ultra DMA modes by which to move data to and from the drive or to disable the movement. *Default is Disabled.*

### Other ATAPI

This indicates the disk drive is installed in an ATAPI sector other than the removable sector. Press the up or down arrow keys < ↑ ↓ > to move the cursor between the following fields:

- **Multi-Sector Transfers:** Press the plus (+) or minus (-) key to select between 2, 4, 8, or 16 sectors per block for multiple sector transfers or to disable the transfer. *Default is disabled.*
- **LBA Mode Control:** Press the plus (+) or minus (-) key to enable or disable the use of the Logical Block Addressing (LBA) in place of cylinders, heads, and sectors. *Default is disabled.*
- **32 Bit I/O** Press the plus (+) or minus (-) key to enable or disable 32-bit IDE data transfers. *Default is disabled.*
- **Transfer Mode:** Press the plus (+) or minus (-) key to select between seven methods by which to move data to and from the drive. *Default is Standard.*
- **Ultra DMA Mode:** Press the plus (+) or minus (-) key to select between six ultra DMA modes by which to move data to and from the drive or to disable the movement. *Default is Disabled.*

## User

Enter the parameters of the hard-disk drive installed at this connection. Press the up or down arrow keys < ↑ ↓ > to move the cursor between the following fields:

- **Cylinders:** Enter the number of cylinders involved in this capacity, range is 0 through 65535. *Default is 0.*
- **Heads:** Enter the number of heads involved in this capacity, range is 1 through 16. *Default is 1.*
- **Sectors:** Enter the number of sectors involved in this capacity, range is 0 through 63. *Default is 0.*
- **Multi-Sector Transfers:** Press the plus (+) or minus (-) key to select between 2, 4, 8, or 16 sectors per block for multiple sector transfers or to disable the transfer. *Default is disabled.*
- **LBA Mode Control:** Press the plus (+) or minus (-) key to enable or disable the use of the Logical Block Addressing (LBA) in place of cylinders, heads, and sectors. *Default is disabled.*
- **32 Bit I/O** Press the plus (+) or minus (-) key to enable or disable 32-bit IDE data transfers. *Default is disabled.*
- **Transfer Mode:** Press the plus (+) or minus (-) key to select between seven methods by which to move data to and from the drive. *Default is Standard.*
- **Ultra DMA Mode:** Press the plus (+) or minus (-) key to select between six ultra DMA modes by which to move data to and from the drive or to disable the movement. *Default is Disabled.*

## Secondary Master

Press [Enter] to access the Secondary Master menu. Press [Esc] to return to the Main menu.

At the **Type** field, press the plus (+) or minus (-) key to change the value to one of the following. The value selected dictates what configurable information is presented. *Default is SanDisk SDP3B-85.*

### Auto

Select this to automatically set the hard-disk drive installed. Press the up or down arrow keys < ↑ ↓ > to move the cursor to the following field:

- **32 Bit I/O:** Press the plus (+) or minus (-) key to enable or disable 32-bit IDE data transfers. *Default is disabled.*

### None

Select this if there is no hard-disk drive.

### CD-ROM

This indicates that a CD-ROM drive is the drive installed. Press the up or down arrow keys < ↑ ↓ > to move the cursor between the following fields:

- **Multi-Sector Transfers:** Press the plus (+) or minus (-) key to select between 2, 4, 8, or 16 sectors per block for multiple sector transfers or to disable the transfer. *Default is disabled.*

- **LBA Mode Control:** Press the plus (+) or minus (-) key to enable or disable the use of the Logical Block Addressing (LBA) in place of cylinders, heads, and sectors. *Default is disabled.*
- **32 Bit I/O** Press the plus (+) or minus (-) key to enable or disable 32-bit IDE data transfers. *Default is disabled.*
- **Transfer Mode:** Press the plus (+) or minus (-) key to select between seven methods by which to move data to and from the drive. *Default is Standard.*
- **Ultra DMA Mode:** Press the plus (+) or minus (-) key to select between six ultra DMA modes by which to move data to and from the drive or to disable the movement. *Default is Disabled.*

### IDE Removable

This indicates the removable disk drive is installed in the IDE sector. Press the up or down arrow keys < ↑ ↓ > to move the cursor between the following fields:

- **Multi-Sector Transfers:** Press the plus (+) or minus (-) key to select between 2, 4, 8, or 16 sectors per block for multiple sector transfers or to disable the transfer. *Default is disabled.*
- **LBA Mode Control:** Press the plus (+) or minus (-) key to enable or disable the use of the Logical Block Addressing (LBA) in place of cylinders, heads, and sectors. *Default is disabled.*
- **32 Bit I/O** Press the plus (+) or minus (-) key to enable or disable 32-bit IDE data transfers. *Default is disabled.*
- **Transfer Mode:** Press the plus (+) or minus (-) key to select between seven methods by which to move data to and from the drive. *Default is Standard.*
- **Ultra DMA Mode:** Press the plus (+) or minus (-) key to select between six ultra DMA modes by which to move data to and from the drive or to disable the movement. *Default is Disabled.*

### ATAPI Removable

This indicates the removable disk drive is installed in the ATAPI sector. Press the up or down arrow keys < ↑ ↓ > to move the cursor between the following fields:

- **Multi-Sector Transfers:** Press the plus (+) or minus (-) key to select between 2, 4, 8, or 16 sectors per block for multiple sector transfers or to disable the transfer. *Default is disabled.*
- **LBA Mode Control:** Press the plus (+) or minus (-) key to enable or disable the use of the Logical Block Addressing (LBA) in place of cylinders, heads, and sectors. *Default is disabled.*
- **32 Bit I/O** Press the plus (+) or minus (-) key to enable or disable 32-bit IDE data transfers. *Default is disabled.*
- **Transfer Mode:** Press the plus (+) or minus (-) key to select between seven methods by which to move data to and from the drive. *Default is Standard.*

- **Ultra DMA Mode:** Press the plus (+) or minus (-) key to select between six ultra DMA modes by which to move data to and from the drive or to disable the movement. *Default is Disabled.*

### Other ATAPI

This indicates the disk drive is installed in an ATAPI sector other than the removable sector. Press the up or down arrow keys < ↑ ↓ > to move the cursor between the following fields:

- **Multi-Sector Transfers:** Press the plus (+) or minus (-) key to select between 2, 4, 8, or 16 sectors per block for multiple sector transfers or to disable the transfer. *Default is disabled.*
- **LBA Mode Control:** Press the plus (+) or minus (-) key to enable or disable the use of the Logical Block Addressing (LBA) in place of cylinders, heads, and sectors. *Default is disabled.*
- **32 Bit I/O** Press the plus (+) or minus (-) key to enable or disable 32-bit IDE data transfers. *Default is disabled.*
- **Transfer Mode:** Press the plus (+) or minus (-) key to select between seven methods by which to move data to and from the drive. *Default is Standard.*
- **Ultra DMA Mode:** Press the plus (+) or minus (-) key to select between six ultra DMA modes by which to move data to and from the drive or to disable the movement. *Default is Disabled.*

### User

Enter the parameters of the hard-disk drive installed at this connection. Press the up or down arrow keys < ↑ ↓ > to move the cursor between the following fields:

- **Cylinders:** Enter the number of cylinders involved in this capacity, range is 0 through 65535. *Default is 650.*
- **Heads:** Enter the number of heads involved in this capacity, range is 1 through 16. *Default is 8.*
- **Sectors:** Enter the number of sectors involved in this capacity, range is 0 through 63. *Default is 32.*
- **Multi-Sector Transfers:** Press the plus (+) or minus (-) key to select between 2, 4, 8, or 16 sectors per block for multiple sector transfers or to disable the transfer. *Default is disabled.*
- **LBA Mode Control:** Press the plus (+) or minus (-) key to enable or disable the use of the Logical Block Addressing (LBA) in place of cylinders, heads, and sectors. *Default is disabled.*
- **32 Bit I/O** Press the plus (+) or minus (-) key to enable or disable 32-bit IDE data transfers. *Default is disabled.*
- **Transfer Mode:** Press the plus (+) or minus (-) key to select between seven methods by which to move data to and from the drive. *Default is Standard.*
- **Ultra DMA Mode:** Press the plus (+) or minus (-) key to select between six ultra DMA modes by which to move data to and from the drive or to disable the movement. *Default is Disabled.*

## Memory Cache

Press **[Enter]** to access the Memory Cache menu and set the state of the memory cache. Press **[Esc]** to return to the Main menu.

### Memory Cache

Press the plus (+) or minus (-) key to enable or disable the memory cache. *Default is enabled.*

### Cache System/Video BIOS Areas

Press the plus (+) or minus (-) key to select either “Write Protect” or “uncached” to control the caching of the system BIOS area. *Default is Write Protect*

### Cache Base 0–512k, 512k–640k, Extended Memory Area

Press the plus (+) or minus (-) key to select “Write Back,” “uncached,” “Write Through,” or “Write Protect” to control the caching of the 512k or 512k through 640k base memory or extended memory area. *Default is Write Back.*

### Cache A000–AFFF, B000–BFFF

Press the plus (+) or minus (-) key to select “Disabled,” “USWC Caching,” “Write Through,” “Write Protect,” or “Write Back” to control the appropriate cache range. *Default is Disabled.*

### Cache C800–CBFF through EC00–EFFF

Press the plus (+) or minus (-) key to select “Disabled,” “Write Through,” “Write Protect,” or “Write Back” to control the appropriate cache range. *Default is Disabled.*

## Boot Features

Press **[Enter]** to access the Boot Features menu and configure the floppy check, the summary screen, the boot-time diagnostic screen, or the Quick-Boot mode. Press **[Esc]** to return to the Main menu.

### Summary Screen

Press the plus (+) or minus (-) key to dictate whether to display system configuration information on boot. *Default is enabled.*

### Boot-Time Diagnostic Screen

Press the plus (+) or minus (-) key to state whether to display the diagnostic screen during the boot up process. *Default is disabled.*

### QuickBoot Mode

Press the plus (+) or minus (-) key to dictate whether the system can skip certain tests during the boot process, thus shortening the time required to perform the boot. *Default is enabled.*

## Advanced

This configures advanced features within your CV60. Press the up or down arrow keys < ↑ ↓ > to move the cursor to the following fields. Press the left or right arrow keys < ← □ □ → > to move the cursor to another menu.



Caution: If you set items in this menu to incorrect values, you could cause your system to malfunction.

### Advanced Chipset Control

Press [Enter] to access the Advanced Chipset Control menu and configure the video boot type, the enable memory gap, or the frequency ratio. Press [Esc] to return to the Advanced menu.

#### Video Boot Type

Press the plus (+) or minus (-) key to select either 512 KB or 1 MB of system memory to allocate to the onboard video controller. *Default is 1 MB.*

#### Enable Memory Gap

Press the plus (+) or minus (-) key to select either “Disabled” or “Extended.” If “Extended,” this turns off the system RAM to free space for use with an option card. *Default is disabled.*

#### Frequency Ratio

Press the plus (+) or minus (-) key to select from fourteen different internal frequency multiplier values of the CPU. *Default is 4x.*

### I/O Device Configuration

Press [Enter] to access the Advanced Chipset Control menu and configure peripheral devices, such as serial ports, panel heater circuit and power, or the Picolink radio. Press [Esc] to return to the Advanced menu.

#### Serial Ports

Press the plus (+) or minus (-) key to select “Disabled,” “Enabled,” “Auto,” or “OS Controlled” to configure serial ports A through D.

If “Enabled” is selected, press the plus (+) or minus (-) key to set the base I/O address and the interrupt for the enabled serial port. *Default is OS Controlled.*



**Note:** To enable the touchscreen, select “Enabled” for Windows CE systems and “OS Controlled” for Windows XP systems.

#### Panel Heater

Press the plus (+) or minus (-) key to enable or disable the panel heater circuit and power. *Default is disabled.*

#### Picolink

Press the plus (+) or minus (-) key to enable or disable support for the Picolink radio. *Default is disabled.*



## Legacy USB Support

Press the plus (+) or minus (-) key to enable or disable support for Legacy Universal Serial Bus (USB) devices. *Default is enabled.*

## Reset Configuration Data

Press the plus (+) or minus (-) key to select whether to clear the Extended System Configuration Data (ESCD). *Default is No.*

## FirstWare Authentication Level

Press the plus (+) or minus (-) key to select the level of FirstWare authentication, from high, medium, or low. *Default is High.*

## PC Card Boot Support

Press the plus (+) or minus (-) key to dictate whether to support PC card boot. *Default is enabled.*

## Security

Use this menu to set the supervisor password. Press the up or down arrow keys < ↑ ↓ > to move the cursor to the following field. Press the left or right arrow keys < ← → > to move the cursor to another menu.

### Set Supervisor Password

Press the plus (+) or minus (-) key to dictate how controlled is the supervisor password to the setup utility. *Default is Enter.*

## Boot

Use this menu to view or configure devices for the dual-booting process for Windows CE and XP systems. Press the plus (+) or minus (-) key to rearrange the order of the devices listed. Press the up or down arrow keys < ↑ ↓ > to move the cursor between devices. Press the left or right arrow keys < ← □ □ → > to move the cursor to another menu.

## Exit

Use this menu to access exit options, settings, and version information. Press the up or down arrow keys < ↑ ↓ > to move the cursor between devices. Press the left or right arrow keys < ← → > to move the cursor to another menu.

### Exit Saving Changes

Select this option to exit the PSU and save your changes to CMOS. Press **[Enter]** to select the option, then press **[Yes]** to continue. Press **[No]** to return to the Exit menu.

### Exit Discarding Changes

Select this option to exit the PSU without saving the data to CMOS. Press **[Enter]** to select the option, then press **[Yes]** to continue. Press **[No]** to return to the Exit menu.

### Load Setup Defaults

Select this option to load the default values for all setup items. Press **[Enter]** to select the option, then press **[Yes]** to continue. Press **[No]** to return to the Exit menu.

### Discard Changes

Select this option to discard all current changes and load previous values from CMOS for all setup items. Press **[Enter]** to select the option, then press **[Yes]** to continue. Press **[No]** to return to the Exit menu.

### Save Changes

Select this option to save current changes to CMOS without exiting the PSU. Press **[Enter]** to select the option, then press **[Yes]** to continue. Press **[No]** to return to the Exit menu.

## Reflash Procedure



**Note:** See the *CV60 Recovery Instruction Guide* P/N: 962-054-073 for more information.

### Windows CE



The following information pertains to the Windows CE operating system.

- 1 Copy the new BIOS onto a storage card, insert the card into your CV60, then reboot the unit.
- 2 From the CV60 desktop, double-click the **My Computer** desktop icon, then double-click the **Windows** folder.
- 3 Double-click the **BiosFlash** desktop icon to access the Intermec CV60 Flash Utility.
- 4 Select **Backup BIOS and Flash BIOS with new settings**, then from within the BIOS Settings Locations box, click the second **Browse** to locate the new BIOS ROM file. You may also click the first **Browse** to dictate the location where to save the backup file.

Click **Flash BIOS** to initiate the reflash. The system should automatically reboot after finishing. If not, then perform a reboot.

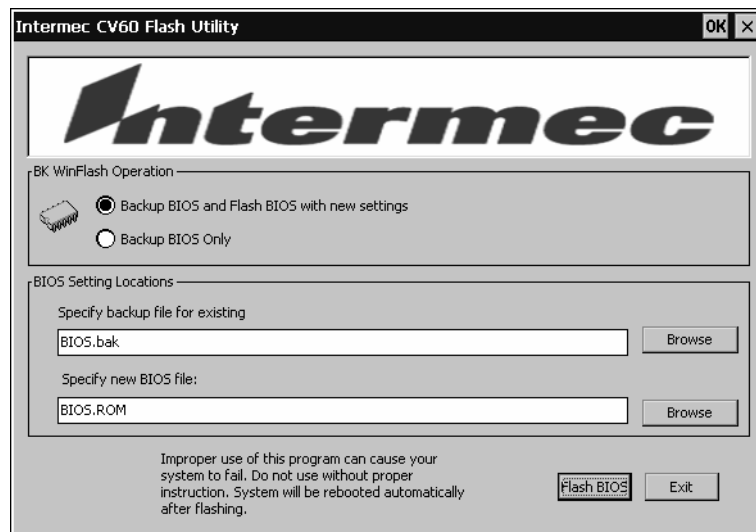

- 5 Upon reboot, at the DOS prompt, enter the following:

```
BiosFlash.exe/nogui/f:<newbiosname>.rom/b:<backupfilename>
```

where *newbiosname* is the name of your new flash file name and *backupfilename* is the name of the backed up file.

### Windows XP



This information pertains to the Windows XP and Windows XP Embedded operating systems. Do the instructions as written for Windows CE, *except* double-click the **CV60Flash** desktop icon.





# 4 Windows Device Configurations

This chapter has the following configurable devices for the Windows CE, Windows XP, and Windows XP Embedded operating systems:

- CV60 Settings (*page 44*)
- Network Adapters (*page 48*)
- AutoIP/DHCP (*page 140*)
- Stylus (*page 67*)
- TCP/IP (*page 72*)
- Tethered Scanner (*page 75*)

## UPS

Use this page to dictate which COM port is to hold the UPS service, how often to poll the UPS, and set when the unit is to automatically shut down. Click the drop-down arrow to reset the **Poll Frequency** value. Check **Automatic shutdown** before you click its drop-down arrow to adjust its value.

Be sure to check **Enable UPS** to enable the rest of the page.

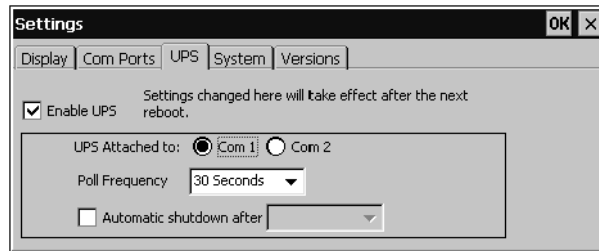

## System

Use this page to reboot the system with a default system registry. Check **Load default system registry** then reboot the system.

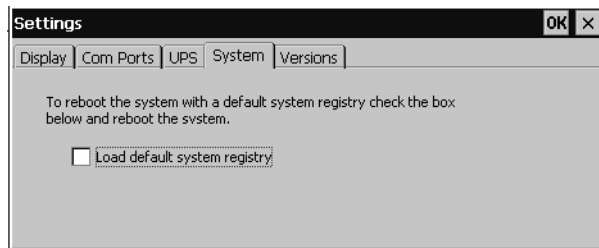

## Versions

Use this page to view the kernel, registry, IVA, PSK and SDK versions.

Current driver versions are displayed in the group box below.

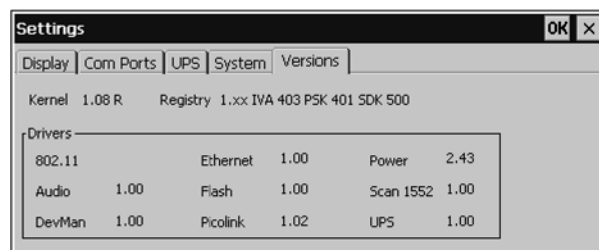



## CV60 Settings

Use the CV60 control panel applet to adjust the brightness, communication ports, and UPS of your CV60. Note that these can also be adjusted within your PhoenixBIOS Setup Utility. See Chapter 3, “PhoenixBIOS Setup Utility” for more information.

## Windows CE



The following information pertains to the Windows CE operating system.

From the desktop, select **Start > Settings > Control Panel**, then double-click the **Settings** desktop icon, or double-click the lightbulb icon in the System Tray (circled in the following illustration). Make your adjustments, then click **OK** to close the Settings.



### Display

Use this page to adjust the brightness of your display. Tap the desired level of display brightness within the Minimum/Maximum range.

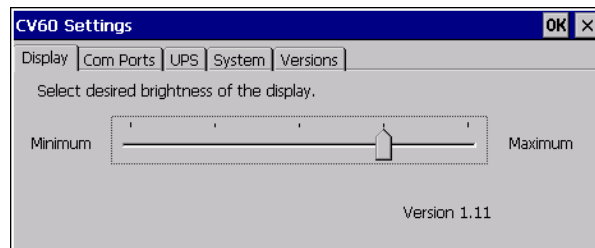

### Com Ports

Check **Com 1 – 5 Volt Enabled** to activate the tethered scanner. If a Pico-link radio is installed in your CV60, then **Com 2 – 5 Volt Enabled** is checked by default.

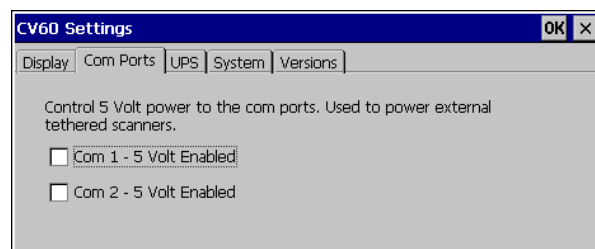

## UPS

Use this page to set which COM port is to hold the UPS service, how often to poll the UPS, and set the time when the unit is to automatically shut down. Click the drop-down arrow to reset the **Poll Frequency** value. Check **Automatic shutdown** before you click its drop-down arrow to adjust its value.

Be sure to check **Enable UPS** to enable the rest of the page.

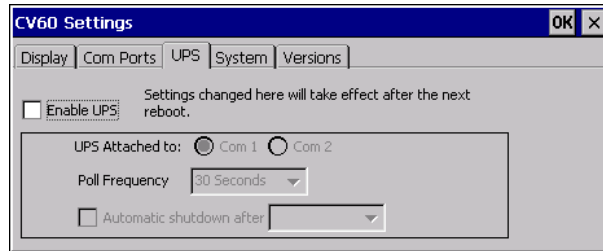

## System

Use this page to reboot the system with a default system registry. Check **Load default system registry** then reboot the system.

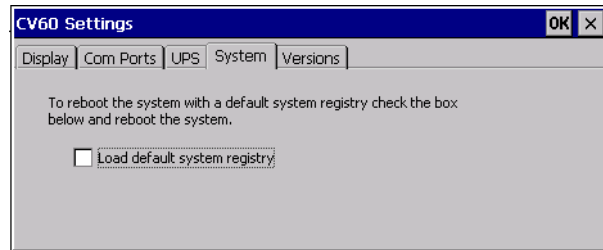

## Versions

Use this page to view the kernel and registry versions.

Current driver versions are displayed in the group box below.

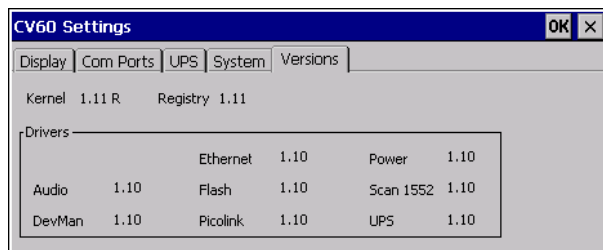

## Windows XP

The following information pertains to the Windows XP and Windows XP Embedded operating systems.



From the desktop, select **Start > Settings > Control Panel**, then double-click the **CV60** desktop icon. Do your adjustments, then click **OK** to close the CV60 Control Panel.

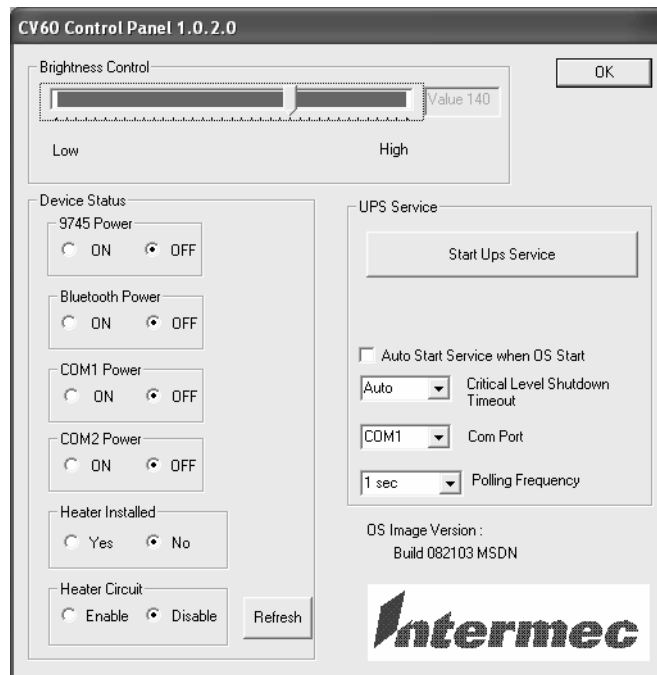

### Brightness Status

Within this box, tap the desired level of brightness within the Low/High range.

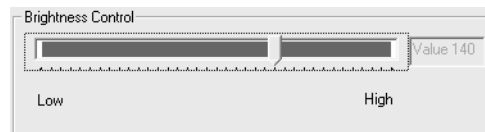

### Device Status

Use the information within this box to monitor whether power to the 9745, Bluetooth, COM1, or COM2 is on or off, the display heater is installed, and the heater circuit is enabled.

The screenshot shows a 'Device Status' window with the following settings:

- 9745 Power:  ON,  OFF
- Bluetooth Power:  ON,  OFF
- COM1 Power:  ON,  OFF
- COM2 Power:  ON,  OFF
- Heater Installed:  Yes,  No
- Heater Circuit:  Enable,  Disable

A 'Refresh' button is located at the bottom right of the window.

### UPS Service

Use this box to start up the UPS service and to set which COM port is to hold the UPS service, how often to poll the UPS, and set when the unit is to automatically shut down. Click the drop-down arrow to reset the appropriate values. Check **Auto Start Service when OS Start** before adjusting any values.

The screenshot shows a 'UPS Service' window with the following settings:

- Start Ups Service:
- Auto Start Service when OS Start:
- Critical Level Shutdown Timeout: Auto
- Com Port: COM1
- Polling Frequency: 1 sec

## Network Adapters

Your CV60 can have up to three radios installed. The default network adapter or radio is dependent on what radios are installed in your CV60. Below are the the network adapters that exist as of this publication. See the Developer's Support web site for the latest information on network adapters for your unit.

- 802.11b/g Radios (*ActionTec*) — page 51.
- Wireless Printing (*Bluetooth*) — page 60.
- Picolink — page 66.

## DHCP

Dynamic Host Configuration Protocol (DHCP) is enabled by default in Windows CE. You can configure the registry settings in the following to set the required AutoIP/DHCP behavior:

- For Ethernet: `HKEY_LOCAL_MACHINE\Comm\LAN9001\TcpIp`
- For 802.11b: `HKEY_LOCAL_MACHINE\Comm\NETWLAN1\TcpIp`

Other registry keys that can modify the behavior of AutoIP are as follows. You can find the appropriate settings and behavior of each of these keys in Microsoft Help.

- AutoInterval
- AutoMask
- AutoSubnet
- AutoIP
- AutoSeed

When a TCP/IP client cannot find a DHCP server, it generates an AutoIP address from the 169.254.xxx.xxx block. The client then tries to check for a DHCP server every 300 seconds (5 minutes) and if a DHCP server is found, the client drops the AutoIP address and uses the address from the DHCP server.

See “*Automatic Client Configuration*” for more information on AutoIP. In the MSDN Windows CE documentation available on the Microsoft Developer Network web site (<http://www.msdn.com>).

To disable AutoIP, set the AutoCfg registry entry to “0.” If a DHCP server cannot be found, instead of using AutoIP, the system will display the “Unable to obtain a server assigned IP address” message.



**Note:** If AutoIP is defined using CAB files, the EnableDHCP registry key must also be defined and set to “1” before the system will attempt to obtain a DHCP address.



**Note:** To extend the number of attempts that a DHCP client makes to get a DHCP address, use the DhcpRetryDialogue and DhcpMaxRetry registry settings.



**Note:** Change the AutoInterval registry key value to make the client retry more often to obtain a DHCP address.

## 802.11b/g Communications

The following communication options on the CV60 Vehicle Mount Computer provide wired and wireless connectivity:

- **Onboard wired Ethernet** (*standard*)
- **Wireless Local Area Network** (*optional*)  
This 802.11b radio option provides up to 11 Mb/sec throughput. The 802.11g option specifies
- **Wireless Personal Area Network** (*standard*)  
This allows for cable-free communications with peripheral devices, such as printers, over a ten-meter range. This compatibility is provided via a Bluetooth qualified module by Socket Communications.

## CORE

The Intermec CORE (Common Object Resource Environment) application provides a framework for various modules that let you configure and manage your Intermec products. These modules are software plug-ins that can be configuration tools, such as the 802.11b radio configuration module, or they can provide information on your environment, such as a battery life module.

CORE modules are collections of specific information. Each module can display general and detailed information. Tap the **General** and **Details** tabs near the bottom to switch between general and detailed information. Note that not all modules have detailed information.

### Activating CORE



CORE is built into the operating system of Windows CE. NET for CV60 Vehicle Mount Computers. Tap **Start > Programs > Core** to access this application.

### Install an Available Radio Module

#### Windows CE

To install an available radio module onto your CV60 Vehicle Mount Computer, tap **Modules > Add/Remove**, select a module from the bottom Available box, then tap **Add** to put the selected module in the upper Installed box. Click **OK** to exit the Add/Remove Modules screen.

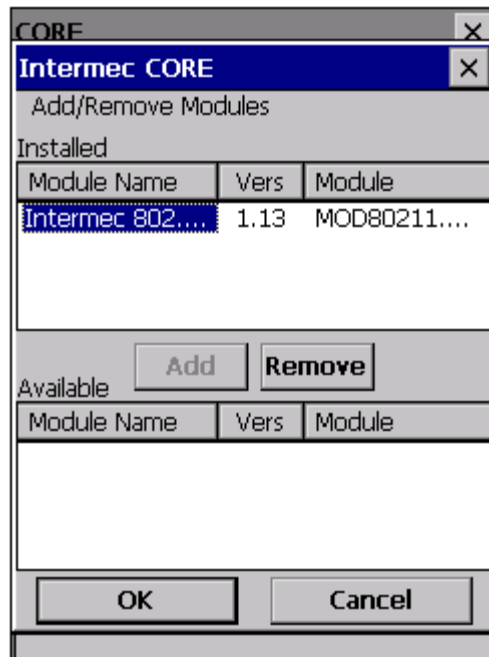



## Loading a Radio Module

To load or switch to another radio module installed on the CV60 Vehicle Mount Computer, tap **Modules > Choose Module**, select a module from the Installed Modules box, then tap **Choose** to initialize and begin using that module.

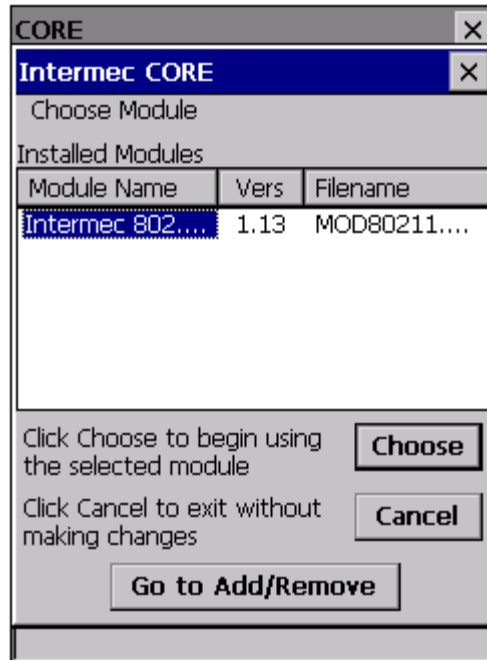



**Note:** Once CORE is running, you can return to it by tapping its icon from the System Tray. Tap **Start** > **Today** > the **Core** three-ring icon (circled in the following illustration).



## Ethernet Communications

Follow the steps below to start Ethernet communications on the CV60 Vehicle Mount Computer. If your system does not contain an 802.11b radio, then **Ethernet networking using DHCP** is selected as the default.

When “Built-in Ethernet” is selected from the NDISTRAY pop-up menu (the Network Driver Interface Specification tray application),

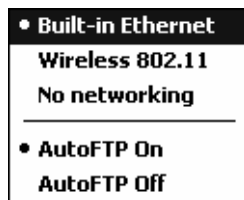

then the **Ethernet** icon shown to the left appears in the System Tray *as circled in the following illustration.*

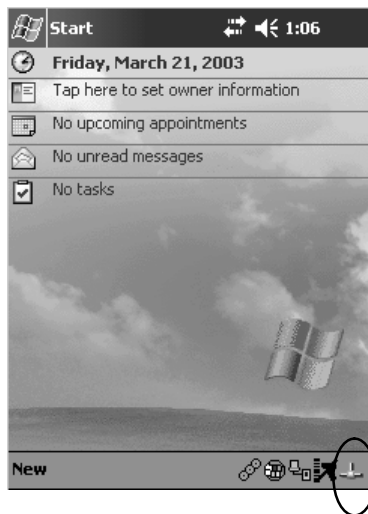

## 802.11b Communications

When “Wireless 802.11” is selected via the NDISTRAY pop-up menu:

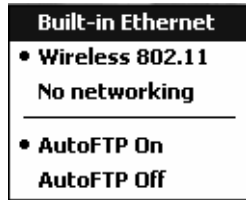

the **802.11 antenna** icon shown to the left appears in the system tray *as circled in the following illustration.*

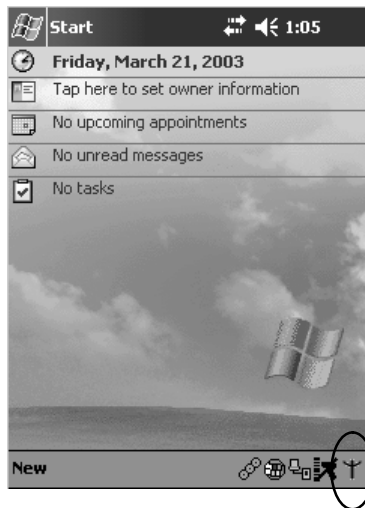

To configure 802.11b communications on the CV60 Vehicle Mount Computer, tap **Start** > **Settings** > the **System** tab > **Wireless Network** to access the Profile Wizard for the 802.11b radio module. Go to Appendix A, “*Configurable Settings*,” for configuration information.

### 802.11b Radio CORE Module



**Note:** See page 52 for information on loading this module in CORE.

The 802.11b radio CORE module displays helpful information about the 802.11b radio option built into your CV60 Vehicle Mount Computer.

Note that you can configure the 802.11b radio module from this CORE application. Select **Configure** > **Configure 802.11 CF** from the bottom menu bar to access the Profile Wizard application. See Appendix A, “*Configurable Settings*,” for information about this application via the Wireless Network control panel applet.

### General

Below are descriptions and meanings for each piece of information provided via the **General** tab. *Note that the information is listed alphabetically.*

Adapter MAC	Identifies the MAC address for this 802.11b adapter.
Antenna	Identifies the antenna used with the 802.11b radio: “Primary,” “Secondary,” or “Diversity.”
AP Mac	Identifies the MAC address of the access point to which this CV60 Vehicle Mount Computer is connected.
Connected to	Reports the connection status and to which SSID this CV60 Vehicle Mount Computer is attached.
Encryption	Reports the encryption mode and the association mode (in parantheses). See page NO TAG for information about WEP encryption.
ESS	Identifies the type of network to which you are attached, either an ESS (Extended Service Set) 802.11 Station, or Ad-hoc.
IP	Provides the IP address which can be set as either DHCP (Dynamic Host Configuration Protocol) or statically.
Link	Indicates the speed at which a connection is made.
Power	Indicates the power status of this 802.11b profile.
Signal	Identifies the radio signal strength (in dBm).
TX Power	Shows the transmit power (in milliwatts) at which transmissions are made.



#### History:

This bar graph displays an active history of this radio module’s quality of connections.



#### Friendly Indicator:

This indicates the general quality of the 802.11b connection. Three filled dots indicates the best quality; two filled dots dictates good quality; one filled dot is of fair quality; and when all three dots are empty, the quality is considered poor.

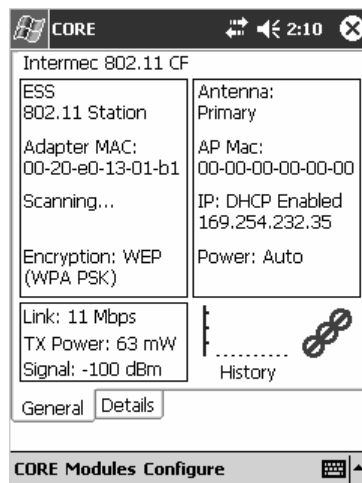

### Details

Below are descriptions and meanings for each piece of information provided via the **Details** tab. *Note the information is listed alphabetically.*

Attach-Roam Cnt	Includes the number of new associations made during the current session, including any found roaming.
CCX Status	States the status of the CCX, either enabled or disabled.
Desired SSID	Identifies the preferred Service Set Identifier (SSID).
Driver Name	Identifies the 802.1x driver installed on this CV60 Vehicle Mount Computer.
Last 5 Supp Msgs	Monitors and reports the 802.1x Security Supplicant activity.
Scanlist	Indicates whether the Scan List option was enabled or disabled.
Supplicant Status	Monitors the 802.1x security activity on the client: “Running” or “Stopped.”
Watchdog Status	Monitors the activity of the Scan List: “Running” or “Stopped.”

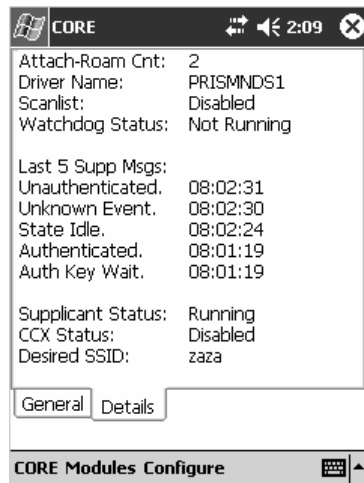

## No Networking

When “No networking” is selected from the NDISTRAY pop-up menu:

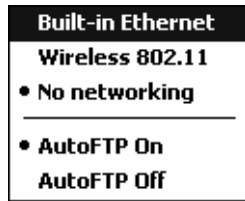

the **disconnected** icon shown to the left appears in the system tray *as circled in the following illustration.*

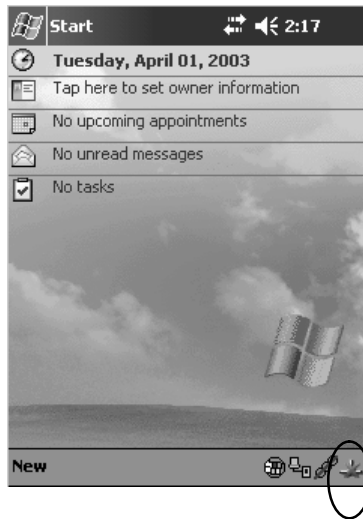

## Network Selection APIs

The Network Selection APIs change the network adapter configuration programmatically. Both drivers support the same IOCTL function numbers for loading and unloading the drivers. Go to Chapter 7, “*Programming*,” to see the APIs.

## Network Connections



Connections

From the CV60 Vehicle Mount Computer, tap **Start > Settings > Network and Dialup Connections > PCI-E100CE1 > the Advanced tab > Network Card** to access the network connections for this unit. Make the changes necessary for your network, then tap **ok** when finished.

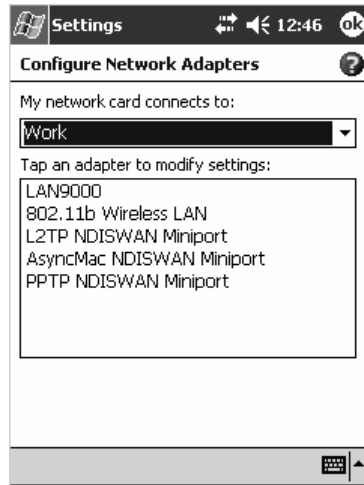

**Note:** “PCI-E100CE1” is for Ethernet and ”802.11b Wireless LAN” is for 802.11b radios.

## Wireless Printing

“Bluetooth” is the name given to a technology standard using short-range radio links, intended to replace the cables connecting portable and fixed electronic devices. The standard defines a uniform structure for a wide range of devices to communicate with each other, with minimal user effort. Its key features are robustness, low complexity, low power, and low cost. The technology also offers wireless access to LANs, the mobile phone network, and the internet for a host of home appliances and portable hand-held interfaces.

The Wireless Printing control panel separates the task of wireless printing from the other Bluetooth management items not relevant to this task.

Wireless Printing has a concept of the “current wireless printer”. This printer is the one to which the CV60 makes a connection when the wireless printing COM port is opened. If there is no current wireless printer, there is no wireless printing COM port. Registration and deregistration of this COM port is controlled by BTCC. The Wp\_quickset\_1.exe executable calls BTCC when a printer is chosen to handle the COM port registration. Customer software or other test applications can also use BTCC to manage the COM port registration and deregistration.

The current wireless printer is stored in the registry and is registered and deregistered on Bluetooth stack load/unload. If the current wireless printer changes, the existing wireless printing COM port is deregistered, and the



new one is registered instead. The registered COM port is stored in the registry as the WPPort.

## Windows CE

The following information pertains to the Windows CE operating system.

### Wireless Printing

There are currently three ways to set the wireless printer. You can use a Bluetooth device discovery to locate the remote device, you can manually enter the remote Bluetooth Device Address, or you can use the Bluetooth Device Manager to choose from previously discovered printers.

#### Use a Bluetooth Device Discovery

You can set your wireless printer via a Bluetooth Device Discovery, which takes about half a minute to locate all Bluetooth devices in your range.



- 1 From the CV60 desktop, select **Start > Settings > Control Panel**, then double-click the **Wireless Printing** desktop icon.
- 2 Make sure **Device Discovery** is selected in the **Set Wireless Printer** box, and click **Acquire Printer** to initiate the device discovery.



- 3 Momentarily, Bluetooth devices discovered within range appear. If your preferred printer is in the list, select to highlight the printer, and click **OK**. If you do not see your preferred device, make sure this device is powered on and set to discovery. Click **Device Discovery** again.



**Note:** Click **Cancel** to return to the first screen without making changes

### Enter the Remote Device Address

If you know the Bluetooth Device Address of the printer you want to use, you can avoid Device Discovery and perform a manual setup.

- 1 Select **Manual** from within the **Set Wireless Printer** box, then click **Acquire Printer**.



- 2 Type the address of your device in the field, then click **OK**.

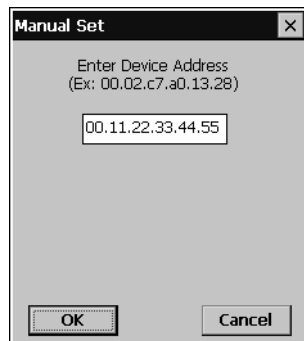

When you set your printer manually, your device does not receive the printer name. Therefore, "-unknown-" is displayed under **Device Name** unless you enter the correct value in to the registry in some other way.

HKEY\_LOCAL\_MACHINE\Software\Intermec\Bluetooth\Wireless Printing

- RemoteDeviceAddress [String] - ex. 0002c7a01328
- RemoteDeviceAddress [String] - ex. PB20-4322377
- WPPort [String] - ex. COM6:

*WPPort* is the COM port to use in a call to CreateFile.

*wp\_quickset* also alerts BTCC of Wireless Printer changes. When a new wireless printer is set, *wp\_quickset* calls BTCC, which then deregisters the existing port (if necessary) and registers a new one based on the updated remote Bluetooth device address.



**Note:** Click **Cancel** to return to the first screen without making changes

### Choose from Previously Discovered Printers

Do the following to select from a list of previously discovered printers:

- 1 Tap **Device Manager** from within the **Set Wireless Printer** box, then click **Acquire Printer**.



- 2 Select to highlight the printer of choice, then tap **OK**.

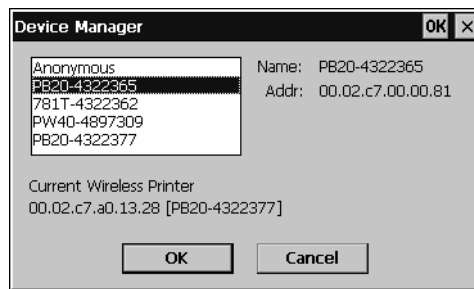

**Note:** Click **Cancel** to return to the first screen without making changes

### Local Bluetooth

Local Bluetooth (Btlocal) is a Control Panel applet that views and sets local device Bluetooth settings. Local Bluetooth also provides a versions screen for various Bluetooth items in the system.



From the CV60 desktop, select **Start > Settings > Control Panel**, then double-click the **Local Bluetooth** desktop icon.



- **Device Name**

This provides the “friendly” name of your CV60.

- **Device Address**

Device address is universally unique and cannot be changed. Read-only.

- **Discoverable**

Check this box to make your CV60 discoverable to other Bluetooth devices. The default is for the CV60 to be undiscoverable since it does not offer any incoming services out of the box.

- **Connectable**

Check this box to allow other Bluetooth devices to connect to your CV60. The default is for the CV60 to be unconnectable since it does not offer any incoming services out of the box.

- **Class of Device**

This sets how your CV60 appears to other devices during a device discovery. The default is 0x920100 which specifies the CV60 is a PC capable of services of information, object transfer, and networking. *Note that though the CV60 identifies itself as having service classes, these services are not supported as of this publication.*

HKEY\_LOCAL\_MACHINE\Software\Intermec\Network\Bluetooth

- Discoverable [DWORD] - 0=FALSE, 1=TRUE (Default is false)
- Connectable [DWORD] - 0=FALSE, 1=TRUE (Default is false)
- DeviceName [String] - ex. 720-6025320 not yet implemented
- CoD [?] - ex. ? not yet implemented

## Windows XP

Information that pertains to the Windows XP and Windows XP Embedded operating systems is not available as of this publication.



## Picolink Radio



**Note:** To ensure the Picolink radio is enabled in your CV60, ensure the COM2 serial port is turned on in the PhoenixBIOS Setup Utility. See Chapter 3, “*PhoenixBIOS Setup Utility*” for more information.

The Picolink radio is an Intermec product that is factory-installed into your unit with a plate that covers the COM2 serial port at the bottom. Wireless scanning capability is enabled using the Intermec Picolink radio, compatible with the Intermec 1552 Decoded Cordless Laser wireless scanner.

To associate the Picolink radio with your 1552 wireless scanner, scan the Picolink bar code label located on the right side of your CV60 in the third indented rib from the top.

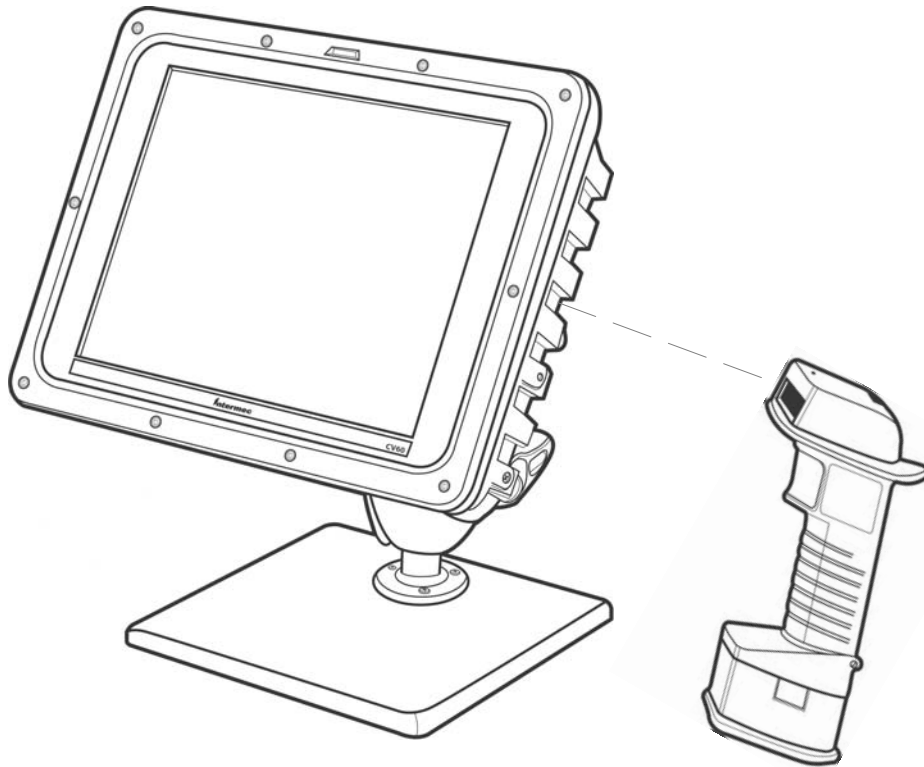

Continue to scan the Picolink label on the CV60 until you hear two beeps from the 1552 Scanner.



**Note:** To enable the touchscreen in units with Windows CE, set COM3 to “Enabled” within the PhoenixBIOS Setup Utility. In units with Windows XP and Windows XP Embedded, set COM3 to “OS Controlled.” See Chapter 3, “*PhoenixBIOS Setup Utility*” for more information.

## Stylus

When the CV60 Vehicle-Mount Computer is first reimaged to Windows CE, Windows XP, or Windows XP Embedded or when it is necessary to recalibrate (or realign) the touchscreen, use the Stylus Control Panel.

## Windows CE

The following information pertains to the Windows CE operating system.

### Double-Tap

Follow the instructions on this page to set the double-tap sensitivity of your stylus. Tap **OK** when finished.

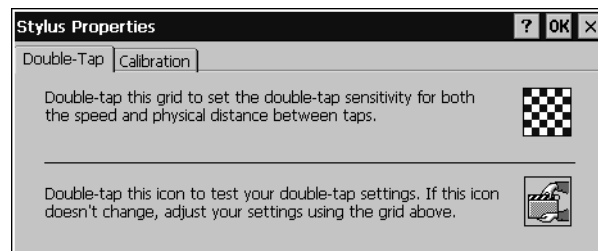

### Calibration

This applet calibrates the stylus for the CV60, aligning the Windows cursor and stylus to the same location on the screen. When complete, the calibration values are stored permanently until the next time you do a calibration.



**Note:** In situations where the touchscreen calibration is off base or is not usable, use the external keyboard to navigate to the calibration screen.



1 From the CV60 desktop, select **Start > Settings > Control Panel**, double-tap the **Stylus** icon to access the Stylus Properties, then tap the **Calibration** tab. Tap **Recalibrate** to begin.

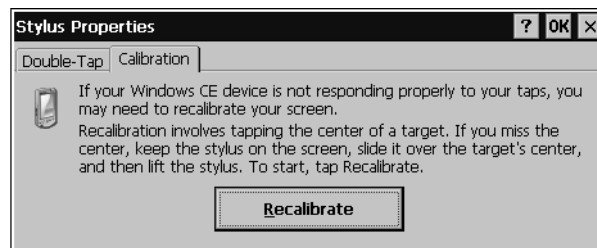

- 2 Tap your stylus firmly at the center of the crosshairs target. Continue the process as the crosshair moves to the upper-left corner, the bottom-left, the bottom-right, and upper-right corners of the screen.

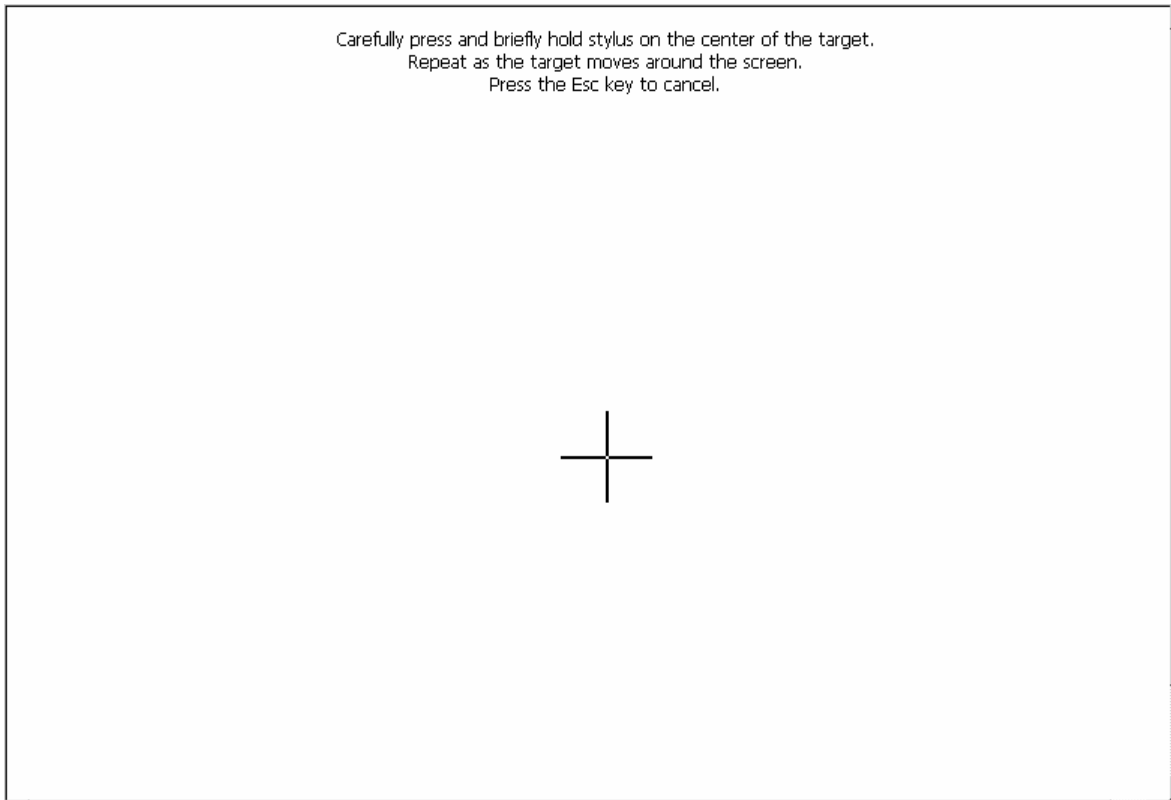

- 3 After all targets are tapped, a message appears to indicate that new calibration settings have been measured. Press [Enter] on the external keyboard to accept the new settings and return to the Stylus Properties screen, or press [Esc] to do another calibration.
- 4 Tap **OK** to close the Stylus Properties screen.



## Windows XP

The following information pertains to the Windows XP and Windows XP Embedded operating systems.

### Double-Tap

Use the Mouse control panel applet to adjust the double-tap sensitivity of your stylus.



Mouse

- 1 From the Windows desktop, select **Start > Settings > Control Panel**, then double-click the **Mouse** desktop icon.
- 2 From the center **Double-click speed** box, drag the **Speed** bar to slower or faster, then test the sensitivity between taps on the folder.
- 3 When satisfied with your double-tap sensitivity, click **Apply** to save your settings, then click **OK** to close the Mouse Properties.

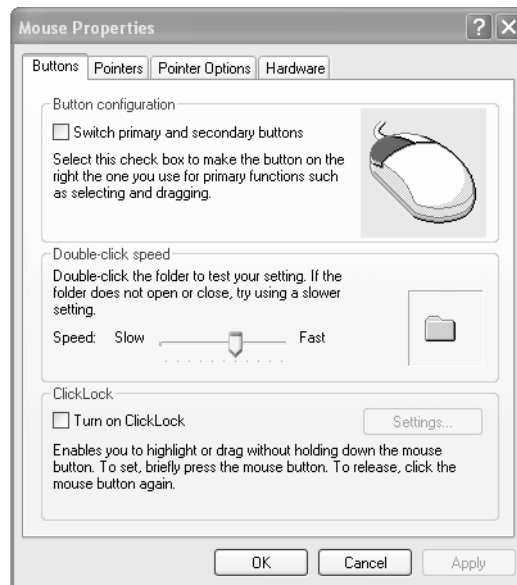

### Calibration

When the CV60 is first reimaged to Windows XP or Windows XP Embedded or when it is necessary to recalibrate (or realign) the touchscreen, use the CV60 Pen Alignment Utility. This utility is located in the Windows Control Panel.

The CV60 Pen Alignment Utility calibrates the pen for the CV60, aligning the Windows cursor and tip of the stylus to the same location on the screen. When complete, the calibration values are stored permanently.



- 1 From the Windows desktop, select **Start > Settings > Control Panel**, then double-click the **CV60 PEN** desktop icon to access the CV60 Pen Alignment Utility.

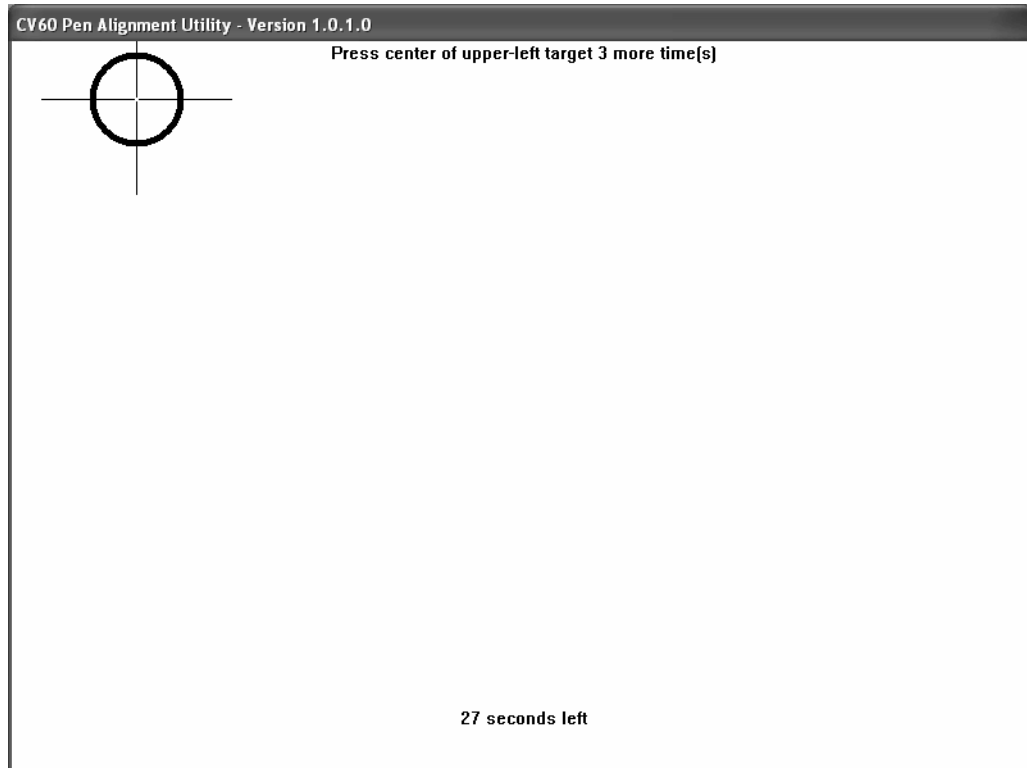

- 2 Tap your stylus firmly at the center of the crosshairs target in the upper-left corner. You should hear a click and see two sets of x,y coordinate values display on the screen. Tap two more times in this same way at the center of this target.
- 3 Continue the three-tap process as the crosshair moves to the upper-right corner, the lower-left, and lower-right corners of the screen.

- 4 Touch on an open area to determine if the Windows cursor matches the location your stylus. Click **Recalibrate** if there is no match. When finished, click **Save** to permanently save the new values or click **Cancel** to continue using the old calibration.

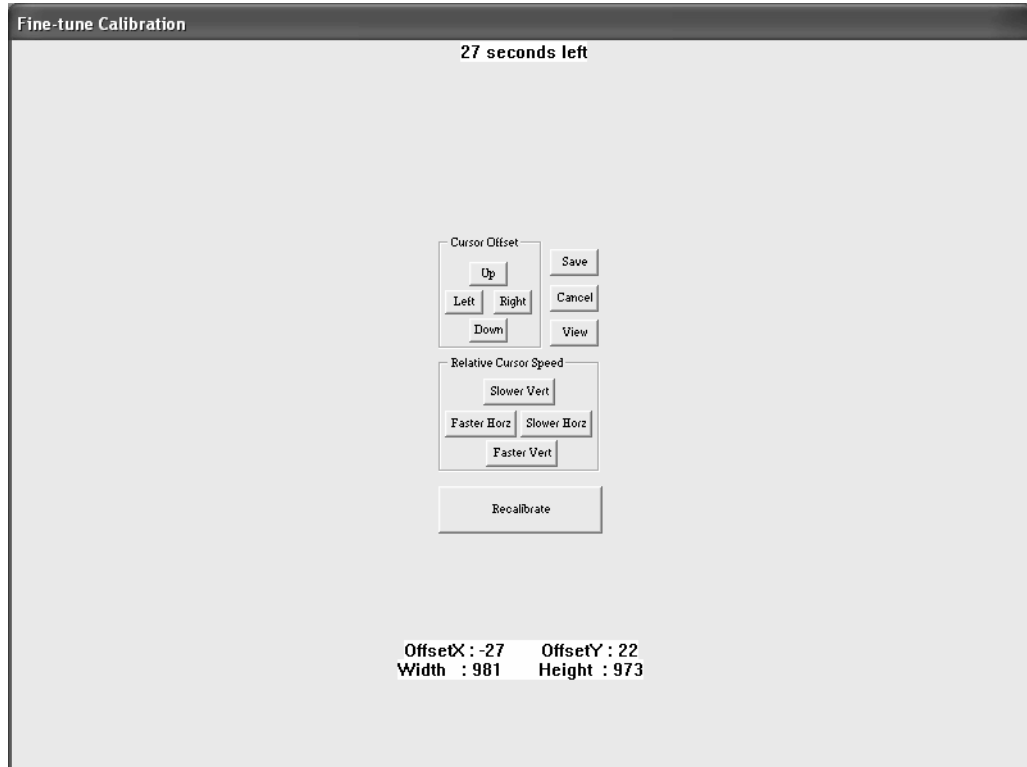

- **Left**  
Move the cursor to the left with respect to your stylus.
- **Right**  
Move the cursor to the right with respect to your stylus.
- **Up**  
Move the cursor up with respect to your stylus.
- **Down**  
Move the cursor down with respect to your stylus.
- **SlowerVert**  
Moves the cursor more slowly in the vertical direction with respect to your stylus. Use this when the cursor matches at the top of the screen, but is lower than the tip of your stylus at the bottom of the screen.
- **FasterVert**  
Moves the cursor more quickly in the vertical direction with respect to your stylus. Use this when the cursor matches at the top of the screen, but is higher than the tip of your stylus at the bottom of the screen.
- **SlowerHorz**  
Works like SlowerVert, except movement is in the horizontal direction.
- **FasterHorz**  
Works like FasterVert, except movement is in the horizontal direction.

## TCP/IP

This section contains Transmission Control Protocol/Internet Protocol (TCP/IP) network information supported for the CV60. This protocol readies the CV60 for communications.

By default, the Local Area Connection is set to obtain an IP address and a DNS server address automatically on your CV60.

## Windows CE

The following information pertains to the Windows CE operating system.

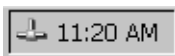

To determine what type of Ethernet connection is set up on your CV60, tap the Ethernet icon twice in your System Tray to access the following information. Tap **Renew** to refresh this information.

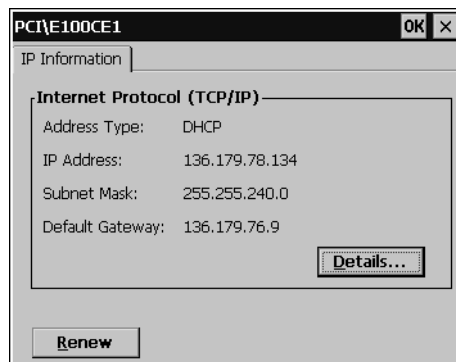

Do the following to assign static IP and DNS addresses:

**1** From the CV60 desktop, tap **Start > Settings > Network and Dial-up Connections**.



**2** Double-tap the **PCI-E100CE2** icon to get its settings. Under the **IP Address** tab, tap **Specify an IP address**, then complete the information:

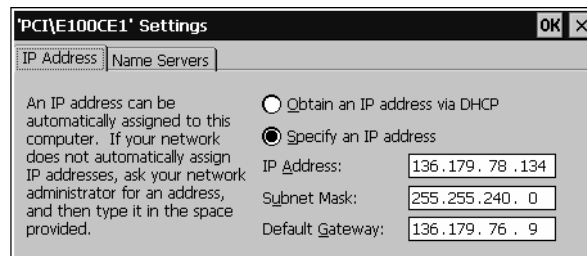

- 3 Tap the **Name Servers** tab, then complete the information. Be sure to complete at least the primary addresses:

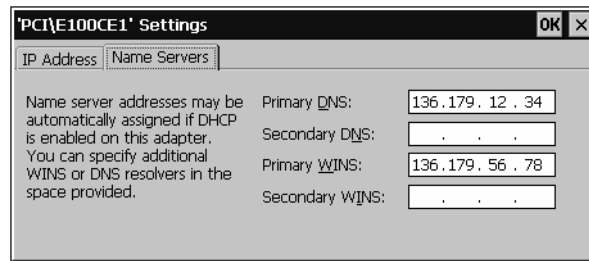

- 4 Tap **OK** to close the Settings, then close the Network Connections screen.

## Windows XP

The following information pertains to the Windows XP and Windows XP Embedded operating systems.

Do the following to assign static IP and DNS addresses:

- 1 From the CV60 desktop, tap **Start > Settings > Network Connections**.
- 2 Press and hold the stylus on the **Local Area Connection** icon to get its pop-up menu, then select **Properties**.
- 3 Select to highlight the **Internet Protocol (TCP/IP)** option, then tap **Properties**.

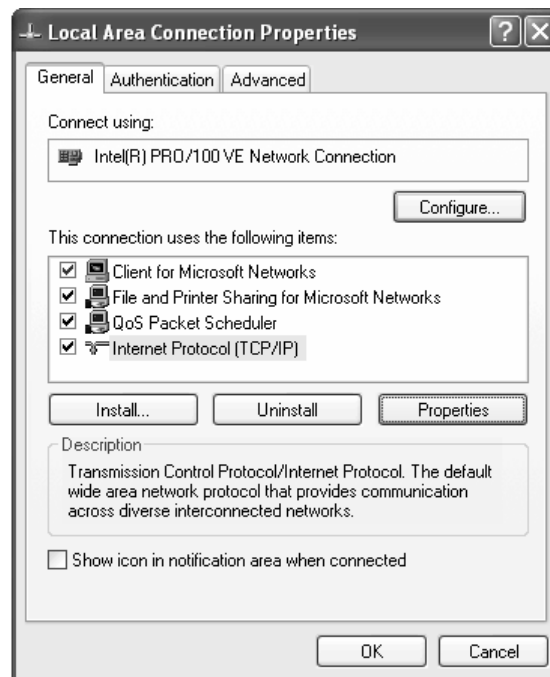
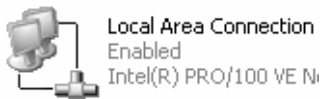

- 4 Tap **Use the following IP address**, then complete both the IP address and DNS addresses.

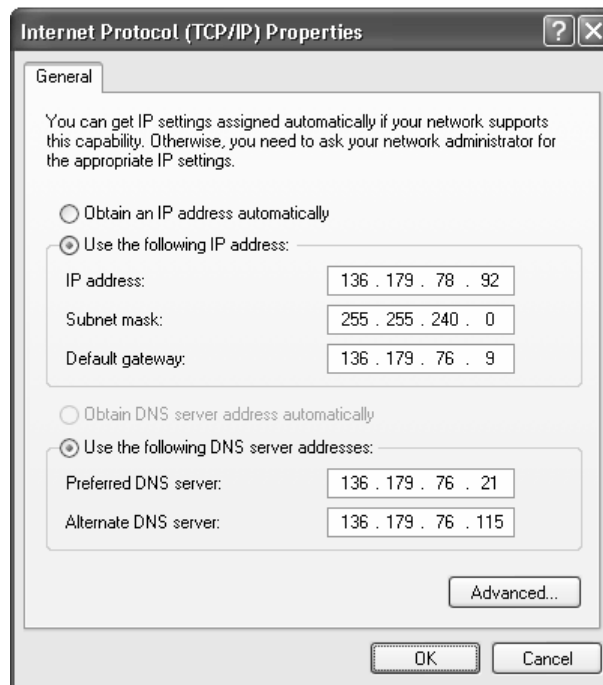

- 5 Tap **OK** to close the TCP/IP Properties, tap **OK** again to close the Local Area Connections screen.

## Tethered Scanner

The Intermecc Tethered Scanner feature allows Automatic Data Collection (ADC) by accepting data from the COM1 port and wedging it into the keyboard interface. This feature is enabled or disabled via the Intermecc Settings and Settings control panel applets.

## Windows CE

### Enabling and Disabling



Settings

From the CV60 desktop, select **Start > Settings > Control Panel**, then double-click the **Settings** desktop icon. Click the **Com Ports** tab, then click **Com 1 - 5 Volt Enabled** to activate the tethered scanner. See page 44 for more information about this control panel applet.

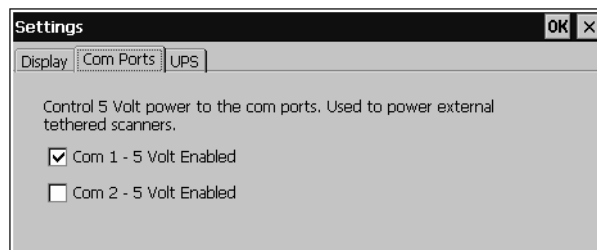

## Scanner Cabling

Sabre 1551E / 1553 Cables connect directly to the CV60 COM Port.

## Windows XP

### Enabling and Disabling



From the CV60 desktop, select **Start > Settings > Control Panel**, then double-click the **CV60** icon. Click the **Com 1 - 5 Volt Enabled** checkbox to activate the tethered scanner.

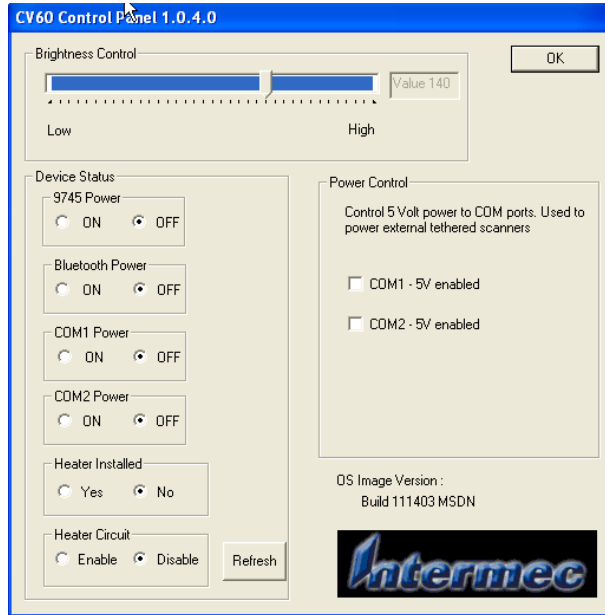



## Scanner Cabling

Sabre 1551E / 1553 Cables connect directly to the CV60 COM Port.

When enabled, the 1551/1553 menu option has these capabilities:

- Grid Data Editing is available.
- The source of the symbology configurations is only available via the Easy Set command labels. Only the Virtual Wedge configurations can be configured via the Intermec Settings control panel applet.
- May transmit the data through the keyboard interface (via the Virtual Wedge).
- The bar code APIs, defined in the IADC interface, are available to get bar code data from the bar code scanner. The following example shows how to programmatically collect bar code data:

```
#include "IADC.h" // Linked with ITCUUID.LIB
#include "ITCAdcMgmt.h" // Linked with ITCAdcDevMgmt.lib

IADC* pIADC;
HRESULT hrStatus = S_OK;

// Create a ADC COM interface to collect bar code data from the 1551E/1553
// when the 1551/1553 menu option is enabled.
hrStatus =
ITCDeviceOpen(TEXT("ExtScanner"), // Name of the ADC device.
IID_IADC, // COM interface to return
ITC_DHDEVFLAG_READAHEAD, // Device's Flags
(LPVOID *) &pIADC); // the returned interface

if( SUCCEEDED(hrStatus) )
{
BYTE byteBuffer[MAX_LABEL_SIZE];
DWORD dwLength = 0;
HRESULT hr = pIADC->Read(
byteBuffer, // Buffer to put the ADC data.
MAX_LABEL_SIZE, // Size of pDataBuffer in bytes.
&dwLength, // Number bytes returned.
NULL, // Time stamp of the received data. NULL.
INFINITE // Number of milliseconds to wait.
);
}

when done using this COM interface, delete it:
ITCDeviceClose( (IUnknown **) pIADC);
```

## How to configure tethered scanners 1551E/1553/1800/1400

Tethered scanners can be configured from the “Intermec Settings” on the CV60. Follow these steps:

- 1 Connect a tethered scanner to the tethered scanner port.
- 2 Under the tethered scanner folder, select the scanner model to match the attached scanner type. If the scanner port state is not already enabled, then enable it.



**Note:** during this process the terminal is trying to communicate to the attached scanner.

You will see a “Failed to save one or more settings” message if:

- the scanner is not powered
- the cable is not properly connected
- if the wrong cable is used
- if the scanner firmware is older than version 2.0.



**Note:** that this process can take up to 8 seconds since the terminal is going through a group of RS323 settings to trying to communicate with the scanner.

The auto-baud process is performed whenever the scanner port state is changed from Disable to Enable or whenever the 1551E/1553 is selected from the scanner model list and the scanner port state is enabled.

If the auto-baud process is successful, about eight beeps will be generated, and it is followed by another series of beeps depending on the firmware version installed in the scanner. The latter series of beeps are suppressed since FW 2.08.



# 5 Developing and Installing Applications

In this chapter you will find guidelines for developing applications using the Software Developer's Kit (SDK) and converting existing Trakker Antares applications using the Programmer Software Kit (PSK).

The CV60 can be ordered with a choice of three operating systems: Windows CE, Windows XP, and Windows XP Embedded (XPE).

The following are references to the operating systems, used throughout this chapter:

- CV60 CE refers to Windows CE platform.
- CV60 XP/XPE refers to the XP and XP Embedded platforms.
- CV60 refers to all three platforms.

## Developing Applications for the CV60

The CV60 Vehicle-Mount Computer runs applications programmed in Microsoft C++ and also run applications developed for the .NET framework using Microsoft C#.

Use this section to understand how to:

- Convert a Trakker Antares application to a CV60 application
- Develop a new application for the CV60
- Develop a web-based application for the CV60

### Developing a New Application for the CV60

Use the Intermec SDK to develop new applications to run on the CV60. The Intermec SDK is a library of C++ language functions you can use to create applications for the CV60.

See the SDK online user's manual for help developing your application. The *Intermec SDK User's Manual* contains hardware and software requirements, all of the functions that are supported by the CV60, and how to use these functions.

You need these hardware and software components to use the Intermec SDK:

- Pentium PC, 400 MHz or higher
- Windows 2000 (Service Pack 2 or later) or Windows XP (Home, Professional, or Server)
- **For CV60 CE:** Microsoft eMbedded Visual C++ version 4.0 with Service Pack 2 for native C++ development
- **For CV60 XP/XPE:** Microsoft Visual C++ 6.0 and the Microsoft Platform SDK
- 128MB RAM (196MB recommended)
- 360MB Hard drive space for minimum installation (720MB for complete)
- CD-ROM drive compatible with multimedia PC specification
- VGA or higher-resolution monitor (Super VGA recommended)
- Microsoft Mouse or compatible pointing device

The SDK is part of the Intermec Developer's Library (IDL) and is available on CD (P/N 235-114-001) or as a download from the Intermec web site at [www.intermec.com](http://www.intermec.com).

## Converting a Trakker Antares Application to a CV60 CE Application

If you have an existing Trakker Antares application that you would like to run on the CV60, you can use the Programmer's Software Kit (PSK) to convert it. The CV60 PSK is a set of libraries and tools that you use to convert your existing Trakker Antares C applications into C/C++ applications for use on your CV60 CE Data Collection Computer.



**Note:** Only CV60 CE supports the PSK.

The CV60 does not support all Trakker Antares PSK functions. You may need to rewrite parts of your application when converting it for use on the CV60.

See the PSK online manual for a list of functions that are not supported.

You need these hardware and software components to use the PSK:

- PC with at least 300 MB of free disk space running Microsoft Windows 2000/XP.
- Microsoft eMbedded Visual C++ version 4.0 with Service Pack 2
- Intermec SDK and development tools
- Intermec PSK which contains these files and utilities:
  - PSK functions library
  - Header files
  - Example files

The PSK is part of the Intermec Developer's Library (IDL) and is available on CD (P/N 235-114-001) or as a download from the Intermec web site at [www.intermec.com](http://www.intermec.com).

## Developing a Web-Based Application

You can develop web-based data collection applications for use on the CV60. For help, see any HTML source book. The CV60 ships with Internet Explorer 6.0.

## Installing Applications on the CV60

You can install files and applications on the CV60 several ways; if you have a simple application, you might only need to deliver the EXE file. You can simply copy a directory structure that contains the application, supporting files, DLLs, images, sound files, and data files to the device.

For CV60 CE, you can package your application as a cabinet (CAB) file.

The delivery methods are:

- ActiveSync
- Wavelink Avalanche
- Drive mapping.

The following sections explain each of these processes you use to install your application on the CV60.

### All CV60:

#### Installing Applications Using Wavelink Avalanche

You can use the Wavelink Avalanche device management system to install applications on all of your wireless CV60s.

The CV60 ships with the Avalanche Enabler already installed. Each time the Avalanche Enabler is activated (typically on a warm boot), the CV60 attempts to connect to the Avalanche Agent. When the CV60 connects to the agent, the agent determines whether an update is available and immediately starts the software upgrade, file transfer, or configuration update.

#### To use Avalanche to remotely manage the CV60

- 1 Install software packages and updates for the CV60 using the Avalanche Administrative Console.
- 2 Schedule the CV60 updates or manually initiate an update using the Avalanche Administrative Console.

For more information on using Wavelink Avalanche, contact your local Intermec representative or visit the Wavelink web site at [www.wavelink.com](http://www.wavelink.com).

### CV60 CE only:

#### Using ActiveSync to Install Applications

You can use ActiveSync to establish a connection between your desktop PC and the CV60 CE. ActiveSync allows you to transfer files, synchronize files, perform remote debugging, and other device management activities.

ActiveSync is a free application available from the Microsoft web site at <http://www.microsoft.com> (search for ActiveSync).

To establish a partnership between your desktop PC and the CV60 CE, you will need:

- Female-to-female null modem serial cable
- ActiveSync version 3.7 or later.

## Installing ActiveSync and Establishing a Partnership

You can use a serial cable to establish your initial partnership between the CV60 CE and your desktop PC.

### To install ActiveSync and establish a partnership

- 1 Download ActiveSync from the Microsoft web site and follow the on-screen instructions for installing it on your desktop PC.
- 2 When the installation process is complete, the Get Connected dialog box appears.
- 3 Connect the CV60 CE to your desktop PC with the serial cable.
- 4 Click **Next** in the Get Connected dialog box. ActiveSync detects a device on the serial port and prompts you to set up a new partnership.
- 5 In the Set Up a Partnership dialog box, click **Next**.
- 6 In the Select Number of Partnerships dialog box, select **Yes, I want to synchronize with only this computer** and then click **Next**.
- 7 In the Select Synchronization Settings dialog box, check the items you want to synchronize and click **Next**.
- 8 In the Setup Complete dialog box, click **Finish**.

When the partnership is established, the following screen appears on your desktop showing the device name of your CV60 and the Connected status.

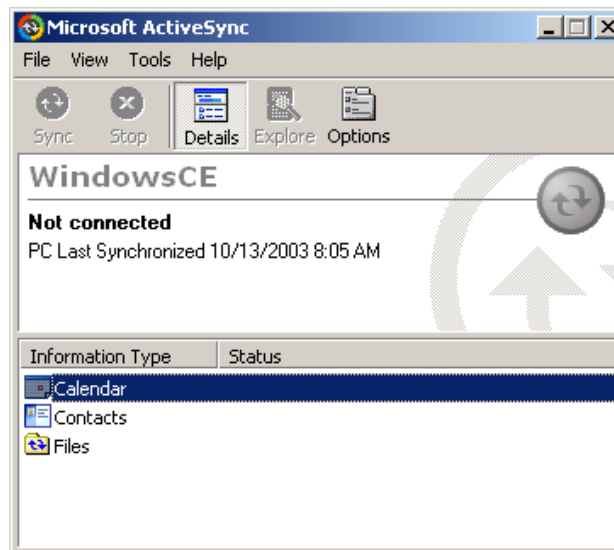

## The Microsoft ActiveSync Screen

An ActiveSync icon (  ) also appears on the CV60 CE status bar indicating that it has established an ActiveSync partnership with your desktop PC.



**Note:** If ActiveSync does not establish a partnership on the first try, the Get Connected dialog box appears on your desktop with the message “Your device was not detected.” Click Next on the Get Connected dialog box until your device is detected.

Now that the partnership has been established, ActiveSync initiates all future connections.

### Using ActiveSync to Copy Files and Install Applications

You can use ActiveSync to copy files to the CV60 CE and to install applications. To install an application, you need to copy the CAB file to a directory on the CV60 CE and then run it. Use the following procedures to learn how to copy files and install applications on the CV60 CE using ActiveSync.

#### To install an application on the CV60 CE using ActiveSync

- 1 Connect the CV60 CE to your desktop PC using ActiveSync. For help, see the previous section, “Installing ActiveSync and Establishing a Partnership.”
- 2 In the Microsoft ActiveSync screen, click **Explore**. Windows Explorer opens the Mobile Device window of your CV60 CE.
- 3 In Windows Explorer on your desktop PC, browse to the file that you want to copy to your CV60 CE.
- 4 Right-click the file and click **Copy**.
- 5 Place the cursor in the folder of your CV60 CE, right-click, and click **Paste**.

The file has now been copied to the CV60 CE and you can see it using the CV60 CE File Manager. Navigate to your application file and run it.



**CV60 XP/XPE:****Mapping a network drive:**

You can transfer files between your desktop PC and the CV60 XP/XPE by mapping a network drive.

To map a network drive, perform the following steps: You may need help from your IT department for some of the following steps.

- 1 From your desktop, right-click My Network Places, and from the pop-up menu select **Map Network Drive**.

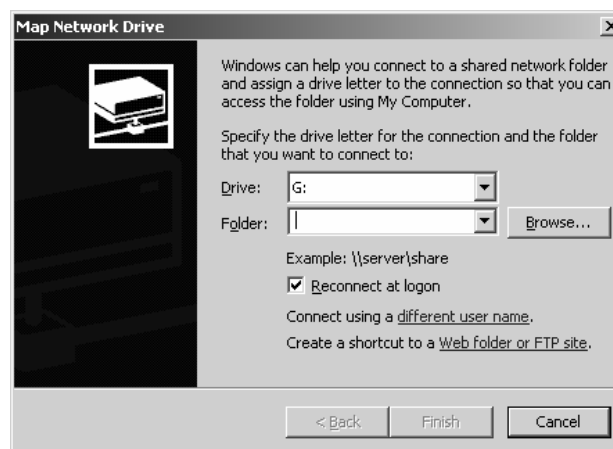

- 2 From the drive drop-down menu, select the drive you wish to map.
- 3 In the Shared Directories menu, click the directory you are going to map.
- 4 You may wish to map to a folder inside a network drive. If so, double-click the directory to expose the underlying folders. Click the desired folder.
- 5 The information about the drive you are mapping is shown at the top of the Map Network Drive pop-up window.
- 6 Drive: The chosen drive.
- 7 Path: Specified path to desired folder in chosen drive. **Connect As:** Your login name.
- 8 Click OK.



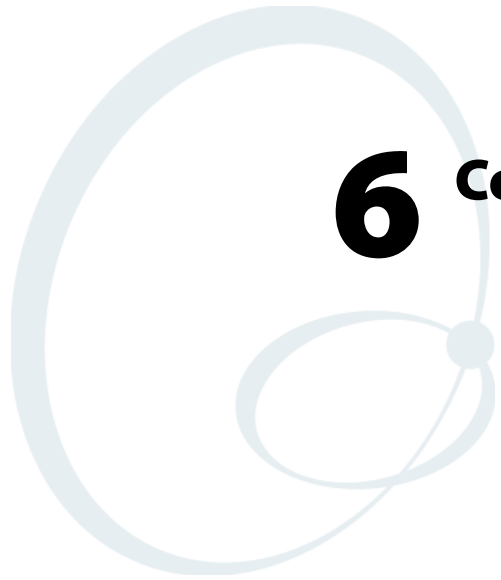

# **6 Connector Pinouts**

This chapter details the CV60 Vehicle-Mount Computer connectors.

## Connectors

Connectors are located on the bottom of the computer and are identified below.

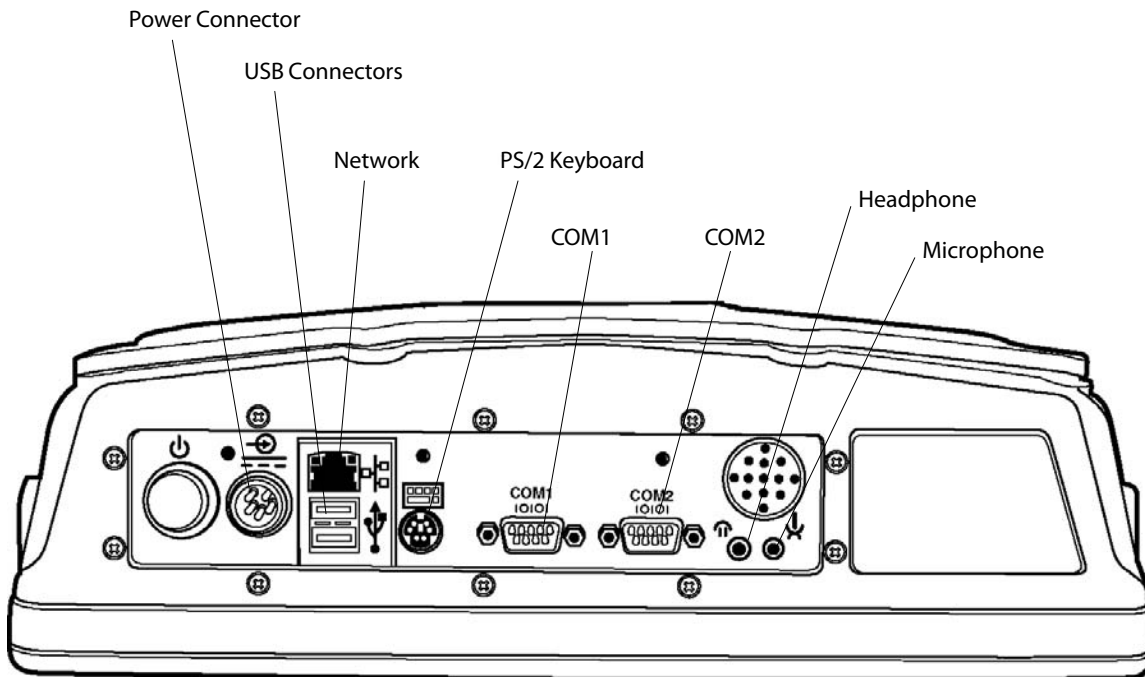

## Connectors

Each COM serial port has its own address and uses a 9-pin male connector to attach RS-232 serial devices, such as a printer, a mouse, an external modem, a scanner, or a serial network connection.

### COM Port Pinout

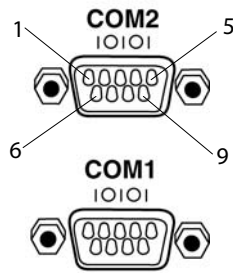

### COM Port Pinout (COM1 & COM2 identical)

Pin	Description
1	RS232 DCD
2	RS232 RXD
3	RS232 TXD
4	RS232 DTR
5	GND
6	RS232 DSR
7	RS232 RTS
8	RS232 CTS
9	RS232 RI & +5V for external tethered scanner

### Keyboard PS/2

This 6-pin mini-DIN, PS/2-standard connectors connect an external keyboard to the computer.

Where an external keyboard is not connected to the computer, you may use an emulated keyboard (if available in your application) that can be activated on the display.

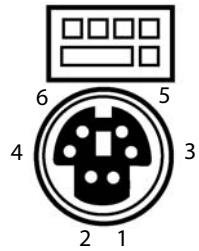

Pin	Description
1	Keyboard Data
2	NC
3	GND
4	NC
5	+5 Volts DC
6	Keyboard Clock

## Ethernet

The RJ-45 type 8-pin modular connector shown below provides an interface to an Ethernet local area network. Pinouts are as shown below when the user views the connector straight on from the outside of the computer.

Once a valid link is detected, whether it is 10Base-T or 100Base-T, the green LED light on the connector will be ON. The yellow LED flash will if there is any activity on the Ethernet LAN port.

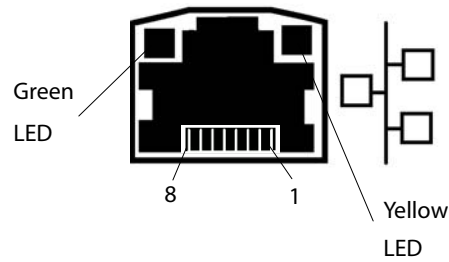

Pin	Signal
1	TX+
2	TX-
3	RX+
4	GND
5	GND
6	RX-
7	GND
8	GND

### USB Connectors

There are 2 external USB 1.1 ports that can be used for connection to common serial type devices such as a mouse or keyboard.

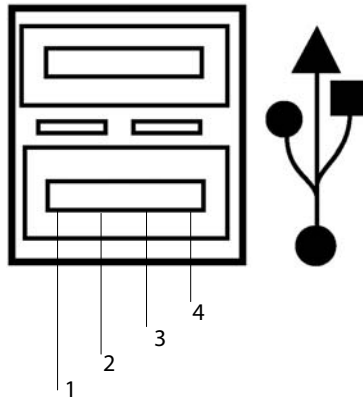

Pin	Signal
1	+5V
2	USB_DATA-
3	USB_DATA+
4	Ground

### Audio Connections

The microphone and headphone jacks are shown below.

#### Microphone / Headphone

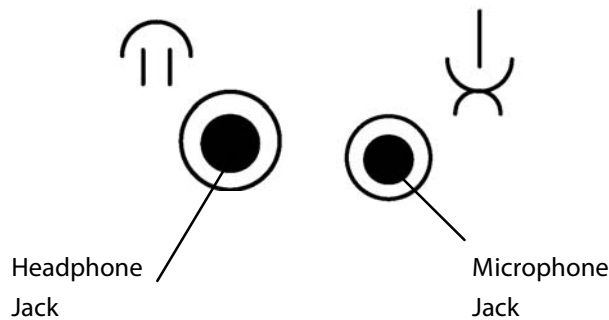

**Note:** The headphone jack functions as an audio line out, and the speaker audio is not disconnected. The microphone jack is a combination mic/headset jack **which disconnects the speaker** when the plug is inserted.



## Power Connector Pin out

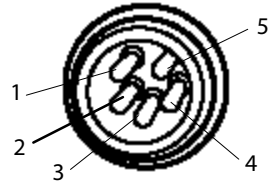

Pin	Description
1	Chassis GND
2	System Line
3	System Neutral
4	Heater Neutral
5	Heater Line











**Corporate Headquarters**

6001 36th Avenue West  
Everett, Washington 98203  
U.S.A

**tel** 425.348.2600

**fax** 425.355.9551

[www.intermec.com](http://www.intermec.com)

CV60 User's Manual - October 2004



\*961-054 -033B\* Rev B