

## MEASUREMENT/TECHNICAL REPORT



### Intermec Technologies Corporation ABTM3 Radio Module

**REPORT NO: 20011018-1**

**DATE: October 18, 2001**

This report concerns: ABTM3 Radio Module, Hybrid Mode Operation	
Equipment Type: 2400- 2483.5 MHz Frequency Hopping Spread Spectrum Transceiver, FCC 15.247 Industry Canada RSS-210 Issue 4	
Measurement procedure used: FCC Guidance for DSSS Systems FCC 97-114	
Report Prepared by:	Report Prepared For:
Dave Fry Intermec Technologies Corporation EMC Test Lab 550 Second Street S.E. Cedar Rapids, Iowa 52401 Phone: (319) 846-2415 FAX: (319) 846-2475	Intermec Technologies Corporation 550 Second Street S.E. Cedar Rapids, Iowa 52401 Phone: (319) 369-3100 FAX: (319) 369-3299

**This report contains data that is outside the NVLAP scope of accreditation.**

**This report shall not be reproduced, except in full, without the permission of Intermec Technologies Corporation, EMC Test Laboratory, Cedar Rapids, IA.**

## **TABLE OF CONTENTS**

- 1.0 Compliance Certification
  - 1.1 Measurement Uncertainties
  
- 2.0 Report Reference
  
- 3.0 Hybrid Mode Characteristics
  - 3.1 Operation Description
  - 3.2 Process Gain
  - 3.3 Average Time of Channel Occupancy
  - 3.4 Channel Separation and Bandwidth
  - 3.5 Power Spectral Density
  
- 4.0 Measurement Equipment List

APPENDIXES (may be file attachments for electronic applications of approval)

- A. 011018A1.xxx Operational Description
- B. 011018B1.xxx CSR Process Gain Memorandum

xxx = file extension .doc, .xls or .pdf

## 1.0 COMPLIANCE CERTIFICATION

**The electromagnetic compatibility test and data evaluations findings of this report have been prepared by the EMC Test Lab, Intermec Technologies Corporation, in accordance with applicable specifications instructions required per-**

<u>FCC SECTION</u>	<u>CANADA RSS-210</u>	<u>TEST NAME</u>
15.247 (f)	6.2.2(o)(c)	Hybrid Systems Process Gain Average Time Channel Occupancy Channel Separation and Bandwidth 20 dB BW 6 dB BW Power Spectral Density

**The data, data evaluation and equipment configuration represented herein are a true and accurate representation of the measurements of the test sample's electromagnetic compatibility characteristics as of the dates and at the times of the test under the conditions herein specified. The data presented herein is traceable to the National Institute of Standards and Technology.**

**This report is not an endorsement of the tested product by NVLAP or any agency of the U.S. Government.**



Accredited by the National Institute of Standards and Technology, National Voluntary Laboratory Accreditation Program for the specific scope of accreditation under Lab Code 100269-0.

The scope of accreditation at the EMC Test Laboratory is limited to NVLAP codes:

12/CIS22 IEC/CISPR 22:1993: Limits and methods of measurement of radio disturbance characteristics of information technology equipment. 12/CIS22a IEC/CISPR 22:1993: Limits and methods of measurement of radio disturbance characteristics of information technology equipment, Amendment 1:1995, and Amendment 2:1996. 12/CIS22b CNS 13438:1997: Limits and methods of measurement of radio disturbance characteristics of information technology equipment. 12/F01 FCC Method - 47 CFR Part 15 - Digital Devices. 12/F01a Conducted Emissions, Power Lines, 450 kHz to 30 MHz. 12/F01b Radiated Emissions. 12/T51 AS/NZS 3548: Electromagnetic Interference - Limits and Methods of Measurement of Information Technology Equipment.

Intermec Technologies Corporation  
EMC Test Laboratory  
550 Second Street S.E.  
Cedar Rapids, Iowa 52401



Interference  
Technology  
International

Dave Fry  
Regulatory Engineer II

Date 10/18/01  
mm/dd/yy



National Association of  
Radio and  
Telecommunications  
Engineers

## 1.1 Measurement Uncertainty

### Confidence Statement

The measurement uncertainty statements below use a Coverage Factor  $K = 2$ .  
The Coverage Factor  $K = 2$  equates to an approximate confidence level of 95%.

### Receiver and Transmitter Direct Measurements Of Conducted Emissions Using HP8566B Spectrum Analyzer and HP85685A Preselector

- 0-1.0 GHz has an Expanded Measurement Uncertainty of  $\pm 2.36$  dB.
- 1.0-2.0 GHz has an Expanded Measurement Uncertainty of  $\pm 3.50$  dB.
- 2.0-2.5 GHz has an Expanded Measurement Uncertainty of  $\pm 0.85$  dB.

### Tektronix TDS460

- Amplitude Measurements Expanded Measurement Uncertainty,  $\pm 1.5\%$  full scale
- Time Measurements Expanded Measurement Uncertainty,  $\pm 0.015\%$

## 2.0 REPORT REFERENCE:

The ABTM3 radio module description is contained within reports from CKC  
Report No.: FC01-057 and is supplemented with Intermec Report No.: 577-500-988.

## 3.0 HYBRID MODE OPERATION

### 3.1 OPERATION DESCRIPTION

See Appendix A for details of radio operation.

### 3.2 PROCESS GAIN

The radio chip within the ABTM3 radio is manufactured by Cambridge Silicon Radio, Part Number BC01B. See Appendix B for the Process Gain Memorandum from CSR.

### 3.3 TRANSMITTER AVERAGE TIME OF CHANNEL OCCUPANCY

An ABTM3 radio module is modified to direct connect the output of the transmitter to the measurement equipment. The output of the radio is 50 Ohms.

Conditions during testing

Temp: 22C, RH: 40%, BP: 29.8 inches

Performed By: Dave Fry

Oct. 17, 2001

### Equipment Setup:

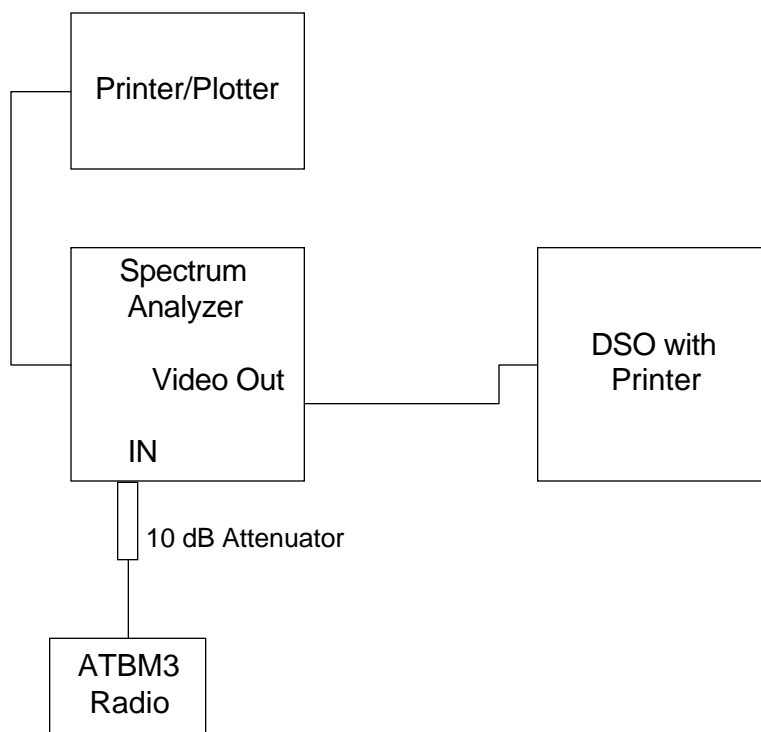

See section 4.0 for equipment list.

### Test Procedure:

- 1) Prior to making conducted measurements of the transmitter, verify the cable losses and attenuation for conducted measurements in the frequency band of interest.
- 2) Connect the modified radio directly to the spectrum analyzer input using the calibrated cable and attenuator. Set the radio to “inquiry” mode and plot the transmitter channels in the permitted band. Use 100kHz resolution and video bandwidths.
- 3) Repeat for “page” mode operation.
- 4) To measure the narrow transmission widths accurately connect a digital storage oscilloscope (DSO) to the spectrum analyzer video out.
- 5) Set the spectrum analyzer on a center frequency of 2441 MHz (Ch. 40) of the transmitter. Using 0 Hz span with 100 kHz RBW and 100kHz VBW plot a 20 msec sweep while the transmitter is operating in inquiry mode in the above configuration. Print this plot that shows the transmission cycle.
- 6) While the radio continues to transmit use the DSO to show a similar plot at 2 mS/division. Using the cursors to mark the repetition rate and print this plot.
- 7) Make a second DSO plot that details the transmission time on channel.
- 8) Calculate the worst-case average transmitter average occupancy based on the plotted information presented.

**Data Plots:**

DSO plot of inquiry / page mode channel cycle time

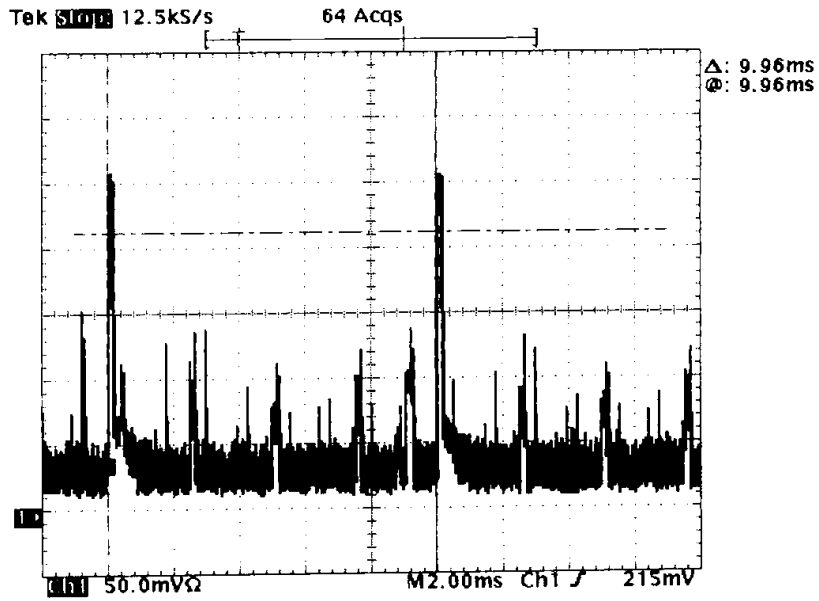

DSO plot of inquiry / page mode channel transmission on time

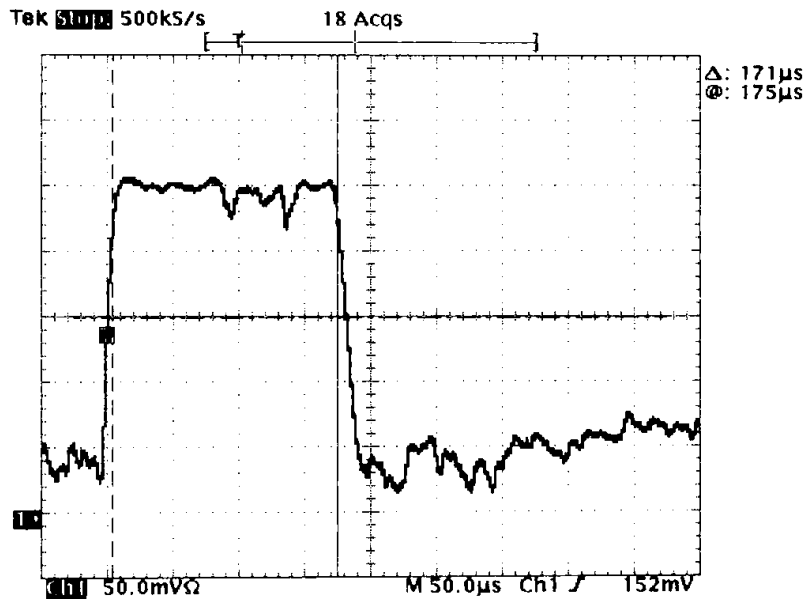

Page mode number of hopping frequencies

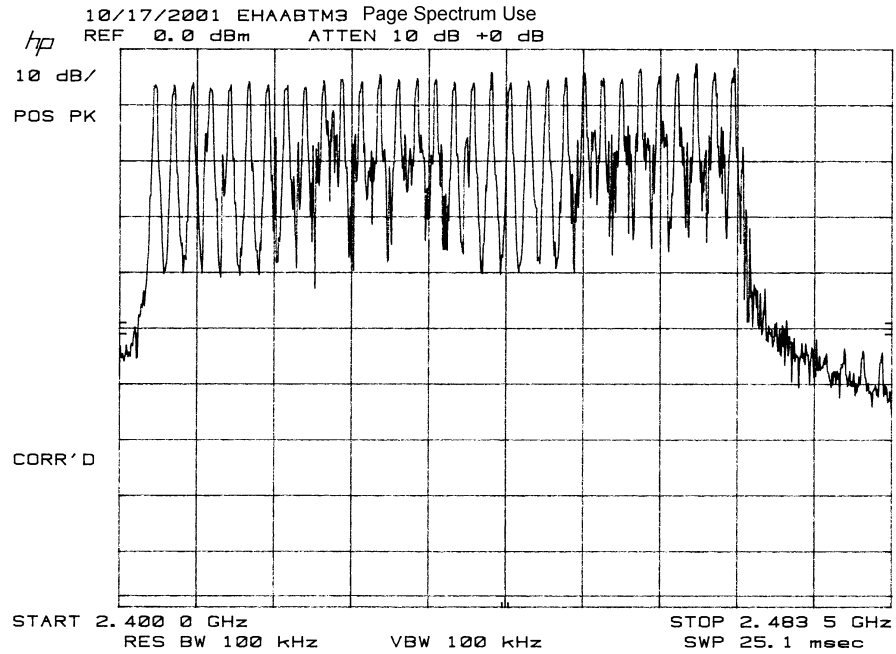

Inquiry mode number of hopping frequencies

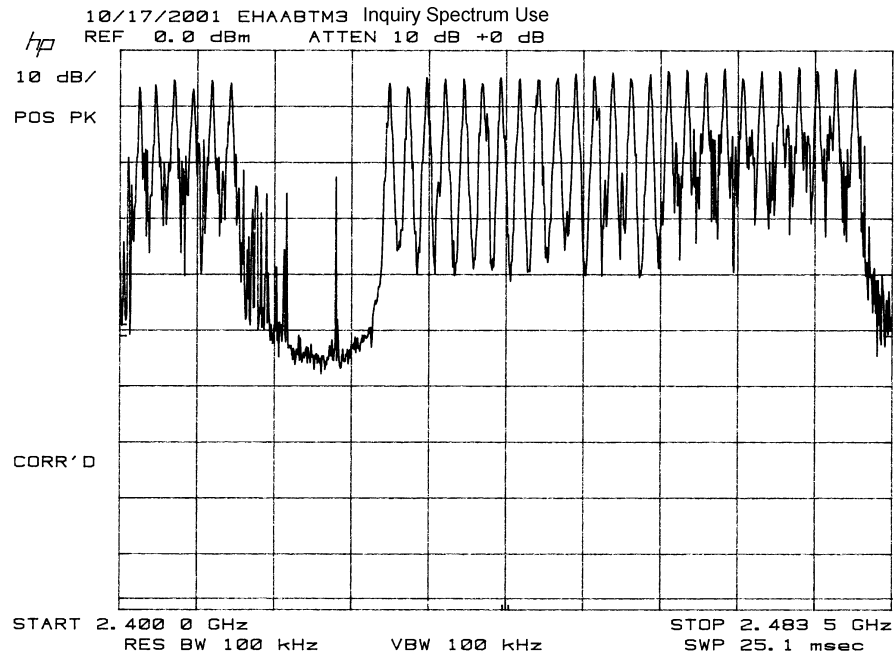

## Results:

“Page” and “Inquiry” modes operate by first hopping with 16 channels. This “Train A” sequence repeats every 10 mS. Every 1.28 seconds hopping frequencies change and a second Train A starts using different frequencies resulting in 128 transmissions on a frequency or channel. After a maximum of seven “Train A” sequences of 1.28 seconds, 16 new hopping channels is selected, “Train B”. If a same frequency is used in both Train A and B, the resulting worst case conditions occur. First  $7 \times 1.28 \times 10\text{mS}$ , the next 7 sequences with Train B, then with other frequencies. Calculating the results below.

1<sup>st</sup> 128 events  $\times$  7 Train A sequences  $\times$  10mS = 8.96 seconds

2<sup>nd</sup> 128 events  $\times$  7 Train B sequences  $\times$  10mS = 8.96 seconds

3<sup>rd</sup> series of events uses a different frequency for 8.96 seconds

Or  $8.96 \times 3 =$  total of 26.8 seconds

$7 \times 128 \times 171\mu\text{S}$ , then 8.96 seconds other frequencies,  $+ 7 \times 128 \times 171\mu\text{S} = .306$  seconds within an average 30 second period considering the random selection of hopping sequences over time.

### 3.4 Channel Separation and Bandwidth

#### Test Procedure:

- 1) Prior to making conducted measurements of the transmitter, verify the cable losses and attenuation for conducted measurements in the frequency band of interest.
- 2) Connect the modified radio directly to the spectrum analyzer input using the calibrated cable and attenuator. Use a 5 MHz span 100kHz resolution and video bandwidths. Set the radio to “inquiry” and “page” mode. Show the channel spacing using the delta function of the spectrum analyzer. Plot the transmitter channels.
- 3) Adjust the spectrum analyzer for a 2 MHz span using 100 kHz resolution and video bandwidths. Plot the spectrum of the transmitter without the hopping mode engaged. Using the peak search mode determine the peak of the channel occupancy. Calculate 6 dB down from the peak and use the display line to show the 6-dB reference. Adjust the marker to the left side of the spectrum to the display line. Using the marker delta function move to show the 6-dB bandwidth of the transmitter spectrum and plot.
- 4) Adjust the spectrum analyzer for a 2 MHz span using 30 kHz resolution and video bandwidths. Plot the spectrum of the transmitter without the hopping mode engaged. Using the peak search mode determine the peak of the channel occupancy. Calculate 20-dB down from the peak and use the display line to show the 20-dB reference. Adjust the marker to the left side of the spectrum to the display line. Using the marker delta function move to show the 20-dB bandwidth of the transmitter spectrum and plot.



### Data Plots:

#### Channel Spacing

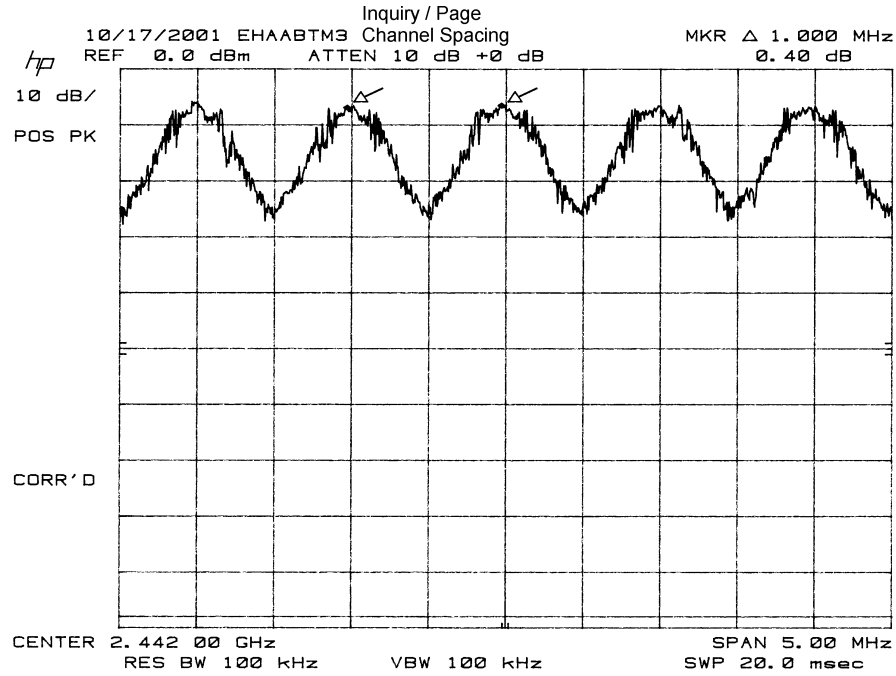

#### 20 dB Bandwidth

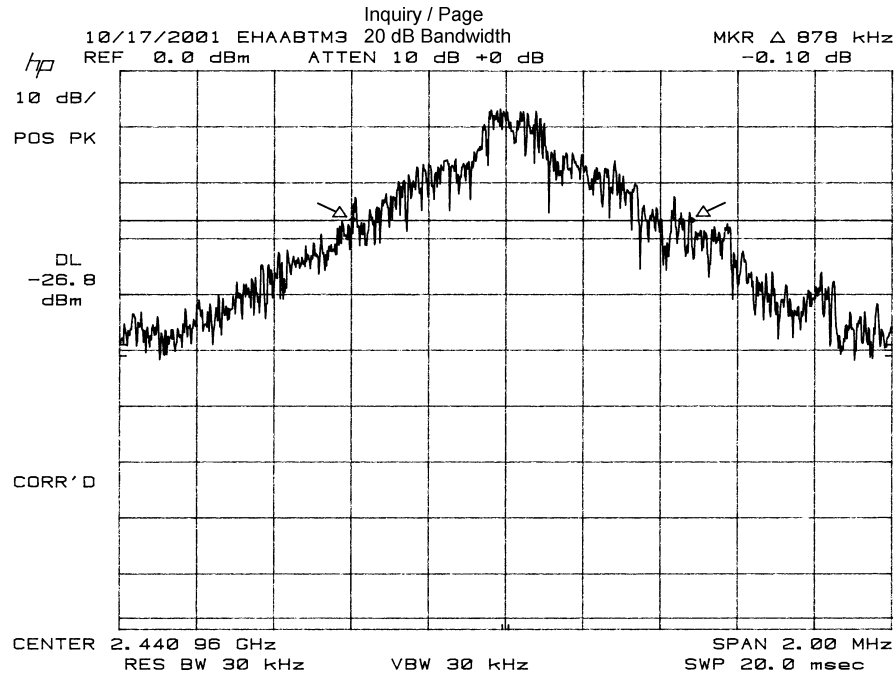

## 6 dB Bandwidth

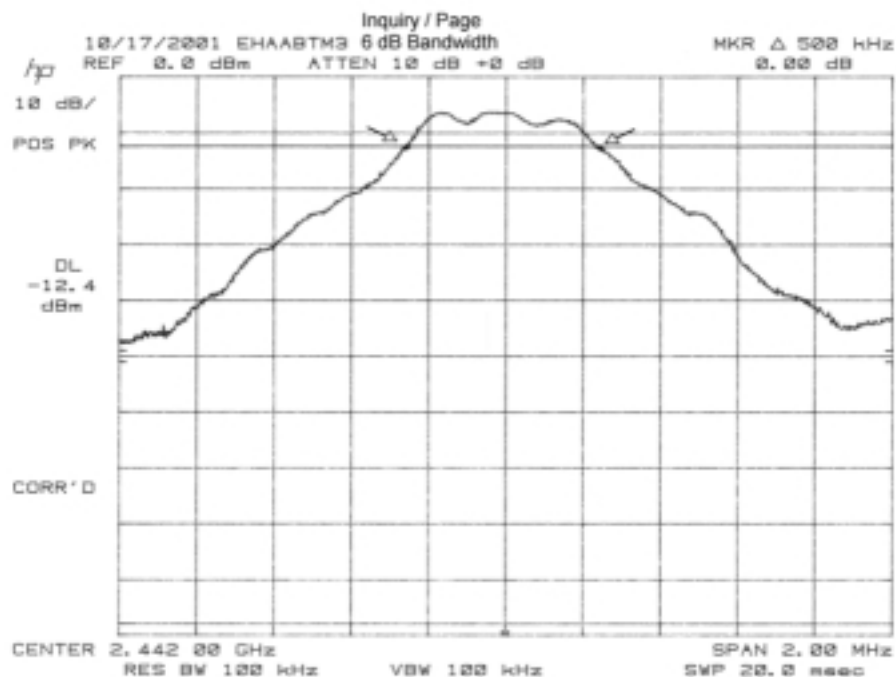

## Results:

The channel spacing equals 1 MHz. This does meet the 25 kHz minimum and is near the 878 kHz channel bandwidth.

The 20-dB bandwidth equals 878 kHz for the center channel 2442 MHz. Similar results were observed for the end channels 2402 and 2480 MHz. This meets the requirement of 20-dB bandwidth maximum of 1 MHz.

The 6-dB bandwidth equals 500 kHz for the center channel 2442 MHz. Similar results were observed for the end channels 2402 and 2480 MHz. This meets the requirement of 6-dB bandwidth maximum of 500 kHz.

### 3.5 Power Spectral Density

#### Test Procedure:

- 1) Prior to making conducted measurements of the transmitter, verify the cable losses and attenuation for conducted measurements in the frequency band of interest.
- 2) Connect the modified radio directly to the spectrum analyzer input using the calibrated cable and attenuator. Use 1.5 MHz span, 3 kHz resolution and video bandwidths. Set the radio to “inquiry” and “page” mode. Show the peak of the channel emission using the peak search function of the spectrum analyzer. Plot the transmitter spectrum as the preliminary power spectral density.
- 3) Adjust the spectrum analyzer for a 150 kHz span using 3 kHz resolution and video bandwidths and set the sweep time for 50 seconds. Center the peak emission shown in the previous step on the spectrum analyzer. Plot the spectrum of the transmitter without the hopping mode engaged. Using the peak search mode determine the peak power spectral density and plot the final power spectral density.

#### Data Plots:

##### PSD Preliminary

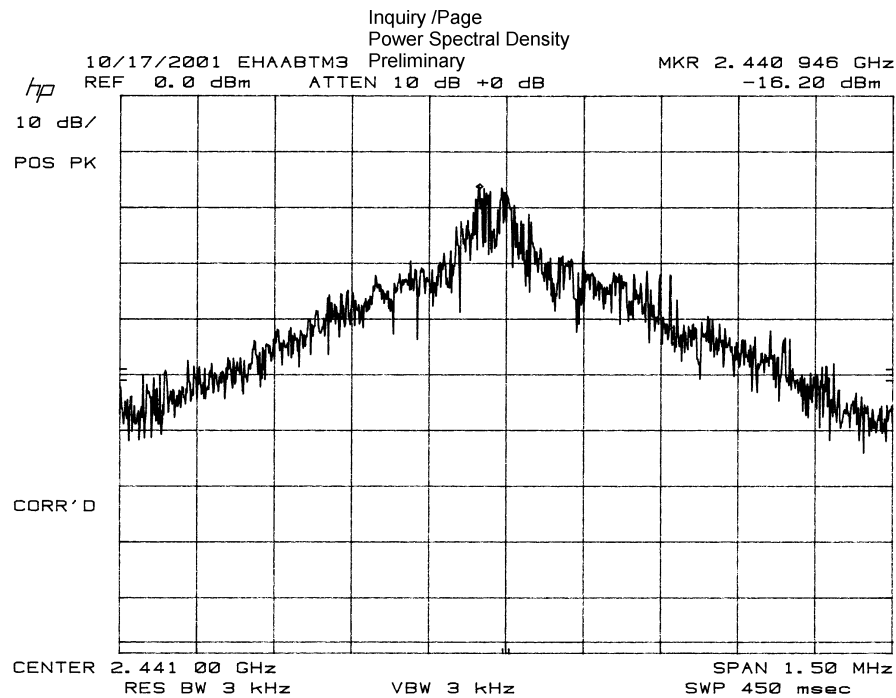

PSD Final

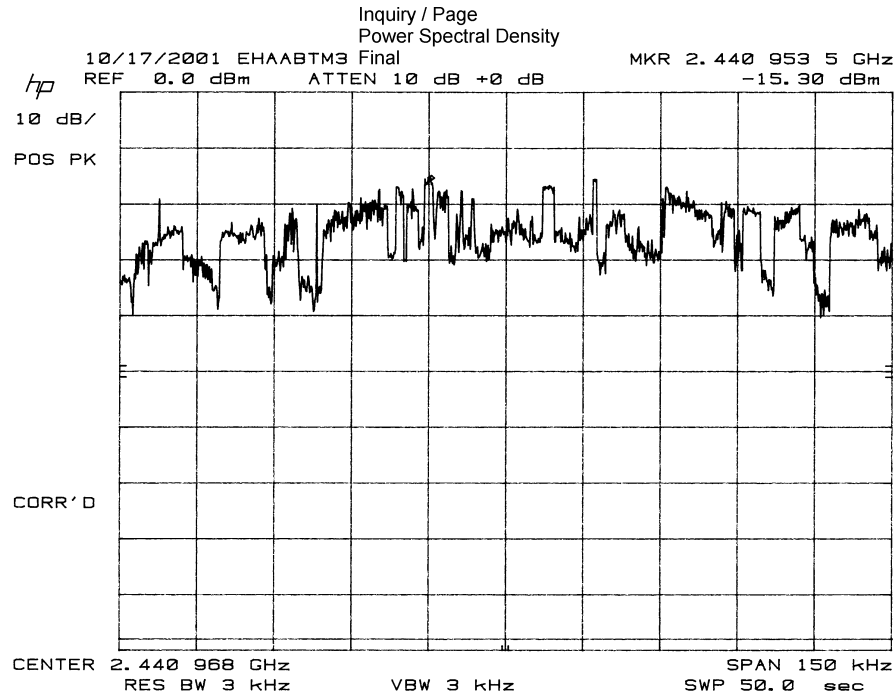

**Results:**

The attenuation for the cable and attenuator is measured as 10.1 dB. The results for power spectral density equals -5.3 dBm. This is well below the specification of +8dBm. Channels at either end of the spectrum also show similar results.

**4.0 Measurement Equipment List**

<u>EQUIPMENT</u>	<u>MFG/MODEL</u>	<u>SERIAL NO.</u>	<u>CALIBRATION</u>	
			<u>DATE</u>	<u>CYCLE</u>
Attenuator	HP 8491-10 dB	43380	09/01	12 Mo
Plotter	HP 7470A	2308A27380	On Req.	
RF Preselector	HP 85685A	3221A01427	10/01	12 Mo
Signal Generator	HP 83630A	3250A00322	03/00	24 Mo
Spectrum Analyzer	HP 8566B	2637A03549	10/01	12 Mo
Digital Oscilloscope	Tektronix TDS460	B020349	12/00	16 Mo

On Req. = On Request