



# FCC TEST REPORT

**REPORT NO.:** RF960919L10A  
**MODEL NO.:** PB50  
**RECEIVED:** Nov. 07, 2007  
**TESTED:** Nov. 08 ~ Nov. 15, 2007  
**ISSUED:** Nov. 19, 2007

**APPLICANT :** Intermec Technologies Corporation

**ADDRESS :** 550 Second Street SE, Cedar Rapids, IA 52401,  
USA

**ISSUED BY :** Advance Data Technology Corporation

**LAB ADDRESS :** No. 47, 14<sup>th</sup> Ling, Chia Pau Tsuen, Lin Kou Hsiang  
244, Taipei Hsien, Taiwan, R.O.C.

**TEST LOCATION :** No. 19, Hwa Ya 2<sup>nd</sup> Rd., Wen Hwa Tsuen, Kwei  
Shan Hsiang, Taoyuan Hsien 333, Taiwan, R.O.C.

This test report consists of 53 pages in total. It may be duplicated completely for legal use with the approval of the applicant. It should not be reproduced except in full, without the written approval of our laboratory. The client should not use it to claim product endorsement by TAF, A2LA or any government agencies. The test results in the report only apply to the tested sample.





## Table of Contents

1	CERTIFICATION.....	4
2	SUMMARY OF TEST RESULTS.....	5
2.1	MEASUREMENT UNCERTAINTY.....	5
3	GENERAL INFORMATION .....	6
3.1	GENERAL DESCRIPTION OF EUT .....	6
3.2	DESCRIPTION OF TEST MODES .....	7
3.2.1	CONFIGURATION OF SYSTEM UNDER TEST .....	7
3.2.2	TEST MODE APPLICABILITY AND TESTED CHANNEL DETAIL .....	8
3.3	GENERAL DESCRIPTION OF APPLIED STANDARDS.....	10
3.4	DESCRIPTION OF SUPPORT UNITS.....	10
4	TEST TYPES AND RESULTS.....	11
4.1	RADIATED EMISSION MEASUREMENT .....	11
4.1.1	LIMITS OF RADIATED EMISSION MEASUREMENT.....	11
4.1.2	TEST INSTRUMENTS.....	12
4.1.3	TEST PROCEDURES .....	13
4.1.4	DEVIATION FROM TEST STANDARD .....	13
4.1.5	TEST SETUP .....	14
4.1.6	EUT OPERATING CONDITIONS .....	14
4.1.7	TEST RESULTS .....	15
4.2	CONDUCTED EMISSION MEASUREMENT .....	22
4.2.1	LIMITS OF CONDUCTED EMISSION MEASUREMENT.....	22
4.2.2	TEST INSTRUMENTS.....	22
4.2.3	TEST PROCEDURES .....	23
4.2.4	DEVIATION FROM TEST STANDARD .....	23
4.2.5	TEST SETUP .....	24
4.2.6	EUT OPERATING CONDITIONS .....	24
4.2.7	TEST RESULTS .....	25
4.3	6dB BANDWIDTH MEASUREMENT .....	27
4.3.1	LIMITS OF 6dB BANDWIDTH MEASUREMENT .....	27
4.3.2	TEST INSTRUMENTS.....	27
4.3.3	TEST PROCEDURE.....	27
4.3.4	DEVIATION FROM TEST STANDARD .....	27
4.3.5	TEST SETUP .....	28
4.3.6	EUT OPERATING CONDITIONS .....	28
4.3.7	TEST RESULTS .....	29
4.4	MAXIMUM PEAK OUTPUT POWER.....	33



4.4.1	LIMITS OF MAXIMUM PEAK OUTPUT POWER MEASUREMENT .....	33
4.4.2	TEST INSTRUMENTS.....	33
4.4.3	TEST PROCEDURES .....	34
4.4.4	DEVIATION FROM TEST STANDARD.....	34
4.4.5	TEST SETUP .....	34
4.4.6	EUT OPERATING CONDITIONS .....	34
4.4.7	TEST RESULTS .....	35
4.5	POWER SPECTRAL DENSITY MEASUREMENT.....	36
4.5.1	LIMITS OF POWER SPECTRAL DENSITY MEASUREMENT .....	36
4.5.2	TEST INSTRUMENTS.....	36
4.5.3	TEST PROCEDURE.....	36
4.5.4	DEVIATION FROM TEST STANDARD .....	36
4.5.5	TEST SETUP .....	36
4.5.6	EUT OPERATING CONDITIONS .....	36
4.5.7	TEST RESULTS .....	37
4.6	BAND EDGES MEASUREMENT.....	41
4.6.1	LIMITS OF BAND EDGES MEASUREMENT .....	41
4.6.2	TEST INSTRUMENTS.....	41
4.6.3	TEST PROCEDURE.....	41
4.6.4	DEVIATION FROM TEST STANDARD.....	41
4.6.5	EUT OPERATING CONDITION.....	41
4.6.6	TEST RESULTS .....	42
4.7	ANTENNA REQUIREMENT .....	50
4.7.1	STANDARD APPLICABLE.....	50
4.7.2	ANTENNA CONNECTED CONSTRUCTION.....	50
5	PHOTOGRAPHS OF THE TEST CONFIGURATION.....	51
6	INFORMATION ON THE TESTING LABORATORIES .....	52
7	APPENDIX A – MODIFICATIONS RECORDERS FOR ENGINEERING CHANGES TO THE EUT BY THE LAB.....	53



## 1 CERTIFICATION

**PRODUCT:** 802.11g portable printer  
**MODEL NO.:** PB50  
**BRAND:** intermec  
**APPLICANT:** Intermec Technologies Corporation  
**TESTED:** Nov. 08 ~ Nov. 15, 2007  
**TEST SAMPLE:** ENGINEERING SAMPLE  
**STANDARDS:** **FCC Part 15, Subpart C (Section 15.247)**  
ANSI C63.4-2003

The above equipment (model: PB50) has been tested by **Advance Data Technology Corporation**, and found compliance with the requirement of the above standards. The test record, data evaluation & Equipment Under Test (EUT) configurations represented herein are true and accurate accounts of the measurements of the sample's EMC characteristics under the conditions specified in this report.

**PREPARED BY** :  , **DATE:** Nov. 19, 2007  
Joanna Wang / Senior Specialist

**TECHNICAL ACCEPTANCE** :  , **DATE:** Nov. 19, 2007  
Responsible for RF Long Chen / Senior Engineer

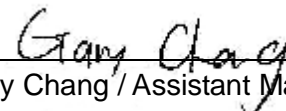
**APPROVED BY** :  , **DATE:** Nov. 19, 2007  
Gary Chang / Assistant Manager

## 2 SUMMARY OF TEST RESULTS

The EUT has been tested according to the following specifications:

APPLIED STANDARD: FCC Part 15, Subpart C			
Standard Section	Test Type and Limit	Result	Remark
15.207	AC Power Conducted Emission	PASS	Meet the requirement of limit. Minimum passing margin is -16.93dB at 0.150MHz.
15.247(a)(2)	Spectrum Bandwidth of a Direct Sequence Spread Spectrum System Limit : min. 500kHz	PASS	Meet the requirement of limit.
15.247(b)	Maximum Peak Output Power Limit: max. 30dBm	PASS	Meet the requirement of limit.
15.247(d)	Transmitter Radiated Emissions Limit: Table 15.209	PASS	Meet the requirement of limit. Minimum passing margin is -1.17dB at 774.560MHz.
15.247(e)	Power Spectral Density Limit: max. 8dBm	PASS	Meet the requirement of limit.
15.247(d)	Band Edge Measurement Limit: 20 dB less than the peak value of fundamental frequency	PASS	Meet the requirement of limit.

### 2.1 MEASUREMENT UNCERTAINTY

Where relevant, the following measurement uncertainty levels have been estimated for tests performed on the EUT as specified in CISPR 16-4-2:

Measurement	Frequency	Uncertainty
Conducted emissions	9kHz ~ 30MHz	2.44 dB
Radiated emissions	30MHz ~ 200MHz	2.93 dB
	200MHz ~ 1000MHz	2.95 dB
	1GHz ~ 18GHz	2.26 dB
	18GHz ~ 40GHz	1.94 dB

This uncertainty represents an expanded uncertainty expressed at approximately the 95% confidence level using a coverage factor of k=2.



### 3 GENERAL INFORMATION

#### 3.1 GENERAL DESCRIPTION OF EUT

<b>PRODUCT</b>	802.11g portable printer
<b>MODEL NO.</b>	PB50
<b>FCC ID</b>	EHA-WUBB
<b>POWER SUPPLY</b>	12.0Vdc from adapter 14.8Vdc from battery
<b>MODULATION TYPE</b>	CCK, DQPSK, DBPSK for DSSS 64QAM, 16QAM, QPSK, BPSK for OFDM
<b>MODULATION TECHNOLOGY</b>	DSSS, OFDM
<b>TRANSFER RATE</b>	802.11b: 11/5.5/2/1Mbps 802.11g: 54/48/36/24/18/12/9/6Mbps
<b>FREQUENCY RANGE</b>	2412MHz ~ 2462MHz
<b>NUMBER OF CHANNEL</b>	11
<b>MAXIMUM OUTPUT POWER</b>	45.709mW
<b>ANTENNA TYPE</b>	Printed antenna with 0.5dBi gain
<b>DATA CABLE</b>	1.8m non-shielded RS232 cable without core
<b>I/O PORTS</b>	Refer to user's manual
<b>ACCESSORY DEVICES</b>	Adapter, battery

**NOTE:**

1. This report is issued as a supplementary report of ADT report no. RF960919L10.
2. This report is prepared for FCC class II permissive change. Difference compared with the original report is adding the components in the radio module. Therefore, all test items had been re-tested.

COMPONENT	ORIGINAL	CLASS II CHANGE
C300	10pF	1.0nH
C301	NIL	1.0pF
C302	NIL	0.5pF

3. The EUT was powered by the following power adapter and battery:

ADAPTER	
<b>BRAND</b>	Intermec Technologies Corporation
<b>MODEL</b>	073573
<b>INPUT POWER</b>	100~240Vac, 1A, 47~63Hz
<b>OUTPUT POWER</b>	12Vdc, 4.15A, 50W
<b>POWER LINE</b>	2m non-shielded cable with one core

BATTERY	
<b>BRAND</b>	Intermec Technologies Corporation
<b>MODEL</b>	AB13
<b>OUTPUT POWER</b>	14.8Vdc, 2200mAh

4. The EUT, operates in the 2.4GHz frequency range, lets you connect IEEE 802.11g or IEEE 802.11b devices to the network. With its high-speed data transmissions of up to 54Mbps.
5. The above EUT information was declared by manufacturer and for more detailed features description, please refer to the manufacturer's specifications or User's Manual.

### 3.2 DESCRIPTION OF TEST MODES

Eleven channels are provided to this EUT.

CHANNEL	FREQUENCY	CHANNEL	FREQUENCY
1	2412 MHz	7	2442 MHz
2	2417 MHz	8	2447 MHz
3	2422 MHz	9	2452 MHz
4	2427 MHz	10	2457 MHz
5	2432 MHz	11	2462 MHz
6	2437 MHz		

#### 3.2.1 CONFIGURATION OF SYSTEM UNDER TEST

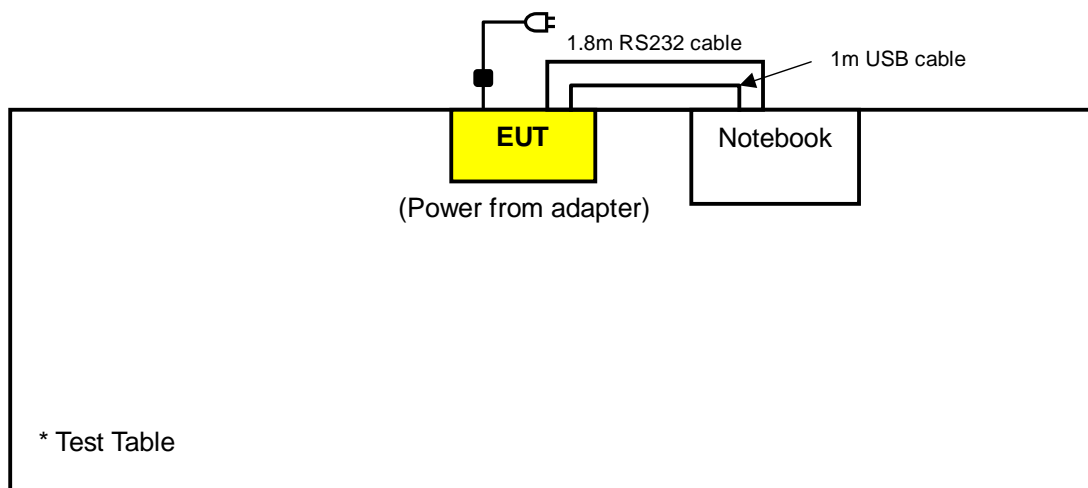

### 3.2.2 TEST MODE APPLICABILITY AND TESTED CHANNEL DETAIL

EUT Configure Mode	Applicable to				Description
	RE <sup>3</sup> 1G	RE<1G	PLC	APCM	
-	√	√	√	√	-

Where **PLC**: Power Line Conducted Emission      **RE<1G**: Radiated Emission below 1GHz  
**RE<sup>3</sup>1G**: Radiated Emission above 1GHz      **APCM**: Antenna Port Conducted Measurement

#### Radiated Emission Test (Above 1 GHz):

- Pre-Scan has been conducted to determine the worst-case mode from all possible combinations between available modulations, data rates, XYZ Axis and antenna ports (if EUT with antenna diversity architecture).
- Following channel(s) was (were) selected for the final test as listed below.

Mode	Available Channel	Tested Channel	Modulation Technology	Modulation Type	Data Rate (Mbps)	AXIS
802.11b	1 to 11	1, 6, 11	DSSS	DBPSK	1	X
802.11g	1 to 11	1, 6, 11	OFDM	BPSK	6	X

#### Radiated Emission Test (Below 1 GHz):

- Pre-Scan has been conducted to determine the worst-case mode from all possible combinations between available modulations, data rates, XYZ Axis and antenna ports (if EUT with antenna diversity architecture).
- Following channel(s) was (were) selected for the final test as listed below.

Mode	Available Channel	Tested Channel	Modulation Technology	Modulation Type	Data Rate (Mbps)	AXIS
802.11b	1 to 11	1	DSSS	DBPSK	1	X

#### Power Line Conducted Emission Test:

- Pre-Scan has been conducted to determine the worst-case mode from all possible combinations between available modulations, data rates and antenna ports (if EUT with antenna diversity architecture).
- Following channel(s) was (were) selected for the final test as listed below.

Mode	Available Channel	Tested Channel	Modulation Technology	Modulation Type	Data Rate (Mbps)
802.11b	1 to 11	1	DSSS	DBPSK	1





**Bandedge Measurement:**

- Pre-Scan has been conducted to determine the worst-case mode from all possible combinations between available modulations, data rates and antenna ports (if EUT with antenna diversity architecture).
- Following channel(s) was (were) selected for the final test as listed below.

Mode	Available Channel	Tested Channel	Modulation Technology	Modulation Type	Data Rate (Mbps)
802.11b	1 to 11	1, 11	DSSS	DBPSK	1
802.11g	1 to 11	1, 11	OFDM	BPSK	6

**Antenna Port Conducted Measurement:**

- Pre-Scan has been conducted to determine the worst-case mode from all possible combinations between available modulations, data rates and antenna ports (if EUT with antenna diversity architecture).
- Following channel(s) was (were) selected for the final test as listed below.

Mode	Available Channel	Tested Channel	Modulation Technology	Modulation Type	Data Rate (Mbps)
802.11b	1 to 11	1, 6, 11	DSSS	DBPSK	1
802.11g	1 to 11	1, 6, 11	OFDM	BPSK	6



### 3.3 GENERAL DESCRIPTION OF APPLIED STANDARDS

The EUT is a RF product. According to the specifications of the manufacturer, it must comply with the requirements of the following standards:

**FCC Part 15, Subpart C (15.247)**  
**ANSI C63.4-2003**

All test items have been performed and recorded as per the above standards.

### 3.4 DESCRIPTION OF SUPPORT UNITS

The EUT has been tested as an independent unit together with other necessary accessories or support units. The following support units or accessories were used to form a representative test configuration during the tests.

NO.	PRODUCT	BRAND	MODEL NO.	SERIAL NO.	FCC ID
1	NOTEBOOK COMPUTER	DELL	PP05L	12130898320	E2K24CLNS

NO.	SIGNAL CABLE DESCRIPTION OF THE ABOVE SUPPORT UNITS
1	1m shielded USB cable

**NOTE:** All power cords of the above support units are non shielded (1.8m).

## 4 TEST TYPES AND RESULTS

### 4.1 RADIATED EMISSION MEASUREMENT

#### 4.1.1 LIMITS OF RADIATED EMISSION MEASUREMENT

Emissions radiated outside of the specified bands, shall be according to the general radiated limits in 15.209 as following:

Frequencies (MHz)	Field strength (microvolts/meter)	Measurement distance (meters)
0.009-0.490	2400/F(kHz)	300
0.490-1.705	24000/F(kHz)	30
1.705-30.0	30	30
30-88	100	3
88-216	150	3
216-960	200	3
Above 960	500	3

**NOTE:**

1. The lower limit shall apply at the transition frequencies.
2. Emission level (dBuV/m) = 20 log Emission level (uV/m).
3. As shown in 15.35(b), for frequencies above 1000MHz, the field strength limits are based on average detector, however, the peak field strength of any emission shall not exceed the maximum permitted average limits, specified above by more than 20dB under any condition of modulation.



#### 4.1.2 TEST INSTRUMENTS

DESCRIPTION & MANUFACTURER	MODEL NO.	SERIAL NO.	CALIBRATED UNTIL
Test Receiver ROHDE & SCHWARZ	ESCI	100424	Jul. 27, 2008
Spectrum Analyzer ROHDE & SCHWARZ	FSP40	100269	Aug. 05, 2008
BILOG Antenna SCHWARZBECK	VULB9168	9168-153	Jan. 04, 2008
HORN Antenna SCHWARZBECK	BBHA 9120 D	9120D-563	Jul. 30, 2008
HORN Antenna SCHWARZBECK	BBHA 9170	BBHA9170242	Jan. 16, 2008
Preamplifier Agilent	8449B	3008A01910	Sep. 19, 2008
Preamplifier Agilent	8447D	2944A10638	Dec. 20, 2007
RF signal cable HUBER+SUHNNER	SUCOFLEX 104	274039/223650	Nov. 07, 2008
RF signal cable Worken	8D-FB	Cable-HYCH9-01	Aug. 09, 2008
Software	ADT_Radiated_V7.6	NA	NA
Antenna Tower EMCO	2070/2080	512.835.4684	NA
Turn Table EMCO	2087-2.03	NA	NA
Antenna Tower & Turn Table Controller EMCO	2090	NA	NA

- NOTE:**
1. The calibration interval of the above test instruments is 12 months and the calibrations are traceable to NML/ROC and NIST/USA.
  2. The test was performed in HwaYa Chamber 9.
  3. The horn antenna and HP preamplifier (model: 8449B) are used only for the measurement of emission frequency above 1GHz if tested.
  4. The IC Site Registration No. is IC3789B-9.

#### 4.1.3 TEST PROCEDURES

- a. The EUT was placed on the top of a rotating table 0.8 meters above the ground at a 3 meters semi-anechoic chamber. The table was rotated 360 degrees to determine the position of the highest radiation.
- b. The EUT was set 3 meters away from the interference-receiving antenna, which was mounted on the top of a variable-height antenna tower.
- c. The antenna is a broadband antenna, and its height is varied from one meter to four meters above the ground to determine the maximum value of the field strength. Both horizontal and vertical polarizations of the antenna are set to make the measurement.
- d. For each suspected emission, the EUT was arranged to its worst case and then the antenna was tuned to heights from 1 meter to 4 meters and the rotatable table was turned from 0 degrees to 360 degrees to find the maximum reading.
- e. The test-receiver system was set to Peak Detect Function and Specified Bandwidth with Maximum Hold Mode.
- f. If the emission level of the EUT in peak mode was lower than the limit specified, then testing could be stopped and the peak values of the EUT would be reported. Otherwise the emissions would be re-tested one by one using peak, quasi-peak method or average method as specified and then reported in data sheet.

**NOTE:**

1. The resolution bandwidth and video bandwidth of test receiver/spectrum analyzer is 120kHz for Peak detection (PK) and Quasi-peak detection (QP) at frequency below 1GHz.
2. The resolution bandwidth of test receiver/spectrum analyzer is 1 MHz and video bandwidth is 3MHz for Peak detection at frequency above 1GHz.
3. The resolution bandwidth of test receiver/spectrum analyzer is 1 MHz and the video bandwidth is 1 kHz for Average detection (AV) at frequency above 1GHz.
4. All modes of operation were investigated and the worst-case emissions are reported.

#### 4.1.4 DEVIATION FROM TEST STANDARD

No deviation.

#### 4.1.5 TEST SETUP

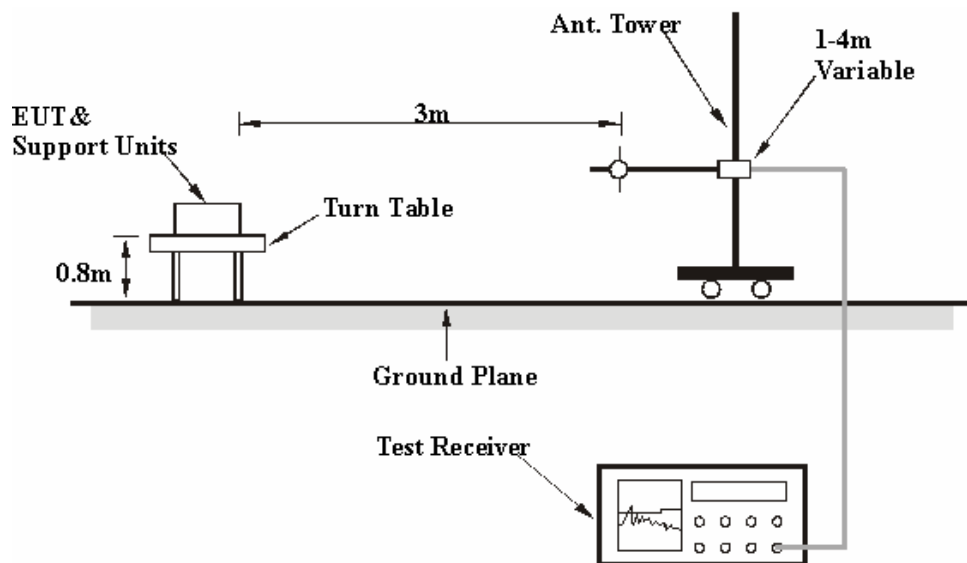

For the actual test configuration, please refer to the attached file (Test Setup Photo).

#### 4.1.6 EUT OPERATING CONDITIONS

- a. Connected the EUT to a notebook and placed on a testing table.
- b. The notebook system run a test program (provided by manufacturer) to enable EUT under transmission/receiving condition continuously at specific channel frequency.



#### 4.1.7 TEST RESULTS

##### 802.11b DSSS MODULATION

EUT TEST CONDITION		MEASUREMENT DETAIL	
CHANNEL	Channel 1	FREQUENCY RANGE	1 ~ 25GHz
INPUT POWER (SYSTEM)	120Vac, 60 Hz	DETECTOR FUNCTION	Peak (PK) Average (AV)
ENVIRONMENTAL CONDITIONS	23deg. C, 69%RH 1016hPa	TESTED BY	Lori Chiu

ANTENNA POLARITY & TEST DISTANCE: HORIZONTAL AT 3 M								
NO.	FREQ. (MHz)	EMISSION LEVEL (dBuV/m)	LIMIT (dBuV/m)	MARGIN (dB)	ANTENNA HEIGHT (m)	TABLE ANGLE (Degree)	RAW VALUE (dBuV)	CORRECTION FACTOR (dB/m)
1	2390.00	57.45 PK	74.00	-16.55	1.25 H	138	25.13	32.32
2	2390.00	47.12 AV	54.00	-6.88	1.25 H	138	14.80	32.32
3	*2412.00	103.29 PK			1.22 H	129	70.97	32.32
4	*2412.00	99.24 AV			1.22 H	129	66.92	32.32
5	4824.00	51.40 PK	74.00	-22.60	1.09 H	357	13.40	38.00
6	4824.00	41.72 AV	54.00	-12.28	1.09 H	357	3.72	38.00
ANTENNA POLARITY & TEST DISTANCE: VERTICAL AT 3 M								
NO.	FREQ. (MHz)	EMISSION LEVEL (dBuV/m)	LIMIT (dBuV/m)	MARGIN (dB)	ANTENNA HEIGHT (m)	TABLE ANGLE (Degree)	RAW VALUE (dBuV)	CORRECTION FACTOR (dB/m)
1	2390.00	56.58 PK	74.00	-17.42	1.00 V	340	24.26	32.32
2	2390.00	46.39 AV	54.00	-7.61	1.00 V	340	14.07	32.32
3	*2412.00	101.76 PK			1.00 V	340	69.44	32.32
4	*2412.00	97.57 AV			1.00 V	340	65.25	32.32
5	4824.00	54.54 PK	74.00	-19.46	1.12 V	158	16.54	38.00
6	4824.00	44.10 AV	54.00	-9.90	1.12 V	158	6.10	38.00

- REMARKS:**
1. Emission level (dBuV/m) = Raw Value (dBuV) + Correction Factor (dB/m).
  2. Correction Factor (dB/m) = Antenna Factor (dB/m) + Cable Factor (dB).
  3. The other emission levels were very low against the limit.
  4. Margin value = Emission level – Limit value.
  5. “ \* “: Fundamental frequency.



EUT TEST CONDITION		MEASUREMENT DETAIL	
CHANNEL	Channel 6	FREQUENCY RANGE	1 ~ 25GHz
INPUT POWER (SYSTEM)	120Vac, 60 Hz	DETECTOR FUNCTION	Peak (PK) Average (AV)
ENVIRONMENTAL CONDITIONS	23deg. C, 69%RH 1016hPa	TESTED BY	Lori Chiu

ANTENNA POLARITY & TEST DISTANCE: HORIZONTAL AT 3 M								
NO.	FREQ. (MHz)	EMISSION LEVEL (dBuV/m)	LIMIT (dBuV/m)	MARGIN (dB)	ANTENNA HEIGHT (m)	TABLE ANGLE (Degree)	RAW VALUE (dBuV)	CORRECTION FACTOR (dB/m)
1	*2437.00	102.86 PK			1.23 H	130	70.52	32.34
2	*2437.00	99.17 AV			1.23 H	130	66.83	32.34
3	4874.00	50.66 PK	74.00	-23.34	1.05 H	193	12.54	38.12
4	4874.00	39.97 AV	54.00	-14.03	1.05 H	193	1.85	38.12
ANTENNA POLARITY & TEST DISTANCE: VERTICAL AT 3 M								
NO.	FREQ. (MHz)	EMISSION LEVEL (dBuV/m)	LIMIT (dBuV/m)	MARGIN (dB)	ANTENNA HEIGHT (m)	TABLE ANGLE (Degree)	RAW VALUE (dBuV)	CORRECTION FACTOR (dB/m)
1	*2437.00	100.54 PK			1.06 V	289	68.20	32.34
2	*2437.00	97.31 AV			1.06 V	289	64.97	32.34
3	4874.00	52.27 PK	74.00	-21.73	1.20 V	10	14.15	38.12
4	4874.00	42.64 AV	54.00	-11.36	1.20 V	10	4.52	38.12

- REMARKS:**
1. Emission level (dBuV/m) = Raw Value (dBuV) + Correction Factor (dB/m).
  2. Correction Factor (dB/m) = Antenna Factor (dB/m) + Cable Factor (dB).
  3. The other emission levels were very low against the limit.
  4. Margin value = Emission level – Limit value.
  5. “ \* “: Fundamental frequency.





EUT TEST CONDITION		MEASUREMENT DETAIL	
CHANNEL	Channel 11	FREQUENCY RANGE	1 ~ 25GHz
INPUT POWER (SYSTEM)	120Vac, 60 Hz	DETECTOR FUNCTION	Peak (PK) Average (AV)
ENVIRONMENTAL CONDITIONS	23deg. C, 69%RH 1016hPa	TESTED BY	Lori Chiu

ANTENNA POLARITY & TEST DISTANCE: HORIZONTAL AT 3 M								
NO.	FREQ. (MHz)	EMISSION LEVEL (dBuV/m)	LIMIT (dBuV/m)	MARGIN (dB)	ANTENNA HEIGHT (m)	TABLE ANGLE (Degree)	RAW VALUE (dBuV)	CORRECTION FACTOR (dB/m)
1	*2462.00	101.13 PK			1.34 H	152	68.76	32.37
2	*2462.00	97.22 AV			1.34 H	152	64.85	32.37
3	2483.50	57.83 PK	74.00	-16.17	1.23 H	151	25.44	32.39
4	2483.50	47.22 AV	54.00	-6.78	1.23 H	151	14.83	32.39
5	4924.00	49.60 PK	74.00	-24.40	1.00 H	343	11.37	38.23
6	4924.00	38.96 AV	54.00	-15.04	1.00 H	343	0.73	38.23
ANTENNA POLARITY & TEST DISTANCE: VERTICAL AT 3 M								
NO.	FREQ. (MHz)	EMISSION LEVEL (dBuV/m)	LIMIT (dBuV/m)	MARGIN (dB)	ANTENNA HEIGHT (m)	TABLE ANGLE (Degree)	RAW VALUE (dBuV)	CORRECTION FACTOR (dB/m)
1	*2462.00	99.45 PK			1.00 V	323	67.08	32.37
2	*2462.00	95.68 AV			1.00 V	323	63.31	32.37
3	2483.50	57.19 PK	74.00	-16.81	1.00 V	333	24.80	32.39
4	2483.50	46.50 AV	54.00	-7.50	1.00 V	333	14.11	32.39
5	4924.00	50.00 PK	74.00	-24.00	1.00 V	179	11.77	38.23
6	4924.00	41.28 AV	54.00	-12.72	1.00 V	179	3.05	38.23

- REMARKS:**
1. Emission level (dBuV/m) = Raw Value (dBuV) + Correction Factor (dB/m).
  2. Correction Factor (dB/m) = Antenna Factor (dB/m) + Cable Factor (dB).
  3. The other emission levels were very low against the limit.
  4. Margin value = Emission level – Limit value.
  5. “ \* “: Fundamental frequency.



### 802.11g OFDM MODULATION

EUT TEST CONDITION		MEASUREMENT DETAIL	
CHANNEL	Channel 1	FREQUENCY RANGE	1 ~ 25GHz
INPUT POWER (SYSTEM)	120Vac, 60 Hz	DETECTOR FUNCTION	Peak (PK) Average (AV)
ENVIRONMENTAL CONDITIONS	23deg. C, 69%RH 1016hPa	TESTED BY	Lori Chiu

#### ANTENNA POLARITY & TEST DISTANCE: HORIZONTAL AT 3 M

NO.	FREQ. (MHz)	EMISSION LEVEL (dBuV/m)	LIMIT (dBuV/m)	MARGIN (dB)	ANTENNA HEIGHT (m)	TABLE ANGLE (Degree)	RAW VALUE (dBuV)	CORRECTION FACTOR (dB/m)
1	2390.00	57.46 PK	74.00	-16.54	1.05 H	149	25.14	32.32
2	2390.00	47.23 AV	54.00	-6.77	1.05 H	149	14.91	32.32
3	*2412.00	100.80 PK			1.05 H	150	68.48	32.32
4	*2412.00	93.00 AV			1.05 H	150	60.68	32.32
5	4824.00	48.65 PK	74.00	-25.35	1.17 H	12	10.65	38.00
6	4824.00	36.34 AV	54.00	-17.66	1.17 H	12	-1.66	38.00

#### ANTENNA POLARITY & TEST DISTANCE: VERTICAL AT 3 M

NO.	FREQ. (MHz)	EMISSION LEVEL (dBuV/m)	LIMIT (dBuV/m)	MARGIN (dB)	ANTENNA HEIGHT (m)	TABLE ANGLE (Degree)	RAW VALUE (dBuV)	CORRECTION FACTOR (dB/m)
1	2390.00	57.33 PK	74.00	-16.67	1.10 V	51	25.01	32.32
2	2390.00	46.69 AV	54.00	-7.31	1.10 V	51	14.37	32.32
3	*2412.00	96.95 PK			1.10 V	51	64.63	32.32
4	*2412.00	89.83 AV			1.10 V	51	57.51	32.32
5	4824.00	49.54 PK	74.00	-24.46	1.05 V	267	11.54	38.00
6	4824.00	37.61 AV	54.00	-16.39	1.05 V	267	-0.39	38.00

- REMARKS:**
1. Emission level (dBuV/m) = Raw Value (dBuV) + Correction Factor (dB/m).
  2. Correction Factor (dB/m) = Antenna Factor (dB/m) + Cable Factor (dB).
  3. The other emission levels were very low against the limit.
  4. Margin value = Emission level – Limit value.
  5. “ \* ”: Fundamental frequency.



EUT TEST CONDITION		MEASUREMENT DETAIL	
CHANNEL	Channel 6	FREQUENCY RANGE	1 ~ 25GHz
INPUT POWER (SYSTEM)	120Vac, 60 Hz	DETECTOR FUNCTION	Peak (PK) Average (AV)
ENVIRONMENTAL CONDITIONS	23deg. C, 69%RH 1016hPa	TESTED BY	Lori Chiu

ANTENNA POLARITY & TEST DISTANCE: HORIZONTAL AT 3 M								
NO.	FREQ. (MHz)	EMISSION LEVEL (dBuV/m)	LIMIT (dBuV/m)	MARGIN (dB)	ANTENNA HEIGHT (m)	TABLE ANGLE (Degree)	RAW VALUE (dBuV)	CORRECTION FACTOR (dB/m)
1	*2437.00	99.70 PK			1.13 H	226	67.36	32.34
2	*2437.00	91.84 AV			1.13 H	226	59.50	32.34
3	4874.00	48.38 PK	74.00	-25.62	1.11 H	316	10.26	38.12
4	4874.00	36.24 AV	54.00	-17.76	1.11 H	316	-1.88	38.12
ANTENNA POLARITY & TEST DISTANCE: VERTICAL AT 3 M								
NO.	FREQ. (MHz)	EMISSION LEVEL (dBuV/m)	LIMIT (dBuV/m)	MARGIN (dB)	ANTENNA HEIGHT (m)	TABLE ANGLE (Degree)	RAW VALUE (dBuV)	CORRECTION FACTOR (dB/m)
1	*2437.00	96.51 PK			1.25 V	162	64.17	32.34
2	*2437.00	89.48 AV			1.25 V	162	57.14	32.34
3	4874.00	49.45 PK	74.00	-24.55	1.00 V	9	11.33	38.12
4	4874.00	37.58 AV	54.00	-16.42	1.00 V	9	-0.54	38.12

- REMARKS:**
1. Emission level (dBuV/m) = Raw Value (dBuV) + Correction Factor (dB/m).
  2. Correction Factor (dB/m) = Antenna Factor (dB/m) + Cable Factor (dB).
  3. The other emission levels were very low against the limit.
  4. Margin value = Emission level – Limit value.
  5. “ \* “: Fundamental frequency.



EUT TEST CONDITION		MEASUREMENT DETAIL	
CHANNEL	Channel 11	FREQUENCY RANGE	1 ~ 25GHz
INPUT POWER (SYSTEM)	120Vac, 60 Hz	DETECTOR FUNCTION	Peak (PK) Average (AV)
ENVIRONMENTAL CONDITIONS	23deg. C, 69%RH 1016hPa	TESTED BY	Lori Chiu

ANTENNA POLARITY & TEST DISTANCE: HORIZONTAL AT 3 M								
NO.	FREQ. (MHz)	EMISSION LEVEL (dBuV/m)	LIMIT (dBuV/m)	MARGIN (dB)	ANTENNA HEIGHT (m)	TABLE ANGLE (Degree)	RAW VALUE (dBuV)	CORRECTION FACTOR (dB/m)
1	*2462.00	99.00 PK			1.20 H	106	66.63	32.37
2	*2462.00	91.21 AV			1.20 H	106	58.84	32.37
3	2483.50	58.68 PK	74.00	-15.32	1.20 H	106	26.29	32.39
4	2483.50	47.03 AV	54.00	-6.97	1.20 H	106	14.64	32.39
5	4924.00	48.21 PK	74.00	-25.79	1.11 H	260	9.98	38.23
6	4924.00	36.02 AV	54.00	-17.98	1.11 H	260	-2.21	38.23
ANTENNA POLARITY & TEST DISTANCE: VERTICAL AT 3 M								
NO.	FREQ. (MHz)	EMISSION LEVEL (dBuV/m)	LIMIT (dBuV/m)	MARGIN (dB)	ANTENNA HEIGHT (m)	TABLE ANGLE (Degree)	RAW VALUE (dBuV)	CORRECTION FACTOR (dB/m)
1	*2462.00	96.34 PK			1.07 V	100	63.97	32.37
2	*2462.00	89.26 AV			1.07 V	100	56.89	32.37
3	2483.50	57.95 PK	74.00	-16.05	1.04 V	101	25.56	32.39
4	2483.50	46.64 AV	54.00	-7.36	1.04 V	101	14.25	32.39
5	4924.00	49.11 PK	74.00	-24.89	1.26 V	218	10.88	38.23
6	4924.00	37.52 AV	54.00	-16.48	1.26 V	218	-0.71	38.23

- REMARKS:**
1. Emission level (dBuV/m) = Raw Value (dBuV) + Correction Factor (dB/m).
  2. Correction Factor (dB/m) = Antenna Factor (dB/m) + Cable Factor (dB).
  3. The other emission levels were very low against the limit.
  4. Margin value = Emission level – Limit value.
  5. “ \* “: Fundamental frequency.



**BELOW 1GHz WORST-CASE DATA : 802.11b DSSS MODULATION**

EUT TEST CONDITION		MEASUREMENT DETAIL	
CHANNEL	Channel 1	FREQUENCY RANGE	Below 1000MHz
INPUT POWER (SYSTEM)	120Vac, 60 Hz	DETECTOR FUNCTION	Quasi-Peak
ENVIRONMENTAL CONDITIONS	24deg. C, 64%RH 1016hPa	TESTED BY	Lori Chiu

ANTENNA POLARITY & TEST DISTANCE: HORIZONTAL AT 3 M								
NO.	FREQ. (MHz)	EMISSION LEVEL (dBuV/m)	LIMIT (dBuV/m)	MARGIN (dB)	ANTENNA HEIGHT (m)	TABLE ANGLE (Degree)	RAW VALUE (dBuV)	CORRECTION FACTOR (dB/m)
1	191.28	36.07 QP	43.50	-7.43	1.50 H	61	25.00	11.07
2	432.37	39.04 QP	46.00	-6.96	1.50 H	163	22.36	16.68
3	467.36	40.39 QP	46.00	-5.61	1.50 H	118	22.64	17.75
4	568.47	37.75 QP	46.00	-8.25	1.50 H	319	17.39	20.36
5	696.79	37.42 QP	46.00	-8.58	1.00 H	145	15.46	21.96
6	<b>774.56</b>	<b>44.83 QP</b>	<b>46.00</b>	<b>-1.17</b>	<b>1.00 H</b>	<b>235</b>	<b>21.06</b>	<b>23.77</b>
7	799.84	37.70 QP	46.00	-8.30	1.00 H	196	13.34	24.36
8	877.61	39.06 QP	46.00	-6.94	1.50 H	214	13.96	25.11
ANTENNA POLARITY & TEST DISTANCE: VERTICAL AT 3 M								
NO.	FREQ. (MHz)	EMISSION LEVEL (dBuV/m)	LIMIT (dBuV/m)	MARGIN (dB)	ANTENNA HEIGHT (m)	TABLE ANGLE (Degree)	RAW VALUE (dBuV)	CORRECTION FACTOR (dB/m)
1	115.45	35.25 QP	43.50	-8.25	1.00 V	79	24.23	11.02
2	467.36	39.35 QP	46.00	-6.65	1.00 V	94	21.60	17.75
3	568.47	37.92 QP	46.00	-8.08	1.00 V	325	17.56	20.36
4	774.56	38.46 QP	46.00	-7.54	1.50 V	94	14.69	23.77
5	877.61	38.59 QP	46.00	-7.41	1.00 V	115	13.49	25.11
6	930.11	37.42 QP	46.00	-8.58	1.00 V	178	11.86	25.56

- REMARKS:**
1. Emission level (dBuV/m) = Raw Value (dBuV) + Correction Factor (dB/m).
  2. Correction Factor (dB/m) = Antenna Factor (dB/m) + Cable Factor (dB).
  3. The other emission levels were very low against the limit.
  4. Margin value = Emission level – Limit value.



## 4.2 CONDUCTED EMISSION MEASUREMENT

### 4.2.1 LIMITS OF CONDUCTED EMISSION MEASUREMENT

FREQUENCY OF EMISSION (MHz)	CONDUCTED LIMIT (dB $\mu$ V)	
	Quasi-peak	Average
0.15 ~ 0.5	66 to 56	56 to 46
0.5 ~ 5	56	46
5 ~ 30	60	50

- NOTE:**
1. The lower limit shall apply at the transition frequencies.
  2. The limit decreases in line with the logarithm of the frequency in the range of 0.15 to 0.50 MHz.
  3. All emanations from a class A/B digital device or system, including any network of conductors and apparatus connected thereto, shall not exceed the level of field strengths specified above.

### 4.2.2 TEST INSTRUMENTS

DESCRIPTION & MANUFACTURER	MODEL NO.	SERIAL NO.	CALIBRATED UNTIL
Test Receiver ROHDE & SCHWARZ	ESCS30	100289	Dec. 08, 2007
RF signal cable Woken	5D-FB	Cable-HYCO3-01	Jan. 06, 2008
LISN ROHDE & SCHWARZ	ESH2-Z5	100100	Jan. 08, 2008
LISN ROHDE & SCHWARZ	ESH3-Z5	100311	Jan. 16, 2008
Software ADT	ADT_Cond_V3	NA	NA

- NOTE:**
1. The calibration interval of the above test instruments is 12 months and the calibrations are traceable to NML/ROC and NIST/USA.
  2. The test was performed in HwaYa Shielded Room 2.
  3. The VCCI Site Registration No. is C-2047.



#### 4.2.3 TEST PROCEDURES

- a. The EUT was placed 0.4 meters from the conducting wall of the shielded room with EUT being connected to the power mains through a line impedance stabilization network (LISN). Other support units were connected to the power mains through another LISN. The two LISNs provide 50 ohm/ 50uH of coupling impedance for the measuring instrument.
- b. Both lines of the power mains connected to the EUT were checked for maximum conducted interference.
- c. The frequency range from 150kHz to 30MHz was searched. Emission levels under (Limit - 20dB) was not recorded.

**NOTE:** All modes of operation were investigated and the worst-case emissions are reported.

#### 4.2.4 DEVIATION FROM TEST STANDARD

No deviation.

#### 4.2.5 TEST SETUP

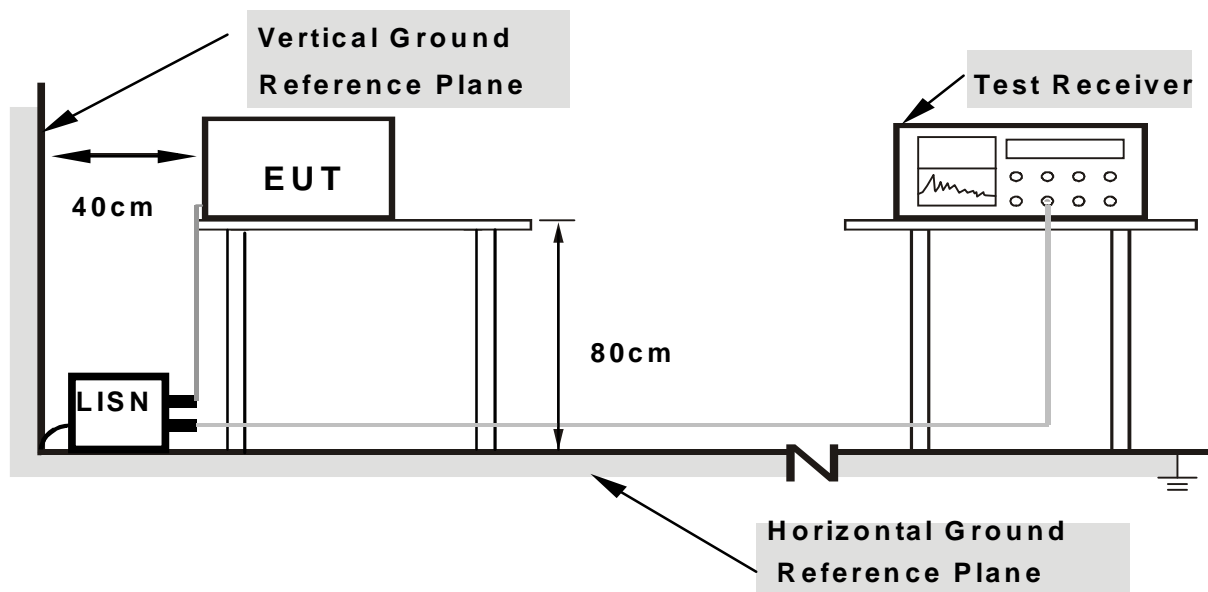

**Note: 1.Support units were connected to second LISN.**

**2.Both of LISNs (AMN) are 80 cm from EUT and at least 80 from other units and other metal planes**

For the actual test configuration, please refer to the attached file (Test Setup Photo).

#### 4.2.6 EUT OPERATING CONDITIONS

Same as 4.1.6.



## 4.2.7 TEST RESULTS

### CONDUCTED WORST-CASE DATA

EUT TEST CONDITION		MEASUREMENT DETAIL	
CHANNEL	Channel 1	PHASE	Line 1
MODULATION TYPE	DBPSK	6dB BANDWIDTH	9 kHz
TRANSFER RATE	1Mbps	ENVIRONMENTAL CONDITIONS	20deg. C, 60%RH, 1016hPa
INPUT POWER (SYSTEM)	120Vac, 60 Hz	TESTED BY	Match Tsui

No	Freq. [MHz]	Corr. Factor [dB]	Reading Value [dB (uV)]		Emission Level [dB (uV)]		Limit [dB (uV)]		Margin (dB)	
			Q.P.	AV.	Q.P.	AV.	Q.P.	AV.	Q.P.	AV.
			1	0.150	0.10	48.97	-	49.07	-	66.00
2	0.220	0.10	42.40	-	42.50	-	62.84	52.84	-20.34	-
3	0.369	0.10	35.19	-	35.29	-	58.53	48.53	-23.24	-
4	0.665	0.10	30.10	-	30.20	-	56.00	46.00	-25.80	-
5	0.886	0.11	28.75	-	28.86	-	56.00	46.00	-27.14	-
6	3.770	0.27	37.04	-	37.31	-	56.00	46.00	-18.69	-

- REMARKS:**
1. Q.P. and AV. are abbreviations of quasi-peak and average individually.
  2. "-": The Quasi-peak reading value also meets average limit and measurement with the average detector is unnecessary.
  3. The emission levels of other frequencies were very low against the limit.
  4. Margin value = Emission level - Limit value
  5. Correction factor = Insertion loss + Cable loss
  6. Emission Level = Correction Factor + Reading Value.

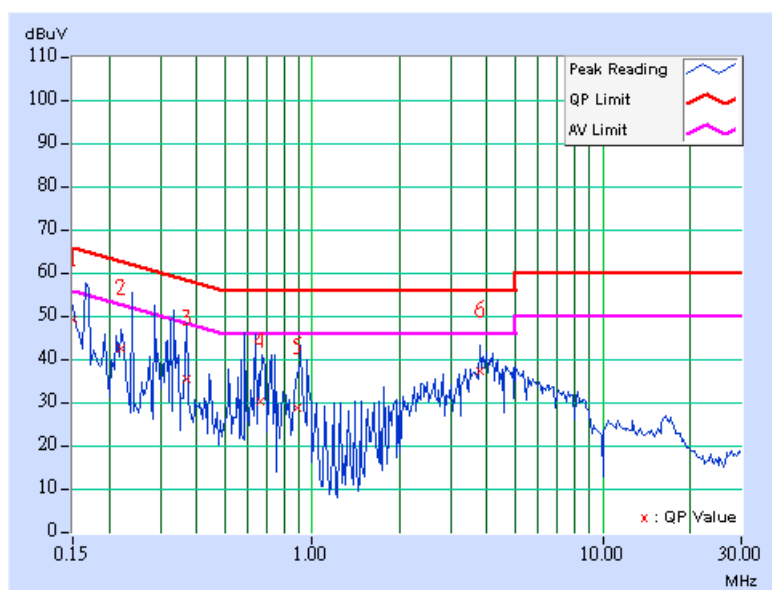

EUT TEST CONDITION		MEASUREMENT DETAIL	
CHANNEL	Channel 1	PHASE	Line 2
MODULATION TYPE	DBPSK	6dB BANDWIDTH	9 kHz
TRANSFER RATE	1Mbps	ENVIRONMENTAL CONDITIONS	20deg. C, 60%RH, 1016hPa
INPUT POWER (SYSTEM)	120Vac, 60 Hz	TESTED BY	Match Tsui

No	Freq. [MHz]	Corr. Factor (dB)	Reading Value [dB (uV)]		Emission Level [dB (uV)]		Limit [dB (uV)]		Margin (dB)	
			Q.P.	AV.	Q.P.	AV.	Q.P.	AV.	Q.P.	AV.
1	0.150	0.10	46.81	-	46.91	-	66.00	56.00	-19.09	-
2	0.223	0.10	40.57	-	40.67	-	62.71	52.71	-22.04	-
3	0.295	0.10	34.77	-	34.87	-	60.38	50.38	-25.51	-
4	0.591	0.14	31.91	-	32.05	-	56.00	46.00	-23.95	-
5	2.285	0.23	28.45	-	28.68	-	56.00	46.00	-27.32	-
6	4.156	0.28	37.61	-	37.89	-	56.00	46.00	-18.11	-

- REMARKS:**
1. Q.P. and AV. are abbreviations of quasi-peak and average individually.
  2. "-": The Quasi-peak reading value also meets average limit and measurement with the average detector is unnecessary.
  3. The emission levels of other frequencies were very low against the limit.
  4. Margin value = Emission level - Limit value
  5. Correction factor = Insertion loss + Cable loss
  6. Emission Level = Correction Factor + Reading Value.

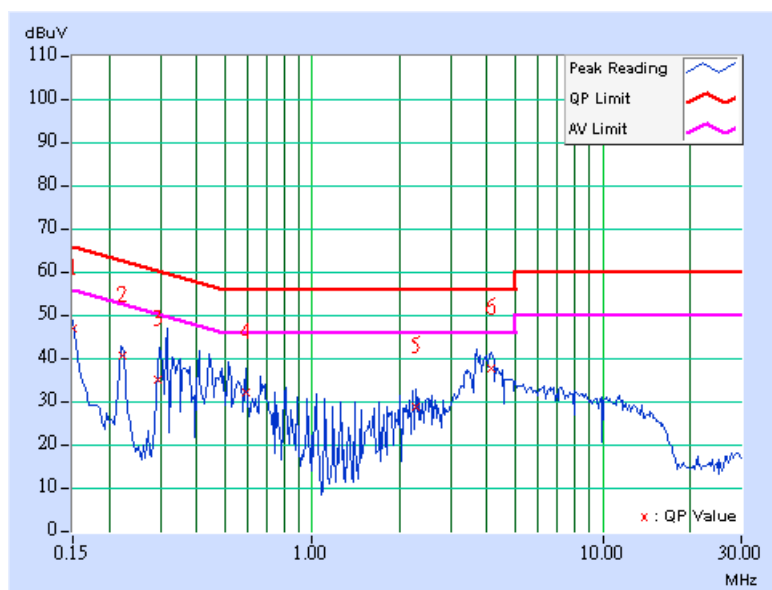



### 4.3 6dB BANDWIDTH MEASUREMENT

#### 4.3.1 LIMITS OF 6dB BANDWIDTH MEASUREMENT

The minimum of 6dB Bandwidth Measurement is 0.5 MHz.

#### 4.3.2 TEST INSTRUMENTS

DESCRIPTION & MANUFACTURER	MODEL NO.	SERIAL NO.	CALIBRATED UNTIL
SPECTRUM ANALYZER	FSP 40	100040	Jun. 28, 2008

**NOTE:** The calibration interval of the above test instruments is 12 months and the calibrations are traceable to NML/ROC and NIST/USA.

#### 4.3.3 TEST PROCEDURE

The transmitter output was connected to the spectrum analyzer through an attenuator. The bandwidth of the fundamental frequency was measured by spectrum analyzer with 100 kHz RBW and 300kHz VBW. The 6dB bandwidth is defined as the total spectrum the power of which is higher than peak power minus 6dB.

#### 4.3.4 DEVIATION FROM TEST STANDARD

No deviation.

#### 4.3.5 TEST SETUP

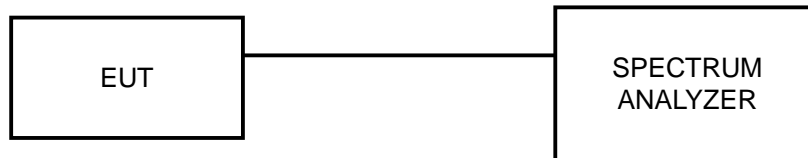

For the actual test configuration, please refer to the related Item – Photographs of the Test Configuration.

#### 4.3.6 EUT OPERATING CONDITIONS

The software provided by client to enable the EUT under transmission condition continuously at lowest, middle and highest channel frequencies individually.



### 4.3.7 TEST RESULTS

#### 802.11b DSSS MODULATION

<b>MODULATION TYPE</b>	DBPSK	<b>TRANSFER RATE</b>	1Mbps
<b>INPUT POWER (SYSTEM)</b>	120Vac, 60 Hz	<b>ENVIRONMENTAL CONDITIONS</b>	25deg. C, 65%RH, 1016hPa
<b>TESTED BY</b>	Long Chen		

CHANNEL	CHANNEL FREQUENCY (MHz)	6dB BANDWIDTH (MHz)	MINIMUM LIMIT (MHz)	PASS/FAIL
1	2412	10.16	0.5	PASS
6	2437	10.16	0.5	PASS
11	2462	10.16	0.5	PASS

#### CH 1

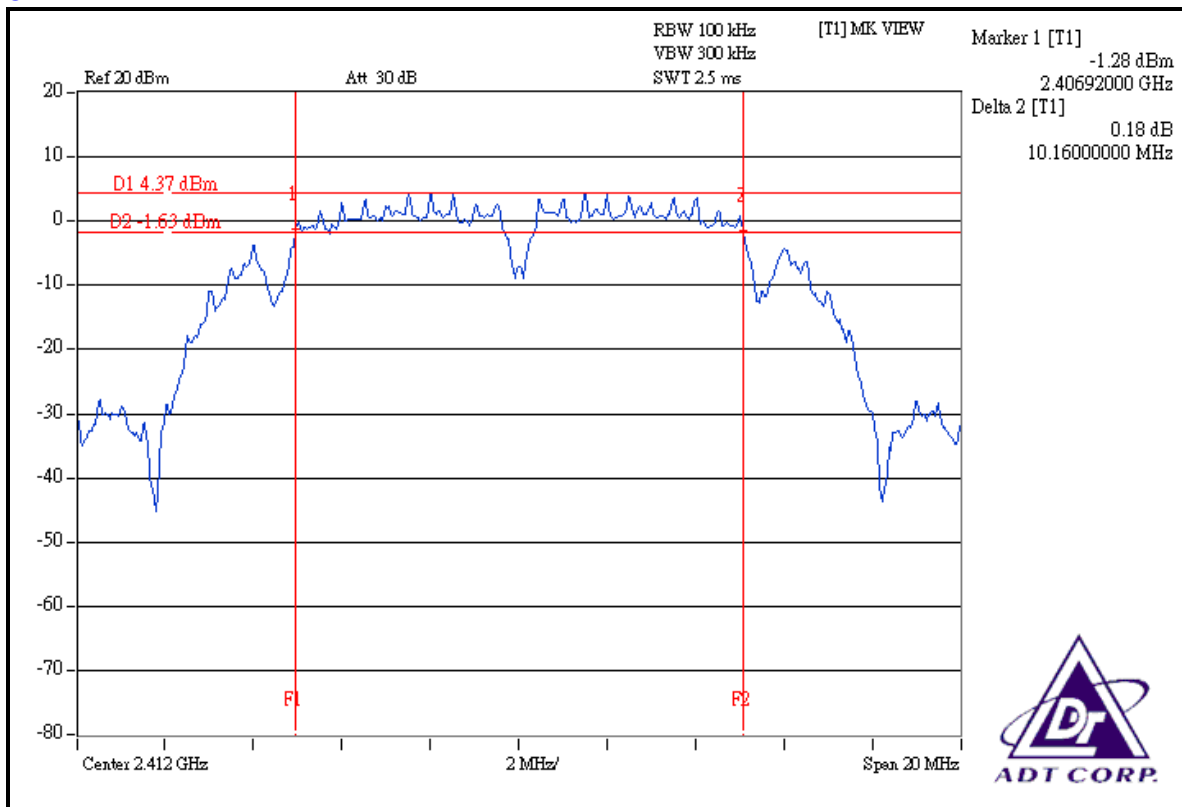



### CH 6

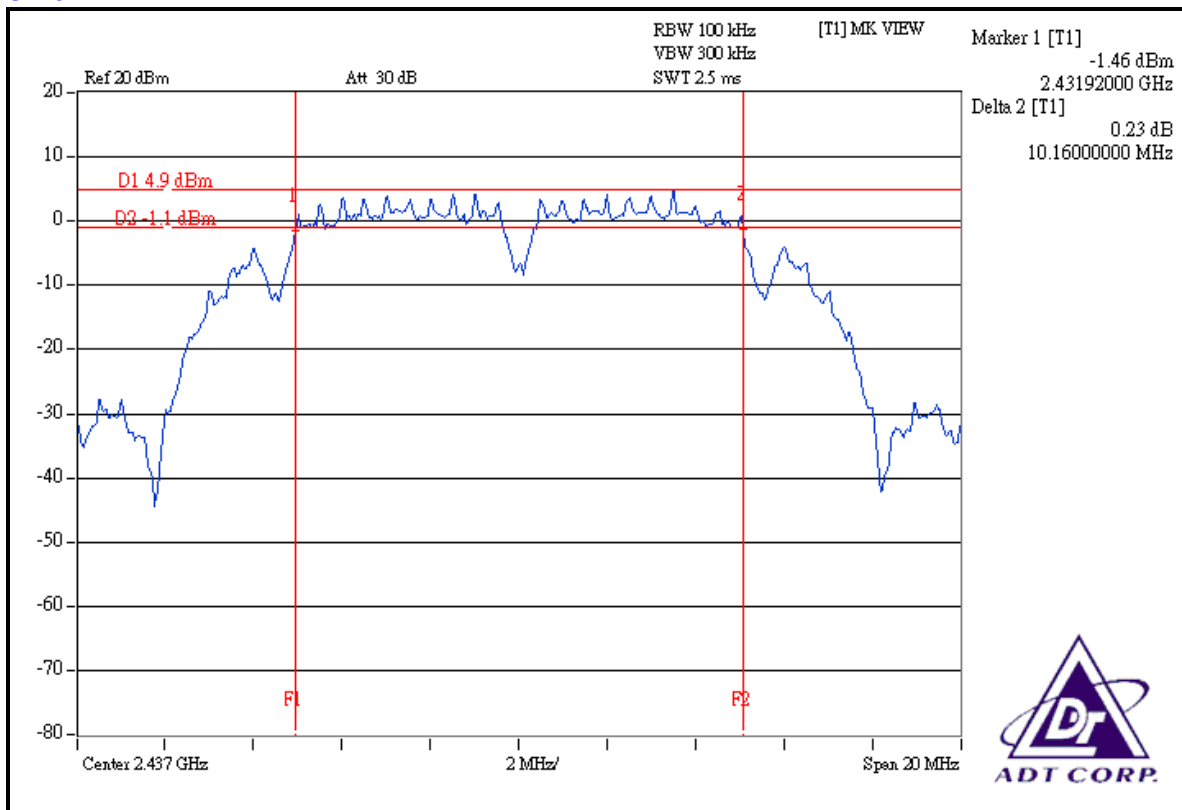

### CH 11

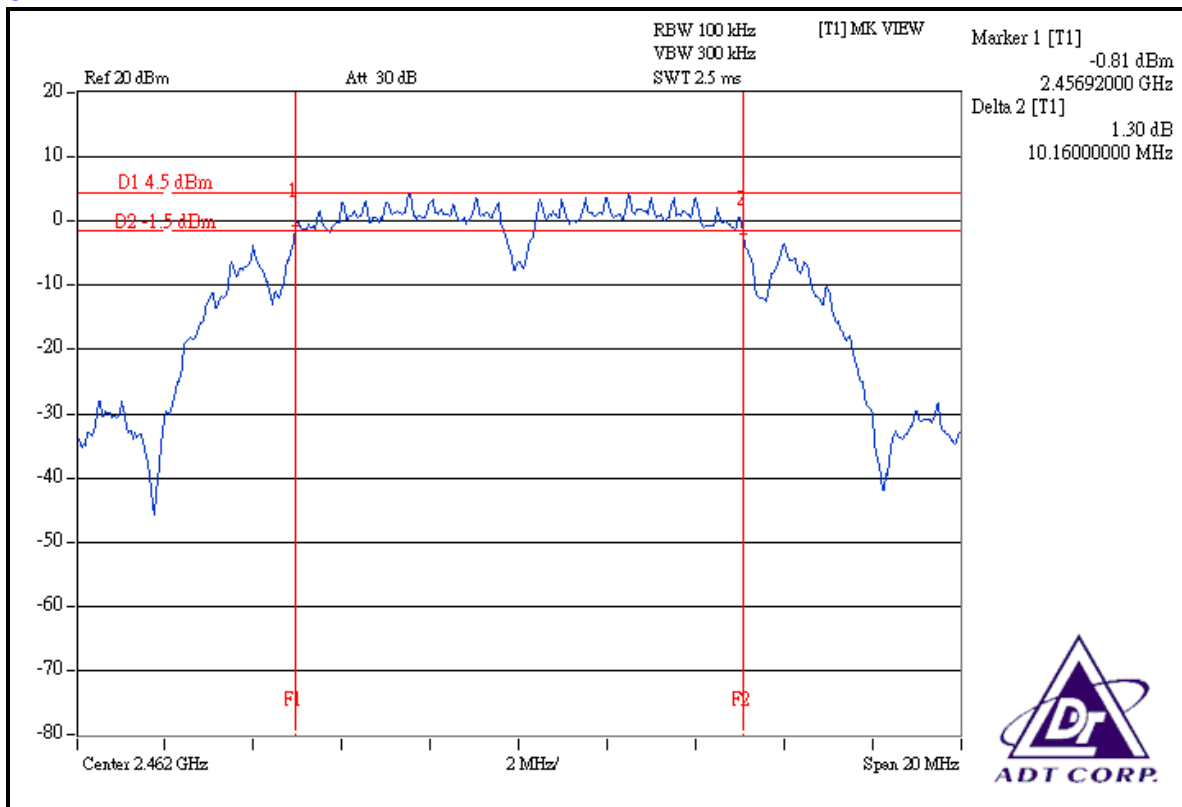

### 802.11g OFDM MODULATION

<b>MODULATION TYPE</b>	BPSK	<b>TRANSFER RATE</b>	6Mbps
<b>INPUT POWER (SYSTEM)</b>	120Vac, 60 Hz	<b>ENVIRONMENTAL CONDITIONS</b>	26deg. C, 67%RH, 1016hPa
<b>TESTED BY</b>	Long Chen		

CHANNEL	CHANNEL FREQUENCY (MHz)	6dB BANDWIDTH (MHz)	MINIMUM LIMIT (MHz)	PASS/FAIL
1	2412	16.36	0.5	PASS
6	2437	16.40	0.5	PASS
11	2462	16.40	0.5	PASS

### CH 1

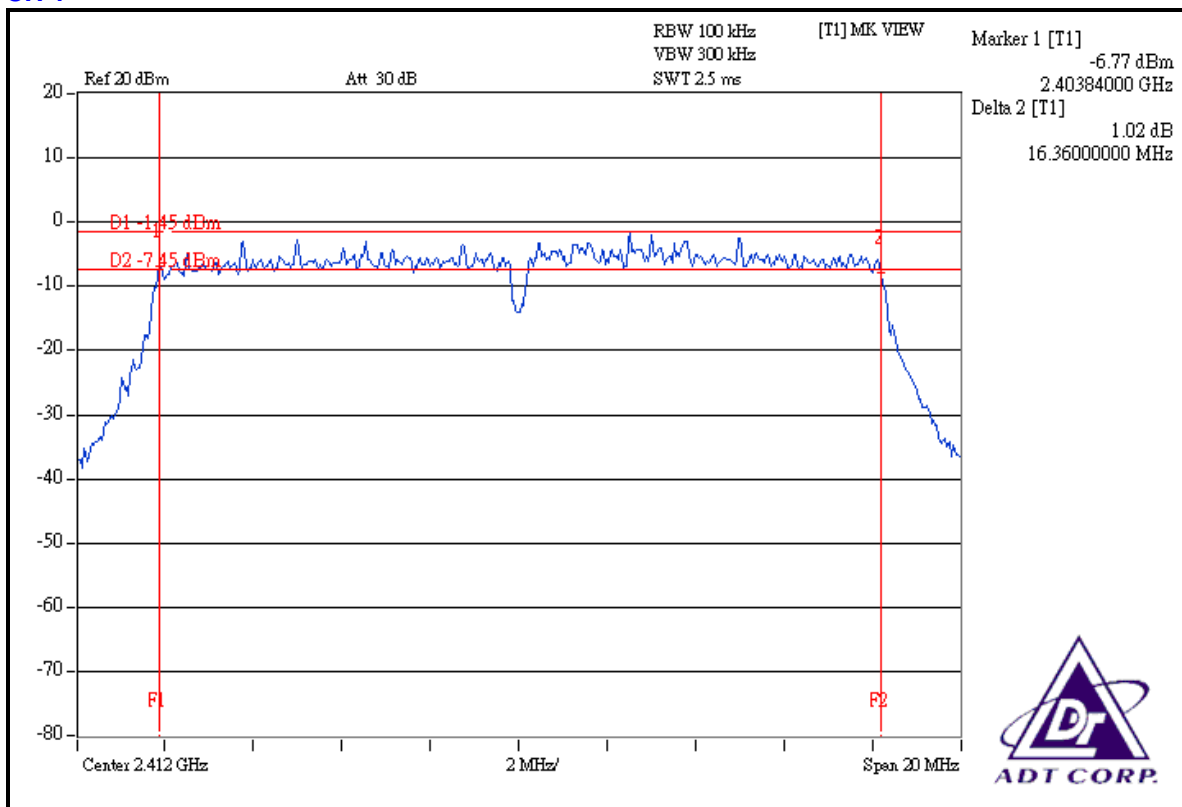



### CH 6

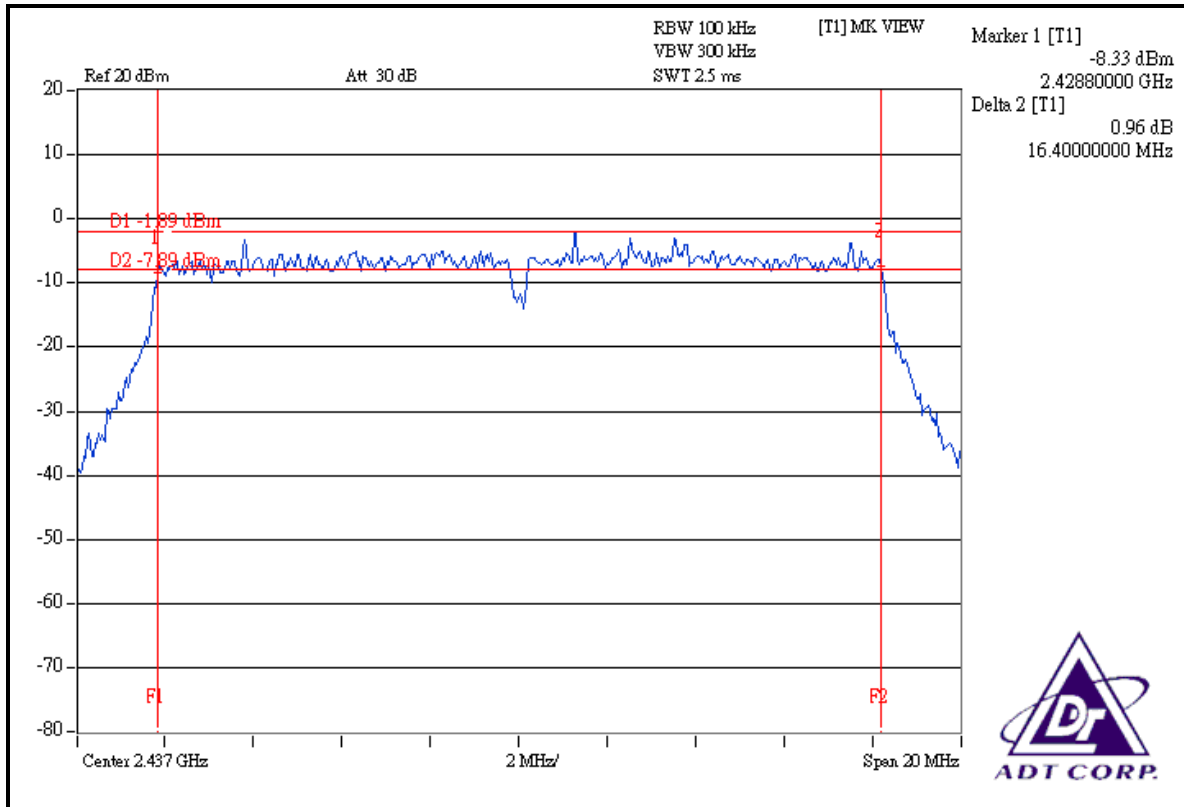

### CH 11

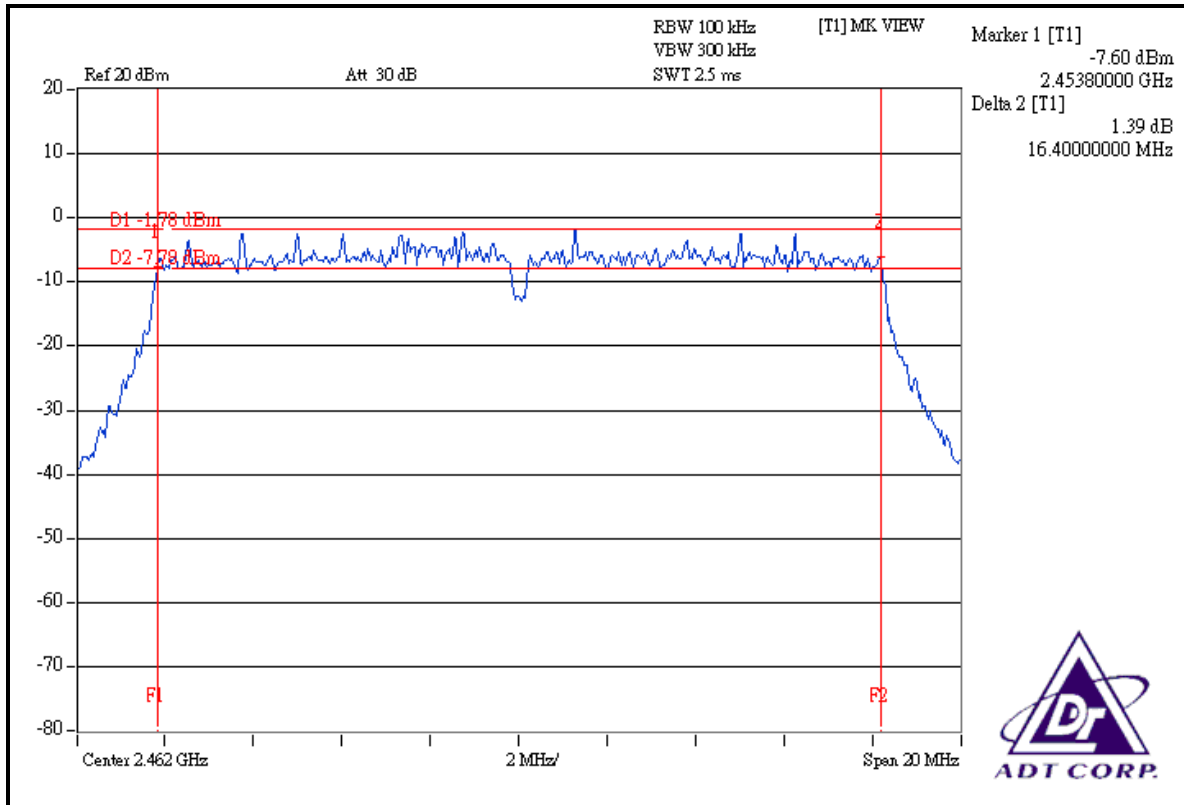





#### 4.4 MAXIMUM PEAK OUTPUT POWER

##### 4.4.1 LIMITS OF MAXIMUM PEAK OUTPUT POWER MEASUREMENT

The Maximum Peak Output Power Measurement is 30dBm.

##### 4.4.2 TEST INSTRUMENTS

DESCRIPTION & MANUFACTURER	MODEL NO.	SERIAL NO.	CALIBRATED UNTIL
R&S SPECTRUM ANALYZER	FSP40	100040	Jun. 28, 2008
AGILENT SIGNAL GENERATOR	E8257C	MY43320668	Dec. 28, 2007
TEKTRONIX OSCILLOSCOPE	TDS1012	C037299	Nov. 27, 2007
NARDA DETECTOR	4503A	FSCM99899	NA

**NOTE:** The calibration interval of the above test instruments is 12 months and the calibrations are traceable to NML/ROC and NIST/USA.

#### 4.4.3 TEST PROCEDURES

1. A detector was used on the output port of the EUT. An oscilloscope was used to peak the response of the detector.
2. Replaced the EUT by the signal generator. The center frequency of the S.G was adjusted to the center frequency of the measured channel.
3. Adjusted the power to have the same peak reading on oscilloscope. Record the power level.

#### 4.4.4 DEVIATION FROM TEST STANDARD

No deviation.

#### 4.4.5 TEST SETUP

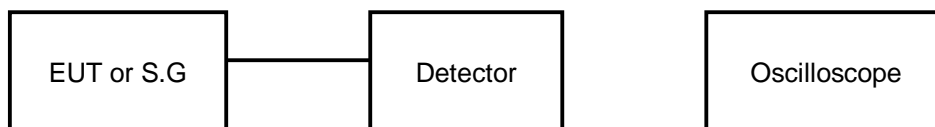

#### 4.4.6 EUT OPERATING CONDITIONS

Same as 4.3.6.



#### 4.4.7 TEST RESULTS

##### 802.11b DSSS MODULATION

<b>MODULATION TYPE</b>	DBPSK	<b>TRANSFER RATE</b>	1Mbps
<b>INPUT POWER (SYSTEM)</b>	120Vac, 60 Hz	<b>ENVIRONMENTAL CONDITIONS</b>	25deg. C, 65%RH, 1016hPa
<b>TESTED BY</b>	Long Chen		

CHANNEL	CHANNEL FREQUENCY (MHz)	PEAK POWER OUTPUT (mW)	PEAK POWER OUTPUT (dBm)	PEAK POWER LIMIT (dBm)	PASS/FAIL
1	2412	45.709	16.60	30	PASS
6	2437	44.875	16.52	30	PASS
11	2462	45.186	16.55	30	PASS

##### 802.11g OFDM MODULATION

<b>MODULATION TYPE</b>	BPSK	<b>TRANSFER RATE</b>	6Mbps
<b>INPUT POWER (SYSTEM)</b>	120Vac, 60 Hz	<b>ENVIRONMENTAL CONDITIONS</b>	25deg. C, 65%RH, 1016hPa
<b>TESTED BY</b>	Long Chen		

CHANNEL	CHANNEL FREQUENCY (MHz)	PEAK POWER OUTPUT (mW)	PEAK POWER OUTPUT (dBm)	PEAK POWER LIMIT (dBm)	PASS/FAIL
1	2412	22.542	13.53	30	PASS
6	2437	22.646	13.55	30	PASS
11	2462	22.699	13.56	30	PASS



## 4.5 POWER SPECTRAL DENSITY MEASUREMENT

### 4.5.1 LIMITS OF POWER SPECTRAL DENSITY MEASUREMENT

The Maximum of Power Spectral Density Measurement is 8dBm.

### 4.5.2 TEST INSTRUMENTS

DESCRIPTION & MANUFACTURER	MODEL NO.	SERIAL NO.	CALIBRATED UNTIL
R&S SPECTRUM ANALYZER	FSP 40	100040	Jun. 28, 2008

**NOTE:** The calibration interval of the above test instruments is 12 months and the calibrations are traceable to NML/ROC and NIST/USA.

### 4.5.3 TEST PROCEDURE

The transmitter output was connected to the spectrum analyzer through an attenuator, the bandwidth of the fundamental frequency was measured with the spectrum analyzer using 3kHz RBW and 30kHz VBW, set sweep time = span/3kHz. The power spectral density was measured and recorded.

The sweep time is allowed to be longer than span/3kHz for a full response of the mixer in the spectrum analyzer.

### 4.5.4 DEVIATION FROM TEST STANDARD

No deviation.

### 4.5.5 TEST SETUP

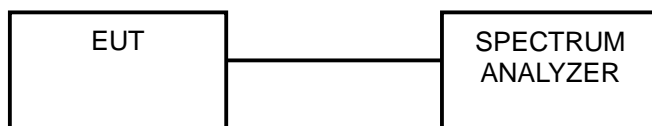

### 4.5.6 EUT OPERATING CONDITIONS

Same as 4.3.6.



#### 4.5.7 TEST RESULTS

##### 802.11b DSSS MODULATION

<b>MODULATION TYPE</b>	DBPSK	<b>TRANSFER RATE</b>	1Mbps
<b>INPUT POWER (SYSTEM)</b>	120Vac, 60 Hz	<b>ENVIRONMENTAL CONDITIONS</b>	25deg. C, 65%RH, 1016hPa
<b>TESTED BY</b>	Long Chen		

CHANNEL	CHANNEL FREQUENCY (MHz)	RF POWER LEVEL IN 3 kHz BW (dBm)	MAXIMUM LIMIT (dBm)	PASS/FAIL
1	2412	-10.33	8	PASS
6	2437	-10.28	8	PASS
11	2462	-10.22	8	PASS

##### CH 1

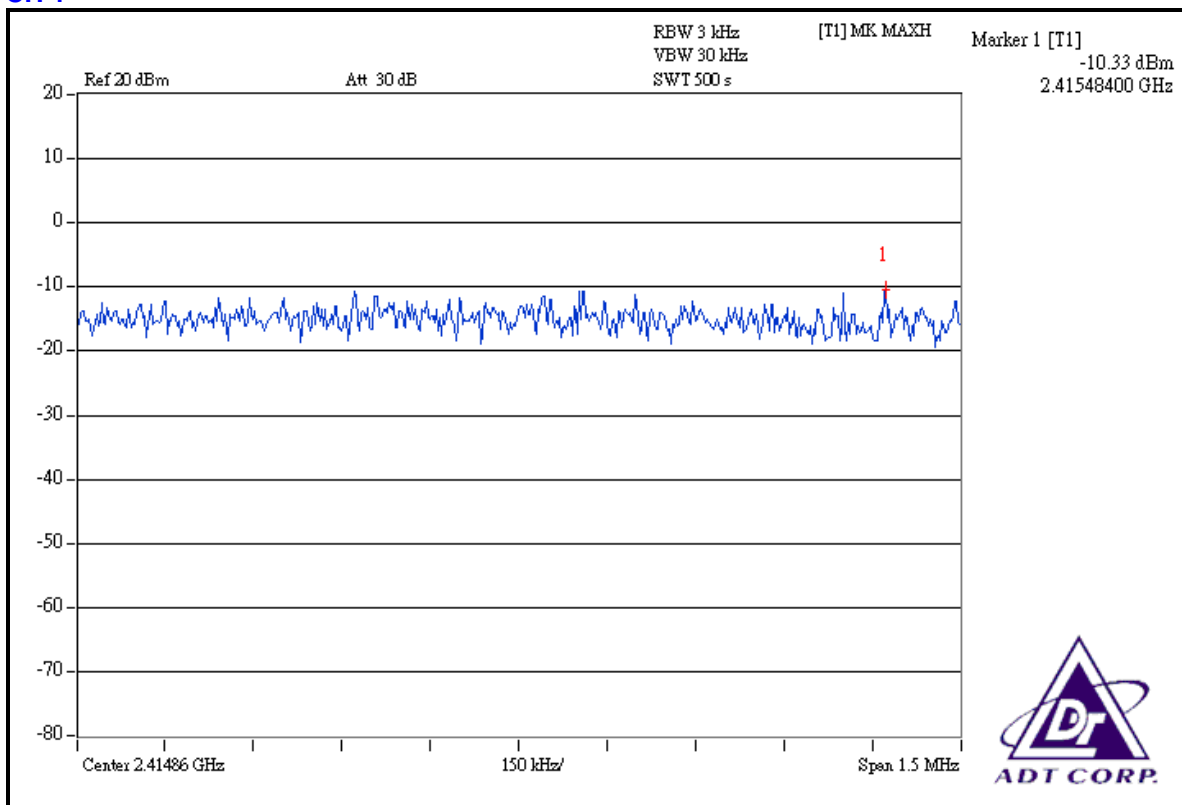



### CH 6

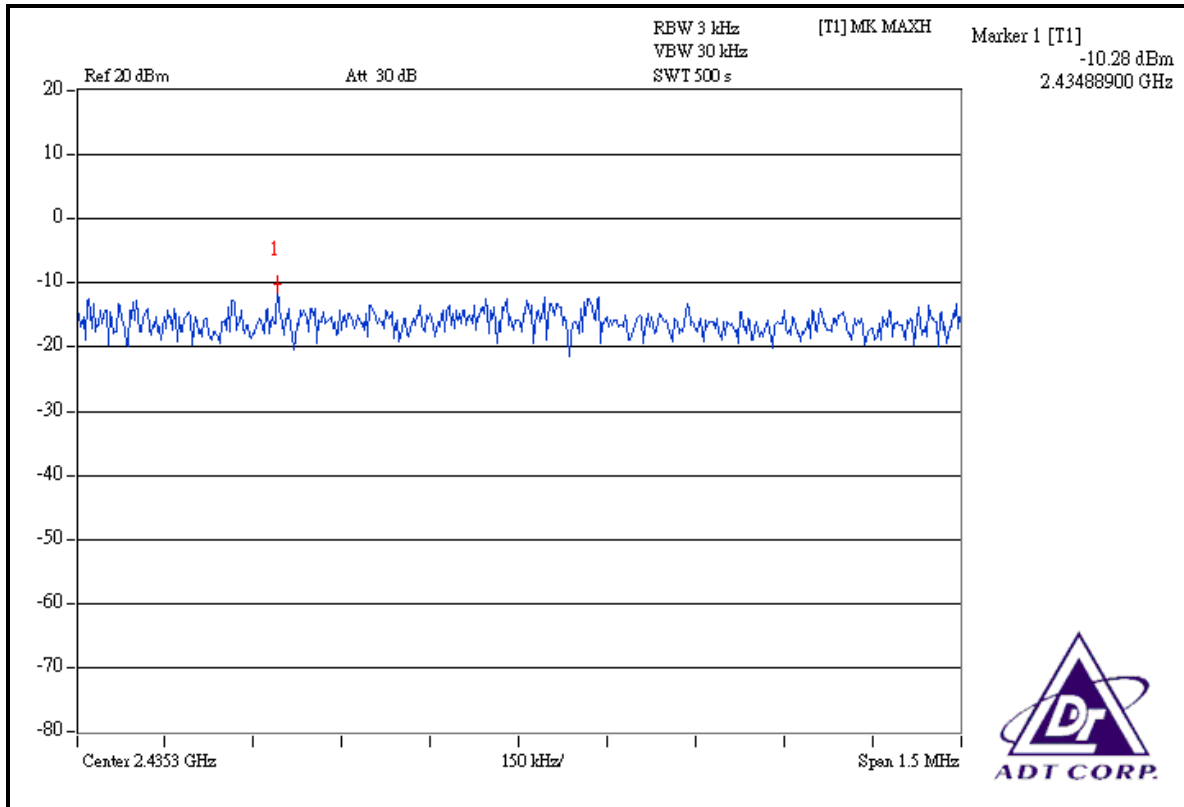

### CH 11

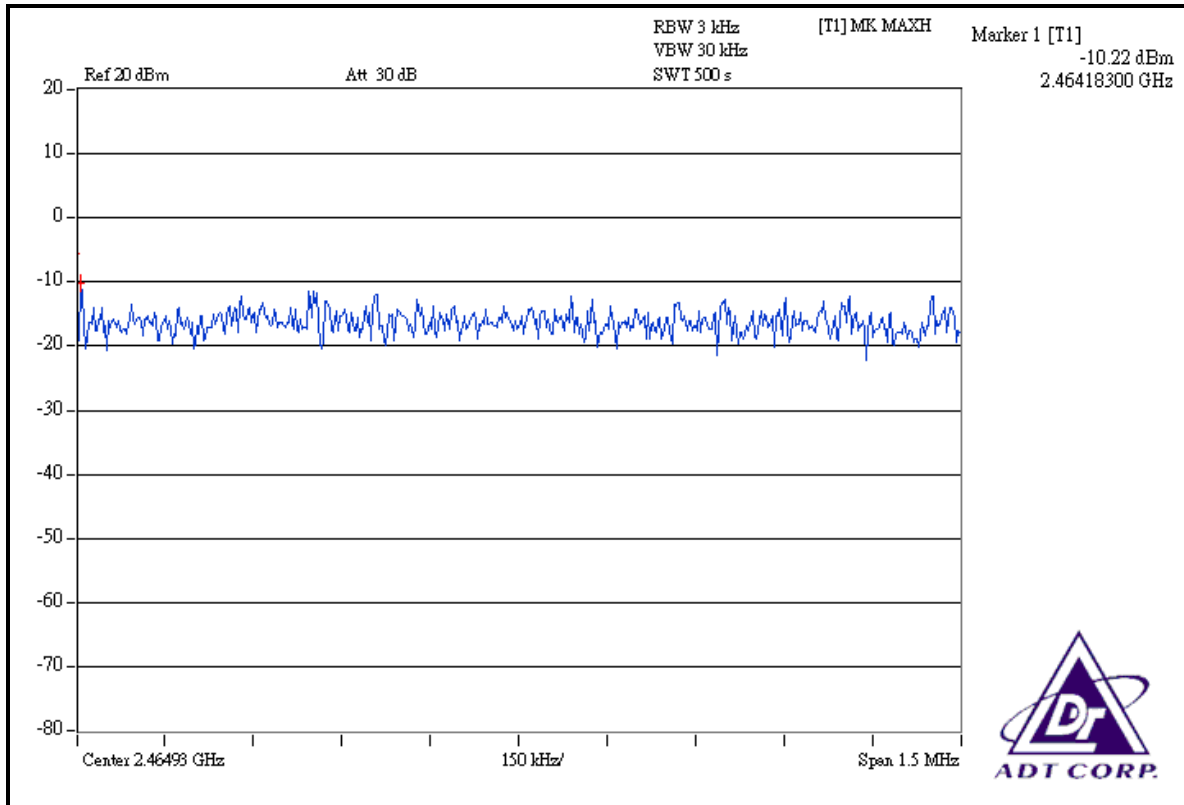



**802.11g OFDM MODULATION**

<b>MODULATION TYPE</b>	BPSK	<b>TRANSFER RATE</b>	6Mbps
<b>INPUT POWER (SYSTEM)</b>	120Vac, 60 Hz	<b>ENVIRONMENTAL CONDITIONS</b>	25deg. C, 65%RH, 1016hPa
<b>TESTED BY</b>	Long Chen		

CHANNEL	CHANNEL FREQUENCY (MHz)	RF POWER LEVEL IN 3 kHz BW (dBm)	MAXIMUM LIMIT (dBm)	PASS/FAIL
1	2412	-17.29	8	PASS
6	2437	-17.33	8	PASS
11	2462	-17.11	8	PASS

**CH 1**

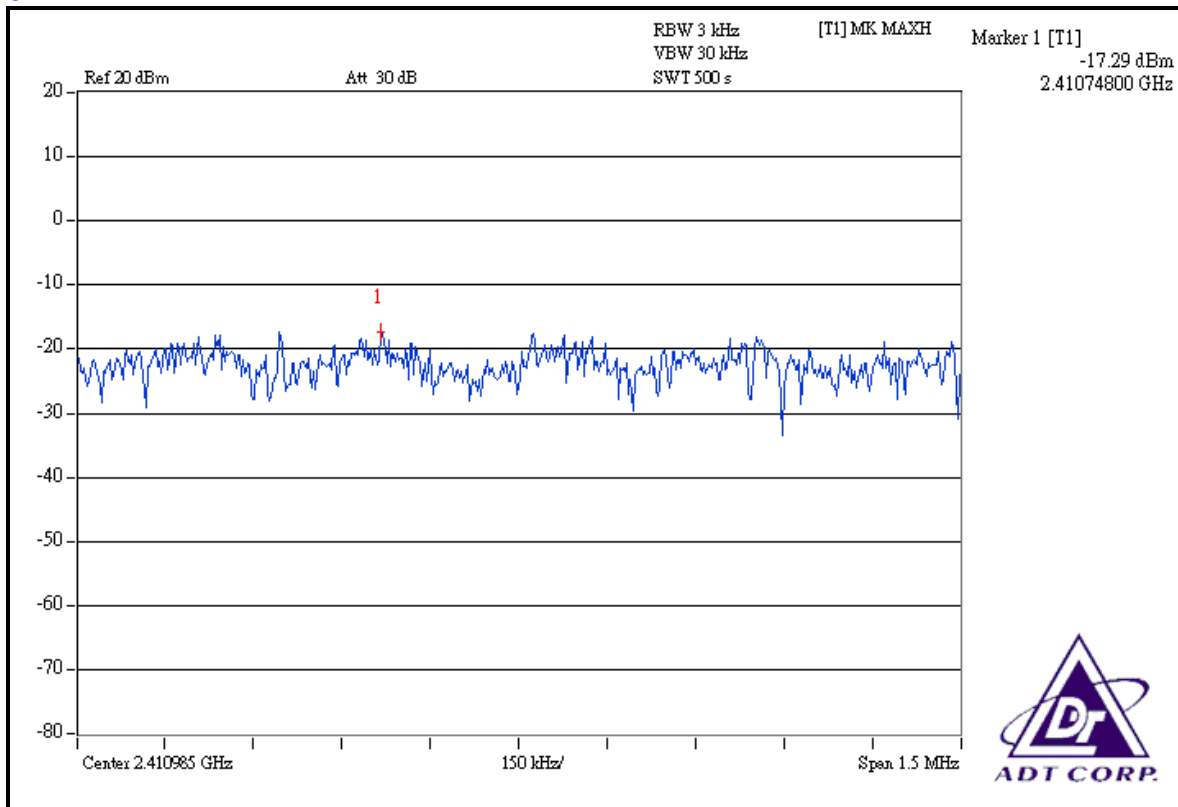



### CH 6

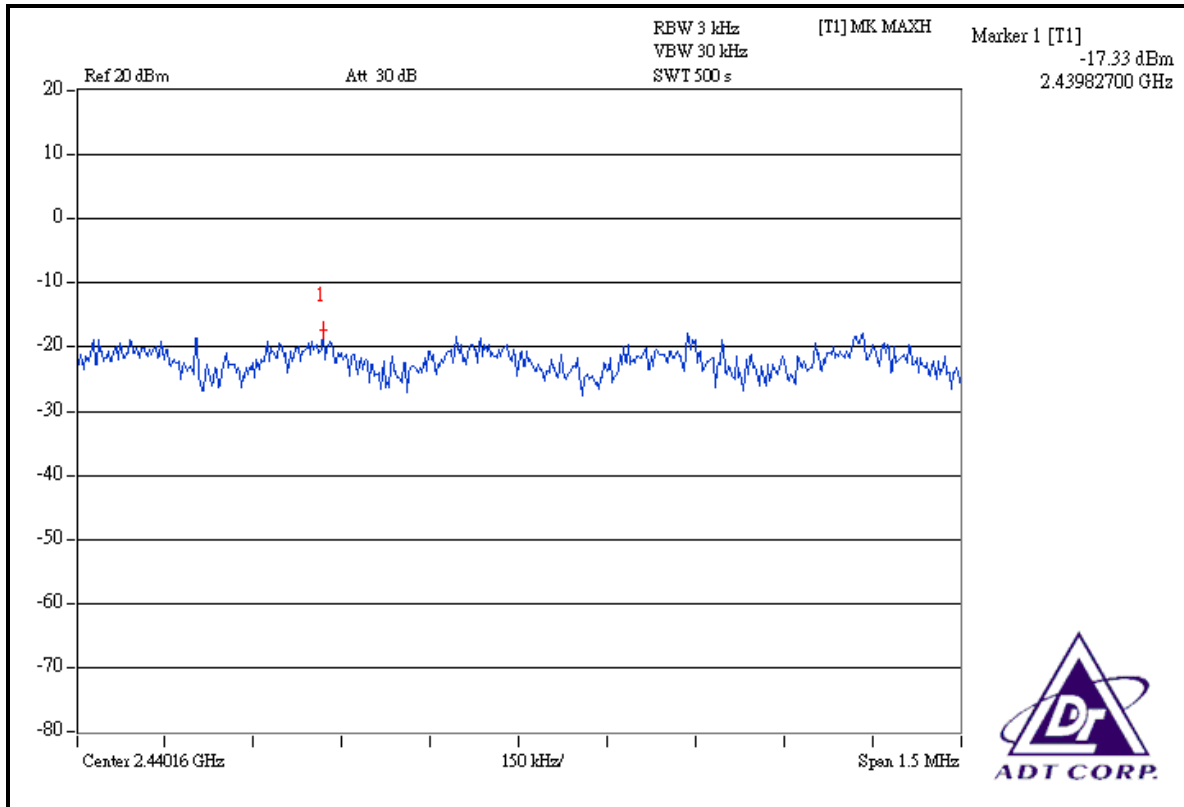

### CH 11

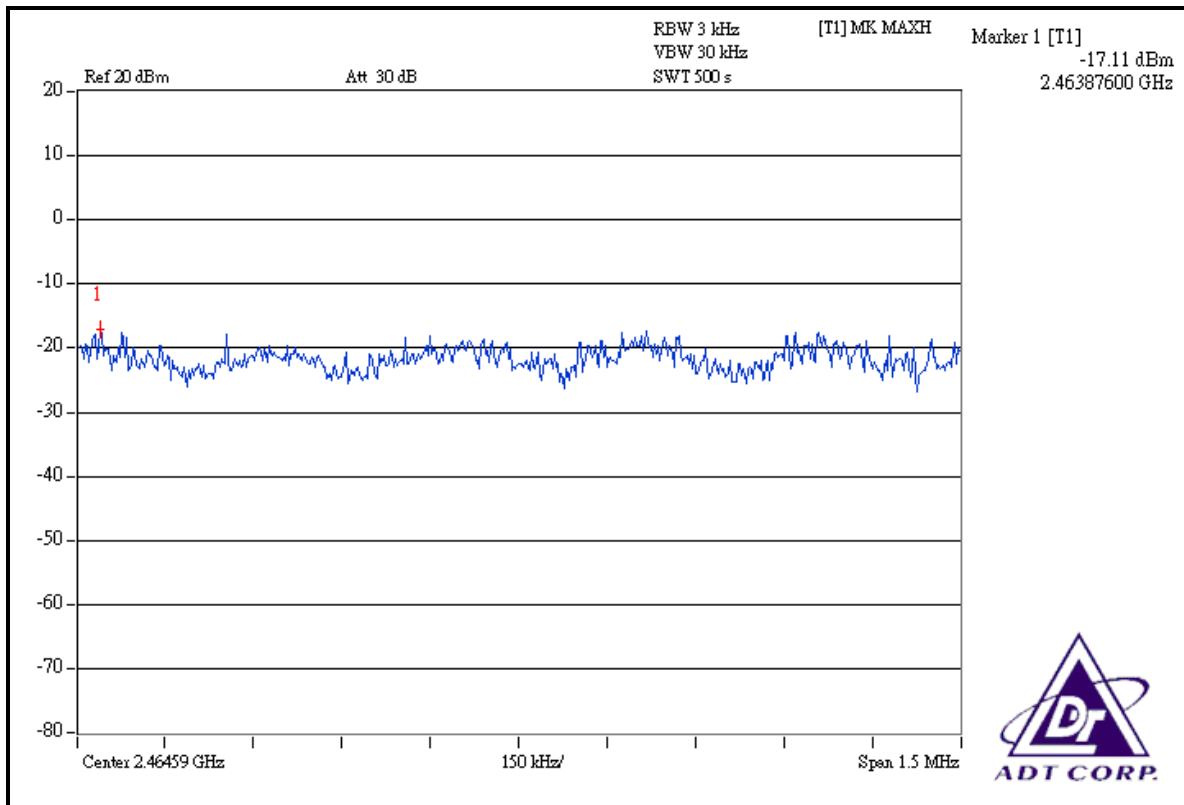





## 4.6 BAND EDGES MEASUREMENT

### 4.6.1 LIMITS OF BAND EDGES MEASUREMENT

Below  $-20\text{dB}$  of the highest emission level of operating band (in 100kHz Resolution Bandwidth).

### 4.6.2 TEST INSTRUMENTS

DESCRIPTION & MANUFACTURER	MODEL NO.	SERIAL NO.	CALIBRATED UNTIL
R&S SPECTRUM ANALYZER	FSP 40	100040	Jun. 28, 2008

**NOTE:** The calibration interval of the above test instruments is 12 months and the calibrations are traceable to NML/ROC and NIST/USA.

### 4.6.3 TEST PROCEDURE

The transmitter output was connected to the spectrum analyzer via a low loss cable. Set both RBW and VBW of spectrum analyzer to 100kHz with suitable frequency span including 100MHz bandwidth from band edge. The band edges were measured and recorded.

The spectrum plots (Peak RBW=100kHz, VBW=300kHz; Average RBW=1MHz, VBW= 1kHz) are attached on the following pages.

### 4.6.4 DEVIATION FROM TEST STANDARD

No deviation.

### 4.6.5 EUT OPERATING CONDITION

Same as 4.3.6.



#### 4.6.6 TEST RESULTS

The spectrum plots are attached on the following 12 images. D1 line indicates the highest level, and D2 line indicates the 20dB offset below D1. It shows compliance with the requirement in part 15.247(d).

#### 802.11b DSSS MODULATION

**NOTE 1:** The band edge emission plot on the next page shows 51.76dBc between carrier maximum power and local maximum emission in restrict band (2.38580GHz). The emission of carrier strength list in the test result of channel 1 at the item 4.2.7 is 103.29dBuV/m (Peak), so the maximum field strength in restrict band is  $103.29 - 51.76 = 51.53$ dBuV/m which is under 74dBuV/m limit.

The band edge emission plot of on the next page shows 61.09dBc between carrier maximum power and local maximum emission in restrict band (2.39000GHz). The emission of carrier strength list in the test result of channel 1 at the item 4.2.7 is 99.24dBuV/m (Average), so the maximum field strength in restrict band is  $99.24 - 61.09 = 38.15$ dBuV/m which is under 54dBuV/m limit.

**NOTE 2:** The band edge emission plot on the next second page shows 50.30dBc between carrier maximum power and local maximum emission in restrict band (2.48360GHz). The emission of carrier strength list in the test result of channel 11 at the item 4.2.7 is 101.13dBuV/m (Peak), so the maximum field strength in restrict band is  $101.13 - 50.30 = 50.83$ dBuV/m which is under 74dBuV/m limit.

The band edge emission plot on the next third page shows 56.79dBc between carrier maximum power and local maximum emission in restrict band (2.48350GHz). The emission of carrier strength list in the test result of channel 11 at the item 4.2.7 is 97.22dBuV/m (Average), so the maximum field strength in restrict band is  $97.22 - 56.79 = 40.43$ dBuV/m which is under 54dBuV/m limit.

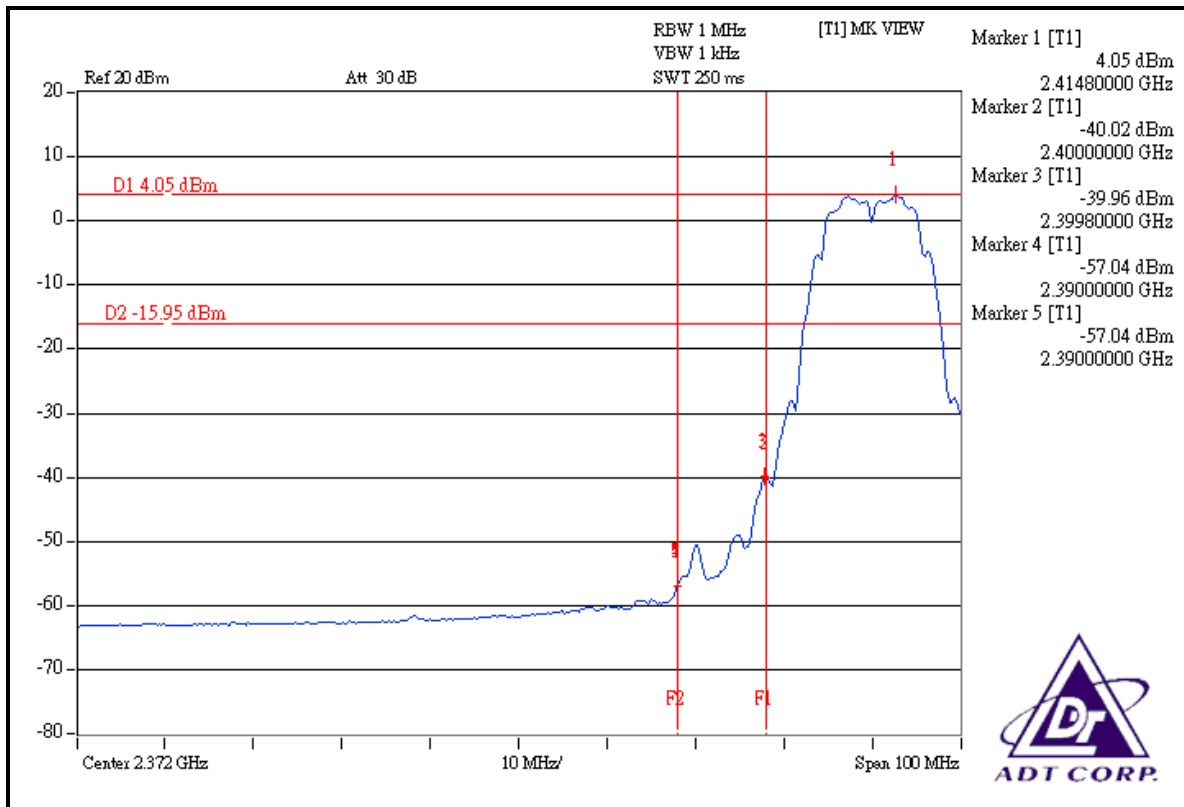
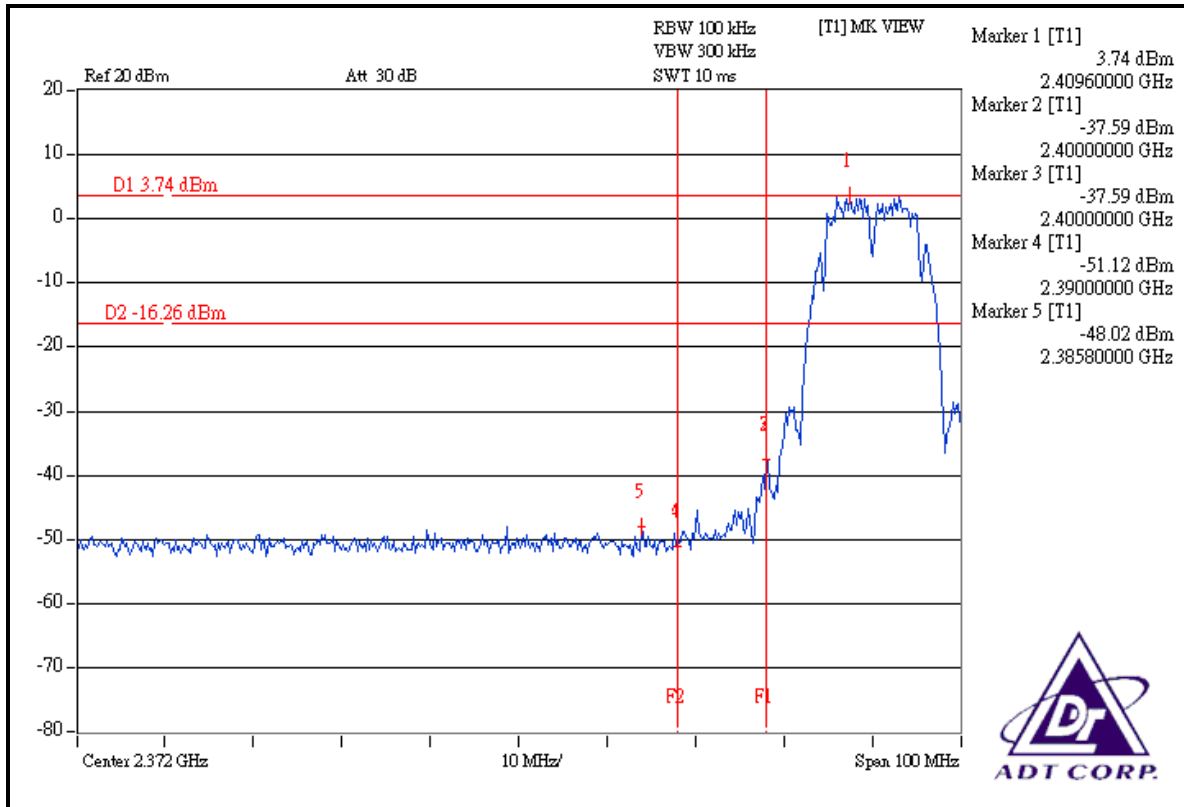

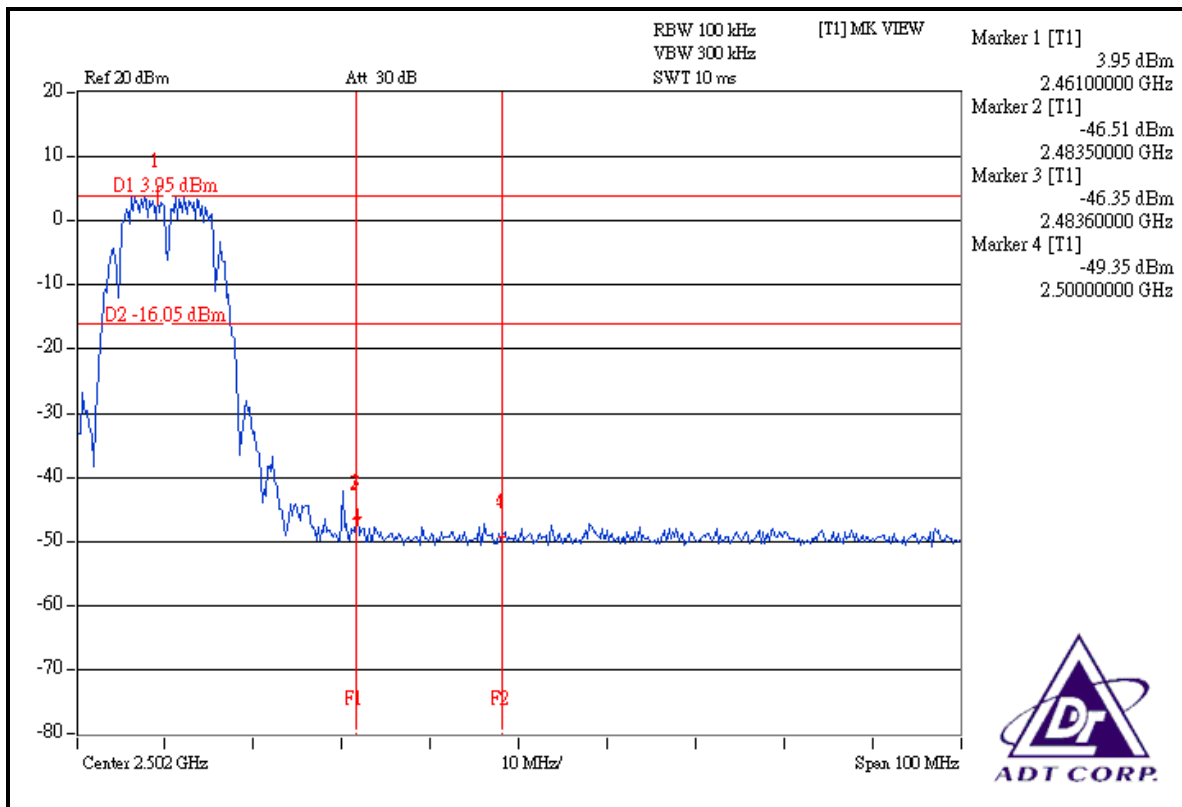
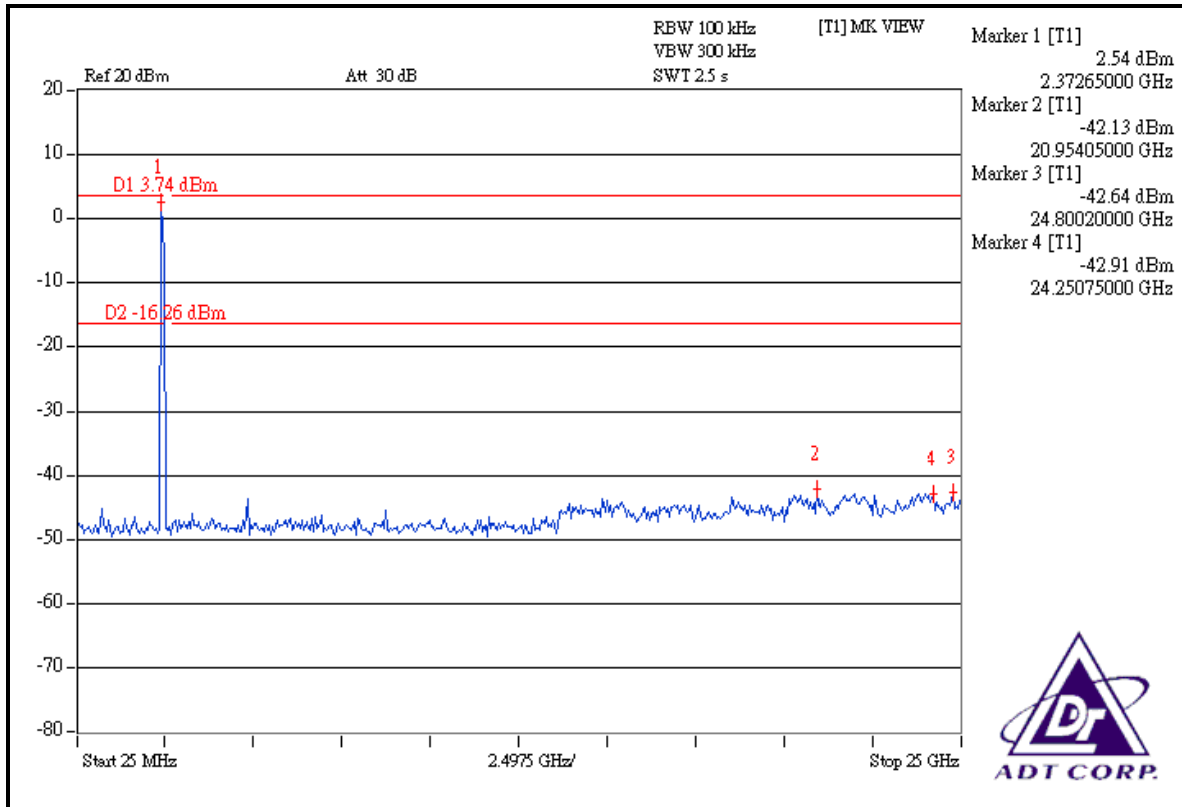

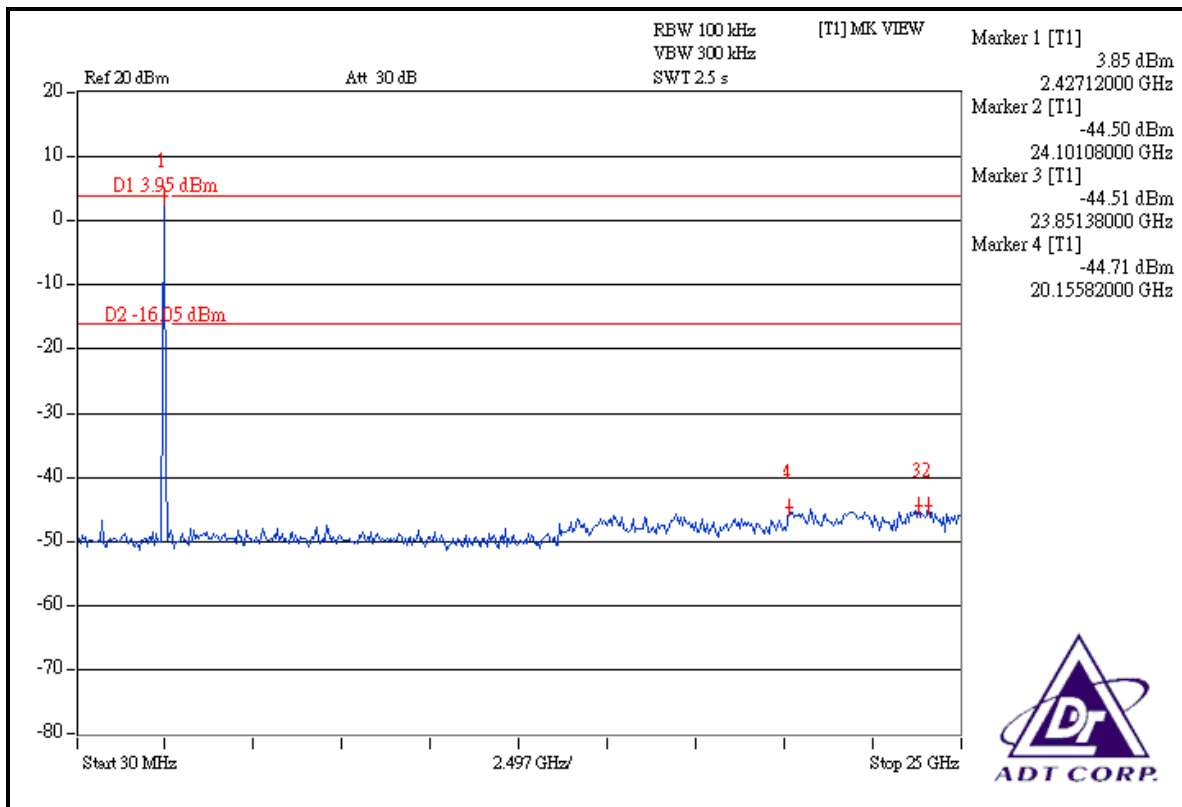
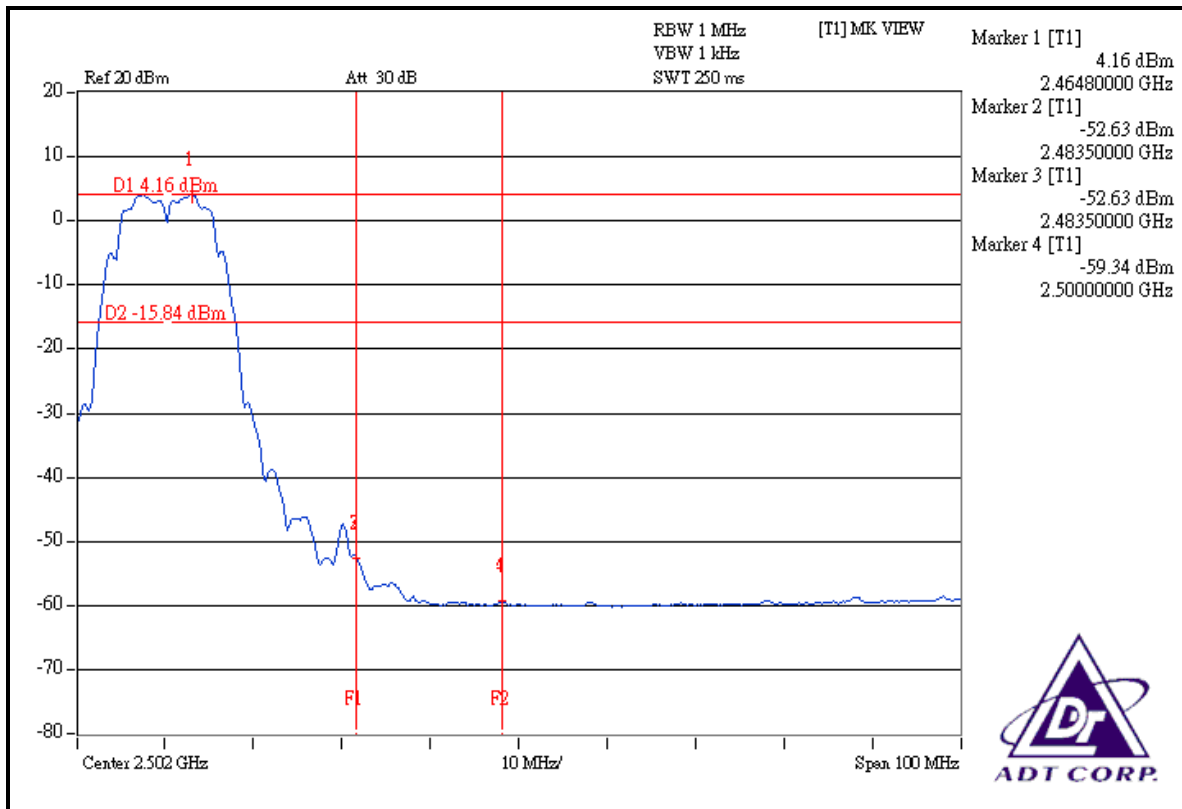



## 802.11g OFDM MODULATION

**NOTE 1:** The band edge emission plot on the next page shows 44.36dBc between carrier maximum power and local maximum emission in restrict band (2.33300GHz). The emission of carrier strength list in the test result of channel 1 at the item 4.2.7 is 100.80dBuV/m (Peak), so the maximum field strength in restrict band is  $100.80 - 44.36 = 56.44$ dBuV/m which is under 74dBuV/m limit.

The band edge emission plot of on the next page shows 54.20dBc between carrier maximum power and local maximum emission in restrict band (2.39000GHz). The emission of carrier strength list in the test result of channel 1 at the item 4.2.7 is 93.00dBuV/m (Average), so the maximum field strength in restrict band is  $93.00 - 54.20 = 38.80$ dBuV/m which is under 54dBuV/m limit.

**NOTE 2:** The band edge emission plot on the next second page shows 44.12dBc between carrier maximum power and local maximum emission in restrict band (2.48420GHz). The emission of carrier strength list in the test result of channel 11 at the item 4.2.7 is 99.00dBuV/m (Peak), so the maximum field strength in restrict band is  $99.00 - 44.12 = 54.88$ dBuV/m which is under 74dBuV/m limit.

The band edge emission plot on the next third page shows 49.73dBc between carrier maximum power and local maximum emission in restrict band (2.48350GHz). The emission of carrier strength list in the test result of channel 11 at the item 4.2.7 is 91.21dBuV/m (Average), so the maximum field strength in restrict band is  $91.21 - 49.73 = 41.48$ dBuV/m which is under 54dBuV/m limit.

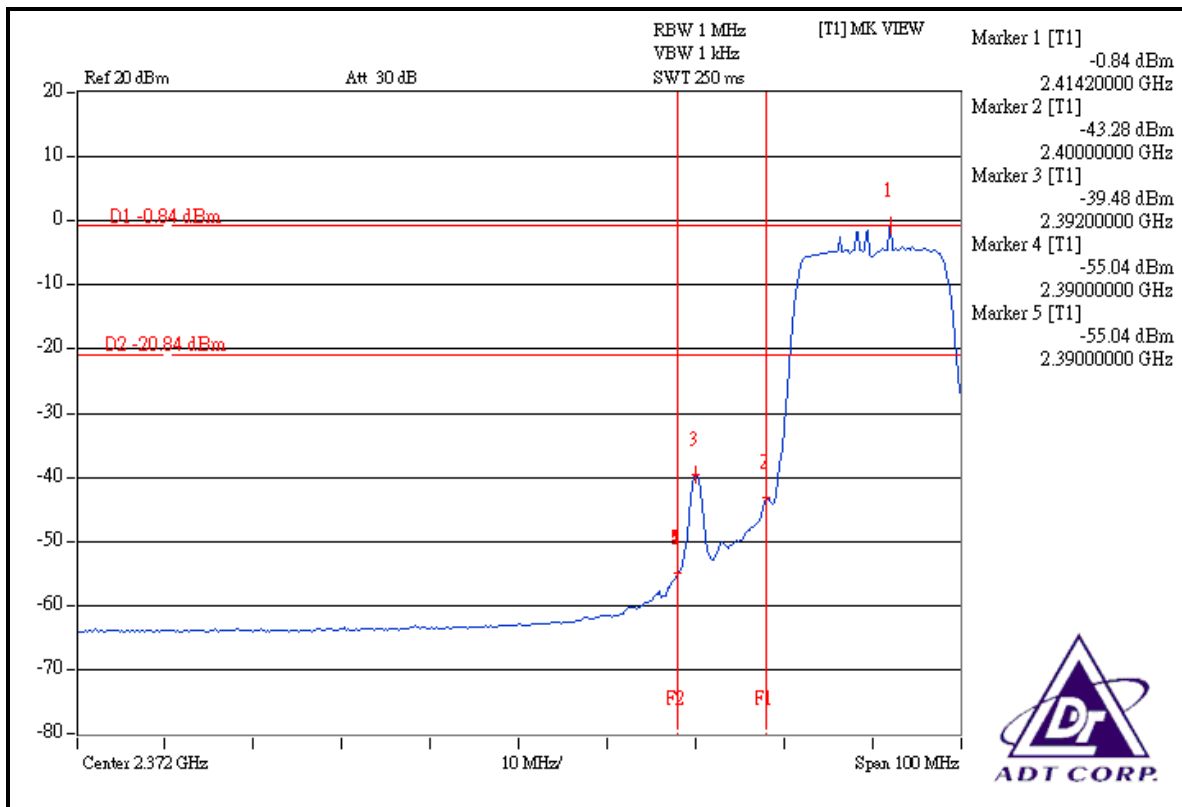
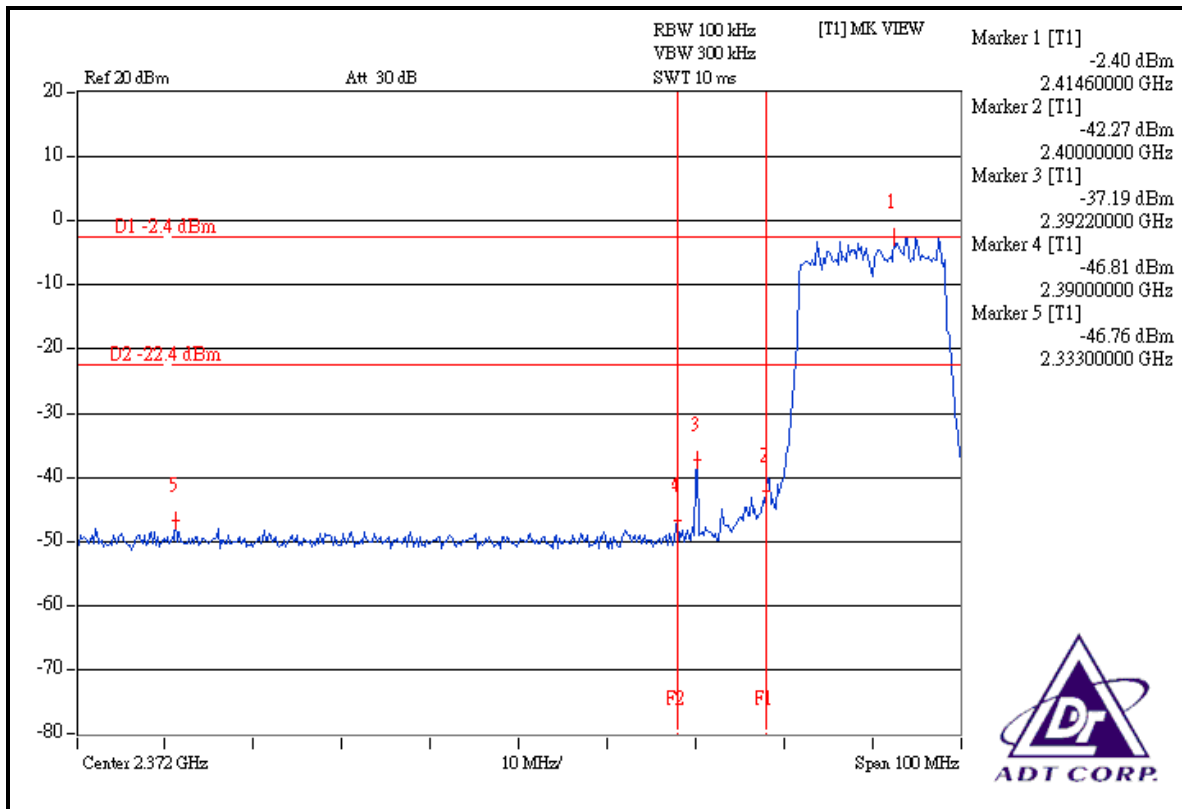

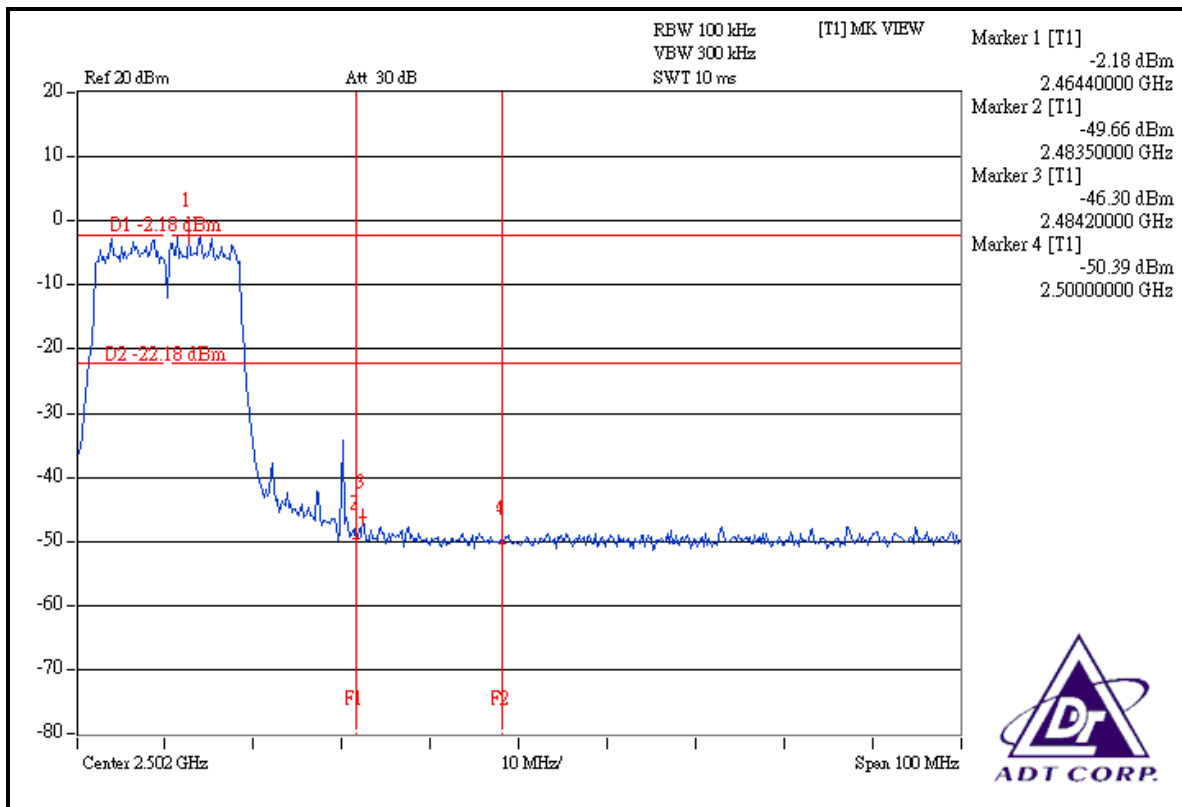
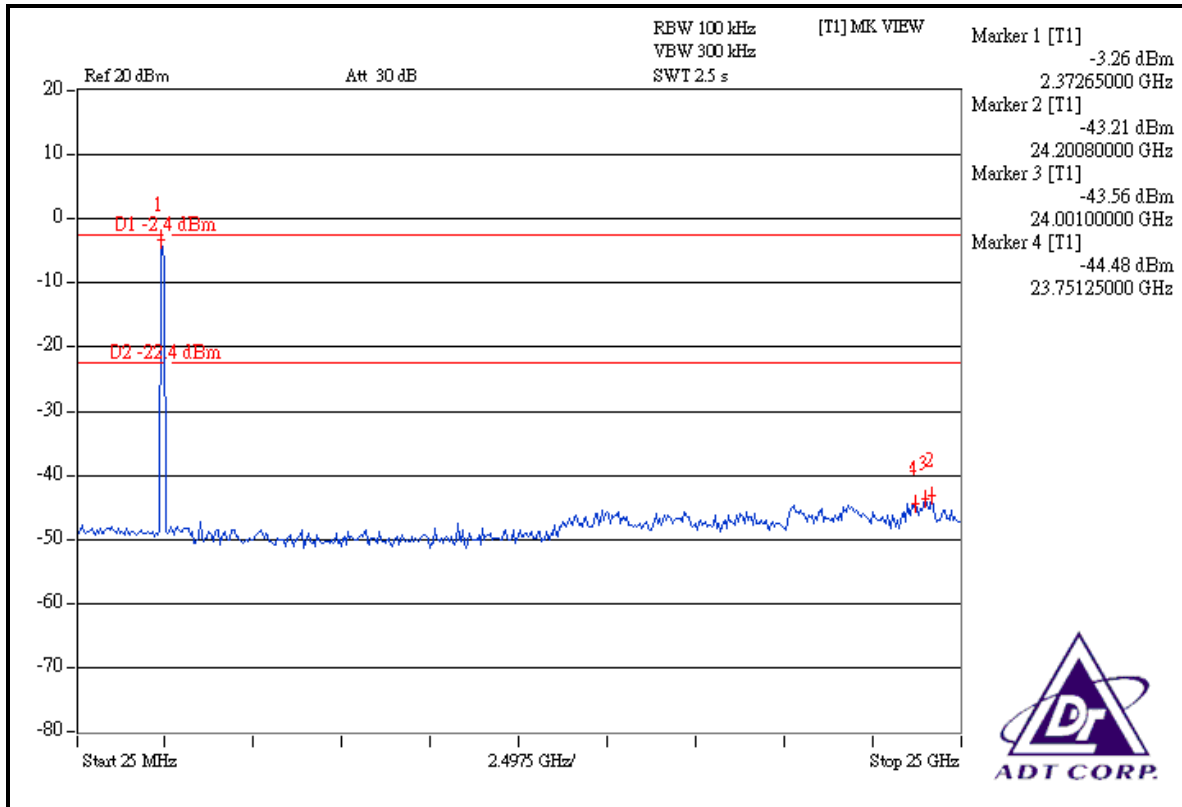



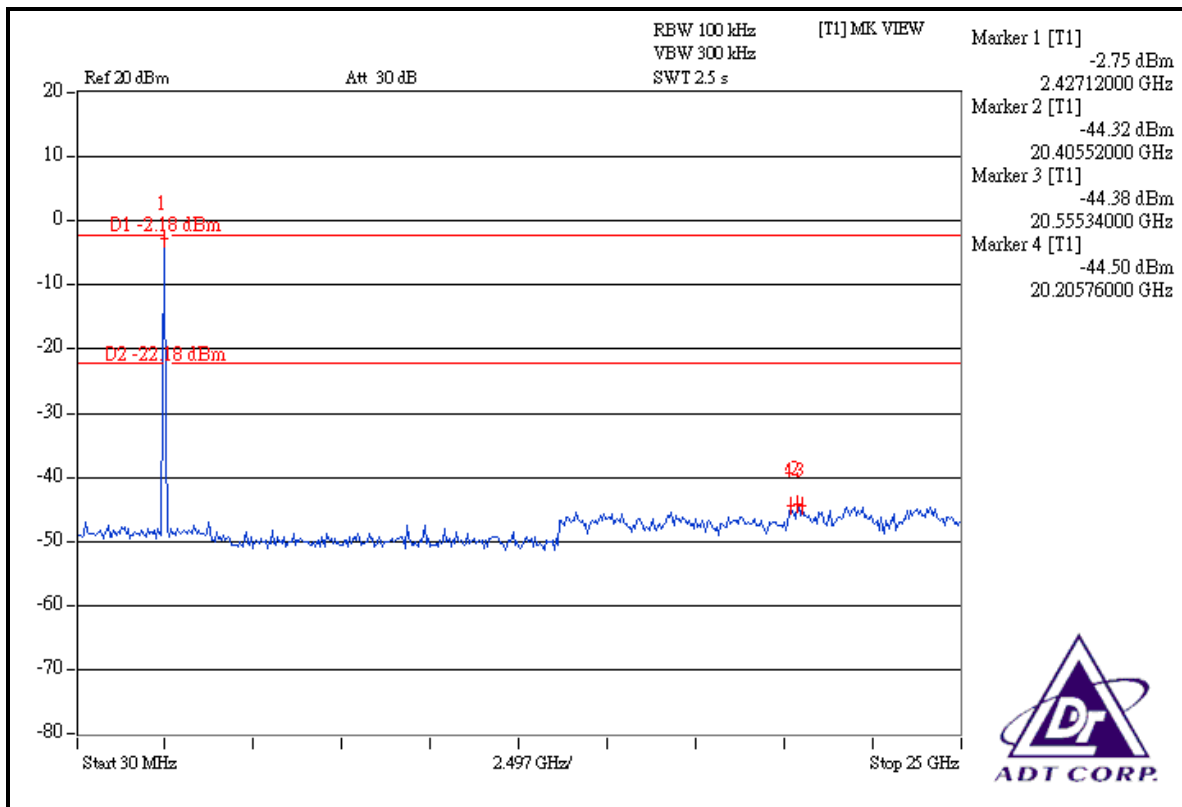
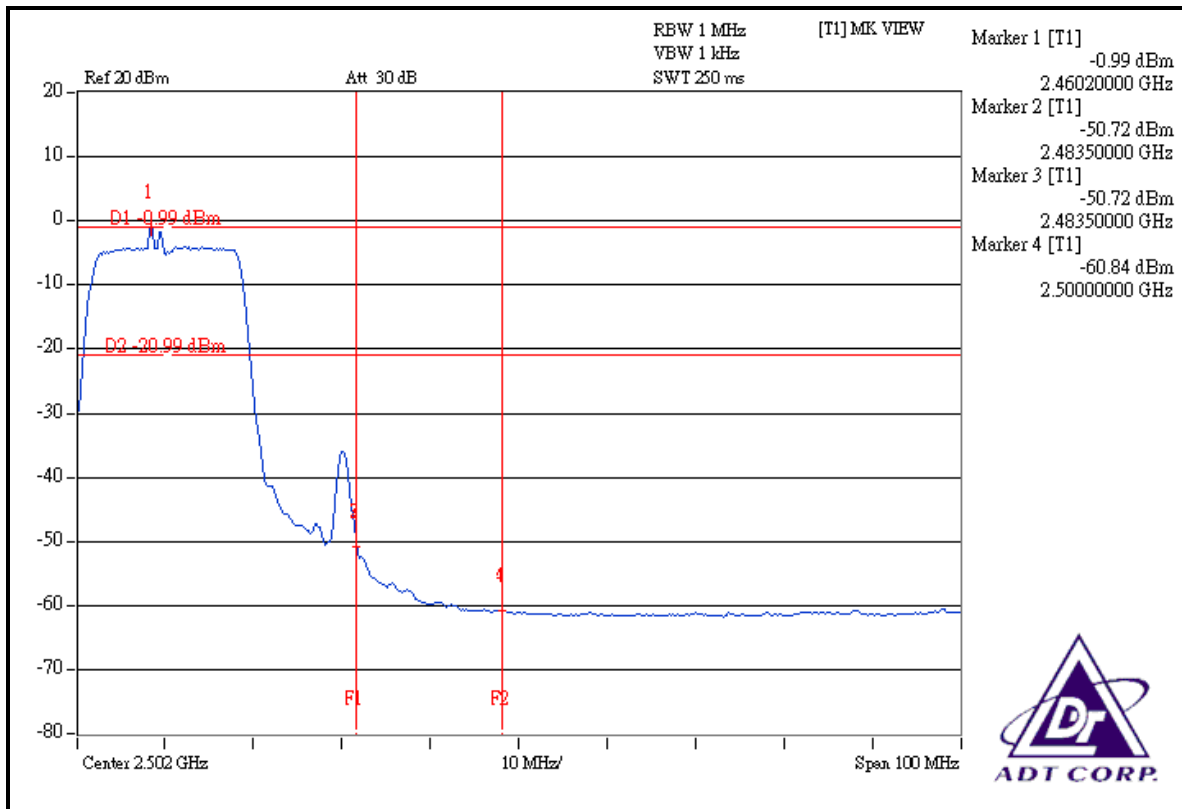



## **4.7 ANTENNA REQUIREMENT**

### **4.7.1 STANDARD APPLICABLE**

For intentional device, according to FCC 47 CFR Section 15.203, an intentional radiator shall be designed to ensure that no antenna other than that furnished by the responsible party shall be used with the device.

And according to FCC 47 CFR Section 15.247 (b), if transmitting antennas of directional gain greater than 6dBi are used, the power shall be reduced by the amount in dB that the directional gain of the antenna exceeds 6dBi.

### **4.7.2 ANTENNA CONNECTED CONSTRUCTION**

The antenna used in this product is Printed antenna without connector. The maximum Gain of the antenna is 0.5dBi.



## 5 PHOTOGRAPHS OF THE TEST CONFIGURATION

Please refer to the attached file (Test Setup Photo).



## 6 INFORMATION ON THE TESTING LABORATORIES

We, ADT Corp., were founded in 1988 to provide our best service in EMC, Radio, Telecom and Safety consultation. Our laboratories are accredited and approved by the following approval agencies according to ISO/IEC 17025.

<b>USA</b>	FCC, UL, A2LA
<b>Germany</b>	TUV Rheinland
<b>Japan</b>	VCCI
<b>Norway</b>	NEMKO
<b>Canada</b>	INDUSTRY CANADA , CSA
<b>R.O.C.</b>	TAF, BSMI, NCC
<b>Netherlands</b>	Telefication
<b>Singapore</b>	GOST-ASIA(MOU)
<b>Russia</b>	CERTIS(MOU)

Copies of accreditation certificates of our laboratories obtained from approval agencies can be downloaded from our web site: [www.adt.com.tw/index.5/phtml](http://www.adt.com.tw/index.5/phtml). If you have any comments, please feel free to contact us at the following:

### **Linko EMC/RF Lab**

Tel: 886-2-26052180

Fax: 886-2-26051924

### **Hsin Chu EMC/RF Lab**

Tel: 886-3-5935343

Fax: 886-3-5935342

### **Hwa Ya EMC/RF/Safety/Telecom Lab**

Tel: 886-3-3183232

Fax: 886-3-3185050

**Web Site:** [www.adt.com.tw](http://www.adt.com.tw)

The address and road map of all our labs can be found in our web site also.



## **7 APPENDIX A – MODIFICATIONS RECORDERS FOR ENGINEERING CHANGES TO THE EUT BY THE LAB**

No any modifications are made to the EUT by the lab during the test.