

# CONSTRUCTION PHOTOS OF EUT

Model: PB21

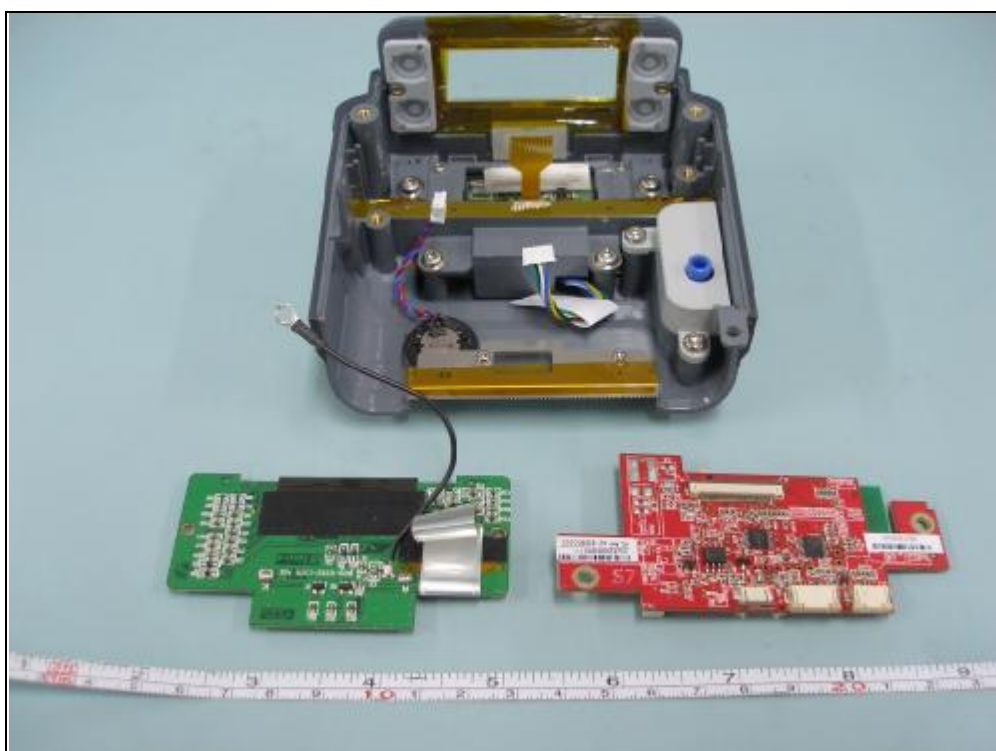

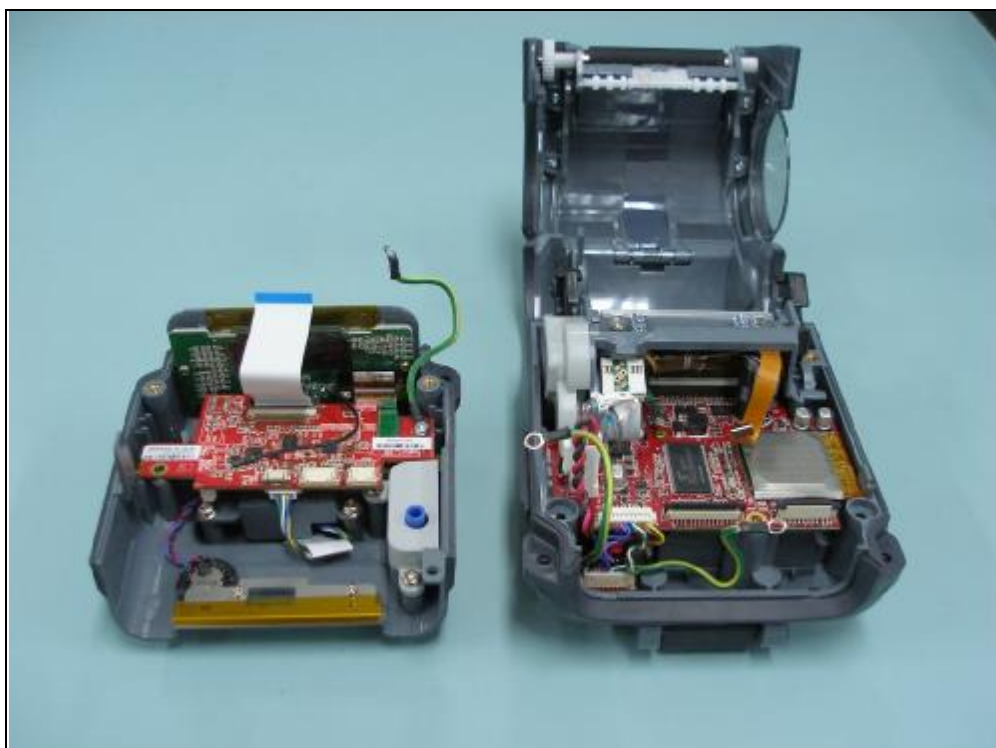

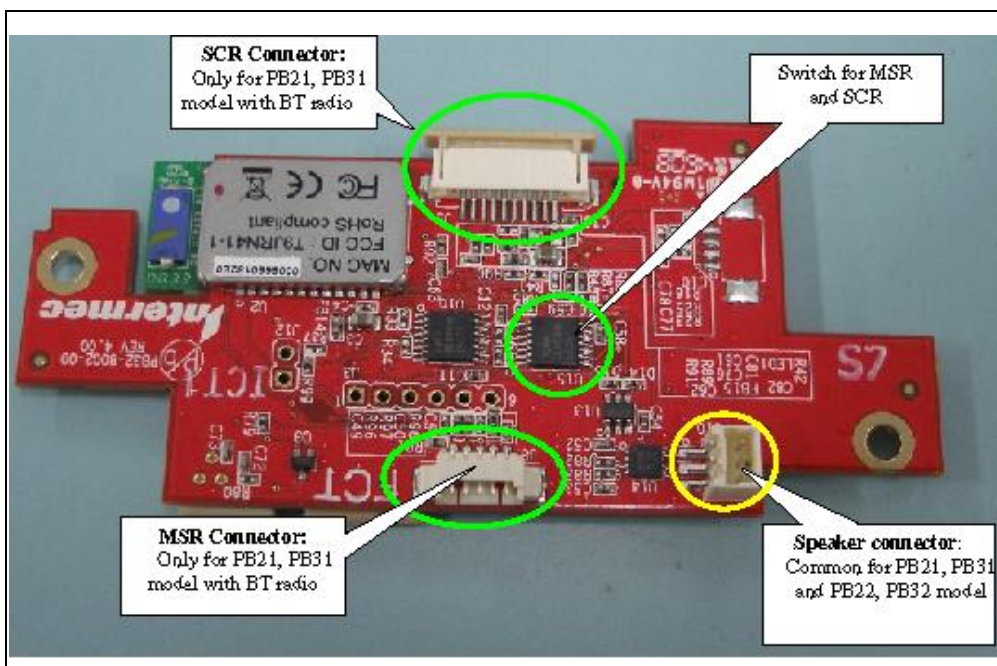
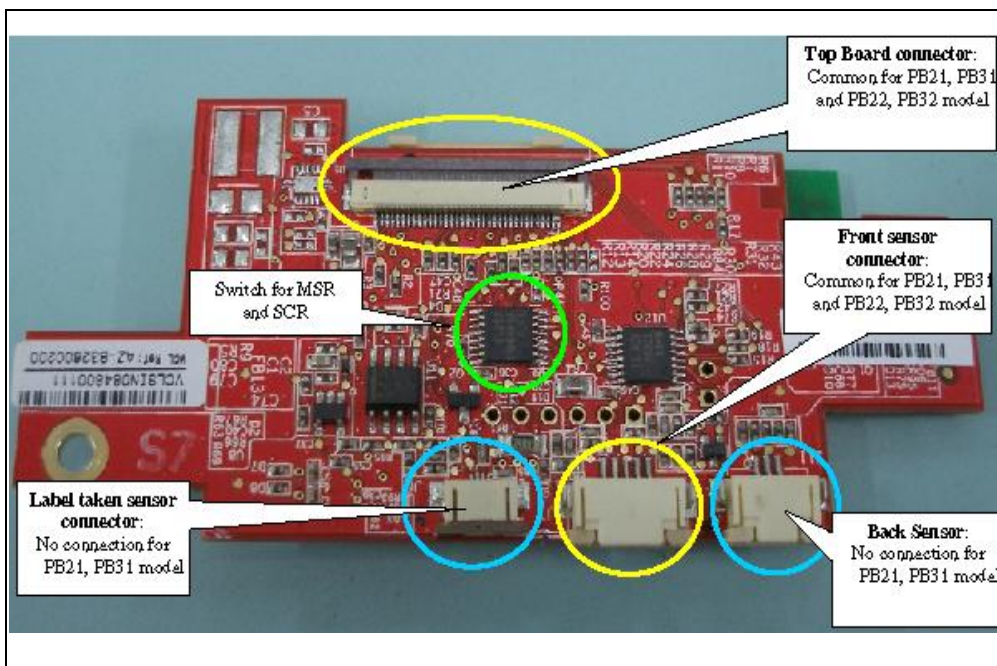
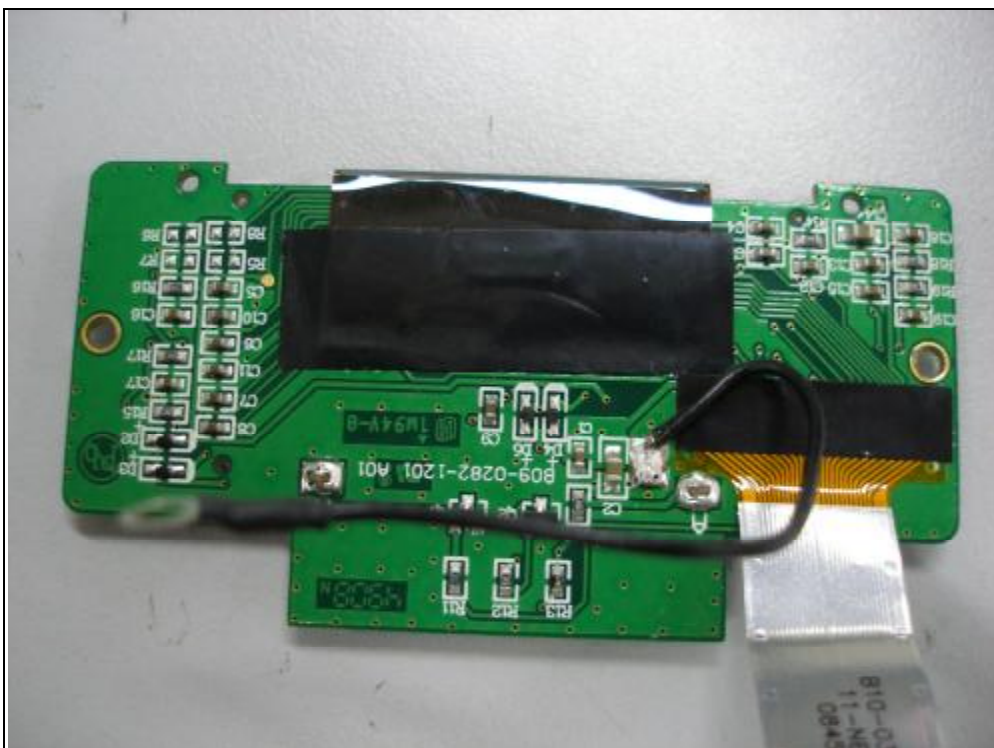
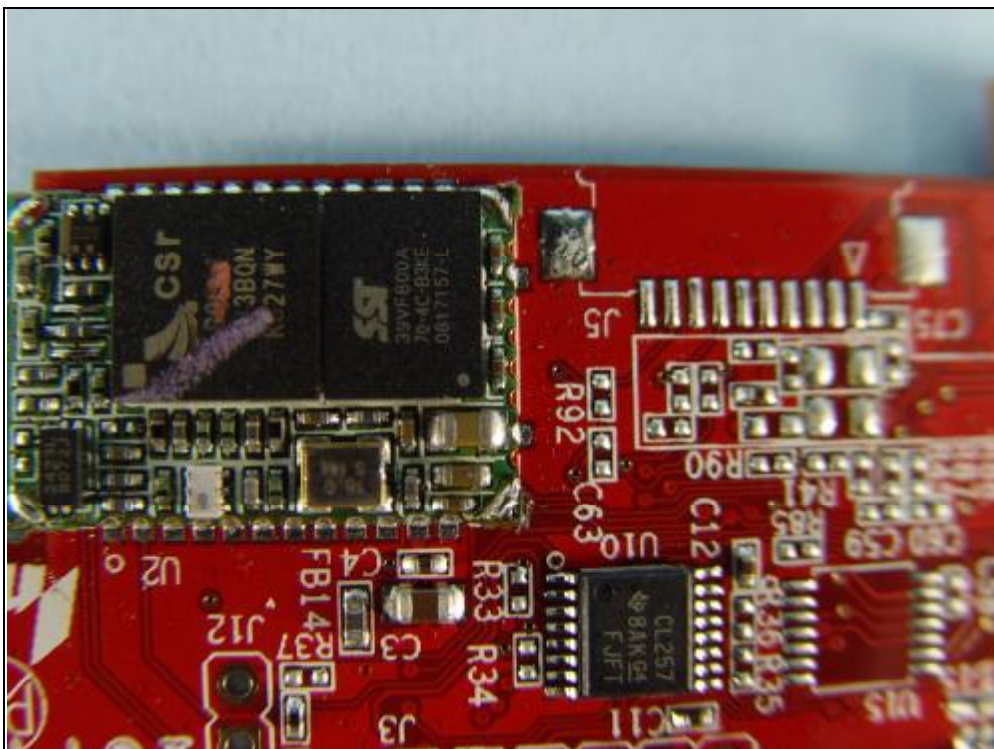



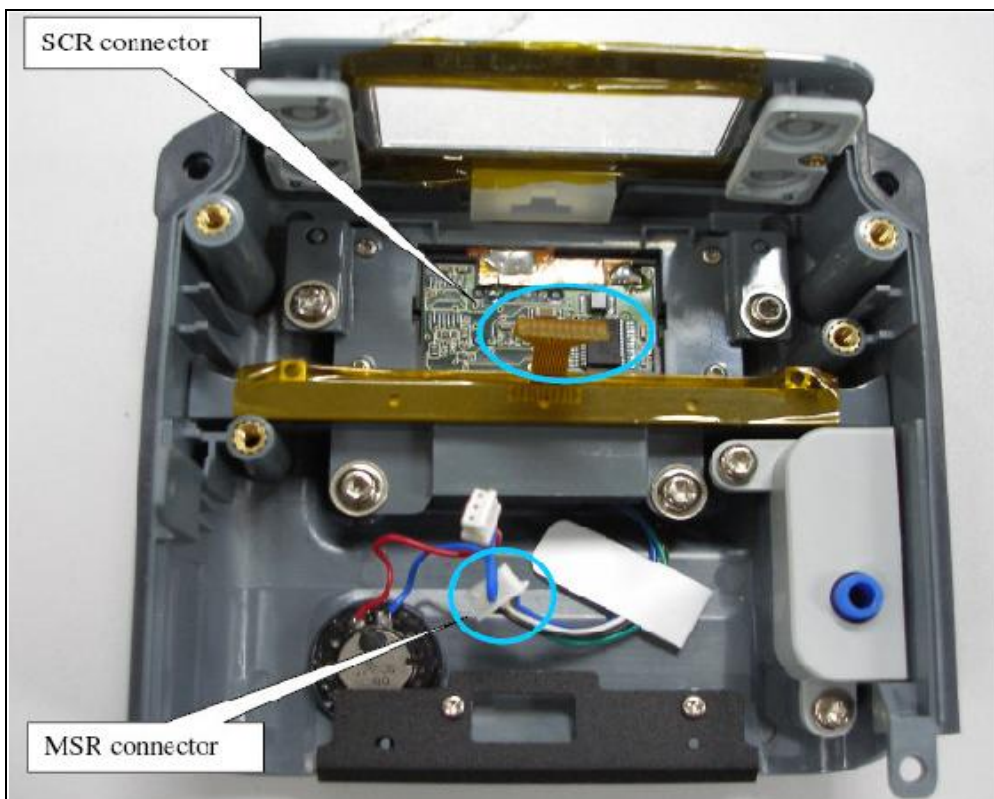
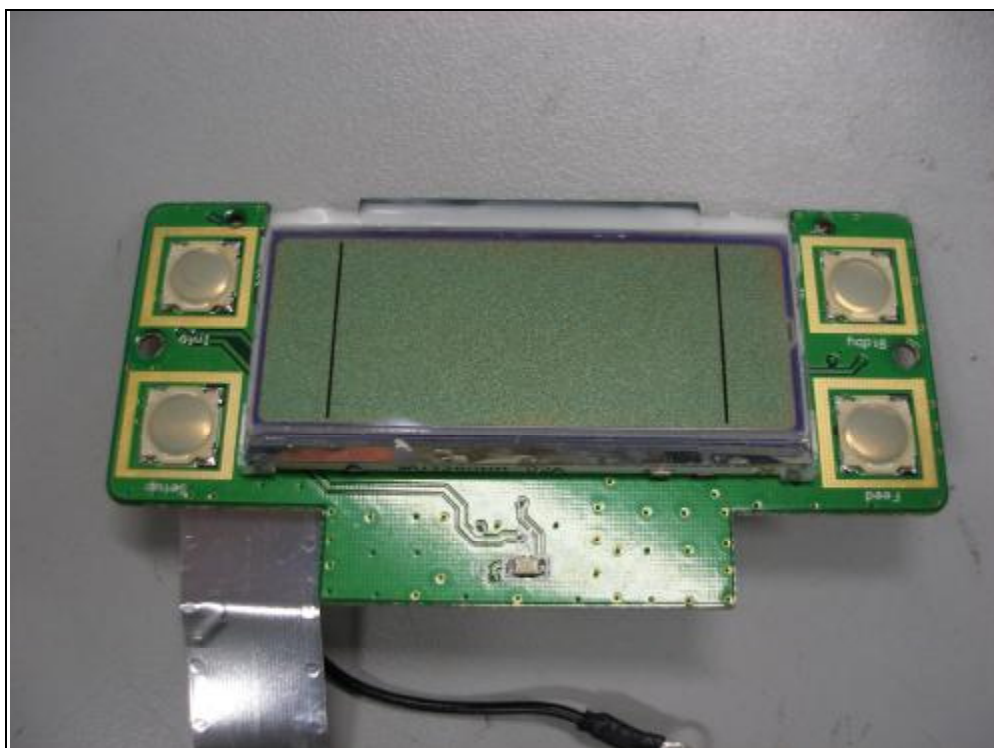

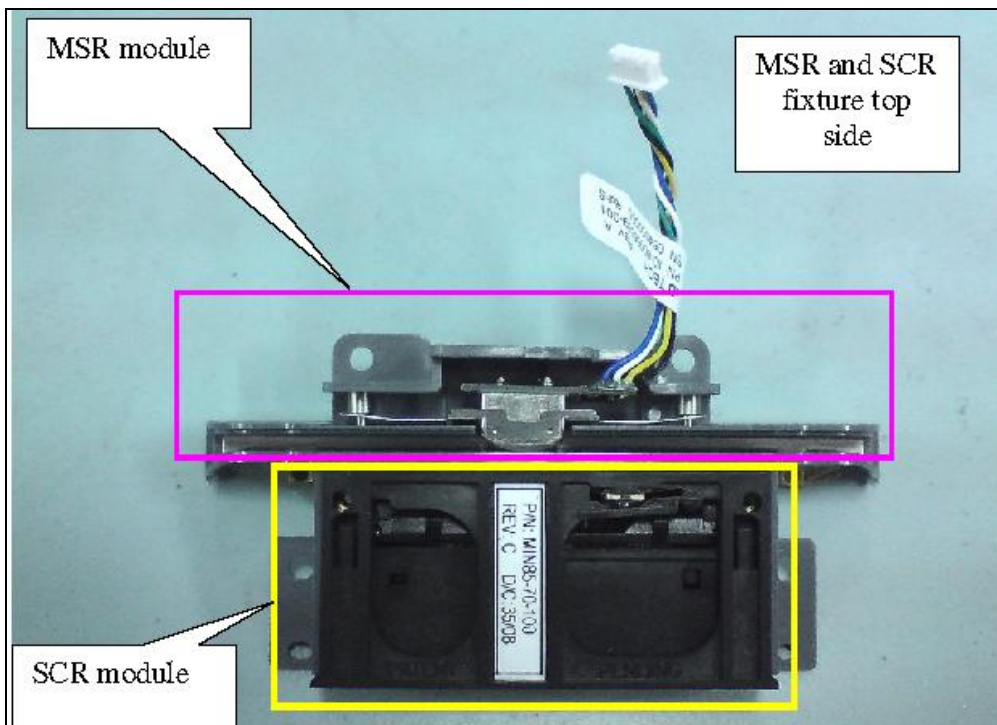
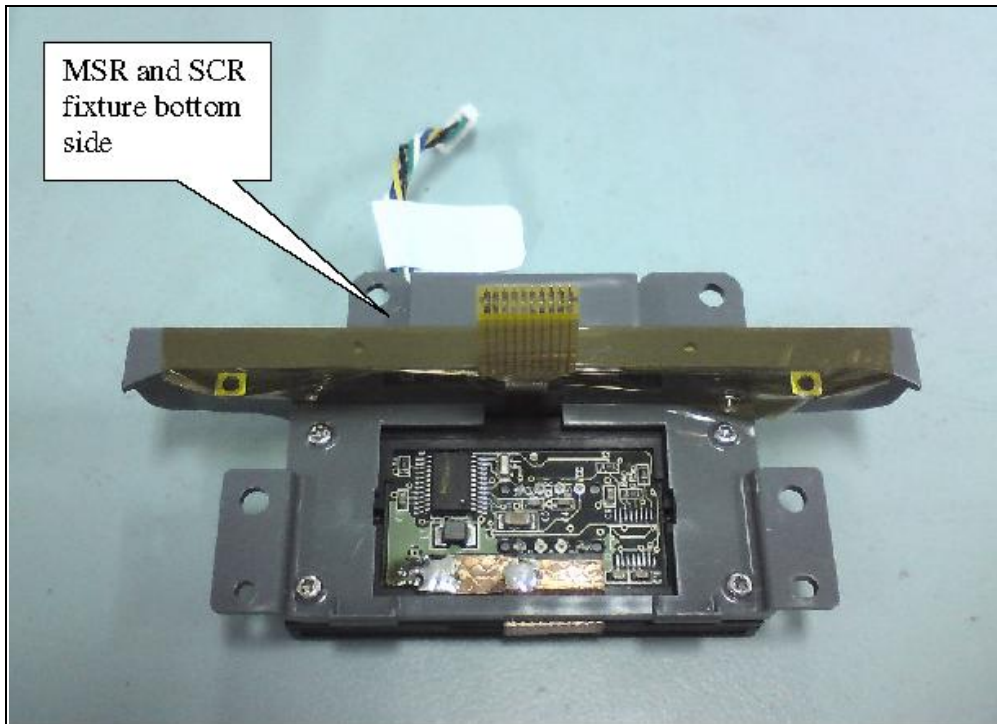

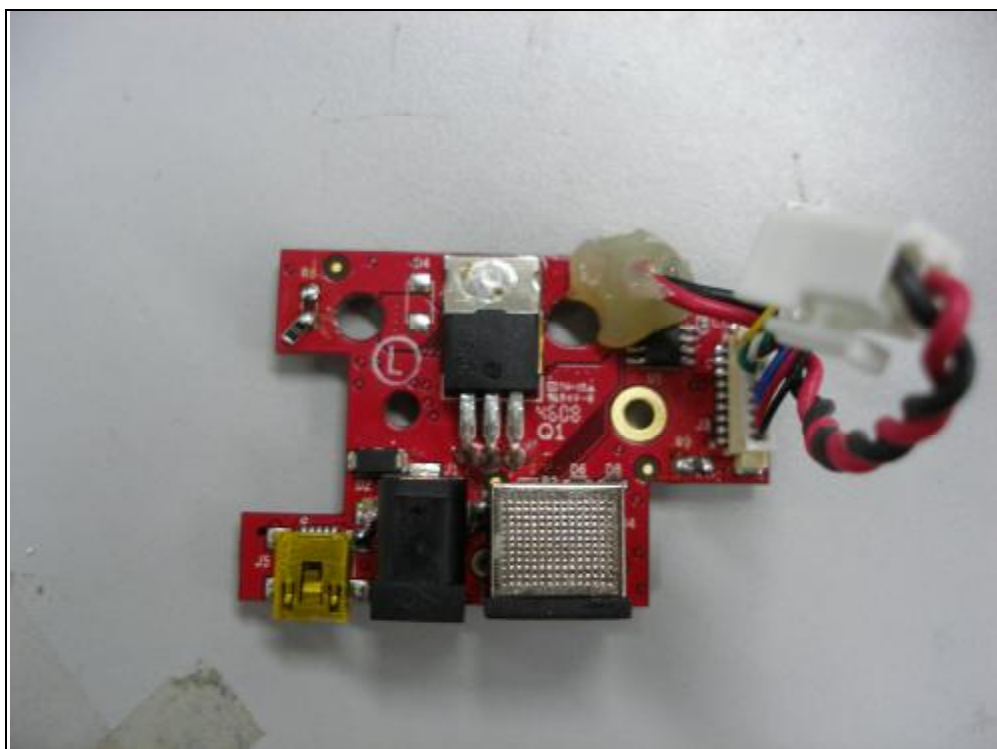
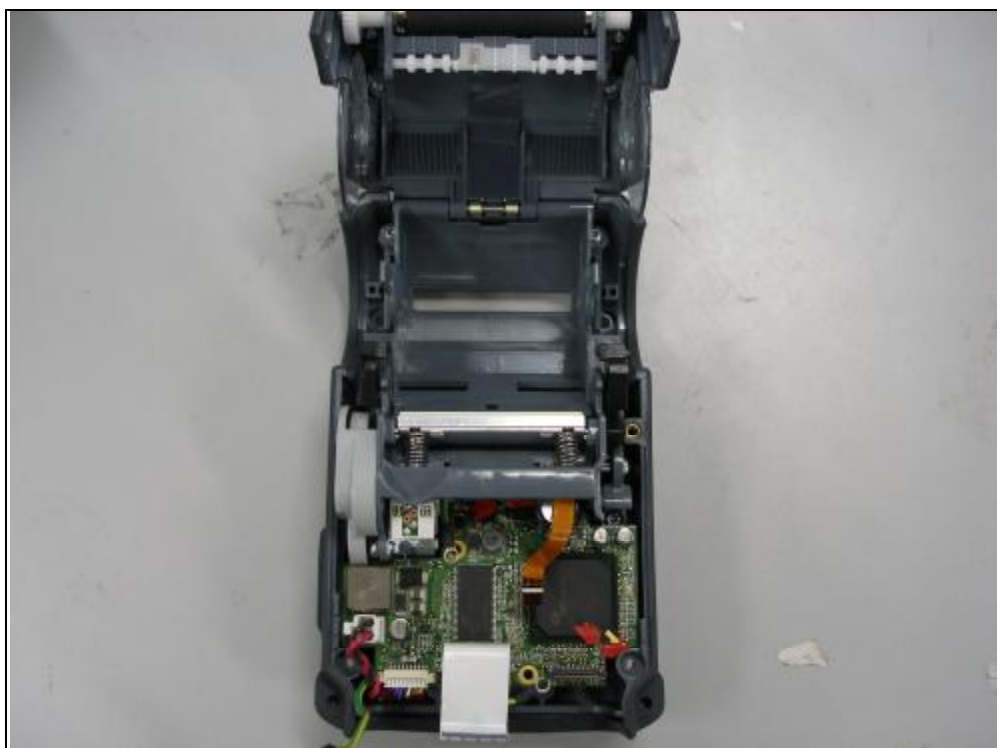



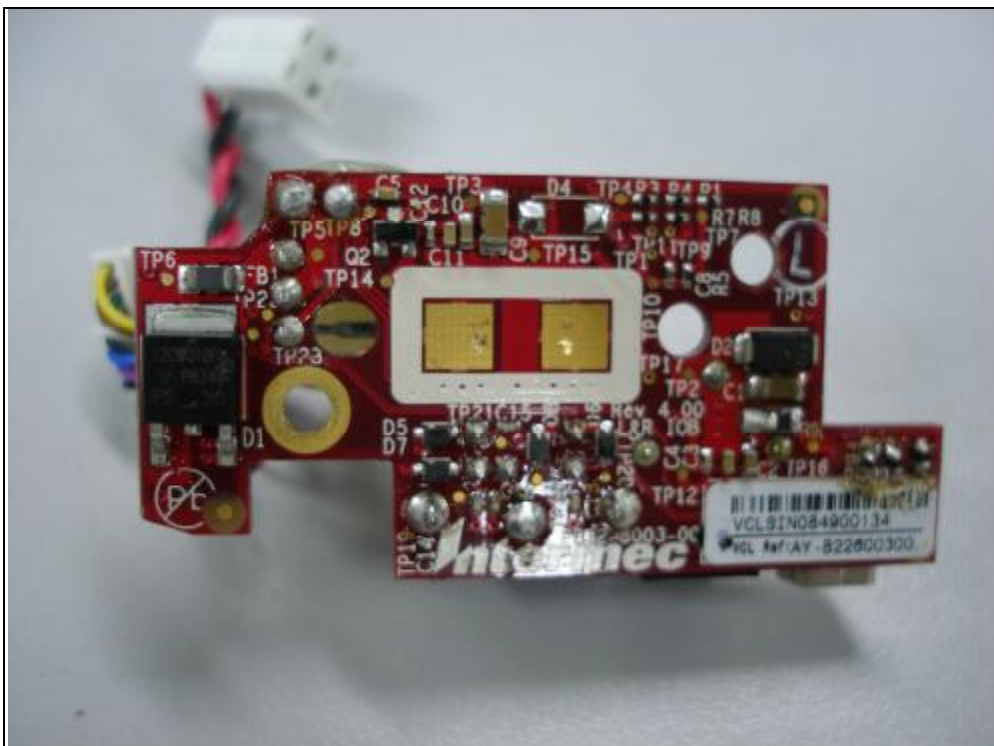

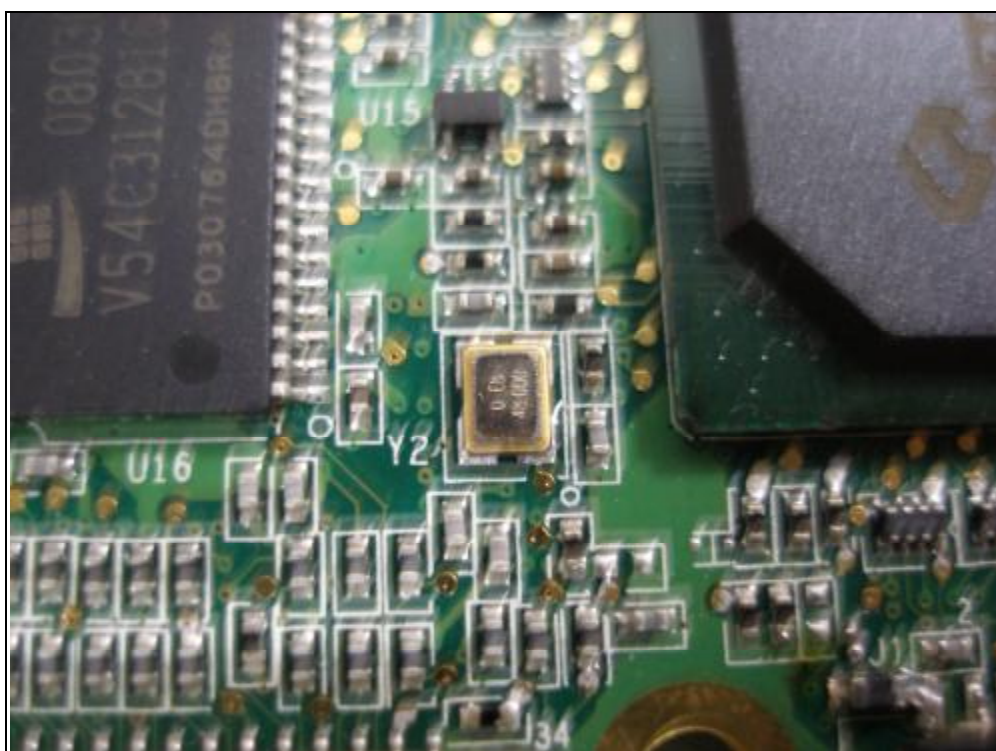
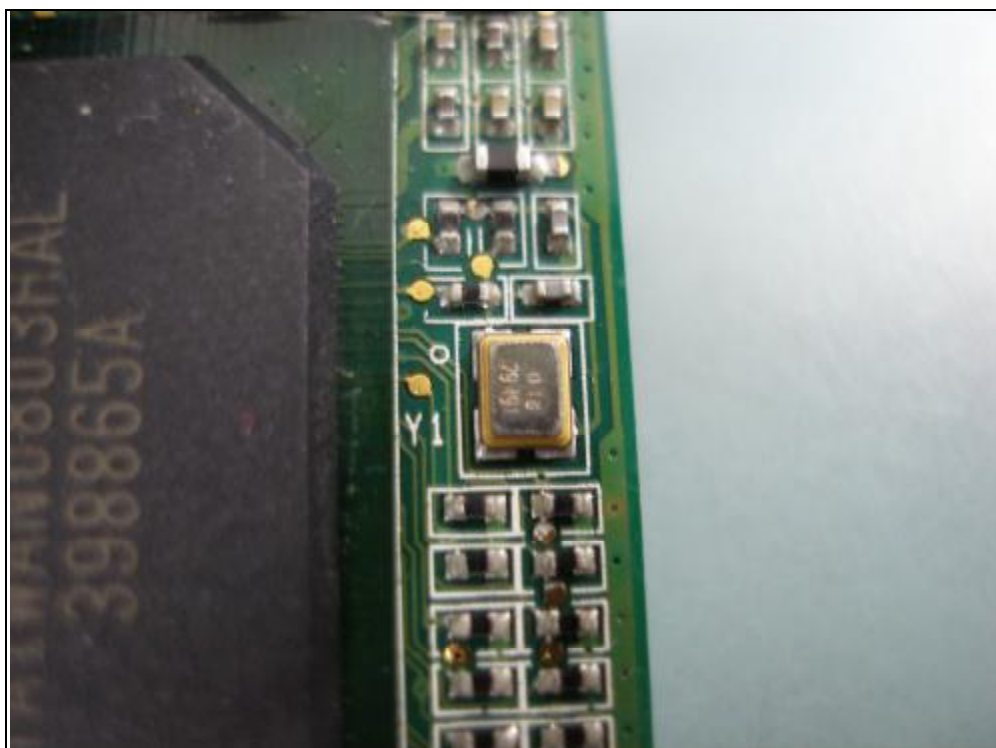



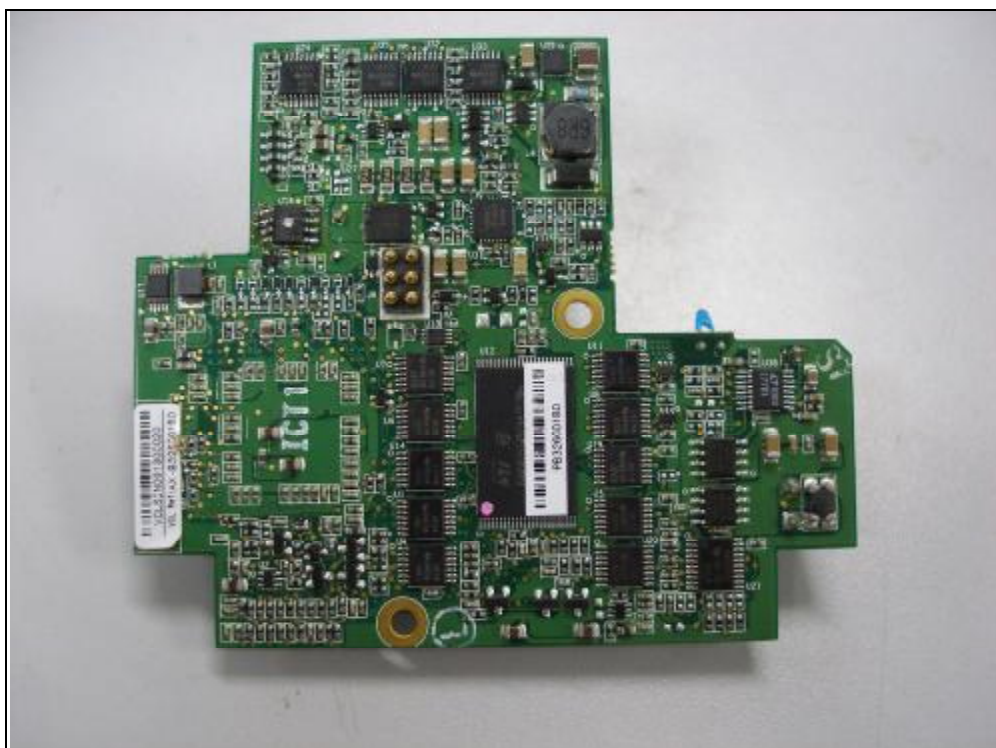

**Model: PB31**

