

Cut 15 mm from this end of the PCB.

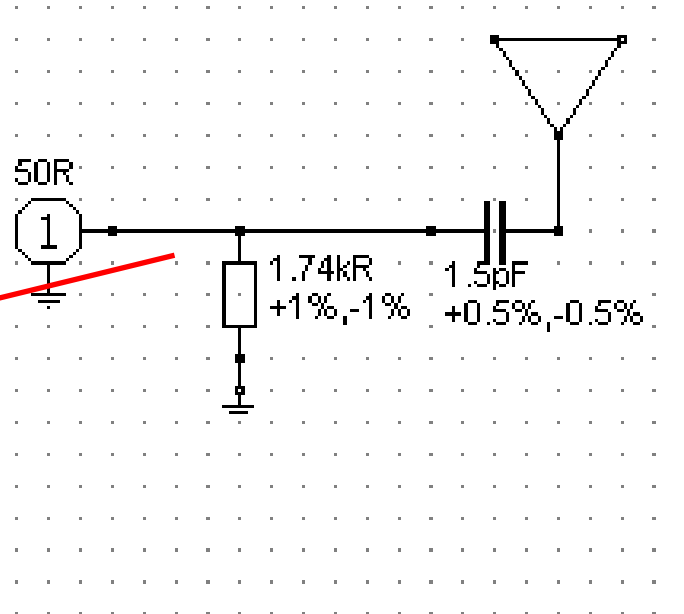

I used a 1.74K KOA resistor and a 1.5pf Johanson Cap both 0204 P.H.

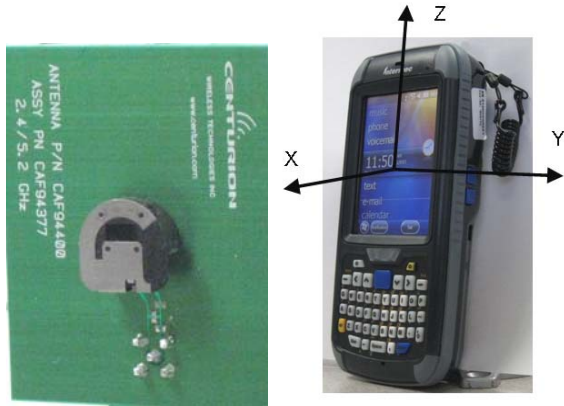

### WAN Free-Space Total EIRP, 2400MHz

Total EIRP, Right Side View

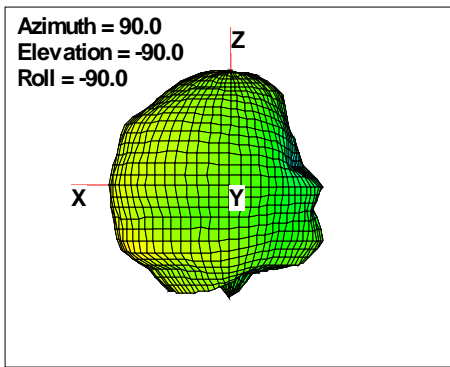

Total EIRP, Left Side View

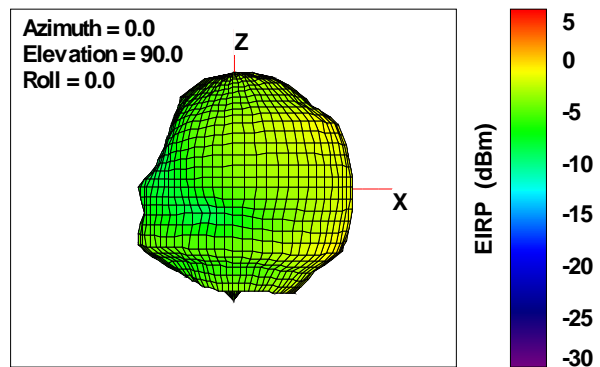

Total EIRP, Bottom View

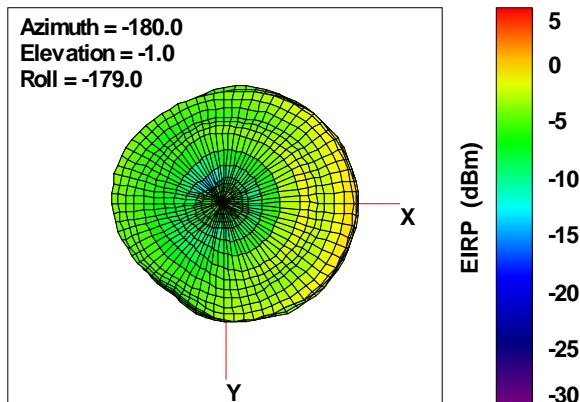

Total EIRP, Top View

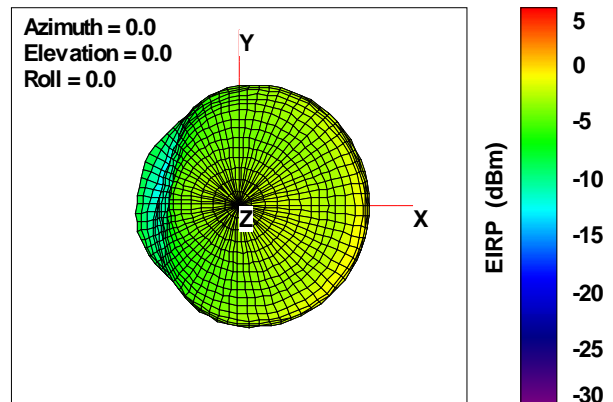

Total EIRP, Front Face View

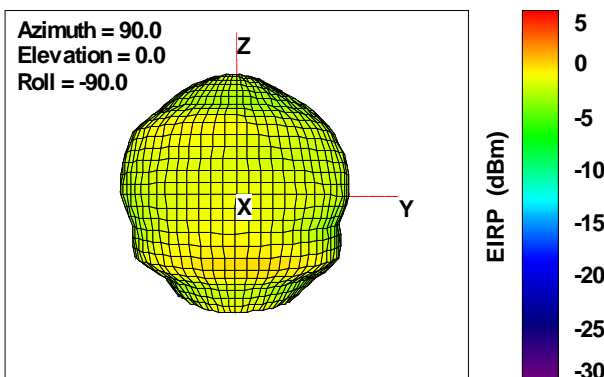

Total EIRP, Back Face View

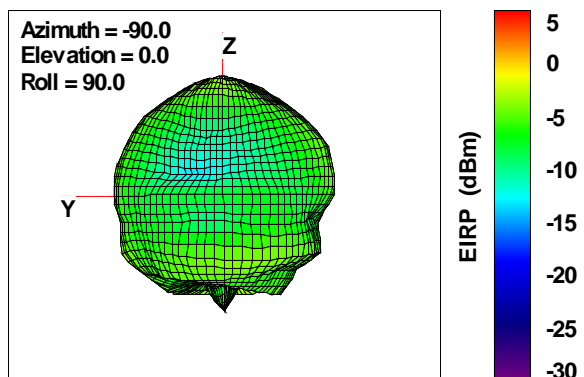

# WAN Free-Space Total EIRP, 2425MHz

### Total ERP, Right Side View

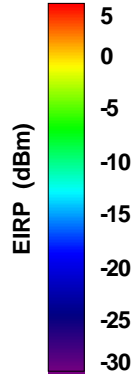
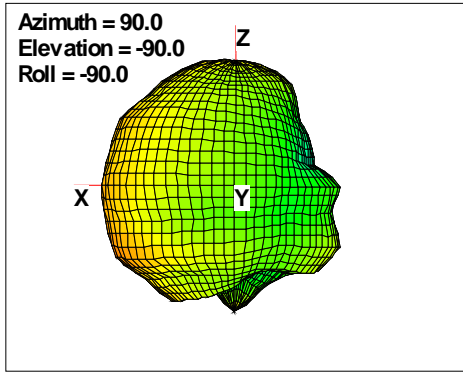

### Total ERP, Left Side View

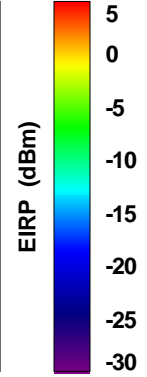
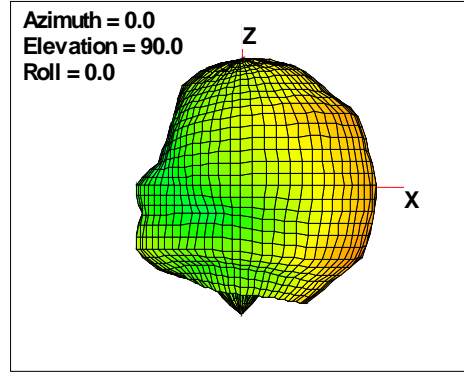

### Total ERP, Bottom View

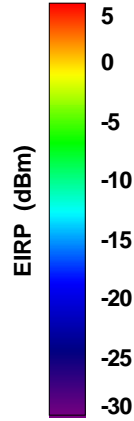
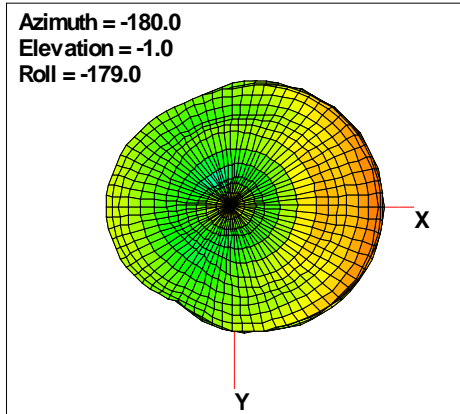

### Total ERP, Top View

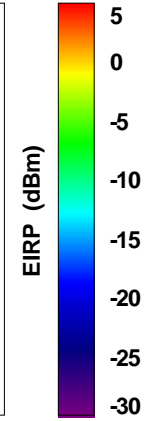
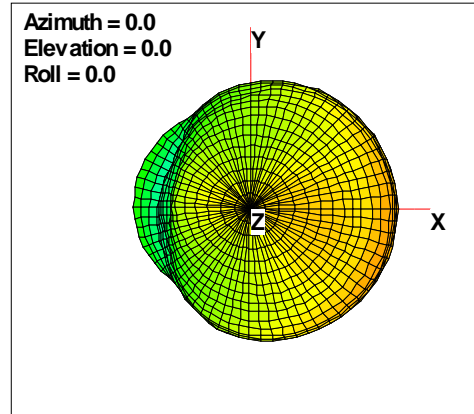

### Total ERP, Front Face View

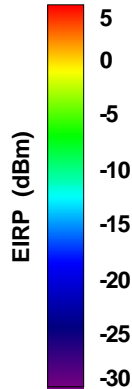
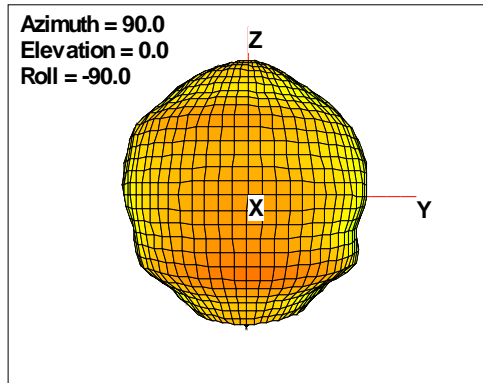

### Total ERP, Back Face View

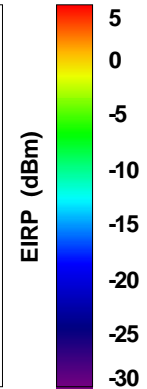
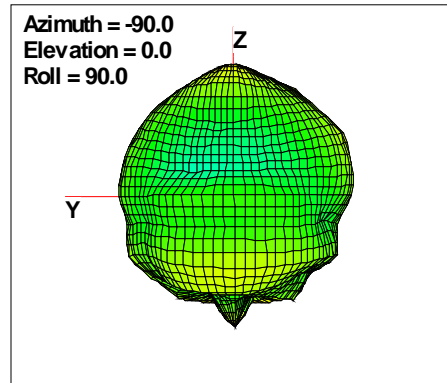



# WAN Free-Space Total EIRP, 2450MHz

### Total EIRP, Right Side View

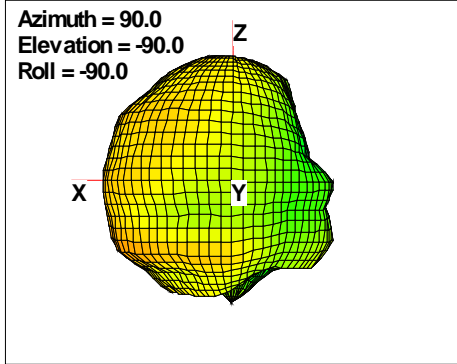

### Total EIRP, Left Side View

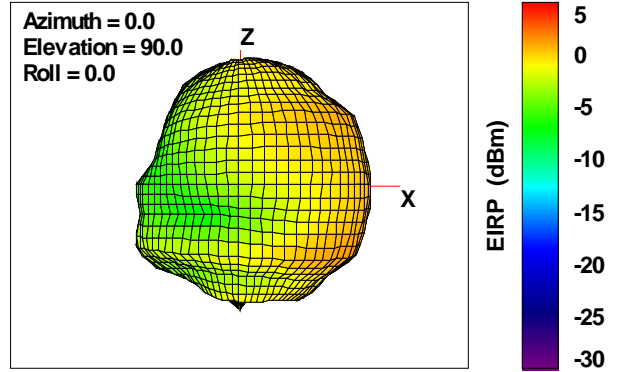

### Total EIRP, Bottom View

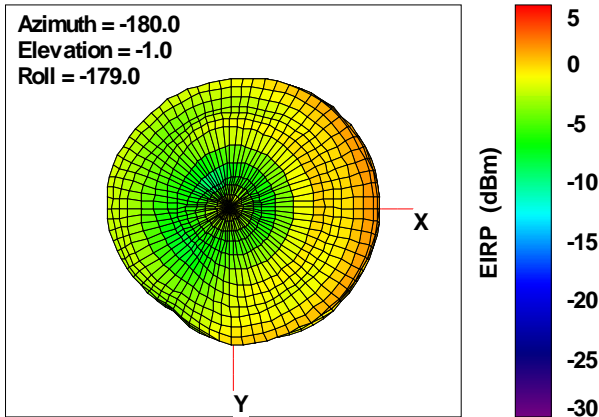

### Total EIRP, Top View

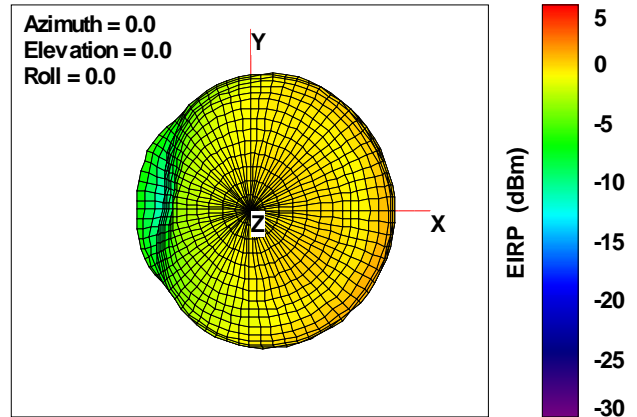

### Total EIRP, Front Face View

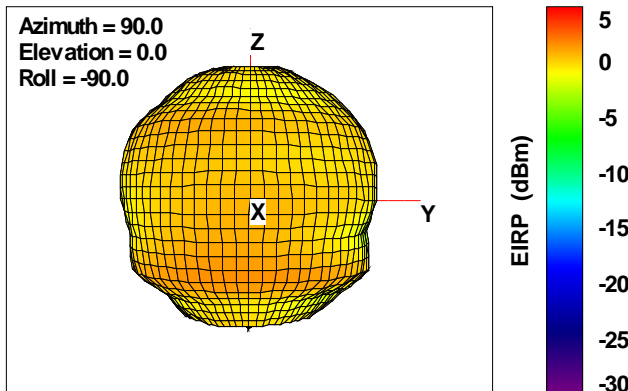

### Total EIRP, Back Face View

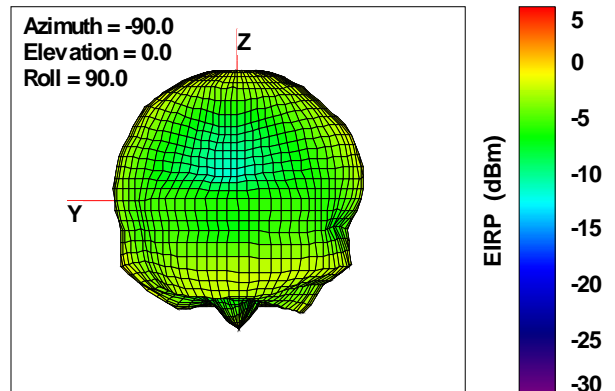

# WAN Free-Space Total EIRP, 2475MHz

### Total EIRP, Right Side View

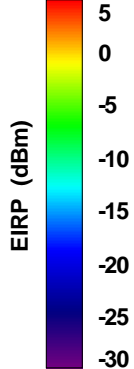
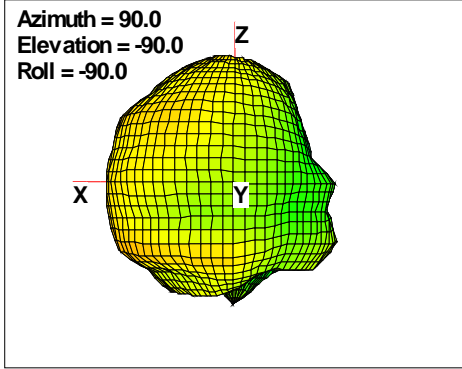

### Total EIRP, Left Side View

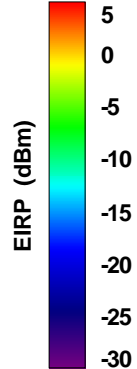
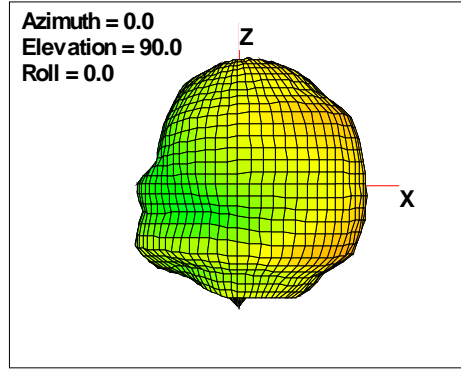

### Total EIRP, Bottom View

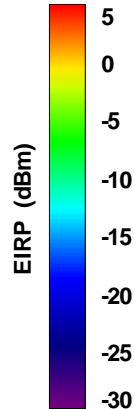
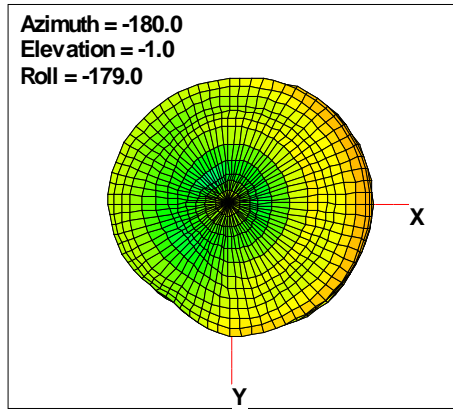

### Total EIRP, Top View

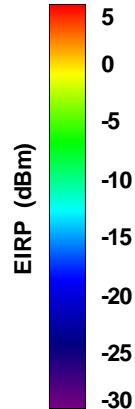
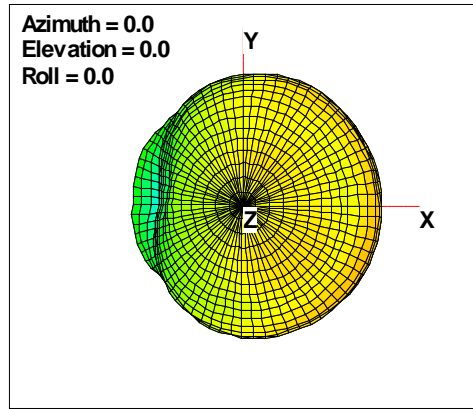

### Total EIRP, Front Face View

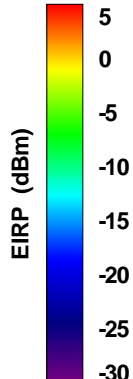
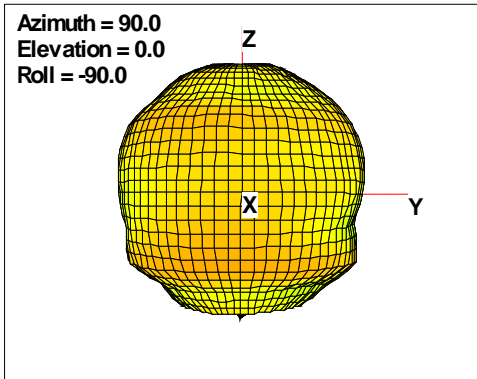

### Total EIRP, Back Face View

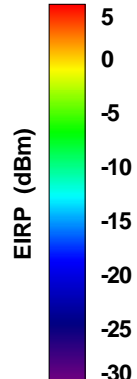
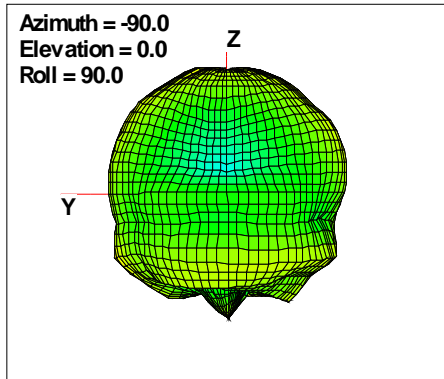

# WAN Free-Space Total EIRP, 2500MHz

Total EIRP, Right Side View

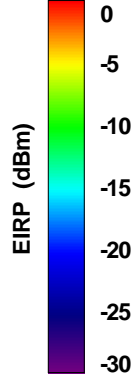
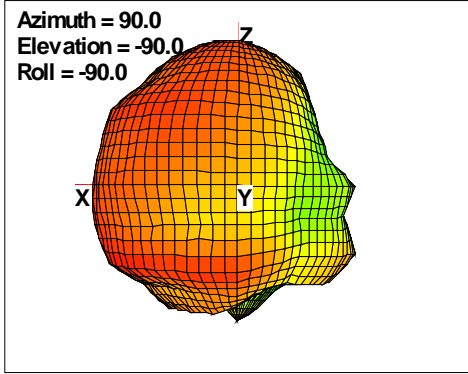

Total EIRP, Left Side View

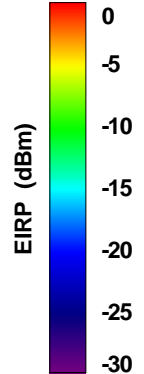
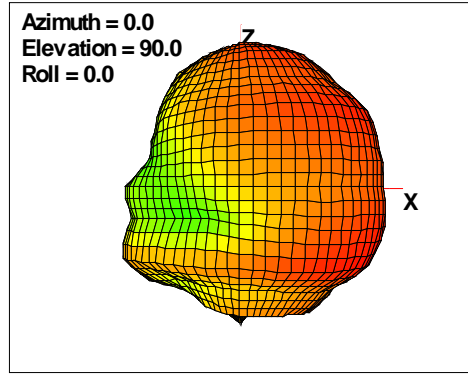

Total EIRP, Bottom View

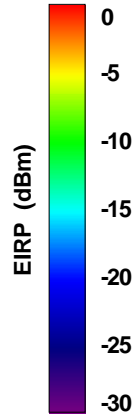
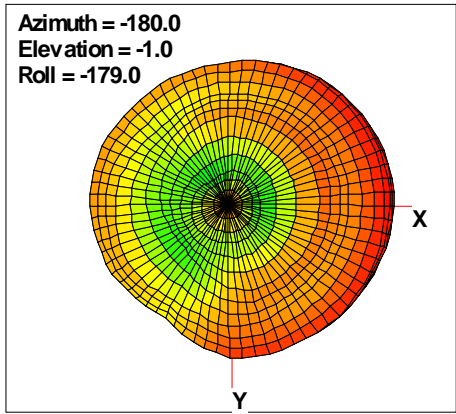

Total EIRP, Top View

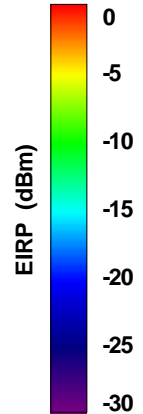
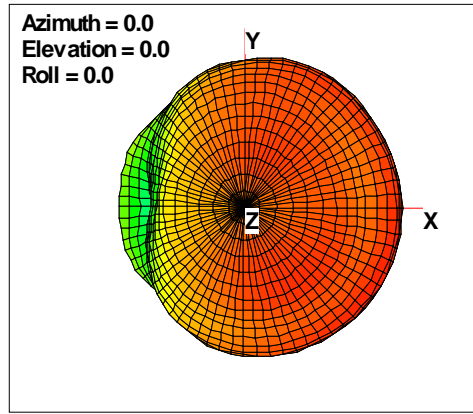

Total EIRP, Front Face View

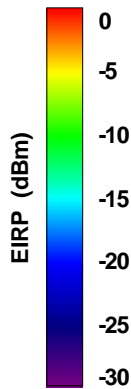
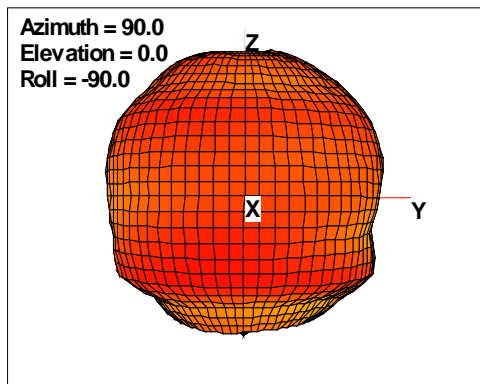

Total EIRP, Back Face View

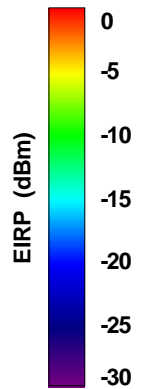
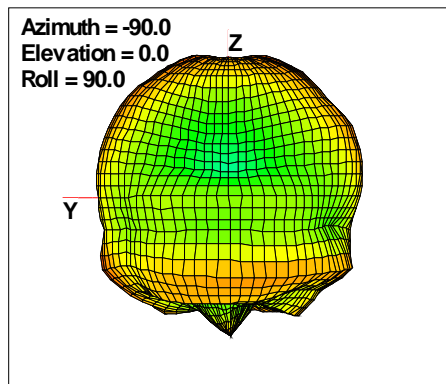

# WAN Free-Space Total EIRP, 4900MHz

Total EIRP, Right Side View

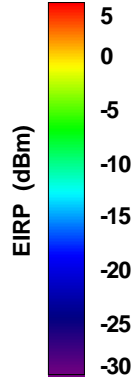
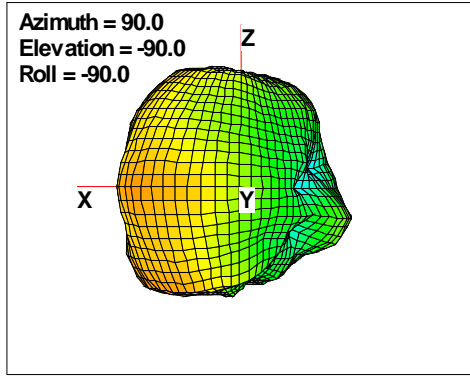

Total EIRP, Left Side View

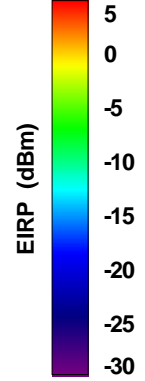
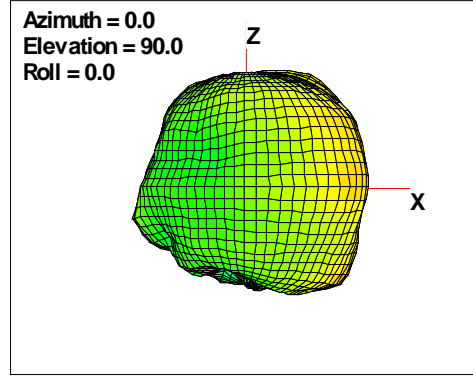

Total EIRP, Bottom View

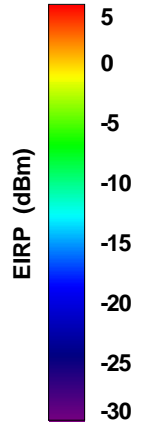
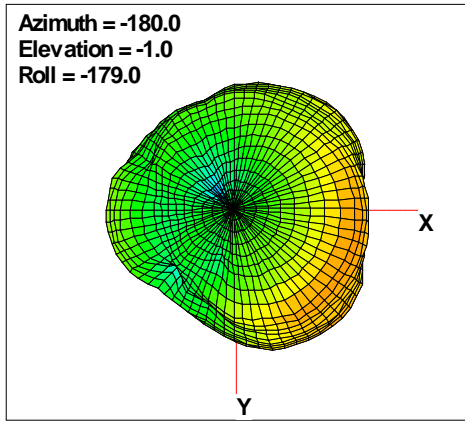

Total EIRP, Top View

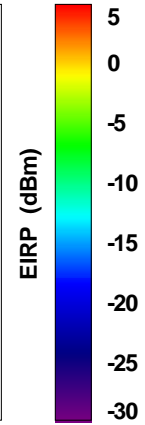
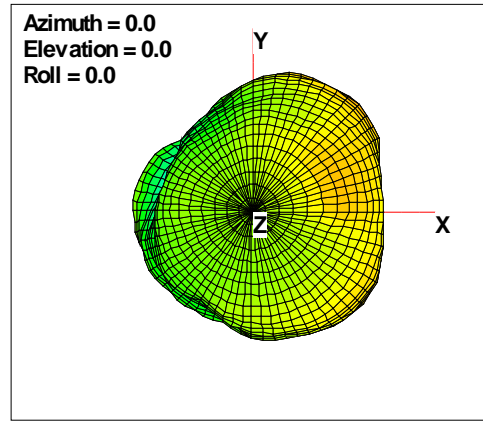

Total EIRP, Front Face View

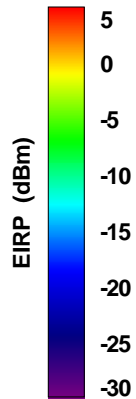
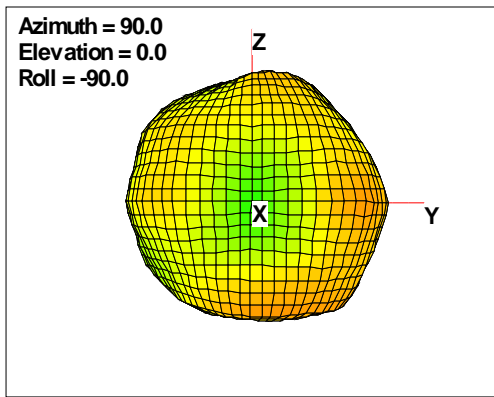

Total EIRP, Back Face View

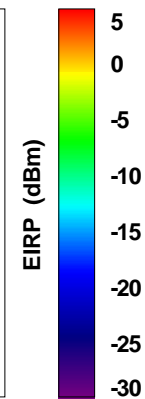
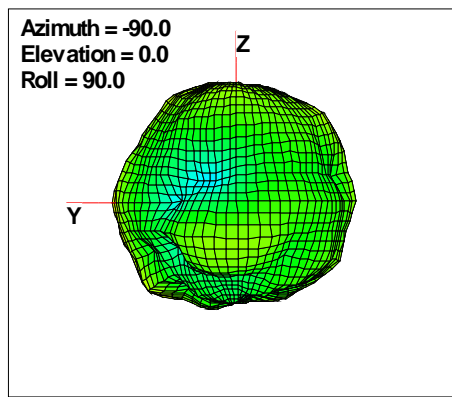

# WAN Free-Space Total EIRP, 4925MHz

### Total EIRP, Right Side View

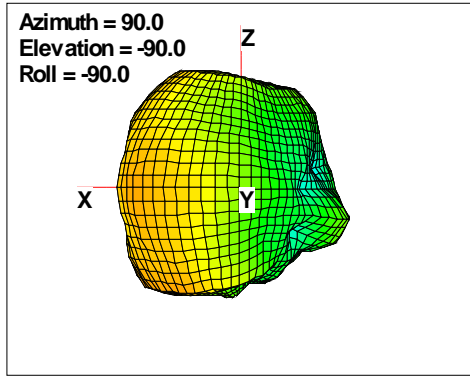

### Total EIRP, Left Side View

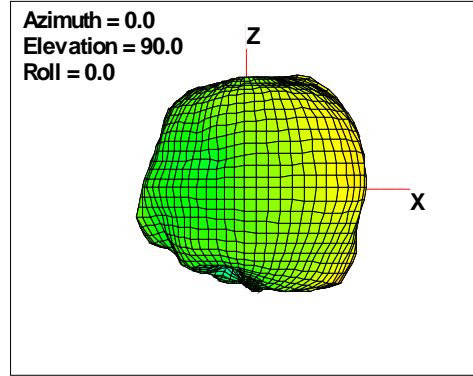

### Total EIRP, Bottom View

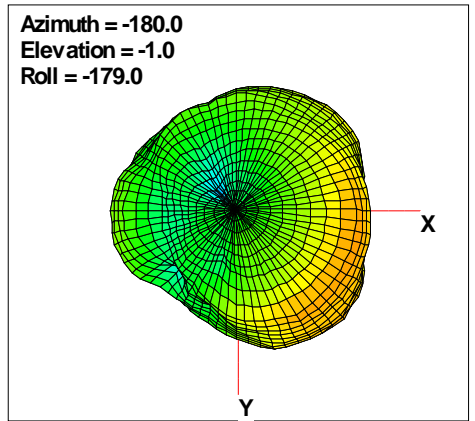

### Total EIRP, Top View

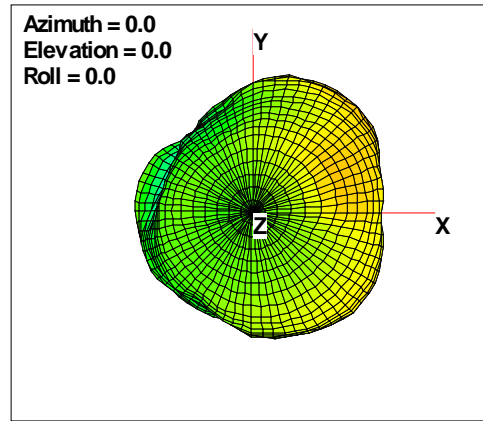

### Total EIRP, Front Face View

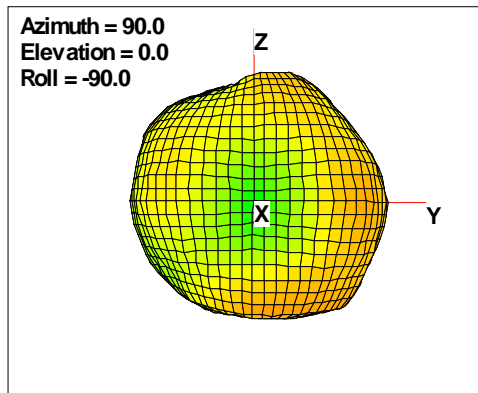

### Total EIRP, Back Face View

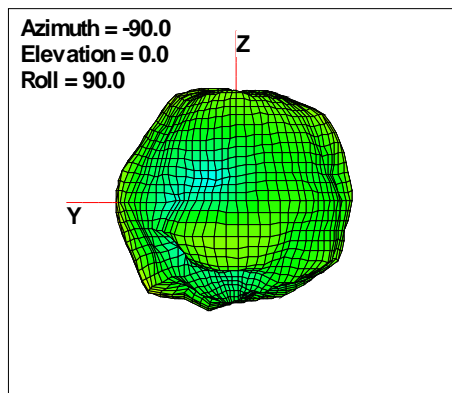

# WAN Free-Space Total EIRP, 4850MHz

### Total EIRP, Right Side View

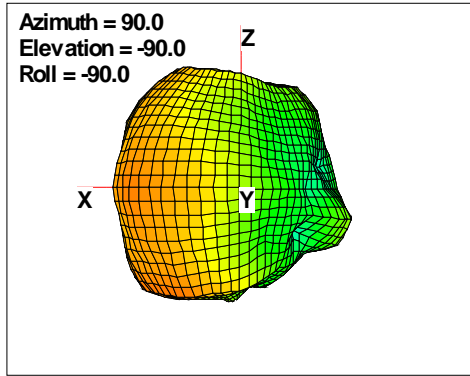

### Total EIRP, Left Side View

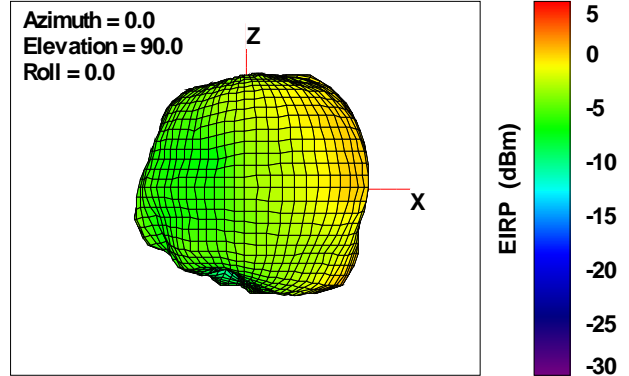

### Total EIRP, Bottom View

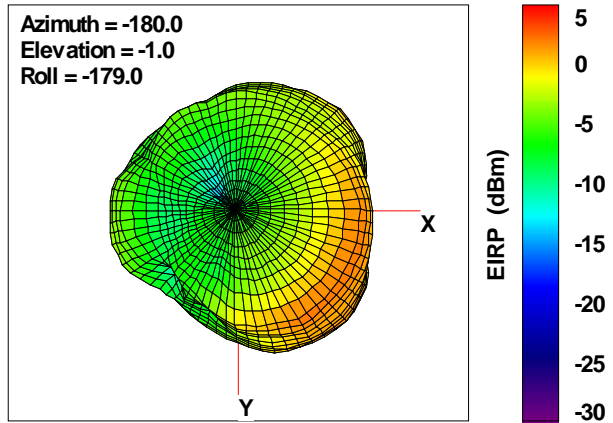

### Total EIRP, Top View

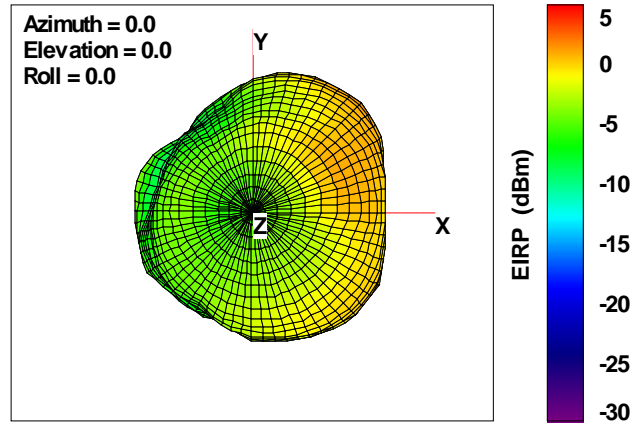

### Total EIRP, Front Face View

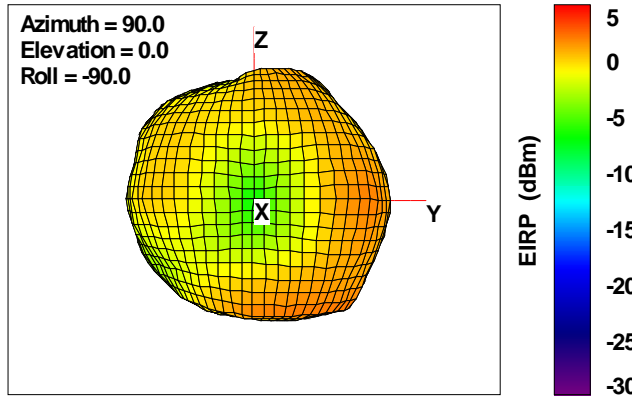

### Total EIRP, Back Face View

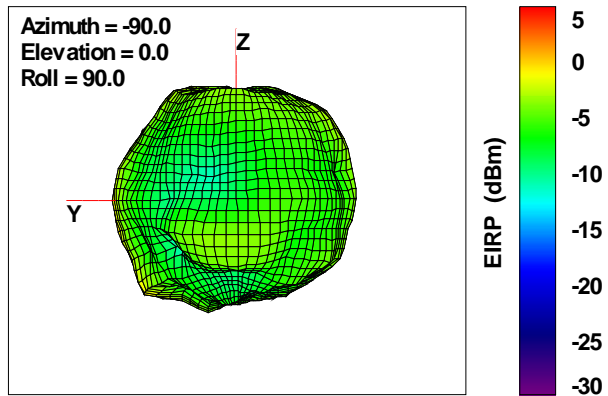

# WAN Free-Space Total EIRP, 4975MHz

### Total EIRP, Right Side View

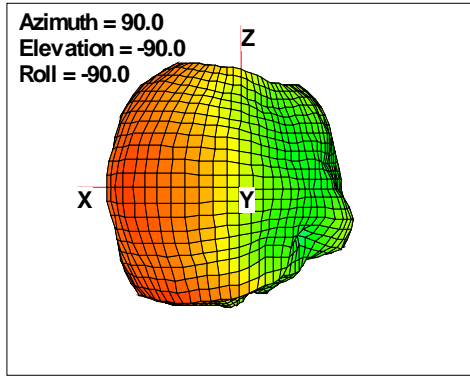

### Total EIRP, Left Side View

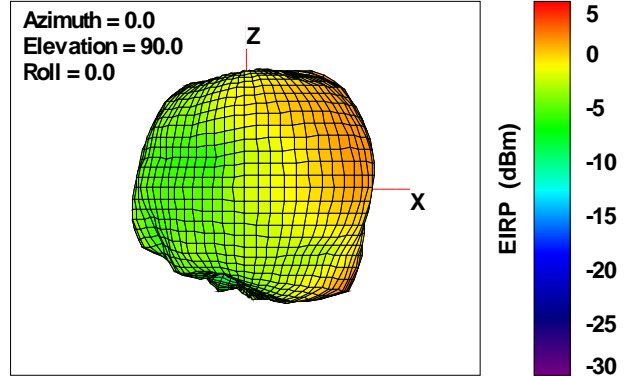

### Total EIRP, Bottom View

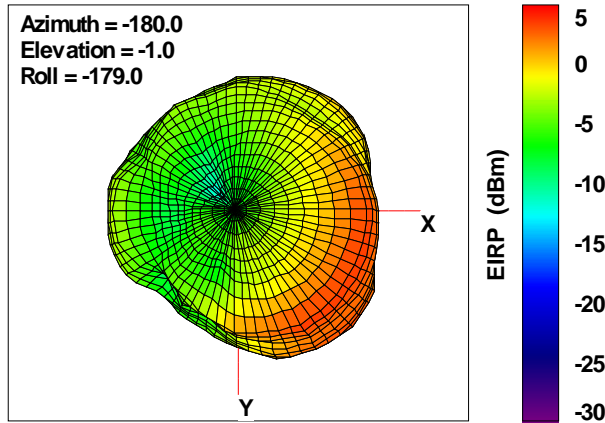

### Total EIRP, Top View

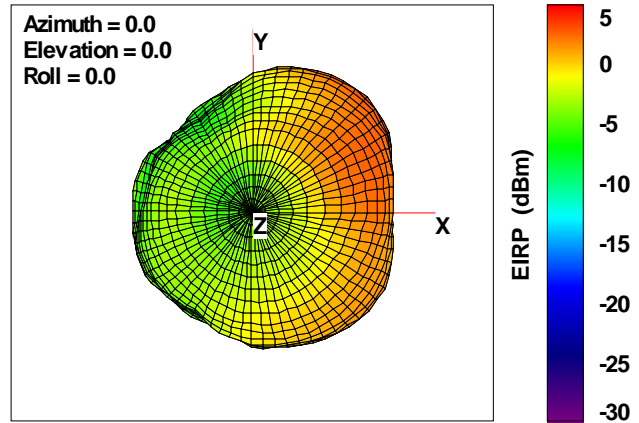

### Total EIRP, Front Face View

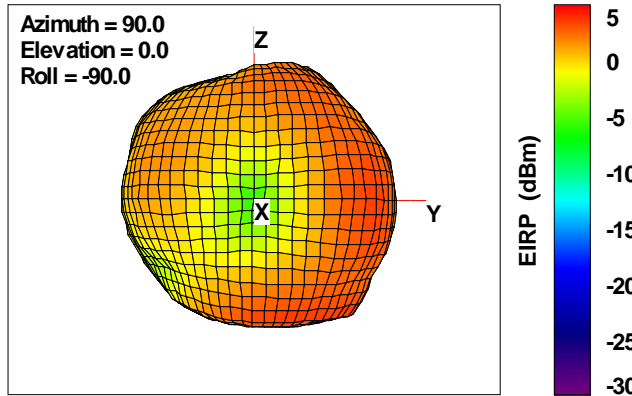

### Total EIRP, Back Face View

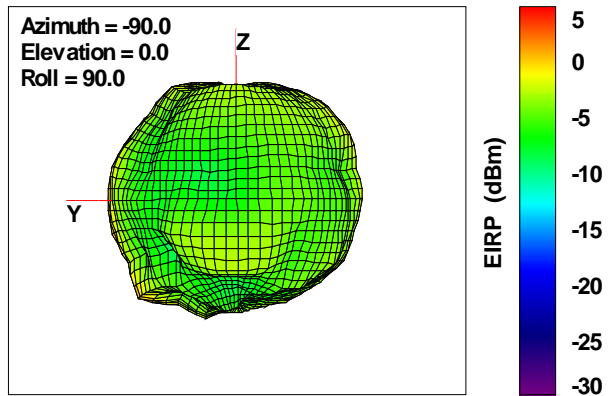

# WAN Free-Space Total EIRP, 5000 MHz

### Total EIRP, Right Side View

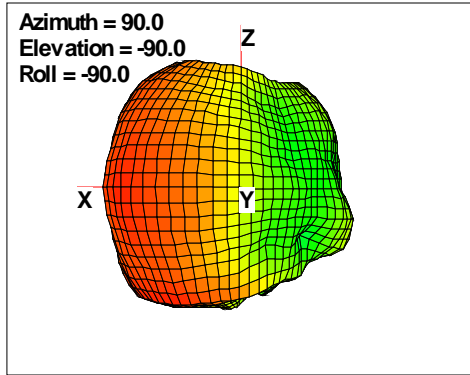

### Total EIRP, Left Side View

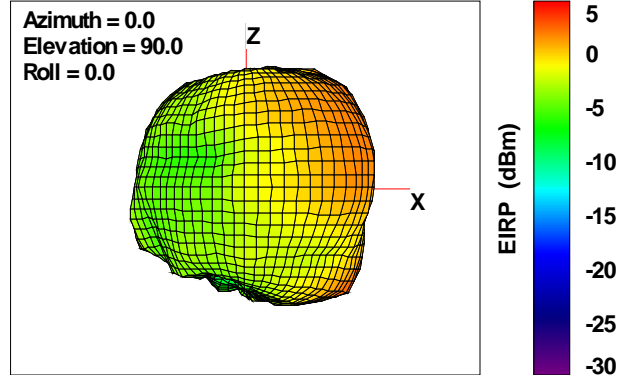

### Total EIRP, Bottom View

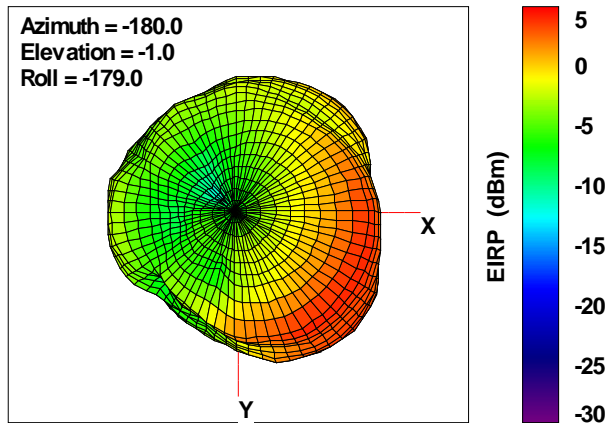

### Total EIRP, Top View

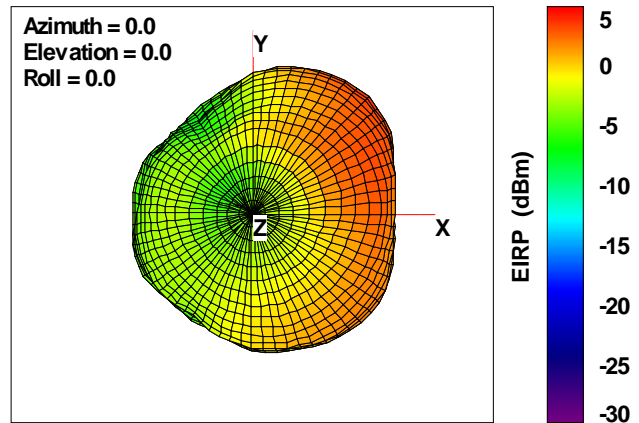

### Total EIRP, Front Face View

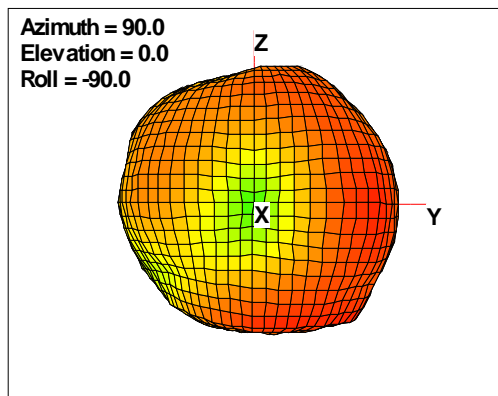

### Total EIRP, Back Face View

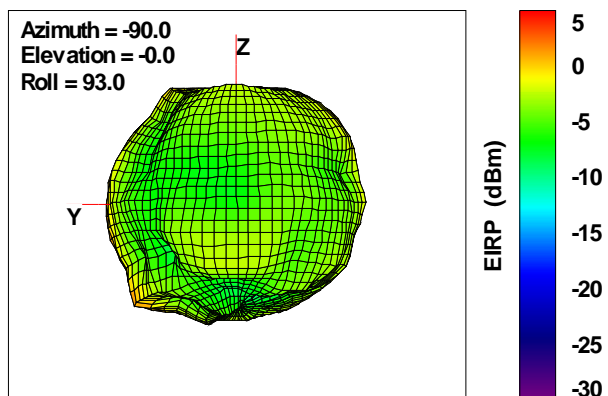



# WAN Free-Space Total EIRP, 5025MHz

### Total EIRP, Right Side View

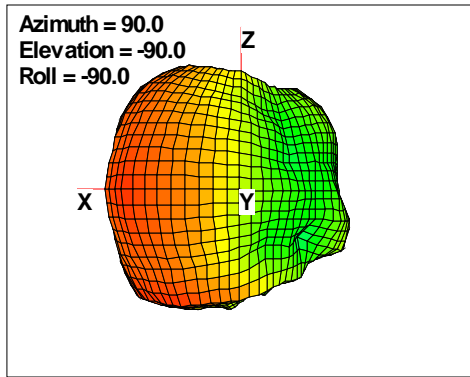

### Total EIRP, Left Side View

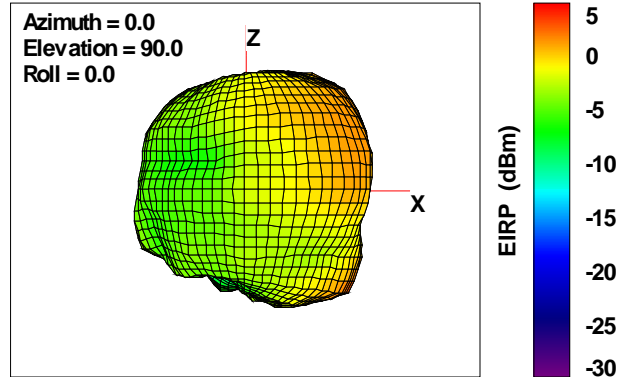

### Total EIRP, Bottom View

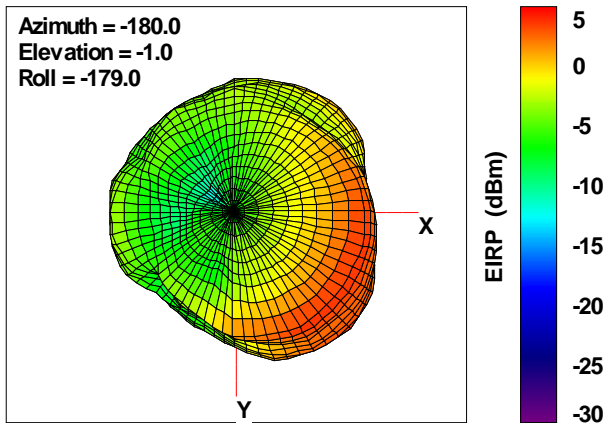

### Total EIRP, Top View

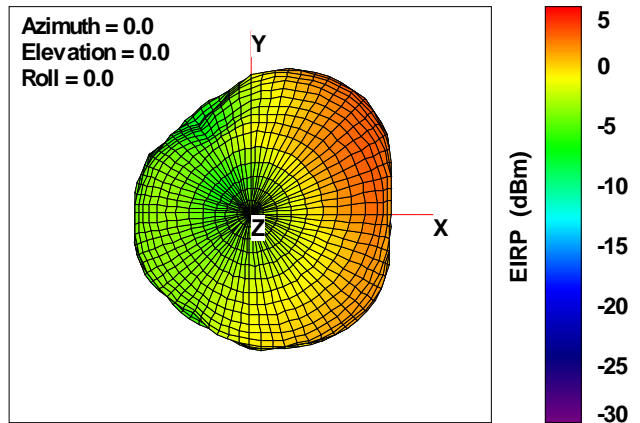

### Total EIRP, Front Face View

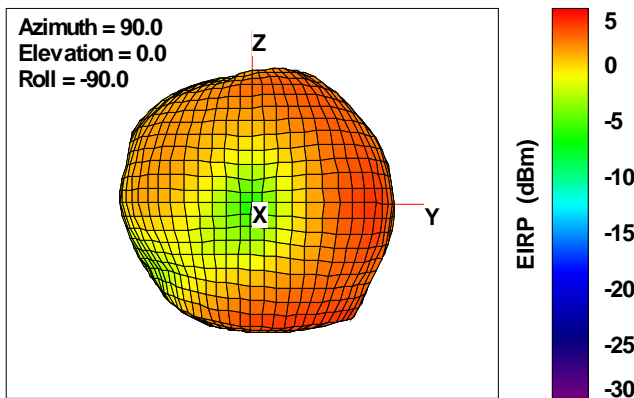

### Total EIRP, Back Face View

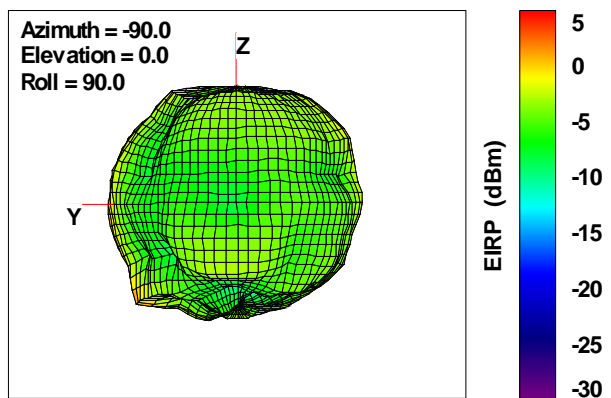

# WAN Free-Space Total EIRP, 5050MHz

### Total EIRP, Right Side View

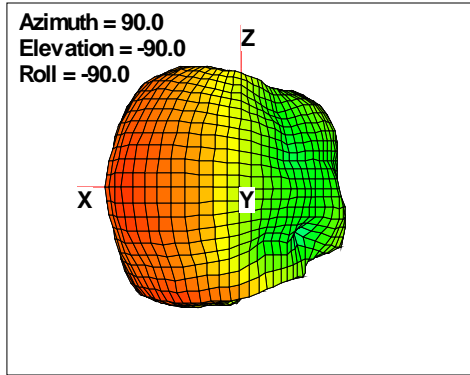

### Total EIRP, Left Side View

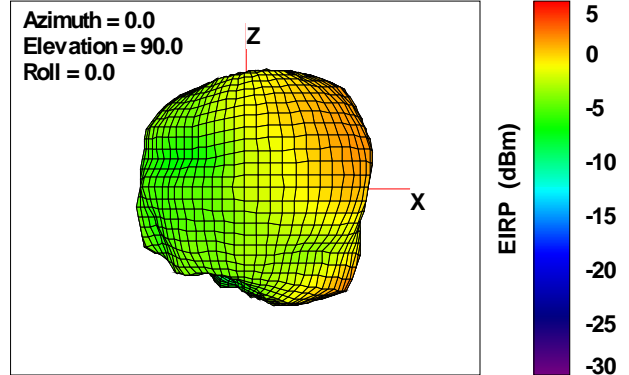

### Total EIRP, Bottom View

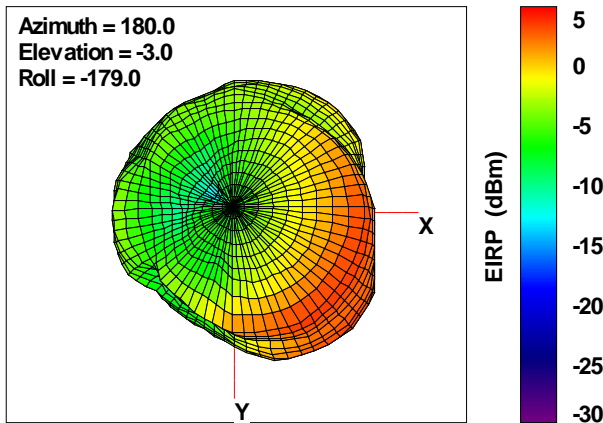

### Total EIRP, Top View

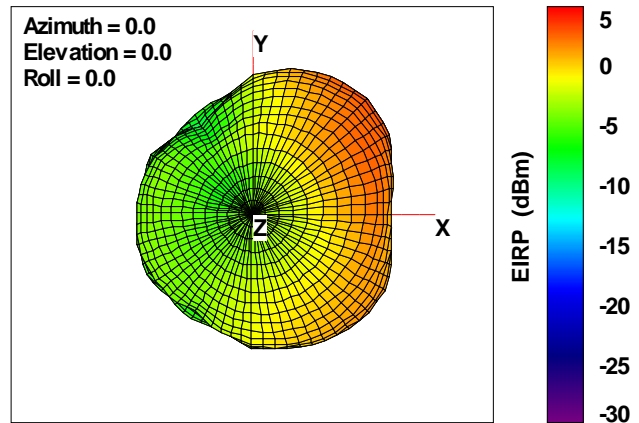

### Total EIRP, Front Face View

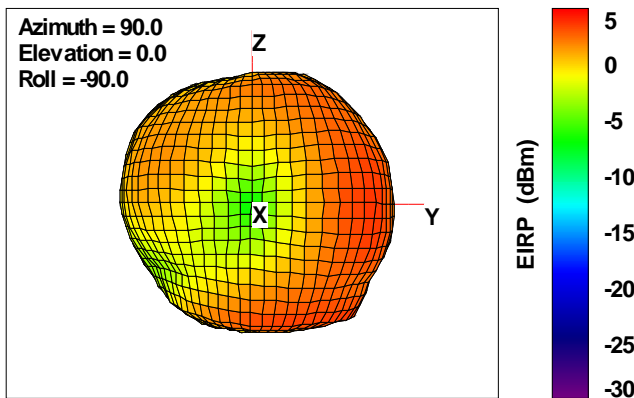

### Total EIRP, Back Face View

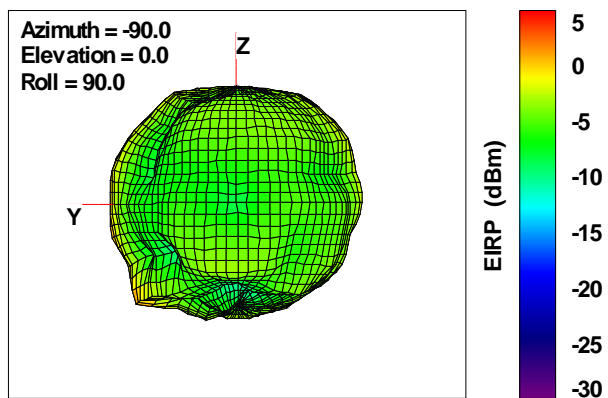

# WAN Free-Space Total EIRP, 5075MHz

### Total EIRP, Right Side View

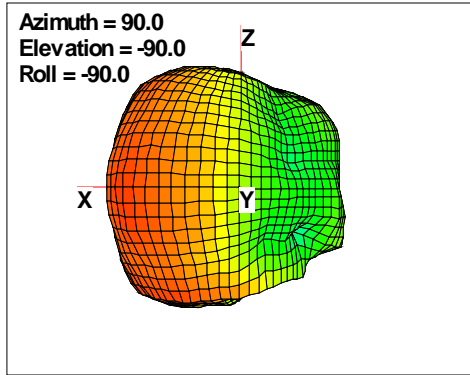

### Total EIRP, Left Side View

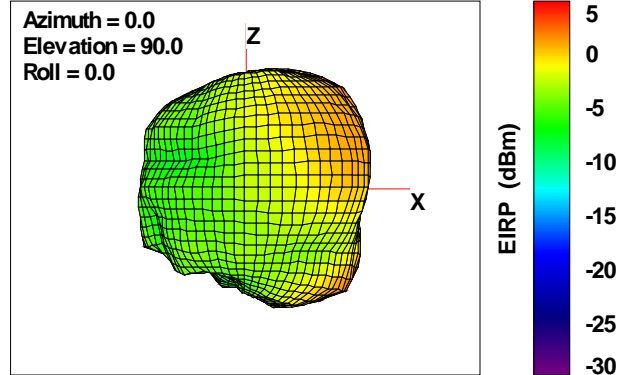

### Total EIRP, Bottom View

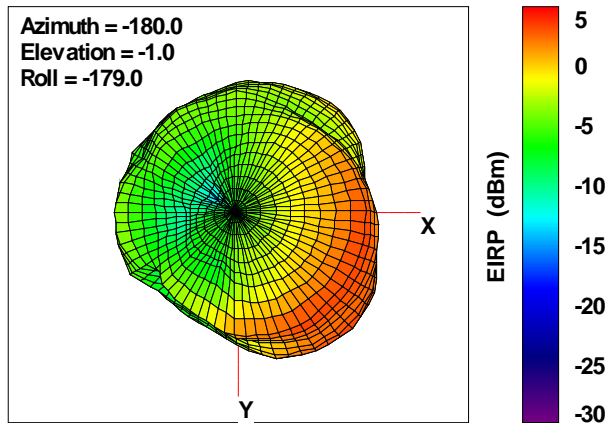

### Total EIRP, Top View

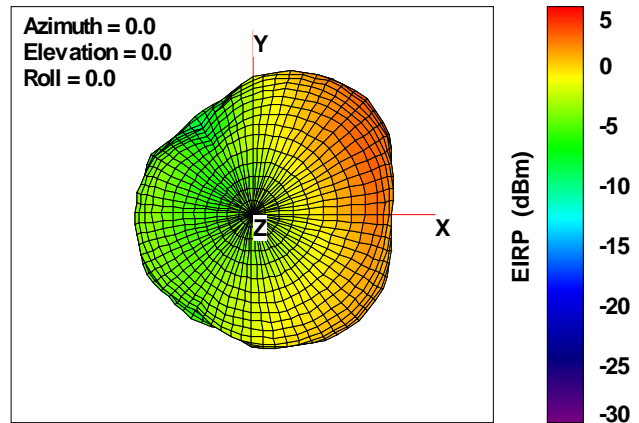

### Total EIRP, Front Face View

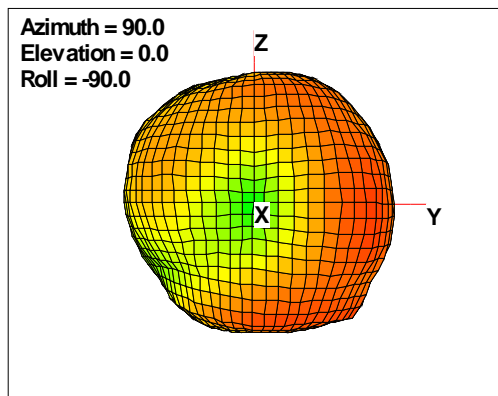

### Total EIRP, Back Face View

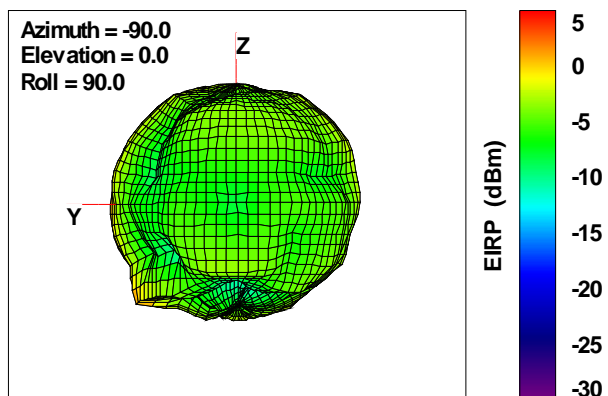

# WAN Free-Space Total EIRP, 5100MHz

### Total EIRP, Right Side View

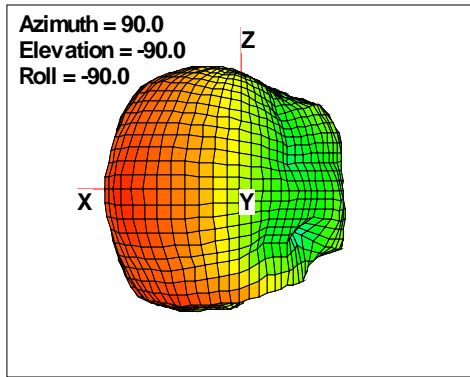

### Total EIRP, Left Side View

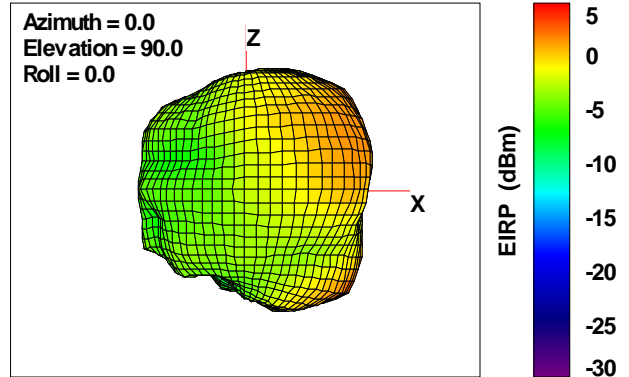

### Total EIRP, Bottom View

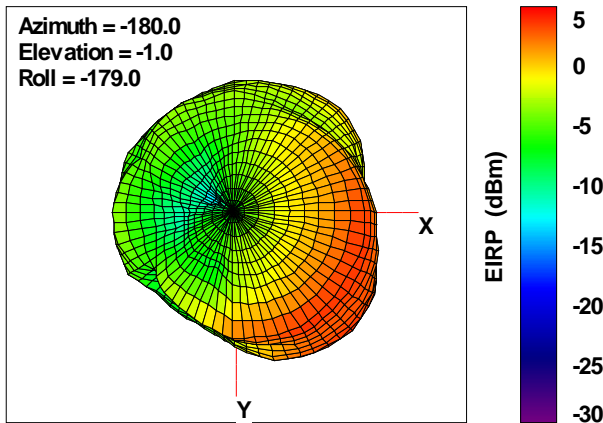

### Total EIRP, Top View

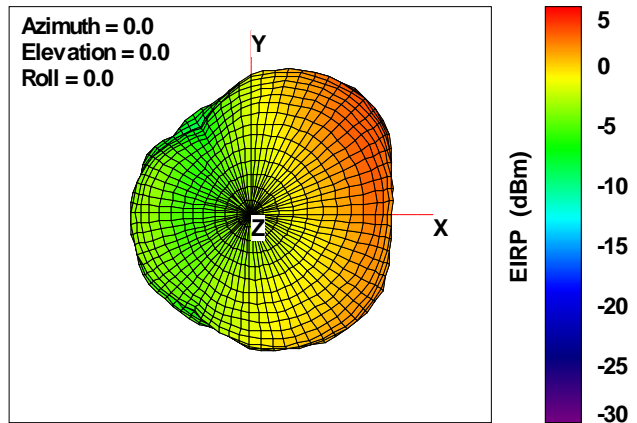

### Total EIRP, Front Face View

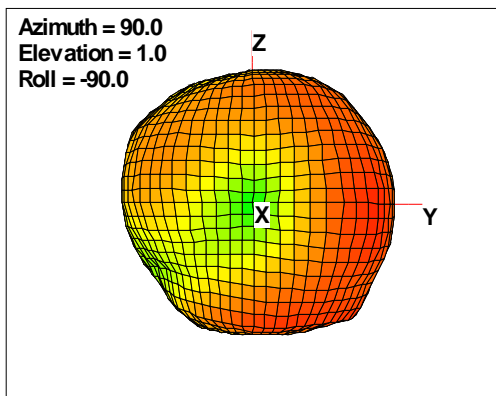

### Total EIRP, Back Face View

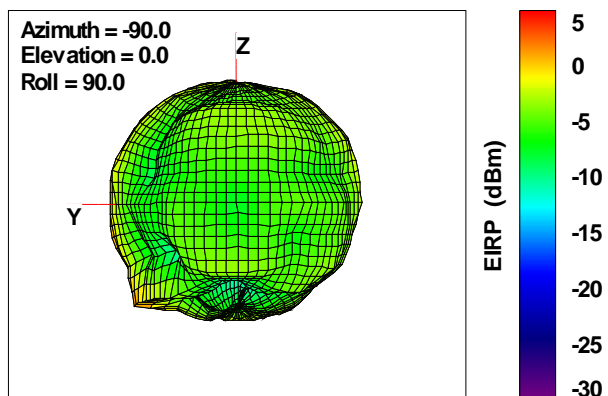

# WAN Free-Space Total EIRP, 5200MHz

### Total EIRP, Right Side View

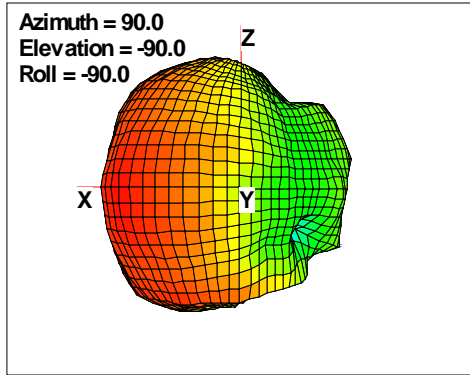

### Total EIRP, Left Side View

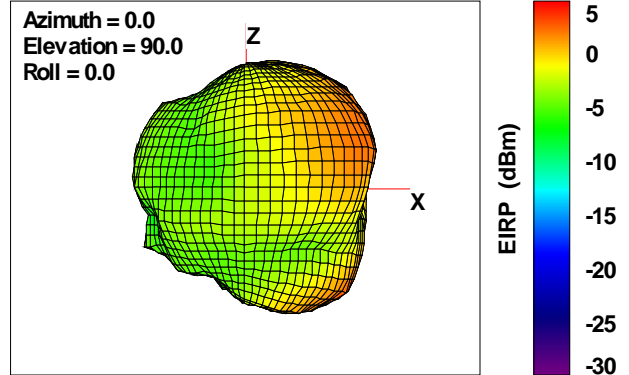

### Total EIRP, Bottom View

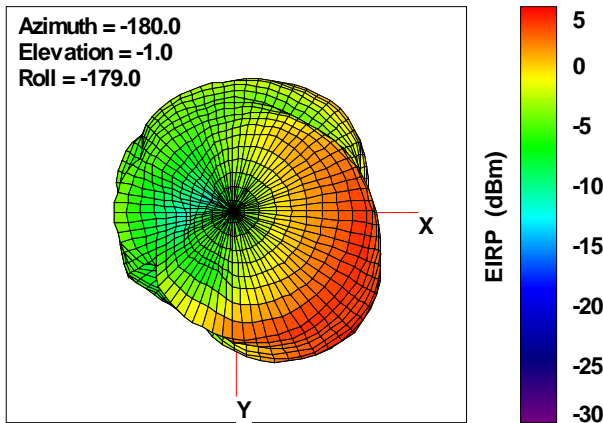

### Total EIRP, Top View

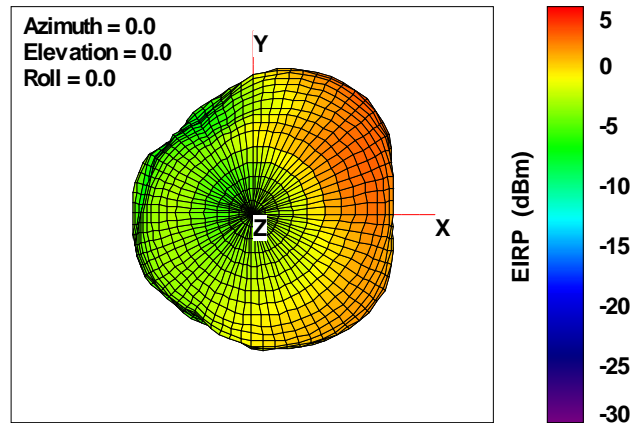

### Total EIRP, Front Face View

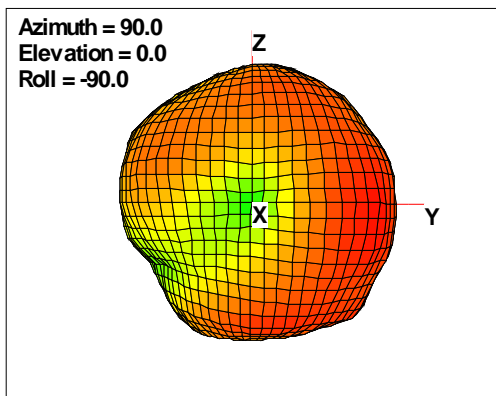

### Total EIRP, Back Face View

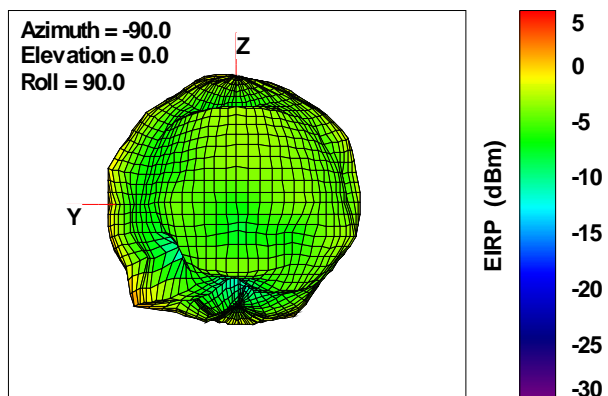

# WAN Free-Space Total EIRP, 5300MHz

### Total EIRP, Right Side View

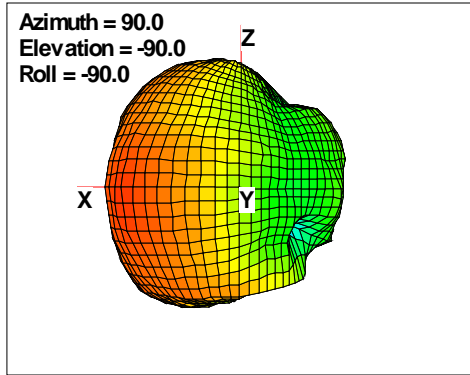

### Total EIRP, Left Side View

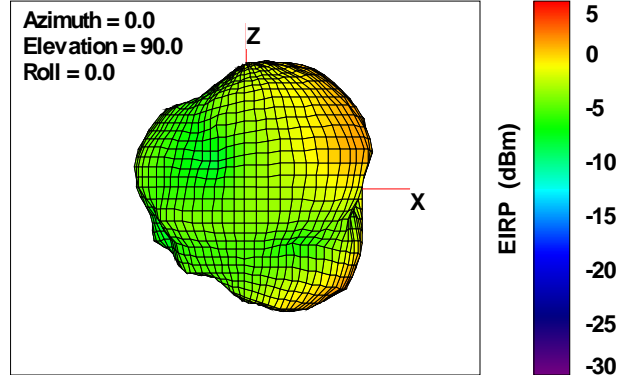

### Total EIRP, Bottom View

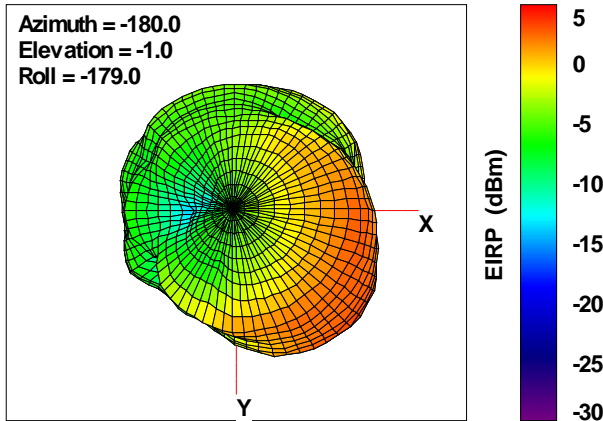

### Total EIRP, Top View

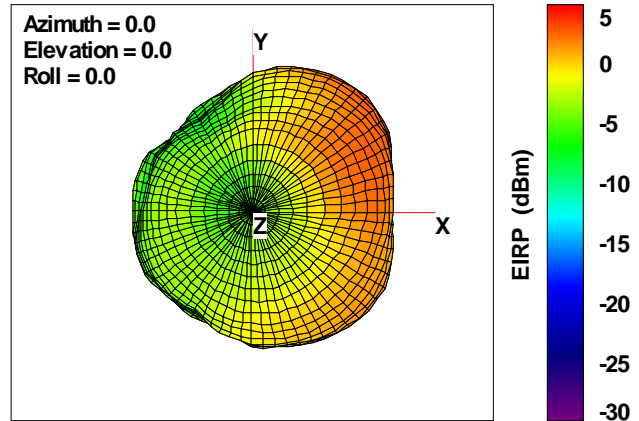

### Total EIRP, Front Face View

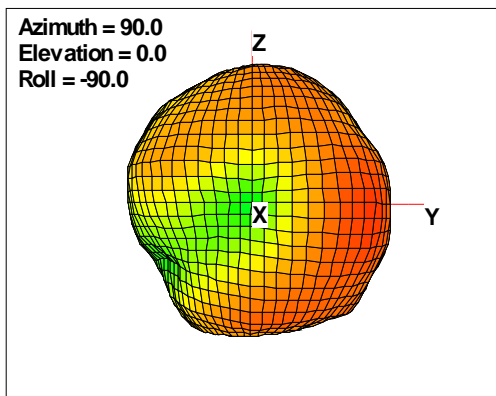

### Total EIRP, Back Face View

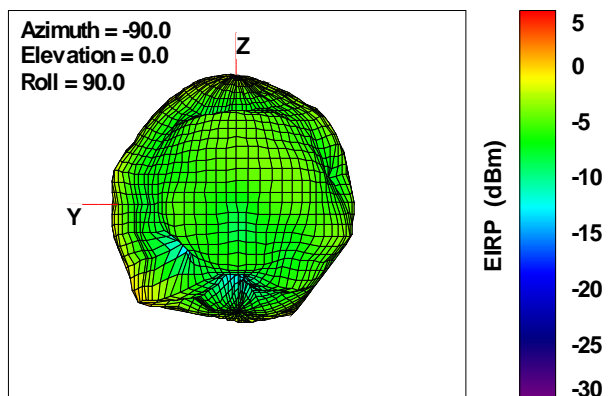

# WAN Free-Space Total EIRP, 5400MHz

### Total EIRP, Right Side View

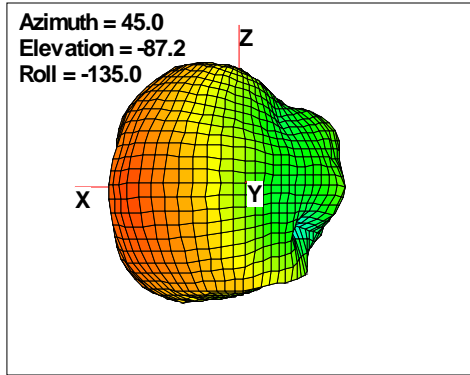

### Total EIRP, Left Side View

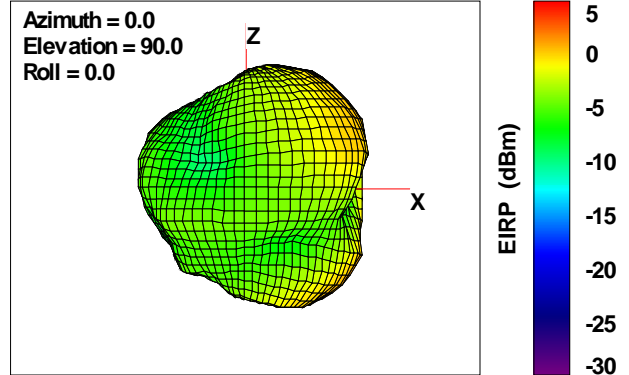

### Total EIRP, Bottom View

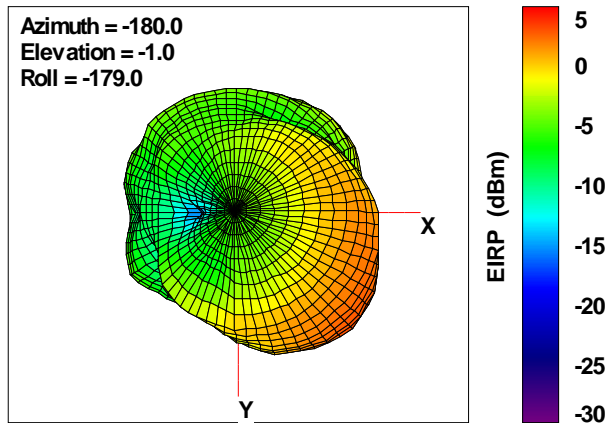

### Total EIRP, Top View

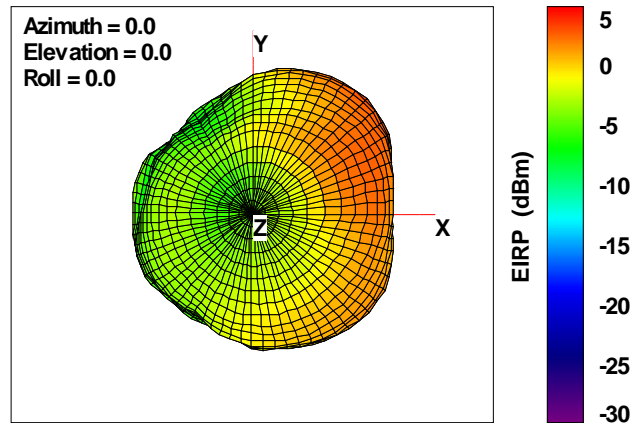

### Total EIRP, Front Face View

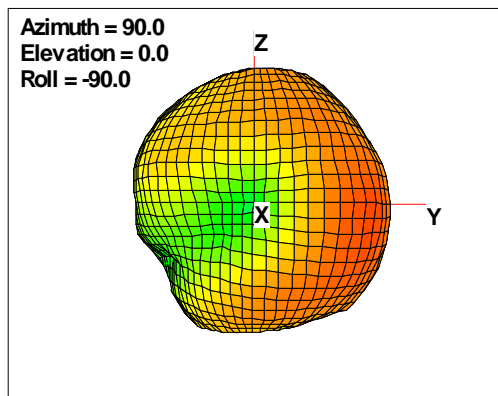

### Total EIRP, Back Face View

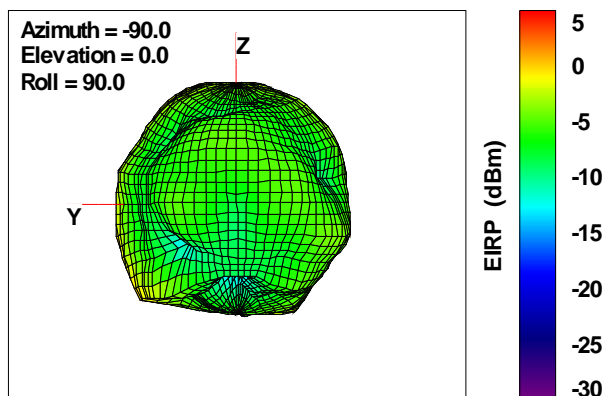

# WAN Free-Space Total EIRP, 5500MHz

### Total EIRP, Right Side View

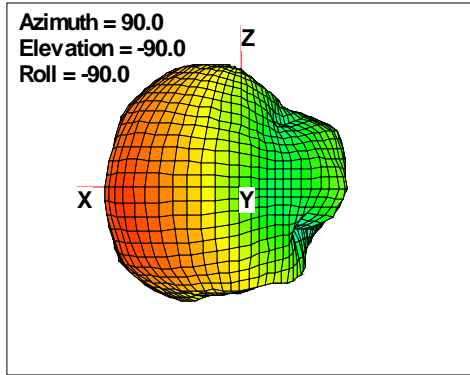

### Total EIRP, Left Side View

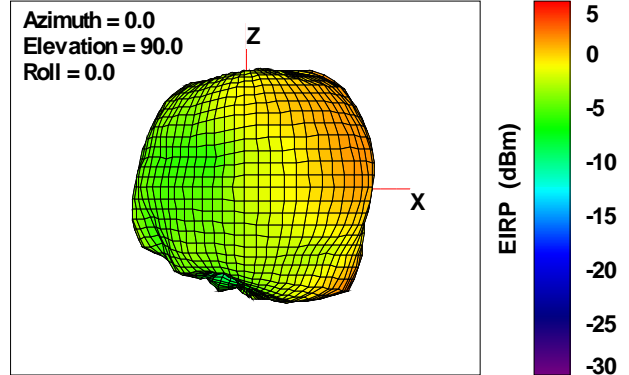

### Total EIRP, Bottom View

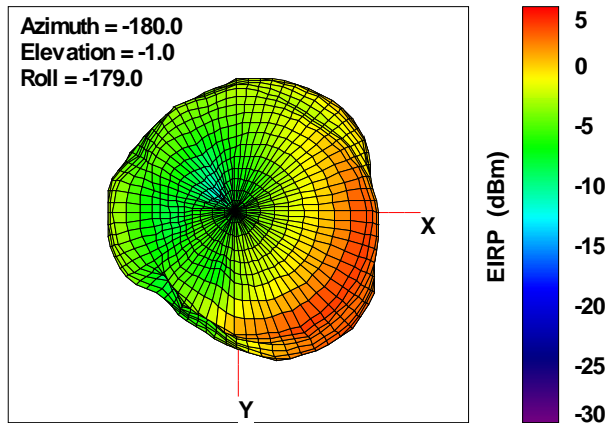

### Total EIRP, Top View

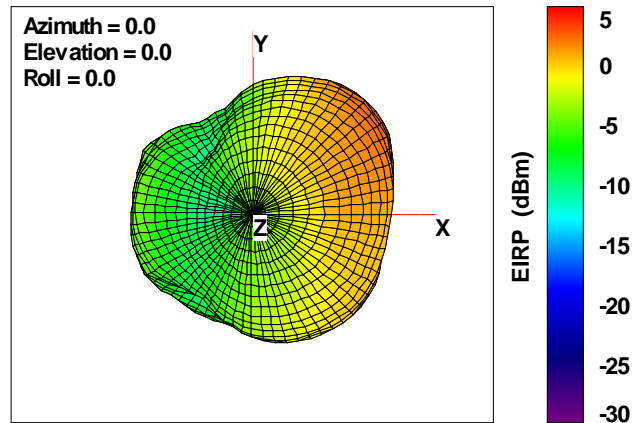

### Total EIRP, Front Face View

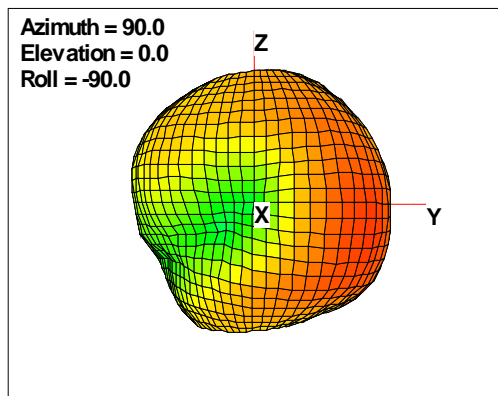

### Total EIRP, Back Face View

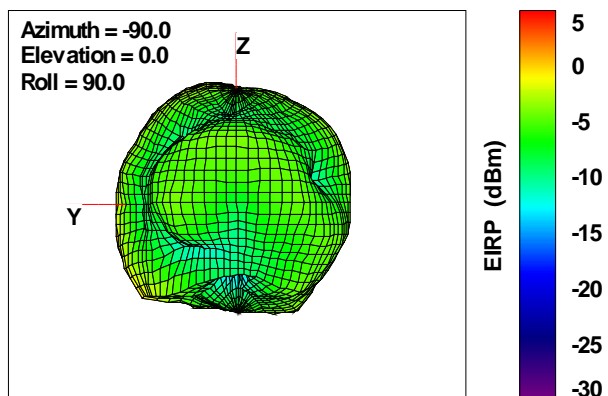



# WAN Free-Space Total EIRP, 5600MHz

### Total EIRP, Right Side View

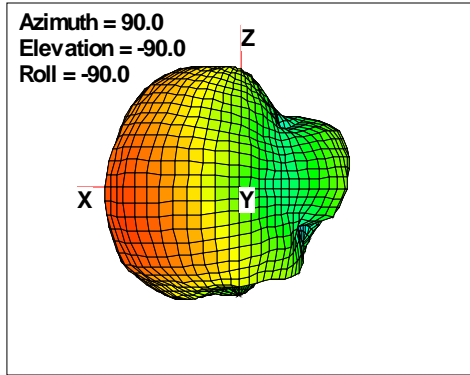

### Total EIRP, Left Side View

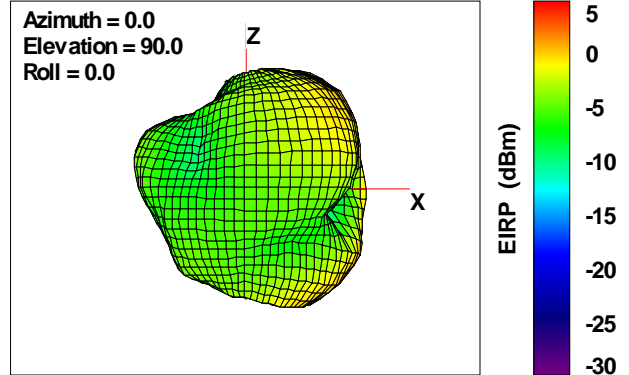

### Total EIRP, Bottom View

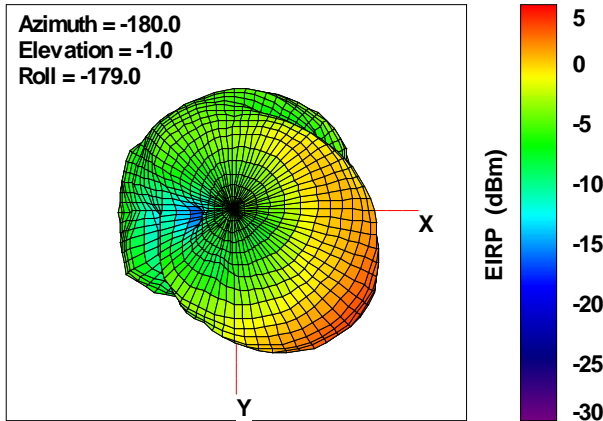

### Total EIRP, Top View

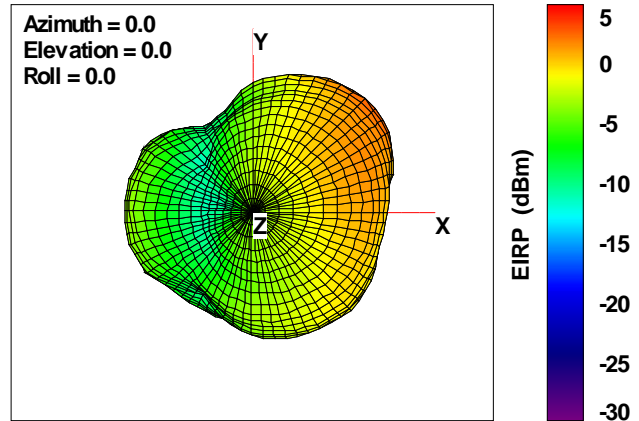

### Total EIRP, Front Face View

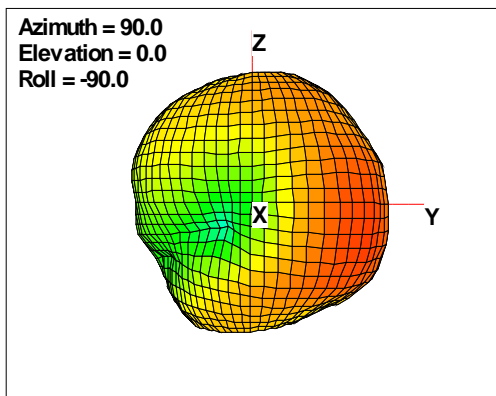

### Total EIRP, Back Face View

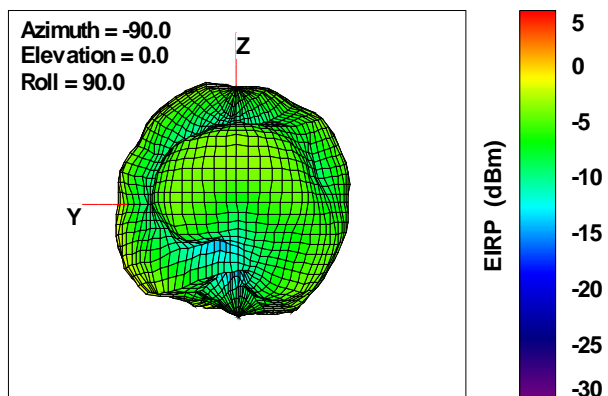

# WAN Free-Space Total EIRP, 5700MHz

### Total EIRP, Right Side View

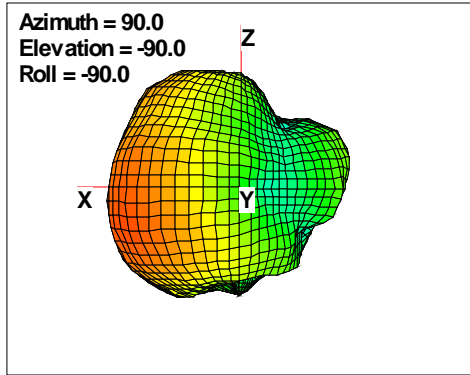

### Total EIRP, Left Side View

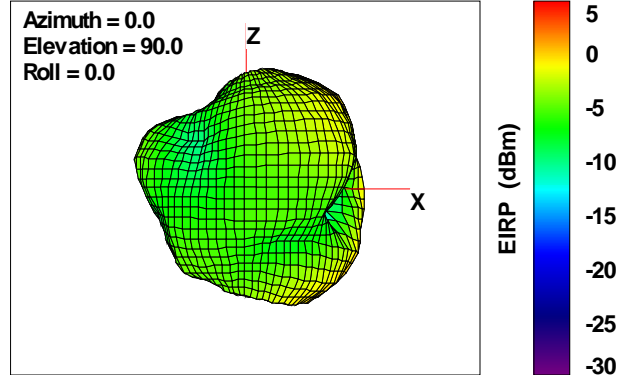

### Total EIRP, Bottom View

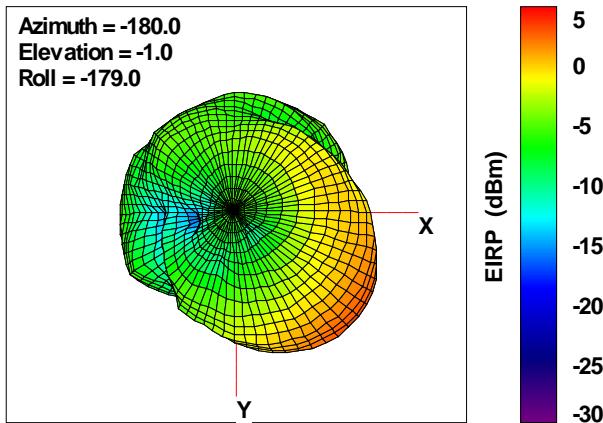

### Total EIRP, Top View

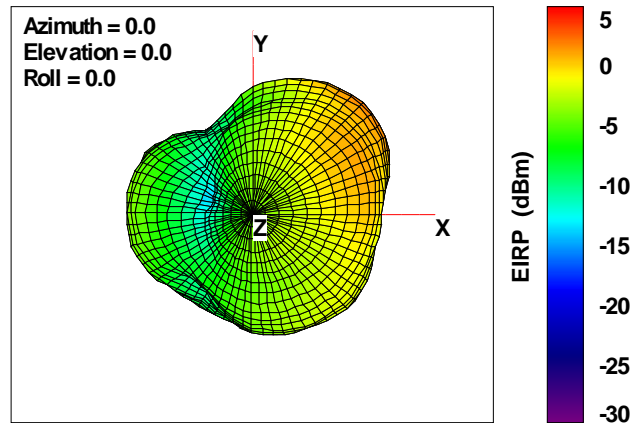

### Total EIRP, Front Face View

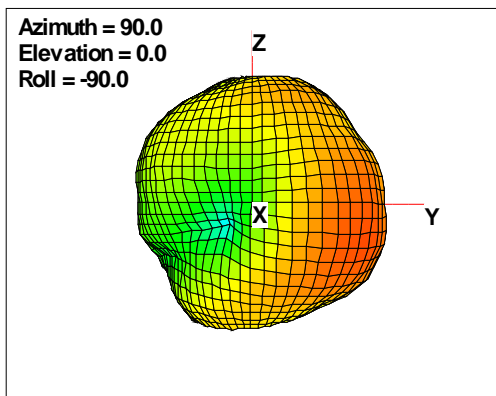

### Total EIRP, Back Face View

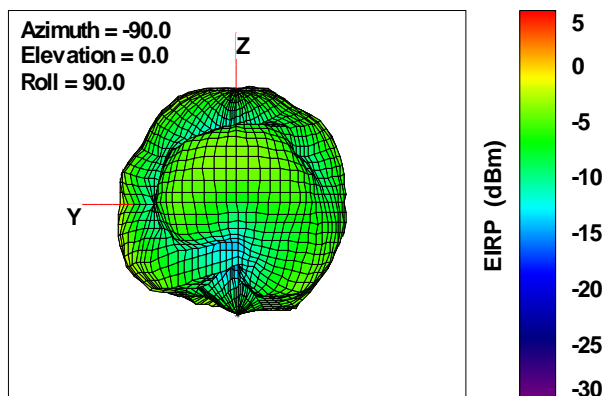

# WAN Free-Space Total EIRP, 5825MHz

### Total EIRP, Right Side View

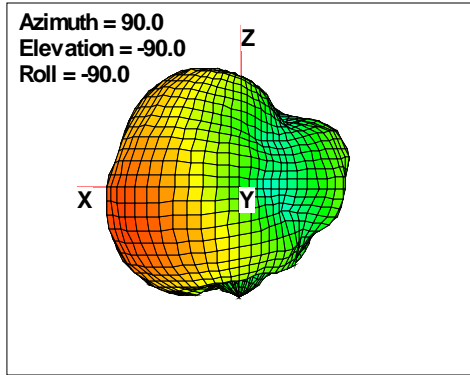

### Total EIRP, Left Side View

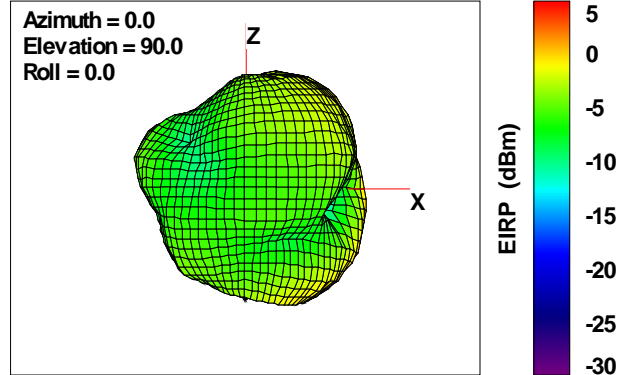

### Total EIRP, Bottom View

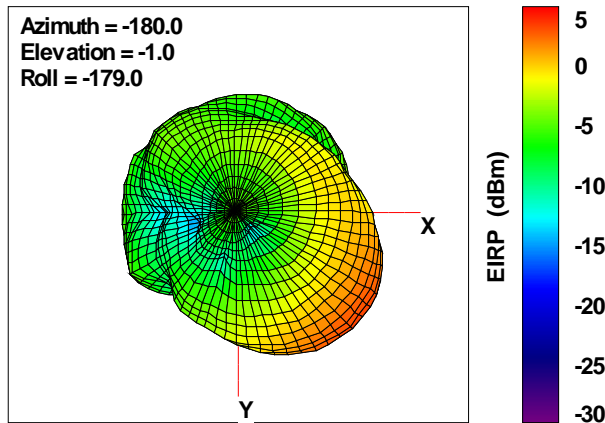

### Total EIRP, Top View

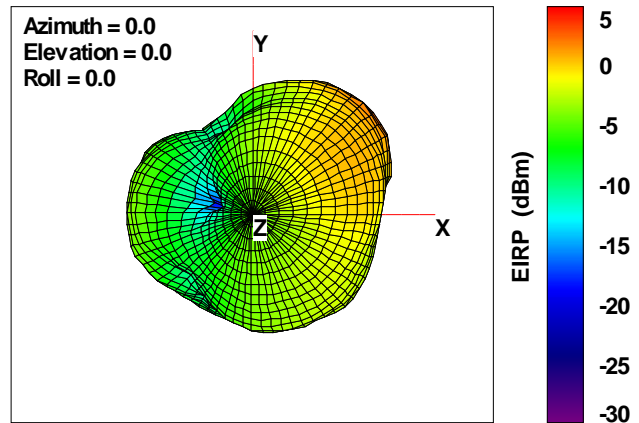

### Total EIRP, Front Face View

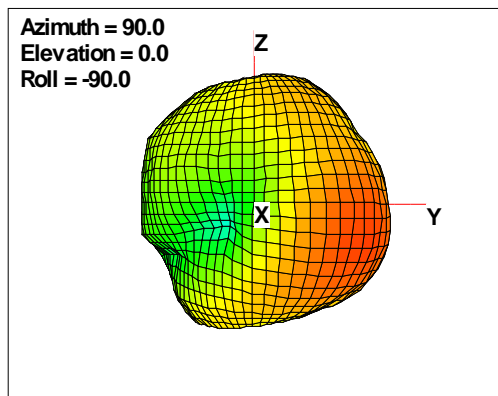

### Total EIRP, Back Face View

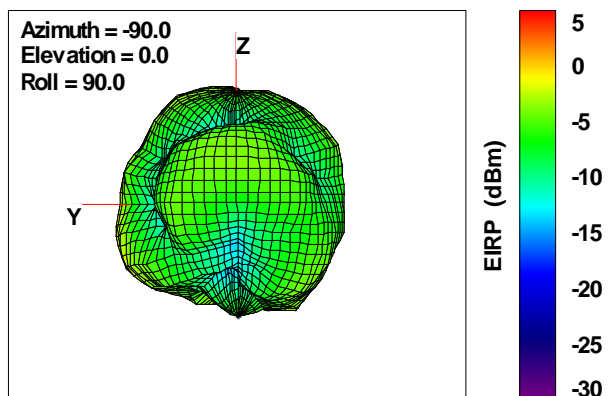

# WAN Free-Space Total EIRP, 5900MHz

### Total EIRP, Right Side View

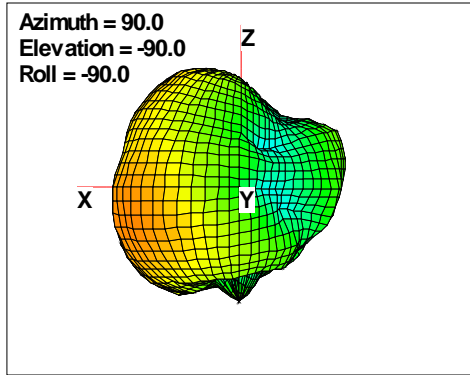

### Total EIRP, Left Side View

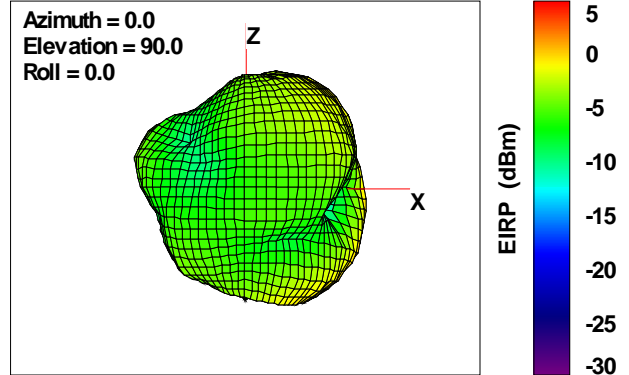

### Total EIRP, Bottom View

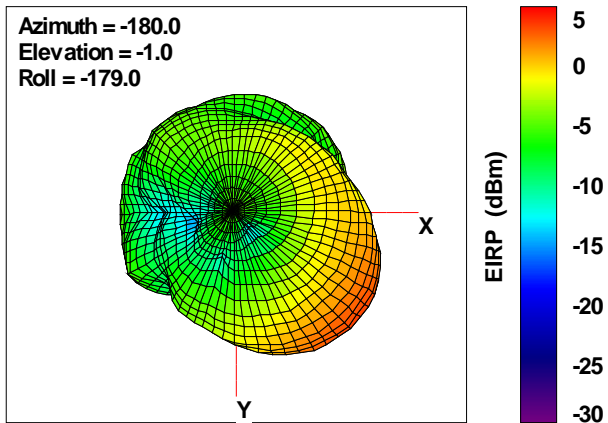

### Total EIRP, Top View

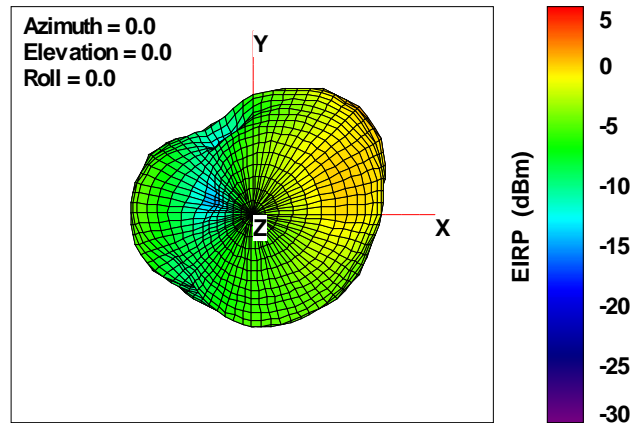

### Total EIRP, Front Face View

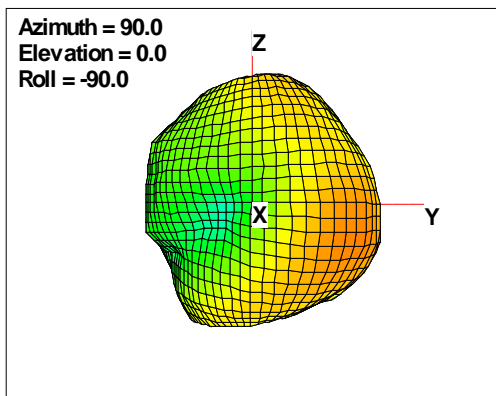

### Total EIRP, Back Face View

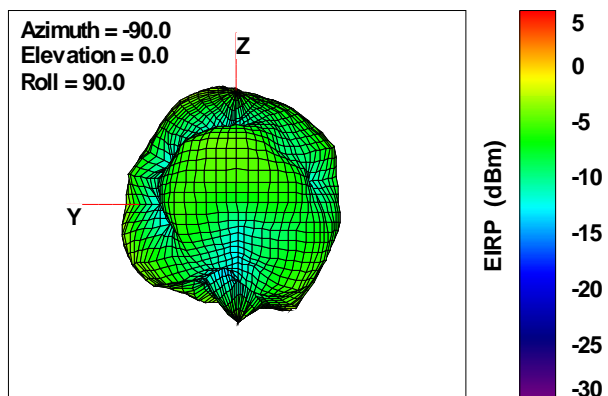

# WAN Free-Space Total EIRP, 6000MHz

### Total EIRP, Right Side View

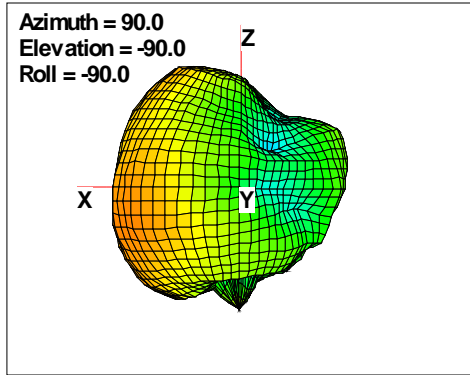

### Total EIRP, Left Side View

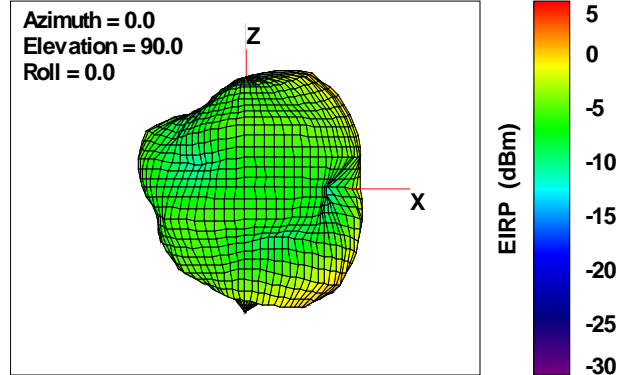

### Total EIRP, Bottom View

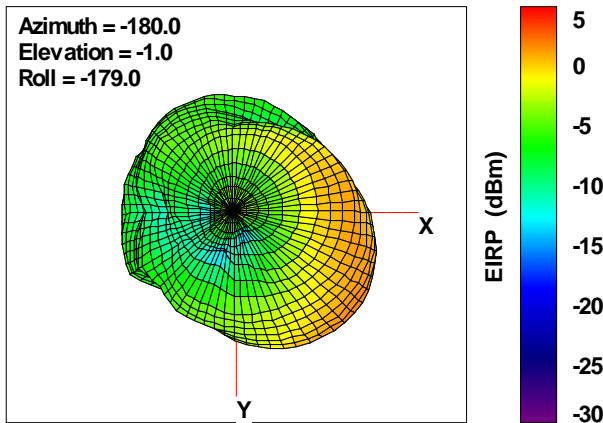

### Total EIRP, Top View

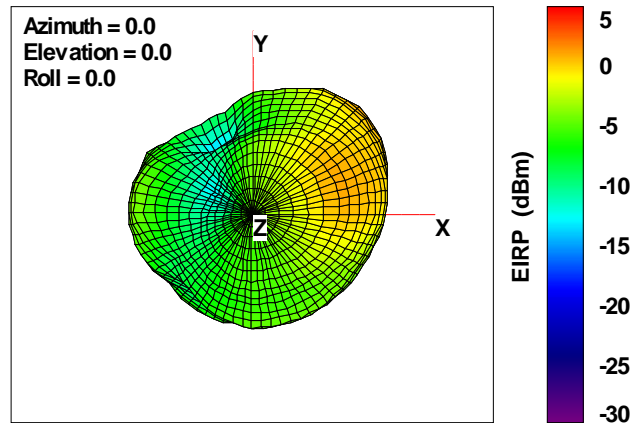

### Total EIRP, Front Face View

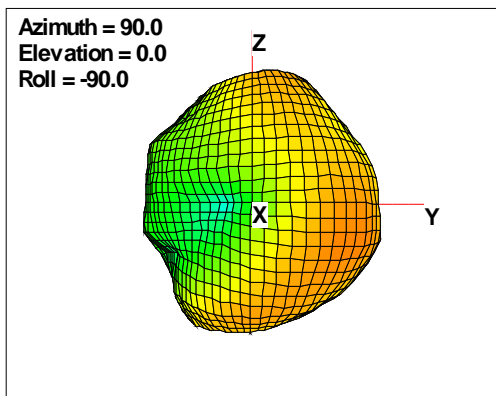

### Total EIRP, Back Face View

