



CK3 Wi-Fi / BT Antenna Report

May 19 2008 Intermec Radio Integration Group



CK3 Antenna Report 802.11 a/b/g

Main 05/19/2008 Intermec Radio Integration Team

Pattern data covers the following frequencies in MHz: 2400, 2450, 2500, 4900, 5000, 5100, 5150, 5250, 5350, 5470, 5600, 5725, 5775, 5825



Technologies Corporation

Gain, Radiation Patterns for WLAN Main Antenna Intermec Technologies Model CK3

Background:

- 1. All measurements were taken using CK3 production unit with the CK3 engineering fixture.**
- 2. Return loss and VSWR are measured using Agilent Technologies E5071B network analyzer.**
- 3. Peak gain, average gain and radiation patterns in the 3 principle planes are measured with SATIMO 3D 64 STARGATE anechoic chamber.**
- 4. Data Supplied by Laird Technologies.**

Antenna:

Manufacturer: Laird Technologies

Antenna Type: Main, 802.11 a/b/g, Internal PIFA

Coordinate System for the Measurements of WLAN Main Antenna

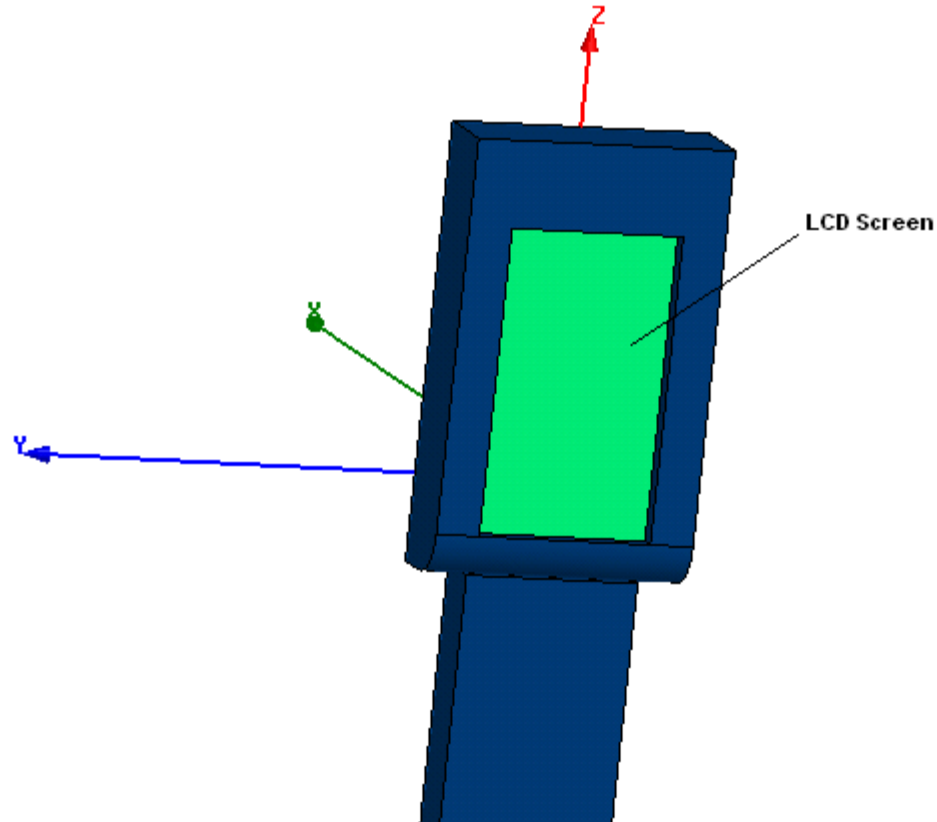

LCD screen is facing the negative X direction

Measured Return Loss for WLAN Main Antenna

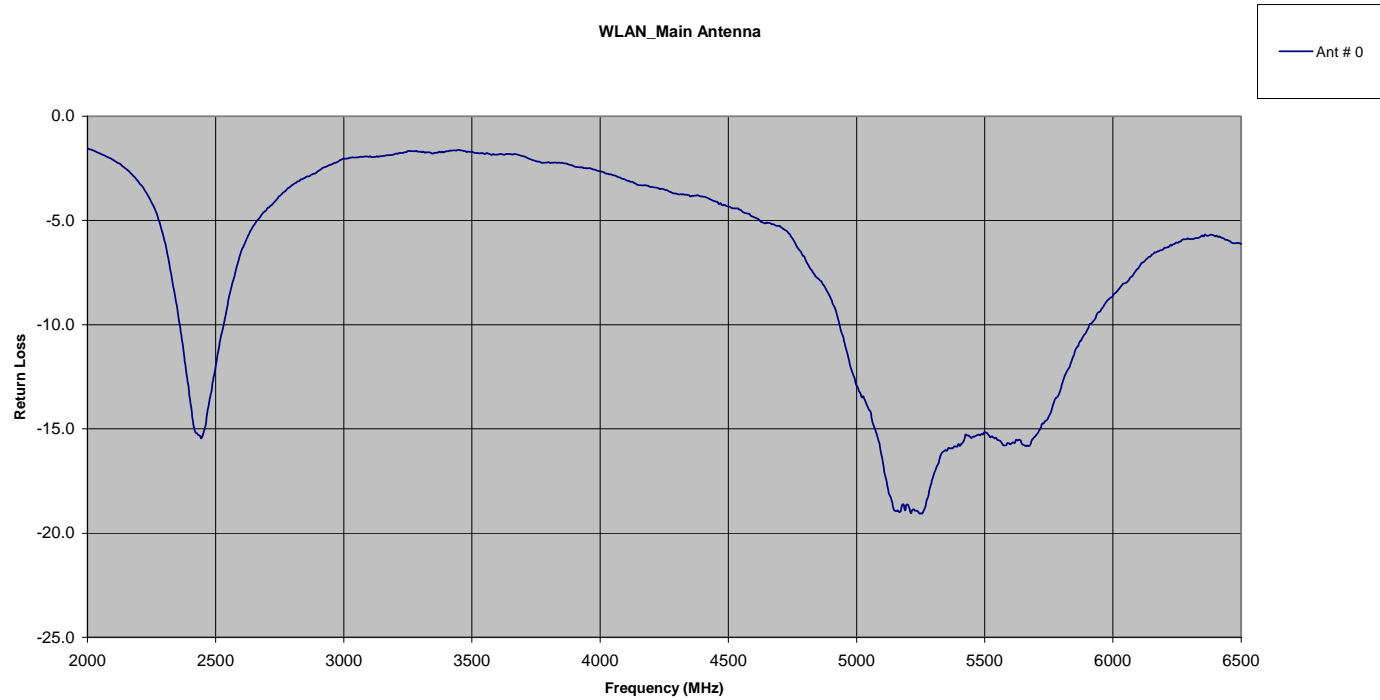

Measured VSWR for WLAN Main Antenna

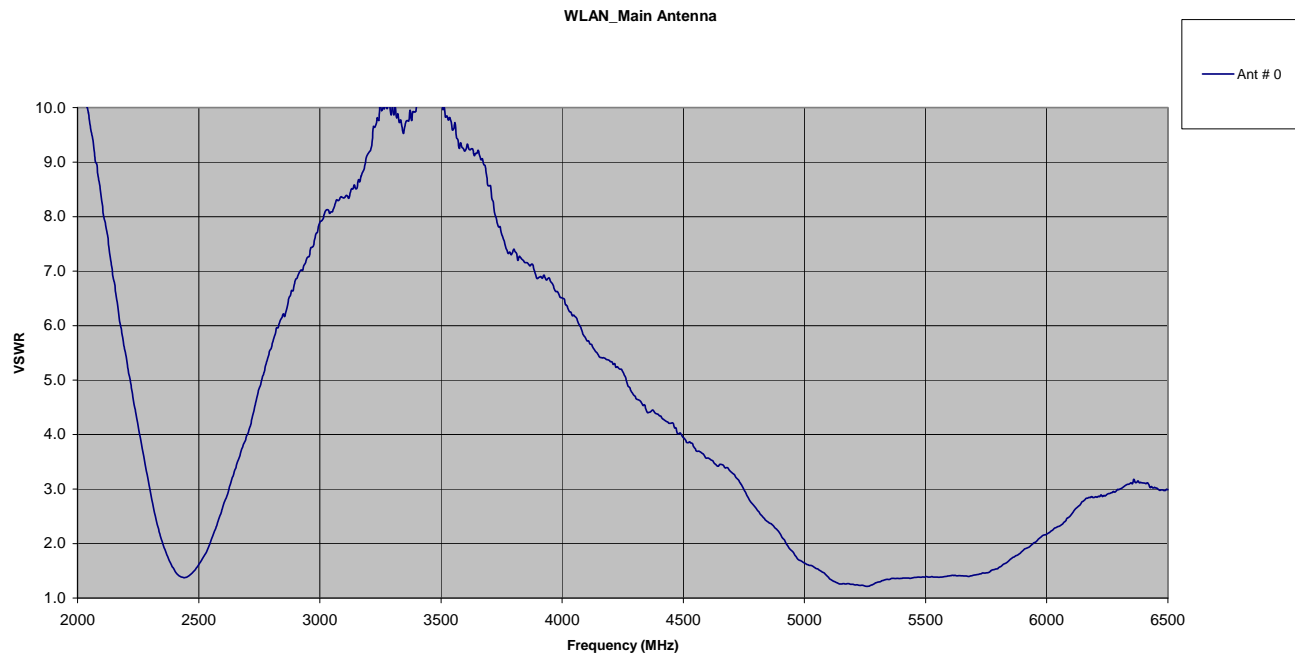

Snap Shot of Measured VSWR for WLAN Main Antenna

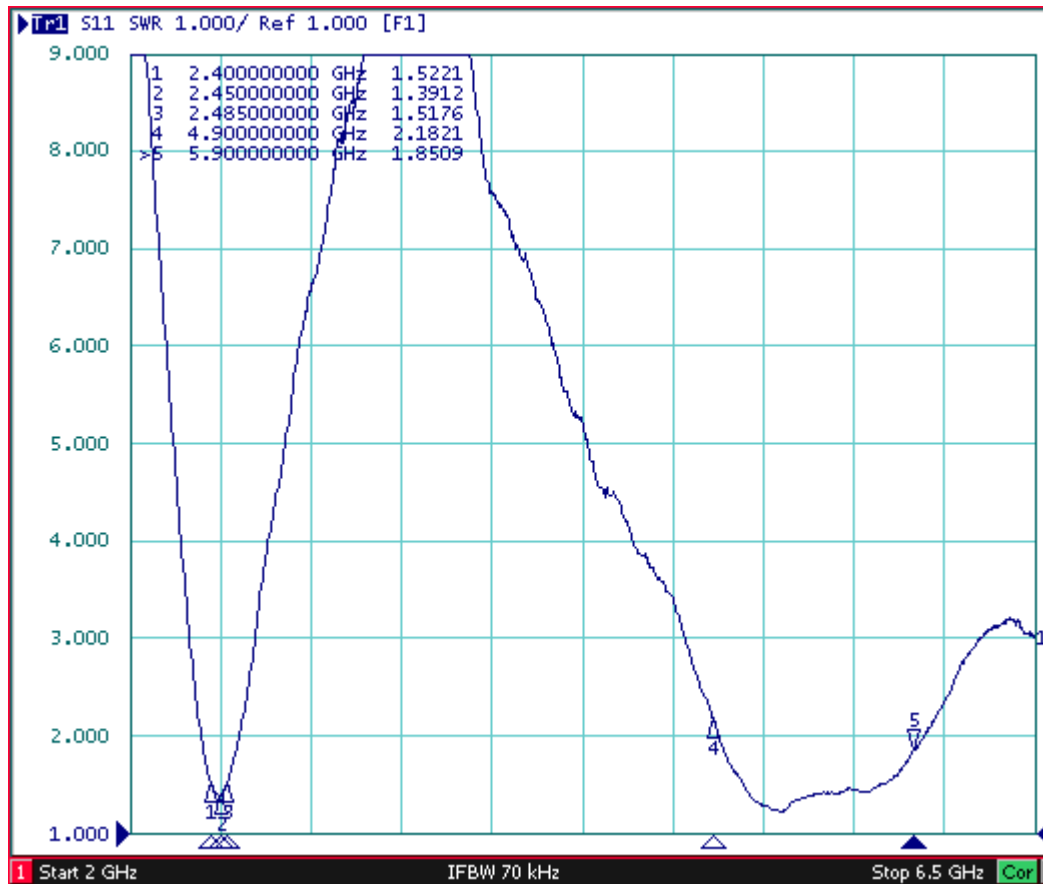

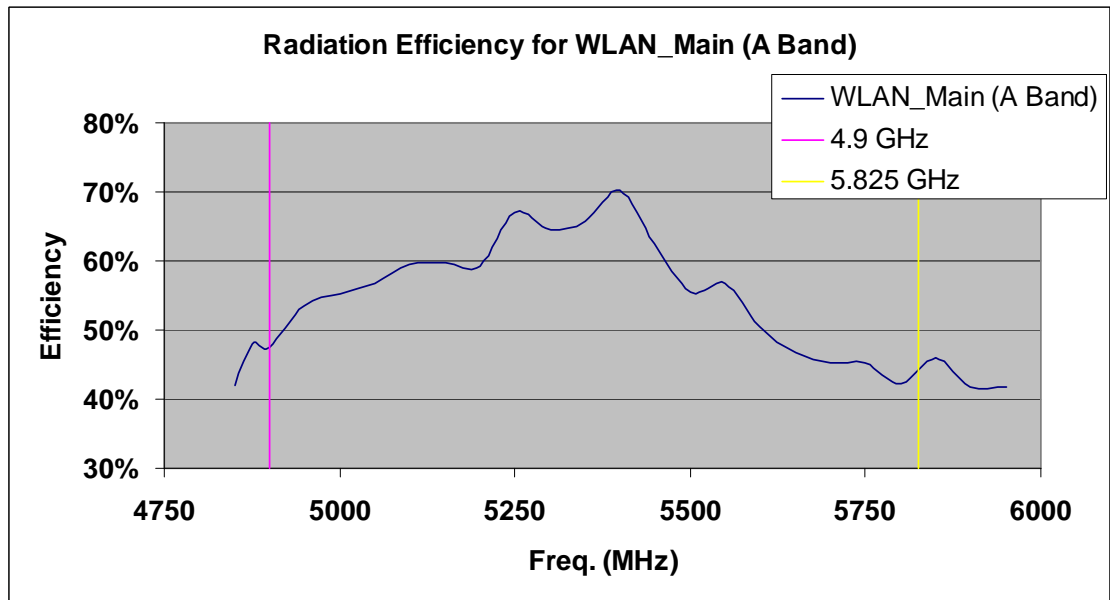
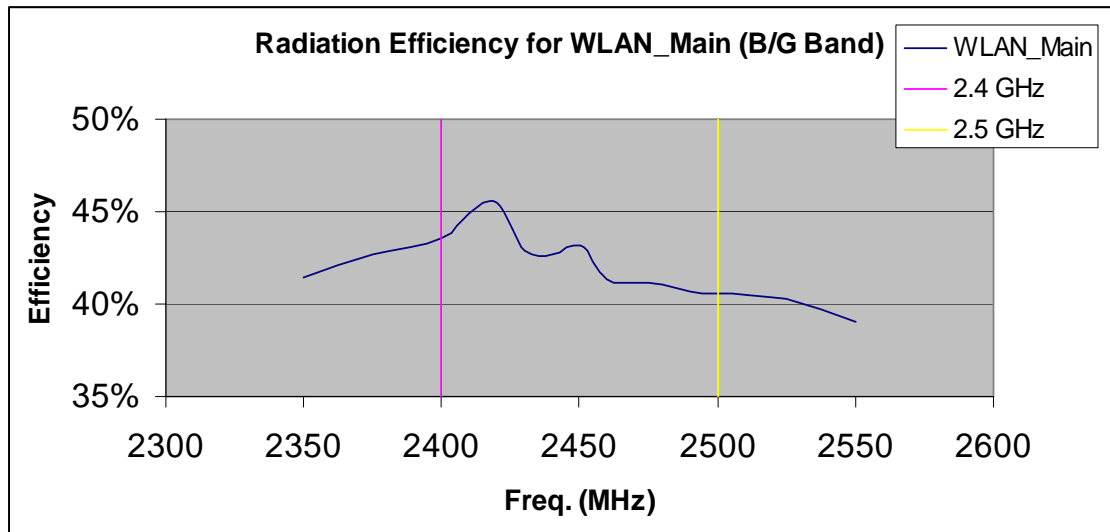

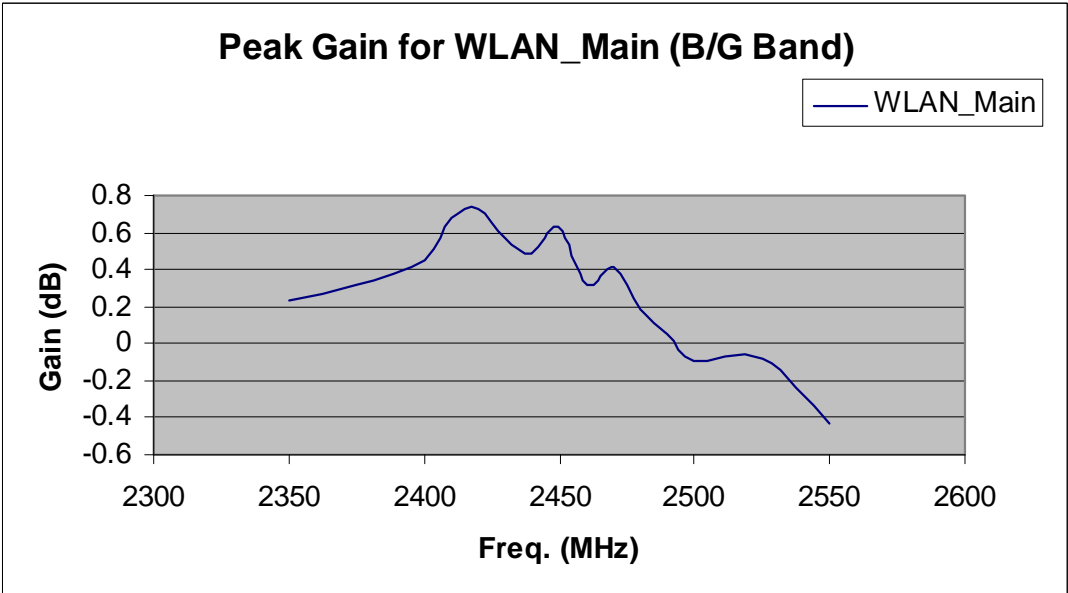
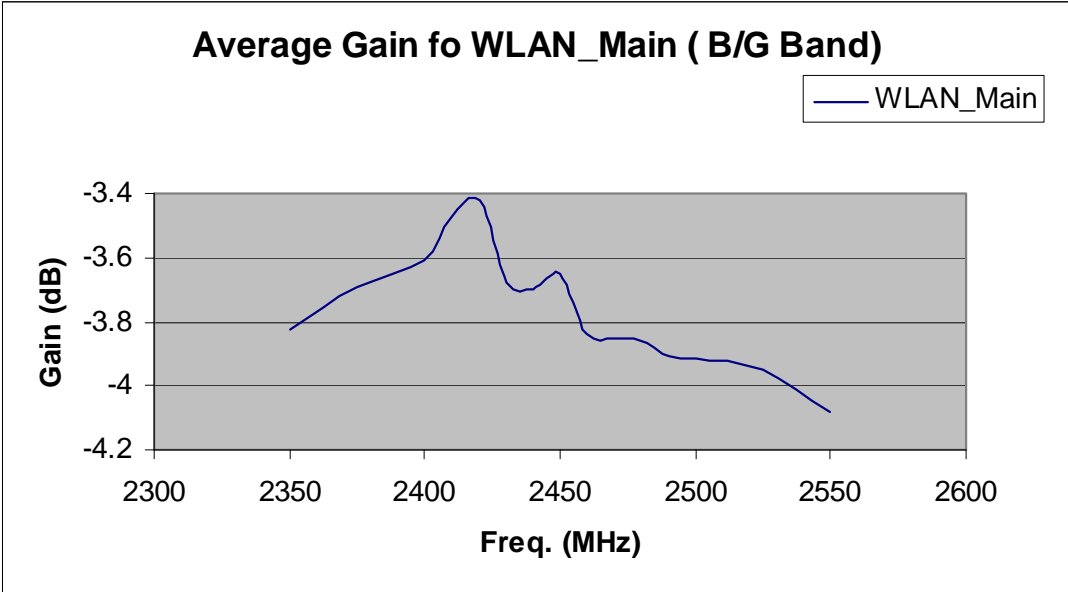

Average Gain for WLAN_Main (A Band)

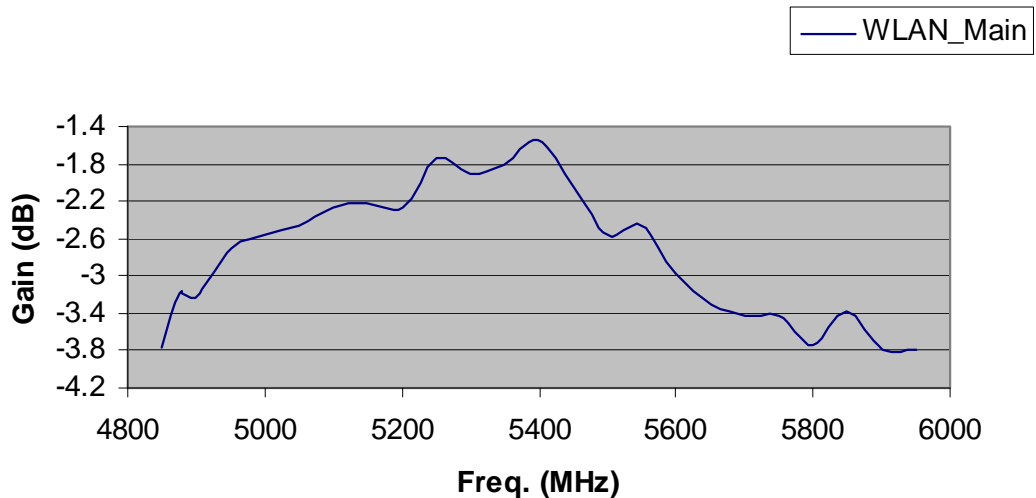

Peak Gain for WLAN_Main (A Band)

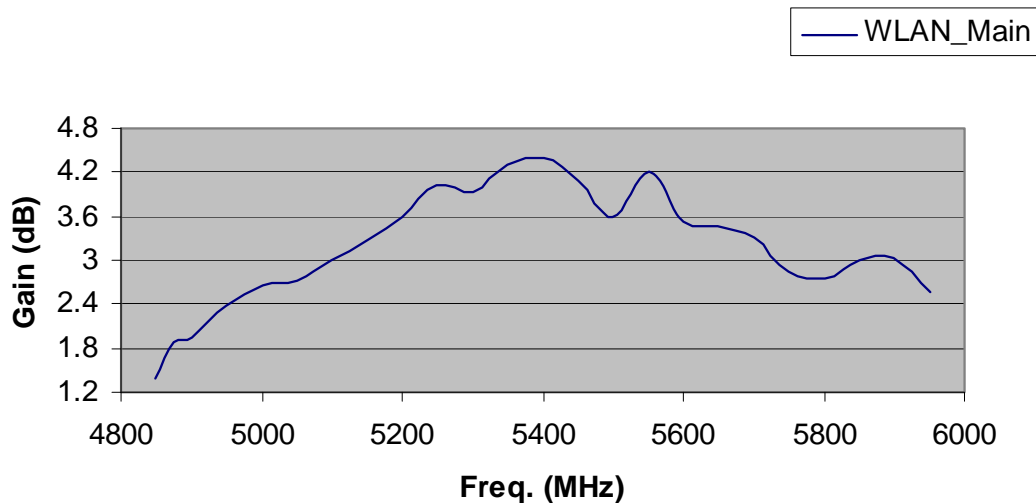

Radiation Patterns in the 3 Principle Planes

Phi = 0

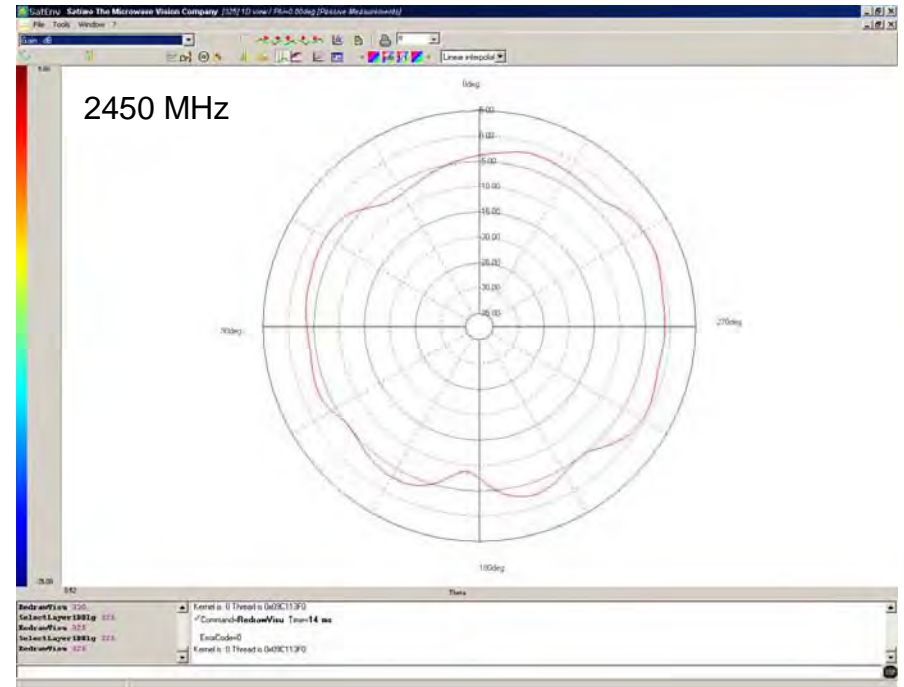
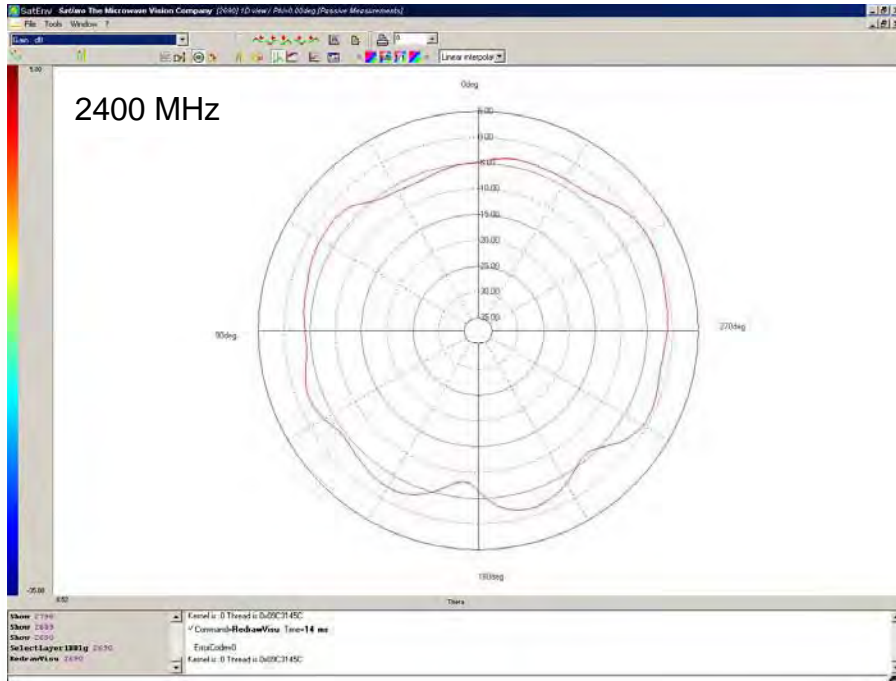

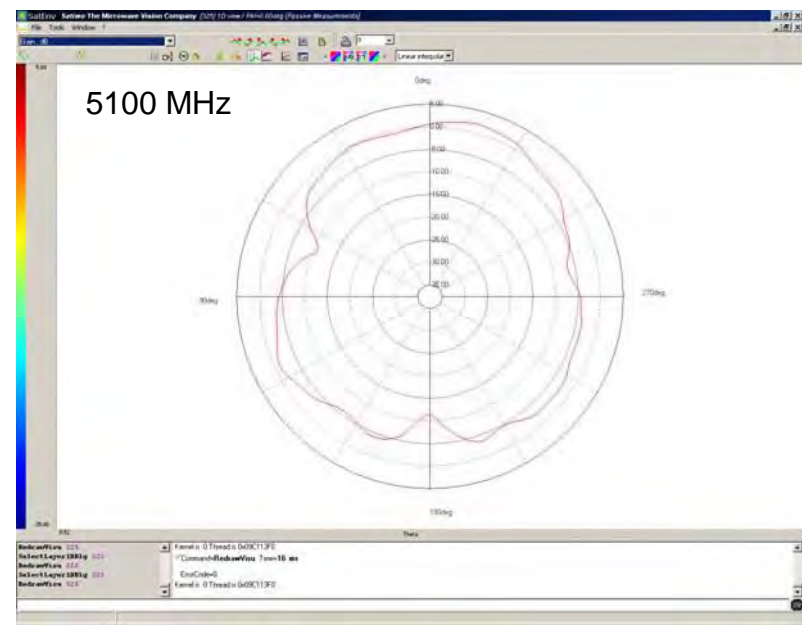
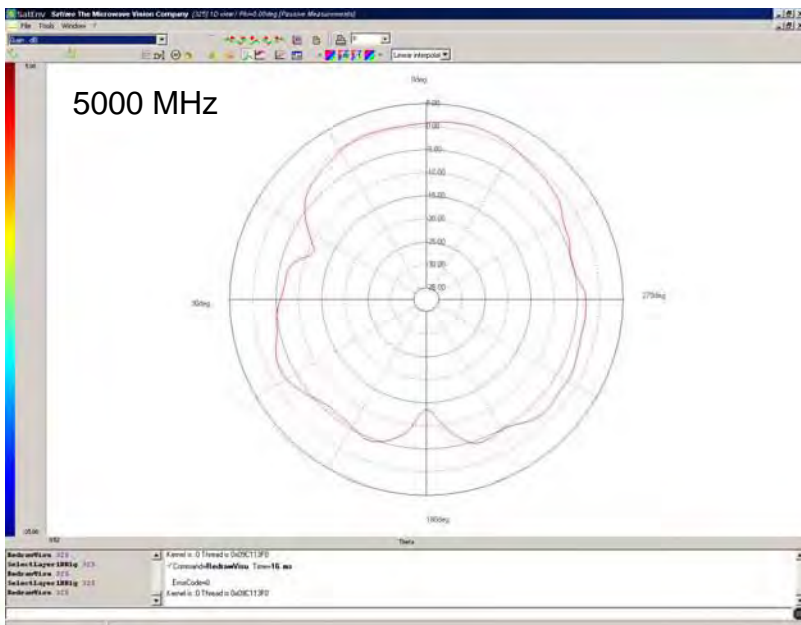
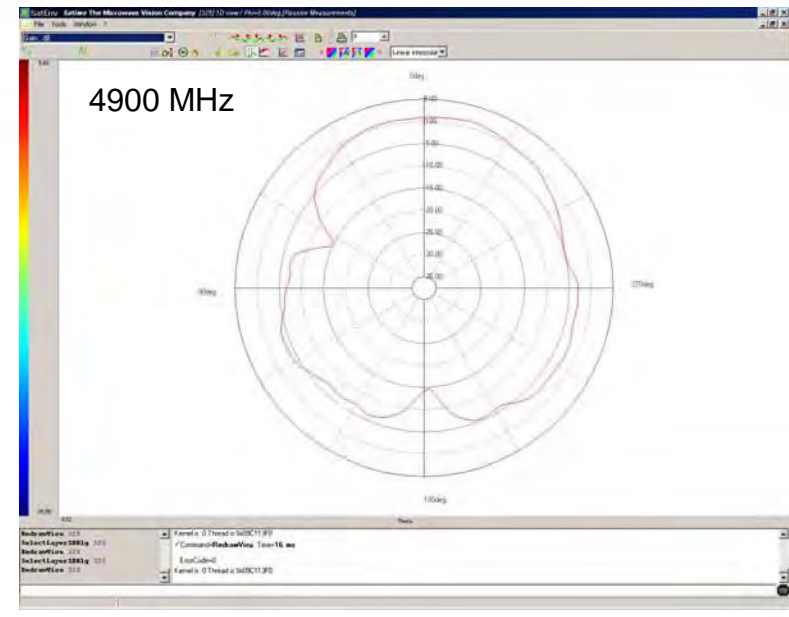
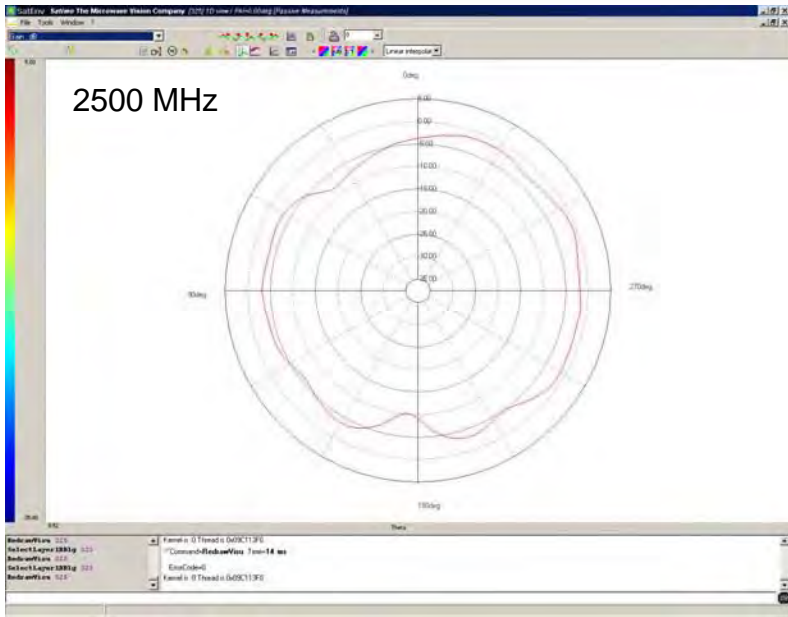

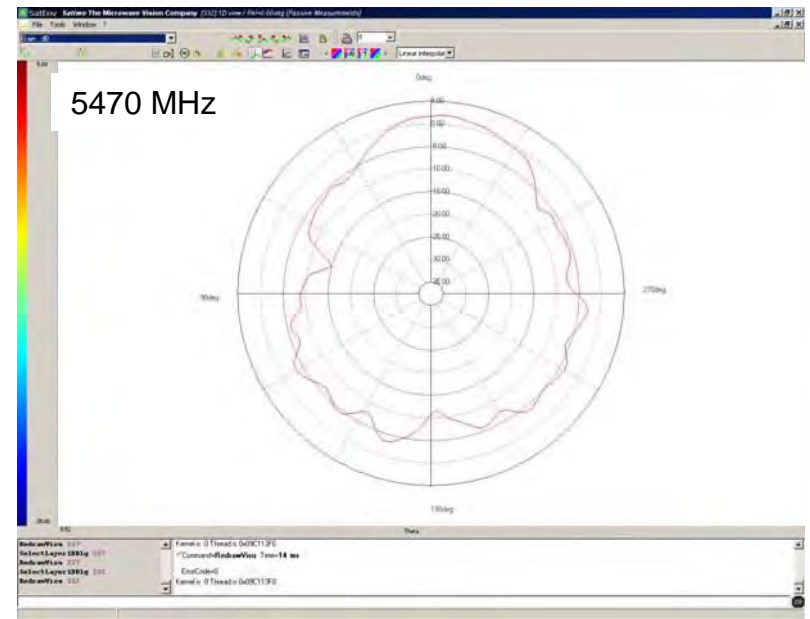
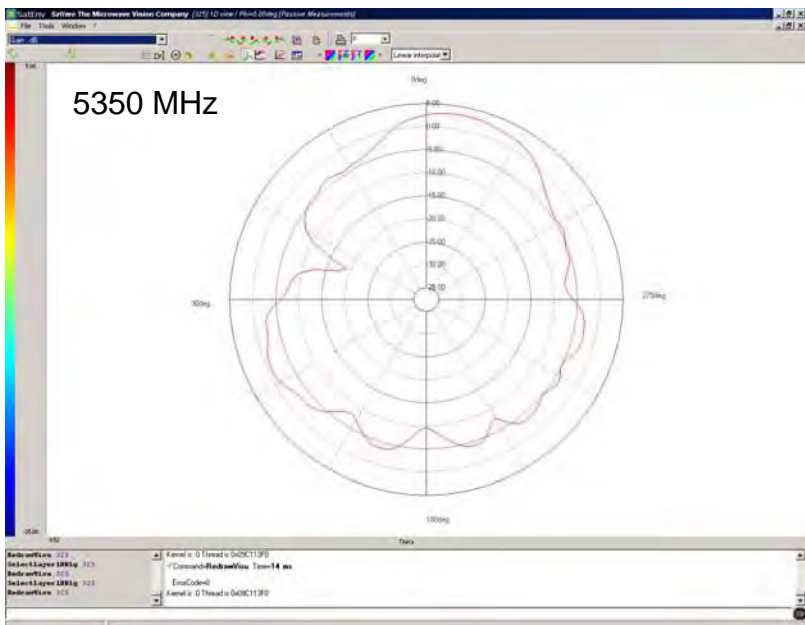
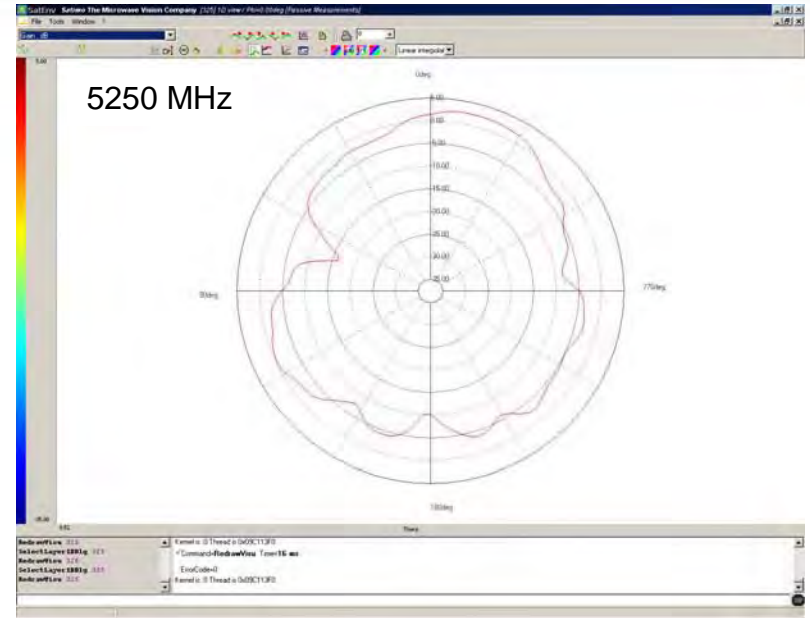
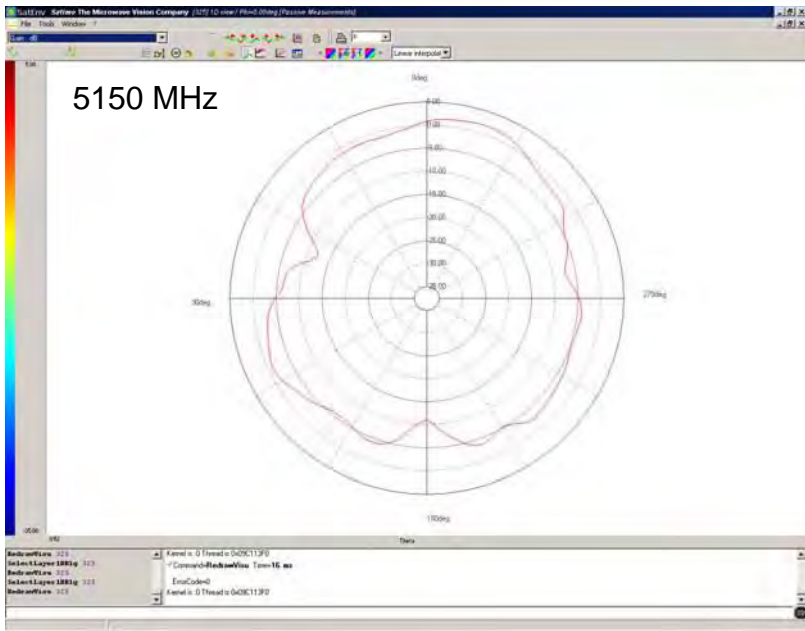

Phi = 90

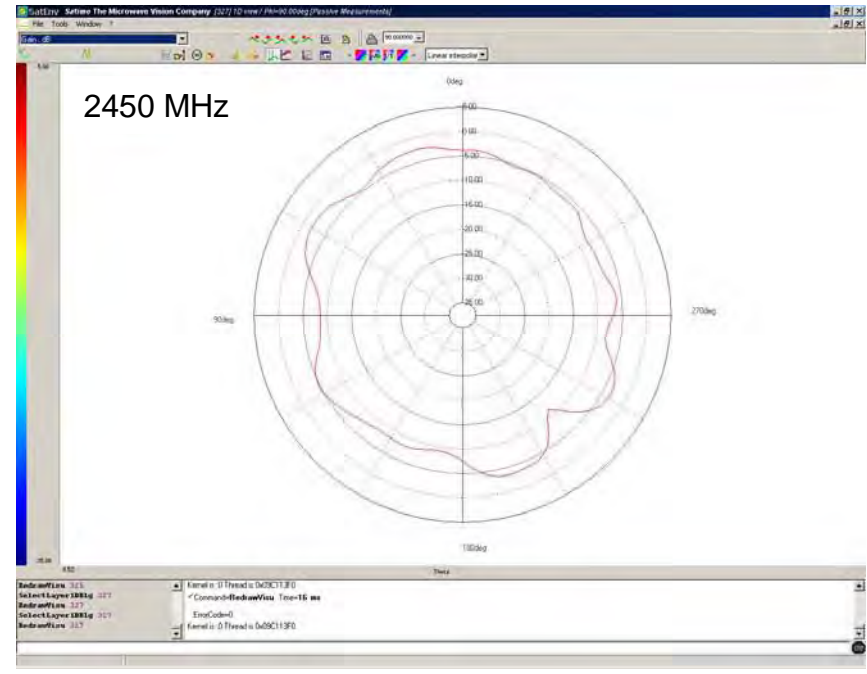
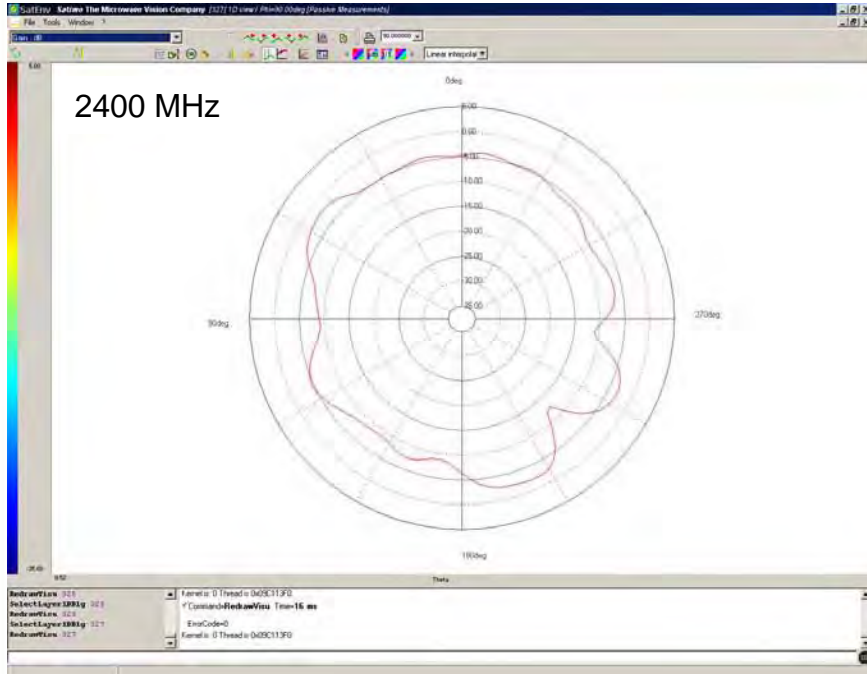

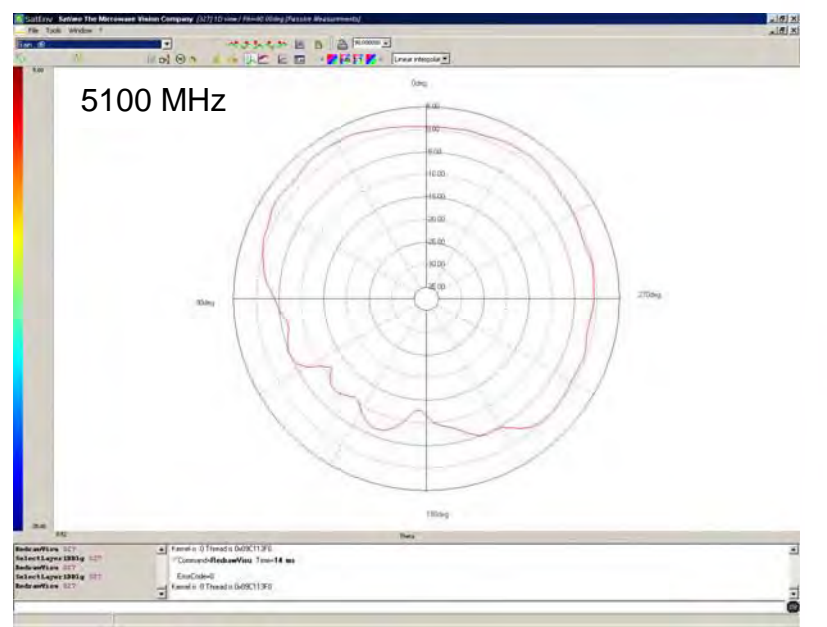
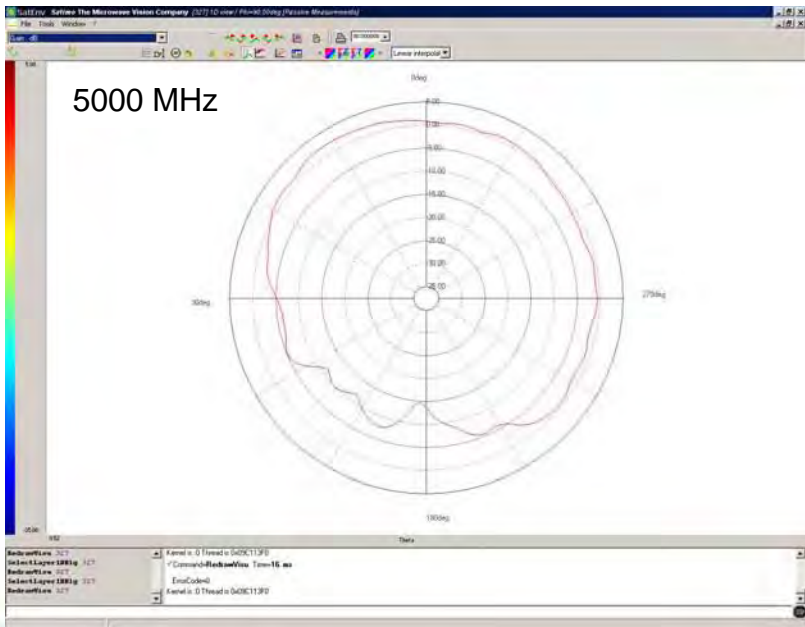
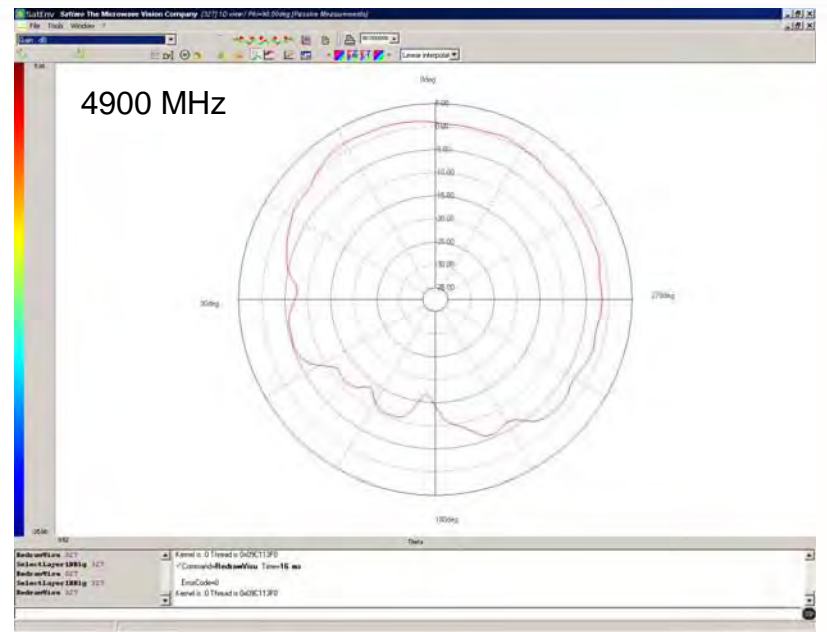
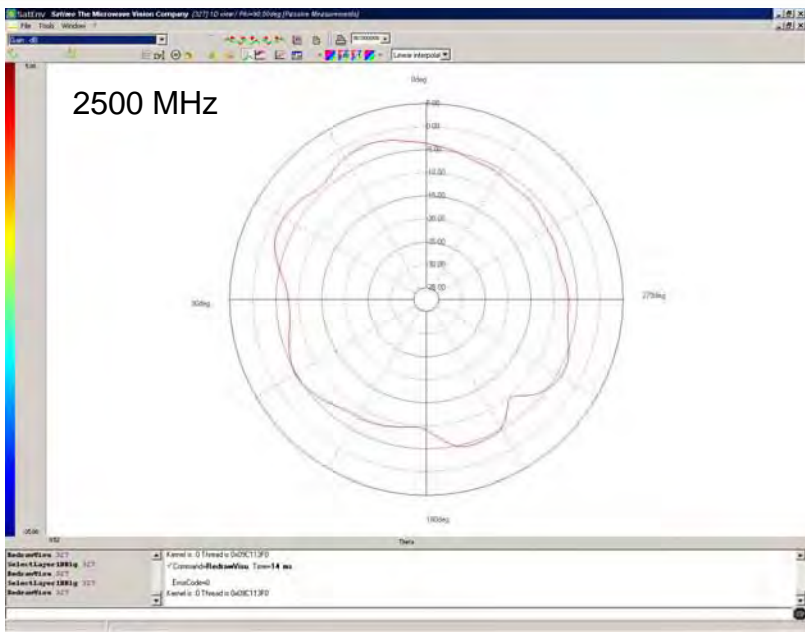

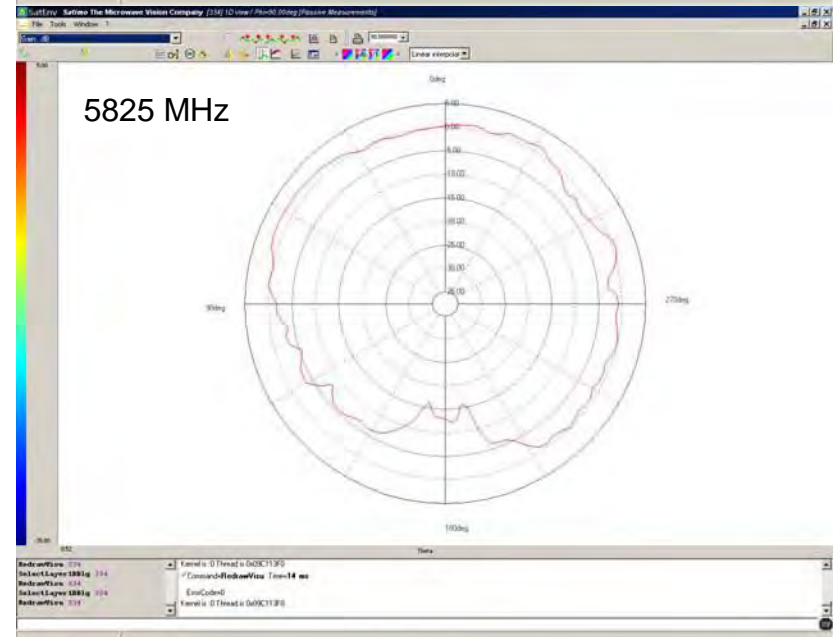
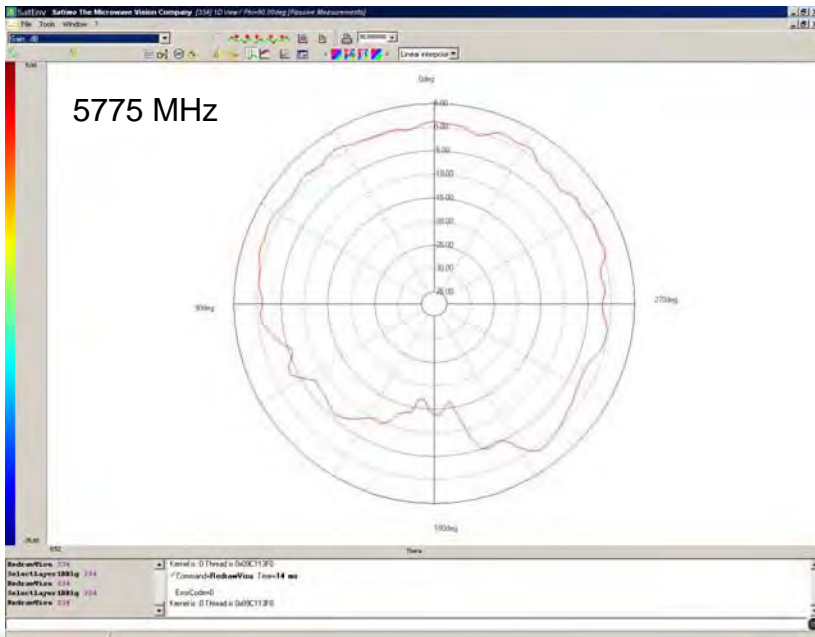
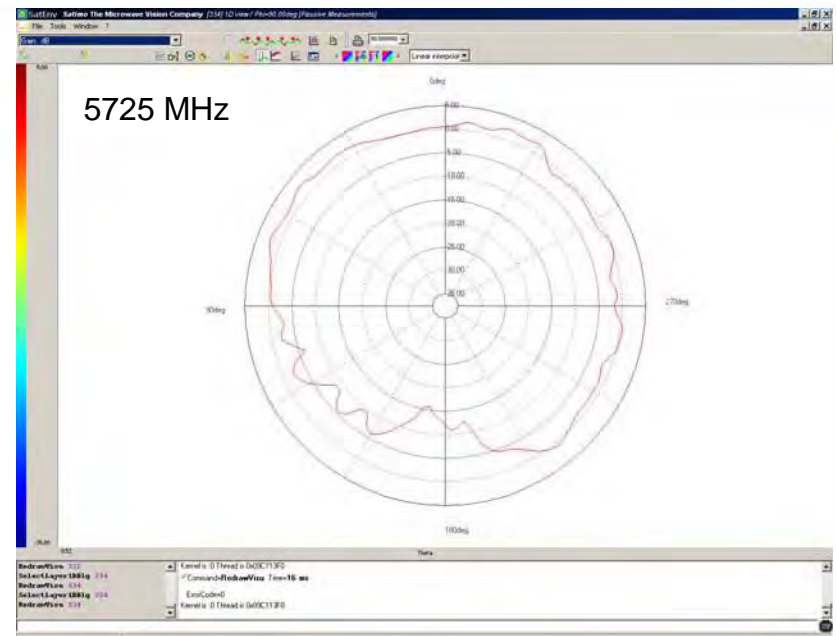
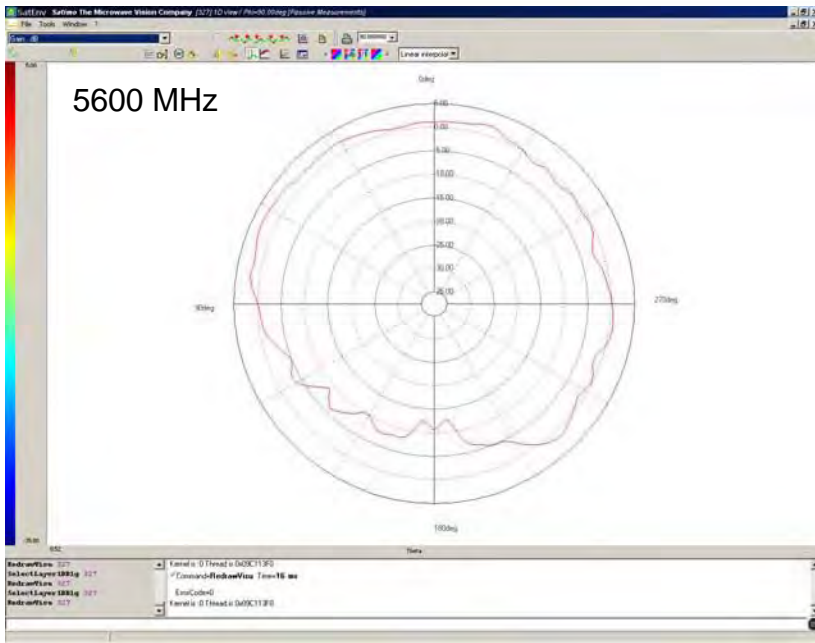

Theta = 90

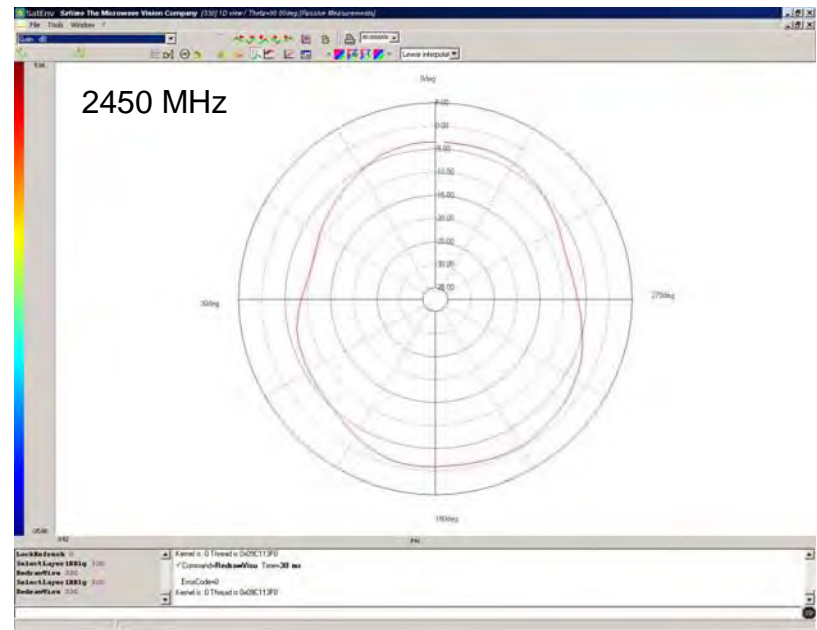
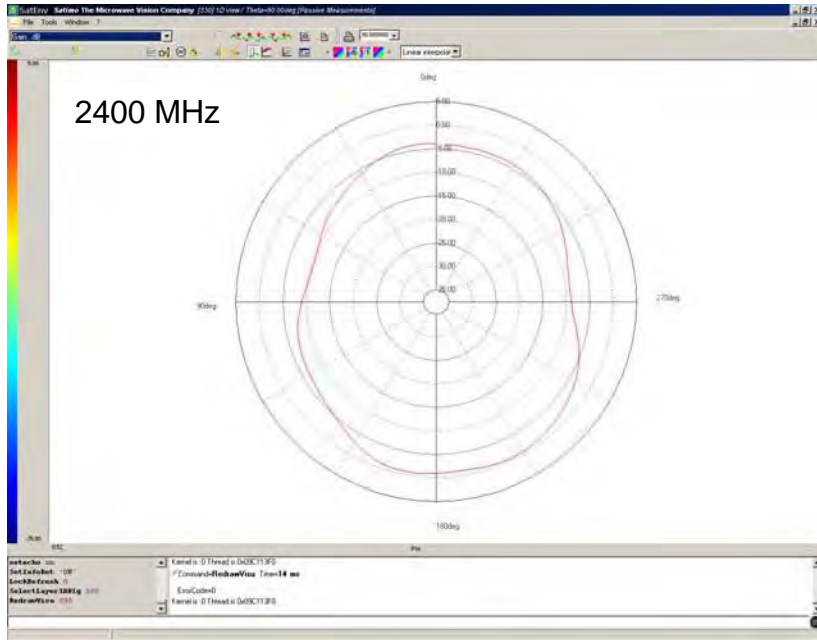

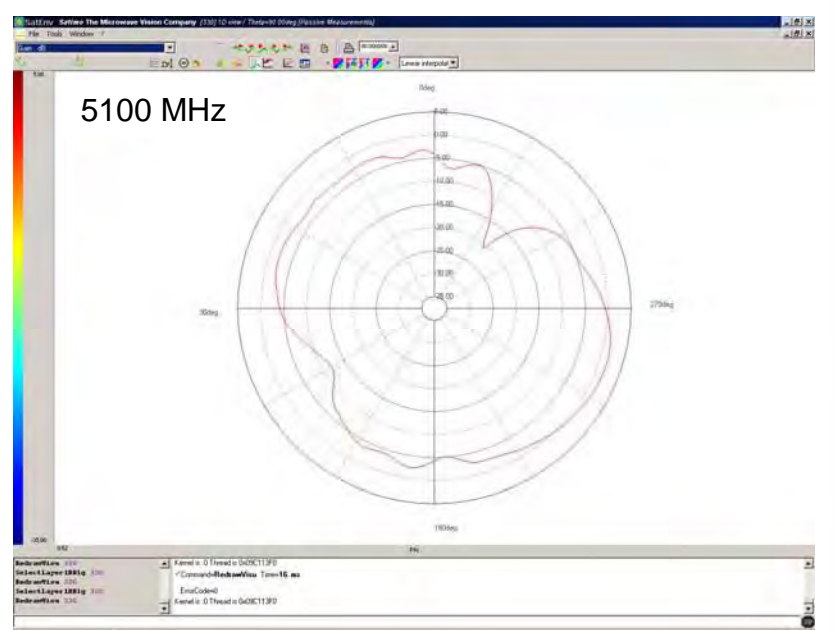
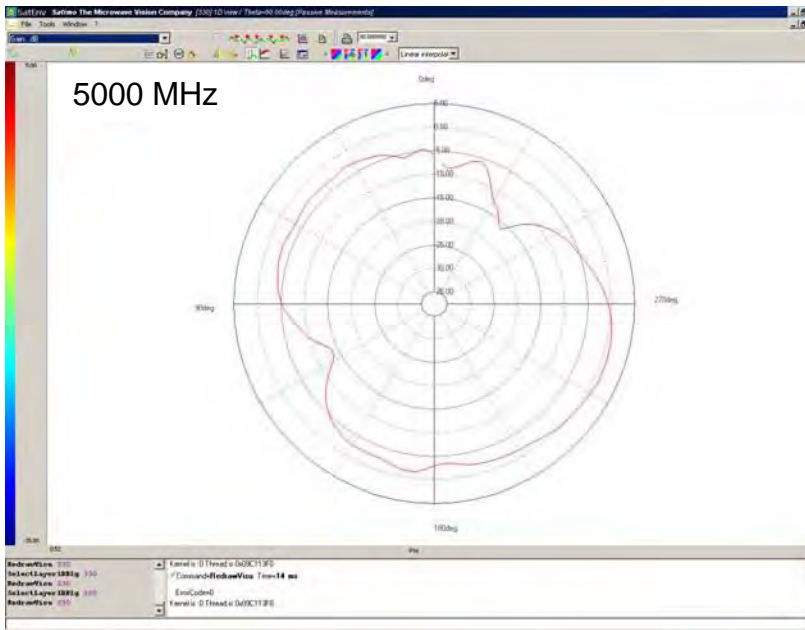
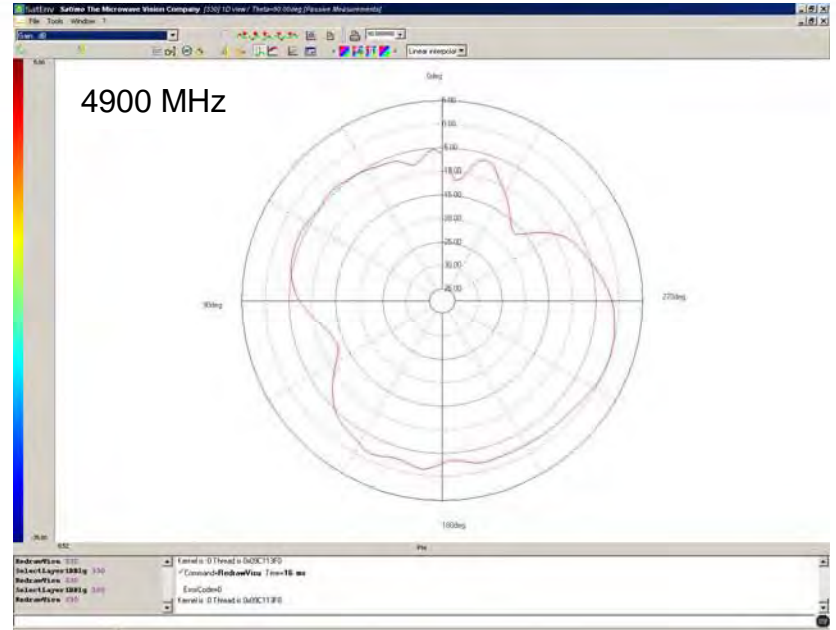
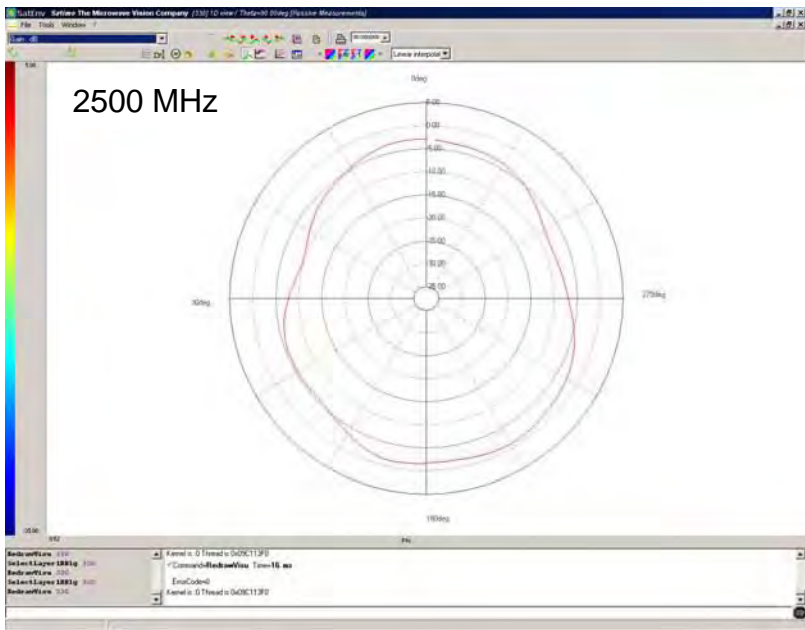

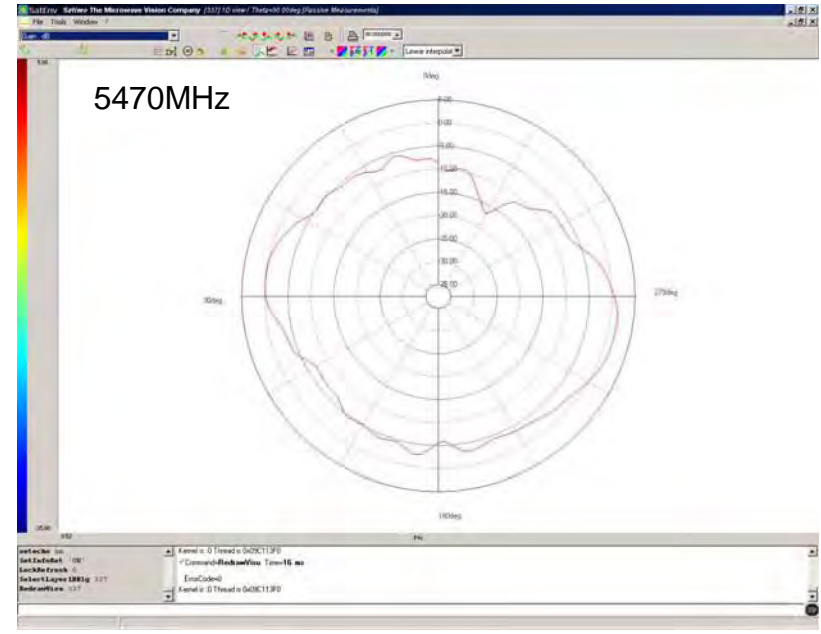
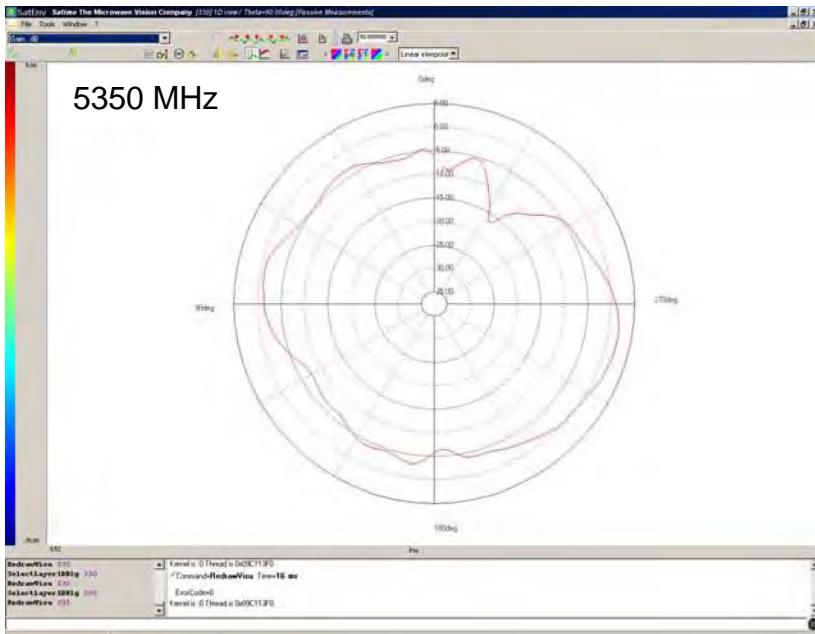
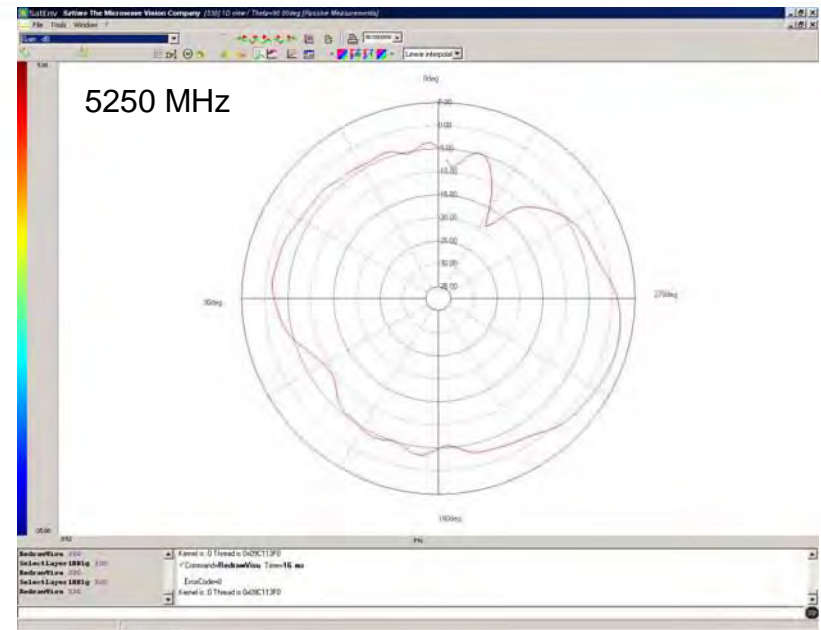
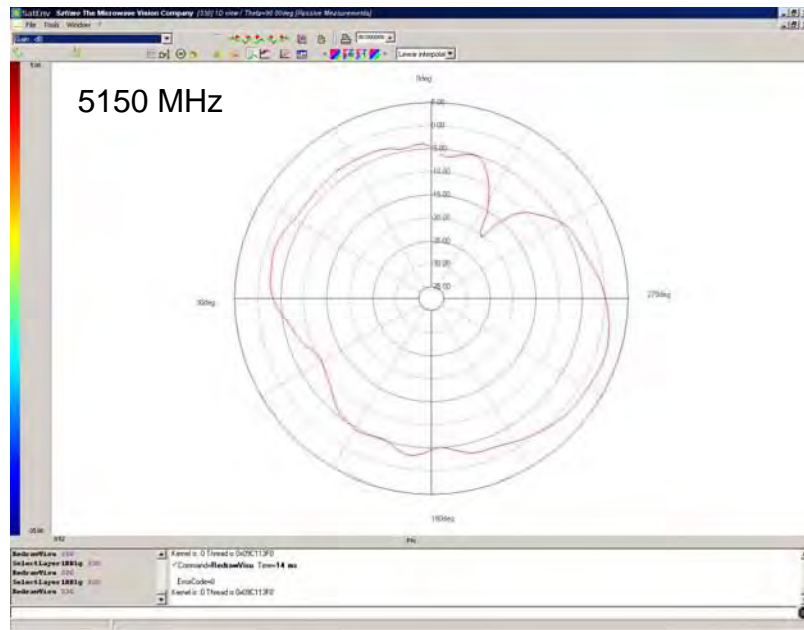

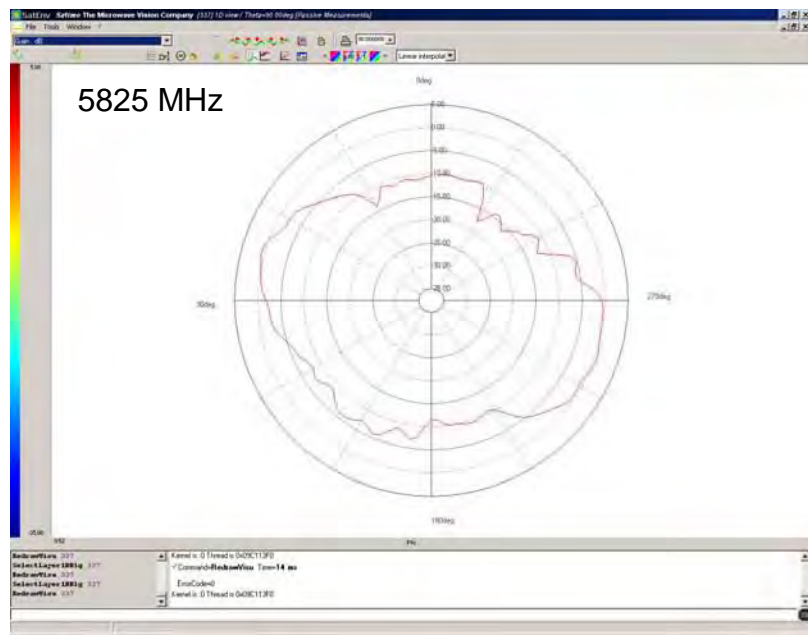
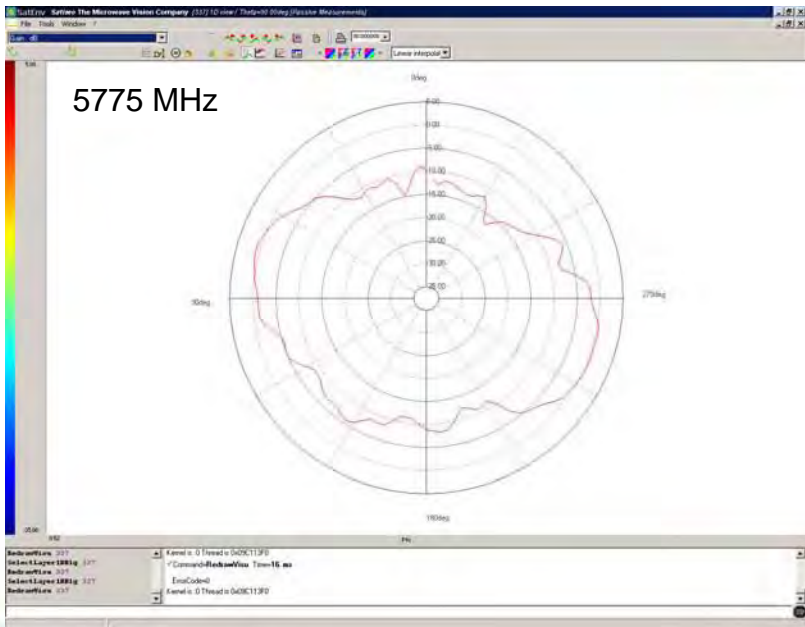
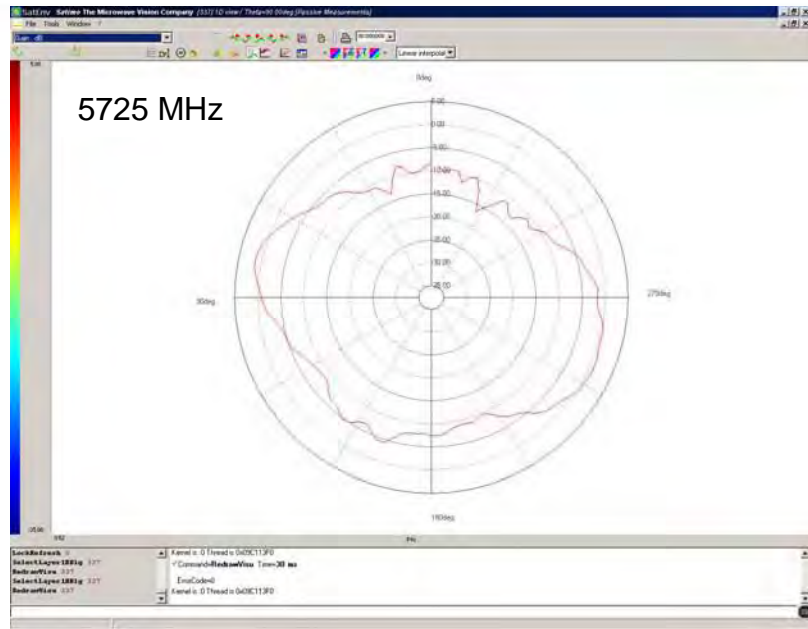
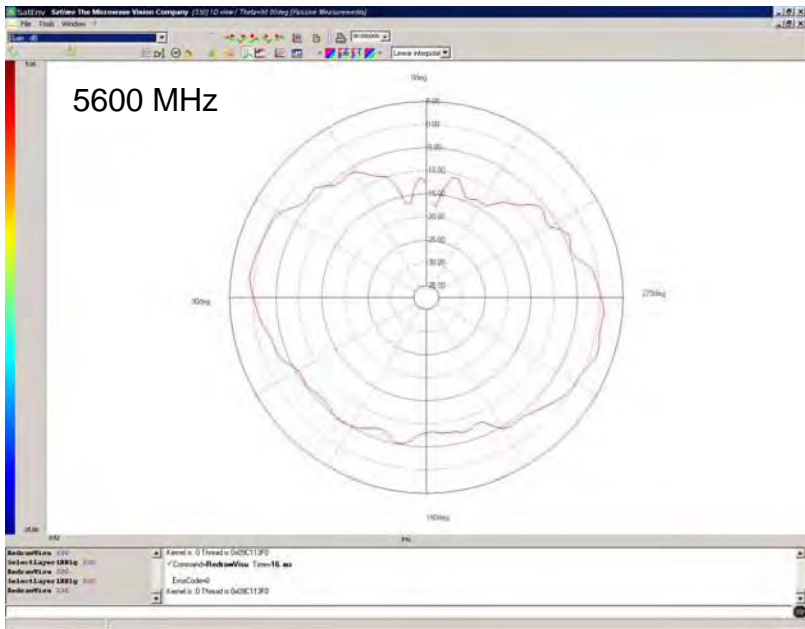



CK3 Antenna Report 802.11 a/b/g Diversity

05/19/2008 Intermec Radio Integration Team

Pattern data covers the following frequencies in MHz: 2400, 2450, 2500, 4900, 5000, 5100, 5150, 5250, 5350, 5470, 5600, 5725, 5775, 5825



Technologies Corporation

Gain, Radiation Patterns for WLAN Diversity Antenna Intermec Technologies Model CK3

Background:

- 1. All measurements were taken using CK3 production unit with the CK3 engineering fixture.**
- 2. Return loss and VSWR are measured using Agilent Technologies E5071B network analyzer.**
- 3. Peak gain, average gain and radiation patterns in the 3 principle planes are measured with SATIMO 3D 64 STARGATE anechoic chamber.**
- 4. Data Supplied by Laird Technologies.**

Antenna:

Manufacturer: Laird Technologies

Antenna Type: Diversity, 802.11 a/b/g, Internal PIFA

Coordinate System for the Measurements of WLAN Diversity Antenna

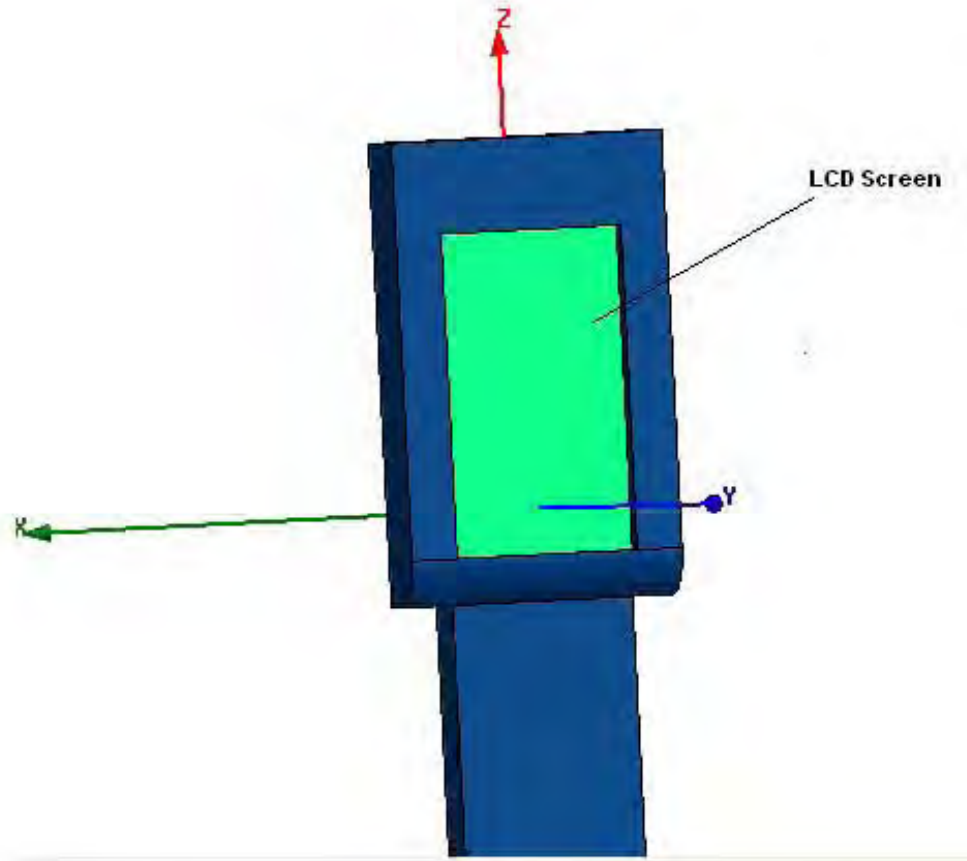

LCD screen is facing the Positive Y direction

WLAN_Diversity Antenna

Measured Return Loss for WLAN Diversity Antenna

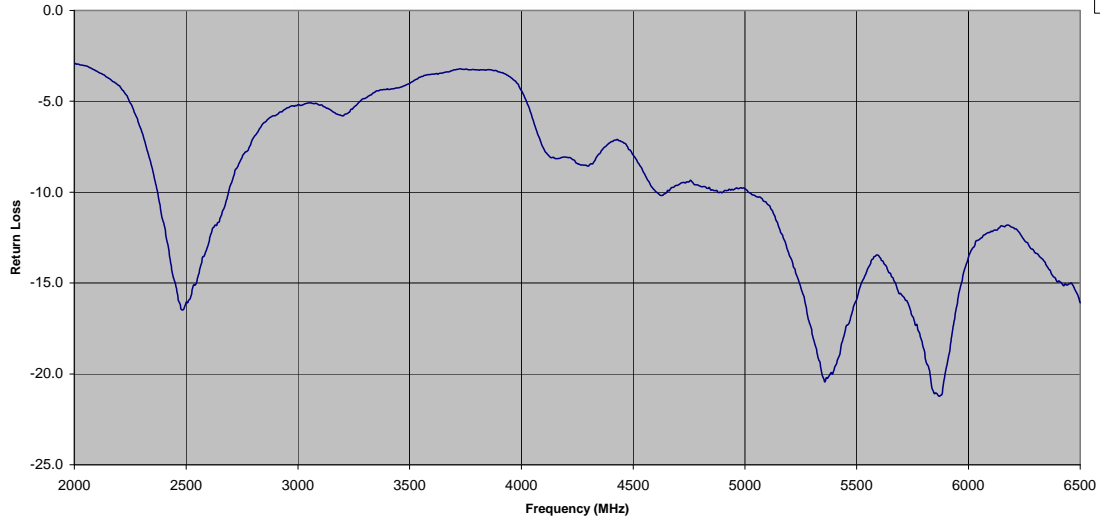

WLAN_Diversity Antenna

Measured VSWR for WLAN Diversity Antenna

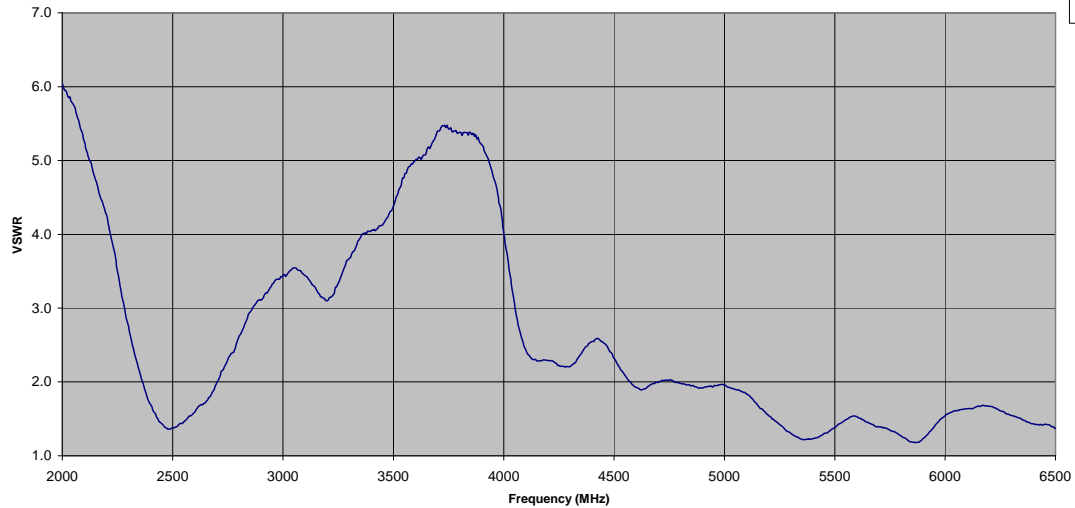

Snap Shot of Measured VSWR for WLAN Diversity Antenna

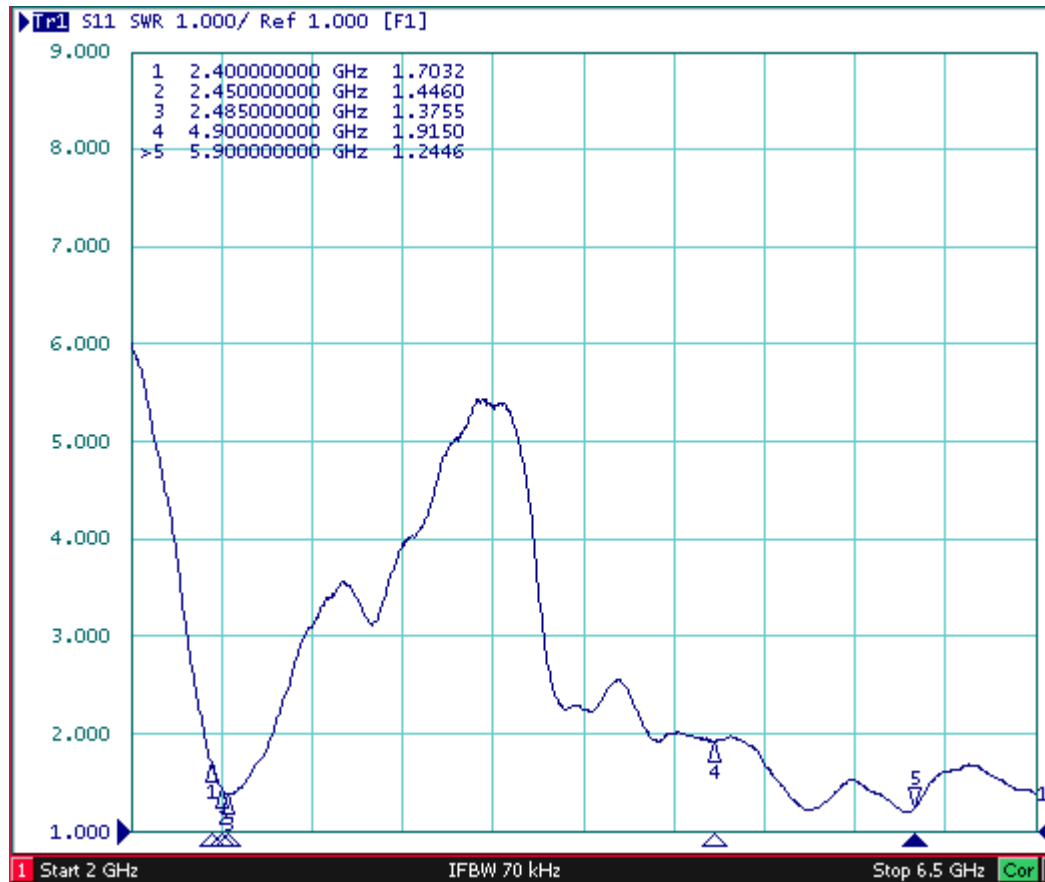

Radiation Efficiency for WLAN_Diversity (B/G Band)

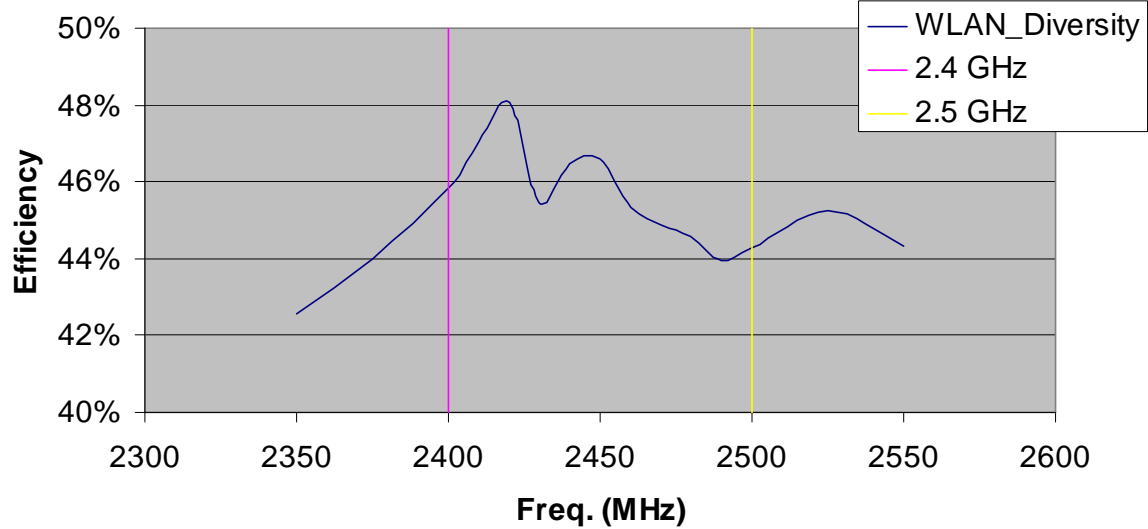

Radiation Efficiency for WLAN_Diversity (A Band)

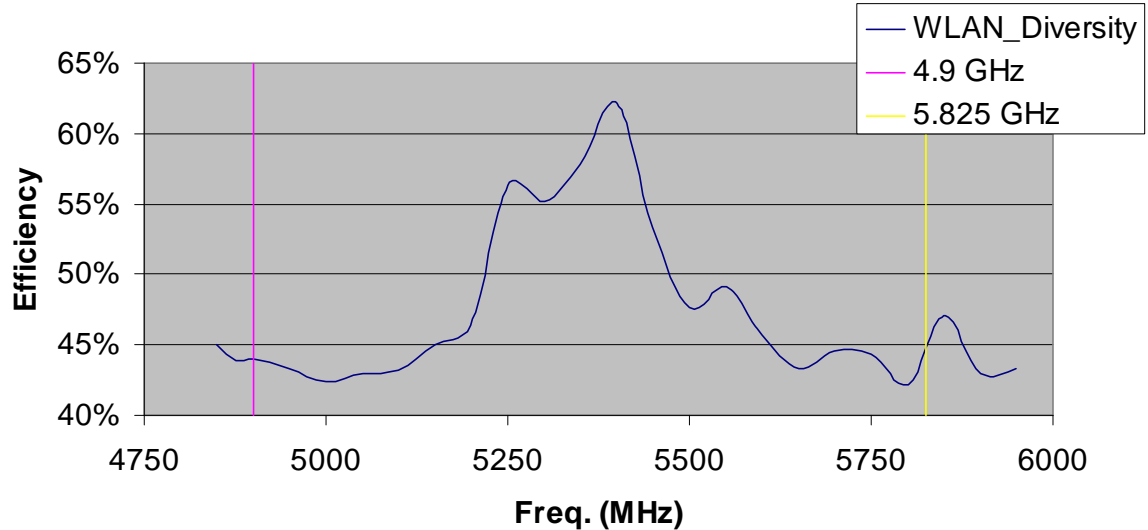

Average Gain for WLAN_Diversity (B/G Band)

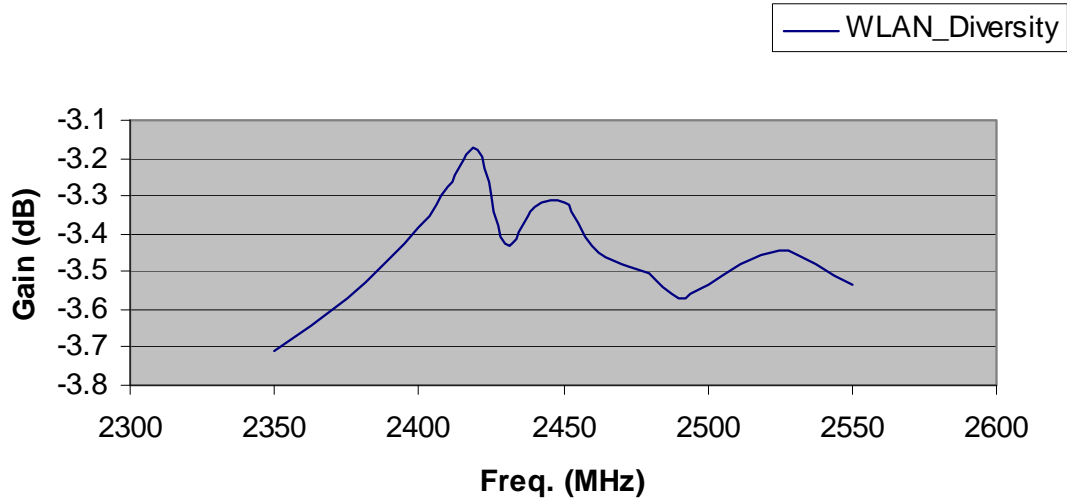

Peak Gain for WLAN_Diversity (B/G Band)

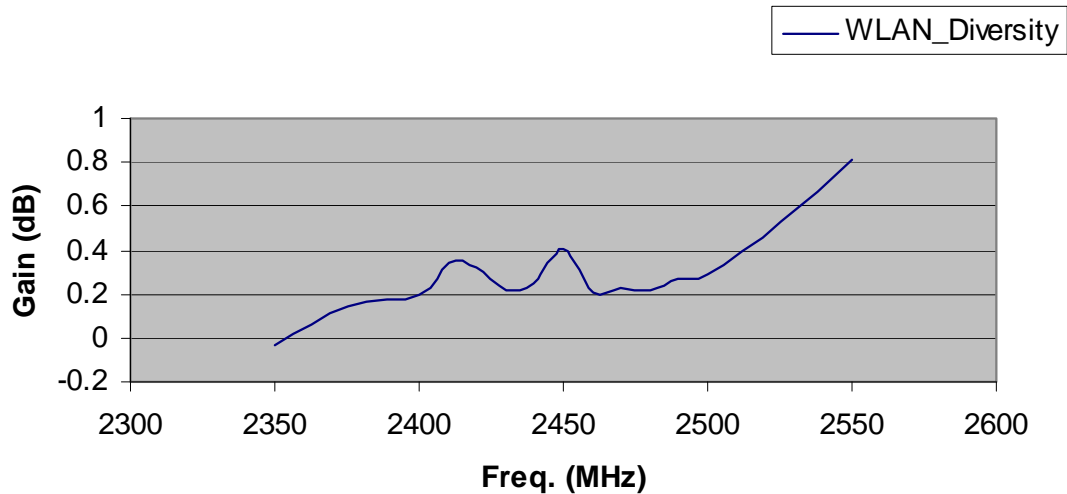

Average Gain for WLAN_Diversity (A Band)

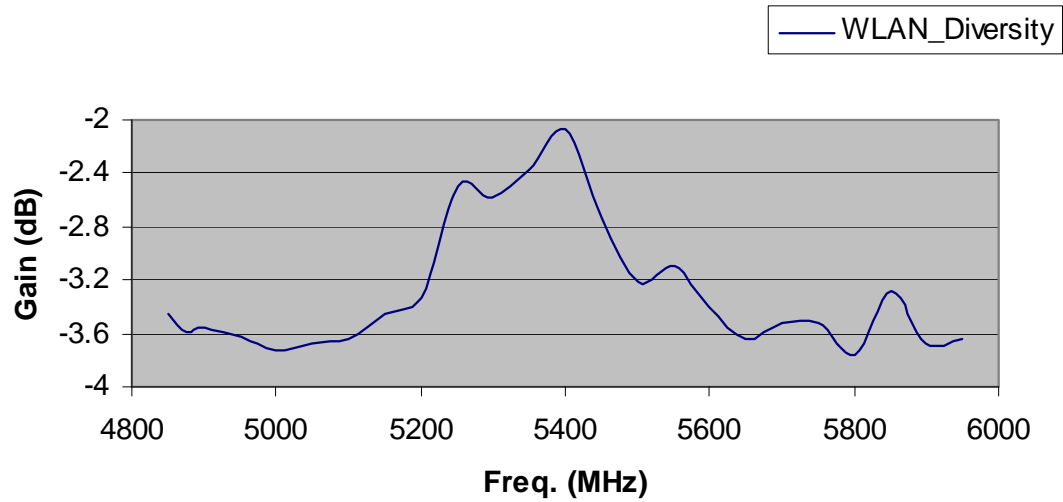

Peak Gain for WLAN_Diversity (A Band)

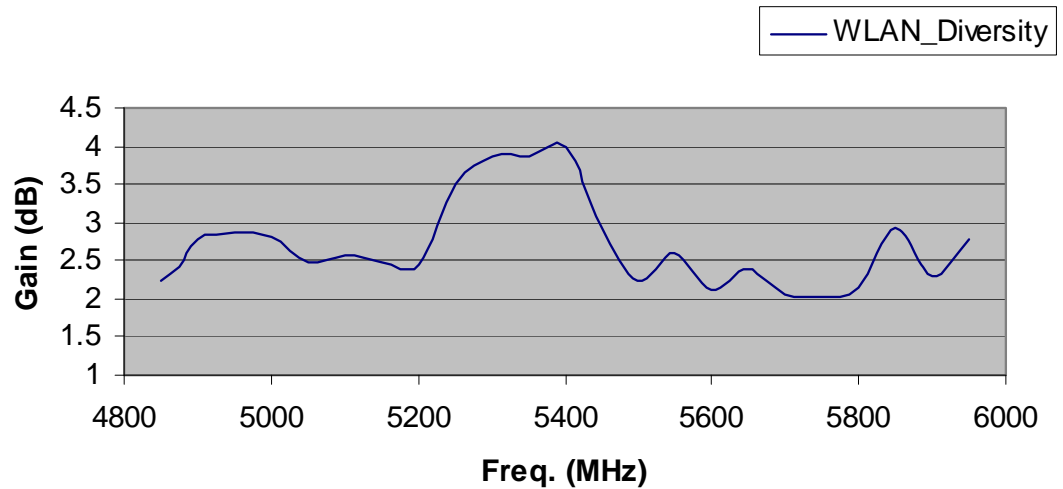

Phi = 0

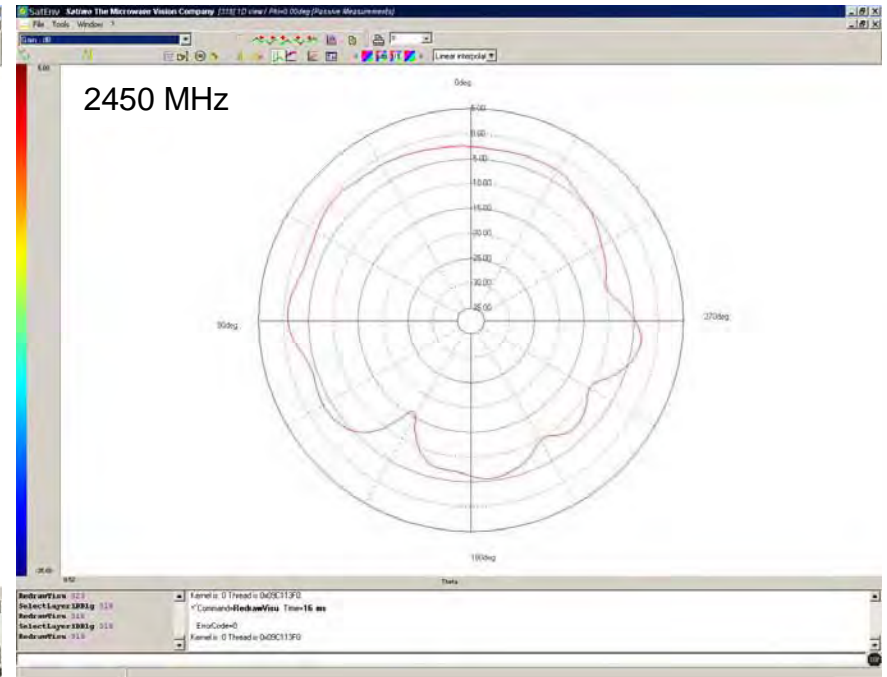
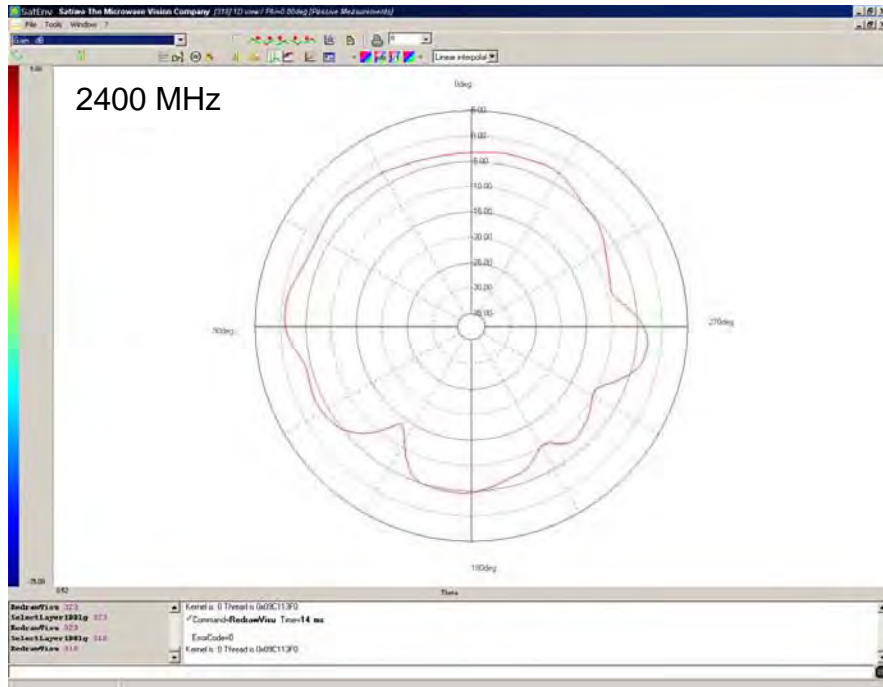

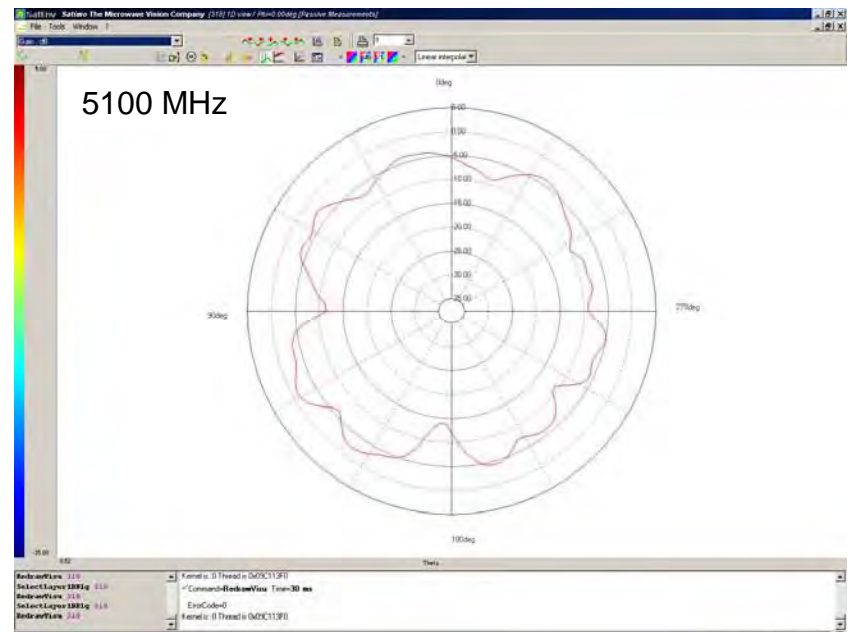
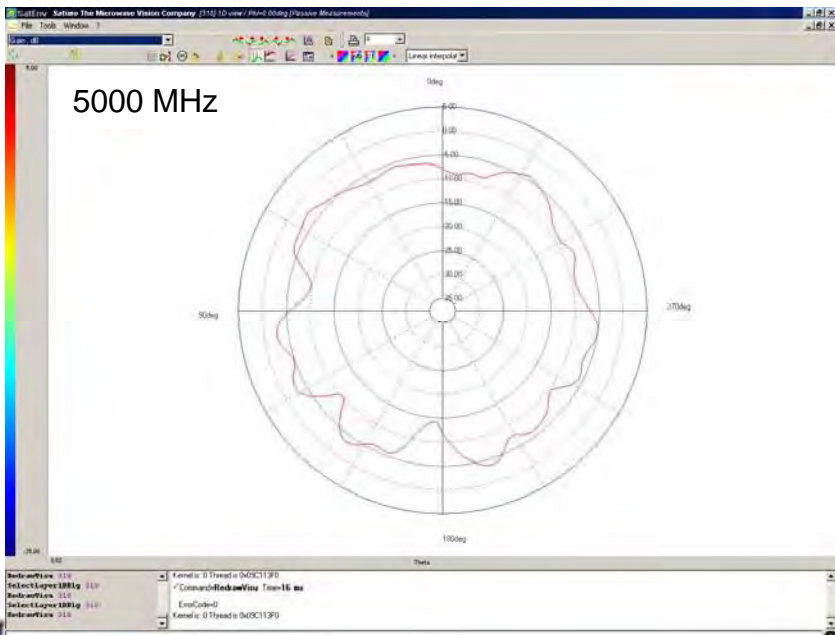
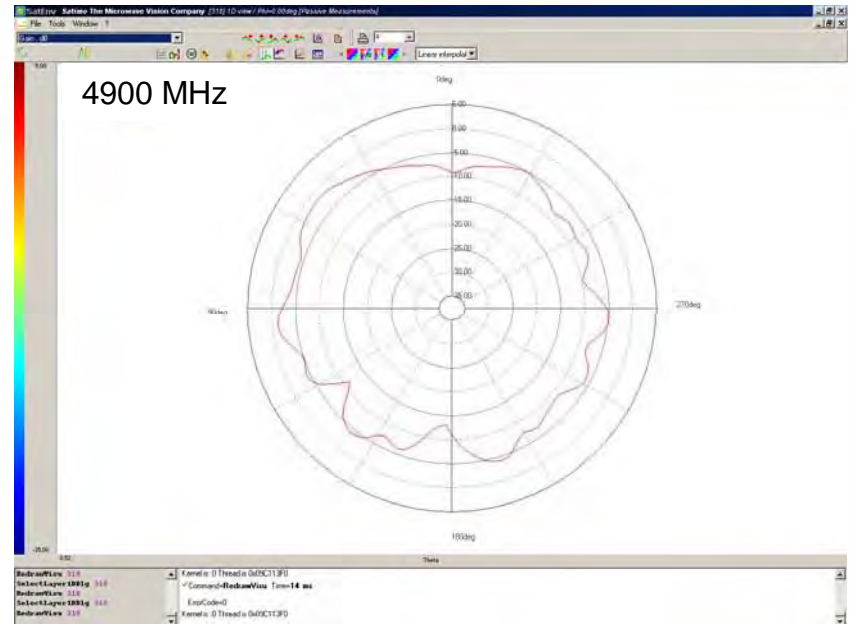
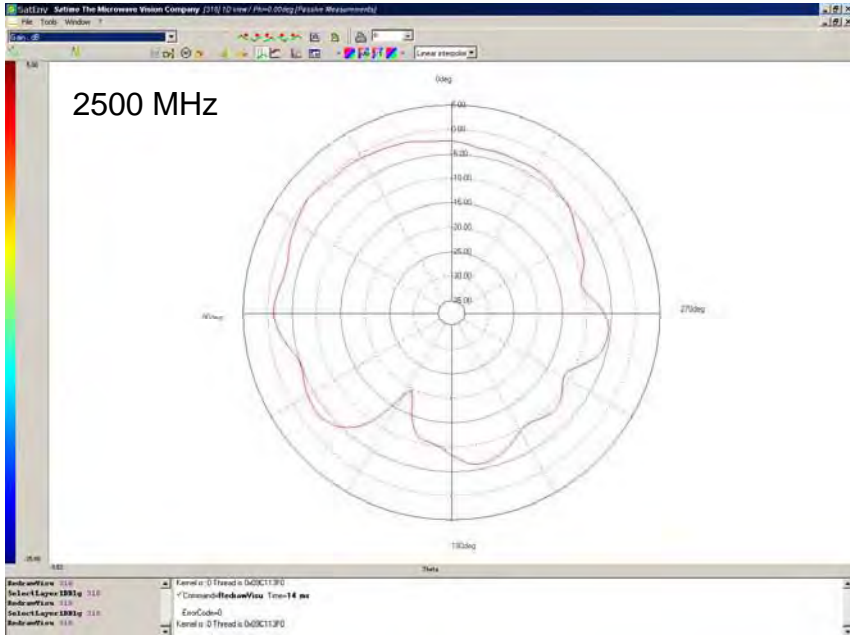

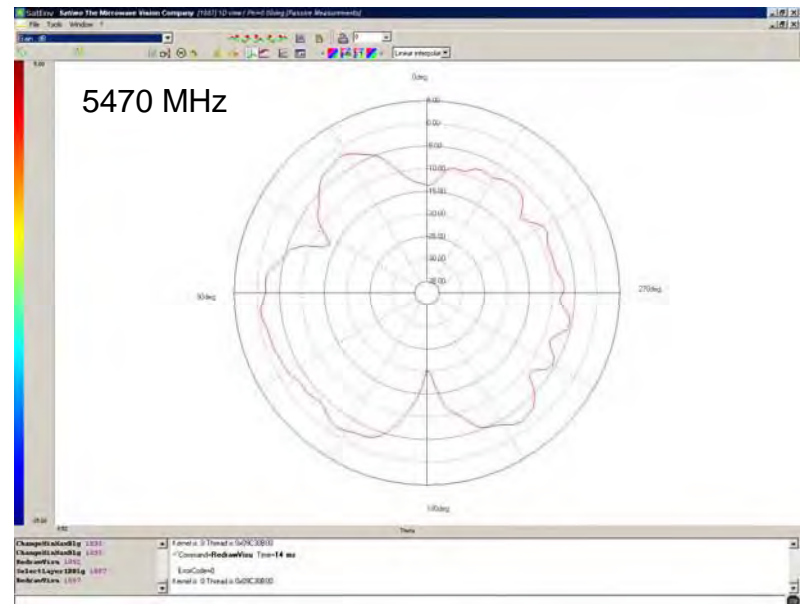
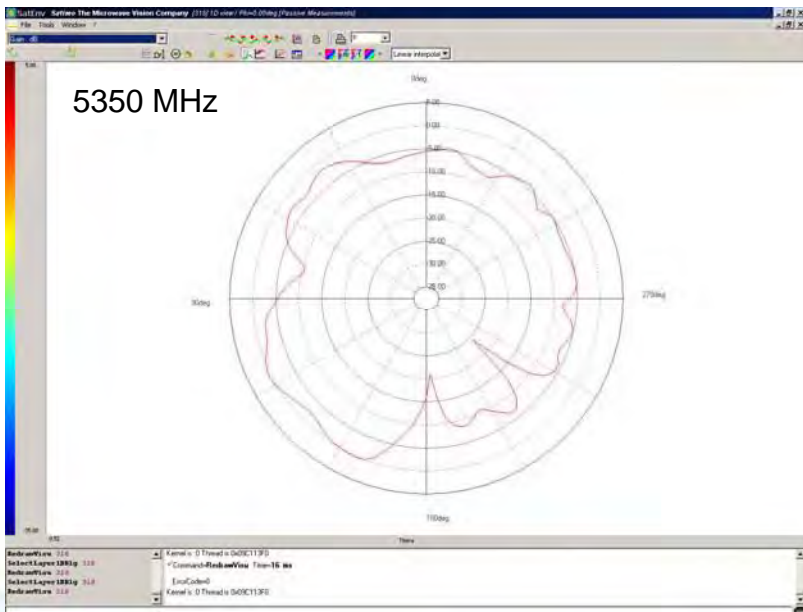
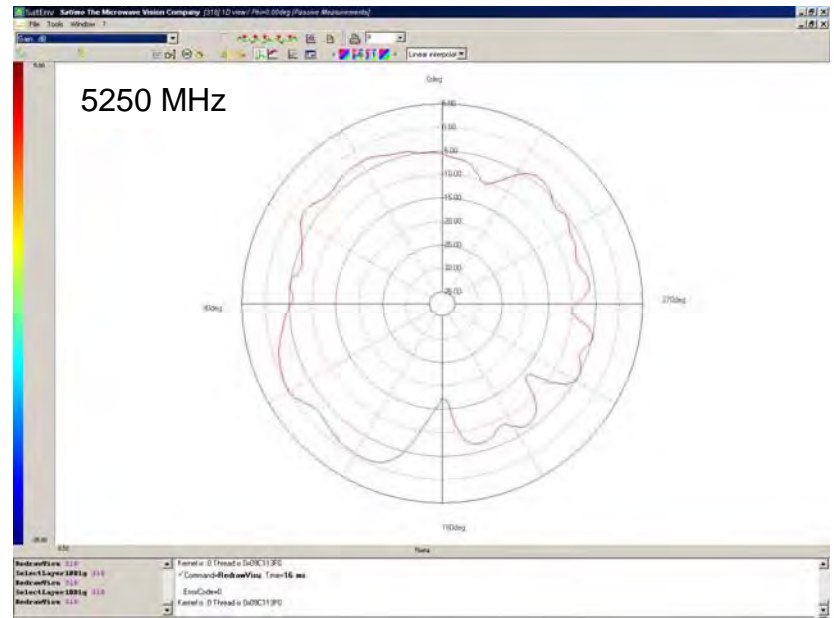
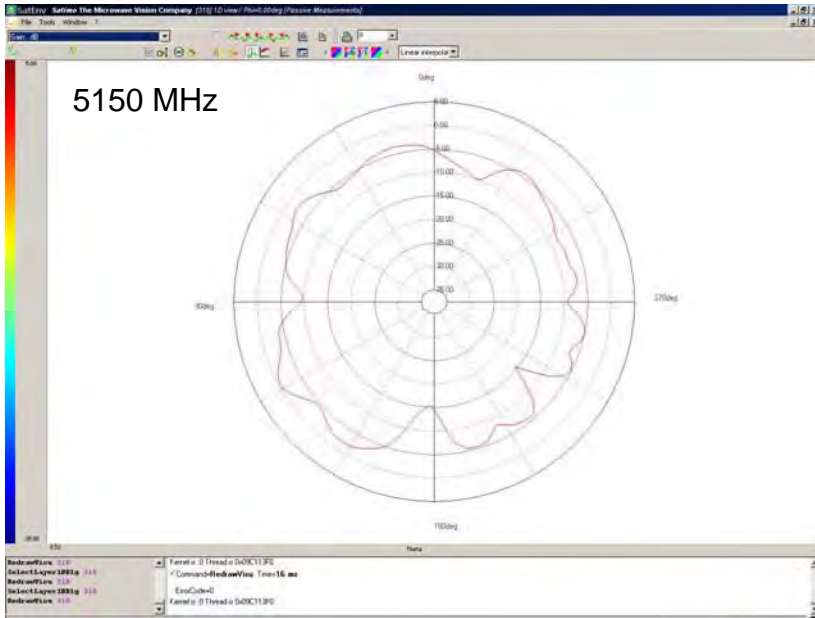

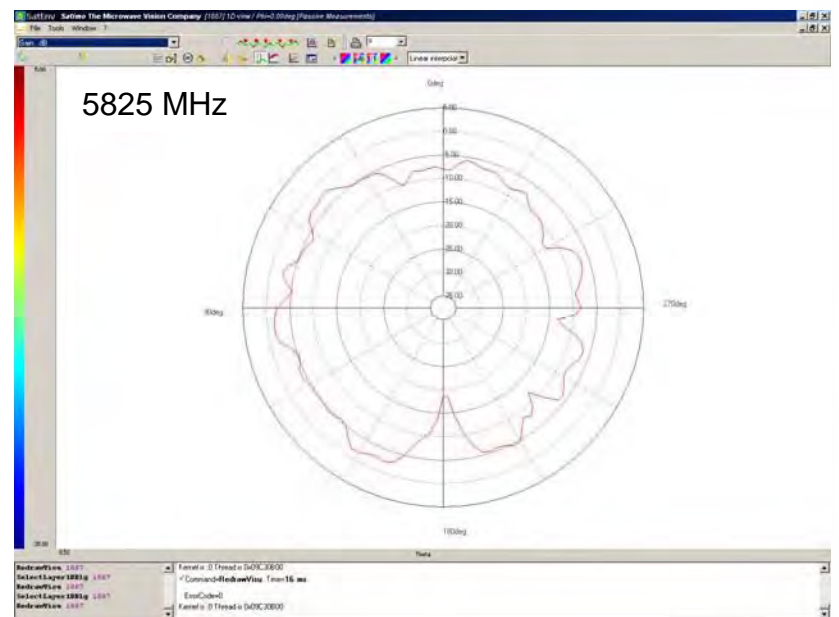
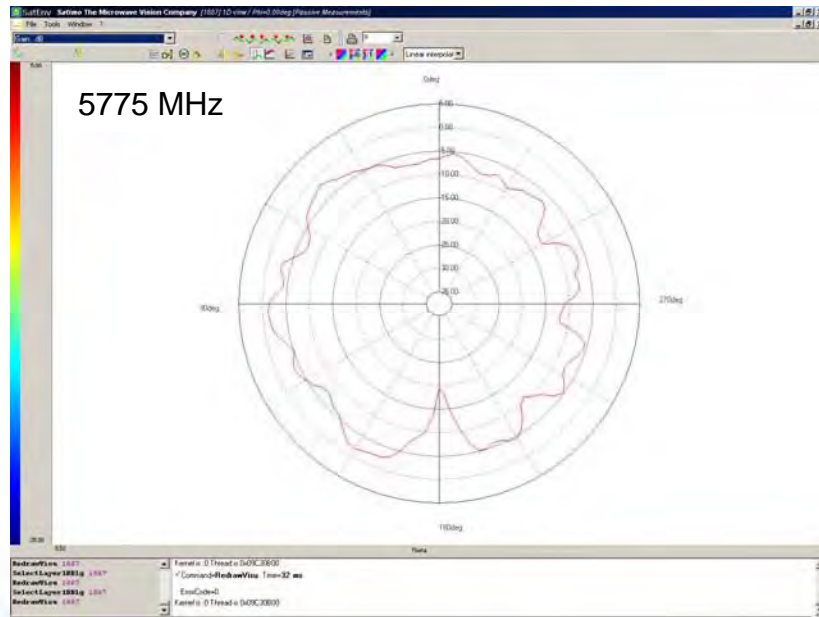
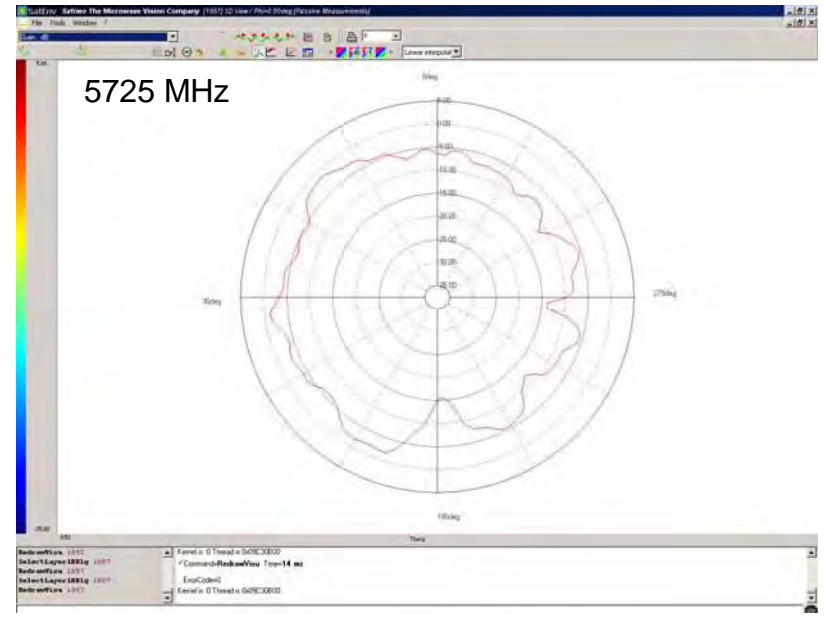
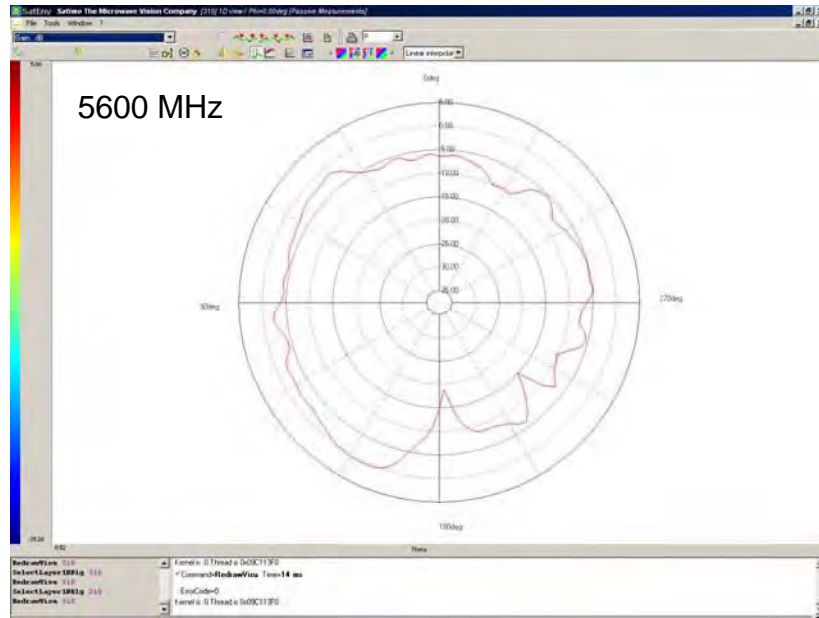

Phi = 90

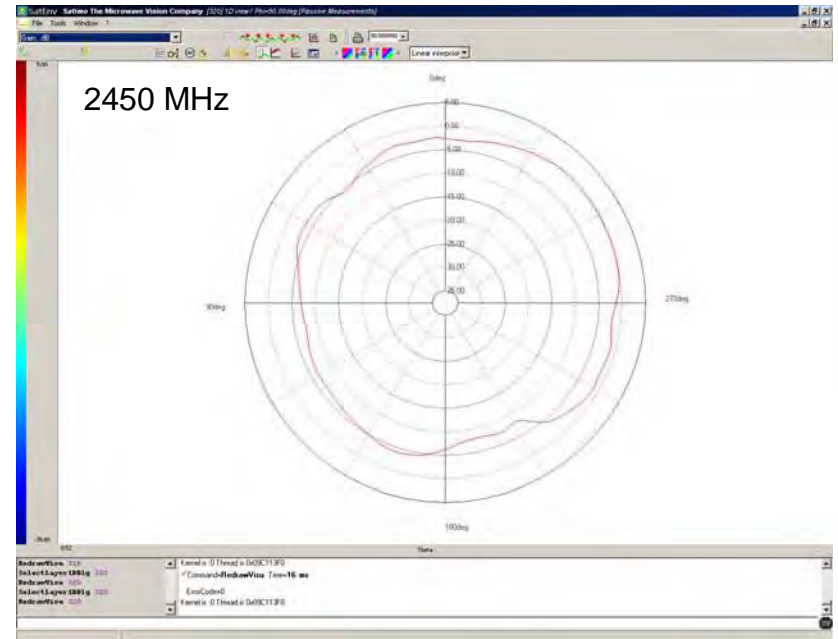
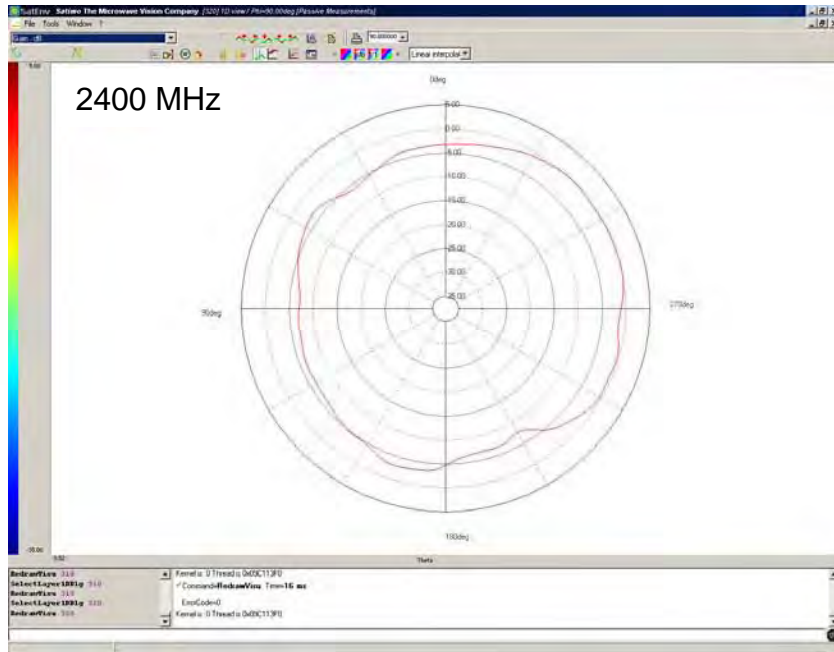

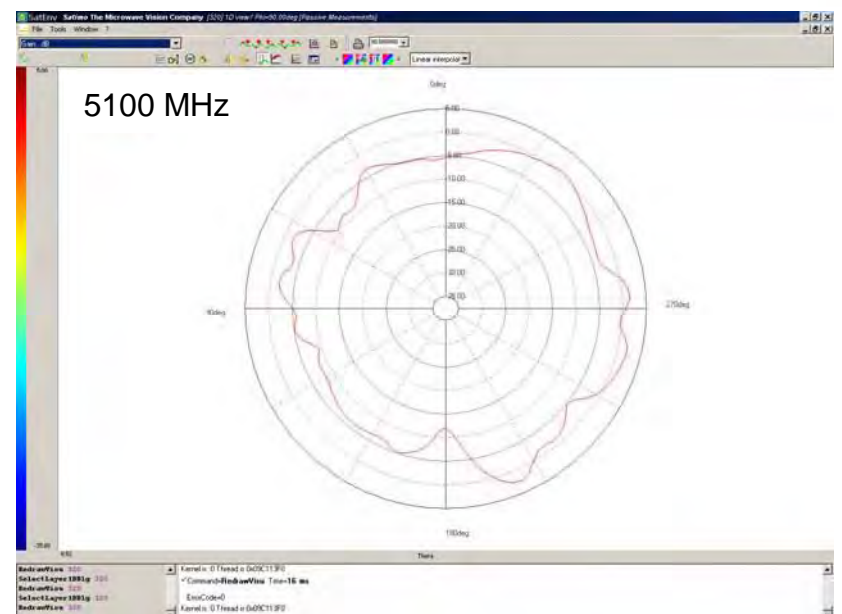
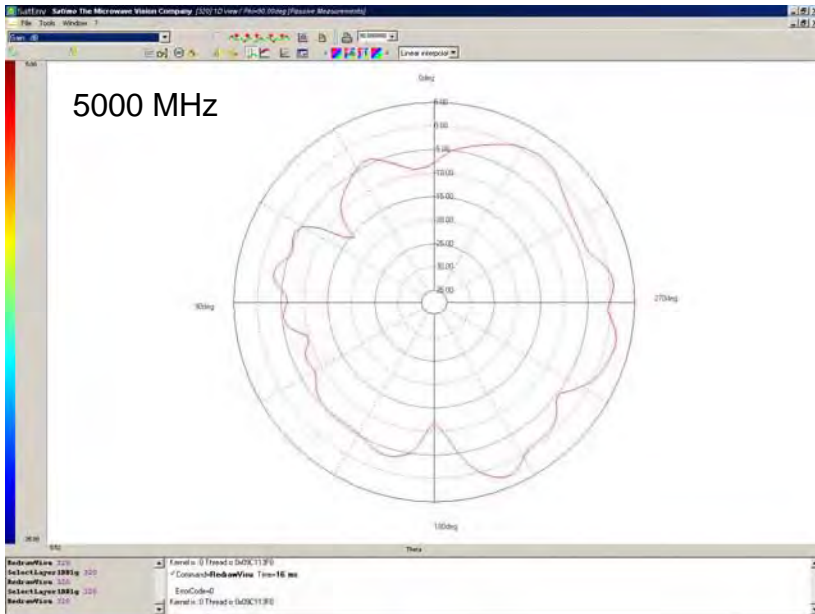
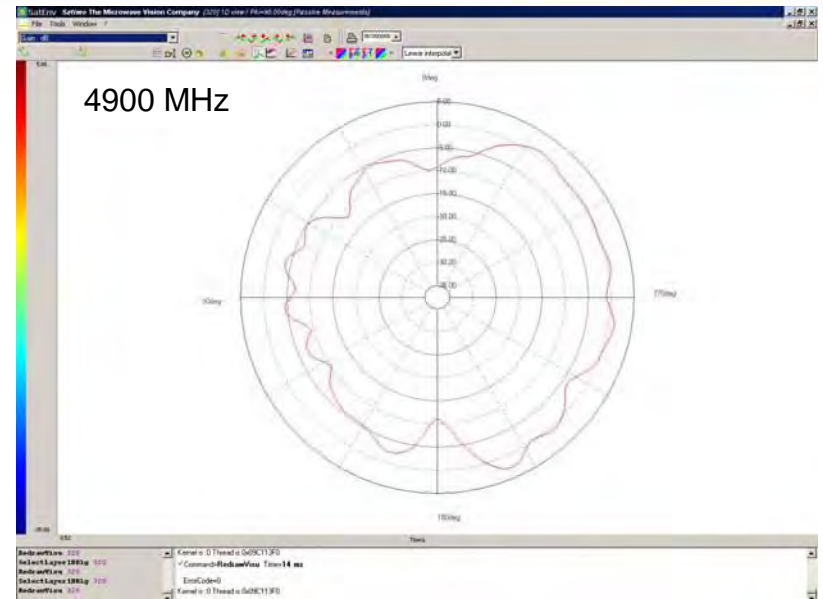
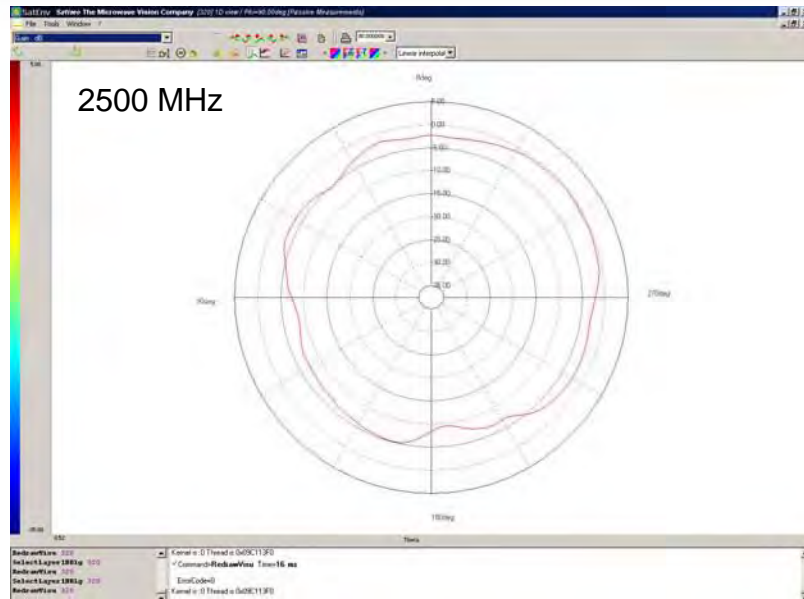

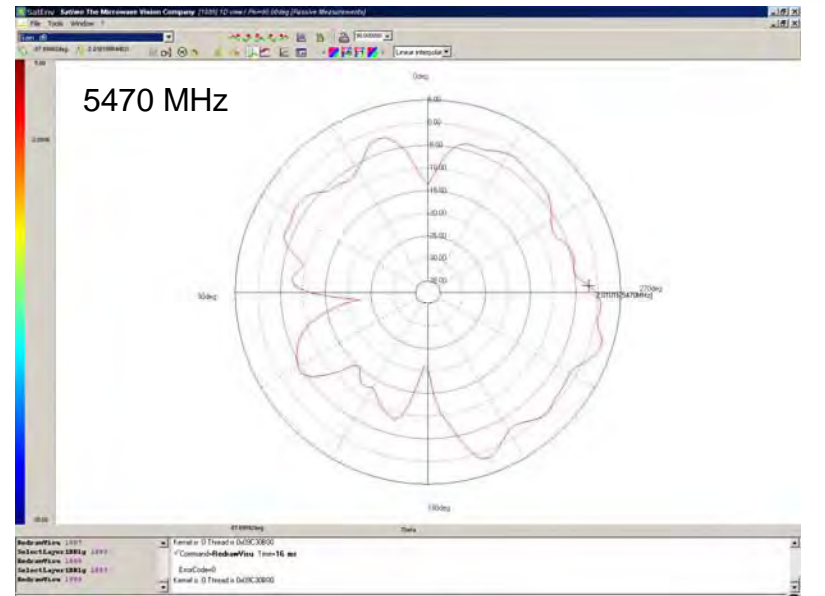
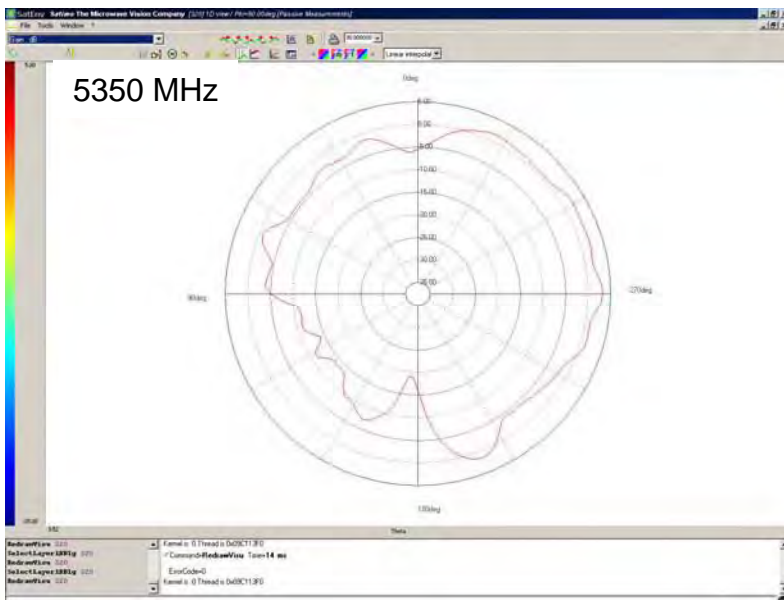
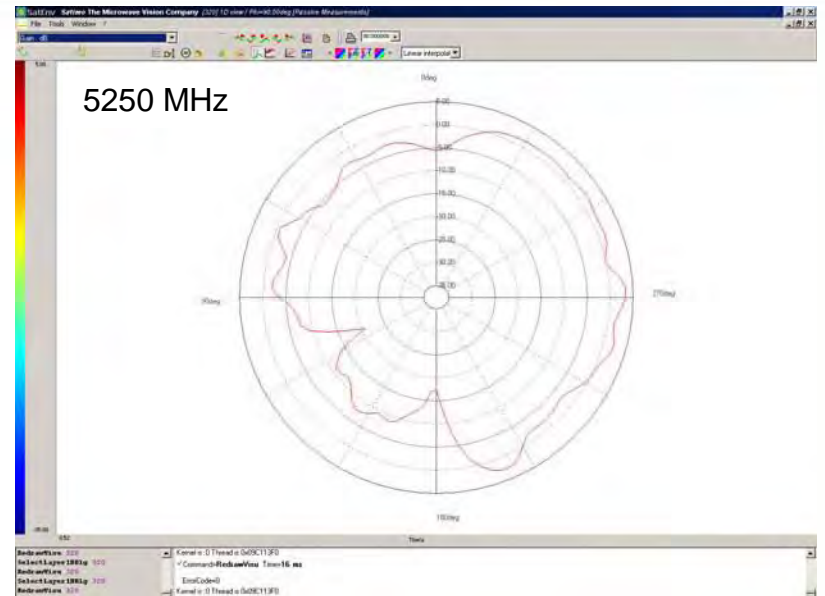
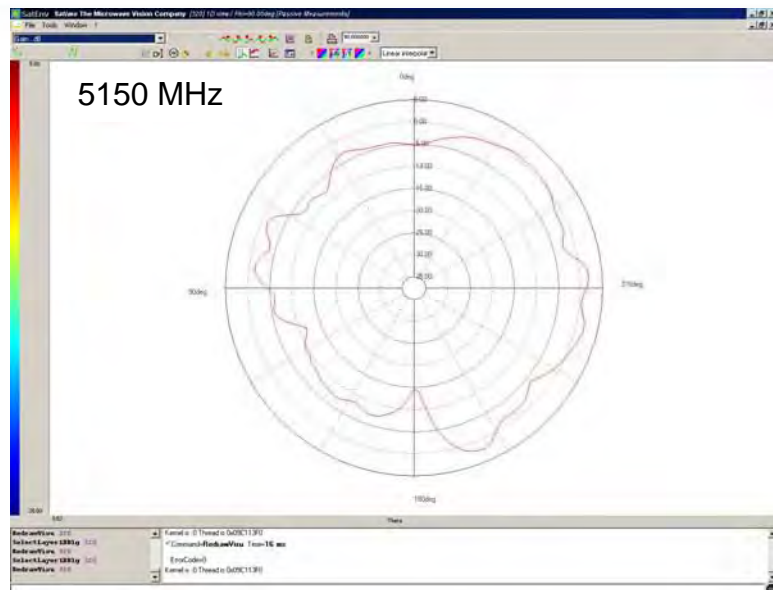

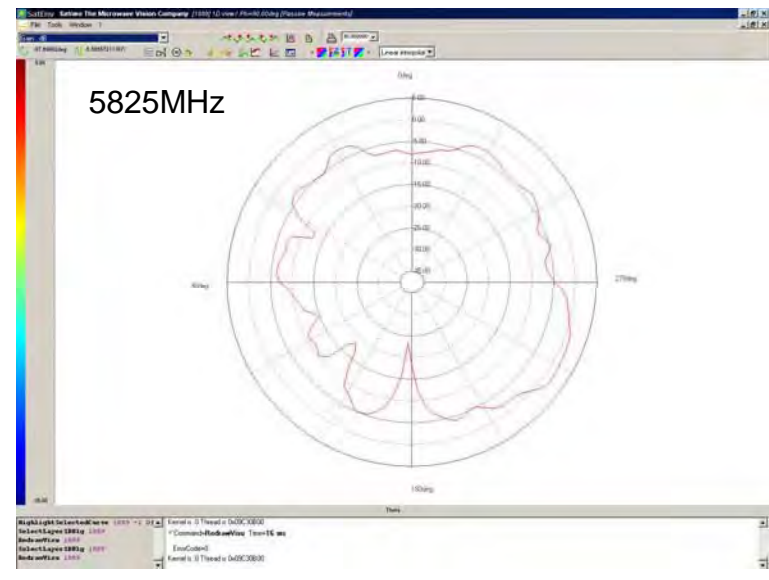
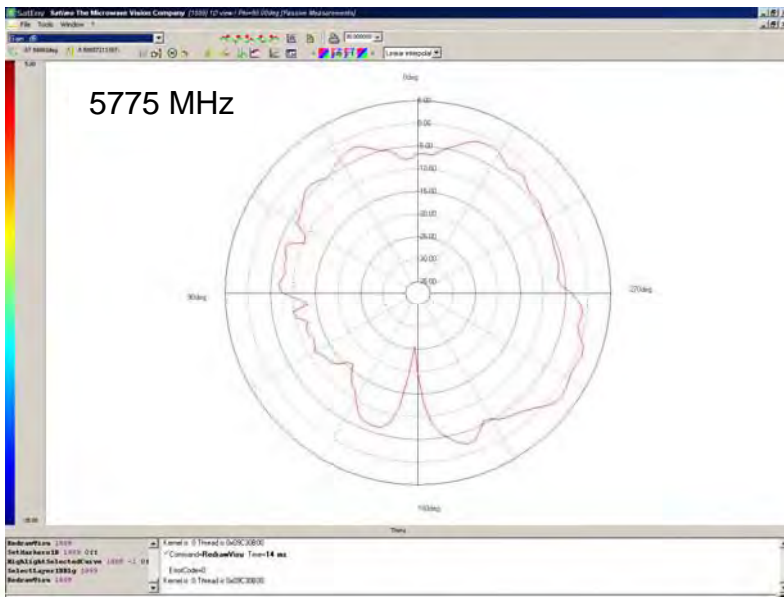
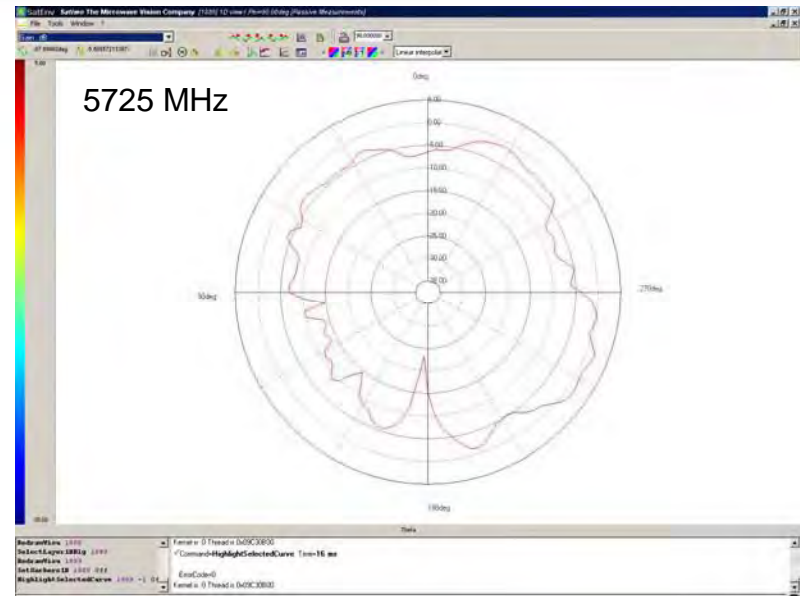
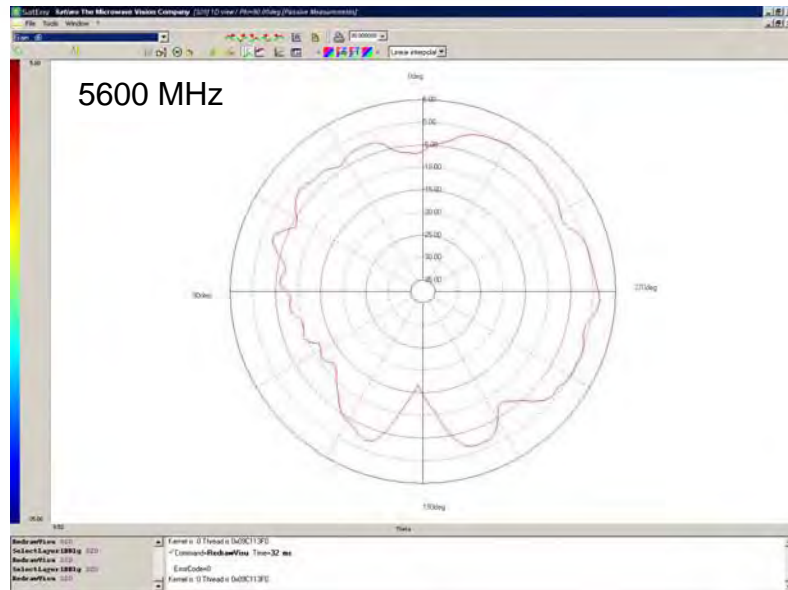

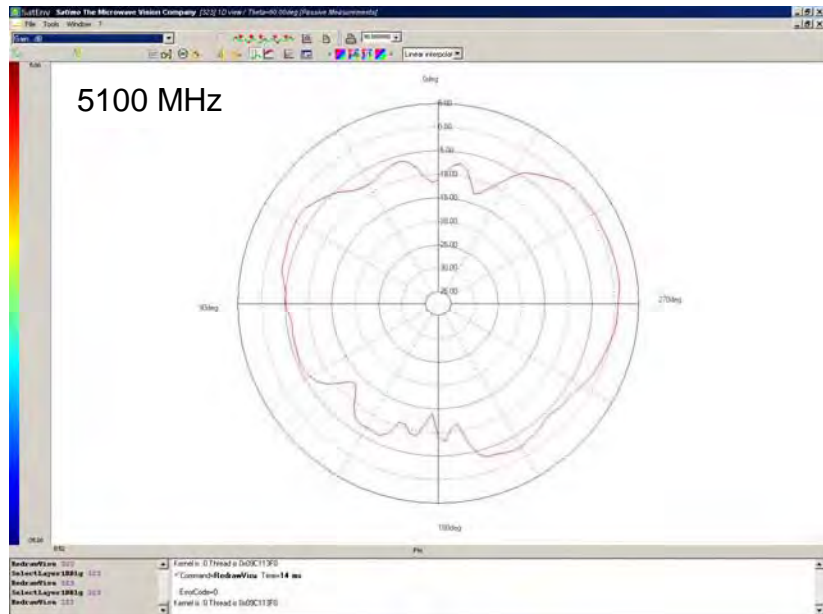
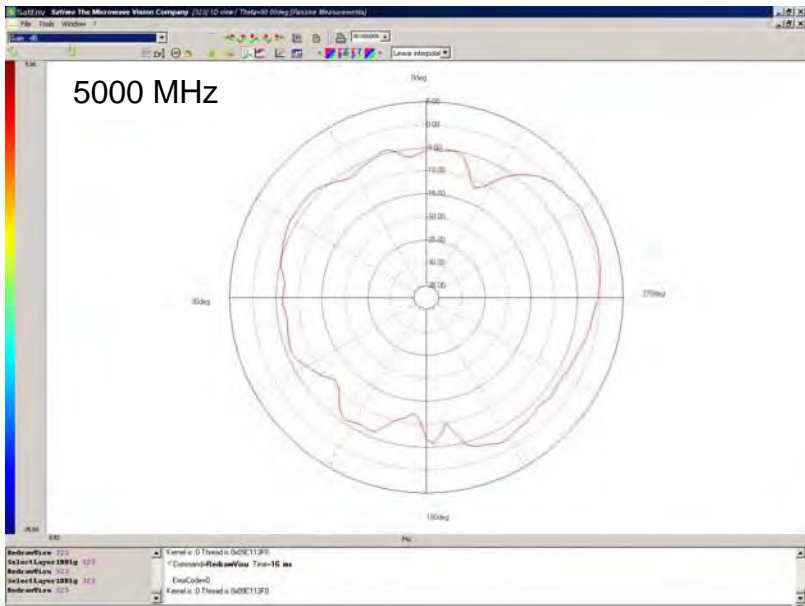
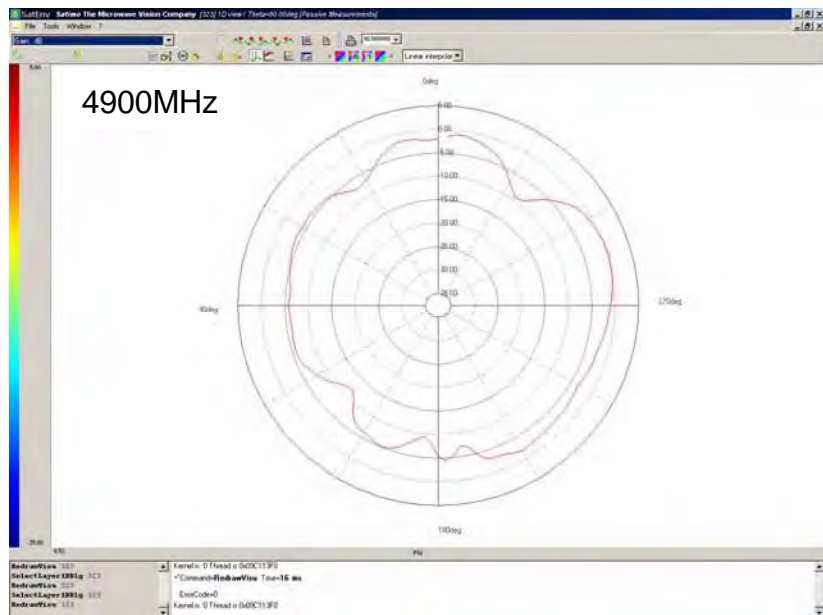
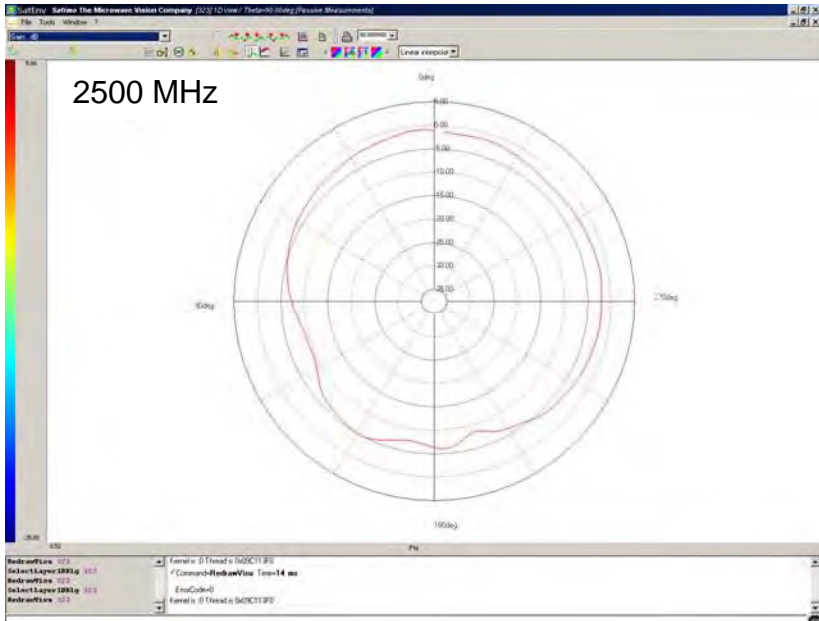

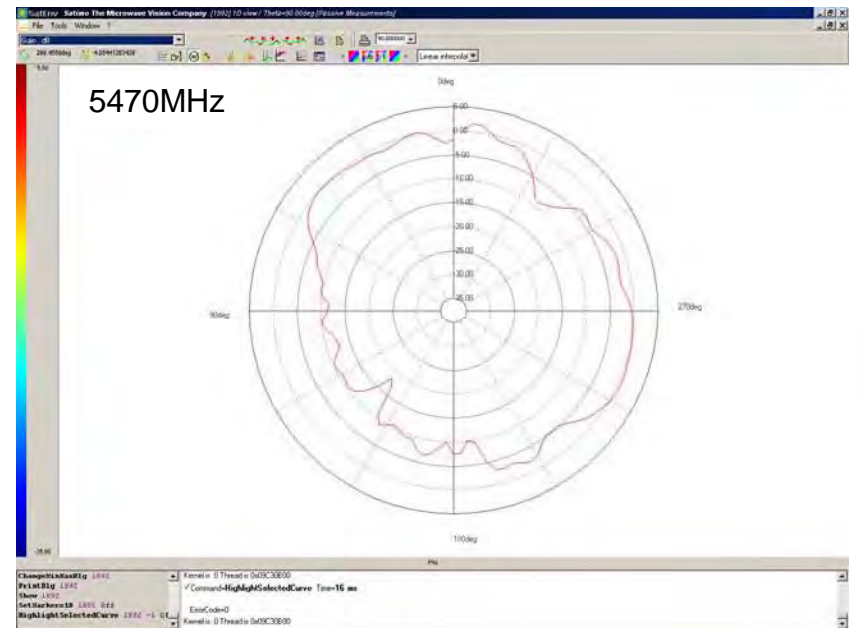
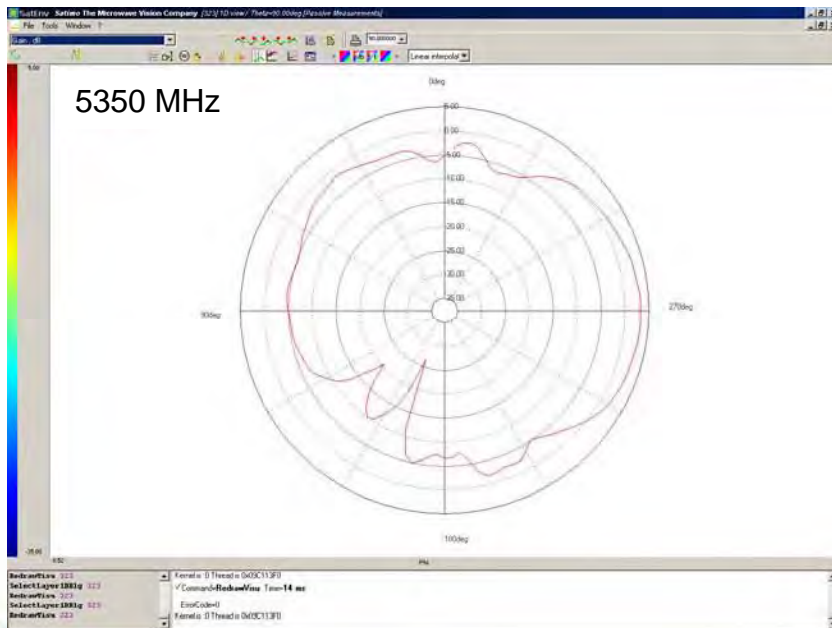
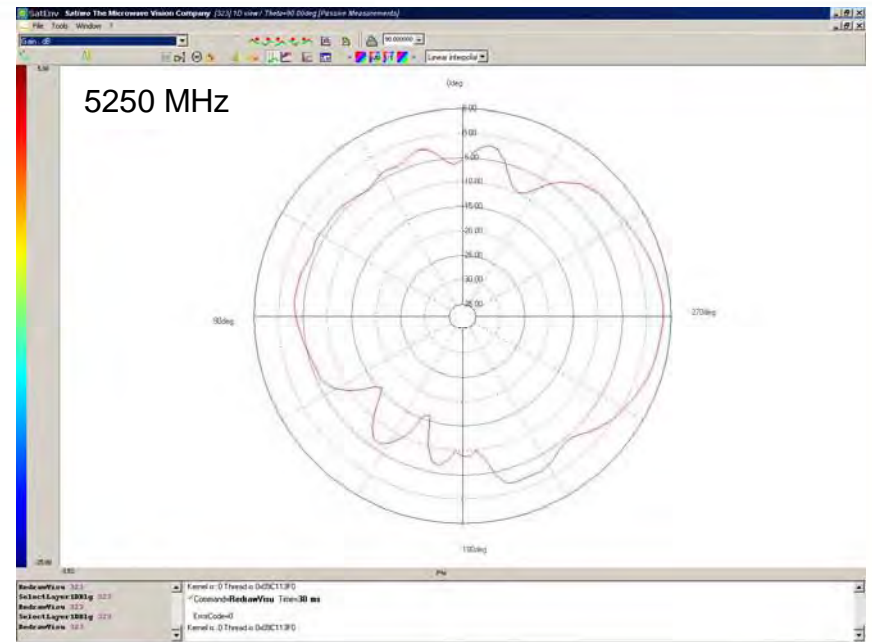
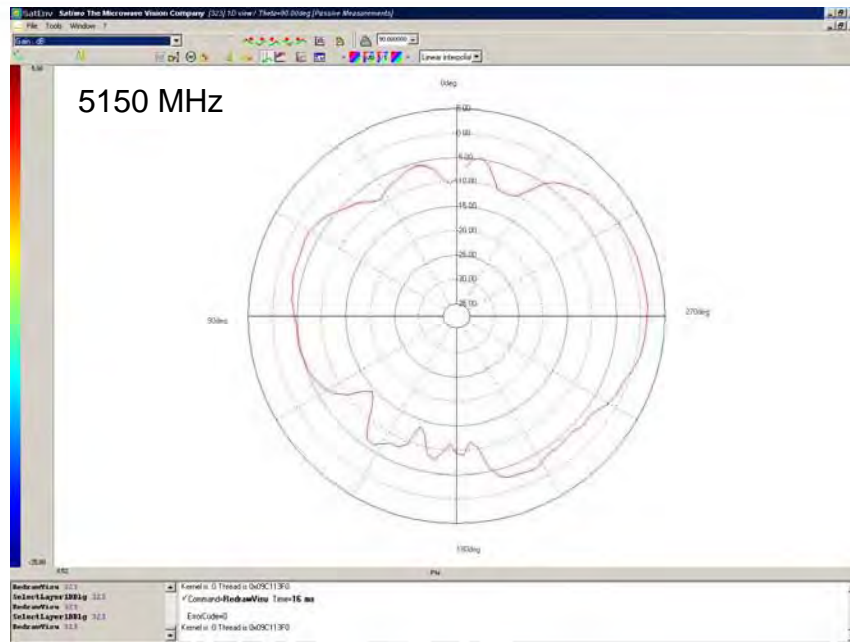

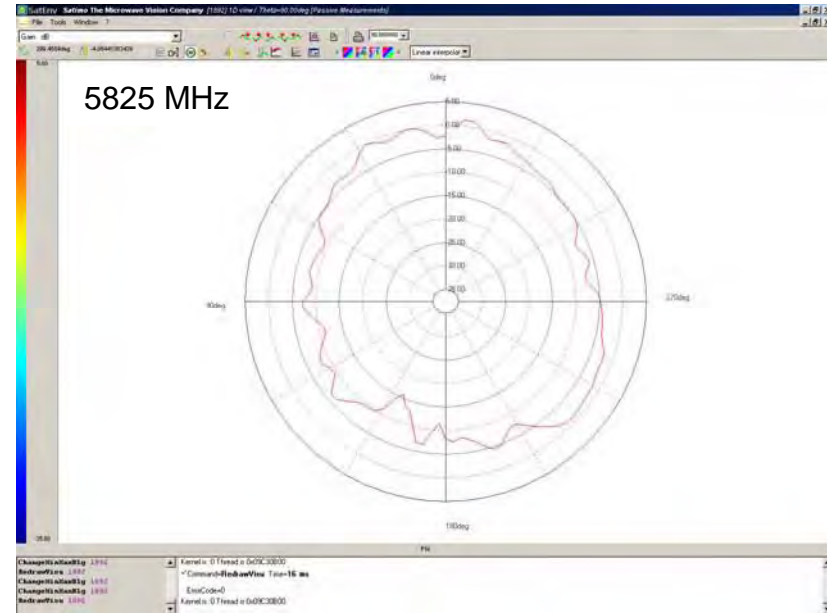
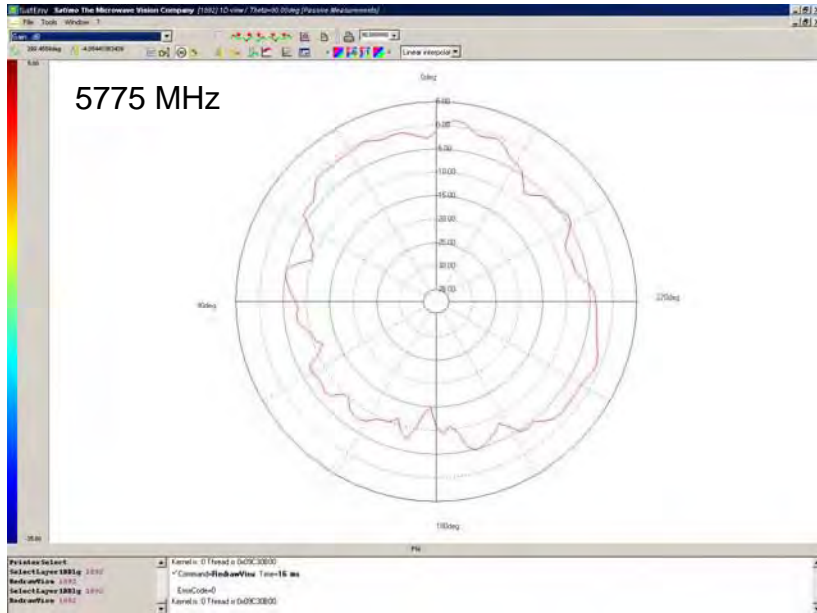
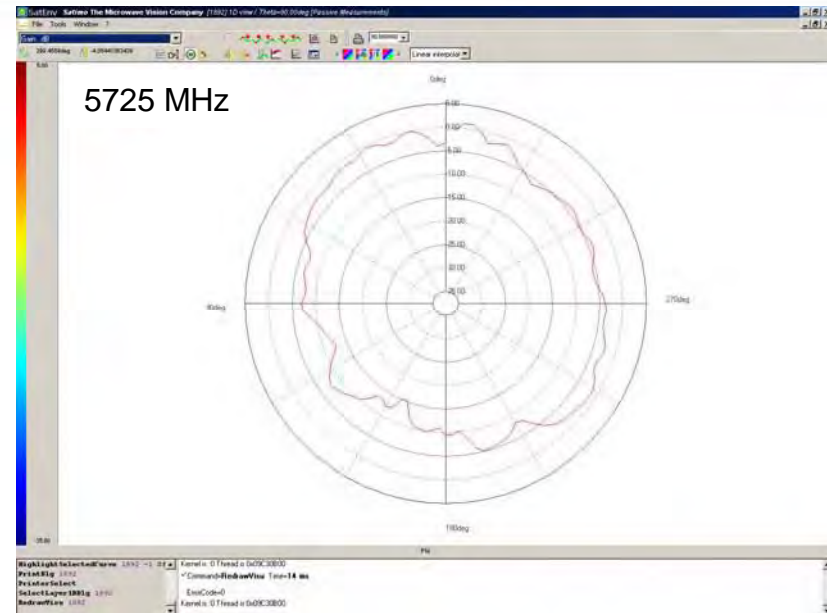
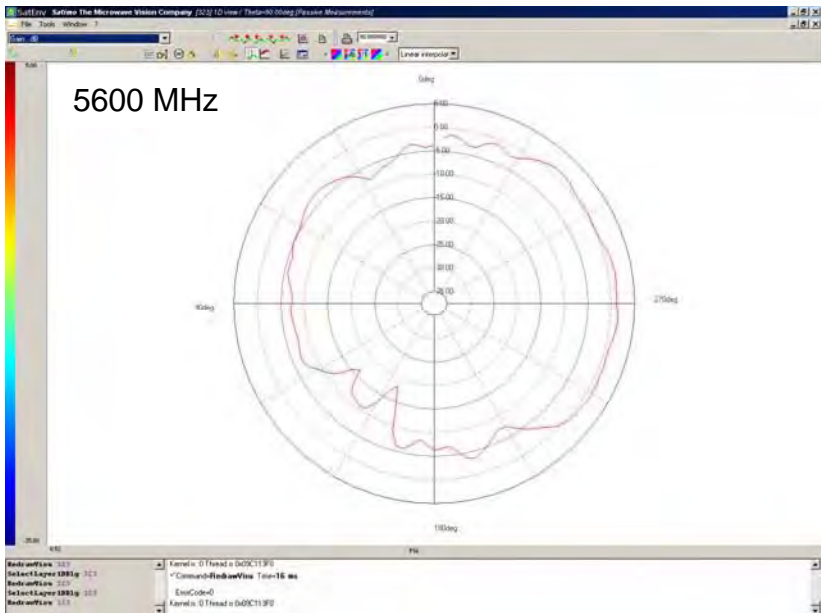



CK3 Antenna Report Bluetooth Antenna

05/19/2008 Intermec Radio Integration Team



Pattern data covers the following frequencies in MHz: 2400, 2450, 2500



Technologies Corporation

Gain, Radiation Patterns for Bluetooth Antenna Intermec Technologies Model CK3

Background:

- 1. All measurements were taken using the CK3 engineering fixture.**
- 2. Return loss and VSWR are measured using Agilent Technologies E5071B network analyzer.**
- 3. Peak gain, average gain and radiation patterns in the 3 principle planes are measured with SATIMO 3D 64 STARGATE anechoic chamber.**
- 4. Data Supplied by Laird Technologies.**

Antenna:

Manufacturer: Laird Technologies

Antenna Type: Bluetooth, Internal Monopole / Meander Line

Coordinate System for the Measurement of BT Antenna

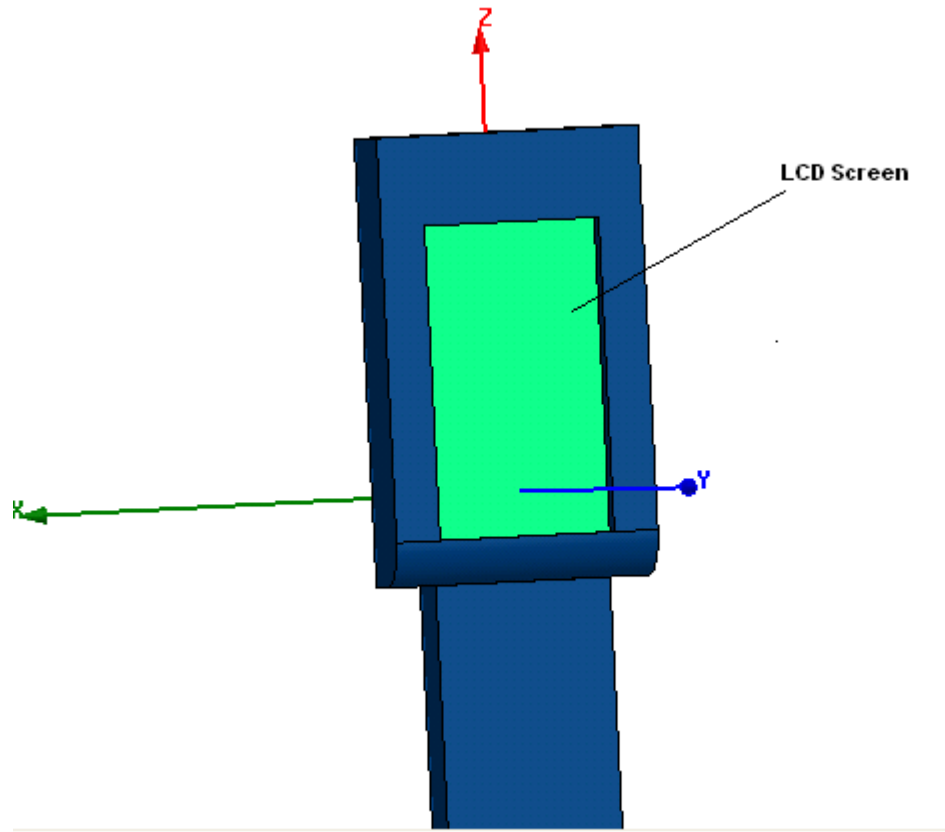

LCD screen is facing the positive Y Direction

BT Antenna

Measured Return Loss for Blue Tooth Antenna

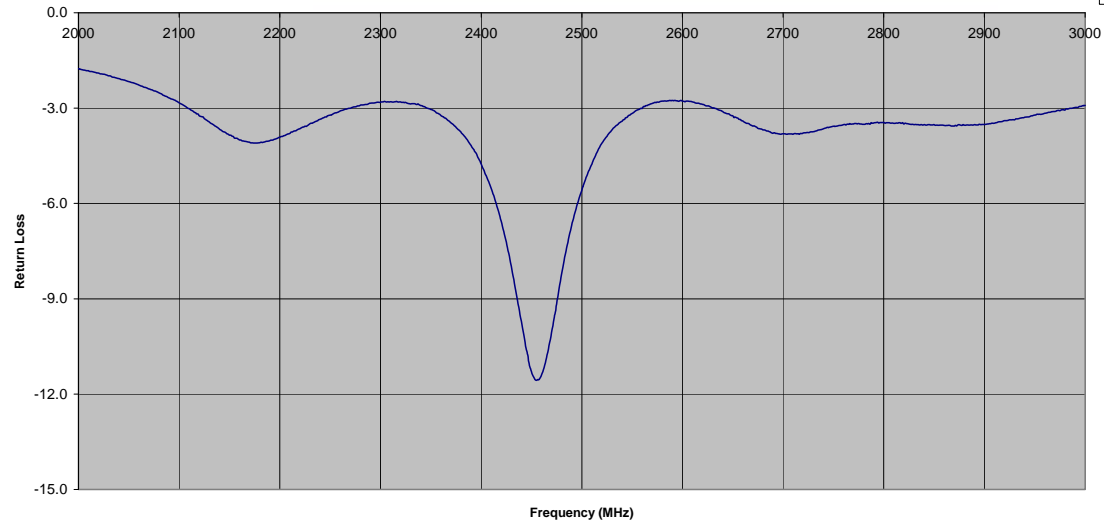

BT Antenna

Measured VSWR for Blue Tooth Antenna

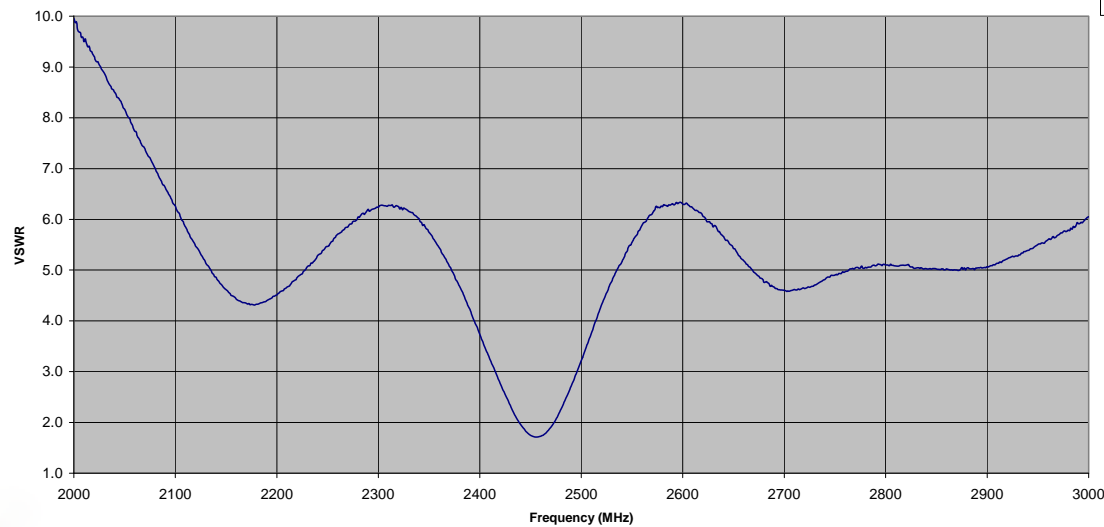

Snap Shot of Measured VSWR for Blue Tooth Antenna

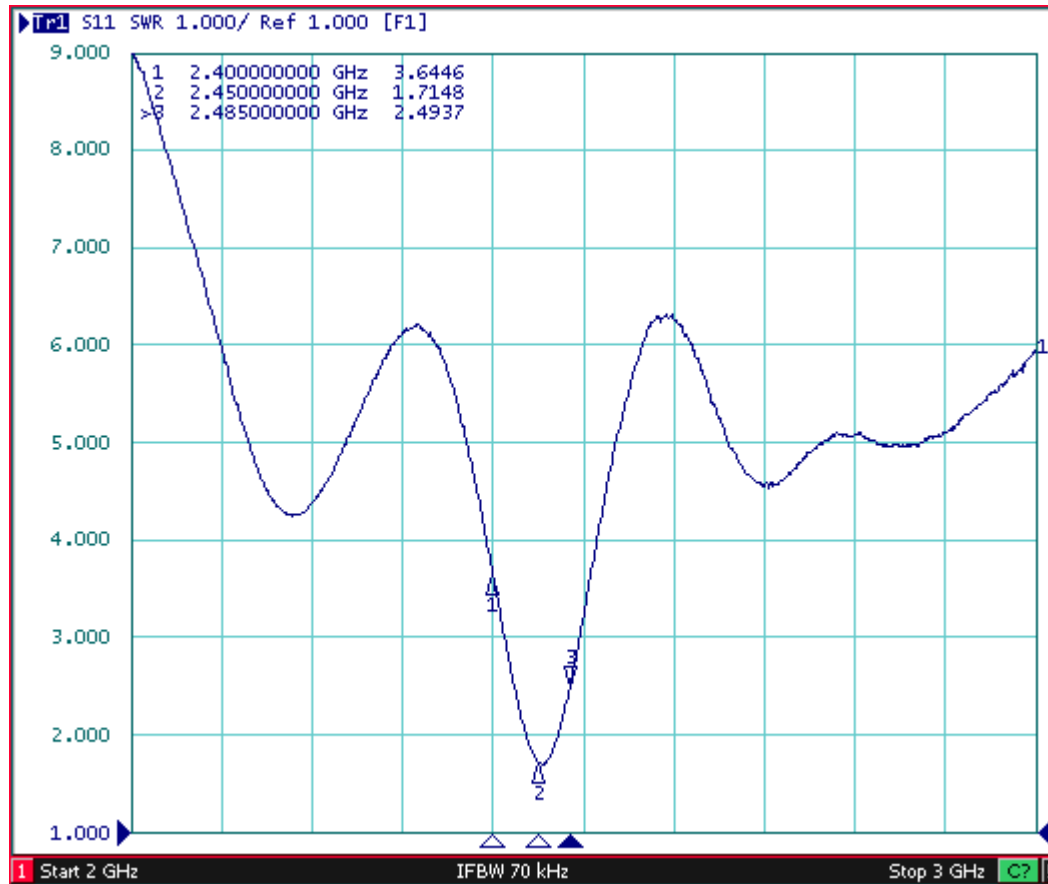

Radiation Efficiency for BT Assembly

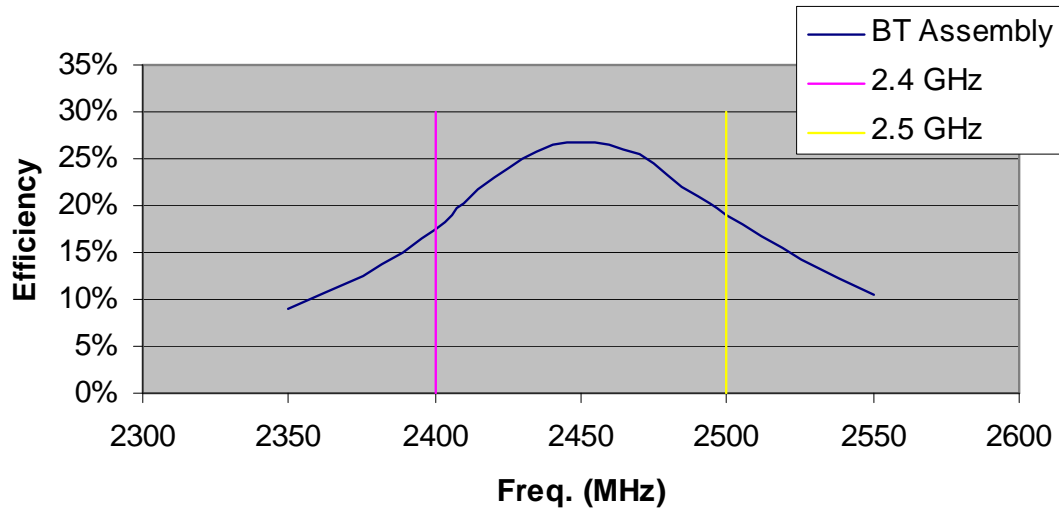

Average Gain for BT Assembly

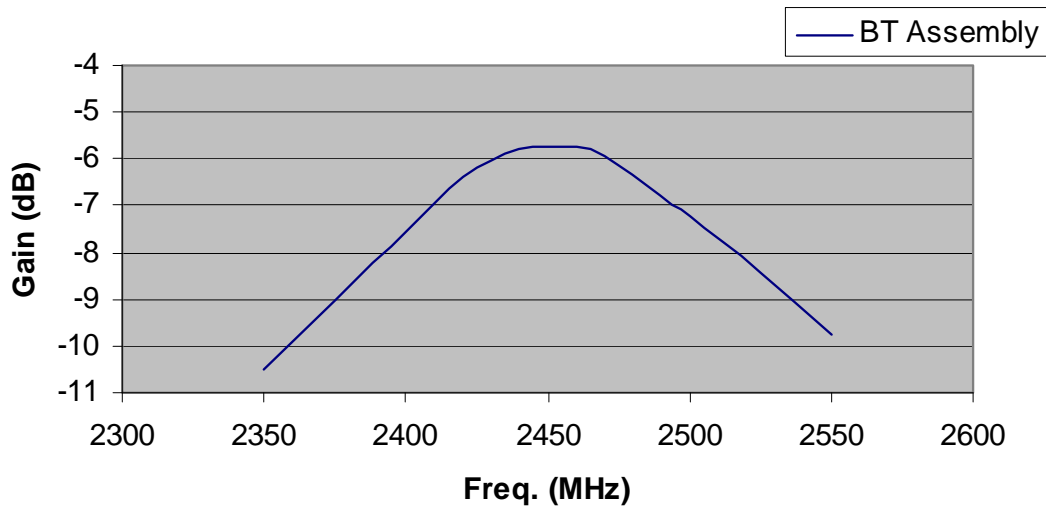

Peak Gain for BT Assembly

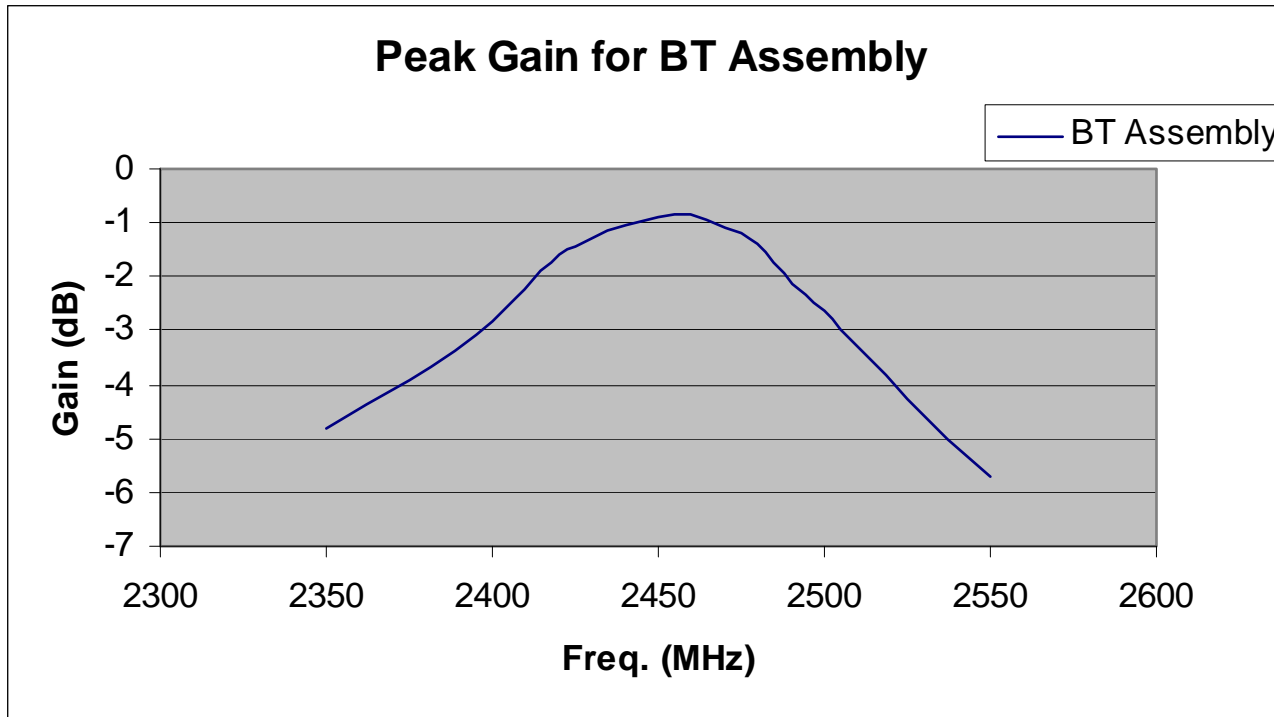

Phi = 0

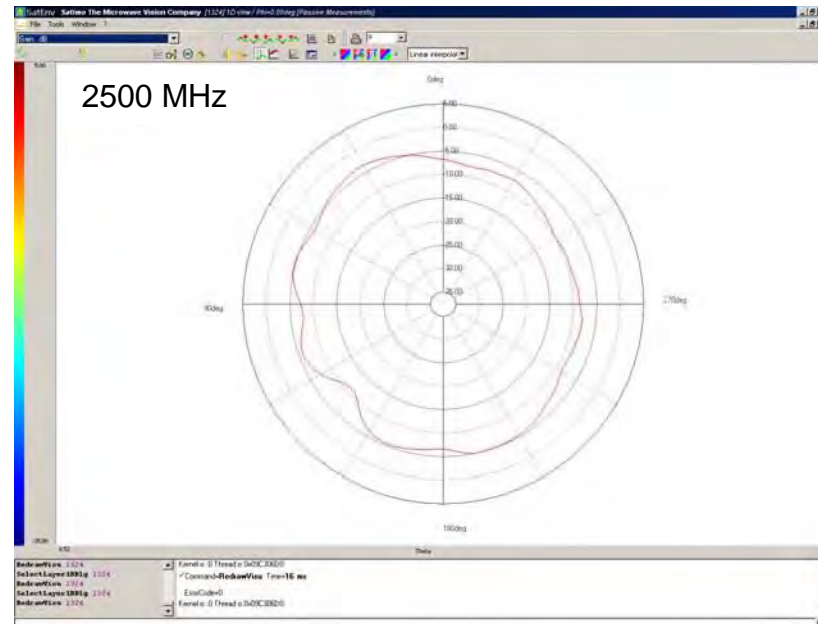
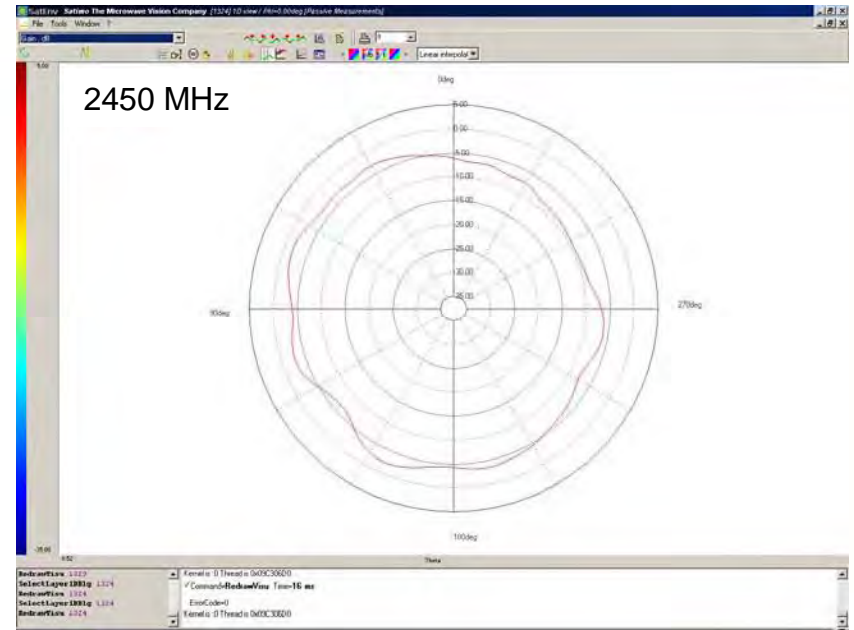
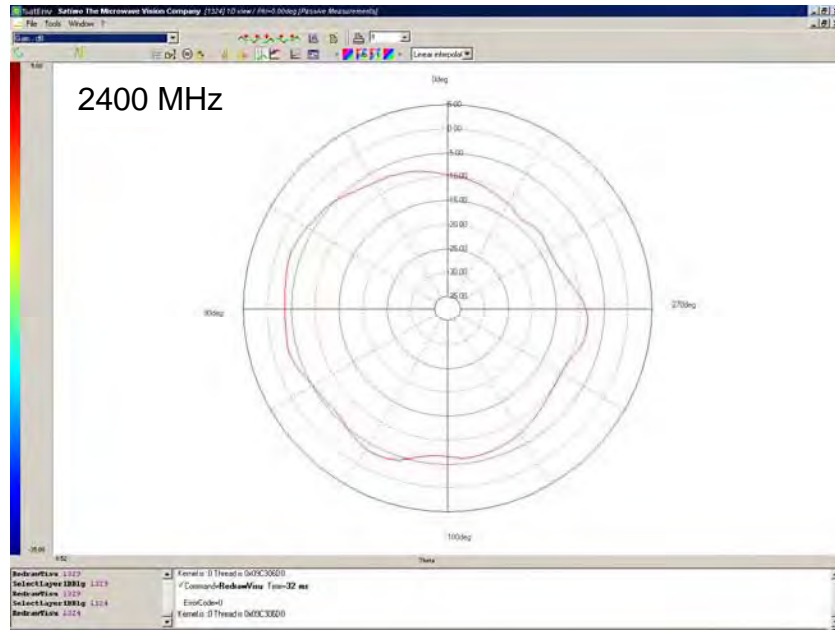

Phi = 90

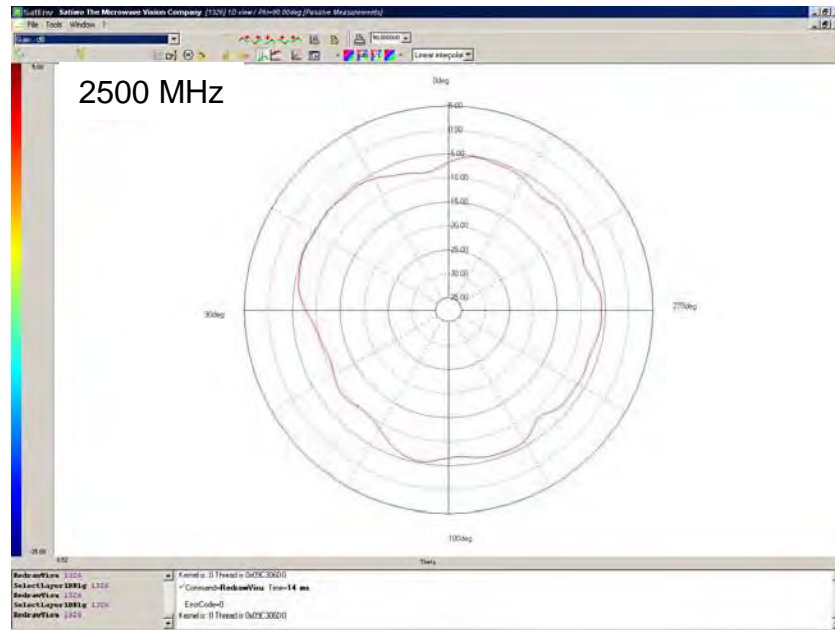
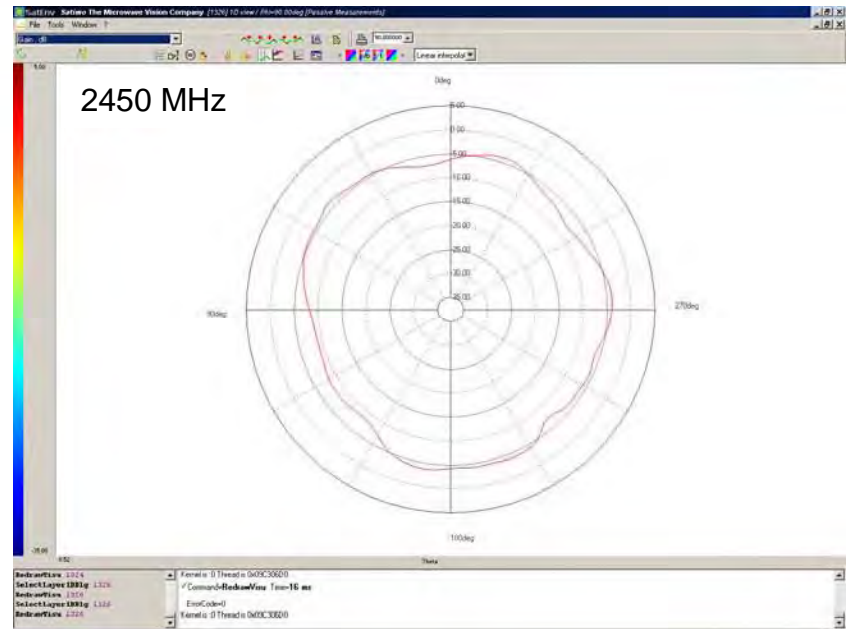
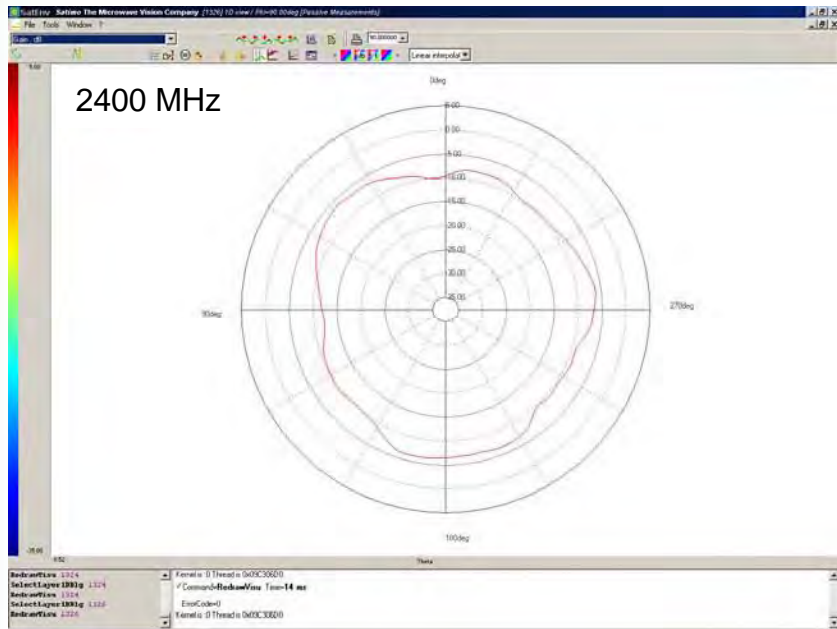

Theta = 90

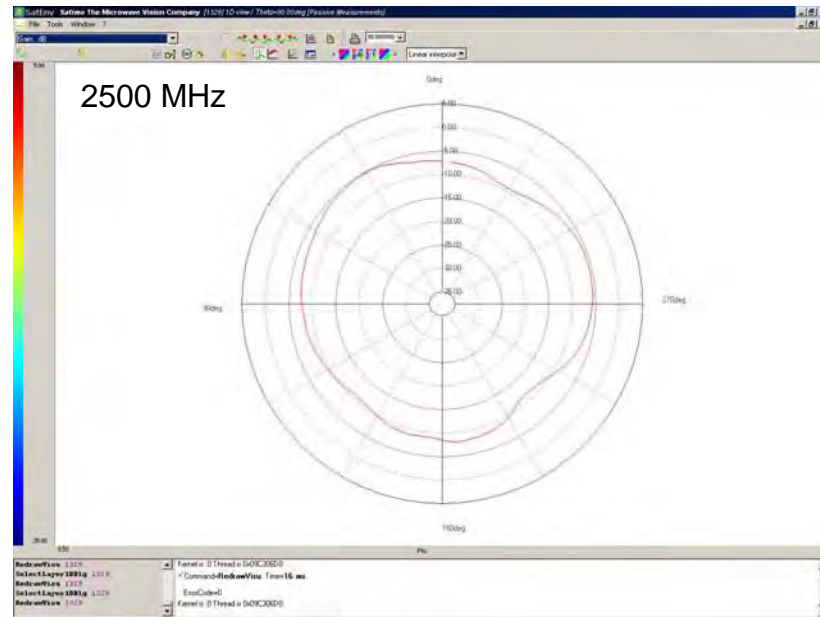
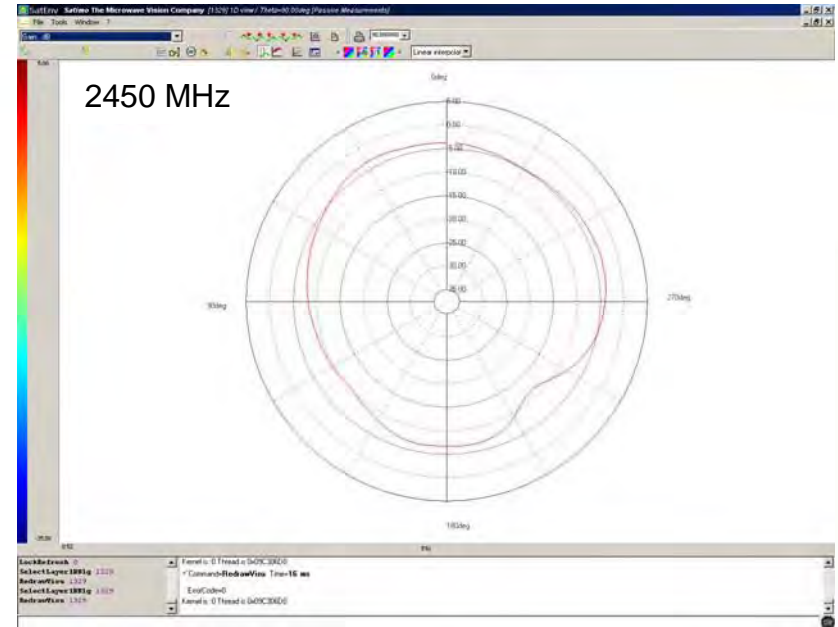
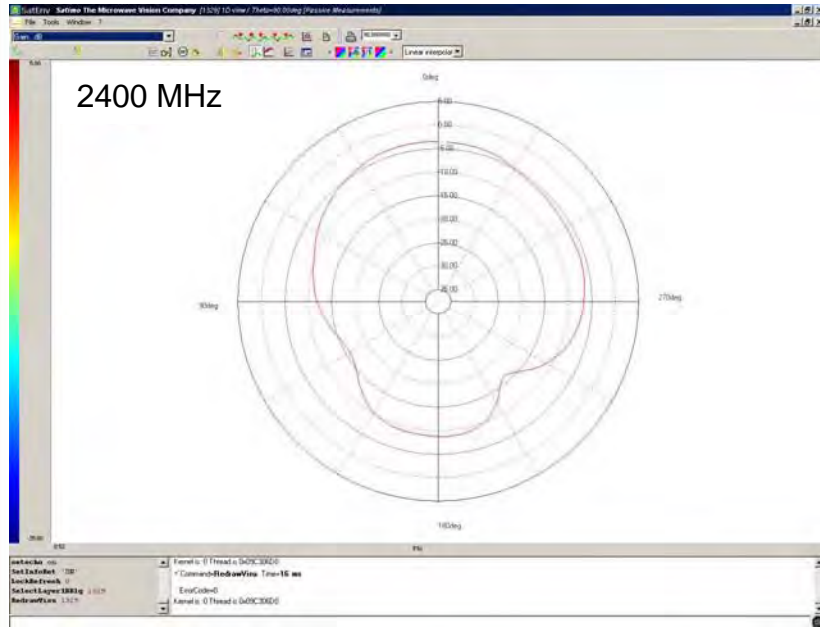



CK3 Antenna Report Pictures

05/19/2008 Intermec Radio Integration Team



Pattern data covers the following frequencies in MHz: 2400, 2450, 2500

Main 802.11a/b/g antenna under front plastic

Diversity 802.11a/b/g antenna under back plastic

Bluetooth antenna under back plastic



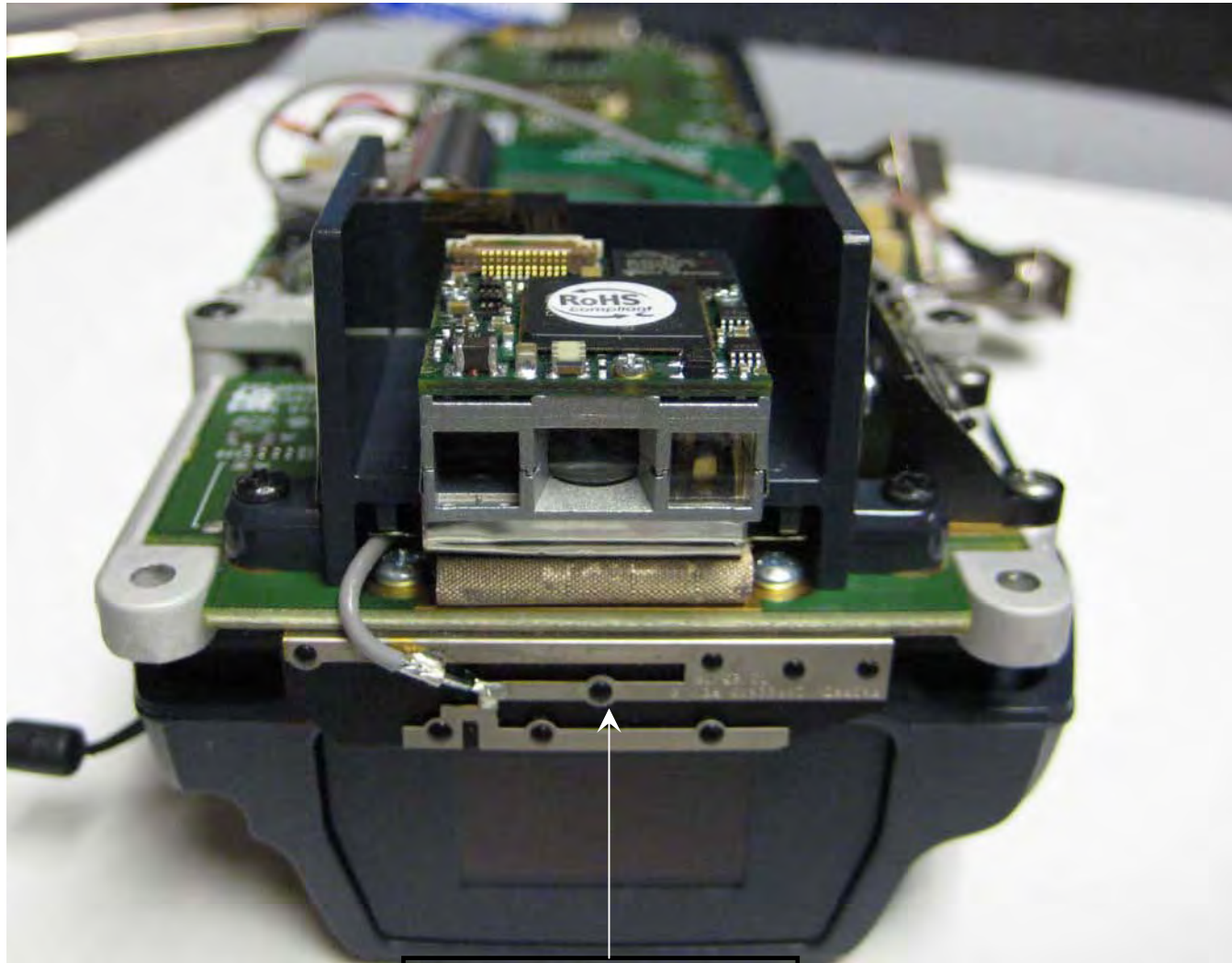

Main 802.11a/b/g antenna

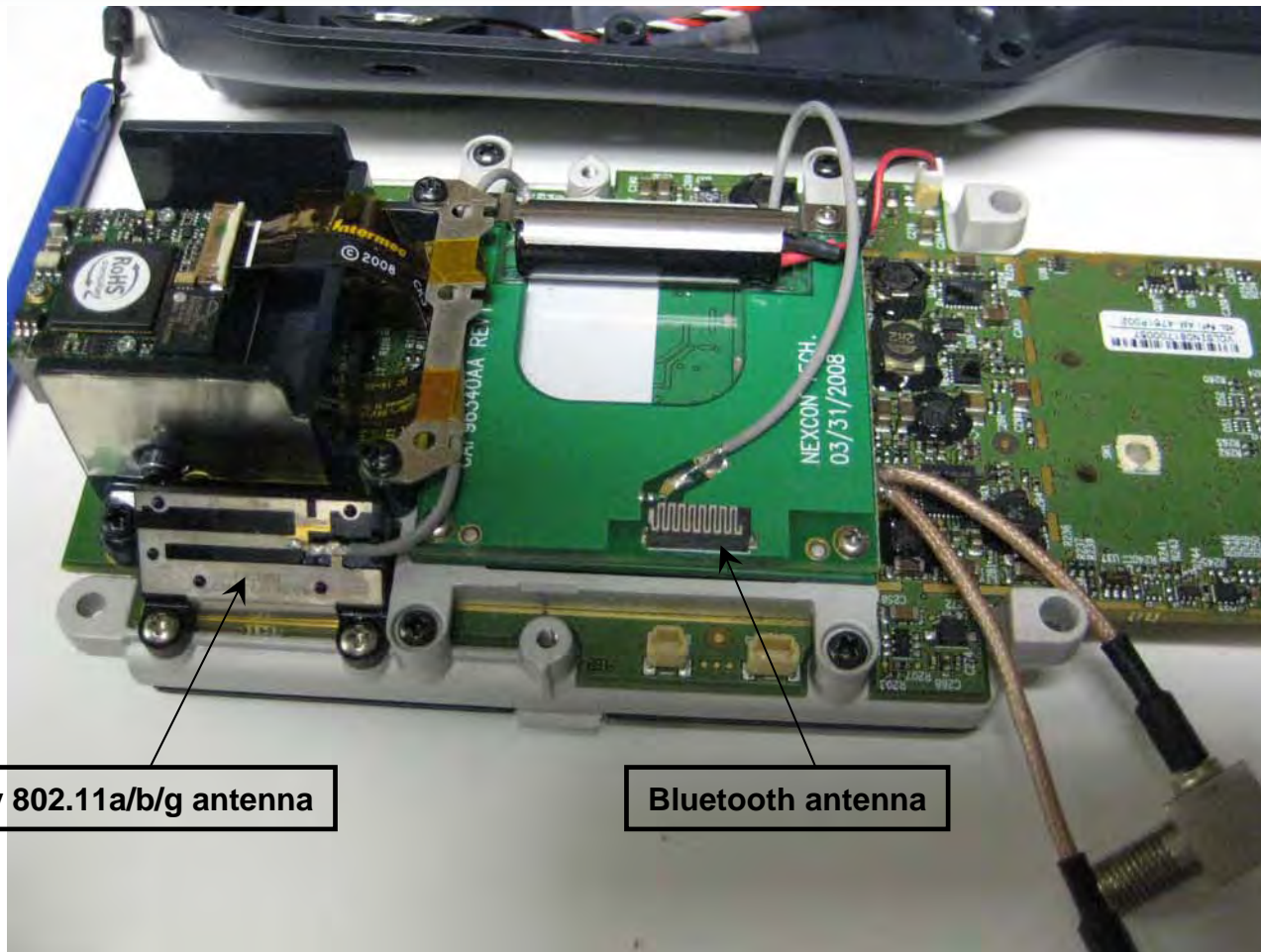

Diversity 802.11a/b/g antenna

Bluetooth antenna