

FCC TEST REPORT

according to

FCC Rules and Regulations

Part 15 Subpart C

| | |
|------------|---|
| Applicant | Socket Communications, Inc. |
| Address | 37400 Central Court Newark, CA 94560 U.S.A. |
| Equipment | KwikBlue4 Class 1 BC04 Bluetooth Module |
| Model No. | KwikBlue4-1 |
| FCC ID | LUBBTM-4 |
| Trade Name | Socket |

Laboratory Accreditation



1332

- The test result refers exclusively to the test presented test model / sample.,
- Without written approval of **Exclusive Certification Corp.** the test report shall not be reproduced except in full.
- The EUT is also considered as a kind of computer peripheral, because the connection to computer is necessary for typical use. It has been verified to comply with the requirements of FCC Part 15, Subpart B, Class B (DoC). The test report has been issued separately.

Contents

| | |
|--|----------------|
| CERTIFICATE OF COMPLIANCE..... | 3 |
| 1. Report of Measurements and Examinations | 4 |
| 1.1 List of Measurements and Examinations | 4 |
| 2. Test Configuration of Equipment under Test | 5 |
| 2.1 Feature of Equipment under Test | 5 |
| 2.2 RF Module Specifications | 5 |
| 2.3 Test Mode and Test Software..... | 6 |
| 2.4 Description of Test System | 6 |
| 2.5 Connection Diagram of Test System | 7 |
| 2.6 General Information of Test | 8 |
| 2.7 History of this test report | 8 |
| 3. Antenna Requirements | 9 |
| 3.1 Standard Applicable | 9 |
| 3.2 Antenna Construction and Directional Gain | 9 |
| 4. Test of Conducted Emission | 10 |
| 4.1 Test Limit | 10 |
| 4.2 Test Procedures | 10 |
| 4.3 Typical Test Setup | 11 |
| 4.4 Measurement equipment | 11 |
| 4.5 Test Result and Data..... | 12 |
| 5. Test of Radiated Emission | 19 |
| 5.1 Test Limit | 19 |
| 5.2 Test Procedures | 20 |
| 5.3 Typical Test Setup..... | 21 |
| 5.4 Measurement equipment | 21 |
| 5.5 Test Result and Data..... | 22 |
| 5.6 Channel Carrier Frequencies Separation | 33 |
| 5.7 20dB Bandwidth Measurement Data | 36 |
| 5.8 Dwell Time | 39 |
| 5.9 Number of Hopping Channels..... | 43 |
| 5.10 Peak Output Power Measurement Data | 45 |
| 5.11 Band Edges Measurement Data | 48 |
| Appendix A. Photographs of EUT..... | A1 ~ A2 |

CERTIFICATE OF COMPLIANCE

according to

FCC Rules and Regulations

Part 15 Subpart C

| | |
|-----------|---|
| Applicant | Socket Communications, Inc. |
| Address | 37400 Central Court Newark, CA 94560 U.S.A. |
| Equipment | KwikBlue4 Class 1 BC04 Bluetooth Module |
| Model No. | KwikBlue4-1 |
| FCC ID | LUBBTM-4 |

I HEREBY CERTIFY THAT :

The measurements shown in this test report were made in accordance with the procedures given in **ANSI C63.4**. The equipment was **passed** the test performed according to **FCC Rules and Regulations Part 15 Subpart C (2003)**. The test was carried out on Jun. 07, 2005 at *Exclusive Certification Corp.*

Signature

Anson Chou / Manager

1. Report of Measurements and Examinations

1.1 List of Measurements and Examinations

| FCC Rule | Description of Test | Result |
|-------------------|---|--------|
| 15.203 | . Antenna Requirement | Pass |
| 15.207 | . Conducted Emission | Pass |
| 15.209 | . Radiated Emission | Pass |
| 15.247(a)(1)(iii) | . Channel Carrier Frequencies Separation | Pass |
| 15.247(a)(1) | . 20dB Bandwidth Measurement | Pass |
| 15.247(a)(1)(iii) | . Dwell Time | Pass |
| 15.247(b)(1) | . Number of Hopping Channels | Pass |
| 15.247(b) | . Peak Output Power Measurement Data | Pass |
| 15.247(c) | . Band Edges Measurement Data | Pass |
| 15.247(d) | . Power Spectral Density Measurement Data | Pass |

Test engineer:

Jerry

2. Test Configuration of Equipment under Test

2.1 Feature of Equipment under Test

Power Level +15 dBm Max.
Program Memory 8 Mbits (512k x 16 bits) Flash
RAM 32k bytes x 16 bits
Reference Oscillator Built-in
Sub Clock Oscillator Built-in
Audio Interface PCM A-Law, μ -Law (CVSD)
Serial Data Interface UART (BCSP of H:4)
USB Interface USB 1.1 (OHCI and UHCI)
Physical Connection Board-to-board connection – solder down

2.2 RF Module Specifications

Operating Frequency 2400 MHz to 2483.5 MHz
Carrier Spacing 1.0 MHz
Channel 79
Duplexing TDD
Symbol Rate (Std data rate) 1 Mbps
Symbol Rate (EDR data rate) 2 & 3 Mbps
Modulation Method (Std data rate) GFSK BbT = 0.5
Modulation Method (EDR data rate) DQPSK & D8PSK
Reference Oscillator 16 MHz (built in)
RF input and output impedance Nominal 50 ohm

2.3 Test Mode and Test Software

The following test mode and test software was performed for conduction and radiation test:

- 802.11b (CH LO: 2412MHz) • 802.11b (CH MID: 2437MHz) • 802.11b (CH HI: 2462MHz)
- 802.11g (CH LO: 2412MHz) • 802.11g (CH MID: 2437MHz) • 802.11g (CH HI: 2462MHz)
- An executive programs, "Internet Explorer.EXE" Application under WIN XP.

2.4 Description of Test System

| Device | Manufacturer | Model No. | Description |
|----------|--------------|-------------|--|
| PC | IBM | IGV | Power Cable, Adapter Unshielding 1.8 m |
| Monitor | SlimAGE | 510A | Power Cable, Adapter Unshielding 1.8 m Data Cable, VGA, shielding 1.35 m |
| Keyboard | IBM | KB-0225 | Data Cable, PS2 shielding 1.85 m |
| Mouse | IBM | MO28VO | Data Cable, USB shielding 1.85 m |
| Printer | HP | Desk Jet400 | Power Cable, Adapter Unshielding 1.8 m Data Cable, PRINT, shielding 1.6 m |
| Notebook | DELL | 510m | Power Cable, Adapter Unshielding 1.8 m |

Use Cable:

| Cable | Description |
|-----------------|------------------|
| USB | Shielding, 1.5m |
| RS232 | Shielding, 0.8m |
| Floating 25 Pin | Shielding, 1.35m |

2.5 Connection Diagram of Test System

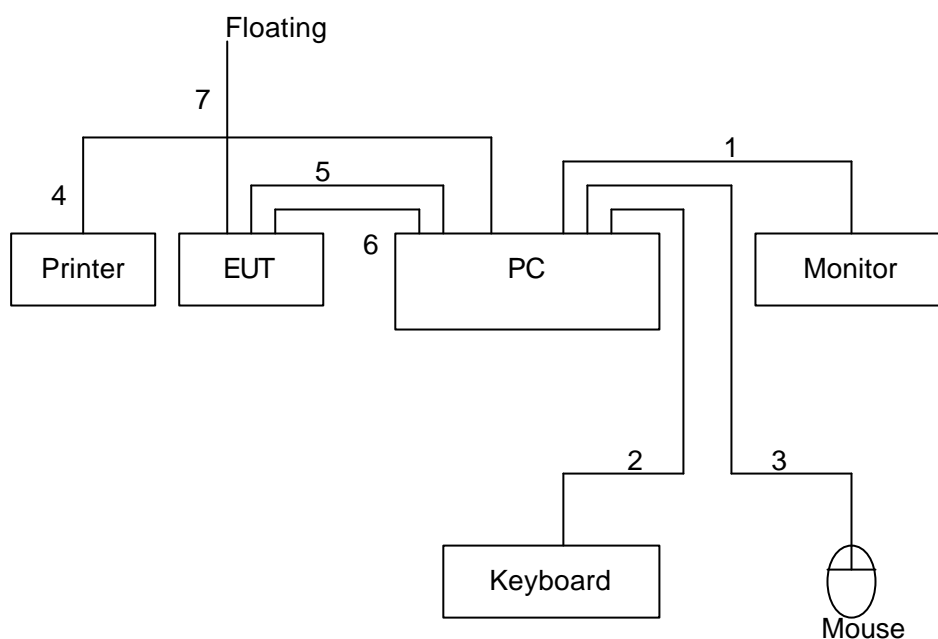

1. The I/O cable is connected from PC to the Monitor.
2. The I/O cable is connected from PC to the Keyboard.
3. The I/O cable is connected from PC to the Mouse.
4. The I/O cable is connected from PC to the Printer.
5. The USB cable is connected from PC to the EUT.
6. The RS232 cable is connected from PC to the EUT.
7. These 25 Pin cables are floating.

2.6 General Information of Test

| | |
|--------------------------------|--|
| Test Site: | Exclusive Certification Corp. 4F-2, No. 28, Lane 78, Xing-Ai Rd. Nei-hu, Taipei City 114 Taiwan R.O.C. |
| Test Site Location (OATS1-SD): | No.68-1, Shihbachongsi, shihding Township, Taipei County 223, Taiwan, R.O.C. |
| Test Voltage: | AC 120V/ 60Hz for PC |
| Test in Compliance with: | ANSI C63.4-2003 FCC Part 15 Subpart C |
| Frequency Range Investigated: | Conducted: from 150kHz to 30 MHz Radiation: from 30 MHz to 24620MHz |
| Test Distance: | The test distance of radiated emission from antenna to EUT is 3 M. |

2.7 History of this test report

ORIGINAL.

3. Antenna Requirements

3.1 Standard Applicable

For intentional device, according to FCC 47 CFR Section 15.203, an intentional radiator shall be designed to ensure that no antenna other than that furnished by the responsible party shall be used with the device.

And according to FCC 47 CFR Section 15.247 (b), if transmitting antennas of directional gain greater than 6dBi are used, the power shall be reduced by the amount in dB that the directional gain of the antenna exceeds 6dBi.

3.2 Antenna Construction and Directional Gain

Antenna type: The antenna is designed to be permanently on PCB, No
Consideration of replacement.

Antenna Gain: 0 dBi

4. Test of Conducted Emission

4.1 Test Limit

Conducted Emissions were measured from 150 kHz to 30 MHz with a bandwidth of 9 KHz on the 115 VAC power and return leads of the EUT according to the methods defined in ANSI C63.4-2003 Section 3.1. The EUT was placed on a nonmetallic stand in a shielded room 0.8 meters above the ground plane as shown in section 4.2. The interface cables and equipment positioning were varied within limits of reasonable applications to determine the position produced maximum conducted emissions.

| Frequency (MHz) | Quasi Peak (dB μ V) | Average (dB μ V) |
|-----------------|-------------------------|----------------------|
| 0.15 – 0.5 | 66-56* | 56-46* |
| 0.5 – 5.0 | 56 | 46 |
| 5.0 – 30.0 | 60 | 50 |

4.2 Test Procedures

- a. The EUT was placed 0.4 meter from the conducting wall of the shielding room was kept at least 80 centimeters from any other grounded conducting surface.
- b. Connect EUT to the power mains through a line impedance stabilization network (LISN).
- c. All the support units are connecting to the other LISN.
- d. The LISN provides 50 ohm coupling impedance for the measuring instrument.
- e. The FCC states that a 50 ohm, 50 micro-henry LISN should be used.
- f. Both sides of AC line were checked for maximum conducted interference.
- g. The frequency range from 150 kHz to 30 MHz was searched.
- h. Set the test-receiver system to Peak Detect Function and Specified Bandwidth with Maximum Hold Mode.

4.3 Typical Test Setup

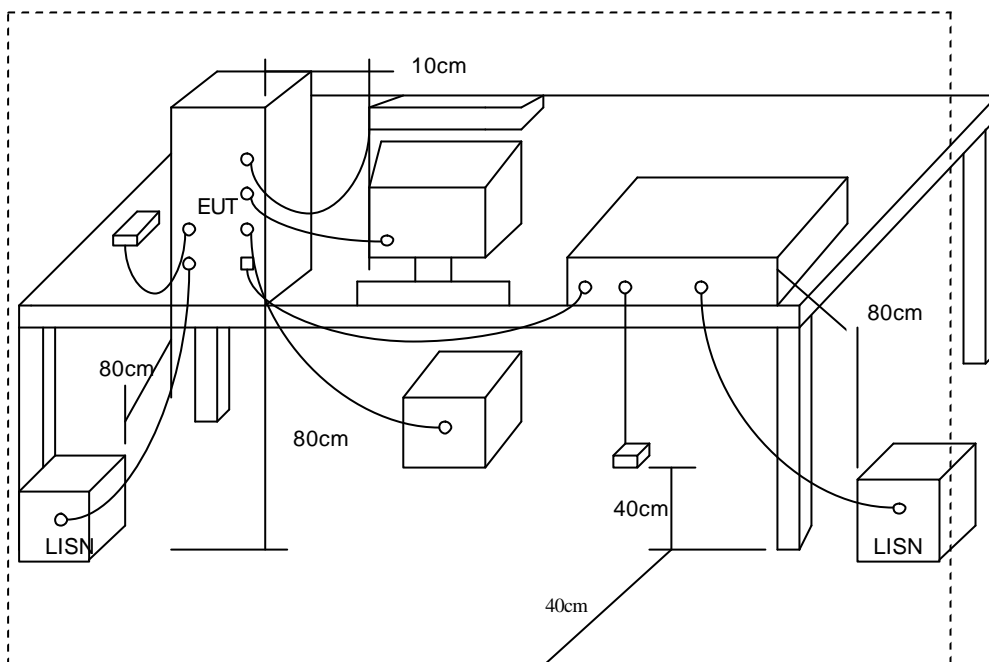

4.4 Measurement equipment

| Instrument/Ancillary | Type | Manufacturer | Valid Date. |
|----------------------|------------|--------------|-------------|
| Receiver | SCR3501 | Schaffner | 2005/11/03 |
| LISN | NNB-2/16Z | ROLF HEINE | 2006/05/01 |
| LISN | ROLF HEINE | NNB-2/16Z | 2006/03/30 |

4.5 Test Result and Data

EUT : Kwik Blue4-1
 Power : AC120V
 Test Mode : CH 0
 Memo :

Pol/Phase : NEUTRAL
 Temperature : 26 °C
 Humidity : 58 %

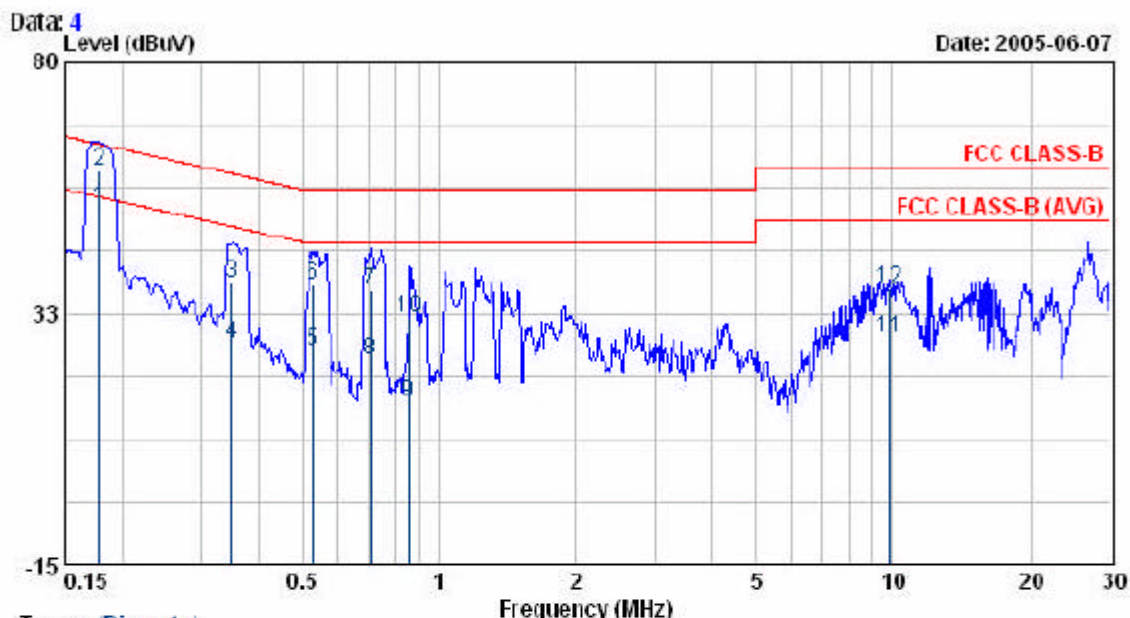

Trace: (Discrete)

| Freq | Read Level | Factor | Level | Limit | Over Limit | Remark |
|------|------------|--------|-------|-------|------------|---------|
| MHz | dBuV | dB | dBuV | dBuV | dBuV | |
| 0.18 | 52.37 | 0.13 | 52.50 | 54.58 | -2.07 | AVERAGE |
| 0.18 | 59.31 | 0.13 | 59.44 | 64.58 | -5.13 | QP |
| 0.35 | 38.03 | 0.34 | 38.37 | 59.00 | -20.63 | QP |
| 0.35 | 26.37 | 0.34 | 26.71 | 49.00 | -22.29 | AVERAGE |
| 0.53 | 24.84 | 0.37 | 25.21 | 46.00 | -20.79 | AVERAGE |
| 0.53 | 37.50 | 0.37 | 37.87 | 56.00 | -18.13 | QP |
| 0.71 | 36.48 | 0.34 | 36.82 | 56.00 | -19.18 | QP |
| 0.71 | 23.22 | 0.34 | 23.56 | 46.00 | -22.44 | AVERAGE |
| 0.86 | 15.46 | 0.32 | 15.78 | 46.00 | -30.22 | AVERAGE |
| 0.86 | 31.40 | 0.32 | 31.72 | 56.00 | -24.28 | QP |
| 9.89 | 27.61 | 0.30 | 27.91 | 50.00 | -22.09 | AVERAGE |
| 9.89 | 36.91 | 0.30 | 37.11 | 60.00 | -22.89 | QP |

Remarks: 1. Level = Read Level + Factor
 2. Factor = LISN(ISN) Factor + Cable Loss

EVT : Kwik Blue4-1
 Power : AC120V
 Test Mode : CH 0
 Memo :

Pol/Phase : LINE
 Temperature : 26 °C
 Humidity : 58 %

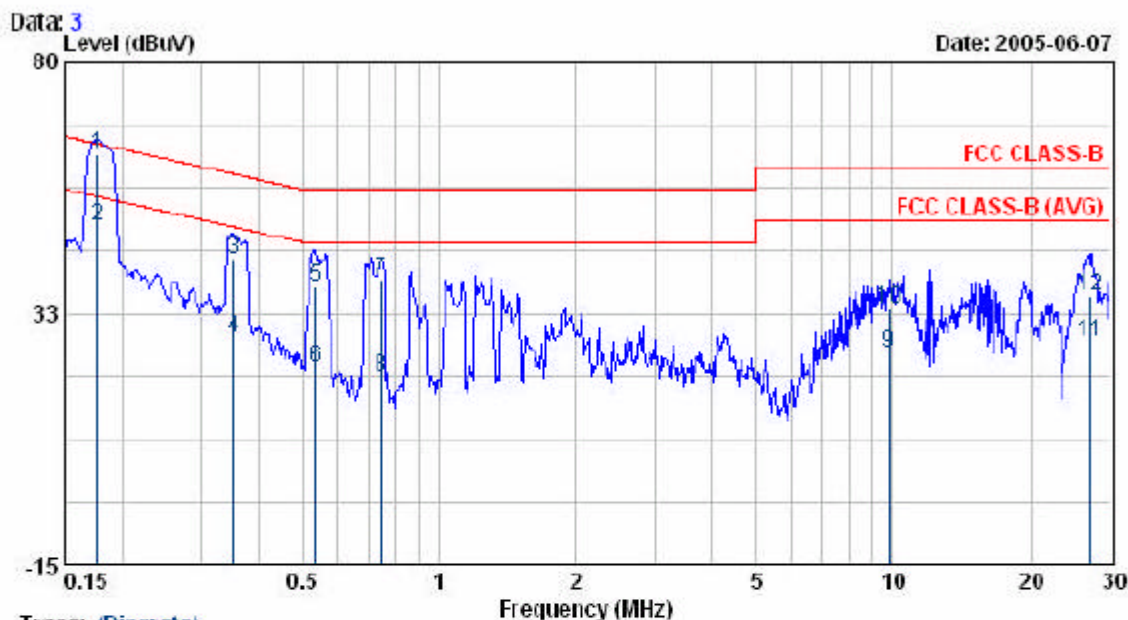

Trace: (Discrete)

| Freq | Read Level | Factor | Level | Limit | Over Limit | Remark |
|-------|------------|--------|-------|-------|------------|---------|
| MHz | dBuV | dB | dBuV | dBuV | dBuV | |
| 0.18 | 62.15 | 0.34 | 62.49 | 64.65 | -2.17 | QP |
| 0.18 | 48.65 | 0.34 | 48.99 | 54.65 | -5.67 | AVERAGE |
| 0.35 | 42.32 | 0.54 | 42.86 | 58.92 | -16.06 | QP |
| 0.35 | 27.17 | 0.54 | 27.71 | 48.92 | -21.21 | AVERAGE |
| 0.54 | 36.86 | 0.57 | 37.43 | 56.00 | -18.57 | QP |
| 0.54 | 21.63 | 0.57 | 22.20 | 46.00 | -23.80 | AVERAGE |
| 0.75 | 38.25 | 0.53 | 38.78 | 56.00 | -17.22 | QP |
| 0.75 | 19.99 | 0.53 | 20.52 | 46.00 | -25.48 | AVERAGE |
| 9.83 | 24.48 | 0.60 | 25.08 | 50.00 | -24.92 | AVERAGE |
| 9.83 | 32.74 | 0.60 | 33.34 | 60.00 | -26.66 | QP |
| 26.99 | 26.23 | 0.72 | 26.95 | 50.00 | -23.05 | AVERAGE |
| 26.99 | 35.16 | 0.72 | 35.88 | 60.00 | -24.12 | QP |

Remarks: 1. Level = Read Level + Factor
 2. Factor = LISN(ISN) Factor + Cable Loss

EUT : Kwik Blue4-1
 Power : AC120V
 Test Mode : CH 39
 Memo :

Pol/Phase : NEUTRAL
 Temperature : 26 °C
 Humidity : 58 %

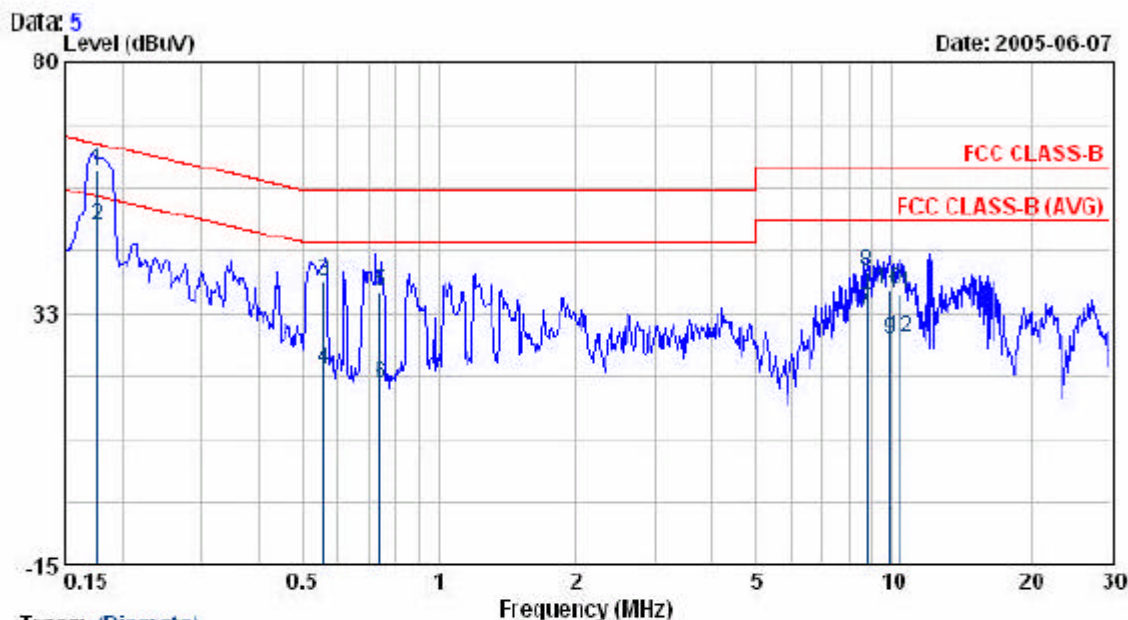

Trace: (Discrete)

| Freq | Read Level | Factor | Level | Limit | Over Limit | Remark |
|-------|------------|--------|-------|-------|------------|---------|
| MHz | dBuV | dB | dBuV | dBuV | dBuV | |
| 0.18 | 59.28 | 0.14 | 59.42 | 64.66 | -5.24 | QP |
| 0.18 | 48.82 | 0.14 | 48.96 | 54.66 | -5.70 | AVERAGE |
| 0.56 | 38.09 | 0.36 | 38.45 | 56.00 | -17.55 | QP |
| 0.56 | 21.66 | 0.36 | 22.02 | 46.00 | -23.98 | AVERAGE |
| 0.74 | 36.18 | 0.33 | 36.51 | 56.00 | -19.49 | QP |
| 0.74 | 18.83 | 0.33 | 19.16 | 46.00 | -26.84 | AVERAGE |
| 8.79 | 32.56 | 0.31 | 32.87 | 50.00 | -17.13 | AVERAGE |
| 8.79 | 39.86 | 0.31 | 40.17 | 60.00 | -19.83 | QP |
| 9.88 | 27.13 | 0.30 | 27.43 | 50.00 | -22.57 | AVERAGE |
| 9.88 | 36.39 | 0.30 | 36.69 | 60.00 | -23.31 | QP |
| 10.42 | 35.77 | 0.33 | 36.10 | 60.00 | -23.90 | QP |
| 10.42 | 27.38 | 0.33 | 27.71 | 50.00 | -22.29 | AVERAGE |

Remarks: 1. Level = Read Level + Factor
 2. Factor = LISN(ISN) Factor + Cable Loss

EUT : Kwik Blue4-1
 Power : AC120V
 Test Mode : CH 39
 Memo :

Pol/Phase : LINE
 Temperature : 26 ℃
 Humidity : 58 %

Data: 6

Level (dBuV)

Date: 2005-06-07

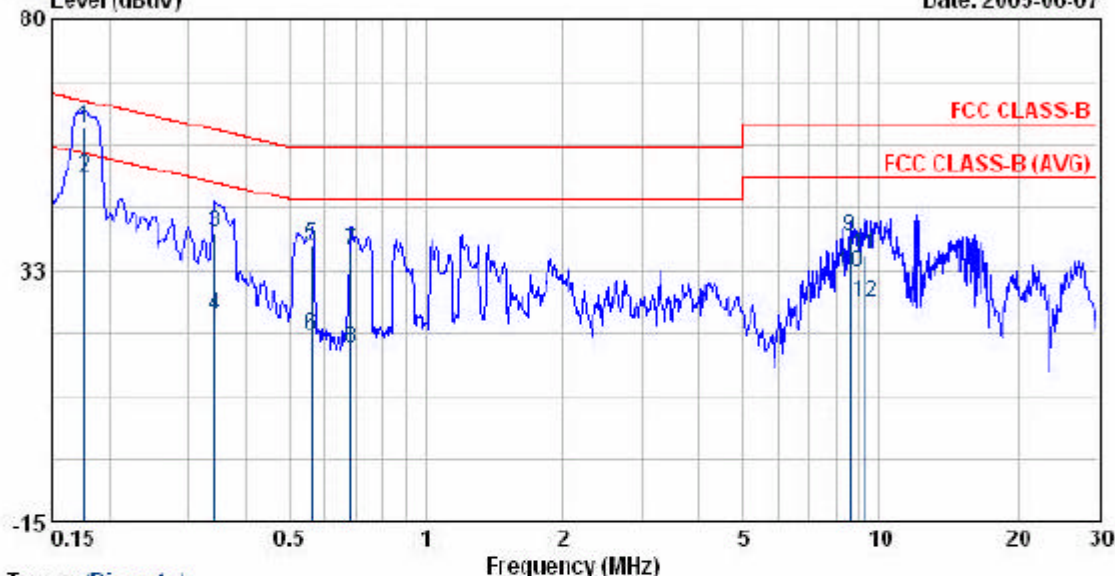

Trace: (Discrete)

| Freq | Read | Factor | Level | Limit | Over | Remark |
|------|-------|--------|-------|-------|--------|---------|
| MHz | dBuV | dB | dBuV | dBuV | dBuV | |
| 0.18 | 59.26 | 0.34 | 59.60 | 64.67 | -5.08 | QP |
| 0.18 | 49.61 | 0.34 | 49.95 | 54.67 | -4.73 | AVERAGE |
| 0.34 | 39.25 | 0.53 | 39.78 | 59.16 | -19.38 | QP |
| 0.34 | 23.40 | 0.53 | 23.93 | 49.16 | -25.23 | AVERAGE |
| 0.56 | 36.62 | 0.56 | 37.18 | 56.00 | -18.82 | QP |
| 0.56 | 19.52 | 0.56 | 20.08 | 46.00 | -25.92 | AVERAGE |
| 0.68 | 35.47 | 0.54 | 36.01 | 56.00 | -19.99 | QP |
| 0.68 | 17.27 | 0.54 | 17.81 | 46.00 | -28.19 | AVERAGE |
| 8.65 | 38.24 | 0.62 | 38.86 | 60.00 | -21.14 | QP |
| 8.65 | 31.24 | 0.62 | 31.86 | 50.00 | -18.14 | AVERAGE |
| 9.36 | 34.74 | 0.61 | 35.35 | 60.00 | -24.65 | QP |
| 9.36 | 25.63 | 0.61 | 26.24 | 50.00 | -23.76 | AVERAGE |

Remarks: 1. Level = Read Level + Factor
 2. Factor = LISN(ISN) Factor + Cable Loss

EVT : Kwik Blue4-1
 Power : AC120V
 Test Mode : CH 78
 Memo :

Pol/Phase : NEUTRAL
 Temperature : 26 °C
 Humidity : 5% %

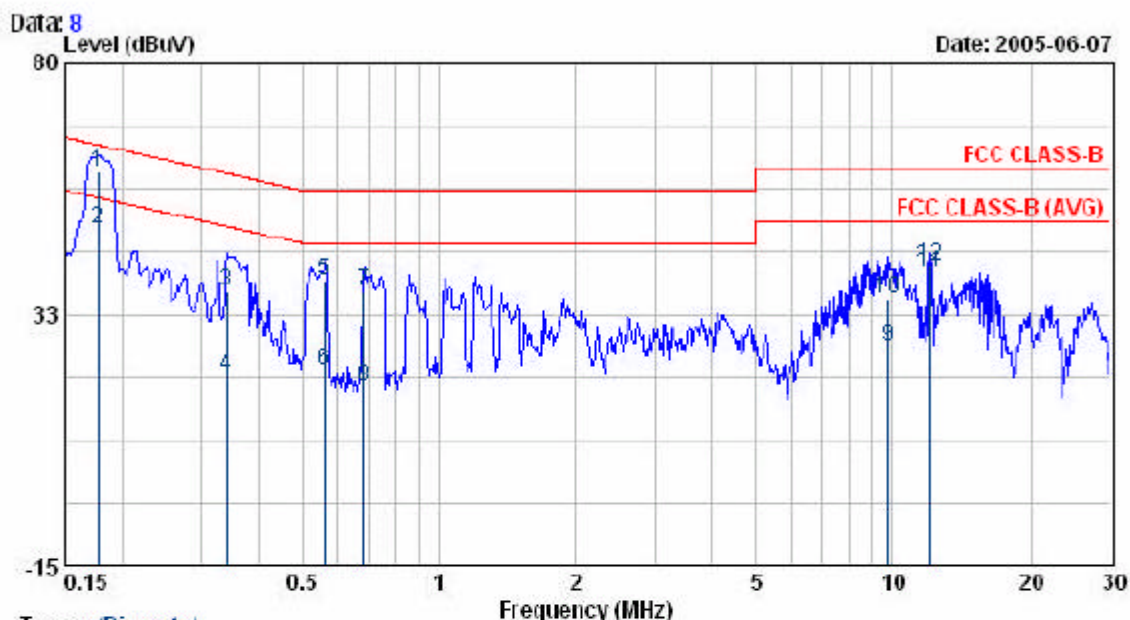

Trace: (Discrete)

| Freq | Read Level | Factor | Level | Limit | Over Limit | Remark |
|-------|------------|--------|-------|-------|------------|---------|
| MHz | dBuV | dB | dBuV | dBuV | dBuV | |
| 0.18 | 59.37 | 0.13 | 59.50 | 64.62 | -5.11 | QP |
| 0.18 | 48.57 | 0.13 | 48.70 | 54.62 | -5.91 | AVERAGE |
| 0.34 | 36.59 | 0.33 | 36.92 | 59.18 | -22.26 | QP |
| 0.34 | 20.34 | 0.33 | 20.67 | 49.18 | -28.51 | AVERAGE |
| 0.56 | 38.54 | 0.36 | 38.90 | 56.00 | -17.10 | QP |
| 0.56 | 21.52 | 0.36 | 21.88 | 46.00 | -24.12 | AVERAGE |
| 0.68 | 36.43 | 0.34 | 36.77 | 56.00 | -19.23 | QP |
| 0.68 | 18.53 | 0.34 | 18.87 | 46.00 | -27.13 | AVERAGE |
| 9.80 | 26.04 | 0.30 | 26.34 | 50.00 | -23.66 | AVERAGE |
| 9.80 | 35.07 | 0.30 | 35.37 | 60.00 | -24.63 | QP |
| 12.00 | 39.80 | 0.43 | 40.23 | 50.00 | -9.77 | AVERAGE |
| 12.00 | 41.35 | 0.43 | 41.78 | 60.00 | -18.22 | QP |

Remarks: 1. Level = Read Level + Factor
 2. Factor = LISN(ISN) Factor + Cable Loss

EVT : Kwik Blue4-1
 Power : AC120V
 Test Mode : CH 78
 Memo :

Pol/Phase : LINE
 Temperature : 26 °C
 Humidity : 5% %

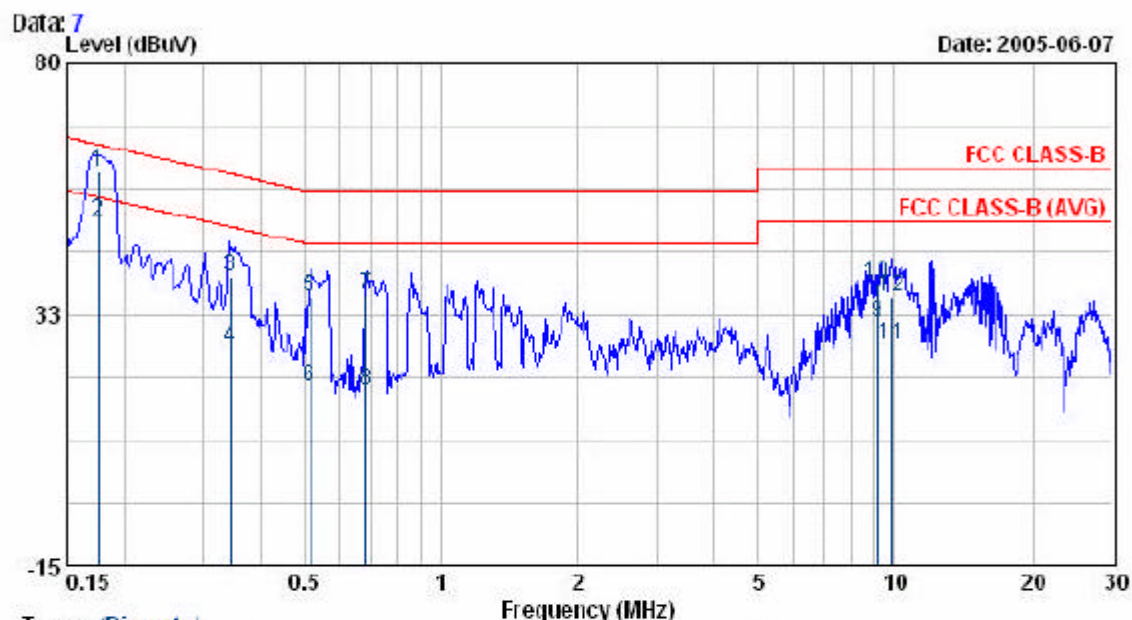

Trace: (Discrete)

| Freq | Read Level | Factor | Level | Limit | Over Limit | Remark |
|------|------------|--------|-------|-------|------------|---------|
| MHz | dBuV | dB | dBuV | dBuV | dBuV | |
| 0.18 | 59.23 | 0.34 | 59.57 | 64.68 | -5.11 | QP |
| 0.18 | 49.76 | 0.34 | 50.10 | 54.68 | -4.58 | AVERAGE |
| 0.34 | 39.01 | 0.53 | 39.54 | 59.10 | -19.56 | QP |
| 0.34 | 25.53 | 0.53 | 26.06 | 49.10 | -23.04 | AVERAGE |
| 0.51 | 35.23 | 0.57 | 35.80 | 56.00 | -20.20 | QP |
| 0.51 | 18.03 | 0.57 | 18.60 | 46.00 | -27.40 | AVERAGE |
| 0.68 | 35.60 | 0.54 | 36.14 | 56.00 | -19.86 | QP |
| 0.68 | 17.35 | 0.54 | 17.89 | 46.00 | -28.11 | AVERAGE |
| 9.18 | 30.30 | 0.61 | 30.91 | 50.00 | -19.09 | AVERAGE |
| 9.18 | 37.68 | 0.61 | 38.29 | 60.00 | -21.71 | QP |
| 9.89 | 26.30 | 0.60 | 26.90 | 50.00 | -23.10 | AVERAGE |
| 9.89 | 35.23 | 0.60 | 35.83 | 60.00 | -24.17 | QP |

Remarks: 1. Level = Read Level + Factor
 2. Factor = LISN(ISN) Factor + Cable Loss

Test engineer: Gallan

4.5.1 Test Photographs

FRONT VIEW



REAR VIEW



5. Test of Radiated Emission

5.1 Test Limit

Radiated emissions from 30 MHz to 25 GHz were measured according to the methods defines in ANSI C63.4-2003. The EUT was placed, 0.8 meter above the ground plane, as shown in section 5.6.3. The interface cables and equipment positions were varied within limits of reasonable applications to determine the positions producing maximum radiated emissions For unintentional device, according to § 15.109(a), except for Class A digital devices, the field strength of radiated emissions from unintentional radiators at a distance of 3 meters shall not exceed the following values:

| Frequency (MHz) | Distance Meters | Radiated (μ V / M) | Radiated (dB μ V / M) |
|-----------------|-----------------|-------------------------|---------------------------|
| 30-88 | 3 | 100 | 40.0 |
| 88-216 | 3 | 150 | 43.5 |
| 216-960 | 3 | 200 | 46.0 |
| Above 960 | 3 | 500 | 54.0 |

For unintentional device, according to CISPR PUB.22, for Class B digital devices, the general requirement of field strength of radiated emissions from intentional radiators at a distance of 10 meters shall not exceed the above table.

| Frequency (MHz) | Distance Meters | Radiated (dB μ V / M) |
|-----------------|-----------------|---------------------------|
| 30-230 | 10 | 30 |
| 230-1000 | 10 | 37 |

5.2 Test Procedures

1. The EUT was placed on a rotatable table top 0.8 meter above ground.
2. The EUT was set 3 meters from the interference receiving antenna which was mounted on the top of a variable height antenna tower.
3. The table was rotated 360 degrees to determine the position of the highest radiation.
4. The antenna is a broadband antenna and its height is varied between one meter and four meters above ground to find the maximum value of the field strength both horizontal polarization and vertical polarization of the antenna are set to make the measurement.
5. For each suspected emission the EUT was arranged to its worst case and then tune the antenna tower (from 1 M to 4 M) and turn table (from 0 degree to 360 degrees) to find the maximum reading.
6. Set the test-receiver system to Peak or CISPR quasi-peak Detect Function and specified bandwidth with Maximum Hold Mode.
7. If the emission level of the EUT in peak mode was 3 dB lower than the limit specified, then testing will be stopped and peak values of EUT will be reported, otherwise, the emissions which do not have 3 dB margin will be repeated one by one using the quasi-peak method and reported.
8. For testing above 1GHz, the emission level of the EUT in peak mode was 20dB lower than average limit (that means the emission level in peak mode also complies with the limit in average mode), then testing will be stopped and peak values of EUT will be reported, otherwise, the emissions will be measured in average mode again and reported.

5.3 Typical Test Setup

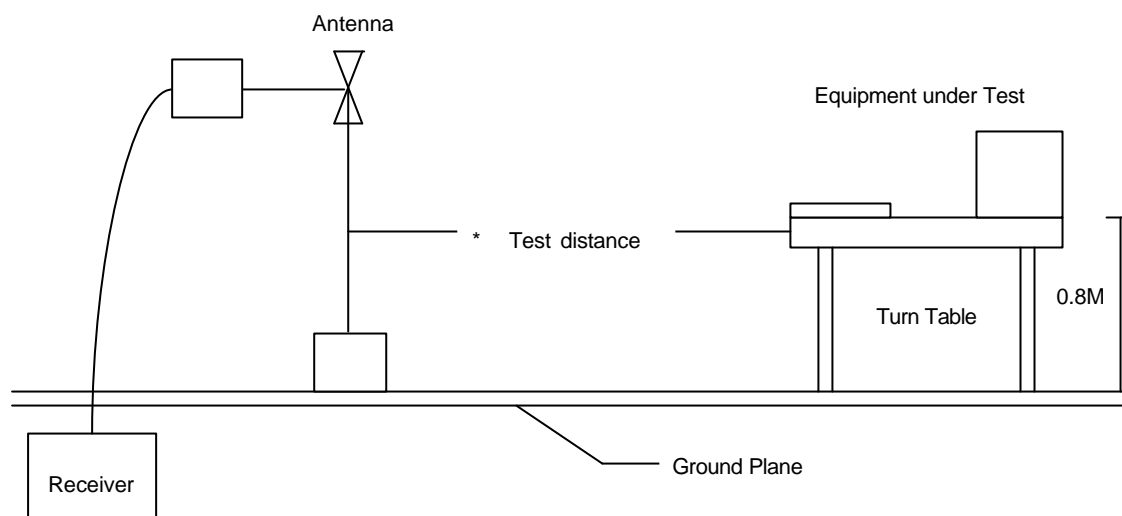

5.4 Measurement equipment

| Instrument/Ancillary | Type | Manufacturer | Valid Date |
|----------------------|----------|--------------|------------|
| EMI Receiver | 8546A | HP | 2006/04/13 |
| Spectrum Analyzer | FSP40 | R&S | 2005/12/28 |
| Horn Antenna | 3115 | EMCO | 2006/02/21 |
| Horn Antenna | 3116 | EMCO | 2006/02/21 |
| Bilog Antenna | CBL6112B | Schaffner | 2006/04/12 |
| Amplifier | 8447D | Agilent | 2005/06/30 |
| Amplifier | 8449B | Agilent | 2005/12/27 |

5.5 Test Result and Data

EUT : Kwik Blue4-1
 Power : 120V
 Test Mode : Transmit/Receive
 Operation Channel: 0
 Modulation Type : GFSK
 Rate : 1 Mbps
 Pol/Phase : HORIZONTAL
 Temperature : 25 °C
 Humidity : 68 %
 Atmospheric Pressure: 1020 mmHg
 Memo :

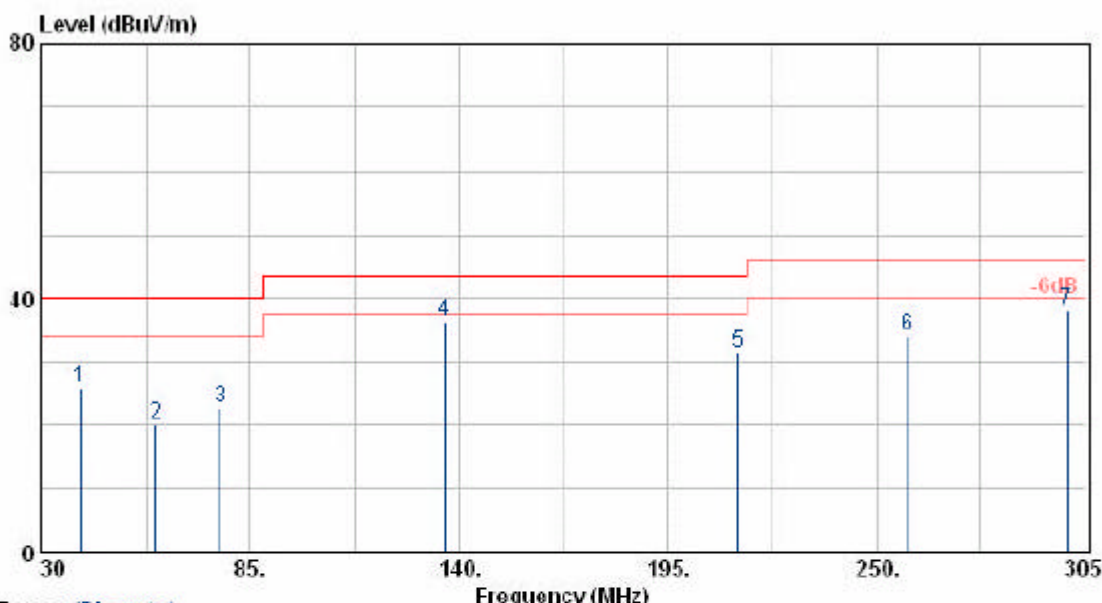

Trace: (Discrete)

| Frequency (MHz) | Meter Reading (dBuV) | Corrected Factor (dBuV/m) | Result (dBuV/m) | Limit (dB) | Margin (dB) | Remark | Table Deg. | Ant High (cm) |
|-----------------|----------------------|---------------------------|-----------------|------------|-------------|--------|------------|---------------|
| 39.98 | 34.88 | -9.10 | 25.78 | 40.00 | -14.22 | Peak | 95 | 100 |
| 60.12 | 41.81 | -21.64 | 20.17 | 40.00 | -19.83 | Peak | 95 | 100 |
| 77.21 | 40.95 | -18.32 | 22.63 | 40.00 | -17.37 | Peak | 320 | 100 |
| 136.10 | 51.06 | -14.73 | 36.33 | 43.50 | -7.17 | Peak | 300 | 100 |
| 213.40 | 48.87 | -17.40 | 31.47 | 43.50 | -12.03 | Peak | 300 | 100 |
| 258.30 | 46.50 | -12.52 | 33.98 | 46.00 | -12.02 | Peak | 240 | 100 |
| 299.99 | 49.13 | -11.10 | 38.03 | 46.00 | -7.97 | Peak | 240 | 100 |

Notes:

1. Result = Meter Reading + Corrected Factor
2. Corrected Factor = Antenna Factor + Cable Loss - Amplifier
3. The resolution bandwidth of test receiver/spectrum analyzer is 120KHz and video bandwidth is 300kHz for Peak detection and Quasi-peak detection at frequency below 1GHz.
4. The resolution bandwidth of test receiver/spectrum analyzer is 1MHz and video bandwidth is 3MHz for Peak detection at frequency above 1GHz.
5. The resolution bandwidth of test receiver/spectrum analyzer is 1MHz and video bandwidth is 10Hz for Average detection at frequency above 1GHz.
6. The other emissions is too below to be measured.

| | | | |
|-------------------|--------------------|----------------------|--------------|
| EUT | : Kwik Blue4-1 | Pol/Phase | : HORIZONTAL |
| Power | : 120V | Temperature | : 25 °C |
| Test Mode | : Transmit/Receive | Humidity | : 68 % |
| Operation Channel | : 0 | Atmospheric Pressure | : 1020 mmHg |
| Modulation Type | : GFSK | Memo | : |
| Rate | : 1 Mbps | | |

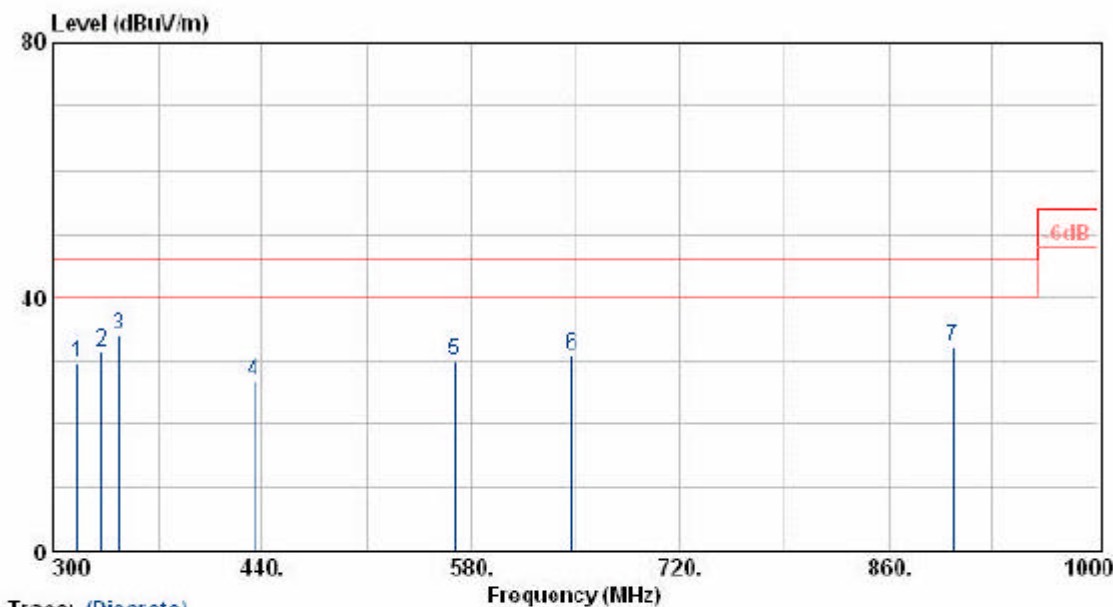

Trace: (Discrete)

| Frequency (MHz) | Meter Reading (dBuV) | Corrected Factor (dBuV/m) | Result (dBuV/m) | Limit (dB) | Margin (dB) | Remark | Table Deg. | Ant High (cm) |
|-----------------|----------------------|---------------------------|-----------------|------------|-------------|--------|------------|---------------|
| 316.52 | 40.55 | -10.78 | 29.77 | 46.00 | -16.23 | Peak | 80 | 100 |
| 332.12 | 42.08 | -10.54 | 31.54 | 46.00 | -14.46 | Peak | 80 | 100 |
| 344.35 | 44.38 | -10.27 | 34.11 | 46.00 | -11.89 | Peak | 30 | 100 |
| 433.98 | 35.35 | -8.47 | 26.88 | 46.00 | -19.12 | Peak | 200 | 100 |
| 558.72 | 34.89 | -4.85 | 30.04 | 46.00 | -15.96 | Peak | 140 | 100 |
| 647.23 | 34.71 | -3.76 | 30.95 | 46.00 | -15.05 | Peak | 80 | 100 |
| 903.10 | 31.18 | 1.23 | 32.41 | 46.00 | -13.59 | Peak | 80 | 100 |

Notes:

1. Result = Meter Reading + Corrected Factor
2. Corrected Factor = Antenna Factor + Cable Loss - Amplifier
3. The resolution bandwidth of test receiver/spectrum analyzer is 120kHz and video bandwidth is 300kHz for Peak detection and Quasi-peak detection at frequency below 1GHz.
4. The resolution bandwidth of test receiver/spectrum analyzer is 1MHz and video bandwidth is 3MHz for Peak detection at frequency above 1GHz.
5. The resolution bandwidth of test receiver/spectrum analyzer is 1MHz and video bandwidth is 10Hz for Average detection at frequency above 1GHz.
6. The other emissions is too below to be measured.

| | | | |
|-------------------|--------------------|----------------------|-------------|
| EUT | : Kwik Blue4-1 | Pol/Phase | : VERTICAL |
| Power | : 120V | Temperature | : 25 °C |
| Test Mode | : Transmit/Receive | Humidity | : 68 % |
| Operation Channel | : 0 | Atmospheric Pressure | : 1020 mmHg |
| Modulation Type | : GFSK | Memo | : |
| Rate | : 1 Mbps | | |

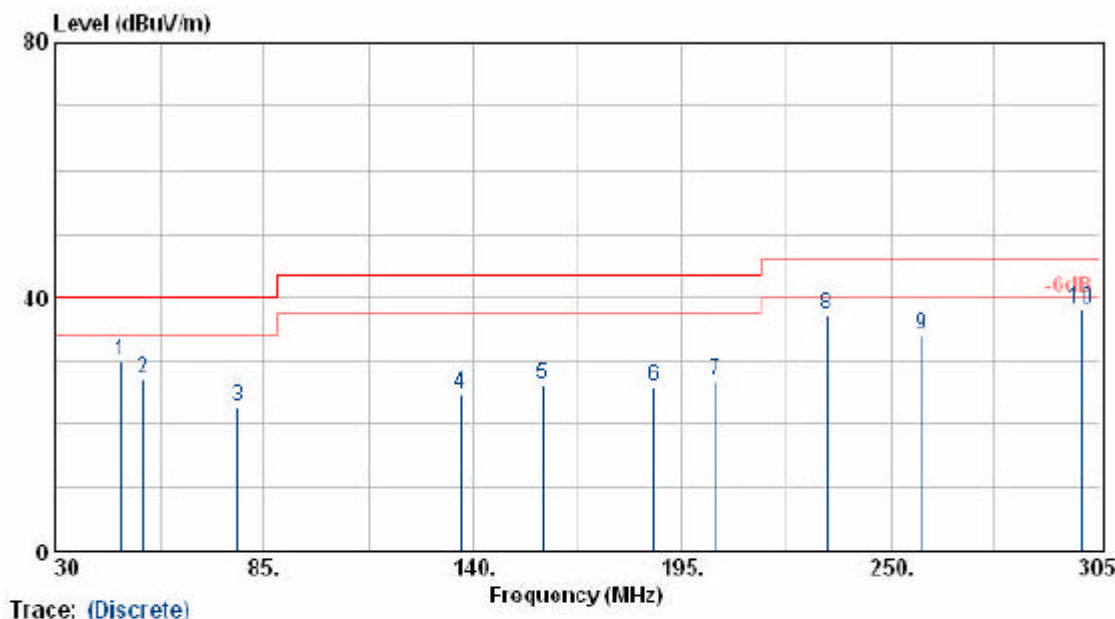

| Frequency (MHz) | Meter Reading (dBuV) | Corrected Factor (dBuV/m) | Result (dBuV/m) | Limit (dB) | Margin (dB) | Remark | Table Deg. | Ant High (cm) |
|-----------------|----------------------|---------------------------|-----------------|------------|-------------|--------|------------|---------------|
| 47.23 | 43.29 | -13.45 | 29.84 | 40.00 | -10.16 | Peak | 65 | 100 |
| 53.21 | 44.01 | -16.97 | 27.04 | 40.00 | -12.96 | Peak | 90 | 100 |
| 78.13 | 40.89 | -18.12 | 22.77 | 40.00 | -17.23 | Peak | 90 | 100 |
| 136.53 | 39.33 | -14.70 | 24.63 | 43.50 | -18.87 | Peak | 150 | 100 |
| 158.34 | 41.66 | -15.48 | 26.18 | 43.50 | -17.32 | Peak | 150 | 100 |
| 187.79 | 42.98 | -17.07 | 25.91 | 43.50 | -17.59 | Peak | 80 | 100 |
| 204.10 | 44.17 | -17.29 | 26.88 | 43.50 | -16.62 | Peak | 40 | 100 |
| 233.10 | 53.04 | -15.79 | 37.25 | 46.00 | -8.75 | Peak | 200 | 100 |
| 258.43 | 46.68 | -12.51 | 34.17 | 46.00 | -11.83 | Peak | 200 | 100 |
| 300.01 | 49.21 | -11.10 | 38.11 | 46.00 | -7.89 | Peak | 180 | 100 |

Notes:

1. Result = Meter Reading + Corrected Factor
2. Corrected Factor = Antenna Factor + Cable Loss - Amplifier
3. The resolution bandwidth of test receiver/spectrum analyzer is 120KHz and video bandwidth is 300kHz for Peak detection and Quasi-peak detection at frequency below 1GHz.
4. The resolution bandwidth of test receiver/spectrum analyzer is 1MHz and video bandwidth is 3MHz for Peak detection at frequency above 1GHz.
5. The resolution bandwidth of test receiver/spectrum analyzer is 1MHz and video bandwidth is 10Hz for Average detection at frequency above 1GHz.
6. The other emissions is too below to be measured.

| | | | |
|-------------------|--------------------|----------------------|-------------|
| EUT | : Kwik Blue4-1 | Pol/Phase | : VERTICAL |
| Power | : 120V | Temperature | : 25 °C |
| Test Mode | : Transmit/Receive | Humidity | : 68 % |
| Operation Channel | : 0 | Atmospheric Pressure | : 1020 mmHg |
| Modulation Type | : GFSK | Memo | : |
| Rate | : 1 Mbps | | |

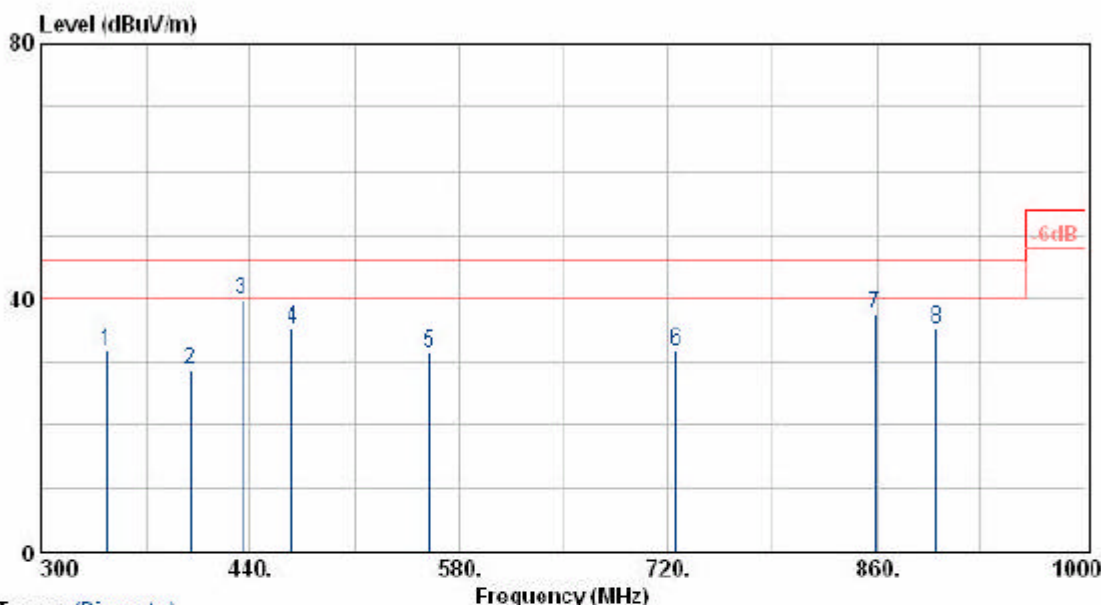

Trace: (Discrete)

| Frequency (MHz) | Meter Reading (dBuV) | Corrected Factor (dBuV/m) | Result (dBuV/m) | Limit (dB) | Margin (dB) | Remark | Table Deg. | Ant High (cm) |
|-----------------|----------------------|---------------------------|-----------------|------------|-------------|--------|------------|---------------|
| 344.24 | 41.87 | -10.27 | 31.60 | 46.00 | -14.40 | Peak | 100 | 100 |
| 399.98 | 37.31 | -8.59 | 28.72 | 46.00 | -17.28 | Peak | 100 | 100 |
| 434.13 | 48.42 | -8.47 | 39.95 | 46.00 | -6.05 | Peak | 200 | 100 |
| 458.38 | 43.03 | -7.92 | 35.11 | 46.00 | -10.89 | Peak | 250 | 100 |
| 559.90 | 36.52 | -5.05 | 31.47 | 46.00 | -14.53 | Peak | 250 | 100 |
| 724.98 | 33.65 | -1.99 | 31.66 | 46.00 | -14.34 | Peak | 145 | 100 |
| 859.16 | 37.05 | 0.50 | 37.55 | 46.00 | -8.45 | Peak | 145 | 100 |
| 900.00 | 33.96 | 1.24 | 35.20 | 46.00 | -10.80 | Peak | 50 | 100 |

Notes:

1. Result = Meter Reading + Corrected Factor
2. Corrected Factor = Antenna Factor + Cable Loss - Amplifier
3. The resolution bandwidth of test receiver/spectrum analyzer is 120kHz and video bandwidth is 300kHz for Peak detection and Quasi-peak detection at frequency below 1GHz.
4. The resolution bandwidth of test receiver/spectrum analyzer is 1MHz and video bandwidth is 3MHz for Peak detection at frequency above 1GHz.
5. The resolution bandwidth of test receiver/spectrum analyzer is 1MHz and video bandwidth is 10Hz for Average detection at frequency above 1GHz.
6. The other emissions is too below to be measured.

```

EVT           : Kwik Blue4-1
Power         : 120V
Test Mode     : Transmit/Receive
Operation Channel: 0
Modulation Type : GFSK
Rate          : 1      Mbps
Pol/Phase     : HORIZONTAL
Temperature   : 28    °C
Humidity      : 67    %
Atmospheric Pressure: 1019 mmHg
Memo          :
    
```

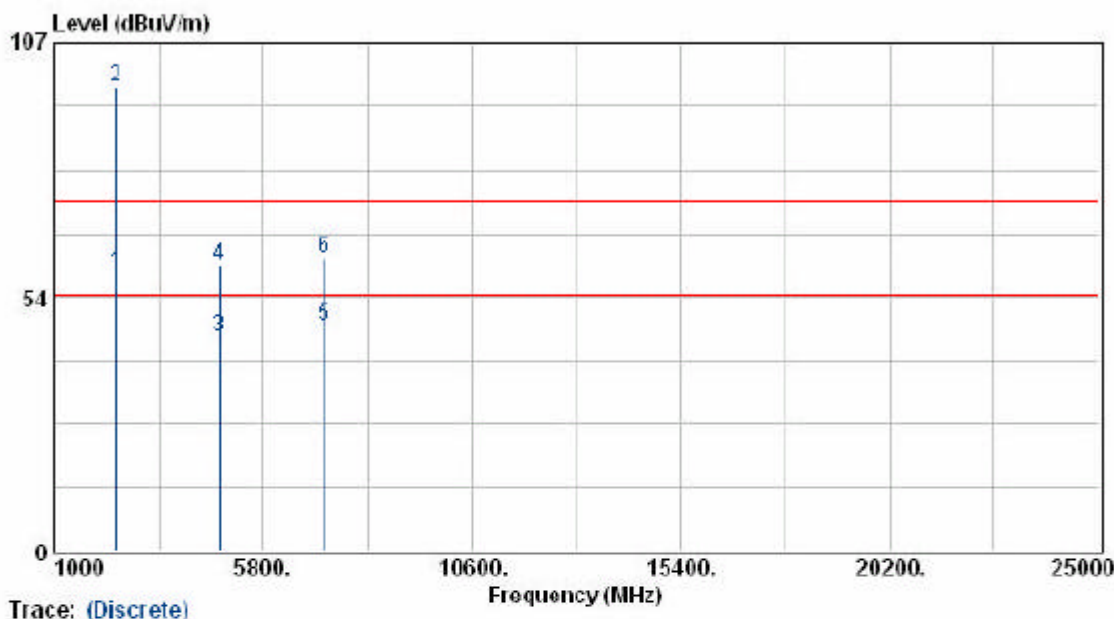

| Frequency (MHz) | Meter Reading (dBUV) | Corrected Factor (dBUV/m) | Result (dBUV/m) | Limit (dB) | Margin (dB) | Remark | Table Deg. | Ant High (cm) |
|-----------------|----------------------|---------------------------|-----------------|------------|-------------|---------|------------|---------------|
| 2402.00 | 57.30 | 1.29 | 58.59 | 54.00 | 4.59 | Average | 99 | 100 |
| 2402.00 | 96.42 | 1.29 | 97.71 | 74.00 | 23.71 | Peak | 99 | 100 |
| 4804.00 | 36.90 | 8.05 | 44.95 | 54.00 | -9.05 | Average | 232 | 100 |
| 4804.00 | 52.18 | 8.05 | 60.23 | 74.00 | -13.77 | Peak | 232 | 100 |
| 7206.00 | 35.49 | 11.83 | 47.32 | 54.00 | -6.68 | Average | 186 | 100 |
| 7206.00 | 49.86 | 11.83 | 61.69 | 74.00 | -12.31 | Peak | 186 | 100 |

Notes:

1. Result = Meter Reading + Corrected Factor
2. Corrected Factor = Antenna Factor + Cable Loss - Amplifier
3. The resolution bandwidth of test receiver/spectrum analyzer is 120KHz and video bandwidth is 300kHz for Peak detection and Quasi-peak detection at frequency below 1GHz.
4. The resolution bandwidth of test receiver/spectrum analyzer is 1MHz and video bandwidth is 3MHz for Peak detection at frequency above 1GHz.
5. The resolution bandwidth of test receiver/spectrum analyzer is 1MHz and video bandwidth is 10Hz for Average detection at frequency above 1GHz.
6. The other emissions is too below to be measured.
7. 2402,2441,2480 MHz is fundamental frequency.

```

EUT           : Kwik Blue4-1
Power         : 120V
Test Mode     : Transmit/Receive
Operation Channel: 0
Modulation Type : GFSK
Rate          : 1      Mbps
Pol/Phase     : VERTICAL
Temperature   : 28    °C
Humidity      : 67    %
Atmospheric Pressure: 1019 mmHg
Memo          :
    
```

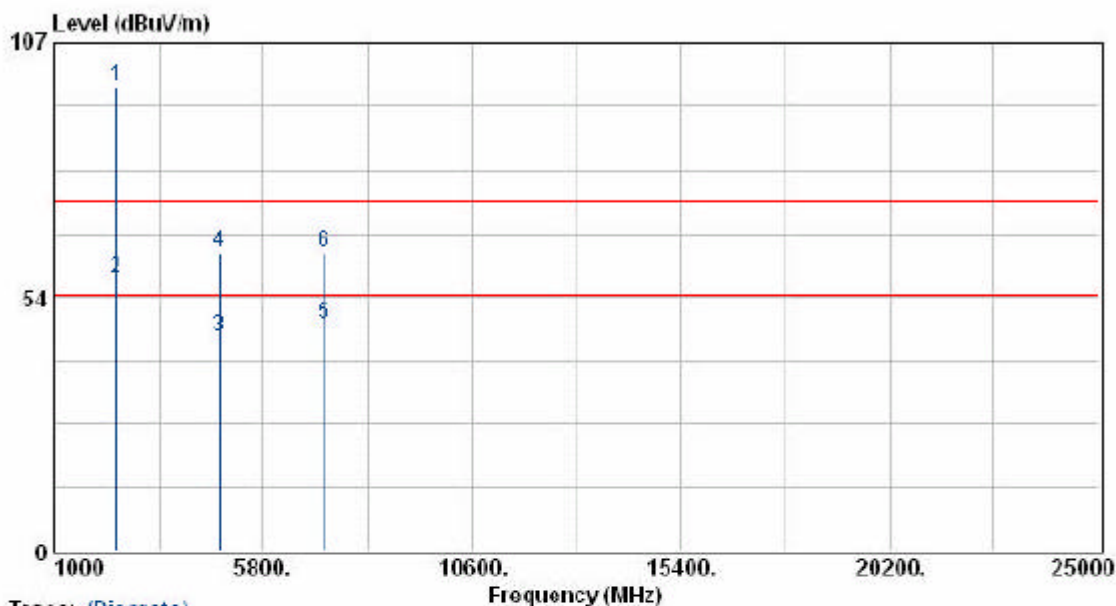

Trace: (Discrete)

| Frequency (MHz) | Meter Reading (dBuV) | Corrected Factor (dBuV/m) | Result (dBuV/m) | Limit (dB) | Margin (dB) | Remark | Table Deg. | Ant High (cm) |
|-----------------|----------------------|---------------------------|-----------------|------------|-------------|---------|------------|---------------|
| 2402.20 | 97.09 | 0.59 | 97.68 | 74.00 | 23.68 | Peak | 57 | 100 |
| 2402.20 | 57.13 | 0.59 | 57.72 | 54.00 | 3.72 | Average | 57 | 100 |
| 4804.10 | 37.89 | 7.29 | 45.18 | 54.00 | -8.82 | Average | 52 | 100 |
| 4804.10 | 55.67 | 7.29 | 62.96 | 74.00 | -11.04 | Peak | 52 | 100 |
| 7206.00 | 36.67 | 11.02 | 47.69 | 54.00 | -6.31 | Average | 214 | 100 |
| 7206.00 | 52.00 | 11.02 | 63.02 | 74.00 | -10.98 | Peak | 214 | 100 |

Notes:

1. Result = Meter Reading + Corrected Factor
2. Corrected Factor = Antenna Factor + Cable Loss - Amplifier
3. The resolution bandwidth of test receiver/spectrum analyzer is 120KHz and video bandwidth is 300kHz for Peak detection and Quasi-peak detection at frequency below 1GHz.
4. The resolution bandwidth of test receiver/spectrum analyzer is 1MHz and video bandwidth is 3MHz for Peak detection at frequency above 1GHz.
5. The resolution bandwidth of test receiver/spectrum analyzer is 1MHz and video bandwidth is 10Hz for Average detection at frequency above 1GHz.
6. The other emissions is too below to be measured.
7. 2402,2441,2480 MHz is fundamental frequency.