

INTERMEC TECHNOLOGIES CORP.

PORTABLE COMPUTER WITH 802.11B/G/N AND BT

Model: 1007CP01



June 25th, 2012

Report No.: SL12011201-ICT-001_1007CP01(FCC_SAR) Rev1.0
(This report supersedes: SL12011201-ICT-001_1007CP01(FCC_SAR))



Modifications made to the product : None

This Test Report is Issued Under the Authority of:

	
David Zhang Compliance Engineer	Leslie Bai Director of Certification

This test report may be reproduced in full only.
All Test Data Presented in this report is only applicable to presented Test sample.

SAR Test Report

SIEMIC, INC.
Accessing global markets

To: C95.1, IEEE 1528, OET Bulletin 65 Suppl. C, RSS 102 and Safety Code 6, EN 62209-2:2010



Laboratory Introduction

SIEMIC, headquartered in the heart of Silicon Valley, with superior facilities in US and Asia, is one of the leading independent testing and certification facilities providing customers with one-stop shop services for Compliance Testing and Global Certifications.



In addition to [testing](#) and [certification](#), SIEMIC provides initial design reviews and [compliance management](#) through out a project. Our extensive experience with [China](#), [Asia Pacific](#), [North America](#), [European](#), and [international](#) compliance requirements, assures the fastest, most cost effective way to attain regulatory compliance for the [global markets](#).

Accreditations for Conformity Assessment

Country/Region	Accreditation Body	Scope
USA	FCC, A2LA	EMC , RF/Wireless , Telecom , SAR
Canada	IC, A2LA, NIST	EMC, RF/Wireless , Telecom , SAR
Taiwan	BSMI , NCC , NIST	EMC, RF, Telecom , Safety
Hong Kong	OFTA , NIST	RF/Wireless ,Telecom
Australia	NATA, NIST	EMC, RF, Telecom , Safety
Korea	KCC/RRA, NIST	EMI, EMS, RF , Telecom, Safety , SAR
Japan	VCCI, JATE, TELEC, RFT	EMI, RF/Wireless, Telecom
Mexico	NOM, COFETEL, Caniety	Safety, EMC , RF/Wireless, Telecom
Europe	A2LA, NIST	EMC, RF, Telecom , Safety, SAR

Accreditations for Product Certifications

Country	Accreditation Body	Scope
USA	FCC TCB, NIST	EMC , RF , Telecom
Canada	IC FCB , NIST	EMC , RF , Telecom
Singapore	iDA, NIST	EMC , RF , Telecom
EU	NB	EMC & R&TTE Directive
Japan	MIC, (RCB 208)	RF , Telecom
HongKong	OFTA (US002)	RF , Telecom

This page has been left blank intentionally.

CONTENTS

1 EXECUTIVE SUMMARY & EUT INFORMATION6
 2 TECHNICAL DETAILS7
 3 INTRODUCTION8
 4 SAR MEASUREMENT SETUP9
 5 ANSI/IEEE C95.1 – 1999 RF EXPOSURE LIMIT19
 6 SYSTEM AND LIQUID VALIDATION20
 7 TYPE A MEASUREMENT UNCERTAINTY.....26
 8 OUTPUT POWER VERIFICATION.....28
 9 SAR TEST RESULTS.....30
 ANNEX A. TEST INSTRUMENT & METHOD.....55
 ANNEX B EUT AND TEST SETUP PHOTOGRAPHS56
 ANNEX C CALIBRATION REPORTS57

This page has been left blank intentionally.

1 Executive Summary & EUT information

The purpose of this test programmed was to demonstrate compliance of the Intermec Technologies Corp Model: 1007CP01 against the current Stipulated Standards. The Portable Computer with 802.11b/g/n and BT have demonstrated compliance with the C95.1, IEEE 1528, OET Bulletin 65 Supplement C , RSS-102 Issue 4, Safety Code 6 and EN 62209-2: 2010 . The test has demonstrated that this unit complies with stipulated standards.

EUT Information

EUT	:	Mobile Computer		
Description	:			
Model No	:	1007CP01		
Serial No	:	136X1200014		
HW version	:	N/A		
IMEI	:	N/A		
Input Power	:	4.4/4.7VDC 2/1.5A		
Maximum Conducted Output Power to Antenna	:	WLAN (2.4GHz): 0.200W (23.00 dBm)		
Classification Per Stipulated Test Standard	:	Potable Device		
Co-located TX	:	802.11b/g/n Radio and Bluetooth Radio		
Antenna Separation distances	:	0cm (Same antenna)		
Measured Highest SAR	:	Band: 2.4GHz	Highest SAR Value:	0.201 W/kg (Head SAR) 0.522 W/kg (Body SAR)
Antenna Gain description	:	WLAN(2.4GHz): 2.41dBi;		

2 TECHNICAL DETAILS

Purpose	Compliance testing of Portable Computer with 802.11b/g/n and BT model 1007CP01 with stipulated standard
Applicant / Client	Intermec Technologies Corp
Manufacturer	Intermec Technologies Corp 6001 36th Avenue W Everett, WA 98203 UNITED STATES
Laboratory performing the tests	SIEMIC Laboratories 2206 Ringwood Ave, San Jose, CA 95131
Test report reference number	SL12011201-ICT-001_1007CP01(FCC_SAR) Rev1.0
Date EUT received	May 26th, 2012
Standard applied	See Page 9
Dates of test (from – to)	Jun 21st, 2012
No of Units:	1
Equipment Category:	DTS
Trade Name:	Intermec Technologies Corp.
Model Name:	1007CP01
RF Operating Frequency (ies)	WIFI 802.11 b/g/n: 2412MHz to 2462MHz Bluetooth: 2402MHz to 2480MHz
Number of Channels:	N/A
Modulation:	WIFI: DSSS,OFDM Bluetooth: GFSK , $\pi/4$ -DQPSK, 8-DPSK
FCC ID:	EHA-1007CP01
IC ID:	1223A-1007CP01

3 INTRODUCTION

Introduction

This measurement report shows compliance of the EUT with FCC OET Bulletin 65 Supplement C (Edition 01-01) & RSS 102 Issue 4.0 and EN 62209-2: 2010.

The test procedures, as described in ANSI C95.1 – 1999 Standard for Safety Levels with Respect to Human Exposure to Radio Frequency Electromagnetic Fields, 3 kHz to 300 GHz [2], and ANSI C95.3 – 2002 Recommended Practice for the Measurement of Potentially Hazardous Electromagnetic Fields [3], were employed.

SAR Definition

Specific Absorption Rate is defined as the time derivative (rate) of the incremental energy (dW) absorbed by (dissipated in) an incremental mass (dm) contained in a volume element (dV) of a given density (ρ).

$$SAR = \frac{d}{dt} \left(\frac{dW}{dm} \right) = \frac{d}{dt} \left(\frac{dW}{\rho dV} \right)$$

SAR is expressed in units of watts per kilogram (W/kg). SAR can be related to the electric field at a point by

$$SAR = \frac{\sigma |E|^2}{\rho}$$

where:

- σ = conductivity of the tissue (S/m)
- ρ = mass density of the tissue (kg/m³)
- E = rms electric field strength (V/m)

4 SAR Measurement Setup

Dosimetric Assessment System

These measurements were performed with the automated near-field scanning system OPENSAR from SATIMO. The system is based on a high precision robot (working range: 850 mm), which positions the probes with a positional repeatability of better than ± 0.02 mm. Special E- and H-field probes have been developed for measurements close to material discontinuity, the sensors of which are directly loaded with a Schottky diode and connected via highly resistive lines to the data acquisition unit.

The SAR measurements were conducted with dosimetric probe (manufactured by SATIMO), designed in the classical triangular configuration and optimized for dosimetric evaluation. The probe has been calibrated according to the procedure described in SAR standard with accuracy of better than $\pm 10\%$. The spherical isotropy was evaluated with the procedure described in SAR standard and found to be better than ± 0.25 dB. The phantom used was the SAM Phantom as described in FCC supplement C, IEEE P1528 and CENELEC EN62209-1/-2.

Measurement System Diagram

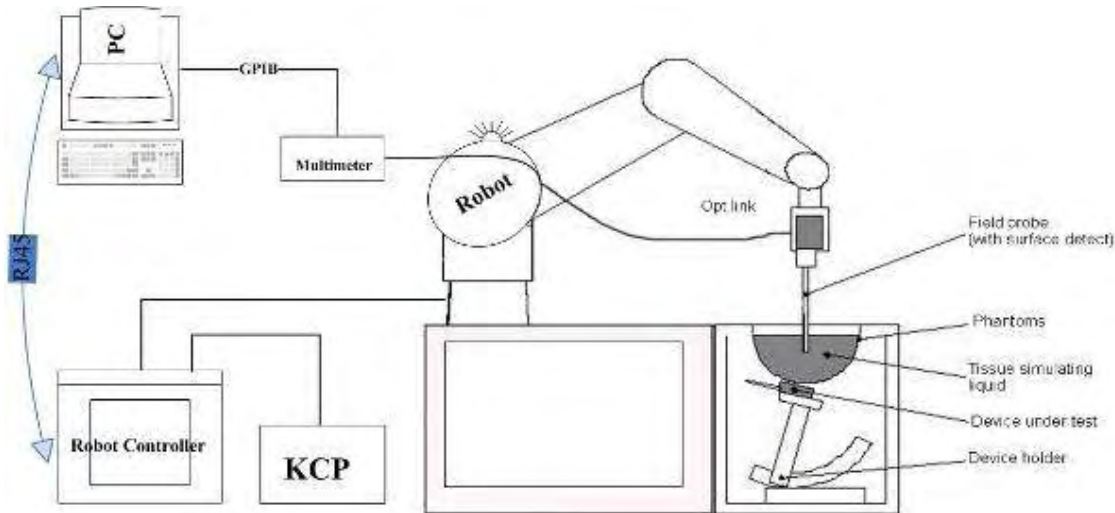

The OPENSAR system for performing compliance tests consist of the following items:

1. A standard high precision 6-axis robot (KUKA) with controller and software.
2. KUKA Control Panel (KCP).
3. A dosimetric probe, i.e., an isotropic E-field probe optimized and calibrated for usage in tissue simulating liquid. The probe is equipped with an optical surface detector system.
4. The functions of the PC plug-in card are to perform the time critical task such as signal filtering, surveillance of the robot operation fast movement interrupts.

5. A computer operating Windows XP.
6. OPENSAR software.
7. Remote control with teaches pendant and additional circuitry for robot safety such as warning lamps, etc.
8. The SAM phantom enabling testing left-hand right-hand and body usage.
9. The Position device for handheld EUT.
10. Tissue simulating liquid mixed according to the given recipes (see Application Note).
11. System validation dipoles to validate the proper functioning of the system.

EP100 Probe



Construction Symmetrical design with triangular Core. Built-in shielding against static charges Calibration in air from 100 MHz to 2.5 GHz. In brain and muscle simulating tissue at frequencies from 800 to 6000 MHz (accuracy of 8%) .

Frequency 100 MHz to 6 GHz;

Linearity ; 0.25 dB (100 MHz to 6 GHz) ,

Directivity : 0.25 dB in brain tissue (rotation around probe axis) 0.5 dB in brain tissue (rotation normal probe axis)

Dynamic : 0.001W/kg to > 100W/kg;

Range Linearity: 0.25 dB

Surface : 0.2 mm repeatability in air and liquids

Dimensions Overall length: 330 mm

Tip length: 16 mm

Body diameter: 8 mm

Tip diameter: 2.6 mm

Distance from probe tip to dipole centers: <1.5 mm

Application General dosimetric up to 6 GHz

Compliance tests of mobile phones

Fast automatic scanning in arbitrary phantoms

The SAR measurements were conducted with the dosimetric probe designed in the classical triangular configuration and optimized for dosimetric evaluation. The probe is constructed using the thick film technique, with printed resistive lines on ceramic substrates.

It is connected to the KRC box on the robot arm and provides an automatic detection of the phantom surface. The 3D file of the phantom is include in OpenSAR software. The Video Positioning System allow the system to take the automatic reference and to move the probe safely and accurately on the phantom.

E-Field Probe Calibration Process

Each probe is calibrated according to a dosimetric assessment procedure described in SAR standard with accuracy better than +/- 10%. The spherical isotropy was evaluated with the procedure described in SAR standard and found to be better than +/-0.25dB. The sensitivity parameters (NormX, NormY, NormZ), the diode compression parameter (DCP) and the conversion factor (ConvF) of the probe are tested.

The free space E-field from probe outputs is determined in a test chamber. This is performed in a TEM cell for frequencies bellow 0.8 GHz, and in a waveguide above 0.8 GHz for free space. For the free space calibration, the probe is placed in the volumetric center of the cavity and at the proper orientation with the field. E-field correlation calibration is performed in a flat phantom filled with the appropriate simulated brain tissue.

SAM Phantom

The SAM Phantom SAM29 is constructed of a fiberglass shell ntegrated in a wooden table. The shape of the shell is in compliance with the specification set in IEEE P1528 and CENELEC EN62209-1. The phantom enables the dosimetric evaluation of left and right hand phone usage as well as body mounted usage at the flat phantom region.

A cover prevents the evaporation of the liquid. Reference markings on the Phantom allow the complete setup of all predefined phantom positions and measurement grids by manually teaching three points in the robot.

- Shell Thickness: 2± 0.2 mm
- Filling Volume: Approx. 25 liters
- Dimensions (H x L x W): 810 x 1000 x 500 mm
- Liquid is filled to at least 15mm from the bottom of Phantom.



Device Holder

In combination with the Generic Twin Phantom V3.0, the Mounting Device enables the rotation of the mounted transmitter in spherical coordinates whereby the rotation points is the ear opening. The devices can be easily, accurately, and repeatedly positioned according to the FCC and CENELEC specifications. The device holder can be locked at different phantom locations (left head, right head, flat phantom).



Note: A simulating human hand is not used due to the complex anatomical and geometrical structure of the hand that may produced infinite number of configurations [10]. To produce the worst-case condition (the hand absorbs antenna output power), the hand is omitted during the tests.

Data Evaluation

The OPENSAR software automatically executes the following procedure to calculate the field units from the microvolt readings at the probe connector. The parameters used in the valuation are stored in the configuration modules of the software:

Probe Parameters	- Sensitivity	Norm _i
	- Conversion factor	ConvFi
	- Diode compression point Dcpi	
Device Parameter	- Frequency	f
	- Crest factor	cf
Media Parametrs	- Conductivity	σ
	- Density	ρ

These parameters must be set correctly in the software. They can either be found in the component documents or be imported into the software from the configuration files issued for the OPENSAR components.

The first step of the evaluation is a linearization of the filtered input signal to account for the compression characteristics of the detector diode. The compensation depends on the input signal, the diode type and the DC-transmission factor from the diode to the evaluation electronics. If the exciting field is pulsed, the crest factor of the signal must be known to correctly compensate for peak power. The formula for each channel can be given as

$$V_i = U_i + U_i^2 \cdot \frac{cf}{dcp_i}$$

- Where
- V_i = Compensated signal of channel i ($i = x, y, z$)
 - U_i = Input signal of channel i ($i = x, y, z$)
 - cf = Crest factor of exciting field(DASY parameter)
 - dcp_i = Diode compression point(DASY parameter)

From the compensated input signals the primary field data for each channel can be evaluated:

E-field probes:
$$E_i = \sqrt{\frac{V_i}{Norm_i \cdot ConvF}}$$

H-field probes:
$$H_i = \sqrt{V_i} \cdot \frac{a_{i10} + a_{i11}f + a_{i12}f^2}{f}$$

- Where V_i = Compensated signal of channel i ($i = x, y, z$)
- $Norm_i$ = Sensor sensitivity of channel i ($i = x, y, z$)
 $\mu V/(V/m)^2$ for E0field Probes
- $ConvF$ = Sensitivity enhancement in solution
- a_{ij} = Sensor sensitivity factors for H-field probes

- f = Carrier frequency (GHz)
- E_i = Electric field strength of channel i in V/m
- H_i = Magnetic field strength of channel i in A/m

The RSS value of the field components gives the total field strength (Hermitian magnitude):

$$E_{tot} = \sqrt{E_x^2 + E_y^2 + E_z^2}$$

The primary field data are used to calculate the derived field units.

$$SAR = E_{tot}^2 \cdot \frac{\sigma}{\rho \cdot 1000}$$

- where SAR = local specific absorption rate in mW/g
- E_{tot} = total field strength in V/m
- σ = conductivity in [mho/m] or [siemens/m]
- ρ = equivalent tissue density in g/cm³

Note that the density is normally set to 1 (or 1.06), to account for actual brain density rather than the density of the simulation liquid.

The power flow density is calculated assuming the excitation field as a free space field.

$$P_{pwe} = \frac{E_{tot}^2}{3770} \quad \text{or} \quad P_{pwe} = H_{tot}^2 \cdot 37.7$$

- where P_{pwe} = Equivalent power density of a plane wave in mW/cm²
- E_{tot} = total electric field strength in V/m
- H_{tot} = total magnetic field strength in A/m

SAR Evaluation – Peak Spatial - Average

The procedure for assessing the peak spatial-average SAR value consists of the following steps

- **Power Reference Measurement**

The reference and drift jobs are useful jobs for monitoring the power drift of the device under test in the batch process. Both jobs measure the field at a specified reference position, at a selectable distance from the phantom surface. The reference position can be either the selected section's grid reference point or a user point in this section. The reference job projects the selected point onto the phantom surface, orients the probe perpendicularly to the surface, and approaches the surface using the selected detection method.

- **Area Scan**

The area scan is used as a fast scan in two dimensions to find the area of high field values, before doing a finer measurement around the hot spot. The sophisticated interpolation routines implemented in OPENSAR software can find the maximum locations even in relatively coarse grids. The scan area is defined by an editable grid. This grid is anchored at the grid reference point of the selected section in the phantom. When the area scan's property sheet is brought-up, grid was at to 15 mm by 15 mm and can be edited by a user.

- **Zoom Scan**

Zoom scans are used to assess the peak spatial SAR values within a cubic averaging volume containing 1 g and 10 g of simulated tissue. The default zoom scan measures 5 x 5 x 7 points within a cube whose base faces are centered around the maximum found in a preceding area scan job within the same procedure. If the preceding Area Scan job indicates more than one maximum, the number of Zoom Scans has to be enlarged accordingly (The default number inserted is 1).

- **Power Drift measurement**

The drift job measures the field at the same location as the most recent reference job within the same procedure, and with the same settings. The drift measurement gives the field difference in dB from the reading conducted within the last reference measurement. Several drift measurements are possible for one reference measurement. This allows a user to monitor the power drift of the device under test within a batch process. In the properties of the Drift job, the user can specify a limit for the drift and have OPENSAR software stop the measurements if this limit is exceeded.

SAR Evaluation – Peak SAR

The procedure for spatial peak SAR evaluation has been implemented according to the IEEE1529 standard. It can be conducted for 1 g and 10 g. The OPENSAR system allows evaluations that combine measured data and robot positions, such as:

- maximum search
- extrapolation
- boundary correction
- peak search for averaged SAR

During a maximum search, global and local maximum searches are automatically performed in 2-D after each Area Scan measurement with at least 6 measurement points. It is based on the evaluation of the local SAR gradient calculated by the Quadratic Shepard's method. The algorithm will find the global maximum and all local maxima within -2 dB of the global maxima for all SAR distributions.

Extrapolation

Extrapolation routines are used to obtain SAR values between the lowest measurement points and the inner phantom surface. The extrapolation distance is determined by the surface detection distance and the probe sensor offset. Several measurements at different distances are necessary for the extrapolation.

They are used in the Cube Scan to obtain SAR values between the lowest measurement points and the inner phantom surface. The routine uses the fourth order least square polynomial method for extrapolation. For a grid using 5x5x7 measurement points with 5mm resolution amounting to 343 measurement points, the uncertainty of the extrapolation routines is less than 1% for 1 g and 10 g cubes.

Definition of Reference Points

Ear Reference Point

Figure 6.2 shows the front, back and side views of the SAM Phantom. The point "M" is the reference point for the center of the mouth, "LE" is the left ear reference point (ERP), and "RE" is the right ERP. The ERPs are 15mm posterior to the entrance to the ear canal (EEC) along the B-M line (Back-Mouth), as shown in Figure 6.1. The plane passing through the two ear canals and M is defined as the Reference Plane. The line N-F (Neck-Front) is perpendicular to the reference plane and passing through the RE (or LE) is called the Reference Pivoting Line (see Figure 6.1). Line B-M is perpendicular to the N-F line. Both N-F and B-M lines are marked on the external phantom shell to facilitate handset positioning [5].

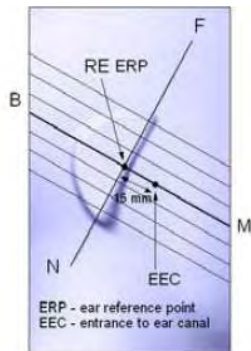

Figure 6.1 Close-up side view of ERP's



Figure 6.2 Front, back and side view of SAM

Device Reference Points

Two imaginary lines on the device need to be established: the vertical centerline and the horizontal line. The test device is placed in a normal operating position with the "test device reference point" located along the "vertical centerline" on the front of the device aligned to the "ear reference point" (See Fig. 6.3). The "test device reference point" is then located at the same level as the center of the ear reference point. The test device is positioned so that the "vertical centerline" is bisecting the front surface of the device at its top and bottom edges, positioning the "ear reference point" on the outer surface of both the left and right head phantoms on the ear reference point [5].

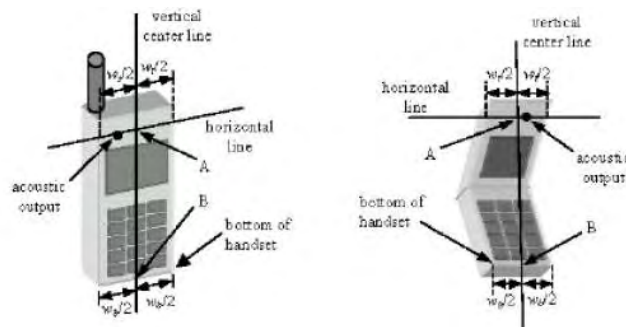

Figure 6.3 Handset Vertical Center & Horizontal Line Reference Points

Test Configuration – Positioning for Cheek / Touch

1. Position the device close to the surface of the phantom such that point A is on the (virtual) extension of the line passing through points RE and LE on the phantom (see Figure below), such that the plane defined by the vertical center line and the horizontal line of the device is approximately parallel to the sagittal plane of the phantom

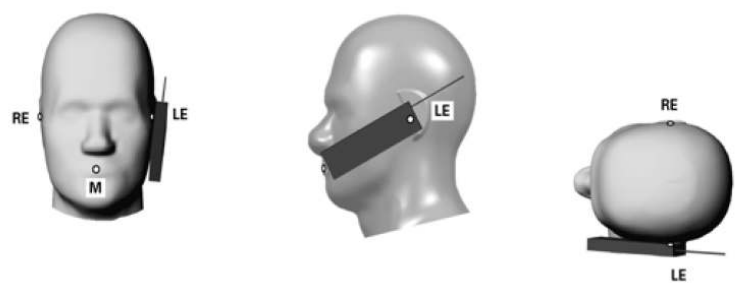

Figure 7.1 Front, Side and Top View of Cheek/Touch Position

2. Translate the device towards the phantom along the line passing through RE and LE until the device touches the ear.
3. While maintaining the device in this plane, rotate it around the LE-RE line until the vertical centerline is in the plane normal to MB-NF including the line MB (called the reference plane).
4. Rotate the device around the vertical centerline until the device (horizontal line) is symmetrical with respect to the line NF.
5. While maintaining the vertical centerline in the reference plane, keeping point A on the line passing through RE and LE and maintaining the device contact with the ear, rotate the device about the line NF until any point on the device is in contact with a phantom point below the ear (cheek). See Figure below.

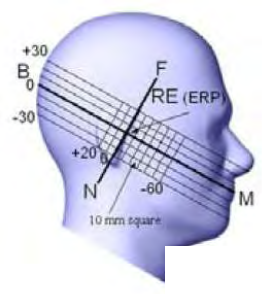

Figure 7.2 Side view w/ relevant markings

Test Configuration – Positioning for Ear / 15° Tilt

With the test device aligned in the Cheek/Touch Position”:

1. While maintaining the orientation of the device, retracted the device parallel to the reference plane far enough to enable a rotation of the device by 15 degrees.
2. Rotate the device around the horizontal line by 15 degrees.
3. While maintaining the orientation of the device, move the device parallel to the reference plane until any part of the device touches the head. (In this position, point A is located on the line RE-LE). The tilted position is obtained when the contact is on the pinna. If the contact is at any location other than the pinna, the angle of the device shall be reduced. The tilted position is obtained when any part of the device is in contact with the ear as well as a second part of the device is in contact with the head (see Figure below).

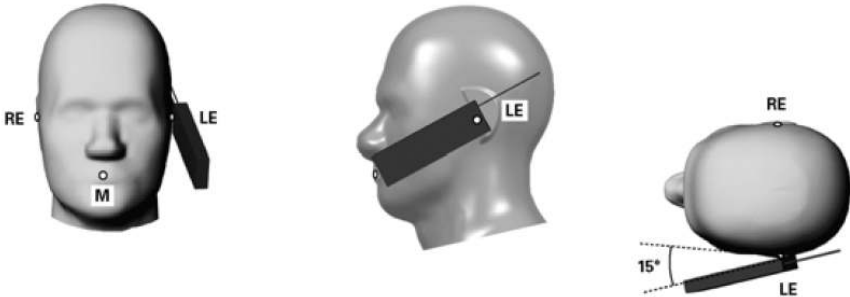

Figure 7.3 Front, Side and Top View of Ear/15° Tilt Position

Test Position – Body Worn Configurations

Body-worn operating configurations are tested with the accessories attached to the device and positioned against a flat phantom in a normal use configuration. A device with a headset output is tested with a headset connected to the device. Body dielectric parameters are used.

Accessories for Body-worn operation configurations are divided into two categories: those that do not contain metallic components and those that do contain metallic components. When multiple accessories that do not contain metallic components are supplied with the device, the device is tested with only the accessory that dictates the closest spacing to the body. Then, when multiple accessories that contain metallic components are supplied with the device, the device is tested with each accessory that contains a unique metallic component. If multiple accessories share an identical metallic component (i.e. the same metallic belt-clip used with different holsters with no other metallic components) only the accessory that dictates the closest spacing to the body is tested.

Body-worn accessories may not always be supplied or available as options for some devices intended to be authorized for body-worn use. In this case, a test configuration where a separation distance between the back of the device and the flat phantom is used. All test position spacings are documented.

Transmitters that are designed to operate in front of a person’s face, as in push-to-talk configurations, are tested for SAR compliance with the front of the device positioned to face the flat phantom. For devices that are carried next to the body such as a shoulder, waist or chest-worn transmitters, SAR compliance is tested with the accessory(ies), including headsets and microphones, attached to the device and positioned against a flat phantom in a normal use configuration.

In all cases SAR measurements are performed to investigate the worst-case positioning. Worst-case positioning is then documented and used to perform Body SAR testing.

5 ANSI/IEEE C95.1 – 1999 RF Exposure Limit

In order for users to be aware of the body-worn operating requirements for meeting RF exposure compliance, operating instructions and cautions statements are included in the user's manual.

Uncontrolled Environment

Uncontrolled Environments are defined as locations where there is the exposure of individuals who have no knowledge or control of their exposure. The general population/uncontrolled exposure limits are applicable to situations in which the general public may be exposed or in which persons who are exposed as a consequence of their employment may not be made fully aware of the potential for exposure or cannot exercise control over their exposure. Members of the general public would come under this category when exposure is not employment-related; for example, in the case of a wireless transmitter that exposes persons in its vicinity.

Controlled Environment

Controlled Environments are defined as locations where there is exposure that may be incurred by persons who are aware of the potential for exposure, (i.e. as a result of employment or occupation). In general, occupational/controlled exposure limits are applicable to situations in which persons are exposed as a consequence of their employment, who have been made fully aware of the potential for exposure and can exercise control over their exposure. This exposure category is also applicable when the exposure is of a transient nature due to incidental passage through a location where the exposure levels may be higher than the general population/uncontrolled limits, but the exposed person is fully aware of the potential for exposure and can exercise control over his or her exposure by leaving the area or by some other appropriate means.

Table 8.1 Human Exposure Limits

	UNCONTROLLED ENVIRONMENT General Population (W/kg) or (mW/g)	CONTROLLED ENVIROMENT Professional Population (W/kg) or (mW/g)
SPATIAL PEAK SAR ¹ Brain	1.60	8.00
SPATIAL AVERAGE SAR ² Whole Body	0.08	0.40
SPATIAL PEAK SAR ³ Hands, Feet, Ankles, Wrists	4.00	20.00

¹ The Spatial Peak value of the SAR averaged over any 1 gram of tissue (defined as a tissue volume in the shape of a cube) and over the appropriate averaging time.

² The Spatial Average value of the SAR averaged over the whole body.

³ The Spatial Peak value of the SAR averaged over any 10 grams of tissue (defined as a tissue volume in the shape of a cube) and over the appropriate averaging time.

6 SYSTEM AND LIQUID VALIDATION

System Validation

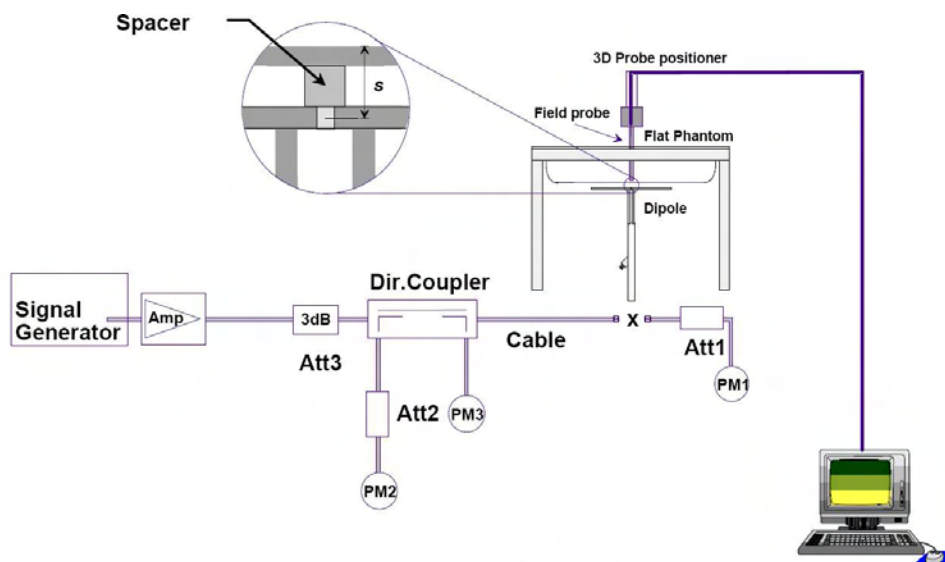

Fig 8.1 System Setup for System Evaluation

The system performance check verifies that the system operates within its specifications. System and operator errors can be detected and corrected. It is recommended that the system performance check be performed prior to any usage of the system in order to guarantee reproducible results. The system performance check uses normal SAR measurements in a simplified setup with a well characterized source. This setup was selected to give a high sensitivity to all parameters that might fail or vary over time. The system check does not intend to replace the calibration of the components, but indicates situations where the system uncertainty is exceeded due to drift or failure.

In the simplified setup for system evaluation, the DUT is replaced by a calibrated dipole and the power source is replaced by a continuous wave that comes from a signal generator. The calibrated dipole must be placed beneath the flat phantom section of the SAM twin phantom with the correct distance holder. The distance holder should touch the phantom surface with a light pressure at the reference marking and be oriented parallel to the long side of the phantom. The equipment setup is shown below:

1. Signal Generator
2. Amplifier
3. Directional Coupler
4. Power Meter
5. Calibrated Dipole

The output power on dipole port must be calibrated to 30 dBm (1000 mW) before dipole is connected.

Numerical reference SAR values (W/kg) for reference dipole and flat phantom

Frequency (MHz)	1 g SAR	10 g SAR	Local SAR at surface (above feed-point)	Local SAR at surface (y = 2 cm offset from feed-point) ^a
300	3.0	2.0	4.4	2.1
450	4.9	3.3	7.2	3.2
835	9.5	6.2	4.1	4.9
900	10.8	6.9	16.4	5.4
1450	29.0	16.0	50.2	6.5
1800	38.1	19.8	69.5	6.8
1900	39.7	20.5	72.1	6.6
2000	41.1	21.1	74.6	6.5
2450	52.4	24.0	104.2	7.7
3000	63.8	25.7	140.2	9.5

Target and measurement SAR after Normalized

Measurement Date	Frequency (MHz)	Phantom/Liquid	Target SAR1g(W/kg)	Measured SAR1g(W/kg)	Deviation (%)
July 21th, 2012	2450	Flat/Head	5.260	5.290	0.58
Jun 21st, 2012	2450	Flat/Body	5.561	5.449	2.01

Liquid Validation

The dielectric parameters were checked prior to assessment using the HP85070C dielectric probe kit. The dielectric parameters measured are reported in each correspondent section.

IEEE SCC-34/SC-2 P1528 recommended Tissue Dielectric Parameters

The head tissue dielectric parameters recommended by the IEEE SCC-34/SC-2 in P1528 have been incorporated in the following table. These head parameters are derived from planar layer models simulating the highest expected SAR for the dielectric properties and tissue thickness variations in a human head. Other head and body tissue parameters that have not been specified in P1528 are derived from the tissue dielectric parameters computed from the 4-Cole-Cole equations and extrapolated according to the head parameters specified in P1528

Target Frequency	Head		Body	
MHz	ϵ_r	σ (S/m)	ϵ_r	σ (S/m)
150	52.3	0.76	61.9	0.80
300	45.3	0.87	58.2	0.92
450	43.5	0.87	56.7	0.94
835	41.5	0.90	55.2	0.97
900	41.5	0.97	55.0	1.05
915	41.5	0.98	55.0	1.06
1450	40.5	1.20	54.0	1.30
1610	40.3	1.29	53.8	1.40
1800-2000	40.0	1.40	53.3	1.52
2450	39.2	1.80	52.7	1.95
3000	38.5	2.40	52.0	2.73
5800	35.3	5.27	48.2	6.00

Note: ϵ_r = relative permittivity, σ = conductivity and $\rho = 1000 \text{ kg/m}^3$

Liquid Confirmation Result:

Temperature: <u>21°C</u>		Relative humidity: <u>58%</u>				
Freq(MHz)		Target	Measured	Deviation (%)	Limit (%)	
2450	Head	Permittivity	39.20	40.61	3.60	5
		Conductivity	1.80	1.79	-0.56	5
2462	Head	Permittivity	39.10	40.63	3.91	5
		Conductivity	1.84	1.78	-3.26	5
2450	Body	Permittivity	52.700	52.863	0.31	5
		Conductivity	1.950	1.937	-0.67	5
2462	Body	Permittivity	52.716	52.91	0.37	5
		Conductivity	1.960	1.940	-1.02	5

Note: Liquid Verification was performed on 2012-06-21

System Validation Plots

Test Mode: 2450MHz Validation
Position: Flat Phantom/Head Liquid
Product Description: N/A
Model: N/A
Test Date: June 21st, 2012

Frequency (MHz)	2450.00(Flat, System validation)
Relative permittivity (real part)	39.20
Relative permittivity (imaginary part)	13.22
Conductivity (S/m)	1.80
Variation (%)	-0.39
SAR 1g (W/Kg)	5.292
SURFACE SAR	VOLUME SAR

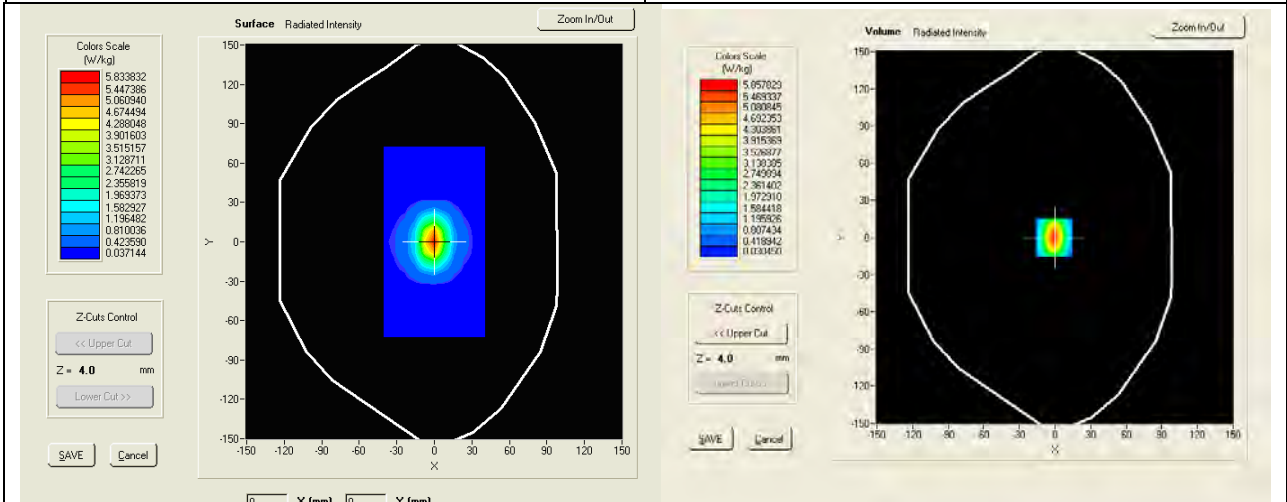

SAR, Z Axis Scan (X = -1, Y = 0)

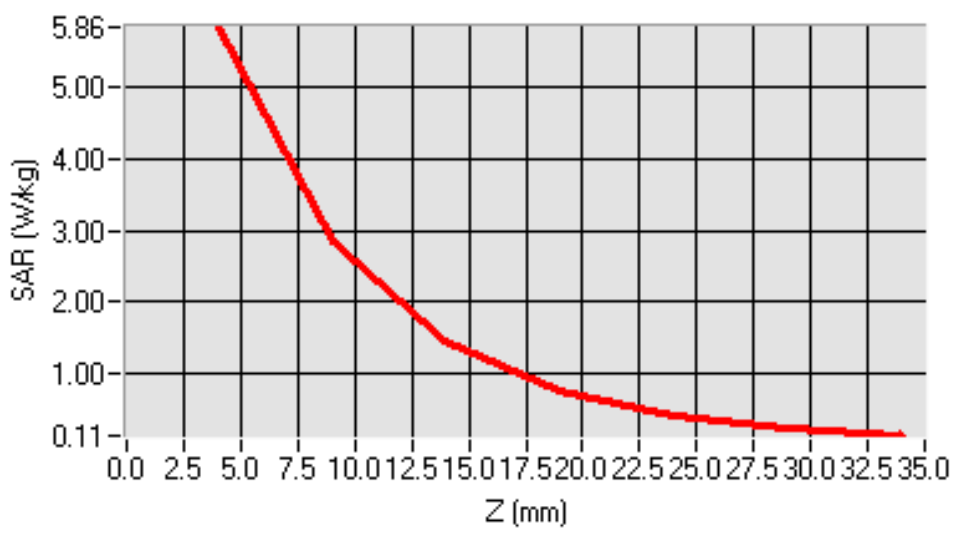

Test Mode: 2450MHz Validation (Body SAR)
Position: Flat Phantom
Product Description: N/A
Model: N/A
Test Date: June 21st, 2012

Frequency (MHz)	2450 (Body Liquid)
Relative permittivity (real part)	52.863
Relative permittivity (imaginary part)	14.983
Conductivity (S/m)	1.937
Variation (%)	-1.65
SAR 1g (W/Kg)	5.449
SURFACE SAR	VOLUME SAR

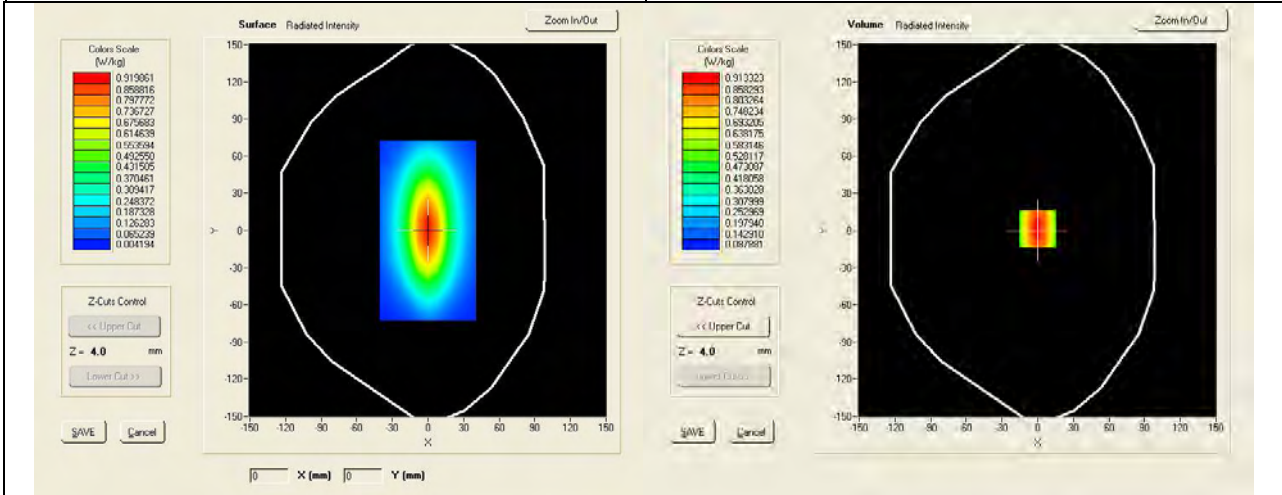

SAR, Z Axis Scan (X = 0, Y = 1)

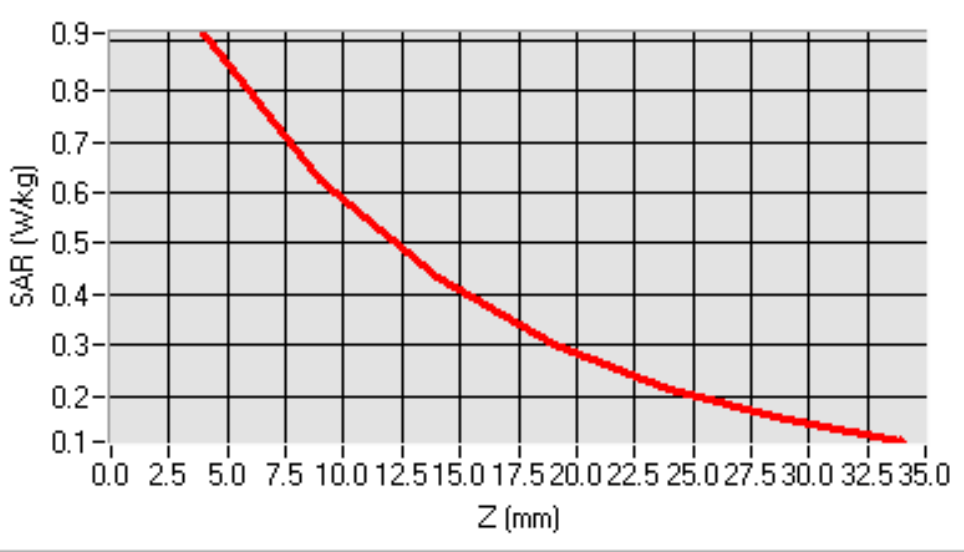

7 TYPE A MEASUREMENT UNCERTAINTY

The component of uncertainty may generally be categorized according to the methods used to evaluate them. The evaluation of uncertainty by the statistical analysis of a series of observations is termed a Type A evaluation of uncertainty. The evaluation of uncertainty by means other than the statistical analysis of a series of observation is termed a Type B evaluation of uncertainty. Each component of uncertainty, however evaluated, is represented by an estimated standard deviation, termed standard uncertainty, which is determined by the positive square root of the estimated variance

A Type A evaluation of standard uncertainty may be based on any valid statistical method for treating data. This includes calculating the standard deviation of the mean of a series of independent observations; using the method of least squares to fit a curve to the data in order to estimate the parameter of the curve and their standard deviations; or carrying out an analysis of variance in order to identify and quantify random effects in certain kinds of measurement.

A type B evaluation of standard uncertainty is typically based on scientific judgment using all of the relevant information available. These may include previous measurement data, experience and specification, data provided in calibration reports and uncertainties assigned to reference data taken from handbooks. Broadly speaking, the uncertainty is either obtained from an outdoor source or obtained from an assumed distribution, such as the normal distribution, rectangular or triangular distributions indicated in Table below :

Uncertainty Distribution	Normal	Rectangle	Triangular	U Shape
Multi-plying Factor ^(a)	1/k ^(b)	1/√3	1/√6	1/√2

(a) standard uncertainty is determined as the product of the multiplying factor and the estimated range of variations in the measured quantity
 (b) κ is the coverage factor

Standard Uncertainty for Assumed Distribution

The combined standard uncertainty of the measurement result represents the estimated standard deviation of the result. It is obtained by combining the individual standard uncertainties of both Type A and Type B -sum-by taking the positive square root of the estimated variances.

Expanded uncertainty is a measure of uncertainty that defines an interval about the measurement result within which the measured value is confidently believed to lie. It is obtained by multiplying the combined standard uncertainty by a coverage factor. Typically, the coverage factor ranges from 2 to 3. Using a coverage factor allows the true value of a measured quantity to be specified with a defined probability within the specified uncertainty range. For purpose of this document, a coverage factor two is used, which corresponds to confidence interval of about 95 %.

The COMOSAR Uncertainty Budget is show in below table:

Uncertainty Budget of COMOSAR for frequency range 300 MHz to 6 GHz

Uncertainty Component	Tolerances %	Probability Distribution	Divisor	Ci (1g)	Ci (10g)	Uncertainty 1g(%)	Uncertainty 10g(%)
Measurement System Related							
Probe Calibration	6	N	1	1	1	6	6
Axial Isotropy	3	R	$\sqrt{3}$	$\sqrt{(1-Cp)}$	$\sqrt{(1-Cp)}$	1.22474	1.22474
Hemispherical Isotropy	4	R	$\sqrt{3}$	\sqrt{Cp}	\sqrt{Cp}	1.63299	1.63299
Boundary Effect	1	R	$\sqrt{3}$	1	1	0.57735	0.57735
Linearity	5	R	$\sqrt{3}$	1	1	2.88675	2.88675
System Detection Limits	1	R	$\sqrt{3}$	1	1	0.57735	0.57735
Readout Electronics	0.5	N	1	1	1	0.5	0.5
Response Time	0.2	R	$\sqrt{3}$	1	1	0.11547	0.11547
Integration Time	2	R	$\sqrt{3}$	1	1	1.1547	1.1547
RF Ambient Conditions	3	R	$\sqrt{3}$	1	1	1.73205	1.73205
Probe Positioner Mechanical Tolerances	2	R	$\sqrt{3}$	1	1	1.1547	1.1547
Probe Positioning with respect to Phantom Shell	1	R	$\sqrt{3}$	1	1	0.57735	0.57735
Extrapolation, Interpolation and integration Algorithms for Max. SAR Evaluation.	1.5	R	$\sqrt{3}$	1	1	0.86603	0.86603
Test Sample Related							
Test Sample Positioning	1.5	N	1	1	1	1.5	1.5
Device Holder Uncertainty	5	N	1	1	1	5	5
Output Power Variation – SAR Drift measurement	3	R	$\sqrt{3}$	1	1	1.73205	1.73205
Phantom and Tissue Parameters Related							
Phantom Uncertainty (Shape and thickness Tolerances)	4	R	$\sqrt{3}$	1	1	2.3094	2.394
Liquid Conductivity – deviation from target value	5	R	$\sqrt{3}$	0.64	0.43	1.84752	1.2413
Liquid Conductivity – Measurement Uncertainty	2.5	N	1	0.64	0.43	1.6	1.075
Liquid Permittivity – deviation from target value	3	R	$\sqrt{3}$	0.6	0.49	1.03923	0.8487
Liquid Permittivity – Measurement Uncertainty	2.5	N	1	0.6	0.49	1.5	1.225
Combined Standard Uncertainty						9.66051 %	9.52428 %
Expanded Standard Uncertainty (K=2 , confidence 95%)						18.9346 %	18.6676 %

8 OUTPUT POWER VERIFICATION

Test Condition:

1. Conducted Measurement
 EUT was set for low, mid, high channel with modulated mode and highest RF output power.
 The base station simulator was connected to the antenna terminal.
2. Conducted Emissions Measurement Uncertainty
 All test measurements carried out are traceable to national standards. The uncertainty of the measurement at a confidence level of approximately 95% (in the case where distributions are normal), with a coverage factor of 2, in the range 30MHz – 40GHz is $\pm 1.5\text{dB}$.
3. Environmental Conditions

Temperature	23°C
Relative Humidity	50%
Atmospheric Pressure	1019mbar
4. Test Date : June 21st, 2012
 Tested By :David Zhang

Test Procedures:

Radio output power measurement

1. The transmitter output port was connected to spectrum analyser.
2. Setup EUT into continuous transmitting mode with 100% duty cycle.
3. Select lowest, middle, and highest channels for each band and different possible test mode.
4. Measure the conducted peak burst power and conducted average burst power from EUT antenna port.

Test Result:

WIFI Mode

802.11b/g/a/n mode (2.4GHz band)

Mode	Channel No.	Frequency (MHz)	Data Rate	Conducted Average Power(dBm)
802.11b	1	2412	11 Mbps	20.87
802.11b	6	2437	11 Mbps	21.60
802.11b	11	2462	11 Mbps	23.00
802.11g	1	2412	54Mbps	18.90
802.11g	6	2437	54 Mbps	19.41
802.11g	11	2462	54 Mbps	21.14
802.11n-20MHz	1	2412	75.5Mbps	19.25
802.11n-20MHz	6	2437	75.5Mbps	19.96
802.11n-20MHz	11	2462	75.5Mbps	21.70

Bluetooth Mode

Bluetooth Mode – Basic Data Rate

Channel number	Frequency (MHz)	Average Output Power(dBm)
1	2402	0.48
40	2441	1.69
79	2480	1.86

Bluetooth Mode – Enhanced Data Rate

Channel number	Frequency (MHz)	Average Output Power(dBm)
1	2402	3.35
40	2441	4.55
79	2480	4.58

9 SAR TEST RESULTS

Test Condition:

1. SAR Measurement
2. Measurement Uncertainty: See page 26 for detail
3. Environmental Conditions

Temperature	23°C
Relative Humidity	50%
Atmospheric Pressure	1019mbar
4. Test Date : June 21st, 2012
 Tested By :David Zhang

Test Procedures:

1. Establish communication link between EUT and base station emulation by air link.
2. Consider the SAR test reduction per FCC KDB guide line. Set EUT into highest output power channel with test mode which has the maximum average burst power listed in power table.
3. Place the EUT in the selected test position. (Cheek, tilt or flat)
4. Perform SAR testing at highest output power channel under the selected test mode. If the measured 1-g SAR is ≤ 0.8 W/kg, then testing for the other channel will not be performed.
4. Measure the conducted peak burst power and conducted average burst power from EUT antenna port.

Note: FCC KDB applied

- 248227 D01 SAR meas for 802 11 a b g v01r02
- 648474 D01 SAR Handsets Multi Xmitter and Ant v01r05
- 648474 D02 SAR Polcy Handsts Multi Xmitter Ant v01r01
- 643646 D01 SAR Test for PTT Radios v01r01

SAR measurement system will proceed the following basic steps:

1. Initial power reference measurement
2. Area Scan
3. Zoom Scan
4. Power drift measurement

Area Scan and Zoom Scan Description:

The resolution for 2.4GHz band SAR measurement is at below,

Area Scan	dx=8mm dy=8mm
Zoom Scan	dx=5mm dy=5mm dz=3mm
Zoom Scan Volume	90mm x 60mm x 40mm

The resolution for 5GHz band SAR measurement is at below,

Area Scan	dx=8mm dy=8mm
Zoom Scan	dx=4mm dy=4mm dz=2.5mm
Zoom Scan Volume	90mm x 60mm x 40mm

Test Configuration Summary:

1. For 2.4GHz band, SAR testing was performed under 802.11b mode, with 11Mbps data rate, which had the highest average output power; and the 802.11n mode was also verified.
2. 1007CP01 computer can be used either handheld or body worn. Different orientation of EUT were evaluated, including the LCD Up, LCD down, Left side, right side. The front side of the EUT is bar code scanner, which won't be held by people or directly against human body, so this orientation is not necessary to be evaluated.

Test Result:

WIFI Mode

Body Worn SAR Test Result without accessories for 2.4GHz band, High data rate (Separation distance: 1cm)

Test Configuration , Body				Crest Factor : 0	Date of Measured : June 21st, 2012		
Freq Band	Mode	Channel	Position	SAR 1g(W/kg)	1g SAR Limit (W/kg)	Variation (%)	
2462MHz	802.11b	11	LCD Up	0.522	1.6	-0.40	
2462MHz	802.11g	11	LCD Up	0.492	1.6	0.82	
2462MHz	802.11n	11	LCD Up	0.515	1.6	0.10	
2462MHz	802.11b	11	LCD Down	0.027	1.6	-2.54	
2462MHz	802.11g	11	LCD Down	0.025	1.6	0.94	
2462MHz	802.11n	11	LCD Down	0.100	1.6	-0.16	
2462MHz	802.11b	11	Left Side Bar	0.041	1.6	-3.51	
2462MHz	802.11g	11	Left Side Bar	0.039	1.6	-4.79	
2462MHz	802.11n	11	Left Side Bar	0.080	1.6	0.32	
2462MHz	802.11b	11	Right Side Bar	0.042	1.6	-3.70	
2462MHz	802.11g	11	Right Side Bar	0.002	1.6	-3.82	
2462MHz	802.11n	11	Right Side Bar	0.003	1.6	1.84	

Body Worn SAR Test Result with accessories for 2.4GHz band, High data rate (Separation distance: 0cm)

Test Configuration , Body				Crest Factor : 0	Date of Measured : June 21st, 2012		
Freq Band	Mode	Channel	Accessories / Position	SAR 1g(W/kg)	1g SAR Limit (W/kg)	Variation (%)	
2462MHz	802.11b	11	Belt clip type 1/ LCD Up	0.207	1.6	-1.97	
2462MHz	802.11b	11	Belt clip type 1/ Left Side	0.341	1.6	0.02	
2462MHz	802.11b	11	Bar code Scanner / Left Side	0.179	1.6	2.05	
2462MHz	802.11b	11	Bar code Scanner / Right Side	0.053	1.6	-2.71	

Head SAR Test Result for Push to talk function (Separation distance: 0cm)

Test Configuration , Head				Crest Factor : 0	Date of Measured : June 21st, 2012		
Freq Band	Mode	Channel	Position	SAR 1g(W/kg)	1g SAR Limit (W/kg)	1g SAR Limit (W/kg)	
2462MHz	802.11b	11	LCD Up	0.201	1.6	-1.16	
2462MHz	802.11g	11	LCD Up	0.097	1.6	-3.36	
2462MHz	802.11n	11	LCD Up	0.191	1.6	-1.77	

Bluetooth Mode

N/A

Note: SAR for Bluetooth mode was not applicable because of the low output power.

Per KDB 648474 D01 SAR Handsets Multi Xmitter and Ant v01r05 requirement , stand-alone SAR is not required for an unlicensed transmitter with output power \leq PRef mW when either the output power or 1-g SAR for each of the other antennas within 2.5 cm of that unlicensed transmitting antenna is \leq PRef mW or $<$ 1.2 W/kg. The measurement SAR of 802.11 b/g/n radio is $<$ 1.2 W/kg, though Bluetooth can be work simultaneously with 802.11b/g/n radio, the standalone SAR is still not required for Bluetooth function.

KDB & Simultaneous SAR Evaluation for BT/WLAN

N/A

Note:

BT can work simultaneously with 802.11b/g/n radio and they share same antenna.

Per KDB 648474 D01 SAR Handsets Multi Xmitter and Ant v01r05 requirement , when simultaneous transmission applies and the sum of the 1-g SAR measured for all simultaneous transmitting antennas is less than the SAR limit, SAR evaluation for simultaneous transmission is not required for all transmitters and antennas.

Total SAR = SAR (802.11b/g/n) + SAR (BT) = 0.522 W/kg + 0 = 0.522 W/kg < 1.6 W/kg

So the simultaneous SAR evaluation is not required.

EUT antenna Location

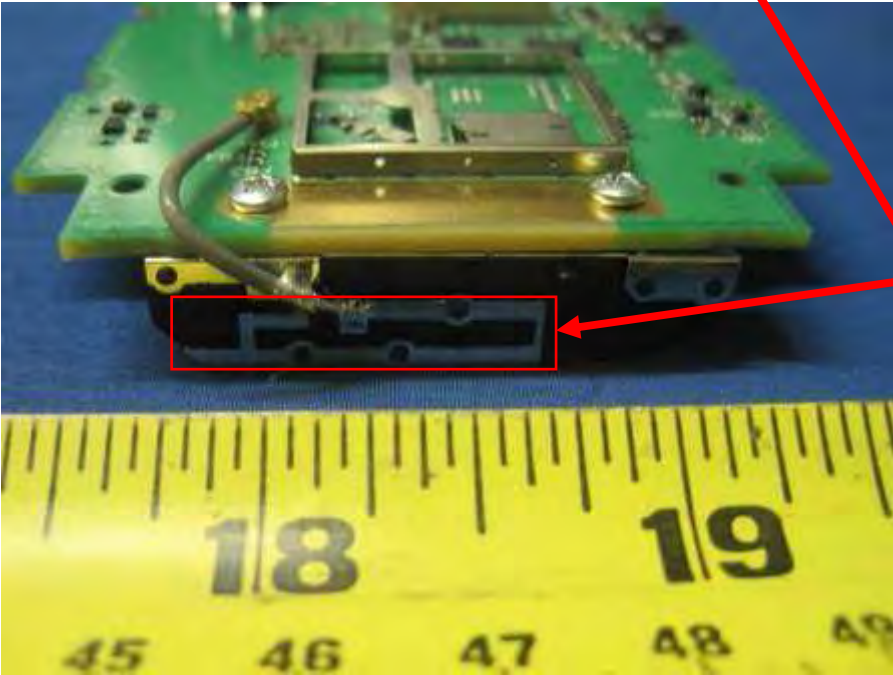

Antenna Location (802.11b/g/n and BT share same antenna). They can work simultaneously.

SAR measurement Plots
WLAN 802.11b Mode

Position- LCD Up
 Product Description : Handheld Computer
 Model : 1007CP01
 Test Date : Jun 21st, 2012

Frequency (MHz)	2462.00 (Flat, Phone measurement)
Relative permittivity (real part)	52.91
Relative permittivity (imaginary part)	14.31
Conductivity (S/m)	1.94
Variation (%)	-0.40
SAR 10g (W/Kg)	0.292
SAR 1g (W/Kg)	0.522

SURFACE SAR

VOLUME SAR

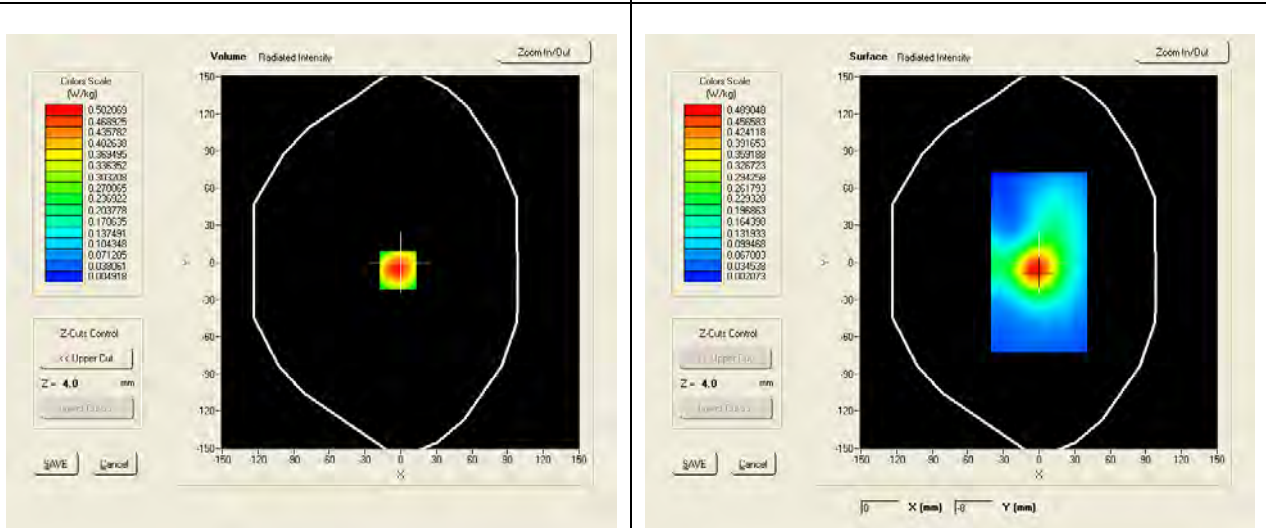

SAR, Z Axis Scan (X = -2, Y = -6)

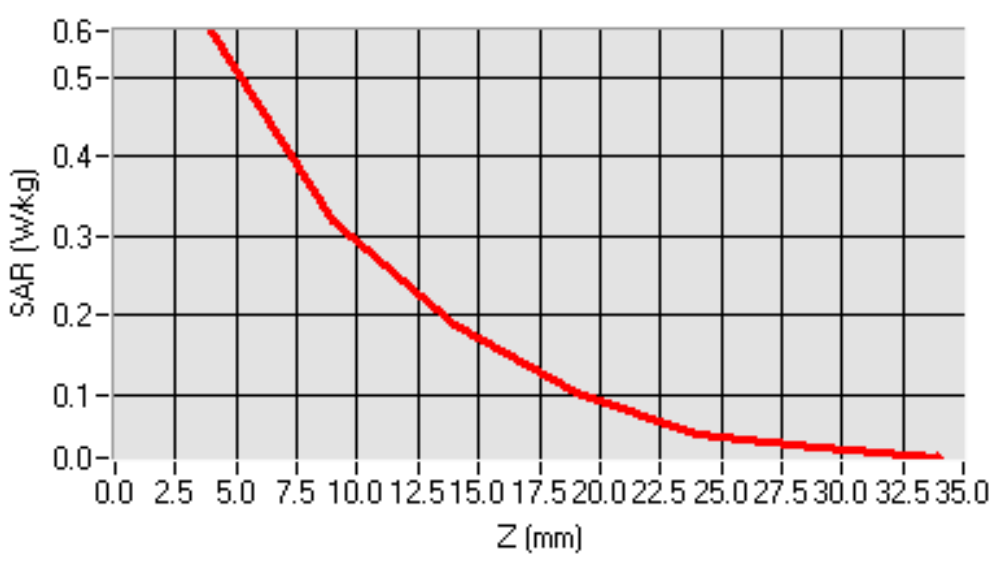

WLAN 802.11g Mode

Position- LCD Up
 Product Description : Handheld Computer
 Model : 1007CP01
 Test Date : Jun 21st, 2012

Frequency (MHz)	2462.00 (Flat, Phone measurement)
Relative permittivity (real part)	52.91
Relative permittivity (imaginary part)	14.31
Conductivity (S/m)	1.94
Variation (%)	0.82
SAR 10g (W/Kg)	0.275
SAR 1g (W/Kg)	0.492
SURFACE SAR	VOLUME SAR

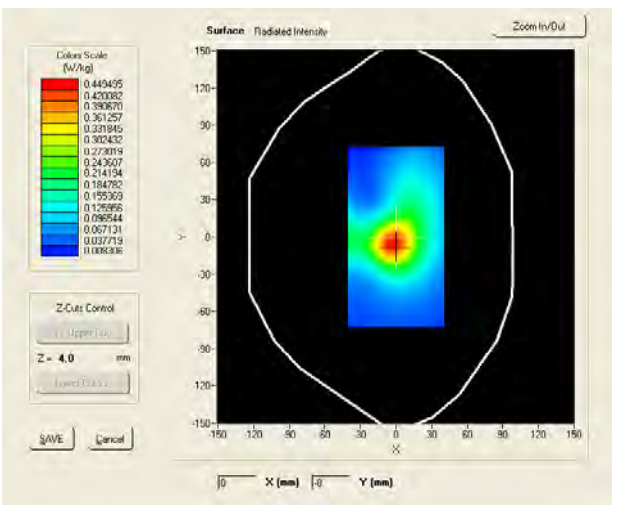
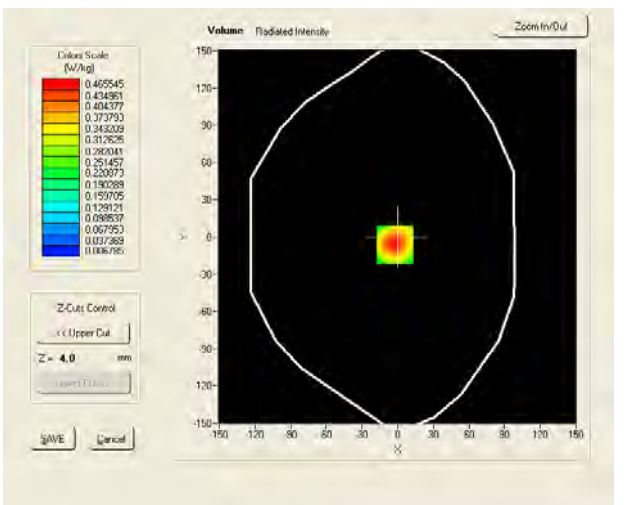

SAR, Z Axis Scan (X = -2, Y = -6)

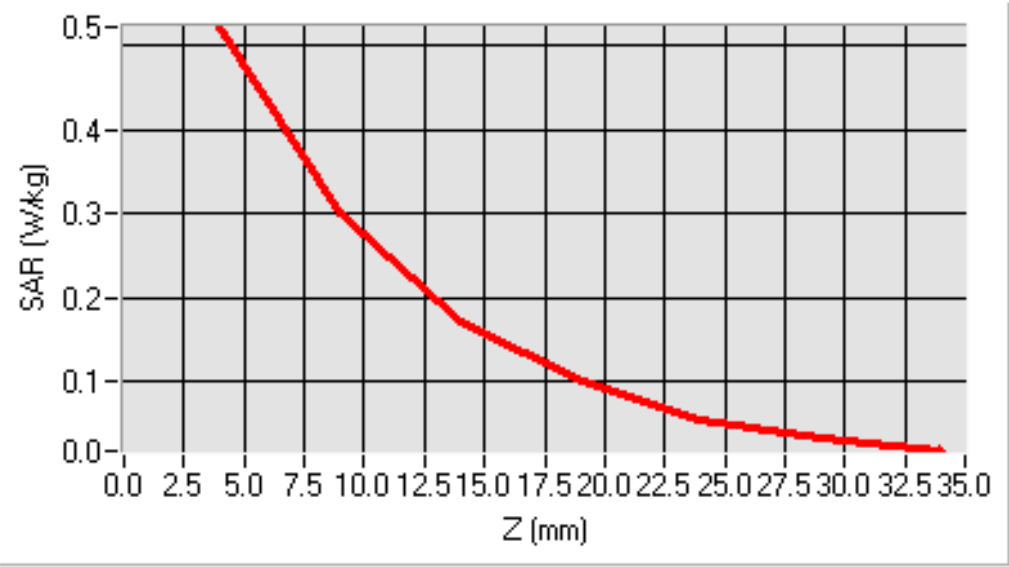

WLAN 802.11n Mode

Position- LCD Up
Product Description : Handheld Computer
Model : 1007CP01
Test Date : Jun 21st, 2012

Frequency (MHz)	2462.00 (Flat, Phone measurement)
Relative permittivity (real part)	52.91
Relative permittivity (imaginary part)	14.31
Conductivity (S/m)	1.94
Variation (%)	0.10
SAR 10g (W/Kg)	0.287
SAR 1g (W/Kg)	0.515

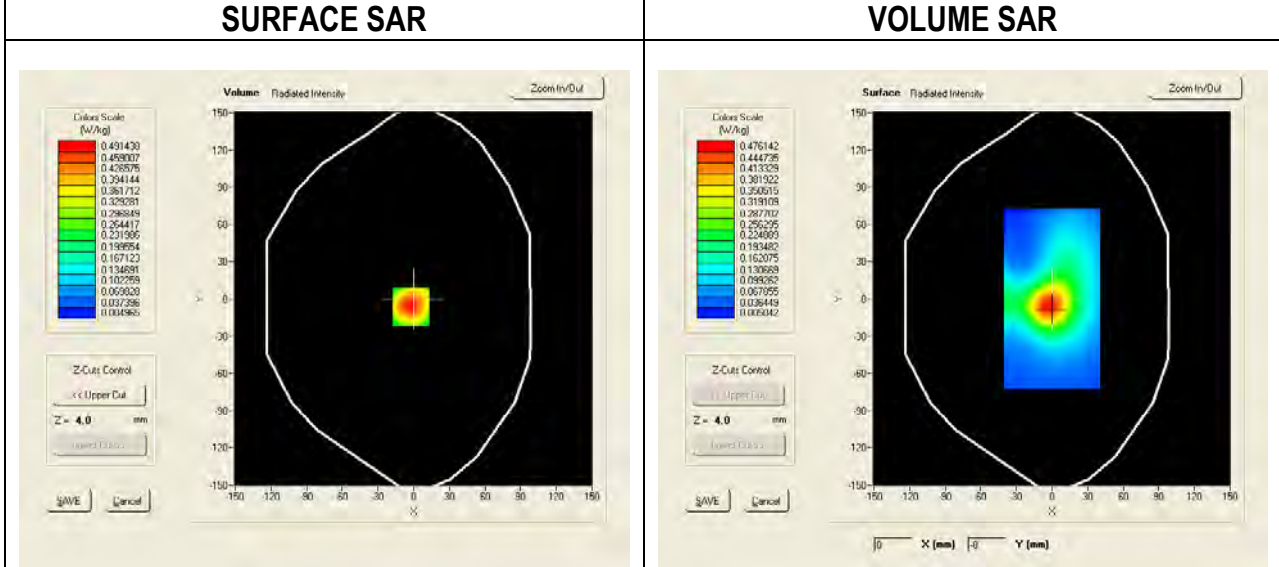

SAR, Z Axis Scan (X = -2, Y = -6)

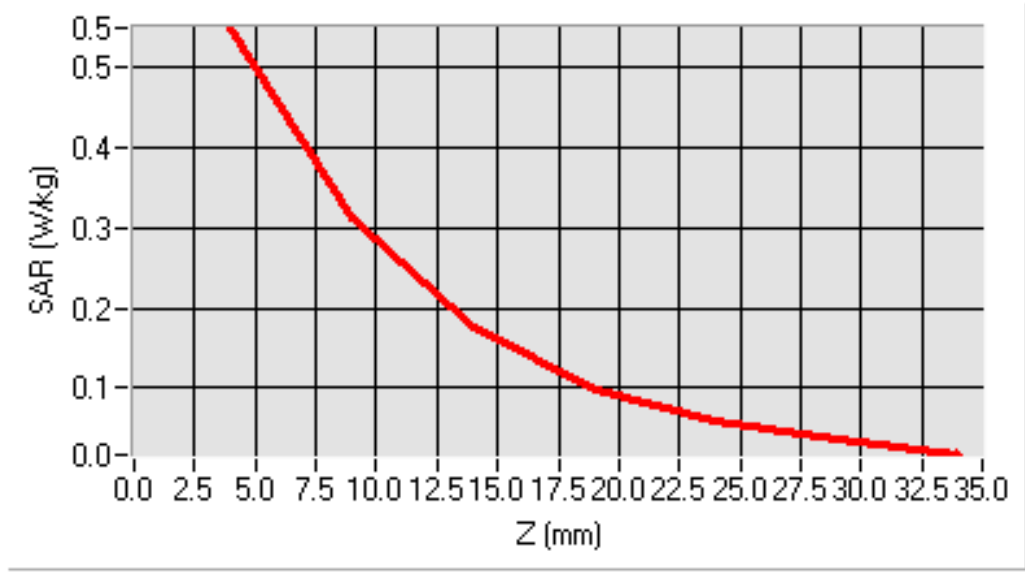

WLAN 802.11b Mode

Position- LCD Down

Product Description : Handheld Computer

Model : 1007CP01

Test Date : Jun 21st, 2012

Frequency (MHz)	2462.00 (Flat, Phone measurement)
Relative permittivity (real part)	52.91
Relative permittivity (imaginary part)	14.31
Conductivity (S/m)	1.94
Variation (%)	-2.54
SAR 10g (W/Kg)	0.009
SAR 1g (W/Kg)	0.027
SURFACE SAR	VOLUME SAR

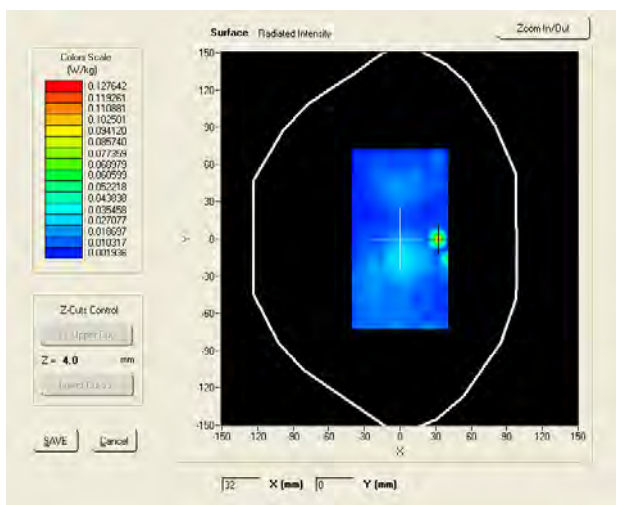
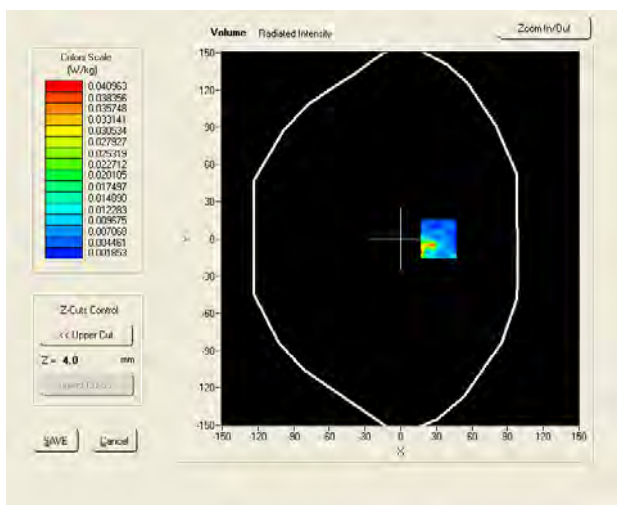

SAR, Z Axis Scan (X = 32, Y = 0)

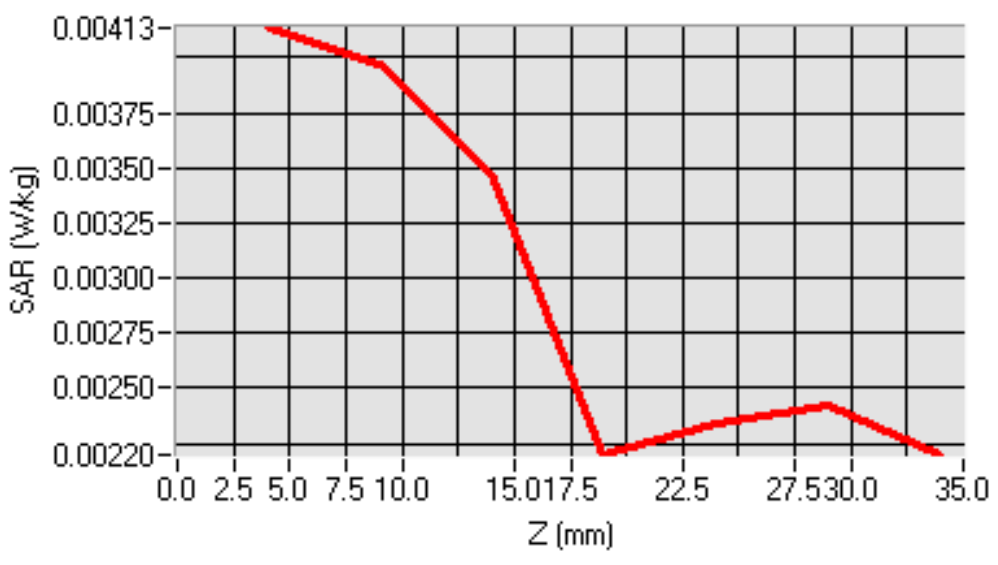

WLAN 802.11g Mode

Position- LCD Down

Product Description : Handheld Computer

Model : 1007CP01

Test Date : Jun 21st, 2012

Frequency (MHz)	2462.00 (Flat, Phone measurement)
Relative permittivity (real part)	52.91
Relative permittivity (imaginary part)	14.31
Conductivity (S/m)	1.94
Variation (%)	0.94
SAR 10g (W/Kg)	0.011
SAR 1g (W/Kg)	0.025
SURFACE SAR	VOLUME SAR

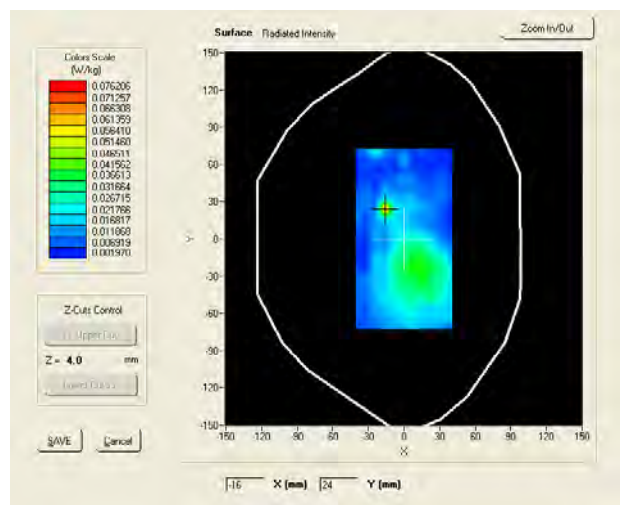
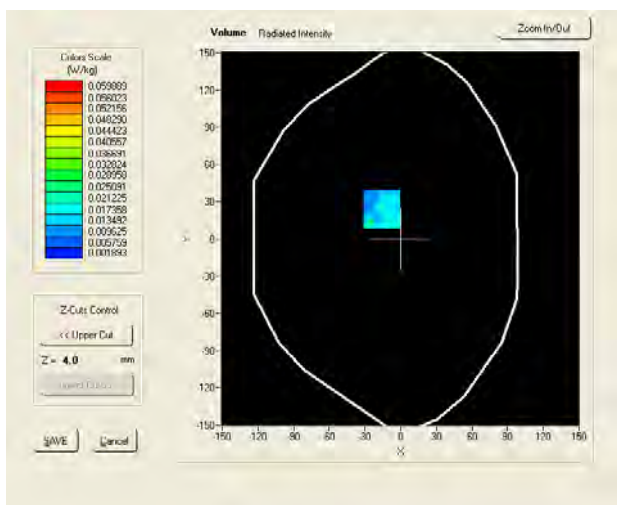

SAR, Z Axis Scan (X = -16, Y = 24)

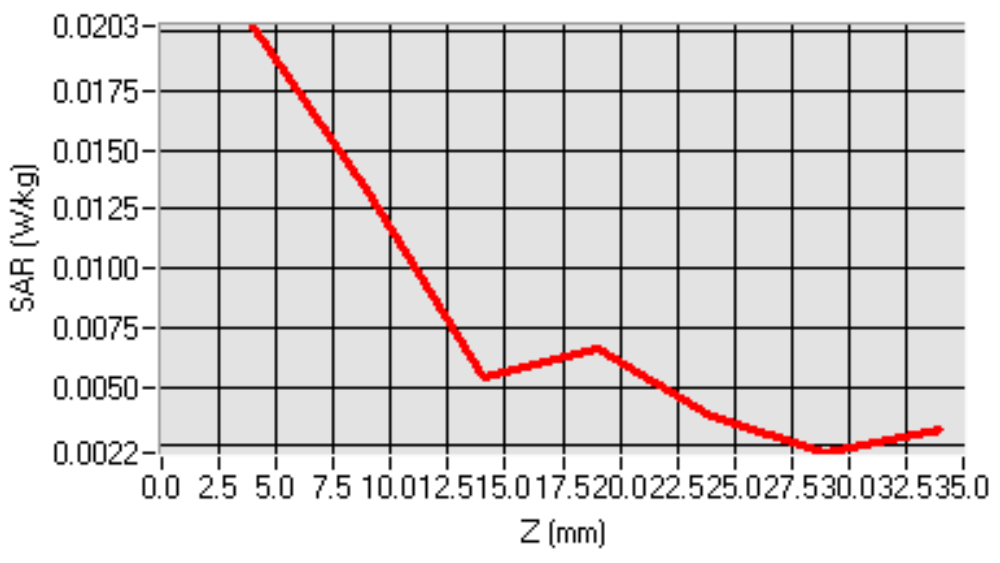

Position- LCD Down
Product Description : Handheld Computer
Model : 1007CP01
Test Date : Jun 21st, 2012

Frequency (MHz)	2462.00 (Flat, Phone measurement)
Relative permittivity (real part)	52.91
Relative permittivity (imaginary part)	14.31
Conductivity (S/m)	1.94
Variation (%)	-0.16
SAR 10g (W/Kg)	0.055
SAR 1g (W/Kg)	0.100

SURFACE SAR

VOLUME SAR

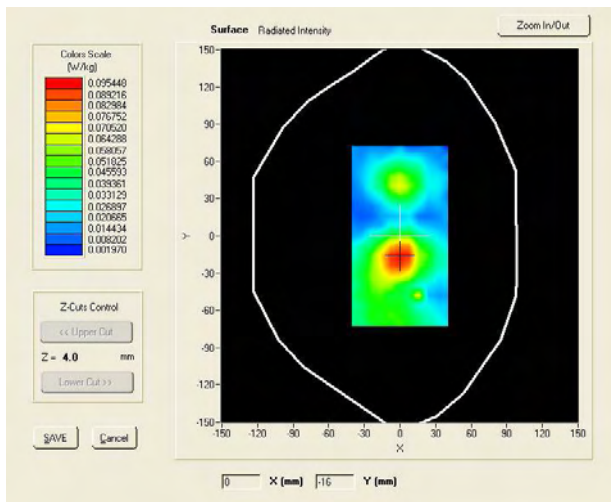
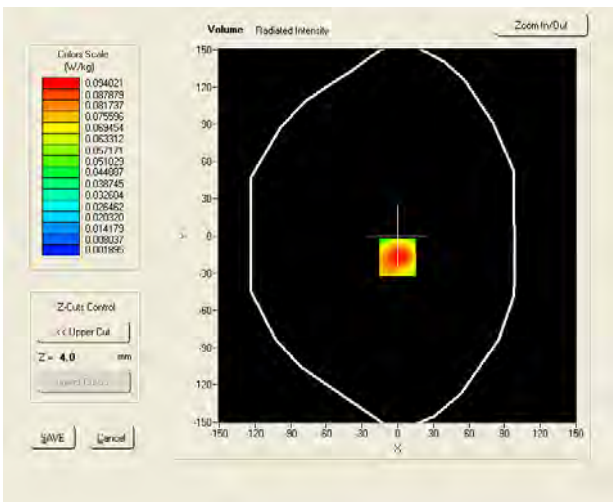

SAR, Z Axis Scan (X = 0, Y = -17)

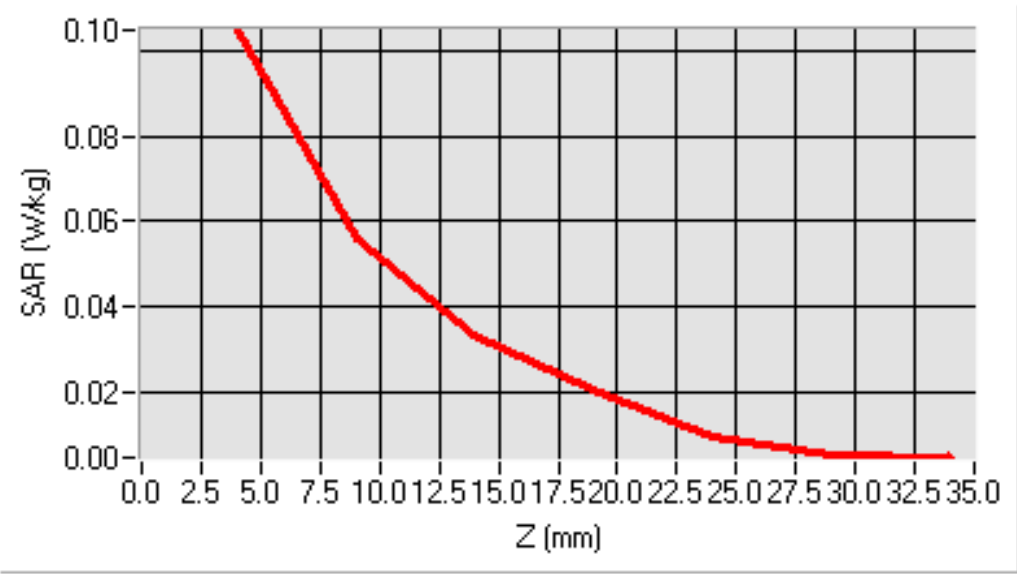

Position- Left side
Product Description : Handheld Computer
Model : 1007CP01
Test Date : Jun 21st, 2012

Frequency (MHz)	2462.00 (Flat, Phone measurement)
Relative permittivity (real part)	52.91
Relative permittivity (imaginary part)	14.31
Conductivity (S/m)	1.94
Variation (%)	-3.51
SAR 10g (W/Kg)	0.021
SAR 1g (W/Kg)	0.041

SURFACE SAR

VOLUME SAR

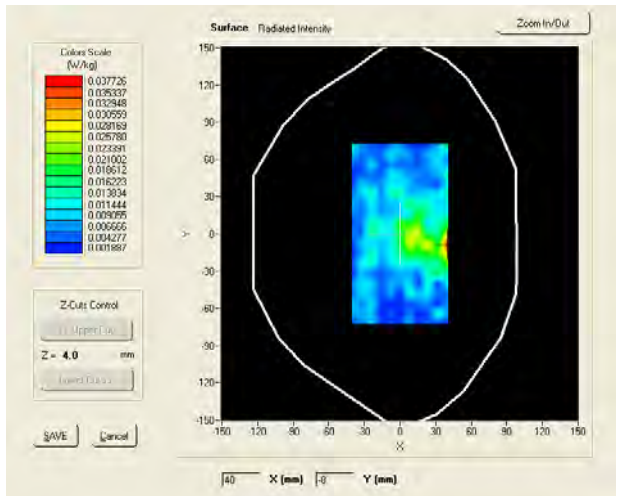
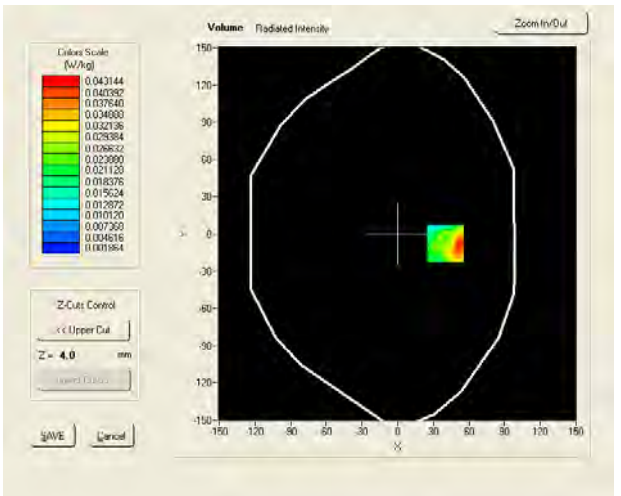

SAR, Z Axis Scan (X = 40, Y = -8)

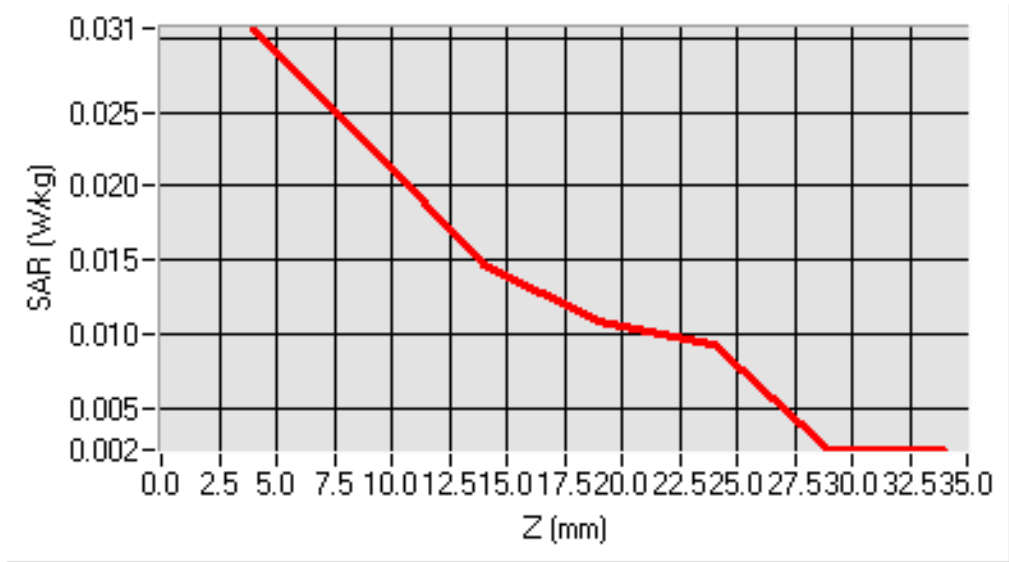

WLAN 802.11g Mode

Position- Left Side

Product Description : Handheld Computer

Model : 1007CP01

Test Date : Jun 21st, 2012

Frequency (MHz)	2462.00 (Flat, Phone measurement)
Relative permittivity (real part)	52.91
Relative permittivity (imaginary part)	14.31
Conductivity (S/m)	1.94
Variation (%)	-4.79
SAR 10g (W/Kg)	0.023
SAR 1g (W/Kg)	0.039
SURFACE SAR	VOLUME SAR

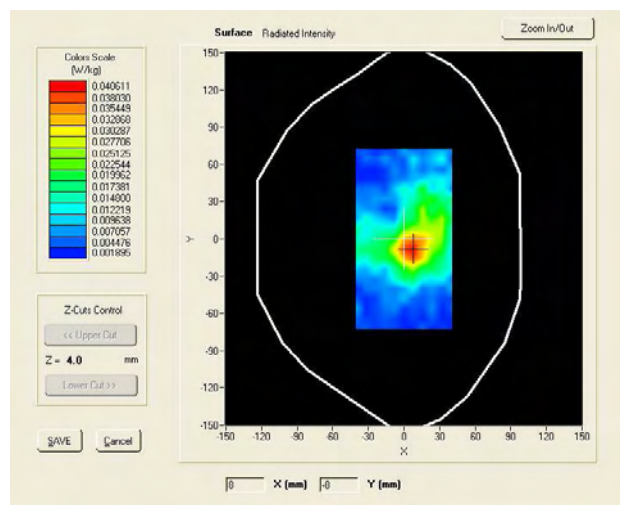
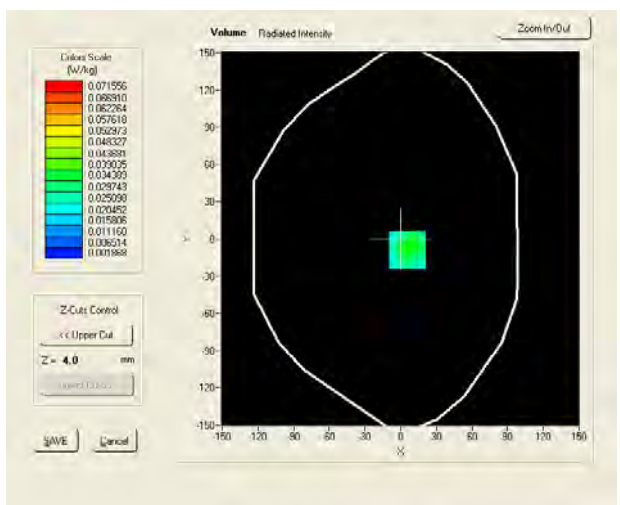

SAR, Z Axis Scan (X = 6, Y = -9)

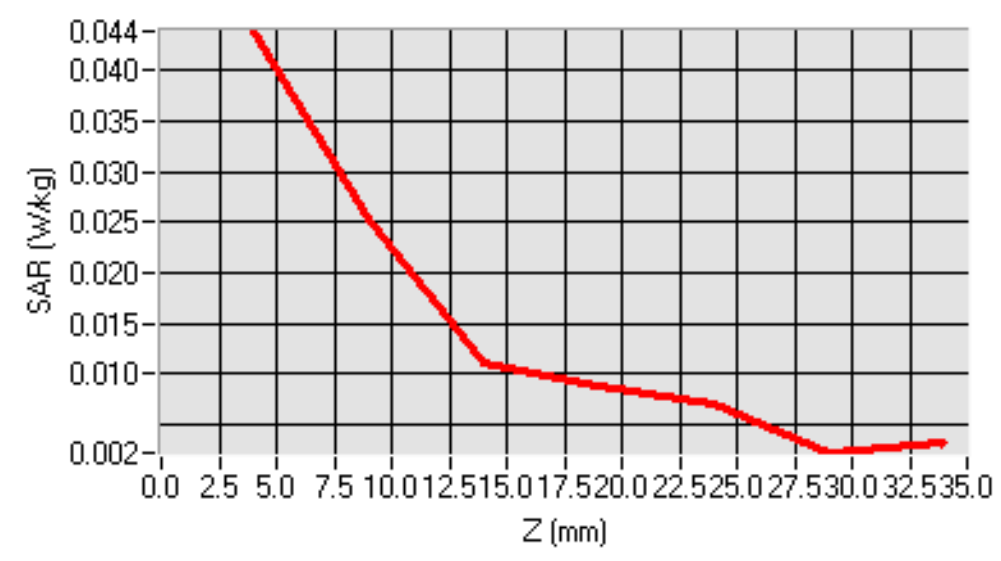

WLAN 802.11n Mode

Position- Left Side
 Product Description : Handheld Computer
 Model : 1007CP01
 Test Date : Jun 21st, 2012

Frequency (MHz)	2462.00 (Flat, Phone measurement)
Relative permittivity (real part)	52.91
Relative permittivity (imaginary part)	14.31
Conductivity (S/m)	1.94
Variation (%)	0.32
SAR 10g (W/Kg)	0.044
SAR 1g (W/Kg)	0.080

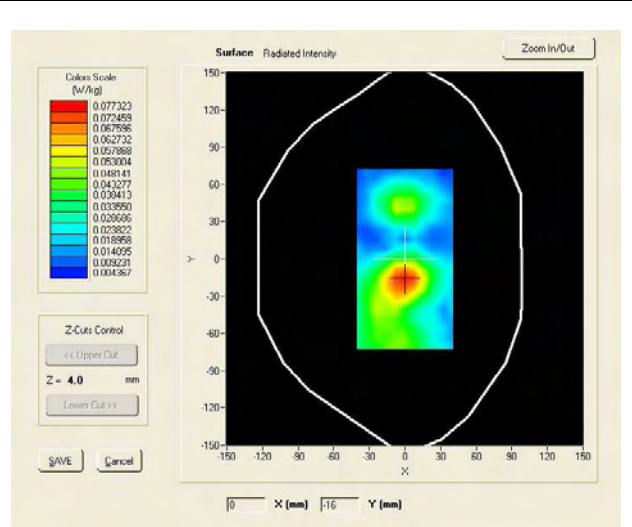
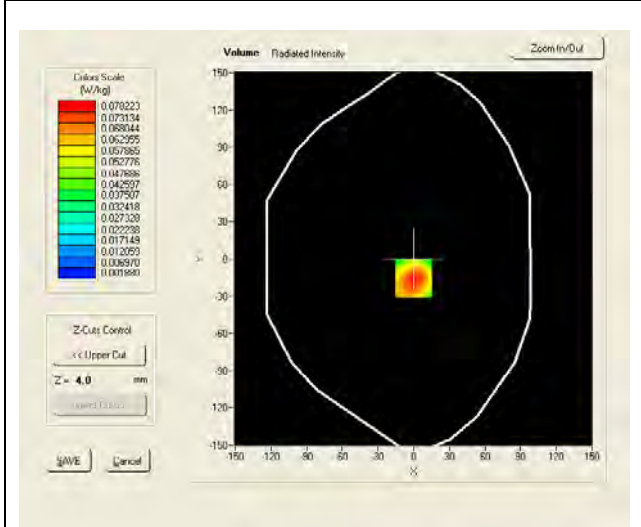

SAR, Z Axis Scan (X = 0, Y = -16)

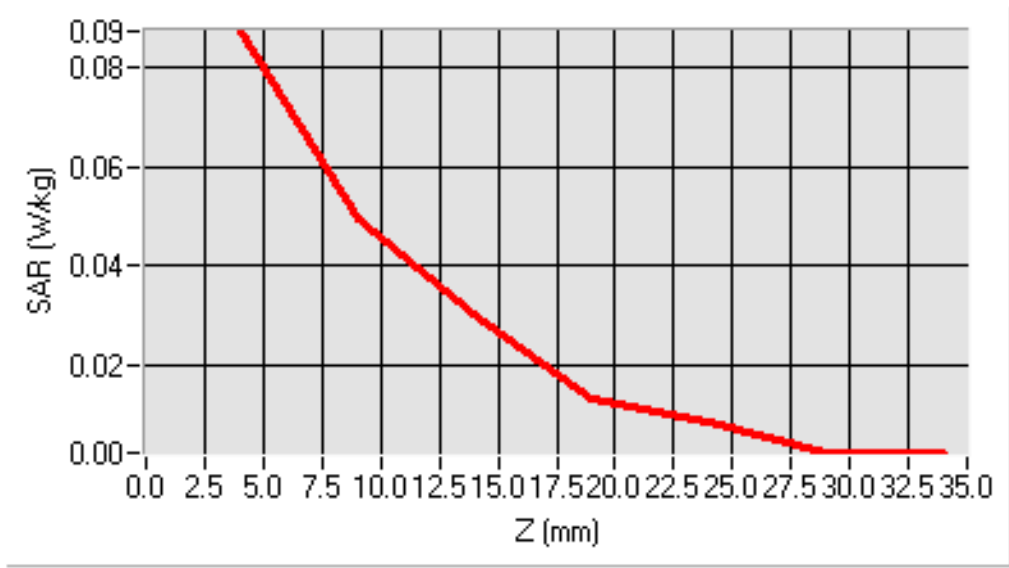

WLAN 802.11b Mode

Position- Right side

Product Description : Handheld Computer

Model : 1007CP01

Test Date : Jun 21st, 2012

Frequency (MHz)	2462.00 (Flat, Phone measurement)
Relative permittivity (real part)	52.91
Relative permittivity (imaginary part)	14.31
Conductivity (S/m)	1.94
Variation (%)	-3.70
SAR 10g (W/Kg)	0.023
SAR 1g (W/Kg)	0.042

SURFACE SAR

VOLUME SAR

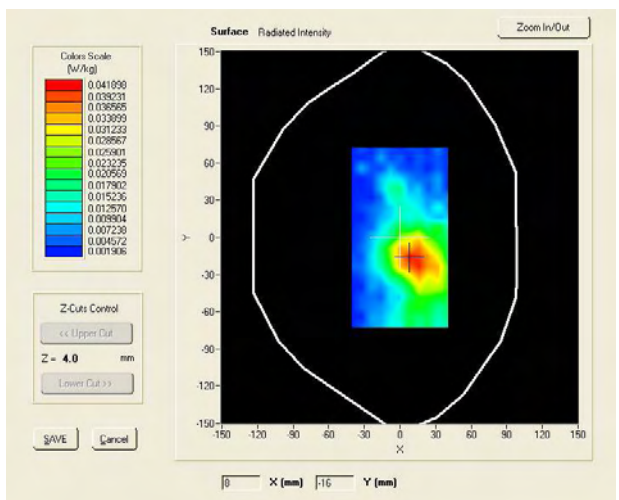
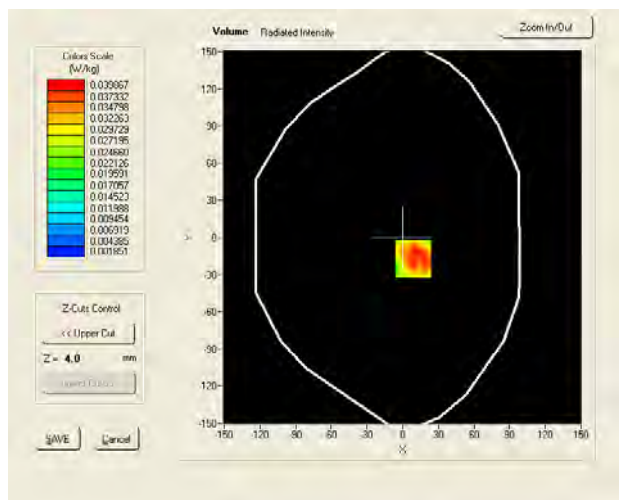

SAR, Z Axis Scan (X = 9, Y = -17)

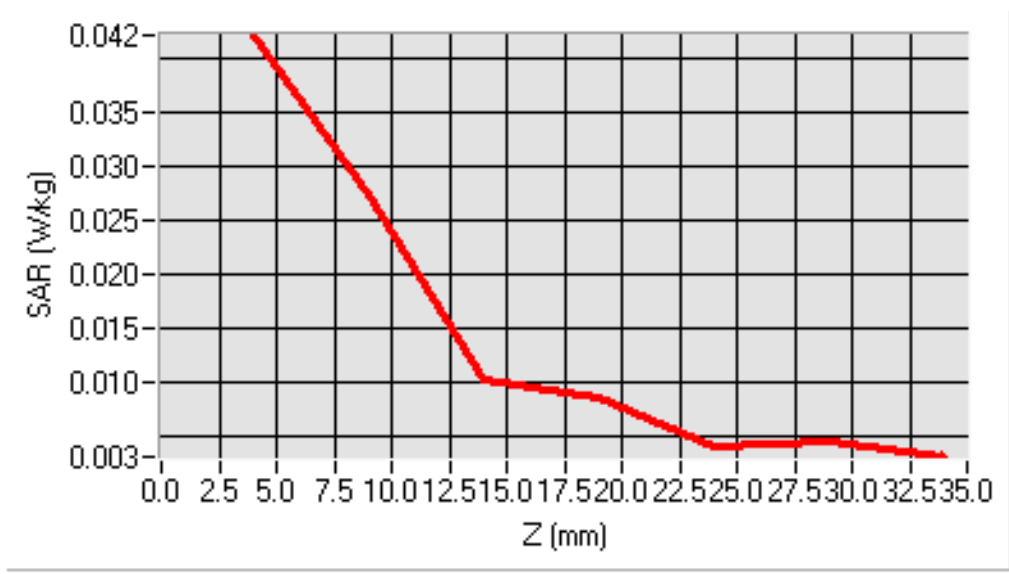

WLAN 802.11g Mode
Position- Right Side
Product Description : Handheld Computer
Model : 1007CP01
Test Date : Jun 21st, 2012

Frequency (MHz)	2462.00 (Flat, Phone measurement)
Relative permittivity (real part)	52.91
Relative permittivity (imaginary part)	14.31
Conductivity (S/m)	1.94
Variation (%)	-3.82
SAR 10g (W/Kg)	0.002
SAR 1g (W/Kg)	0.002

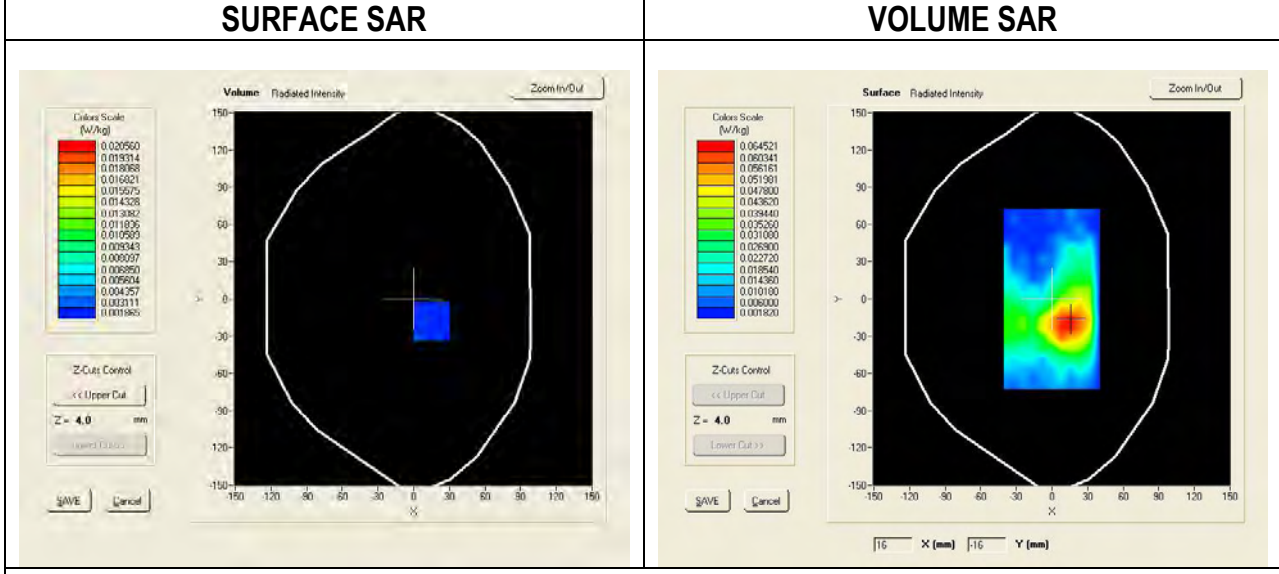

SAR, Z Axis Scan (X = 15, Y = -18)

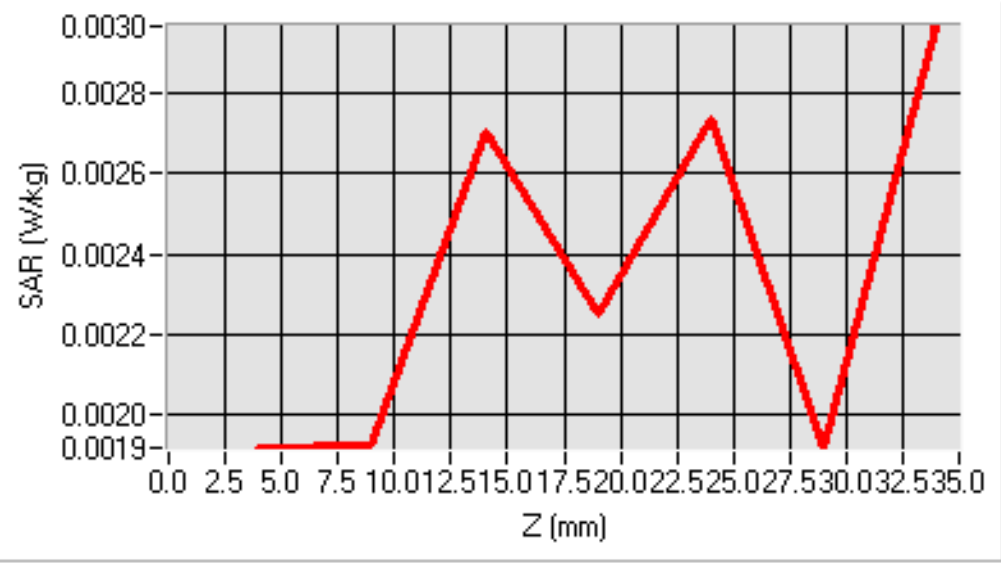

WLAN 802.11n Mode

Position- Right Side
 Product Description : Handheld Computer
 Model : 1007CP01
 Test Date : Jun 21st, 2012

Frequency (MHz)	2462.00 (Flat, Phone measurement)
Relative permittivity (real part)	52.91
Relative permittivity (imaginary part)	14.31
Conductivity (S/m)	1.94
Variation (%)	1.84
SAR 10g (W/Kg)	0.003
SAR 1g (W/Kg)	0.003

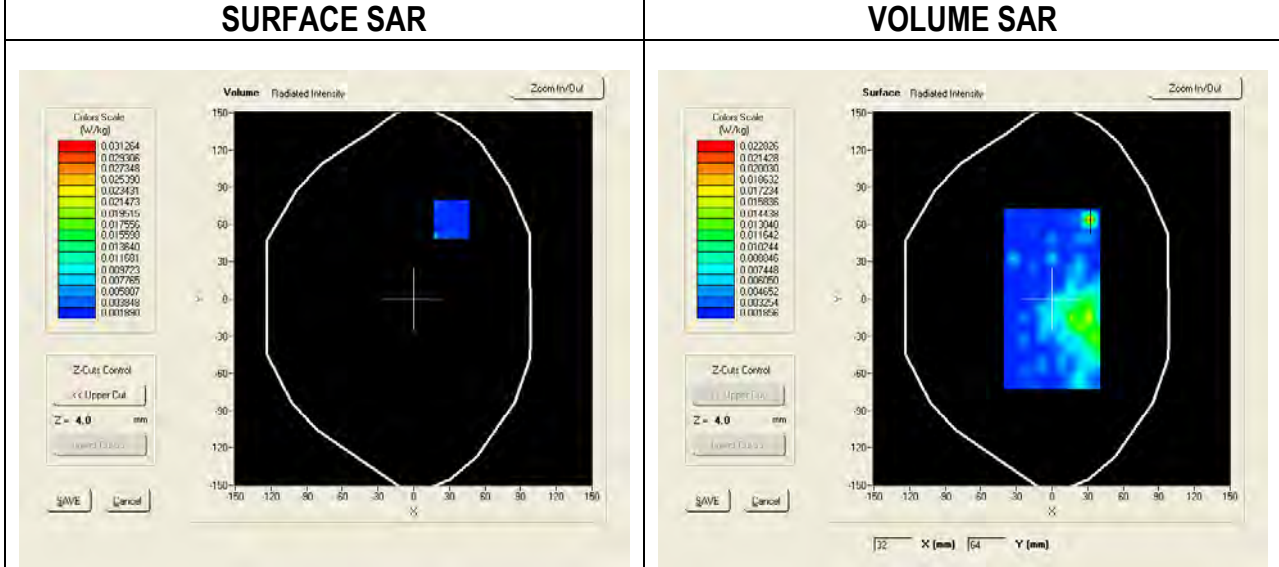

SAR, Z Axis Scan (X = 32, Y = 64)

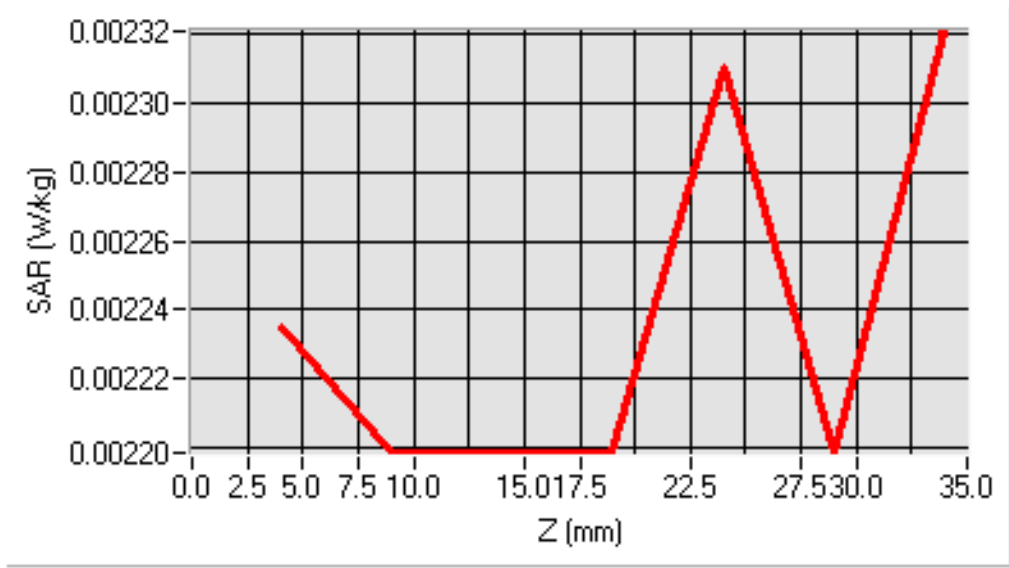

WLAN 802.11b Mode

Position- LCD Up (Push to talk)

Product Description : Handheld Computer

Model : 1007CP01

Test Date : Jun 21st, 2012

Frequency (MHz)	2462.00 (Flat, Phone measurement, head liquid)
Relative permittivity (real part)	40.63
Relative permittivity (imaginary part)	12.82
Conductivity (S/m)	1.78
Variation (%)	-1.16
SAR 10g (W/Kg)	0.116
SAR 1g (W/Kg)	0.201

SURFACE SAR

VOLUME SAR

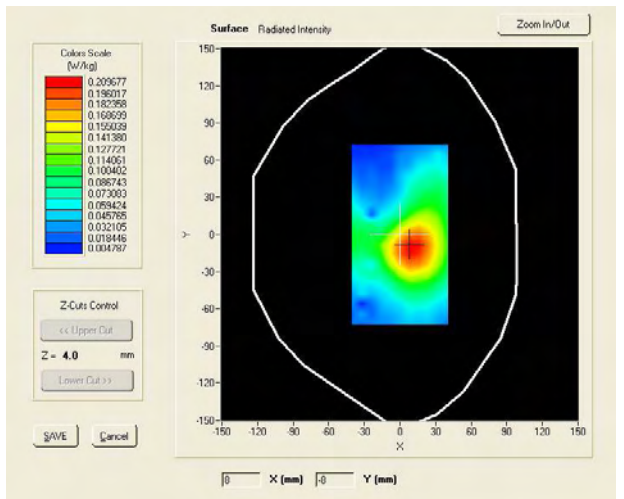
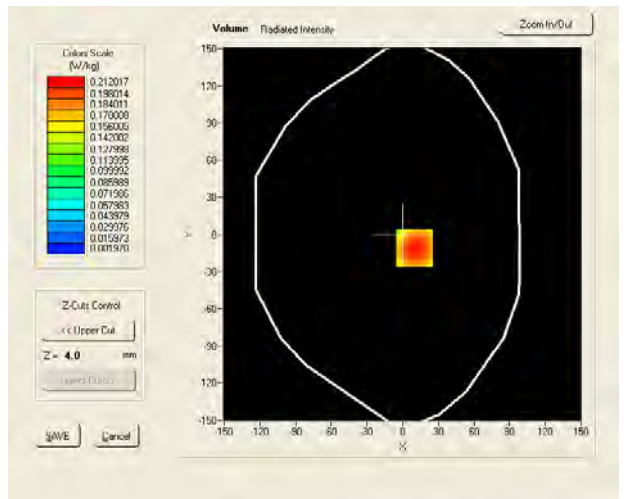

SAR, Z Axis Scan (X = 10, Y = -11)

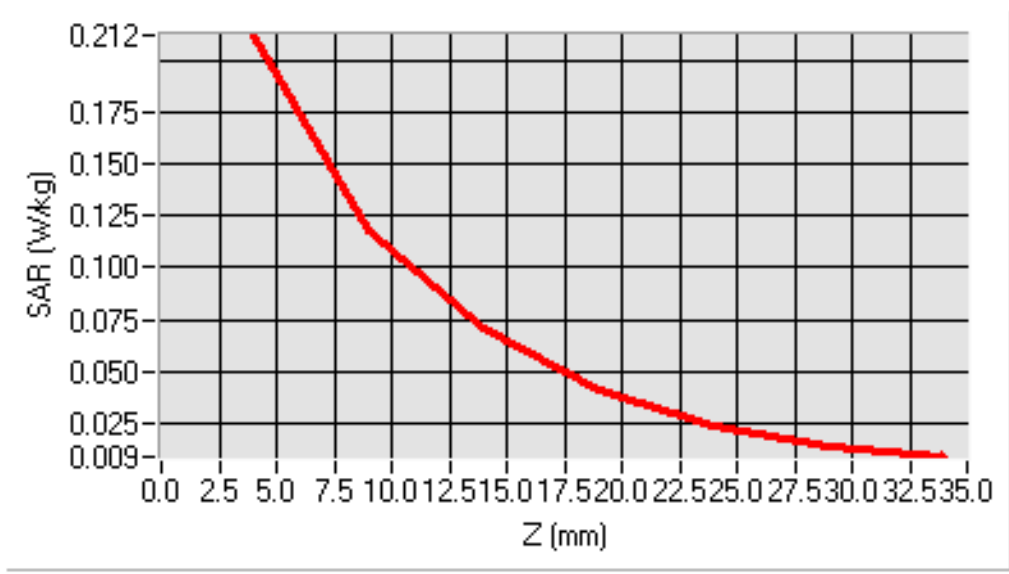

WLAN 802.11g Mode
 Position- LCD Up (Push to talk)
 Product Description : Handheld Computer
 Model : 1007CP01
 Test Date : Jun 21st, 2012

Frequency (MHz)	2462.00 (Flat, Phone measurement, head liquid)
Relative permittivity (real part)	40.63
Relative permittivity (imaginary part)	12.82
Conductivity (S/m)	1.78
Variation (%)	-3.36
SAR 10g (W/Kg)	0.057
SAR 1g (W/Kg)	0.097

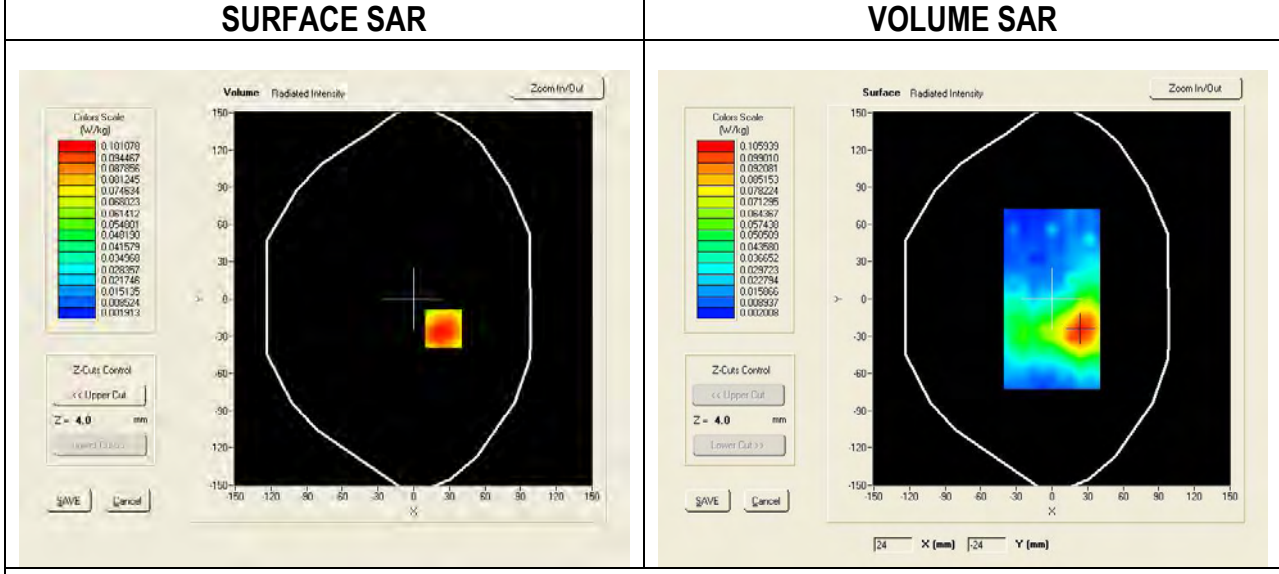

SAR, Z Axis Scan (X = 25, Y = -24)

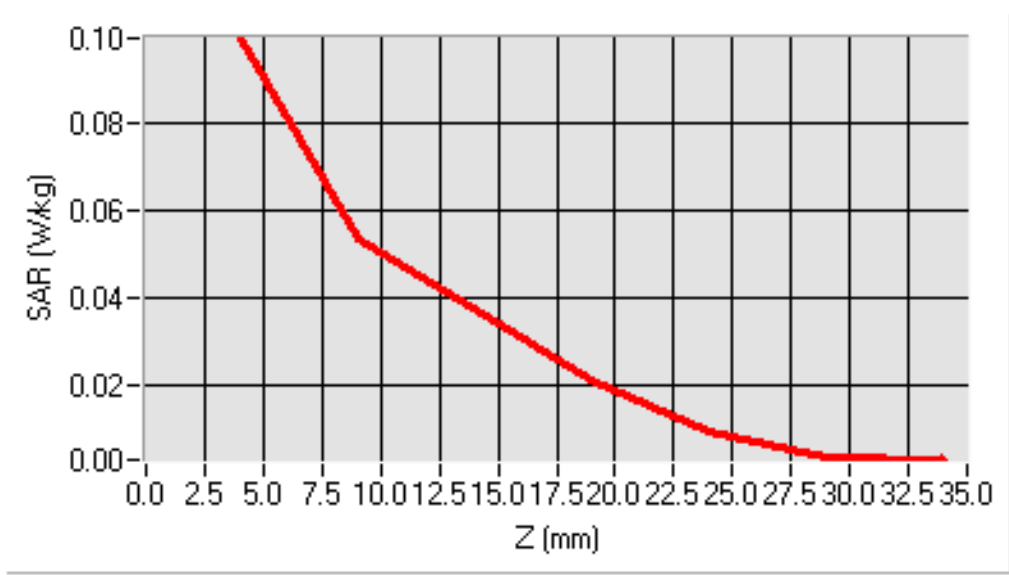

WLAN 802.11n Mode

Position- LCD Up (Push to talk)

Product Description : Handheld Computer

Model : 1007CP01

Test Date : Jun 21st, 2012

Frequency (MHz)	2462.00 (Flat, Phone measurement, head liquid)
Relative permittivity (real part)	40.63
Relative permittivity (imaginary part)	12.82
Conductivity (S/m)	1.78
Variation (%)	-1.77
SAR 10g (W/Kg)	0.112
SAR 1g (W/Kg)	0.191
SURFACE SAR	VOLUME SAR

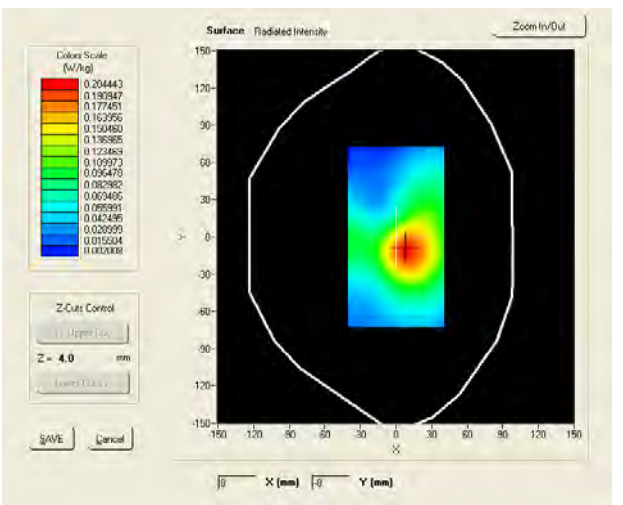
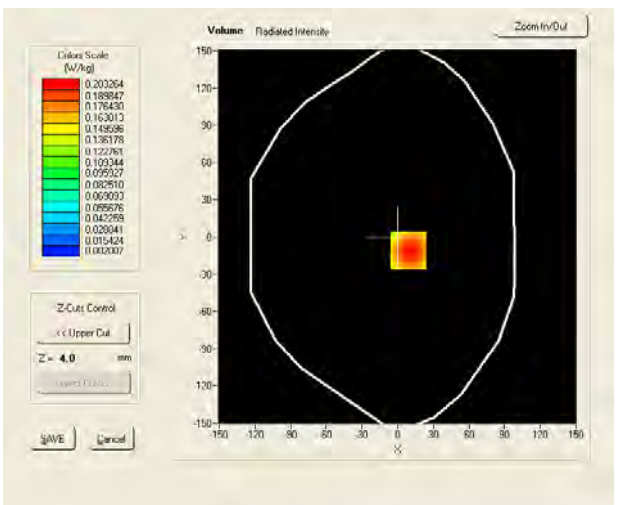

SAR, Z Axis Scan (X = 9, Y = -11)

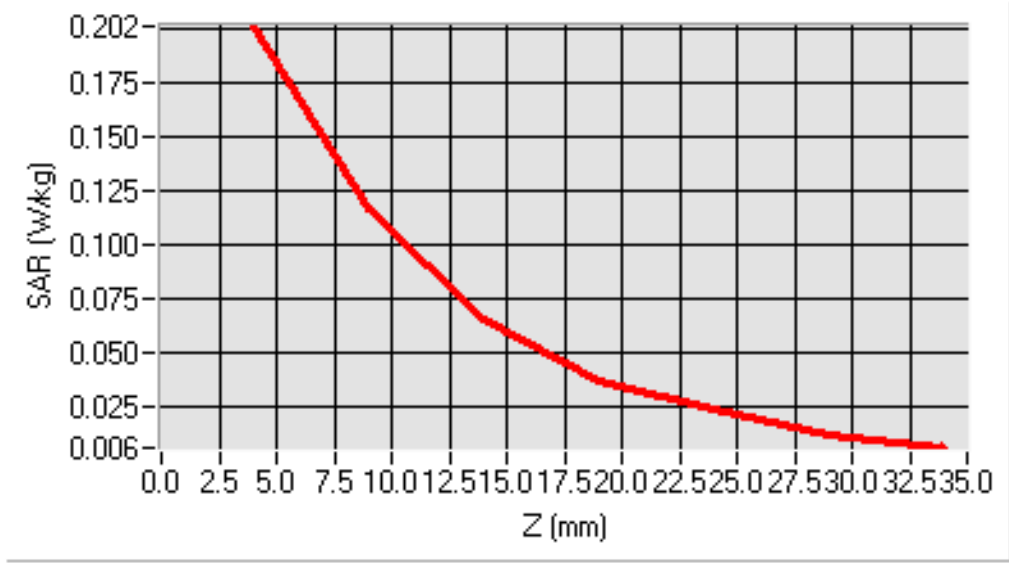

WLAN 802.11b Mode

Position- Belt clip type 1/ LCD Up
Product Description : Handheld Computer
Model : 1007CP01
Test Date : Jun 21st, 2012

Frequency (MHz)	2462.00 (Flat, Phone measurement, body liquid)
Relative permittivity (real part)	52.91
Relative permittivity (imaginary part)	14.31
Conductivity (S/m)	1.94
Variation (%)	-1.97
SAR 10g (W/Kg)	0.102
SAR 1g (W/Kg)	0.207
SURFACE SAR	VOLUME SAR

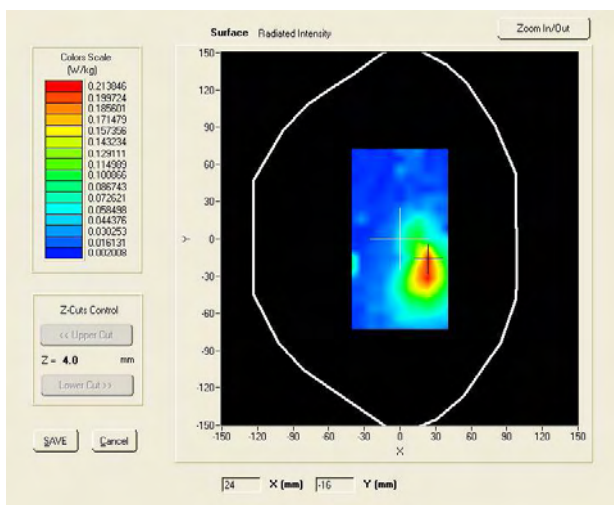
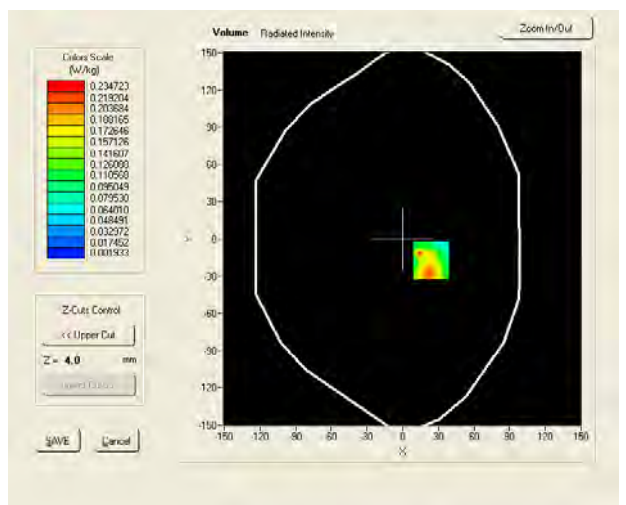

SAR, Z Axis Scan (X = 24, Y = -17)

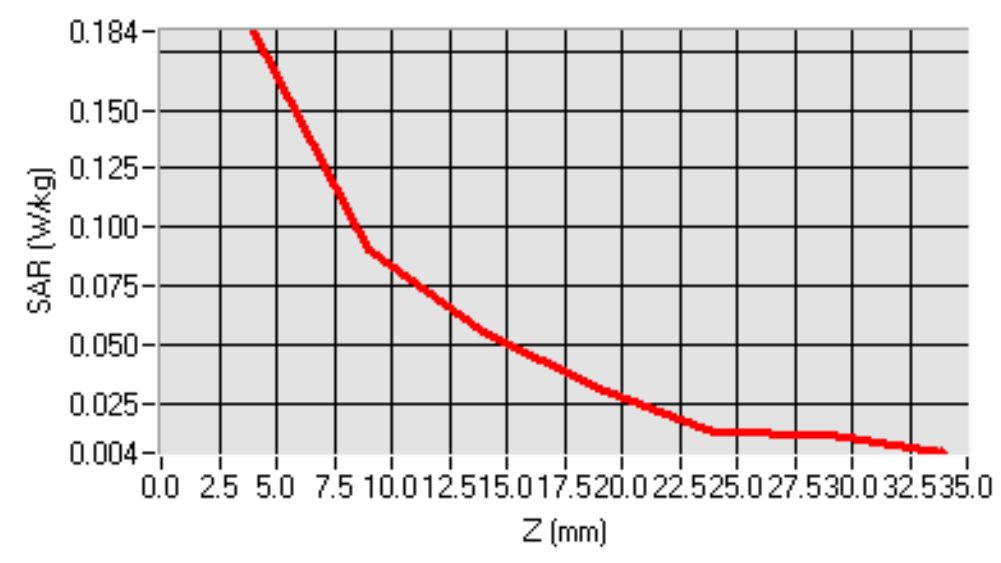

WLAN 802.11b Mode

Position- Belt clip type 2/ Right Side
 Product Description : Handheld Computer
 Model : 1007CP01
 Test Date : Jun 21st, 2012

Frequency (MHz)	2462.00 (Flat, Phone measurement, body liquid)
Relative permittivity (real part)	52.91
Relative permittivity (imaginary part)	14.31
Conductivity (S/m)	1.94
Variation (%)	0.02
SAR 10g (W/Kg)	0.174
SAR 1g (W/Kg)	0.341
SURFACE SAR	VOLUME SAR

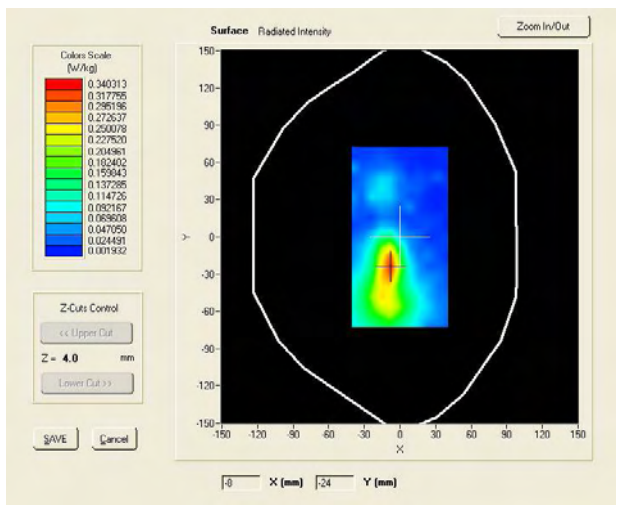
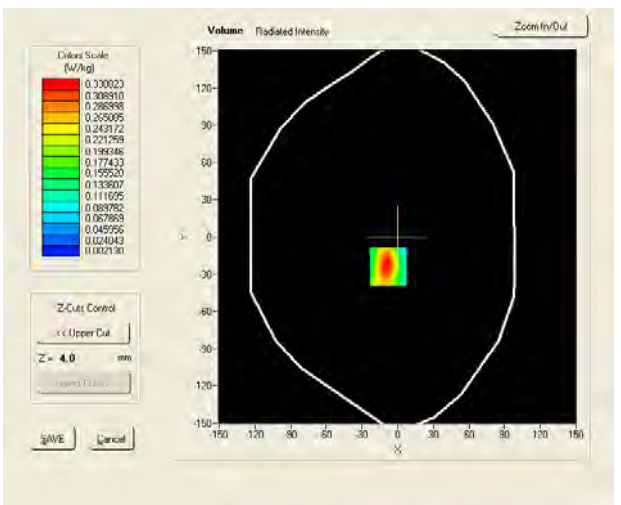

SAR, Z Axis Scan (X = -8, Y = -24)

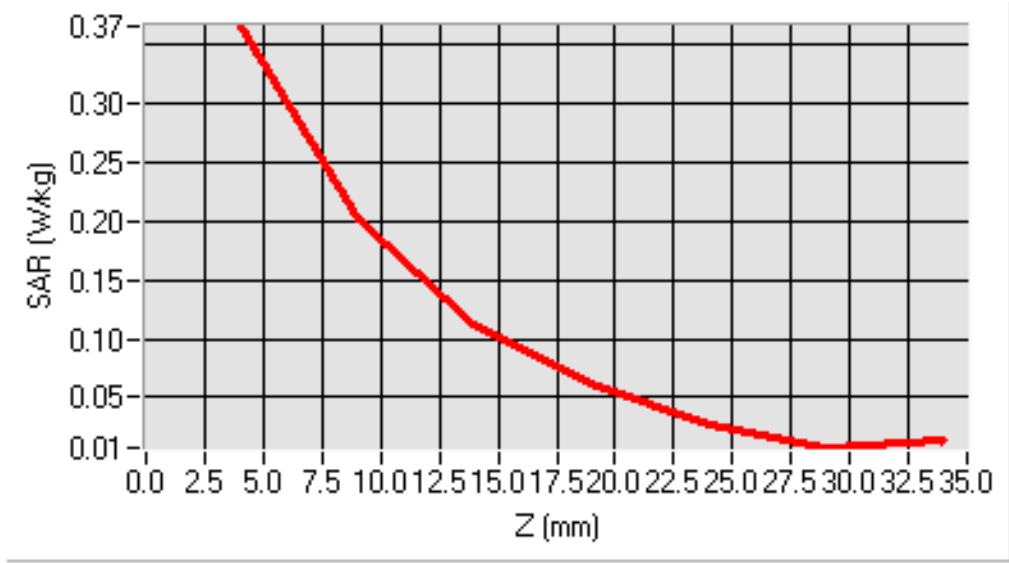

WLAN 802.11b Mode

Position- Bar code Scanner / Left Side
Product Description : Handheld Computer
Model : 1007CP01
Test Date : Jun 21st, 2012

Frequency (MHz)	2462.00 (Flat, Phone measurement, body liquid)
Relative permittivity (real part)	52.91
Relative permittivity (imaginary part)	14.31
Conductivity (S/m)	1.94
Variation (%)	2.05
SAR 10g (W/Kg)	0.096
SAR 1g (W/Kg)	0.179
SURFACE SAR	VOLUME SAR

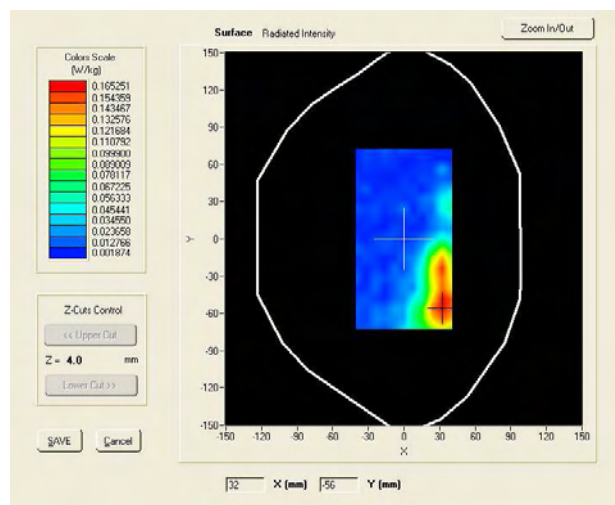
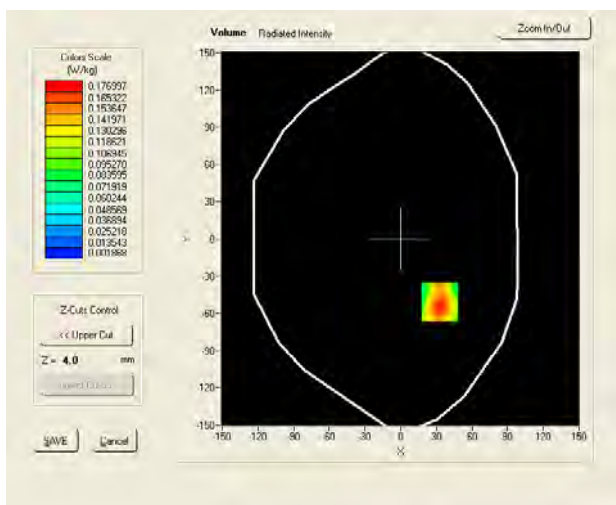

SAR, Z Axis Scan (X = 33, Y = -51)

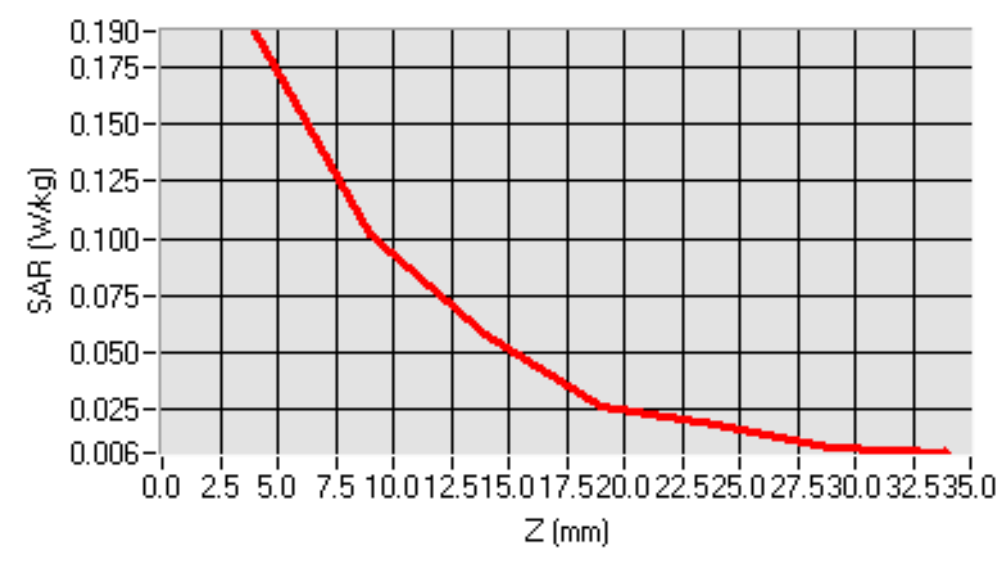

WLAN 802.11b Mode

Position- Bar code Scanner / Right Side
 Product Description : Handheld Computer
 Model : 1007CP01
 Test Date : Jun 21st, 2012

Frequency (MHz)	2462.00 (Flat, Phone measurement, body liquid)
Relative permittivity (real part)	52.91
Relative permittivity (imaginary part)	14.31
Conductivity (S/m)	1.94
Variation (%)	-2.71
SAR 10g (W/Kg)	0.030
SAR 1g (W/Kg)	0.053
SURFACE SAR	VOLUME SAR

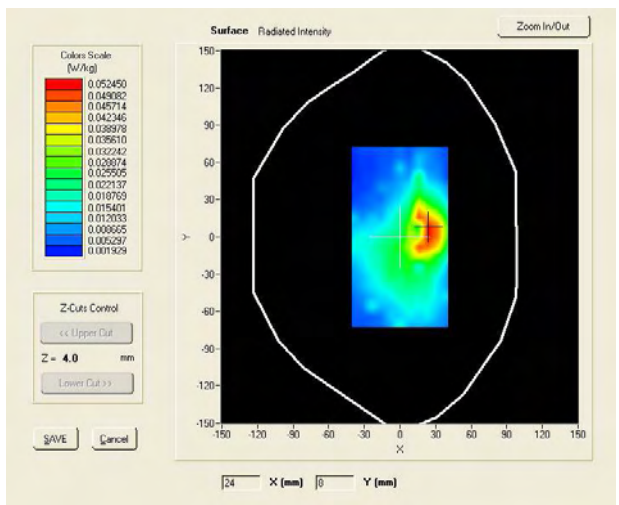
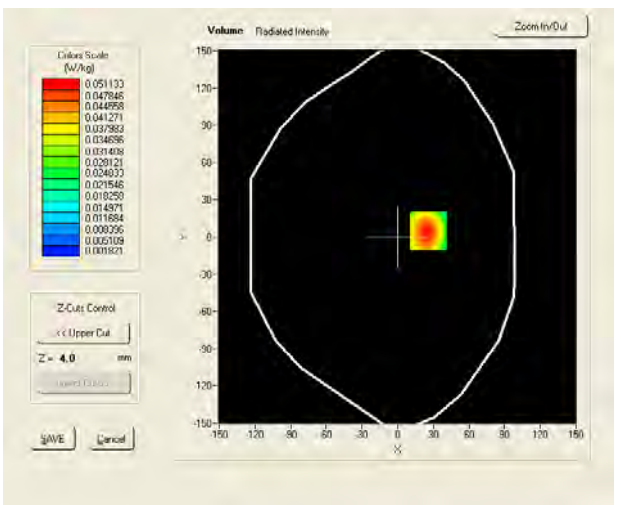

SAR, Z Axis Scan (X = 26, Y = 5)

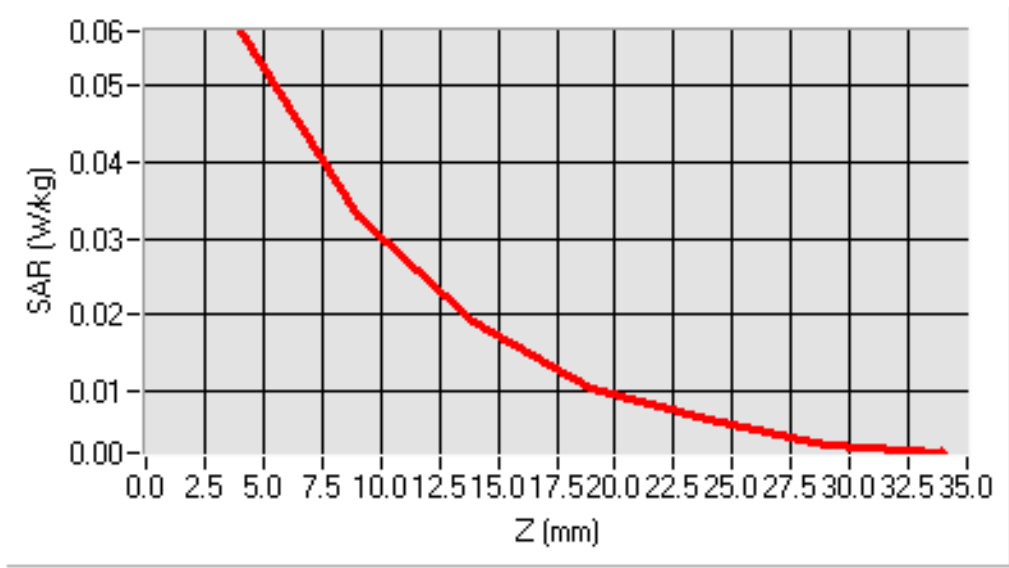

Annex A. TEST INSTRUMENT & METHOD

Annex A.i. TEST INSTRUMENTATION & GENERAL PROCEDURES

Name of Equipment	Manufacturer	Type/Model	Serial Number	Calibration Date	Cal Cycle Time	Calibration Due Date
P C	Compaq	PV 3.06GHz	375052-AA1	N/A	N/A	N/A
Signal Generator	Agilent	8665B-008	3744A01304	5/17/2012	1 Year	5/17/2013
MultiMeter	Keithley	MiltiMeter 2000	1259033	08/13/2011	1 Year	08/13/2012
S-Parameter Network Analyzer	Agilent	8753ES	US38161019	05/11/2012	1 Year	05/11/2013
Wireless Communication Test Set	R & S	CMU200	111078	2/22/2012	1 Year	2/22/2013
Power Meter	HP	437B	3038A03648	04/25/2012	1 Year	04/25/2013
E-field PROBE	SATIMO	EPG111	SN31-10 EPG111	06/13/2012	1 Year	06/13/2013
DIPOLE 2450	SATIMO	DIPOLE 2450MHz	SN 31/10 DIPJ138	06/13/2012	1 Year	06/13/2013
WaveGuide 5/6 GHz	SATIMO	Wave Guide 5/6GHz	SN 31/10 DIPWGA13	06/13/2012	1 Year	06/13/2013
COMOSAR Open Coaxial Probe	SATIMO	OCP36	SN 31/10 OCP36	06/13/2012	1 Year	06/13/2013
Communication Antenna	SATIMO	ANTA30	SN 31/10 ANTA30	N/A	N/A	N/A
Laptop POSITIONING DEVICE	SATIMO	LSH63	SN 31/10 LSH13	N/A	N/A	N/A
Mobile Phone POSITIONING DEVICE	SATIMO	MSH63	SN 31/10 MSH63	N/A	N/A	N/A
DUMMY PROBE	ANTENNESS A	None	SN 31/10	N/A	N/A	N/A
SAM PHANTOM	SATIMO	SAM77	SN 31/10 SAM77	N/A	N/A	N/A
Elliptic Phantom	SATIMO	ELLI17	SN 31-10 ELLI17	N/A	N/A	N/A
PHANTOM TABLE	SATIMO	N/A	N/A	N/A	N/A	N/A
6 AXIS ROBOT	KUKA	KR5	949319	N/A	N/A	N/A
High Power Solid State Amplifier (80MHz~1000MHz)	Instruments for Industry	CMC150	M631-0408	N/A	N/A	N/A
Medium Power Solid State Amplifier (0.8~4.2GHz)	Instruments for Industry	S41-25	M629-0408	N/A	N/A	N/A
Wave Tube Amplifier 4-8 GHz at 20Watt	Hughes Aircraft Company	1277H02F000	81	N/A	N/A	N/A

Annex B EUT AND TEST SETUP PHOTOGRAPHS

See Attachment

Annex C CALIBRATION REPORTS



COMOSAR E-Field Probe Calibration Report

Ref : ACR.170.1.12.SATU.A

SIEMIC TESTING AND CERTIFICATION SERVICES
2206 RINGWOOD AVE.
SAN JOSE, CA 95131, USA
SATIMO COMOSAR DOSIMETRIC E-FIELD PROBE
SERIAL NO.: SN 18/11 EPG123

Calibrated at SATIMO US
2105 Barrett Park Dr. - Kennesaw, GA 30144



13/06/2012

Summary:
This document presents the method and results from an accredited COMOSAR Dosimetric E-Field Probe calibration performed in SATIMO USA using the CALISAR / CALIBAIR test bench, for use with a SATIMO COMOSAR system only. All calibration results are traceable to national metrology institutions.



COMOSAR E-FIELD PROBE CALIBRATION REPORT

Ref: ACR.170.1.12.SATU.A

	<i>Name</i>	<i>Function</i>	<i>Date</i>	<i>Signature</i>
<i>Prepared by :</i>	Jérôme LUC	Product Manager	6/18/2012	<i>[Signature]</i>
<i>Checked by :</i>	Jérôme LUC	Product Manager	6/18/2012	<i>[Signature]</i>
<i>Approved by :</i>	Kim RUTKOWSKI	Quality Manager	6/18/2012	<i>[Signature]</i>

	<i>Customer Name</i>
<i>Distribution :</i>	SIEMIC Testing and Certification Services

<i>Issue</i>	<i>Date</i>	<i>Modifications</i>
A	6/18/2012	Initial release



COMOSAR E-FIELD PROBE CALIBRATION REPORT

Ref: ACR.170.1.12.SATU.A

TABLE OF CONTENTS

1	Device Under Test	4
2	Product Description	4
2.1	General Information	4
3	Measurement Method	4
3.1	Linearity	4
3.2	Sensitivity	5
3.3	Lower Detection Limit	5
3.4	Isotropy	5
3.5	Boundary Effect	5
4	Measurement Uncertainty	5
5	Calibration Measurement Results	6
5.1	Sensitivity in air	6
5.2	Linearity	7
5.3	Sensitivity in liquid	7
5.4	Isotropy	8
6	List of Equipment	10



1 DEVICE UNDER TEST

Device Under Test	
Device Type	COMOSAR DOSIMETRIC E FIELD PROBE
Manufacturer	Satimo
Model	SSE2
Serial Number	SN 18/11 EPG123
Product Condition (new / used)	used
Frequency Range of Probe	0.7 GHz-6GHz
Resistance of Three Dipoles at Connector	Dipole 1: R1=0.179 MΩ Dipole 2: R2=0.191 MΩ Dipole 3: R3=0.189 MΩ

A yearly calibration interval is recommended.

2 PRODUCT DESCRIPTION

2.1 GENERAL INFORMATION

Satimo's COMOSAR E field Probes are built in accordance to the IEEE 1528, OET 65 Bulletin C and CEI/IEC 62209 standards.



Figure 1 – Satimo COMOSAR Dosimetric E field Dipole

Probe Length	330 mm
Length of Individual Dipoles	2 mm
Maximum external diameter	8 mm
Probe Tip External Diameter	2.5 mm
Distance between dipoles / probe extremity	1 mm

3 MEASUREMENT METHOD

The IEEE 1528, OET 65 Bulletin C, CENELEC EN50361 and CEI/IEC 62209 standards provide recommended practices for the probe calibrations, including the performance characteristics of interest and methods by which to assess their affect. All calibrations / measurements performed meet the fore mentioned standards.

3.1 LINEARITY

The evaluation of the linearity was done in free space using the waveguide, performing a power sweep to cover the SAR range 0.01W/kg to 100W/kg.



3.2 SENSITIVITY

The sensitivity factors of the three dipoles were determined using a two step calibration method (air and tissue simulating liquid) using waveguides as outlined in the standards.

3.3 LOWER DETECTION LIMIT

The lower detection limit was assessed using the same measurement set up as used for the linearity measurement. The required lower detection limit is 10 mW/kg.

3.4 ISOTROPY

The axial isotropy was evaluated by exposing the probe to a reference wave from a standard dipole with the dipole mounted under the flat phantom in the test configuration suggested for system validations and checks. The probe was rotated along its main axis from 0 - 360 degrees in 15 degree steps. The hemispherical isotropy is determined by inserting the probe in a thin plastic box filled with tissue-equivalent liquid, with the plastic box illuminated with the fields from a half wave dipole. The dipole is rotated about its axis (0°-180°) in 15° increments. At each step the probe is rotated about its axis (0°-360°).

3.5 BOUNDARY EFFECT

The boundary effect is defined as the deviation between the SAR measured data and the expected exponential decay in the liquid when the probe is oriented normal to the interface. To evaluate this effect, the liquid filled flat phantom is exposed to fields from either a reference dipole or waveguide. With the probe normal to the phantom surface, the peak spatial average SAR is measured and compared to the analytical value at the surface.

4 MEASUREMENT UNCERTAINTY

The guidelines outlined in the IEEE 1528, OET 65 Bulletin C, CENELEC EN50361 and CEI/IEC 62209 standards were followed to generate the measurement uncertainty associated with an E-field probe calibration using the waveguide technique. All uncertainties listed below represent an expanded uncertainty expressed at approximately the 95% confidence level using a coverage factor of k=2, traceable to the Internationally Accepted Guides to Measurement Uncertainty.

Uncertainty analysis of the probe calibration in waveguide					
ERROR SOURCES	Uncertainty value (%)	Probability Distribution	Divisor	ci	Standard Uncertainty (%)
Incident or forward power	3.00%	Rectangular	$\sqrt{3}$	1	1.732%
Reflected power	3.00%	Rectangular	$\sqrt{3}$	1	1.732%
Liquid conductivity	5.00%	Rectangular	$\sqrt{3}$	1	2.887%
Liquid permittivity	4.00%	Rectangular	$\sqrt{3}$	1	2.309%
Field homogeneity	3.00%	Rectangular	$\sqrt{3}$	1	1.732%
Field probe positioning	5.00%	Rectangular	$\sqrt{3}$	1	2.887%
Field probe linearity	3.00%	Rectangular	$\sqrt{3}$	1	1.732%



COMOSAR E-FIELD PROBE CALIBRATION REPORT

Ref: ACR.170.1.12.SATU.A

Combined standard uncertainty					5.831%
Expanded uncertainty 95 % confidence level k = 2					11.662%

5 CALIBRATION MEASUREMENT RESULTS

Calibration Parameters	
Liquid Temperature	21 °C
Lab Temperature	21 °C
Lab Humidity	45 %

5.1 SENSITIVITY IN AIR

Normx dipole 1 (µV/(V/m) ²)	Normy dipole 2 (µV/(V/m) ²)	Normz dipole 3 (µV/(V/m) ²)
0.77	0.86	0.55

DCP dipole 1 (mV)	DCP dipole 2 (mV)	DCP dipole 3 (mV)
111	110	101

Calibration curves $e_i=f(V)$ (i=1,2,3) allow to obtain H-field value using the formula:

$$E = \sqrt{E_1^2 + E_2^2 + E_3^2}$$

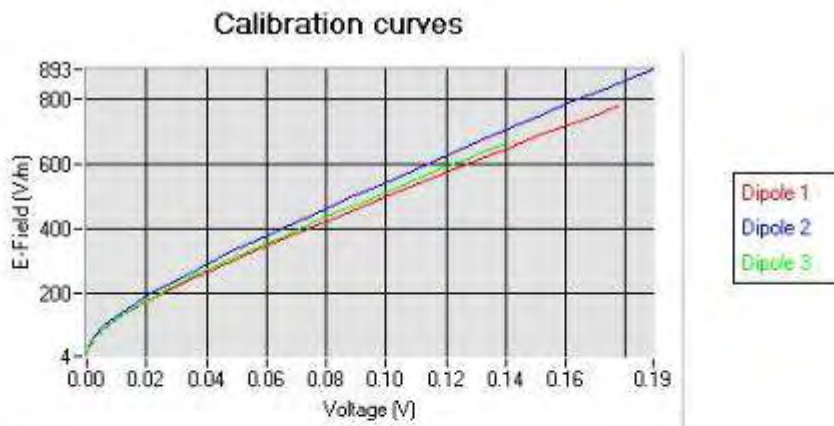



COMOSAR E-FIELD PROBE CALIBRATION REPORT

Ref: ACR.170.1.12.SATU.A

5.2 LINEARITY

Linearity

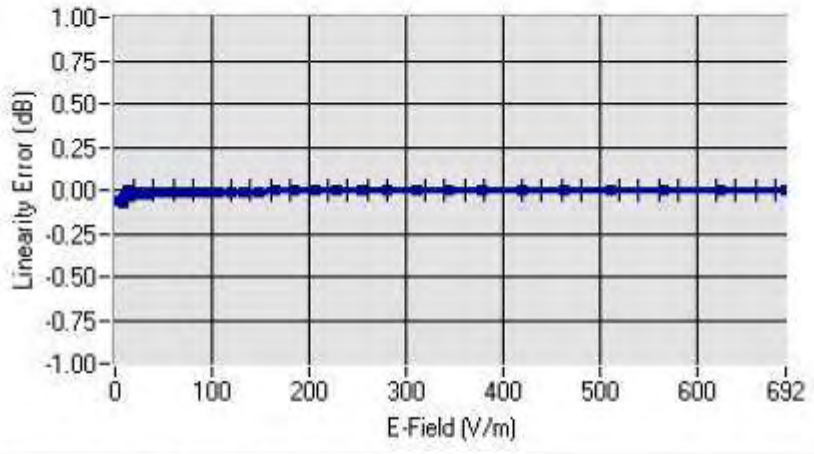

Linearity: $\pm 1.59\%$ ($\pm 0.07\text{dB}$)

5.3 SENSITIVITY IN LIQUID

Liquid	Frequency (MHz +/- 100MHz)	Permittivity	Epsilon (S/m)	ConvF
HL850	835	40.96	0.90	7.53
BL850	835	54.10	0.99	7.75
HL900	900	40.60	0.97	7.08
BL900	900	53.00	1.04	7.35
HL1800	1750	40.45	1.38	7.26
BL1800	1750	54.23	1.50	7.54
HL1900	1880	38.89	1.38	7.92
BL1900	1880	53.89	1.52	8.18
HL2000	1950	39.47	1.43	7.76
BL2000	1950	52.75	1.47	7.92
HL2450	2450	38.97	1.88	7.93
BL2450	2450	51.87	1.95	8.16
HL3500	3500	39.83	2.85	5.45
BL3500	3500	51.00	3.16	5.67
HL5200	5200	36.95	4.61	5.29
BL5200	5200	48.99	5.00	5.47
HL5500	5500	34.70	4.96	5.91
BL5500	5500	49.28	5.76	6.07
HL5800	5800	33.69	5.62	6.13
BL5800	5800	48.13	6.14	6.27

LOWER DETECTION LIMIT: 7mW/kg



COMOSAR E-FIELD PROBE CALIBRATION REPORT

Ref: ACR.170.1.12.SATU.A

5.4 ISOTROPY

HL900 MHz

- Axial isotropy: 0.04 dB
- Hemispherical isotropy: 0.08 dB

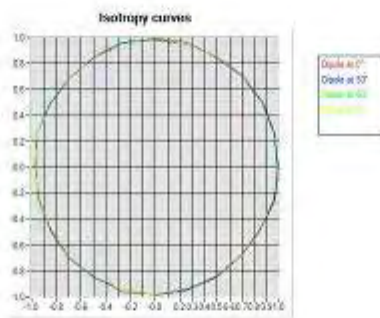

HL1800 MHz

- Axial isotropy: 0.06 dB
- Hemispherical isotropy: 0.10 dB

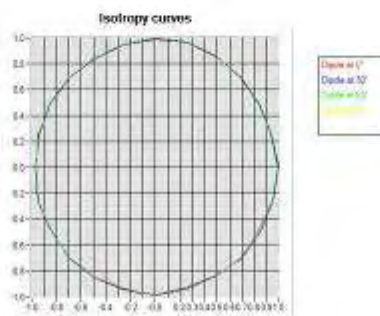

HL5500 MHz

- Axial isotropy: 0.08 dB
- Hemispherical isotropy: 0.15 dB



COMOSAR E-FIELD PROBE CALIBRATION REPORT

Ref: ACR.170.1.12.SATU.A

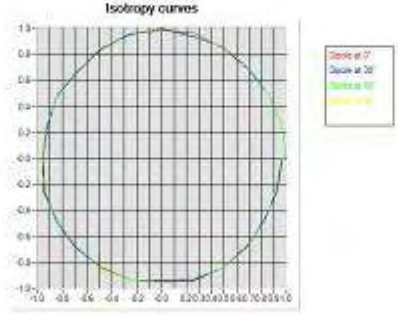



6 LIST OF EQUIPMENT

Equipment Summary Sheet				
Equipment Description	Manufacturer / Model	Identification No.	Current Calibration Date	Next Calibration Date
Flat Phantom	Satimo	SN-20/09-SAM71	Validated. No cal required.	Validated. No cal required.
COMOSAR Test Bench	Version 3	NA	Validated. No cal required.	Validated. No cal required.
Network Analyzer	Rhode & Schwarz ZVA	SN100132	02/2010	02/2013
Reference Probe	Satimo	EP 94 SN 37/08	Characterized prior to test. No cal required.	Characterized prior to test. No cal required.
Multimeter	Keithley 2000	1188656	11/2010	11/2013
Signal Generator	Agilent E4438C	MY49070581	12/2010	12/2013
Amplifier	Aethercomm	SN 046	Characterized prior to test. No cal required.	Characterized prior to test. No cal required.
Power Meter	HP E4418A	US38261498	11/2010	11/2013
Power Sensor	HP ECP-E26A	US37181460	11/2010	11/2013
Directional Coupler	Narda 4216-20	01386	Characterized prior to test. No cal required.	Characterized prior to test. No cal required.
Waveguide	Mega Industries	069Y7-158-13-712	Validated. No cal required.	Validated. No cal required.
Waveguide Transition	Mega Industries	069Y7-158-13-701	Validated. No cal required.	Validated. No cal required.
Waveguide Termination	Mega Industries	069Y7-158-13-701	Validated. No cal required.	Validated. No cal required.
Temperature / Humidity Sensor	Control Company	11-661-9	3/2012	3/2014



SAR Reference Dipole Calibration Report

Ref : ACR.170.7.12.SATU.A

SIEMIC TESTING AND CERTIFICATION SERVICES

2206 RINGWOOD AVE.

SAN JOSE, CA 95131, USA

SATIMO COMOSAR REFERENCE DIPOLE

FREQUENCY: 2450 MHZ

SERIAL NO.: SN 31/10 DIPJ138

Calibrated at SATIMO US

2105 Barrett Park Dr. - Kennesaw, GA 30144



06/13/2012

Summary:

This document presents the method and results from an accredited SAR reference dipole calibration performed in SATIMO USA using the COMOSAR test bench. All calibration results are traceable to national metrology institutions.



SAR REFERENCE DIPOLE CALIBRATION REPORT

Ref: ACR.170.7.12.SATU.A

	<i>Name</i>	<i>Function</i>	<i>Date</i>	<i>Signature</i>
<i>Prepared by :</i>	Jérôme LUC	Product Manager	6/18/2012	<i>JS</i>
<i>Checked by :</i>	Jérôme LUC	Product Manager	6/18/2012	<i>JS</i>
<i>Approved by :</i>	Kim RUTKOWSKI	Quality Manager	6/18/2012	<i>Kim Rutkowski</i>

	<i>Customer Name</i>
<i>Distribution :</i>	SIEMIC Testing and Certification Services

<i>Issue</i>	<i>Date</i>	<i>Modifications</i>
A	6/18/2012	Initial release



SAR REFERENCE DIPOLE CALIBRATION REPORT

Ref: ACR.170.7.12.SATU.A

TABLE OF CONTENTS

1	Introduction.....	4
2	Device Under Test	4
3	Product Description	4
3.1	General Information	4
4	Measurement Method	5
4.1	Return Loss Requirements	5
4.2	Mechanical Requirements	5
5	Measurement Uncertainty	5
5.1	Return Loss	5
5.2	Dimension Measurement	5
5.3	Validation Measurement	5
6	Calibration Measurement Results	6
6.1	Return Loss	6
6.2	Mechanical Dimensions	6
7	Validation measurement	7
7.1	Measurement Condition	7
7.2	Head Liquid Measurement	7
7.3	Measurement Result	8
8	List of Equipment	8



1 INTRODUCTION

This document contains a summary of the requirements set forth by the IEEE 1528, OET 65 Bulletin C and CEI/IEC 62209 standards for reference dipoles used for SAR measurement system validations and the measurements that were performed to verify that the product complies with the fore mentioned standards.

2 DEVICE UNDER TEST

Device Under Test	
Device Type	COMOSAR 2450 MHz REFERENCE DIPOLE
Manufacturer	Satimo
Model	SID2450
Serial Number	SN 31/10 DIPJ138
Product Condition (new / used)	used

A yearly calibration interval is recommended.

3 PRODUCT DESCRIPTION

3.1 GENERAL INFORMATION

Satimo's COMOSAR Validation Dipoles are built in accordance to the IEEE 1528, OET 65 Bulletin C and CEI/IEC 62209 standards. The product is designed for use with the COMOSAR test bench only.



Figure 1 – Satimo COMOSAR Validation Dipole



4 MEASUREMENT METHOD

The IEEE 1528, OET 65 Bulletin C and CEI/IEC 62209 standards provide requirements for reference dipoles used for system validation measurements. The following measurements were performed to verify that the product complies with the fore mentioned standards.

4.1 RETURN LOSS REQUIREMENTS

The dipole used for SAR system validation measurements and checks must have a return loss of -20 dB or better. The return loss measurement shall be performed against a liquid filled flat phantom, with the phantom constructed as outlined in the fore mentioned standards.

4.2 MECHANICAL REQUIREMENTS

The IEEE Std. 1528 and CEI/IEC 62209 standards specify the mechanical components and dimensions of the validation dipoles, with the dimensions frequency and phantom shell thickness dependent. The COMOSAR test bench employs a 2 mm phantom shell thickness therefore the dipoles sold for use with the COMOSAR test bench comply with the requirements set forth for a 2 mm phantom shell thickness.

5 MEASUREMENT UNCERTAINTY

All uncertainties listed below represent an expanded uncertainty expressed at approximately the 95% confidence level using a coverage factor of k=2, traceable to the Internationally Accepted Guides to Measurement Uncertainty.

5.1 RETURN LOSS

The following uncertainties apply to the return loss measurement:

Frequency band	Expanded Uncertainty on Return Loss
400-6000MHz	0.1 dB

5.2 DIMENSION MEASUREMENT

The following uncertainties apply to the dimension measurements:

Length (mm)	Expanded Uncertainty on Length
3 - 300	0.05 mm

5.3 VALIDATION MEASUREMENT

The guidelines outlined in the IEEE 1528, OET 65 Bulletin C, CENELEC EN50361 and CEI/IEC 62209 standards were followed to generate the measurement uncertainty for validation measurements.

Scan Volume	Expanded Uncertainty
1 g	16.19 %
10 g	15.86 %



SAR REFERENCE DIPOLE CALIBRATION REPORT

Ref: ACR.170.7.12.SATU.A

6 CALIBRATION MEASUREMENT RESULTS

6.1 RETURN LOSS

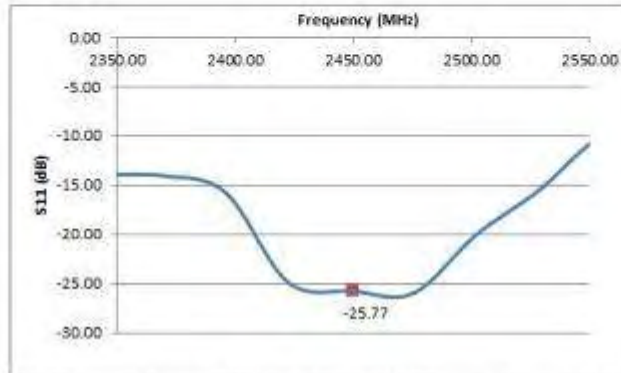

Frequency (MHz)	Return Loss (dB)	Requirement (dB)
2450	-25.77	-20

6.2 MECHANICAL DIMENSIONS

Frequency MHz	L mm		h mm		d mm	
	required	measured	required	measured	required	measured
300	420.0 ±1 %		250.0 ±1 %		6.35 ±1 %	
450	290.0 ±1 %		166.7 ±1 %		6.35 ±1 %	
750	176.0 ±1 %		100.0 ±1 %		6.35 ±1 %	
835	161.0 ±1 %		89.8 ±1 %		3.6 ±1 %	
900	149.0 ±1 %		83.3 ±1 %		3.6 ±1 %	
1450	89.1 ±1 %		51.7 ±1 %		3.6 ±1 %	
1500	80.5 ±1 %		50.0 ±1 %		3.6 ±1 %	
1640	79.0 ±1 %		45.7 ±1 %		3.6 ±1 %	
1750	75.2 ±1 %		42.9 ±1 %		3.6 ±1 %	
1800	72.0 ±1 %		41.7 ±1 %		3.6 ±1 %	
1900	68.0 ±1 %		39.5 ±1 %		3.6 ±1 %	
1950	66.3 ±1 %		38.5 ±1 %		3.6 ±1 %	
2000	64.5 ±1 %		37.5 ±1 %		3.6 ±1 %	
2100	61.0 ±1 %		35.7 ±1 %		3.6 ±1 %	
2300	55.5 ±1 %		32.6 ±1 %		3.6 ±1 %	
2450	51.5 ±1 %	PASS	30.4 ±1 %	PASS	3.6 ±1 %	PASS
2600	48.5 ±1 %		28.8 ±1 %		3.6 ±1 %	
3000	41.5 ±1 %		25.0 ±1 %		3.6 ±1 %	
3500	37.0 ±1 %		26.4 ±1 %		3.6 ±1 %	
3700	34.7 ±1 %		26.4 ±1 %		3.6 ±1 %	



SAR REFERENCE DIPOLE CALIBRATION REPORT

Ref: ACR.170.7.12.SATU.A

7 VALIDATION MEASUREMENT

The IEEE Std. 1528, OET 65 Bulletin C and CEI/IEC 62209 standards state that the system validation measurements must be performed using a reference dipole meeting the fore mentioned return loss and mechanical dimension requirements. The validation measurement must be performed against a liquid filled flat phantom, with the phantom constructed as outlined in the fore mentioned standards. Per the standards, the dipole shall be positioned below the bottom of the phantom, with the dipole length centered and parallel to the longest dimension of the flat phantom, with the top surface of the dipole at the described distance from the bottom surface of the phantom.

7.1 MEASUREMENT CONDITION

Software	OPENSAR V4
Phantom	SN 20/09 SAM71
Probe	SN 18/11 EPG122
Liquid	Head Liquid Values: eps' : 39.0 sigma : 1.88
Distance between dipole center and liquid	10.0 mm
Area scan resolution	dx=8mm/dy=8mm
Zoon Scan Resolution	dx=8mm/dy=8m/dz=5mm
Frequency	2450 MHz
Input power	20 dBm
Liquid Temperature	21 °C
Lab Temperature	21 °C
Lab Humidity	45 %

7.2 HEAD LIQUID MEASUREMENT

Frequency MHz	Relative permittivity (ε _r)		Conductivity (σ) S/m	
	required	measured	required	measured
300	45.3 ±5 %		0.87 ±5 %	
450	43.5 ±5 %		0.87 ±5 %	
750	41.9 ±5 %		0.89 ±5 %	
835	41.5 ±5 %		0.90 ±5 %	
900	41.5 ±5 %		0.97 ±5 %	
1450	40.5 ±5 %		1.20 ±5 %	
1500	40.4 ±5 %		1.23 ±5 %	
1640	40.2 ±5 %		1.31 ±5 %	
1750	40.1 ±5 %		1.37 ±5 %	
1800	40.0 ±5 %		1.40 ±5 %	
1900	40.0 ±5 %		1.40 ±5 %	
1950	40.0 ±5 %		1.40 ±5 %	
2000	40.0 ±5 %		1.40 ±5 %	
2100	39.8 ±5 %		1.49 ±5 %	
2300	39.5 ±5 %		1.67 ±5 %	
2450	39.2 ±5 %	PASS	1.80 ±5 %	PASS
2600	39.0 ±5 %		1.96 ±5 %	
3000	38.5 ±5 %		2.40 ±5 %	
3500	37.9 ±5 %		2.91 ±5 %	



SAR REFERENCE DIPOLE CALIBRATION REPORT

Ref: ACR.170.7.12.SATU.A

7.3 MEASUREMENT RESULT

The IEEE Std. 1528 and CEI/IEC 62209 standards state that the system validation measurements should produce the SAR values shown below (for phantom thickness of 2 mm), within the uncertainty for the system validation. All SAR values are normalized to 1 W forward power. In bracket, the measured SAR is given with the used input power.

Frequency MHz	1 g SAR (W/kg/W)		10 g SAR (W/kg/W)	
	required	measured	required	measured
300	2.85		1.94	
450	4.58		3.06	
750	8.49		5.55	
835	9.56		6.22	
900	10.9		6.99	
1450	29		16	
1500	30.5		16.8	
1640	34.2		18.4	
1750	36.4		19.3	
1800	38.4		20.1	
1900	39.7		20.5	
1950	40.5		20.9	
2000	41.1		21.1	
2100	43.6		21.9	
2300	48.7		23.3	
2450	52.4	54.82 (5.48)	24	24.50 (2.45)
2600	55.3		24.6	
3000	63.8		25.7	
3500	67.1		25	

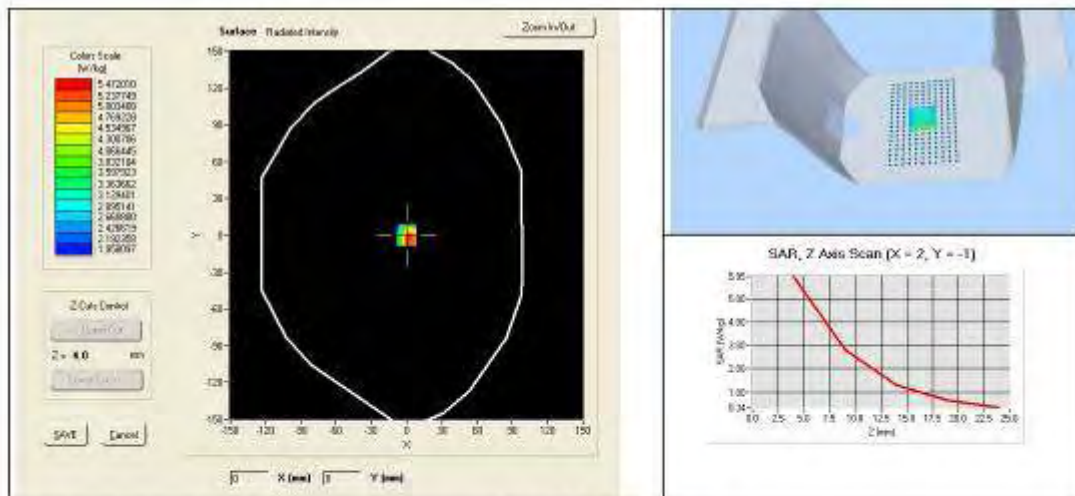



SAR REFERENCE DIPOLE CALIBRATION REPORT

Ref: ACR.170.7.12.SATU.A

8 LIST OF EQUIPMENT

Equipment Summary Sheet				
Equipment Description	Manufacturer / Model	Identification No.	Current Calibration Date	Next Calibration Date
Flat Phantom	Satimo	SN-20/09-SAM71	Validated. No cal required.	Validated. No cal required.
COMOSAR Test Bench	Version 3	NA	Validated. No cal required.	Validated. No cal required.
Network Analyzer	Rhode & Schwarz ZVA	SN100132	02/2010	02/2013
Calipers	Carrera	CALIPER-01	12/2010	12/2013
Reference Probe	Satimo	EPG122 SN 18/11	Characterized prior to test. No cal required.	Characterized prior to test. No cal required.
Multimeter	Keithley 2000	1188656	11/2010	11/2013
Signal Generator	Agilent E4438C	MY49070581	12/2010	12/2013
Amplifier	Aethercomm	SN 046	Characterized prior to test. No cal required.	Characterized prior to test. No cal required.
Power Meter	HP E4418A	US38261498	11/2010	11/2013
Power Sensor	HP ECP-E26A	US37181460	11/2010	11/2013
Directional Coupler	Narda 4216-20	01386	Characterized prior to test. No cal required.	Characterized prior to test. No cal required.
Temperature and Humidity Sensor	Control Company	11-661-9	3/2012	3/2014