

Supplement to Test Report I09GW6944-FCC-EMC-3

ON

Type of Equipment: PCI Express Mini Card
Type of Designation: MC8795V
Manufacturer: Flextronics

ACCORDING TO

FCC CFR Part 2, FREQUENCY ALLOCATIONS AND RADIO
TREATY MATTERS; GENERAL RULES AND REGULATIONS;
e-CFR, April 24, 2009

PART 22, PUBLIC MOBILE SERVICES e-CFR, April 24, 2009

PART 24, PERSONAL COMMUNICATIONS SERVICES e-CFR,
April 24, 2009

China Telecommunication Technology Labs.

Month date, year
Apr,13, 2010

Signature

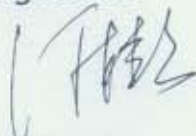

He Guili
Director

FCC ID: N7NMC8795

Report Date: 2010-4-13

Test Firm Name: China Telecommunication Technology Labs

Registration Number: 840587

Statement

The measurements shown in this report were made in accordance with the procedures described on test pages. All reported tests were carried out on a sample equipment to demonstrate limited compliance with FCC CFR 47 Parts 2, 22, and 24. The sample tested was found to comply with the requirements defined in the applied rules.

CONTENTS

1 GENERAL INFORMATION	4
1.1 NOTES	4
1.2 TESTERS	5
1.3 TESTING LABORATORY INFORMATION	6
1.4 DETAILS OF APPLICANT OR MANUFACTURER	7
2 TEST ITEM	8
2.1 GENERAL INFORMATION	8
2.2 OUTLINE OF EUT	8
2.3 MODIFICATIONS INCORPORATED IN EUT	8
2.4 EQUIPMENT CONFIGURATION	8
2.5 OTHER INFORMATION	9
3 SUMMARY OF TEST RESULTS	10
4 TEST RESULTS OF MODE	11
4.1 RADIATED SPURIOUS EMISSION	11
4.2 RADIATED RF POWER OUTPUT AND ERP	21
4.3 OCCUPIED BANDWIDTH	24
4.4 FREQUENCY STABILITY OVER TEMPERATURE VARIATION	33
4.5 FREQUENCY STABILITY OVER VOLTAGE VARIATION	36
4.6 CONDUCTED RF POWER OUTPUT	38
4.7 CONDUCTED SPURIOUS EMISSION	40
4.8 BAND EDGE	44
ANNEX A EXTERNAL PHOTOS	50
ANNEX B INTERNAL PHOTOS.....	51
ANNEX C DEVIATIONS FROM PRESCRIBED TEST METHODS.....	54

1 General Information

1.1 Notes

The current document is a supplement to test report I09GW6944-FCC-EMC-3

All reported tests were carried out on a sample equipment to demonstrate limited compliance with FCC CFR 47 Parts 2, 22 and 24.

The test results of this test report relate exclusively to the item(s) tested as specified in section 2.

The following deviation from, additions to, or exclusions from the test specifications have been made. See Annex C.

China Telecommunication Technology Labs.(CTTL) authorizes the applicant or manufacturer (see section 1.4) to reproduce this report provided, and the test report may only be reproduced or published in full. Reproduction or publication of extracts from the report requires the prior written approval of CTTL Mr. He Guili.

Any use which a third party makes of this report, or any reliance on or decisions to be made based on it, are the responsibility of such third parties. CTTL accepts no responsibility for damages, if any, suffered by any third party as a result of decisions made or actions based on this report.

1.2 Testers

Name: Li Guoqing
Position: Engineer
Department: Department of EMC test
Signature: 李国庆

Name: Pan Yang
Position: Engineer
Department: Department of EMC test
Signature: 潘阳

Editor of this test report:

Name: Li Guoqing
Position: Engineer
Department: Department of EMC test
Date: 2010-4-13
Signature: 李国庆

Technical responsibility for area of testing:

Name: Zou Dongyi
Position: Manager
Department: Department of EMC test
Date: 2010-4-13
Signature: 邹东屹

1.3 Testing Laboratory information

1.3.1 Location

Name: China Telecommunication Technology Labs.
Address: No. 11, Yue Tan Nan Jie, Xi Cheng District
BEIJING
P. R. CHINA, 100045
Tel: +86 10 68094053
Fax: +86 10 68011404
Email: emc@chinattl.com

1.3.2 Details of accreditation status

Accredited by: China National Accreditation Service for Conformity
Assessment (CNAS)
Registration number: CNAS Registration No. CNAS L0570
Standard: ISO/IEC 17025:2005

1.3.3 Test location, where different from section 1.3.1

Name: -----
Street: -----
City: -----
Country: -----
Telephone: -----
Fax: -----
Postcode: -----

1.4 Details of applicant or manufacturer

1.4.1 Applicant

Name: Sierra Wireless, Inc.
Address: 13811, Wireless Way, Richmond, British Columbia
Country: Canada
Telephone: +1 604-232-1440
Fax: +1 604-231-1109
Contact: Ying Wang
Telephone: +86 755 8611 9802
Email: ywang@sierrawireless.com

1.4.2 Manufacturer (if different from applicant in section 1.4.1)

Name: Flextronics
Address: Flextronics Zhuhai Industrial Park (B16), Xin Qing
Science & Technology Industrial Park, Jing An,
Doumen, Zhuhai, GD, China.

1.4.3 Manufactory (if different from applicant in section 1.4.1)

Name: ----
Address: ----

2 Test Item

2.1 General Information

Manufacturer: Flextronics
 Name: PCI Express Mini Card
 Model Number: MC8795V
 Serial Number: 1201477-1.0
 Production Status: Product
 Receipt date of test item: 2009-8-3

2.2 Outline of EUT

EUT is a PCI Express Mini Card supporting GPRS/EGPRS 850/1900 and WCDMA/HSDPA/HSUPA FDD II/V

2.3 Modifications Incorporated in EUT

The EUT has not been modified from what is described by the brand name and unique type identification stated above.

2.4 Equipment Configuration

Equipment configuration list:

Item	Generic Description	Manufacturer	Type	Serial No.	Remarks
A	PCI Express Mini Card	Flextronics	MC8795V	1201477-1.0	None
B	adapter	--	--	--	None
C	battery	--	--	--	None
D	Earphone	--	--	--	None
E	Antenna	--	3G101	--	None

Cables:

Item	Cable Type	Manufacturer	Length	Shield	Quantity	Remarks
1	DC cable on Adapter	--	--	--	--	None

Note: the EUT has no adaptor, battery, earphone and cable.

2.5 Other Information

Report description:

In test report I09GW6944-FCC-EMC-3, GPRS/EGPRS and WCDMA modes were recorded, and in this supplement report, HSDPA/HSUPA modes are recorded.

TTL Test Report

3 Summary of Test Results

A brief summary of the tests carried out is shown as following.

HSDPA/HSUPA mode:		
2.1051, 24.238, 2.1053,22.917	Radiated Spurious Emission	Pass
2.1046,24.232	Radiated RF Power Output	Pass
22.913(a)	Effective Radiated Power (ERP)	Pass
2.1049,22.917(b), 24.238(b)	Occupied Bandwidth	*Note 3
2.1055,22.355, 24.235	Frequency Stability over Temperature Variation	Pass
2.1055,22.355, 24.235	Frequency Stability over Voltage Variation	Pass
2.1046,22.913(a), 24.232(c)	Conducted RF Power Output	Pass
2.1051,22.917,24. 238	Conducted spurious emissions	Pass
Note 3: No applicable performance criteria.		

TTL TEST REPORT

4 Test Results of mode

4.1 Radiated Spurious Emission

Specifications:	2.1051, 24.238, 2.1053, 22.917					
Date of Tests	2010-4-7					
Test conditions:	Ambient Temperature: 15°C-35°C Relative Humidity: 30%-60% Air pressure: 86-106kPa					
Operation Mode	TX on maximum transmitting power level at channel 4175 and 9400 for HSPA FDD V and II band respectively.					
Test Results:	Pass					
Test equipment Used:						
Asset Number	Description	Manufacturer	Model Number	Serial Number	Cal Due	State
7805	EMI Test Receiver	R/S	ESI26	100211	2011-01-11	Normal
7330	Ultra Broadband Antenna	SCHWARZBECK	VULB 9160	--	2012-10-26	Normal
7330	Double-Ridged Horn Antenna	R/S	HF906	100037	2012-01-09	Normal
713	Fully-Anechoic Chamber	ETS	11.8m×6.5m×6.3 m	--	2013-11-16	Normal
023	Wireless Communications Test Set	Agilent	8960(E5515C)	GB41450323	2010-06-09	Normal
111835	Wireless Communications Test Set	R&S	CMU200	1100000802	--	Normal

Limit Level Construction:

According to Part 24.238 (a), i.e., Out of band emissions. The power of any emission outside of the authorized operating frequency ranges must be attenuated below the transmitting power (P) by a factor of at least $43 + 10 \log(P)$ dB, so the limit level is:
 $P(\text{dBm}) - (43 + 10 \log(P)) \text{ dB} = -13\text{dBm}$

Limits for Radiated spurious emissions(UE)

Frequency range	Limit Level /Resolution Bandwidth
30 MHz to 20000 MHz	-13dBm/1MHz

Test Setup:

The EUT was placed in an anechoic chamber, see figure SP. The Wireless Communications Test Set was used to set the TX channel and power level and modulate the TX signal with different bit patterns. The test was done using an automated test system, where all test equipments were controlled by a computer.



Figure SP

Test Method:

The measurement was performed accordance with section 2.2.12 of ANSI/TIA-603-B-2002: *Land Mobile FM or PM Communications Equipment Measurement and Performance Standards*.

1 The maximum spurious emissions were searched by turning the azimuth of the turntable, shifting the polarization of the measuring antenna and changing the pose of the EUT.

2 Levels of EUT's transmitter harmonics and suspicious signals were recorded.

3 The recorded levels were corrected in the automated test system with the correction factors given by a substitution calibration made before the measurement. The calibration was made separately for vertical and horizontal polarization and the system uses different correction factors depending on the measuring antenna polarization.

4 The corrected values of radiated spurious emissions indicated as EIRP are reported.

Note:

--

Test Results for HSDPA mode:

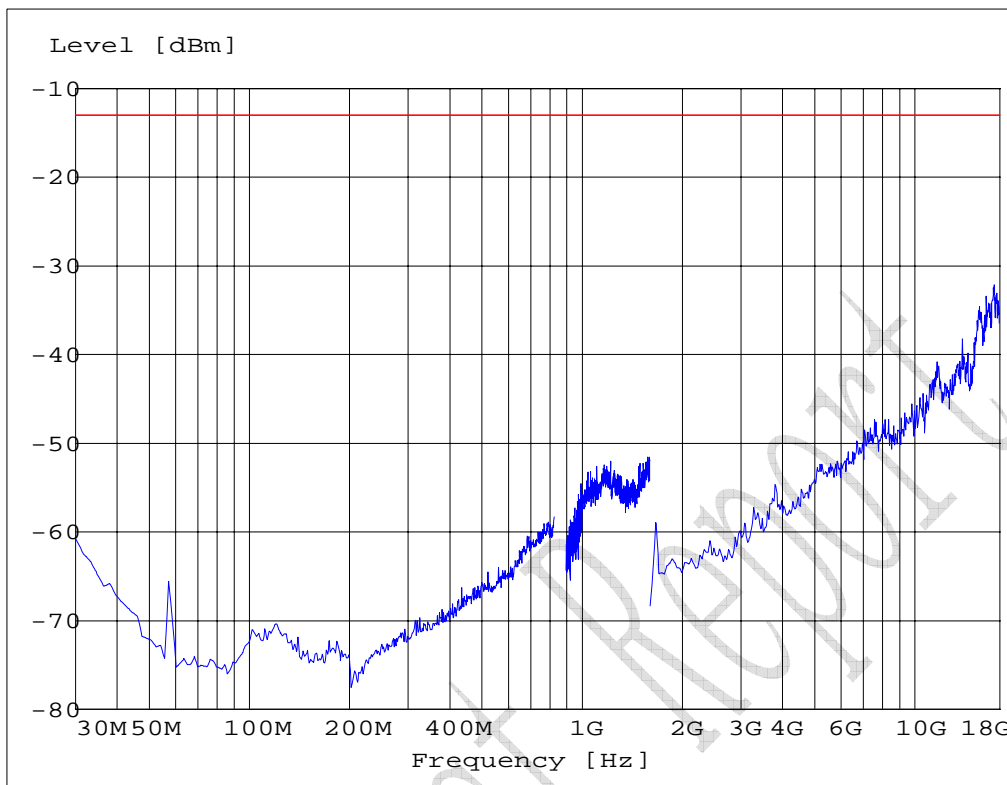

S4175VF for HSDPA FDD V mode

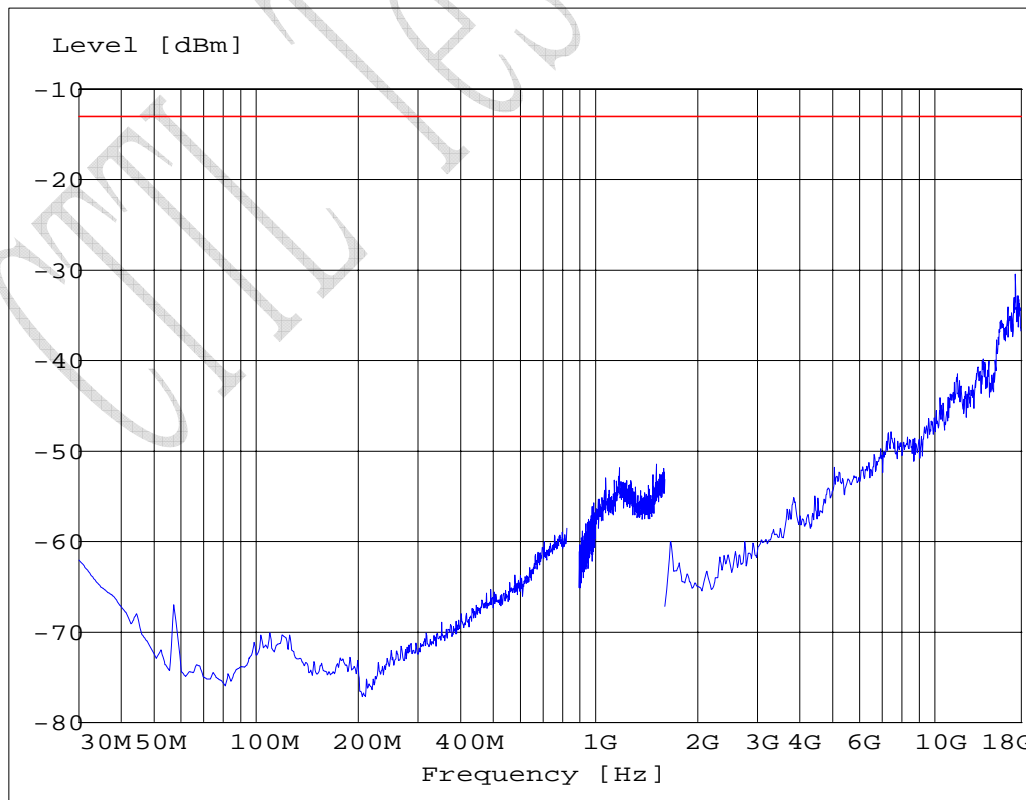

S4175HF for HSDPA FDD V mode

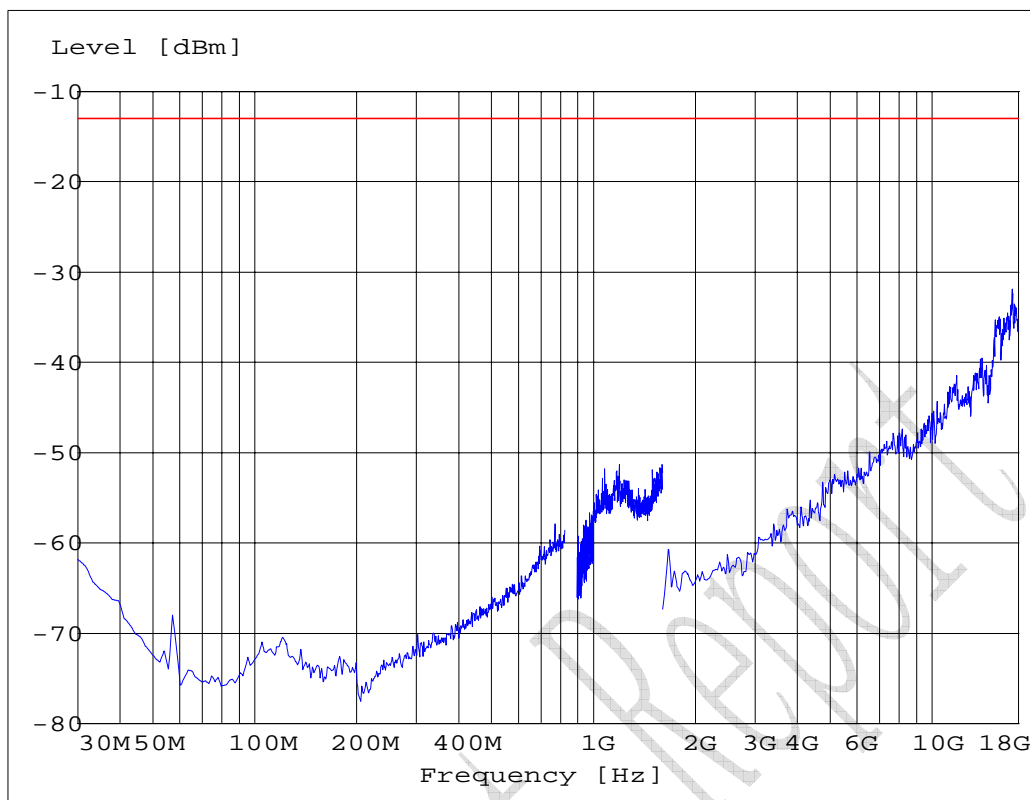

S4175VT for HSDPA FDD V mode

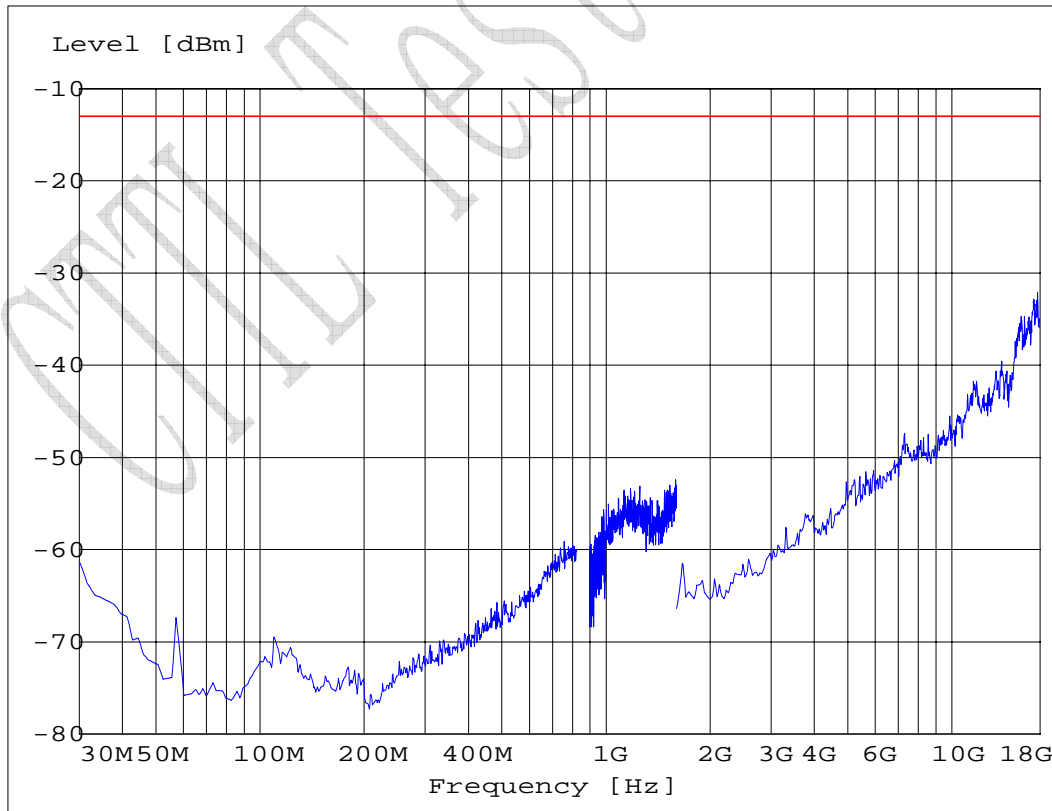

S4175HT for HSDPA FDD V mode

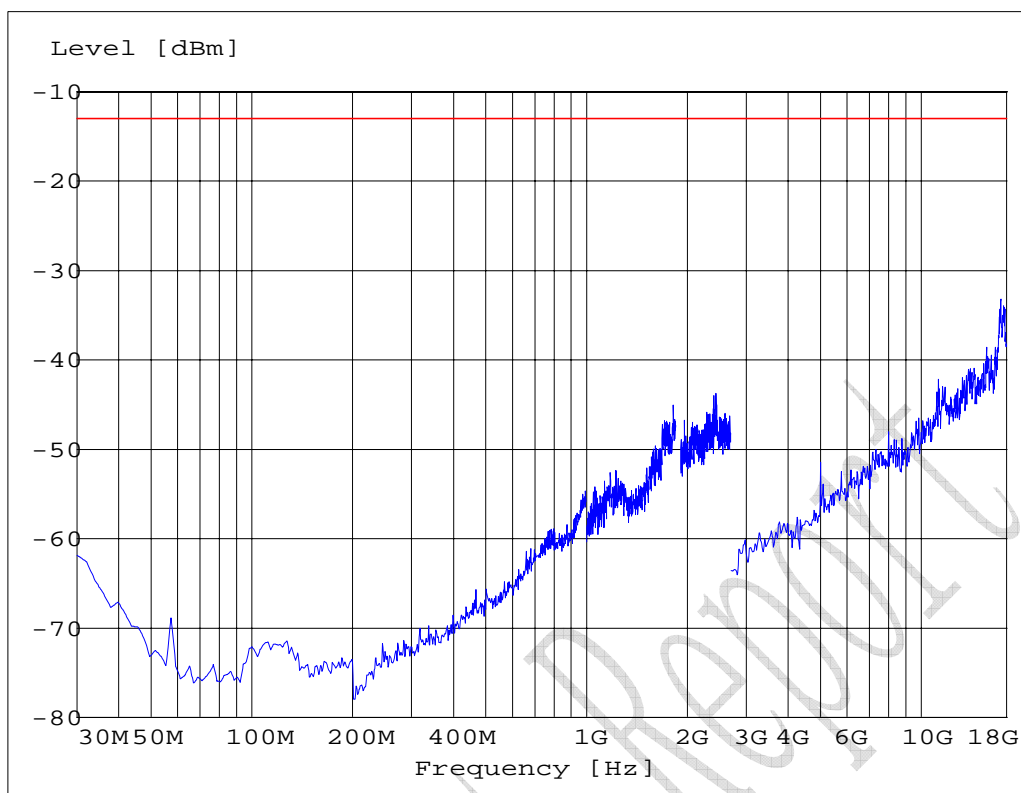

S9400VF for HSDPA FDD II mode

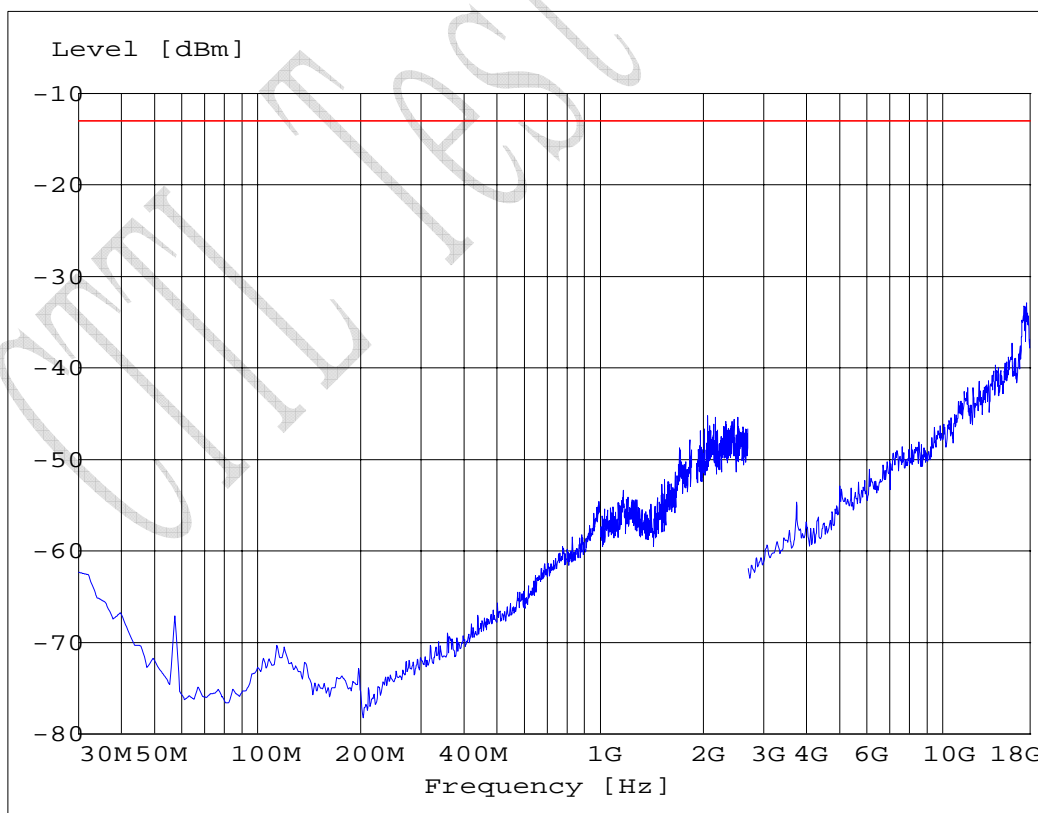

S9400HF for HSDPA FDD II mode

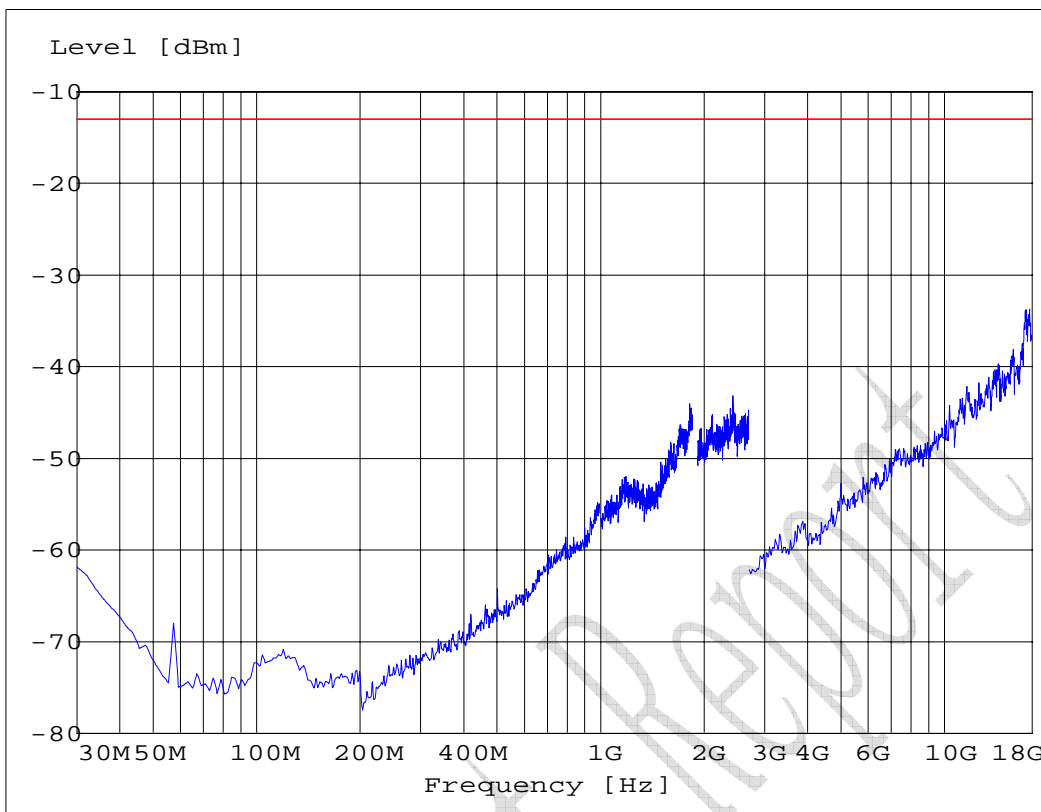

S9400VT for HSDPA FDD II mode

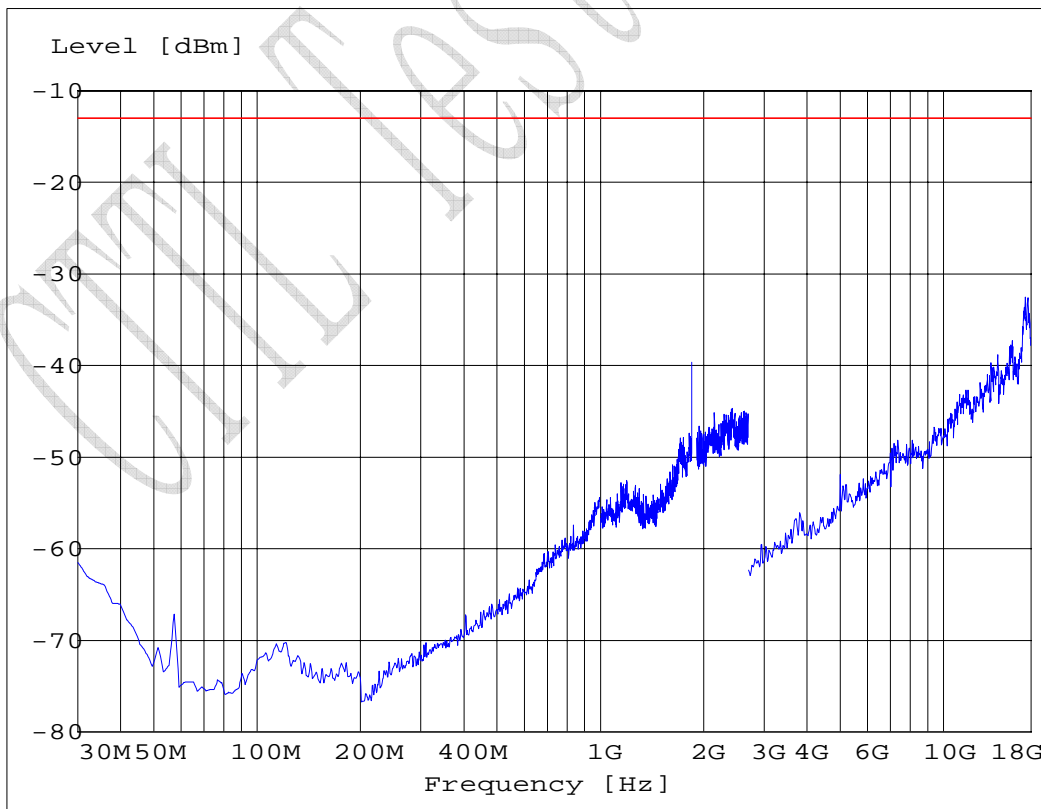

S9400HT for HSDPA FDD II mode

Test Results for HSUPA mode:

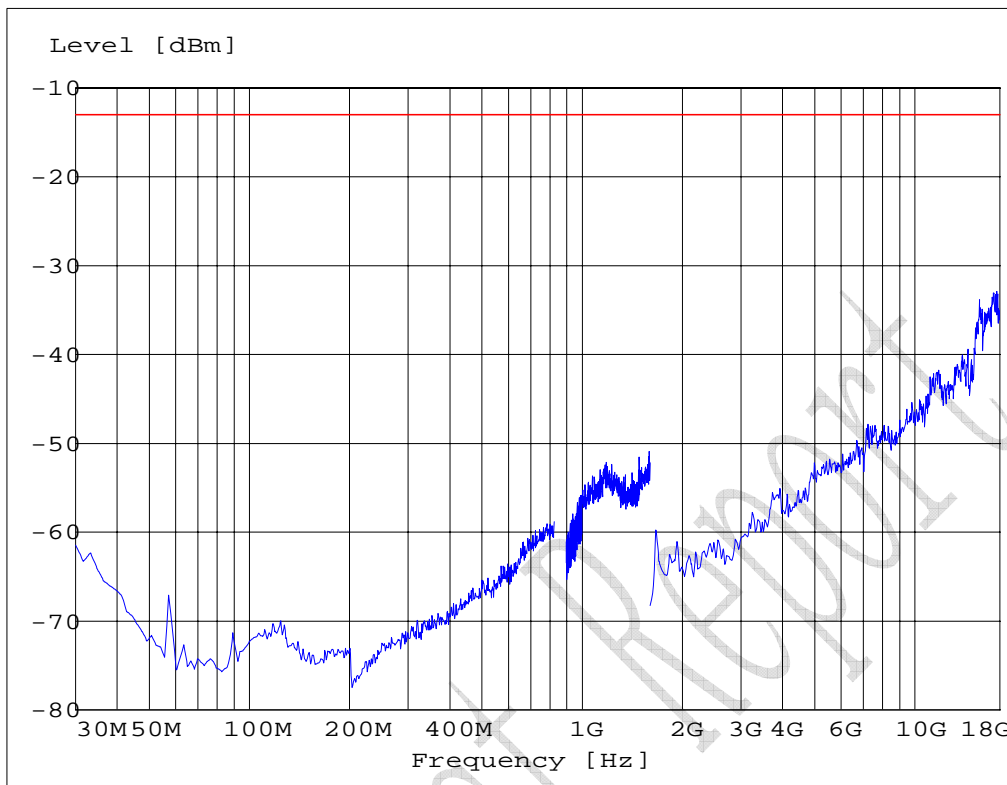

S4175VF for HSUPA FDD V mode

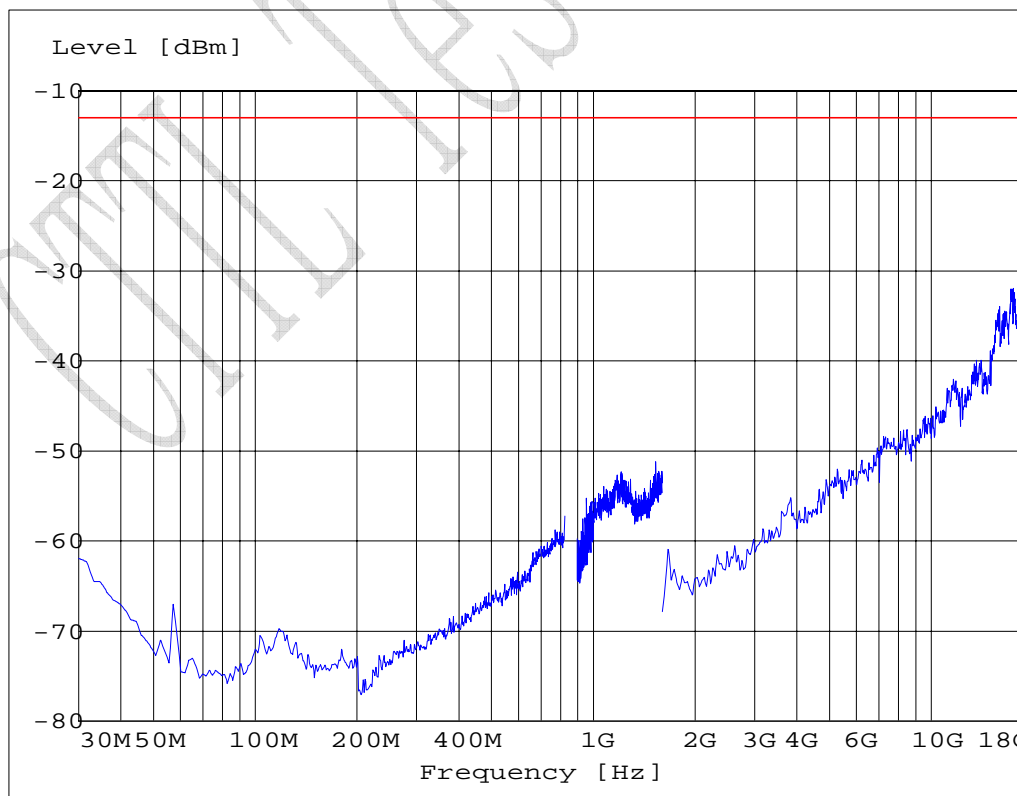

S4175HF for HSUPA FDD V mode

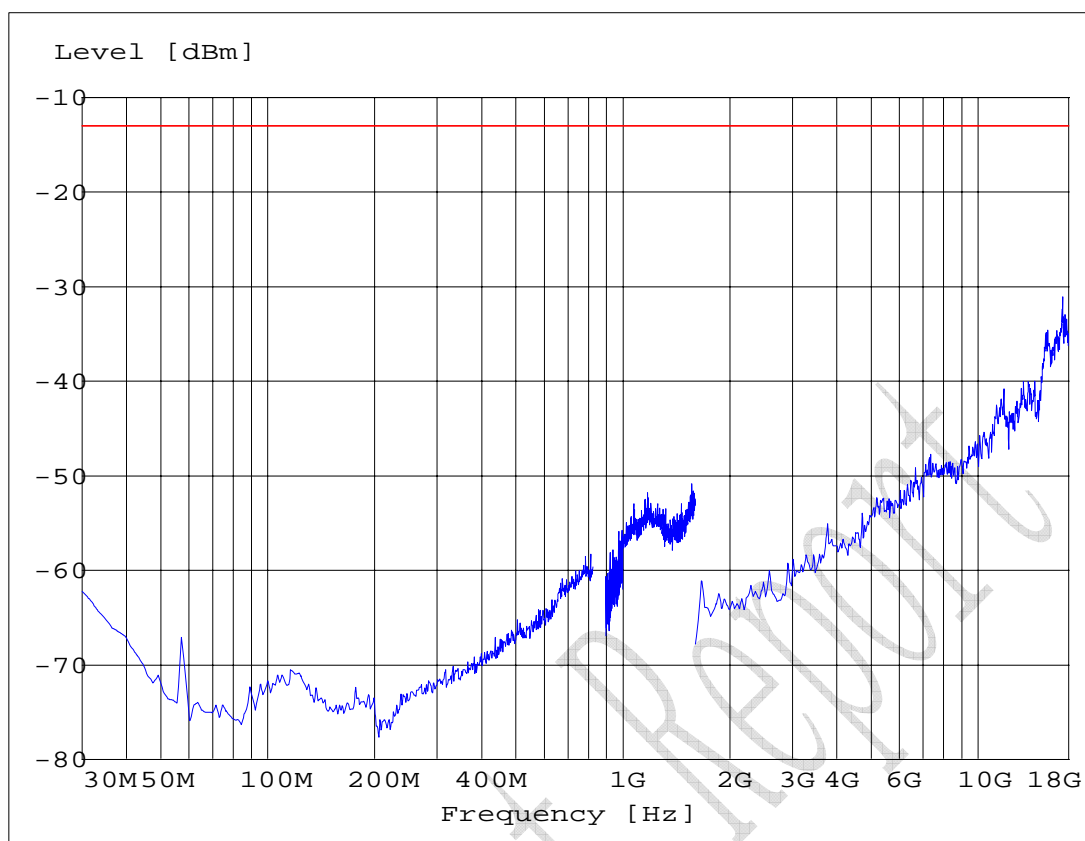

S4175VT for HSUPA FDD V mode

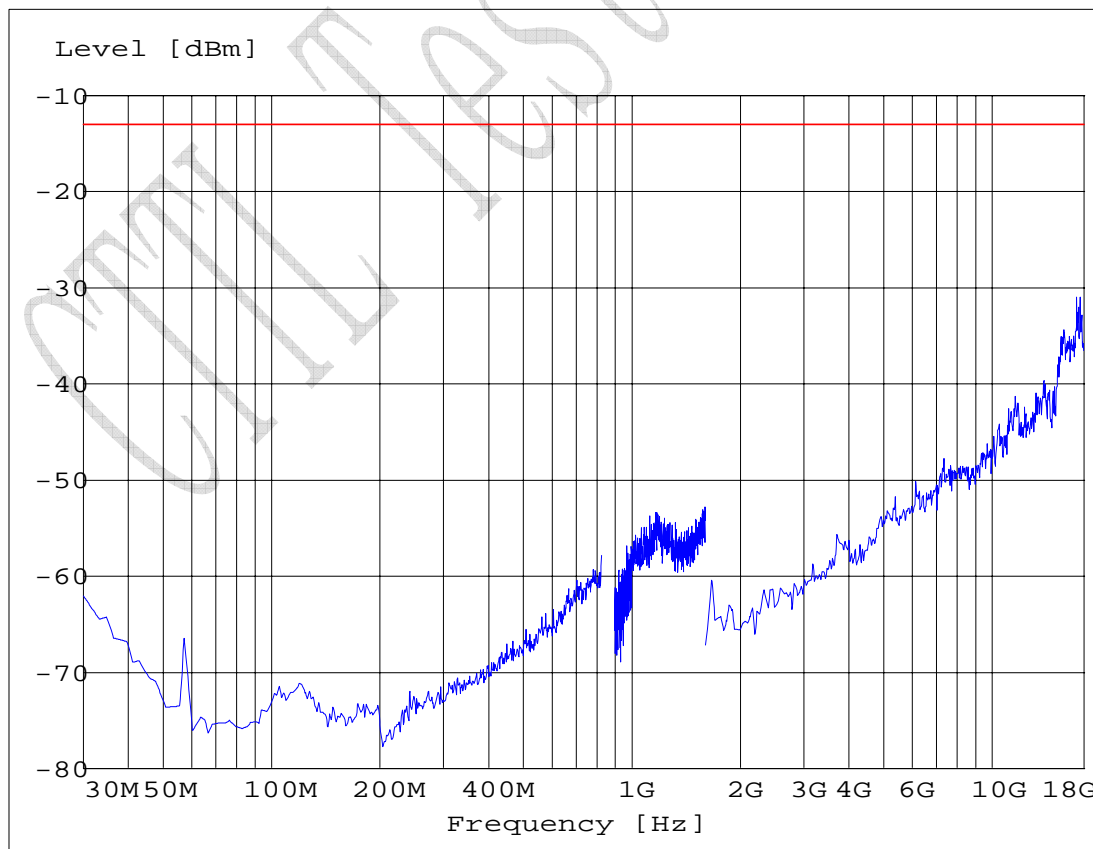

S4175HT for HSUPA FDD V mode

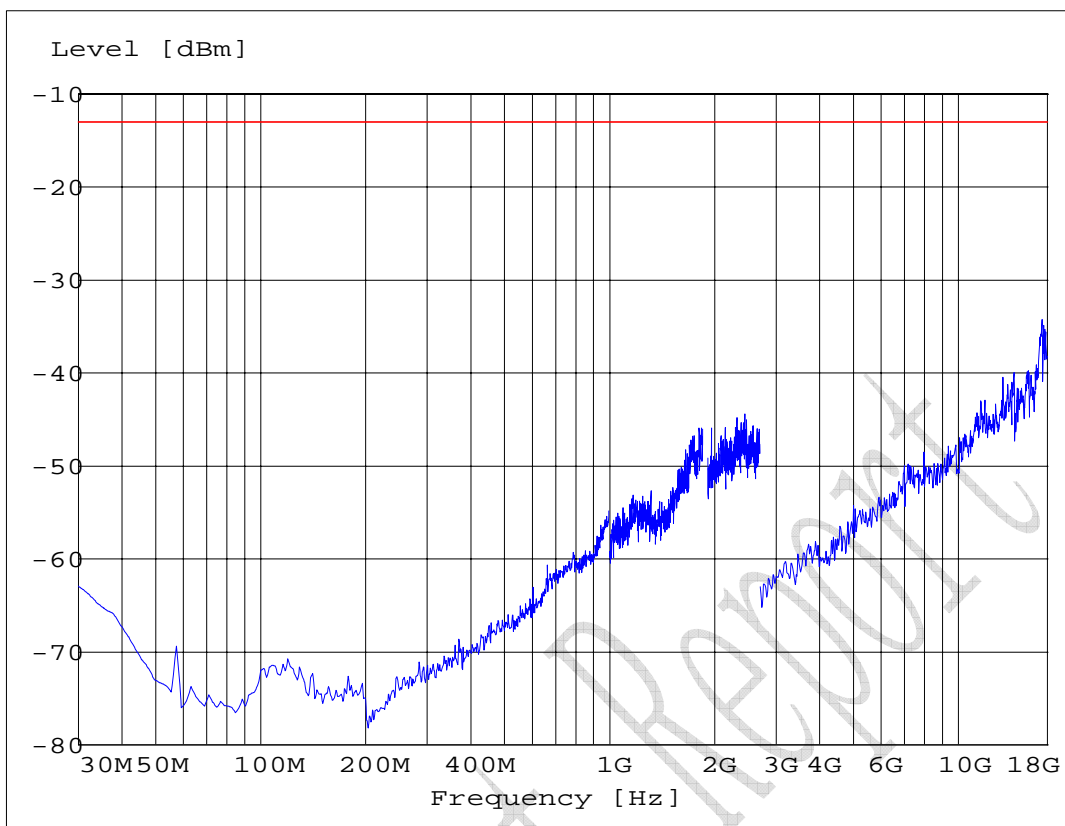

S9400VF for HSUPA FDD II mode

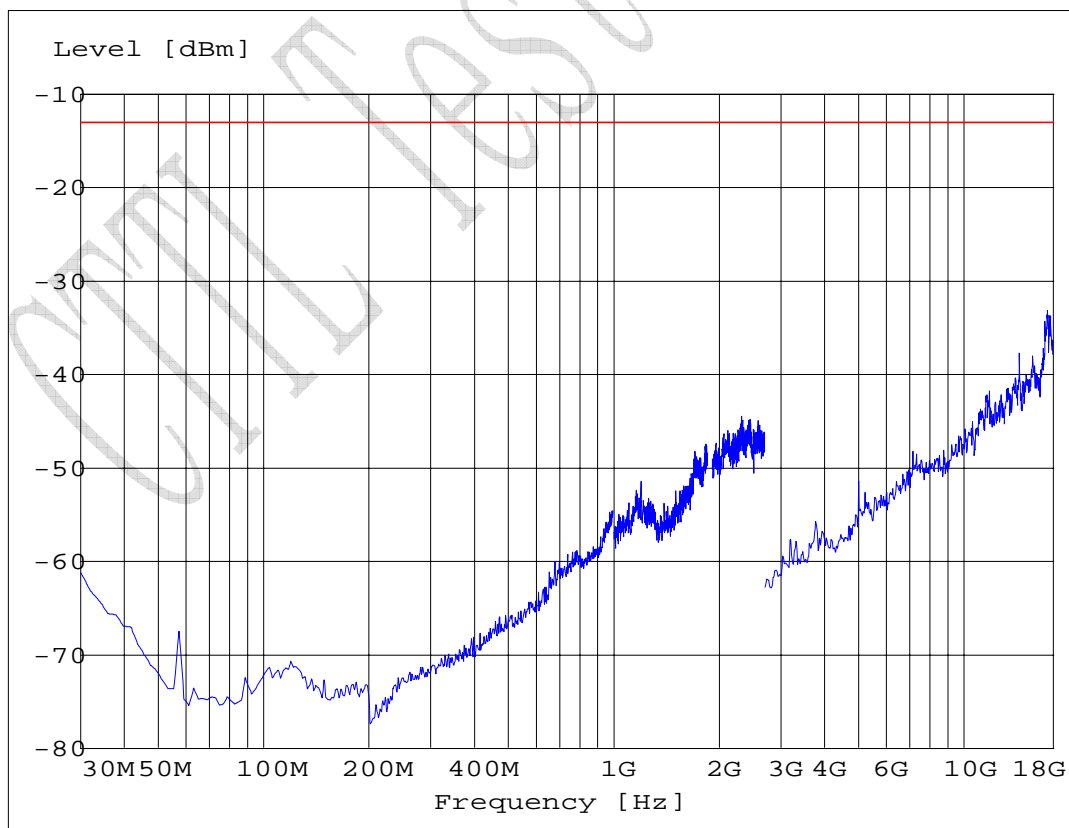

S9400HF for HSUPA FDD II mode

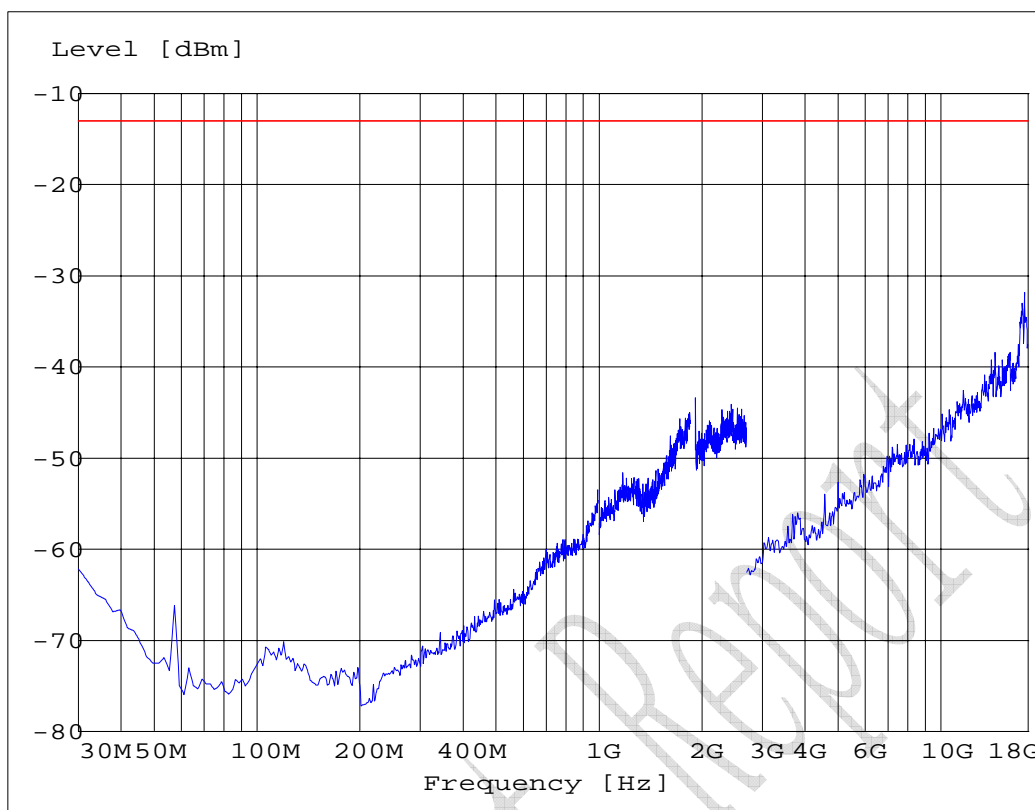

S9400VT for HSUPA FDD II mode

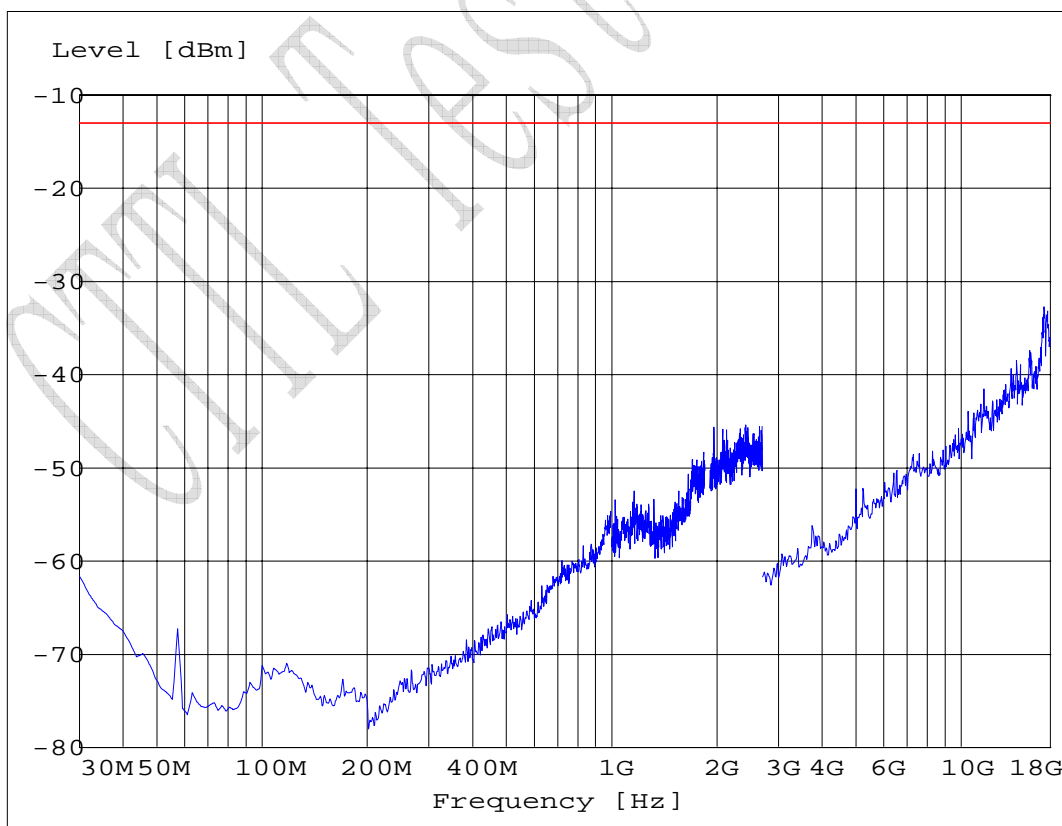

S9400HT for HSUPA FDD II mode

4.2 Radiated RF Power Output and ERP

Specifications:	2.1046,24.232,22.913(a)					
Date of Tests	2010-4-9					
Test conditions:	Ambient Temperature: 15°C-35°C Relative Humidity: 30%-60% Air pressure: 86-106kPa					
Operation Mode	TX on maximum transmitting power level at channel 4132, 4175, 4233, 9262, 9400 and 9538 for HSPA.					
Test Results:	Pass					
Test equipment Used:						
Asset Number	Description	Manufacturer	Model Number	Serial Number	Cal Due	State
7805	EMI Test Receiver	R/S	ESI26	100211	2011-01-11	Normal
7330	Ultra Broadband Antenna	SCHWARZBECK	VULB 9160	--	2012-10-26	Normal
7330	Double-Ridged Horn Antenna	R/S	HF906	100037	2012-01-09	Normal
713	Fully-Anechoic Chamber	ETS	11.8m×6.5m×6.3m	--	2013-11-16	Normal
023	Wireless Communications Test Set	Agilent	8960(E5515C)	GB41450323	2010-06-09	Normal
111835	Wireless Communications Test Set	R&S	CMU200	1100000802	--	Normal

Limit Level Construction:

(a) Radiated RF Power Output
According to Part 24.232(b), i.e., Mobile/portable stations are limited to 2 watts EIRP peak power and the equipment must employ means to limit the power to the minimum necessary for successful communications, so the limit level is 2 W or 33 dBm.

(b) ERP
According to Part 22.913(a), the ERP of mobile transmitters and auxiliary test transmitters must not exceed 7 Watts.

Limits for Radiated RF Power Output	
Frequency range	Limit Level (EIRP)/Resolution Bandwidth
TX channel	33dBm/1MHz
Limits for ERP	
Frequency range	Limit Level (ERP)
TX channel	7W

Test Setup:

The EUT was set in an anechoic chamber, which is connected to the Wireless Communications Test Set located outside the chamber over the air. The test was done using an automated test system, where all test equipments were controlled by a computer.

Test Method

The measurement was performed accordance with section 2.2.17 of ANSI/TIA-603-B-2002: *Land Mobile FM or PM Communications Equipment Measurement and Performance Standards*.

1 The maximum power was searched by turning the azimuth of the turntable, shifting the polarization of the measuring antenna and changing the pose of the EUT.

2 The measured levels are EIRP values corrected in the automated test system with the correction factors given by a substitution calibration made before the measurement. The calibration is made separately for vertical and horizontal polarization and the system uses different correction factors depending on the measuring antenna polarization.

3 The corrected maximum levels were reported for EIRP values, and ERP values can be calculated from EIRP values.

Note:

ERP dBm = EIRP dBm – 2.15dB.

ERP Value for HSDPA FDD V band mode:

ARFCN	Frequency [MHz]	EIRP [dBm]
4132	825.531062	21.89
4175	833.847695	22.79
4233	845.571142	22.54

EIRP Value for HSDPA FDD II band mode:

ARFCN	Frequency [MHz]	EIRP [dBm]
9262	1851.422846	21.01
9400	1878.877756	18.26
9538	1906.533066	18.44

ERP Value for HSUPA FDD V band mode:

ARFCN	Frequency [MHz]	EIRP [dBm]
4132	827.434870	21.81
4175	834.048096	22.96
4233	845.370741	22.94

EIRP Value for HSUPA FDD II band mode:

ARFCN	Frequency [MHz]	EIRP [dBm]
9262	1851.022044	20.75
9400	1879.278557	18.00
9538	1906.533066	19.31

TTL Test Report

4.3 Occupied bandwidth

Specifications:	2.1049,22.917(b),24.238(b)					
Date of Test	2010-4-8					
Test conditions:	Ambient Temperature: 15°C-35°C Relative Humidity: 30%-60% Air pressure: 86-106kPa					
Operation Mode	TX on maximum transmitting power level at channel 4132, 4175, 4233, 9262, 9400 and 9538 for HSPA.					
Test Results:	--					
Test equipment Used:						
Asset Number	Description	Manufacturer	Model Number	Serial Number	Cal Due	State
7805	EMI Test Receiver	R/S	ESI26	100211	2011-01-11	Normal
023	Wireless Communications Test Set	Agilent	8960(E5515C)	GB41450323	2010-06-09	Normal
111835	Wireless Communications Test Set	R&S	CMU200	1100000802	--	Normal

Test Setup

During the process of testing, the EUT was controlled via Wireless Communications Test Set to ensure max power transmission and proper modulation and measured by Rhode & Schwarz EMI test receiver (ESI26)

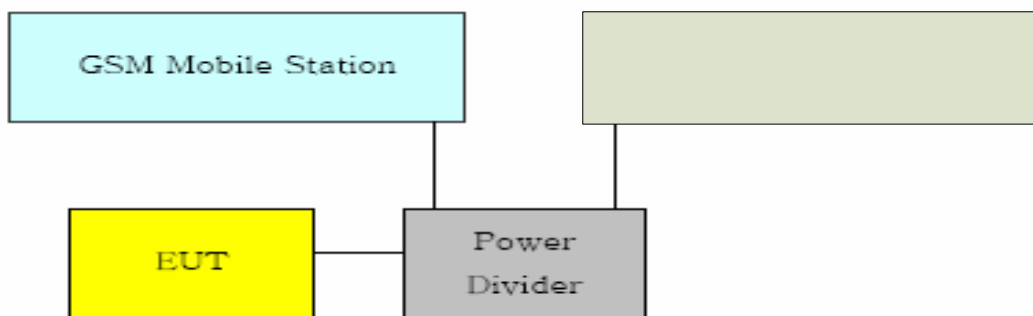

Test Method

The 99% occupied bandwidth was calculated from the spectrum analyzer. Markers in the spectrum analyzer were then placed between the calculated frequencies to show the calculated 99% power band.

Note:

--

Results data of HSDPA mode:

EUT channel	99% occupied bandwidth [MHz]
4132	4.208
4175	4.208
4233	4.168
9262	4.248
9400	4.208
9538	4.248

Graphical results for HSDPA mode:

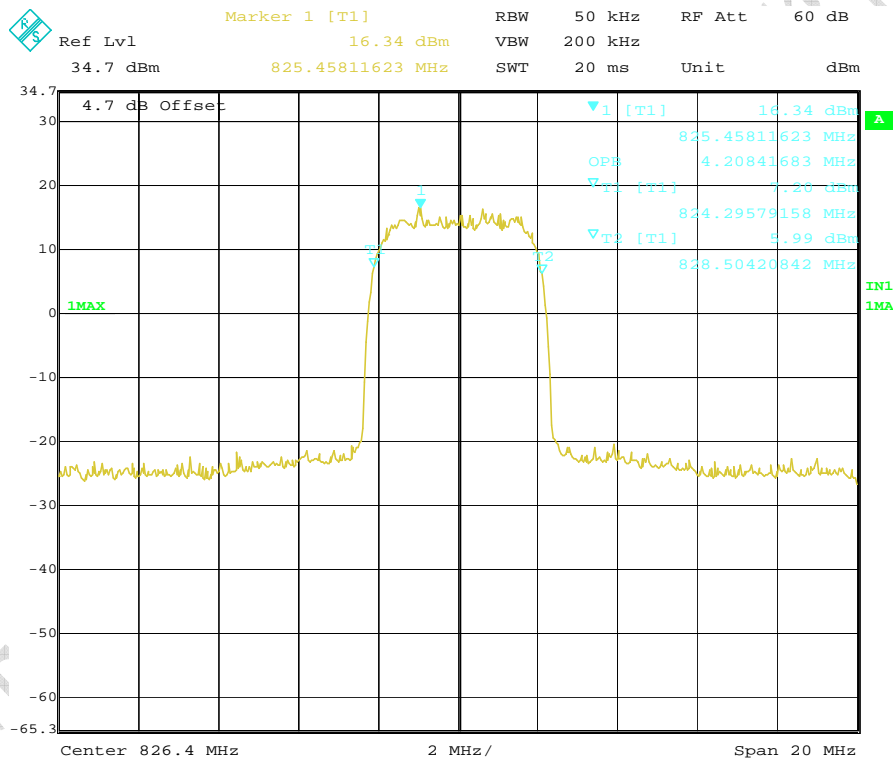

Channel 4132

FCC Parts 2, 22, 24
Equipment: MC8795V

Supplement to Test Report I09GW6944-FCC-EMC-3

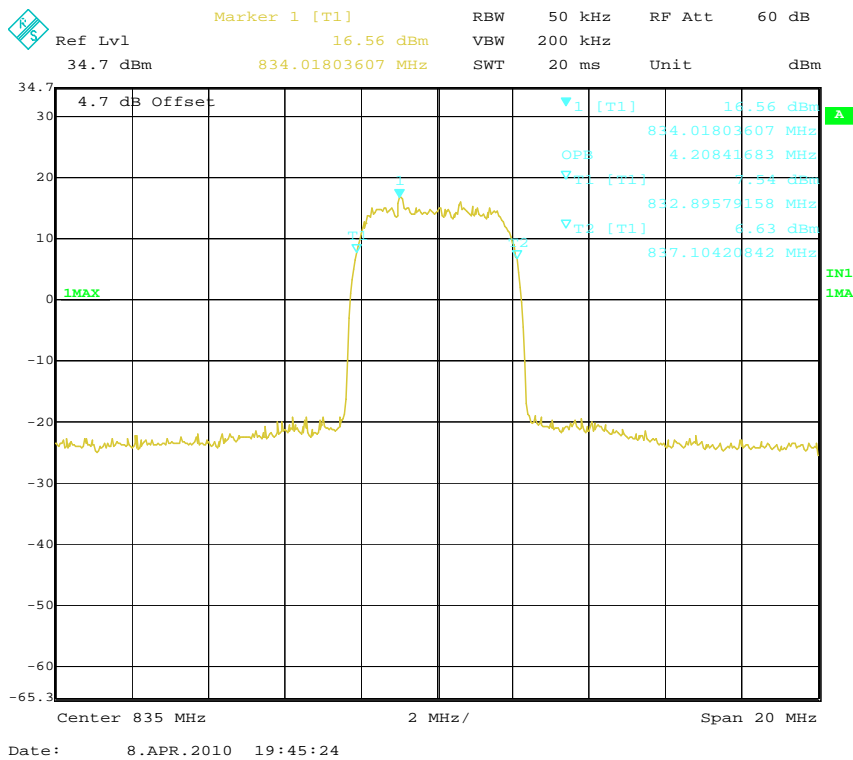

Channel 4175

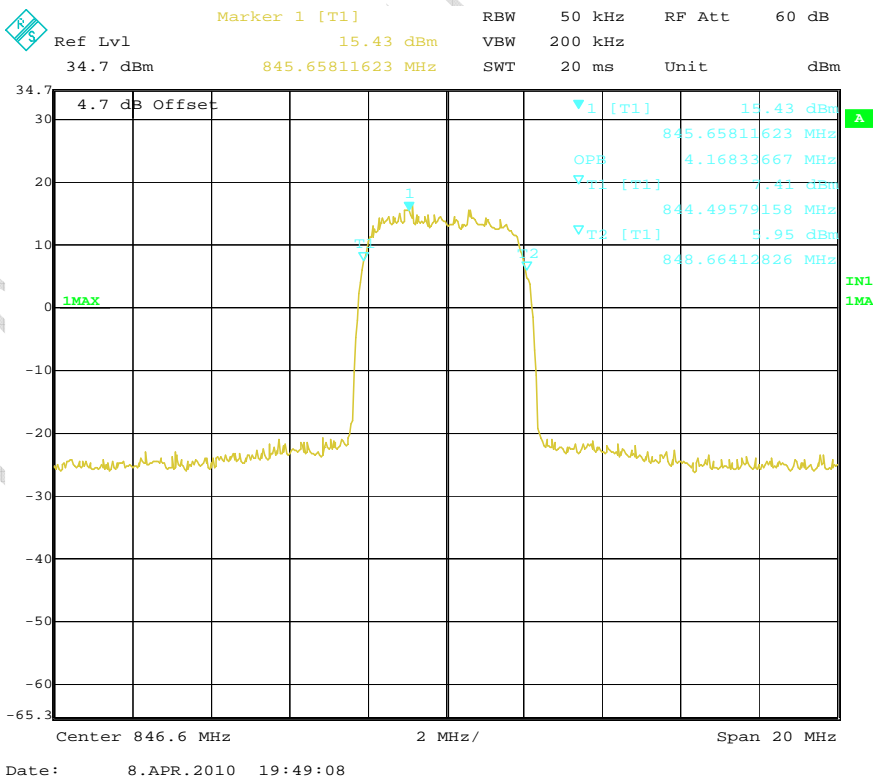

Channel 4233

FCC Parts 2, 22, 24
Equipment: MC8795V

Supplement to Test Report I09GW6944-FCC-EMC-3

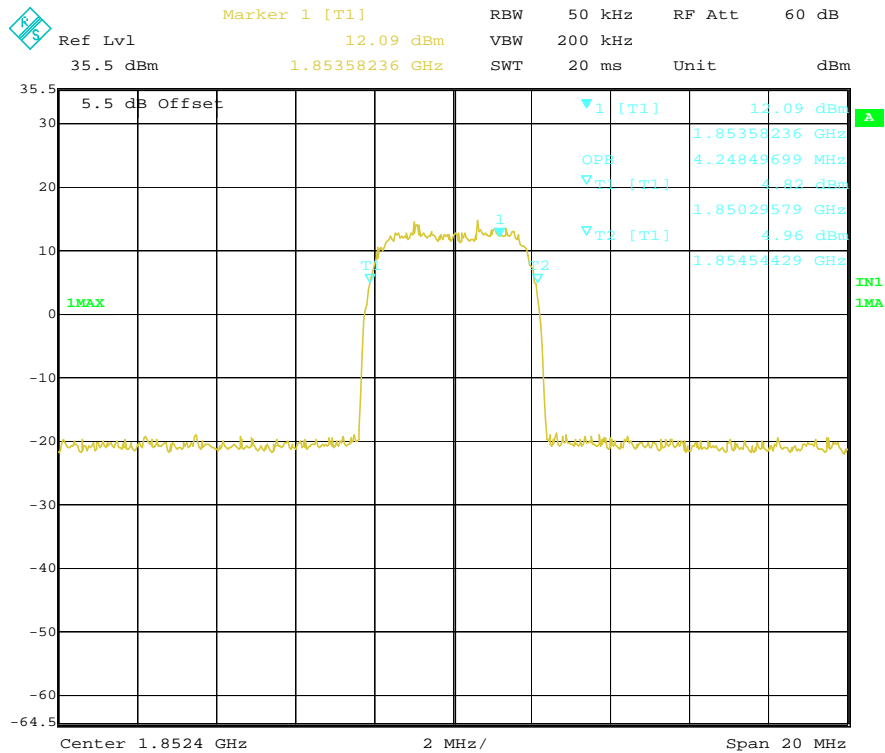

Date: 8.APR.2010 17:44:07

Channel 9262

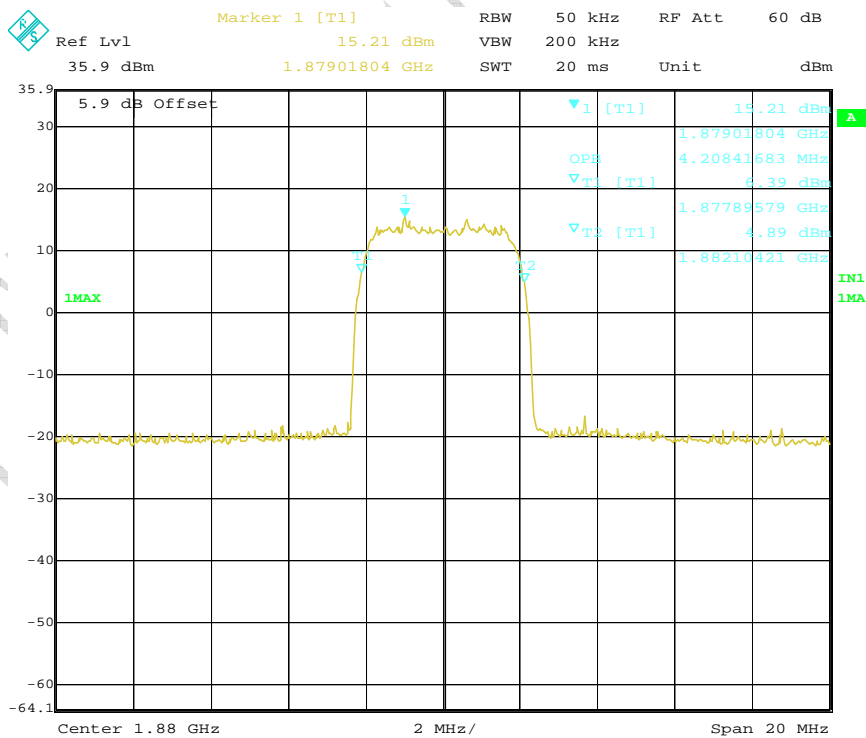

Date: 8.APR.2010 18:36:57

Channel 9400

FCC Parts 2, 22, 24
Equipment: MC8795V

Supplement to Test Report I09GW6944-FCC-EMC-3

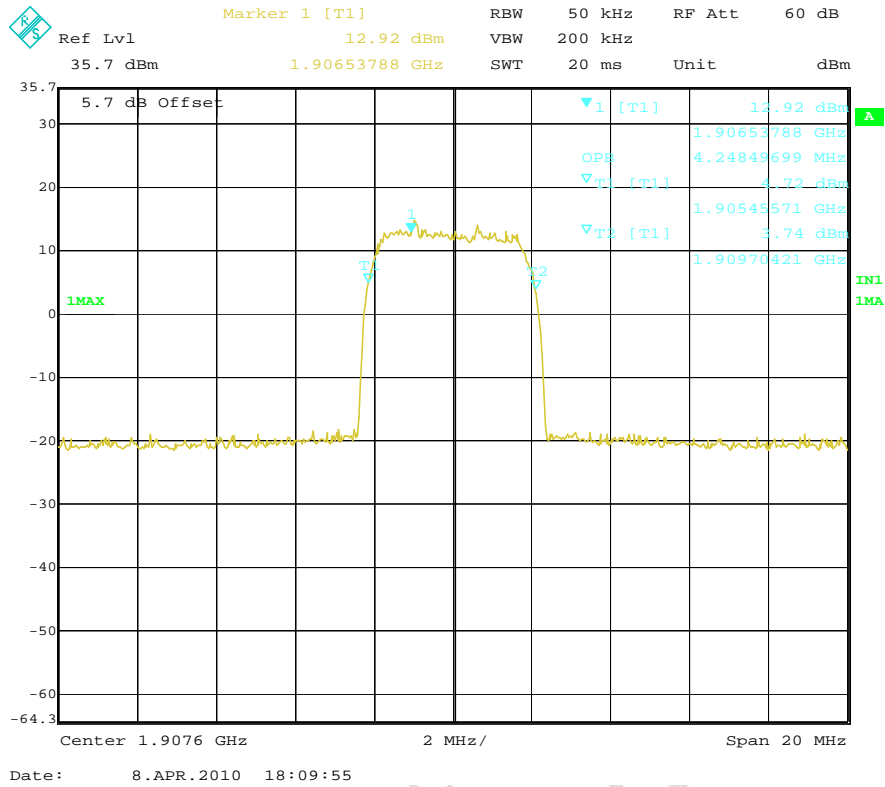

Channel 9538

TTL TEST

Results data of HSUPA mode:

EUT channel	99% occupied bandwidth [MHz]
4132	4.208
4175	4.208
4233	4.168
9262	4.208
9400	4.208
9538	4.208

Graphical results for HSUPA mode:

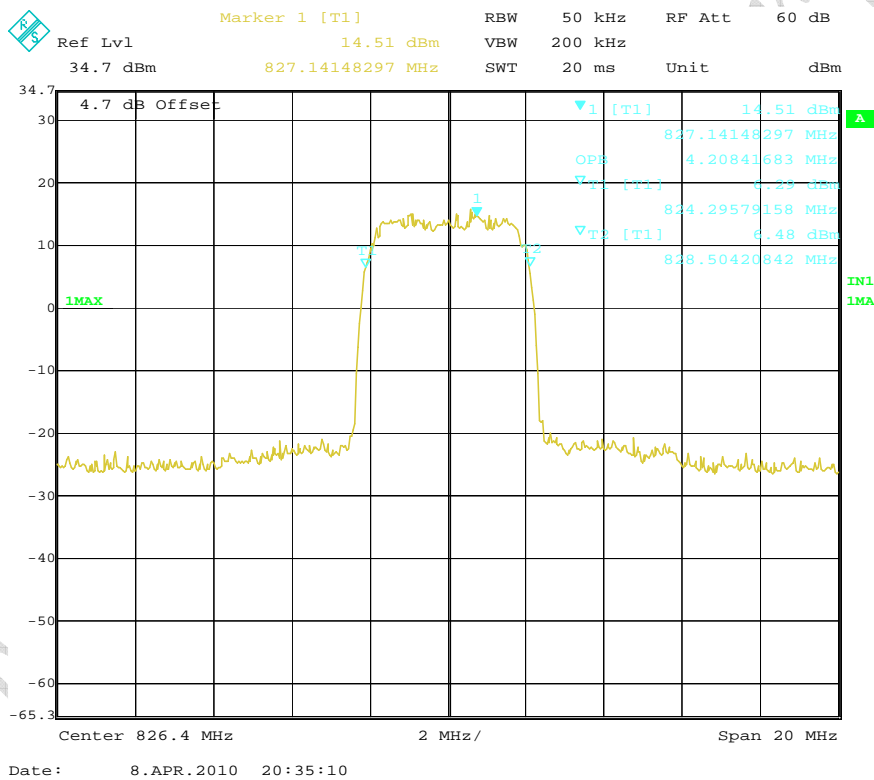

Channel 4132

FCC Parts 2, 22, 24
Equipment: MC8795V

Supplement to Test Report I09GW6944-FCC-EMC-3

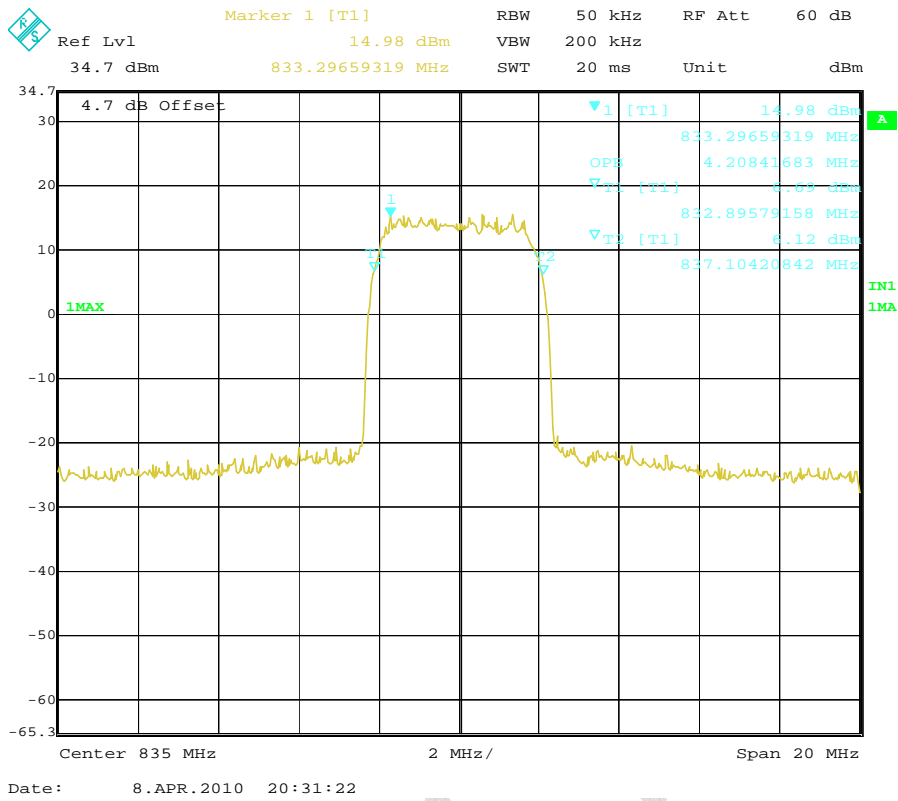

Channel 4175

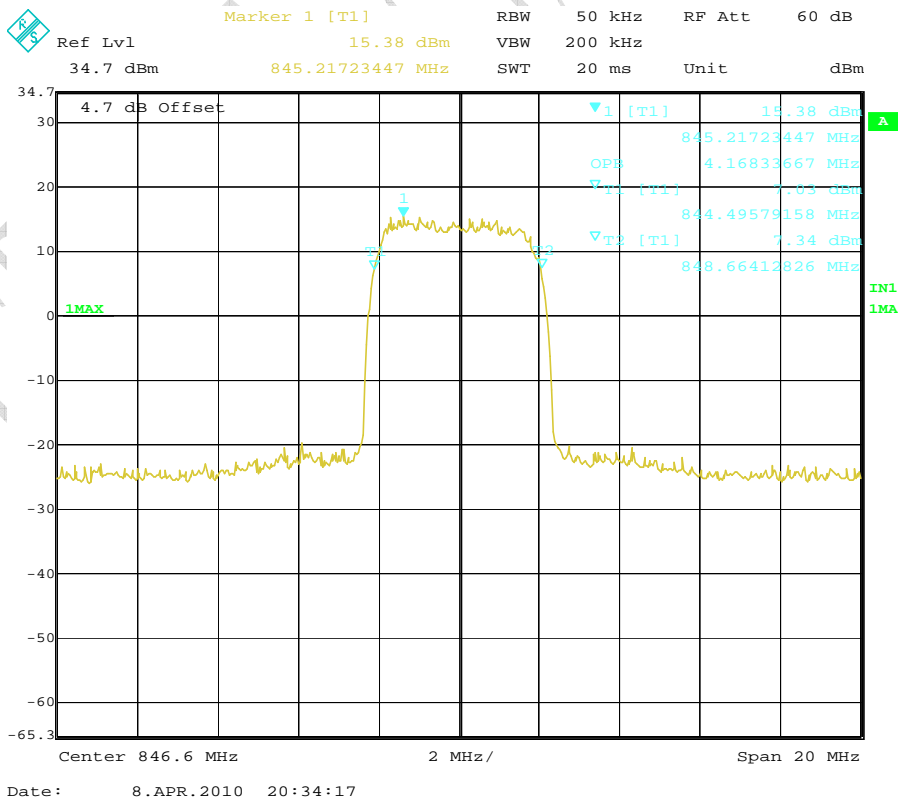

Channel 4233

FCC Parts 2, 22, 24
Equipment: MC8795V

Supplement to Test Report I09GW6944-FCC-EMC-3

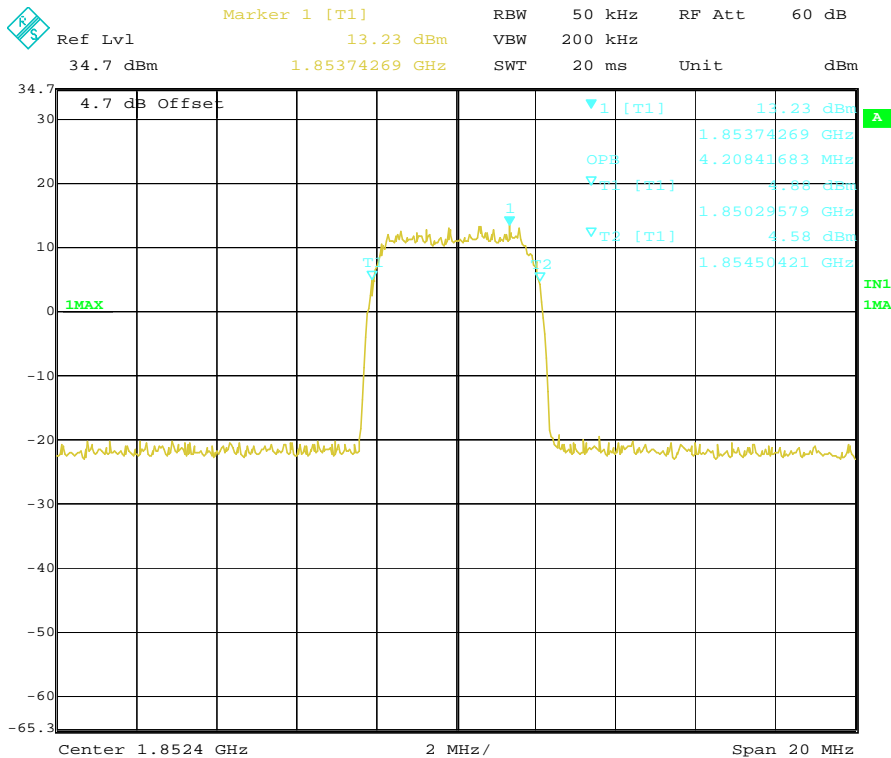

Channel 9262

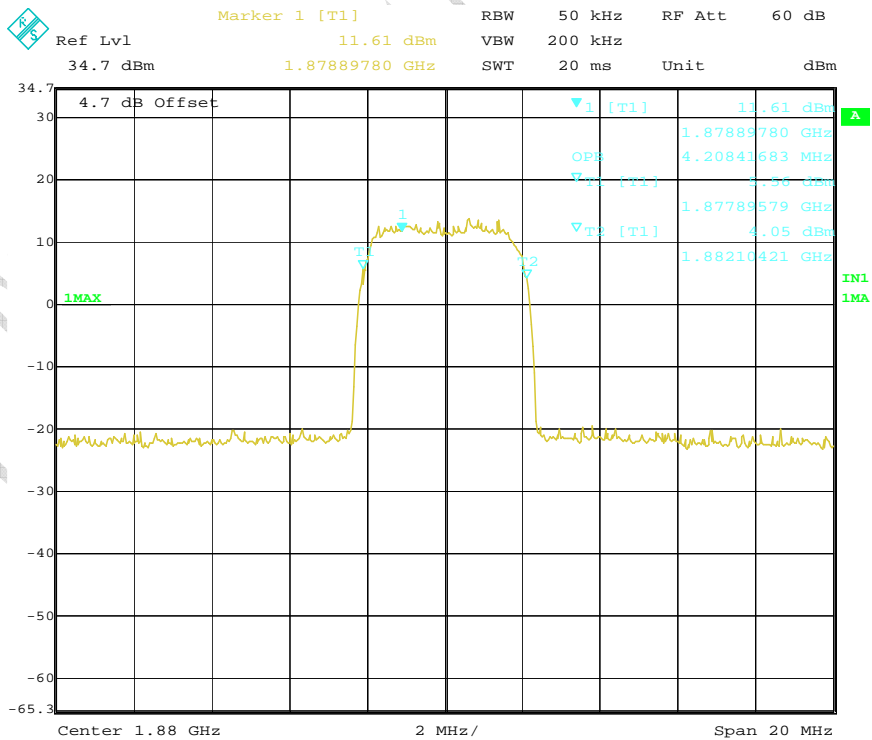

Channel 9400

FCC Parts 2, 22, 24
Equipment: MC8795V

Supplement to Test Report I09GW6944-FCC-EMC-3

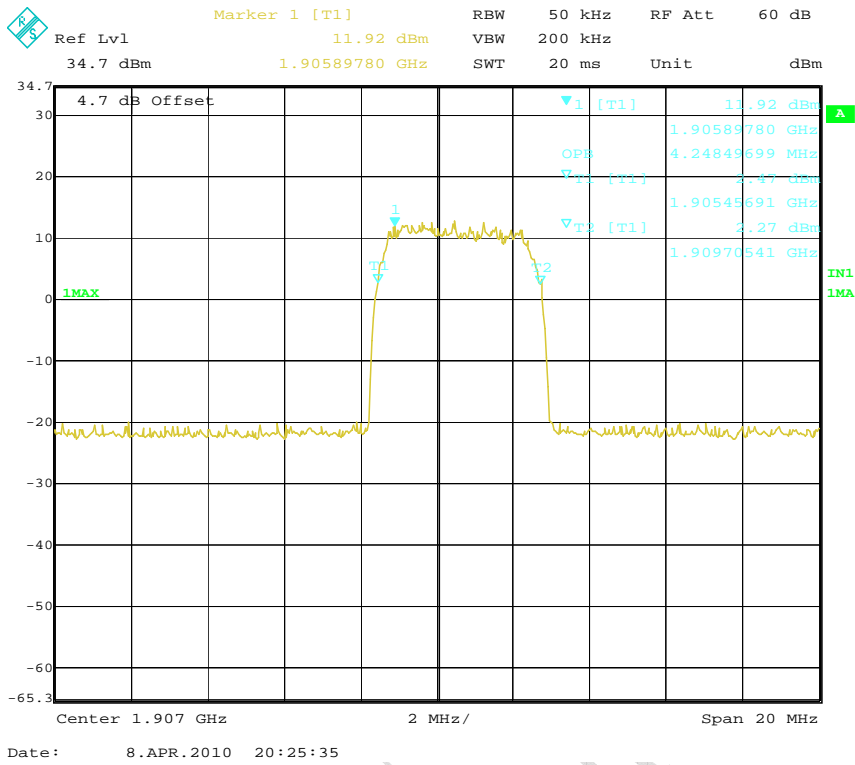

Channel 9538

4.4 Frequency Stability over Temperature Variation

Specifications:	2.1055,22.355,24.235					
Date of Test	2010-4-9					
Test conditions:	Ambient Temperature: -30°C-50°C Relative Humidity: 30%-60% Air pressure: 86-106kPa					
Operation Mode	TX on maximum transmitting power level at channel 4175 and 9400 for HSPA					
Test Results:	Pass					
Test equipment Used:						
Asset Number	Description	Manufacturer	Model Number	Serial Number	Cal Due	State
023	Wireless Communications Test Set	Agilent	8960(E5515C)	GB41450323	2010-06-09	Normal
561	Temperature Chamber	Terchy Environmental Technology LTD.	MHU-800SR	84121202	2011-01-06	Normal
111835	Wireless Communications Test Set	R&S	CMU200	1100000802	--	Normal
Limit						
Frequency deviation [ppm]	±2.5					

Test Setup

The EUT was placed in a temperature chamber, demonstrated as figure T. The wireless communications test set (test simulator) was used to set the TX channel and power levels, modulate the TX signal with different bit patterns and measure the frequency of TX.

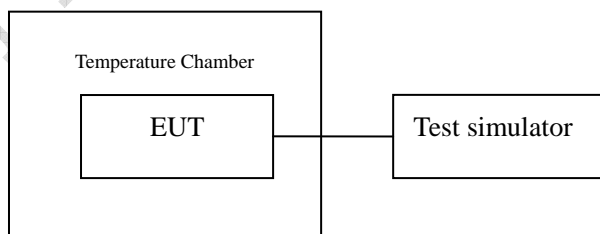

Figure T: setup for measurement of frequency stability over temperature variation

Test Method

1. The EUT was turned off and placed in the temperature chamber.
2. The temperature of the chamber was set to -30°C and allowed to stabilize.
3. The EUT temperature was allowed to stabilize for 45 minutes.
4. The EUT was turned on and set to transmit with Simulator.
5. The maximum transmit frequency deviation during one minute period was measured by Wireless Communications Test Set.
6. The steps 3-5 were repeated for -20°C, -10°C, 0°C, 10°C, 20°C, 30°C, 40°C and 50°C.

Test results data for HSDPA mode:

Channel 4175: Compliance windows: 2087.5Hz

Temperature[°C]	Deviation[Hz]	Remarks
-30	-23	Pass
-20	-21	Pass
-10	-23	Pass
0	-20	Pass
10	-18	Pass
20	-17	Pass
30	-9	Pass
40	-11	Pass
50	-12	Pass

Channel 661: Compliance windows: 4700Hz

Temperature[°C]	Deviation[Hz]	Remarks
-30	-26	Pass
-20	-24	Pass
-10	-20	Pass
0	-23	Pass
10	-18	Pass
20	-16	Pass
30	-17	Pass
40	-12	Pass
50	-16	Pass

Test results data for HSUPA mode:

Channel 4175: Compliance windows: 2087.5Hz

Temperature[°C]	Deviation[Hz]	Remarks
-30	-12	Pass
-20	-11	Pass
-10	-9	Pass
0	-12	Pass
10	-14	Pass
20	-9	Pass
30	-13	Pass
40	-13	Pass
50	-7	Pass

Channel 661: Compliance windows: 4700Hz

Temperature[°C]	Deviation[Hz]	Remarks
-30	-27	Pass
-20	-14	Pass
-10	-19	Pass
0	-18	Pass
10	-20	Pass
20	-19	Pass
30	-21	Pass
40	-23	Pass
50	-23	Pass

4.5 Frequency Stability over Voltage Variation

Specifications:	2.1055,22.355,24.235					
Date of Test	2010-4-8					
Test conditions:	Ambient Temperature: 15°C-35°C Relative Humidity: 30%-60% Air pressure: 86-106kPa					
Operation Mode	TX on maximum transmitting power level at channel 4175 and 9400 for HSPA					
Test Results:	Pass					
Test equipment Used:						
Asset Number	Description	Manufacturer	Model Number	Serial Number	Cal Due	State
023	Wireless Communications Test Set	Agilent	8960(E5515C)	GB41450323	2010-06-09	Normal
7982	DC Power Source	4NIC	DH1715A-3	004224	--	Normal
Limit						
Frequency deviation [ppm]	±2.5					

Test Setup

The EUT was placed in a shielding chamber and powered by the dummy battery which is connected to a DC power source, demonstrated as figure V. The wireless communications test set was used to set the TX channel and power level, modulate the TX signal with different bit patterns and measure the frequency of TX.

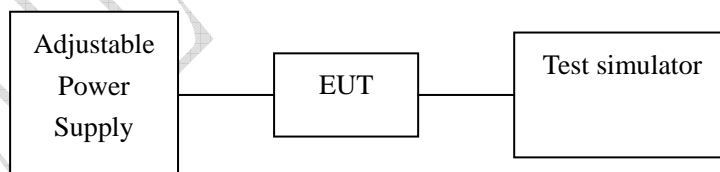

Figure V: test setup for measurement of frequency stability over voltage variation

Test Results data for HSDPA mode:

Channel 4175: Compliance windows: 2087.5Hz

Level	Voltage[V]	Deviation[Hz]	Remarks
Nominal	3.3	3	Pass
Cut-off point	2.8	-19	Pass

Channel 9400: Compliance windows: 4700Hz

Level	Voltage[V]	Deviation[Hz]	Remarks
Nominal	3.3	14	Pass
Cut-off point	3.0	-28	Pass

Test Results data for HSUPA mode:

Channel 4175: Compliance windows: 2087.5Hz

Level	Voltage[V]	Deviation[Hz]	Remarks
Nominal	3.3	-12	Pass
Cut-off point	2.7	-20	Pass

Channel 9400: Compliance windows: 4700Hz

Level	Voltage[V]	Deviation[Hz]	Remarks
Nominal	3.3	13	Pass
Cut-off point	2.8	-38	Pass

4.6 Conducted RF Power Output

Specifications:	2.1046,22.913(a),24.232(c)					
Date of Tests	2010-4-8					
Test conditions:	Ambient Temperature: 15°C-35°C Relative Humidity: 30%-60% Air pressure: 86-106kPa					
Operation Mode	TX on maximum transmitting power level at channel 4175 and 9400 for HSPA					
Test Results:	Pass					
Test equipment Used:						
Asset Number	Description	Manufacturer	Model Number	Serial Number	Cal Due	State
7805	EMI Test Receiver	R/S	ESI26	100211	2011-01-11	Normal
023	Wireless Communications Test Set	Agilent	8960(E5515C)	GB41450323	2010-06-09	Normal
---	Power splitter	Jie sai	---	1000132	2011-01-04	Normal
111835	Wireless Communications Test Set	R&S	CMU200	1100000802	--	Normal

Limits for Radiated RF Power Output	
Frequency range	Limit Level (EIRP)/Resolution Bandwidth
TX channel	33dBm/1MHz
Limits for ERP	
Frequency range	Limit Level (ERP)
TX channel	7W

Test Setup:

During the process of testing, the EUT was controlled via the Wireless Communications Test Set to ensure max power transmission and proper modulation and measured by Rhode & Schwarz EMI test receiver (ESI26).

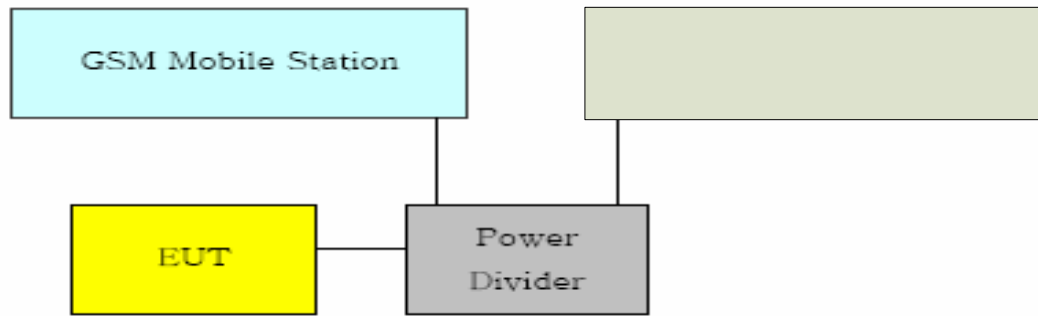

Test Method

- 1) The EUT was coupled to the EMI test receiver analyzer mode and the base station simulator through a power divider. The radio frequency load attached to the EUT antenna terminal was 50 Ohm. The lost of the cables the test system is calibrated to correct the readings.
- 2) The spectrum analyzer was set to Maxpeak Detector function and Maximum hold mode.
- 3) The resolution bandwidth of the spectrum analyzer was comparable to the emission bandwidth.

Note: --

Test Results for HSPA mode:

ARFCN	Peak output power [dBm] - HSDPA	Peak output power [dBm] - HSUPA
4132	23.64	23.40
4175	23.48	23.84
4233	23.78	23.77
9262	22.01	21.84
9400	22.57	22.70
9538	22.29	22.04

4.7 Conducted Spurious Emission

Specifications:	2.1051,22.917,24.238					
Date of Tests	2010-4-8					
Test conditions:	Ambient Temperature: 15°C-35°C Relative Humidity: 30%-60% Air pressure: 86-106kPa					
Operation Mode	TX on maximum transmitting power level at channel 4175 and 9400 for HSPA					
Test Results:	Pass					
Test equipment Used:						
Asset Number	Description	Manufacturer	Model Number	Serial Number	Cal Due	State
7805	EMI Test Receiver	R/S	ESI26	100211	2011-01-11	Normal
023	Wireless Communications Test Set	Agilent	8960(E5515C)	GB41450323	2010-06-09	Normal
---	Power splitter	Jie sai	---	1000132	2011-01-04	Normal
111835	Wireless Communications Test Set	R&S	CMU200	1100000802	--	Normal

Limit Level Construction:

According to Part 24.238 (a), i.e., Out of band emissions. The power of any emission outside of the authorized operating frequency ranges must be attenuated below the transmitting power (P) by a factor of at least $43 + 10 \log(P)$ dB, so the limit level is:
 $P(\text{dBm}) - (43 + 10 \log(P)) \text{ dB} = -13\text{dBm}$

Limits for Radiated spurious emissions(UE)

Frequency range	Limit Level /Resolution Bandwidth
30 MHz to 20000 MHz	-13dBm/1MHz

Test Setup:

During the process of testing, the EUT was controlled via Wireless Communications Test Set to ensure max power transmission and proper modulation and measured by Rhode & Schwarz EMI test receiver (ESI26)

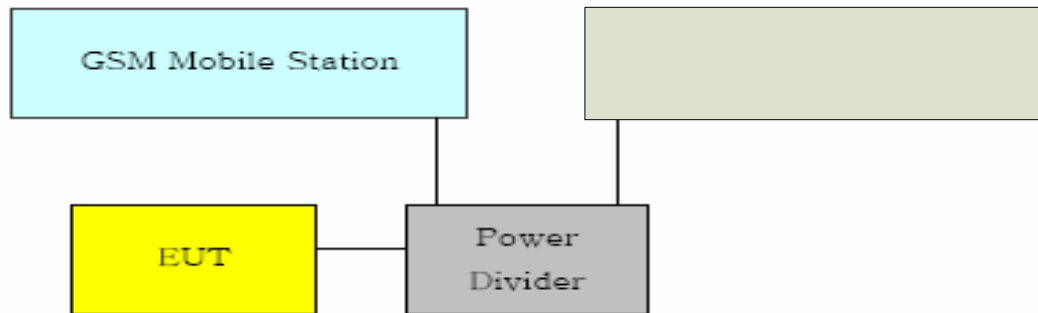

Test Method

The measurement was performed accordance with section 2.2.13 of ANSI/TIA-603-B-2002: *Land Mobile FM or PM Communications Equipment Measurement and Performance Standards*.

The following steps outline the procedure used to measure the conducted emissions from the EUT.

1. Determine frequency range for measurements: From CFR 2.1057 the spectrum should be investigated from the lowest radio frequency generated in the equipment up to at least the 10th harmonic of the carrier frequency. For the equipment under test, this equates to a frequency range of 30 MHz to 19.1 GHz, data taken from 30 MHz to 20 GHz.
2. Determine EUT transmit frequencies: below outlines the band edge frequencies pertinent to conducted emissions testing.

Note: --

Test Results for HSDPA mode:

Out of band emission	
Frequency [MHz]	Level (dBm)
--	--

Graphical results for HSDPA mode:

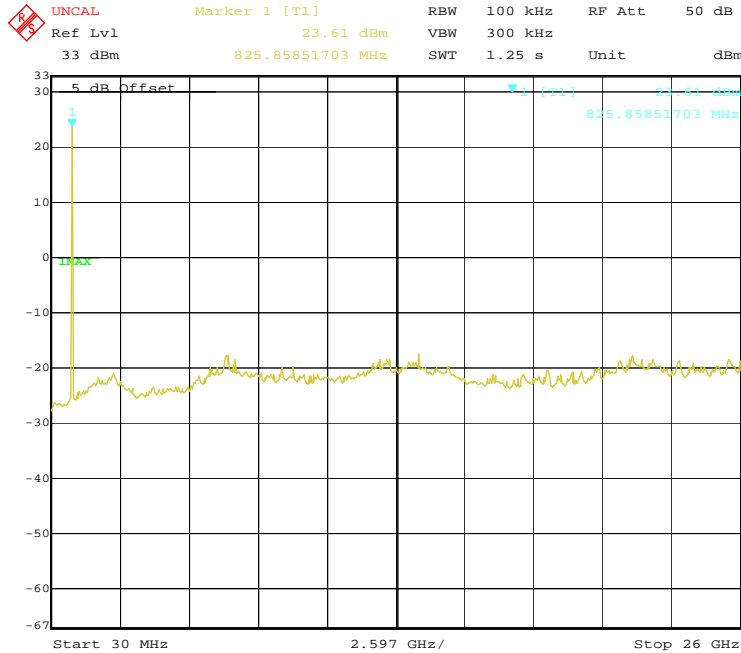

Date: 11.SEP.2009 19:14:21

Channel 4175

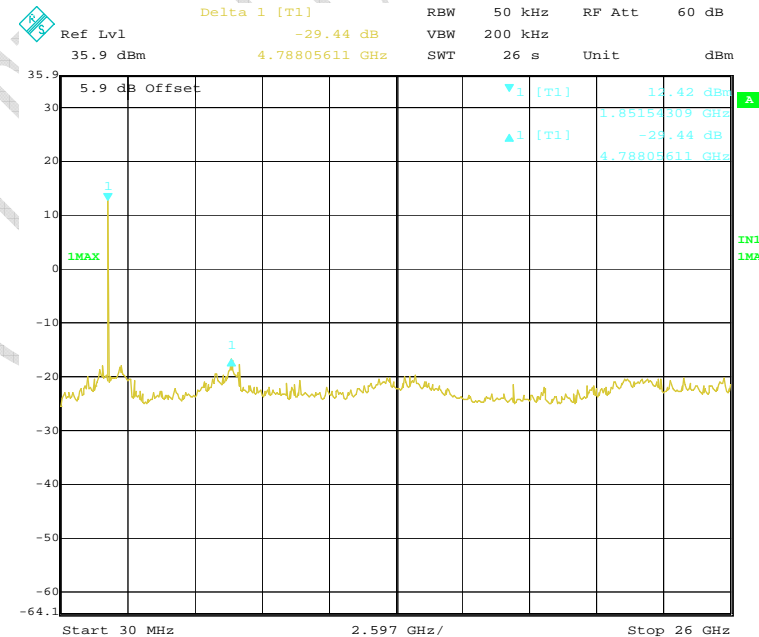

Date: 8.APR.2010 18:38:25

Channel 9400

Test Results for HSUPA mode:

Out of band emission	
Frequency [MHz]	Level (dBm)
--	--

Graphical results for HSDPA mode:

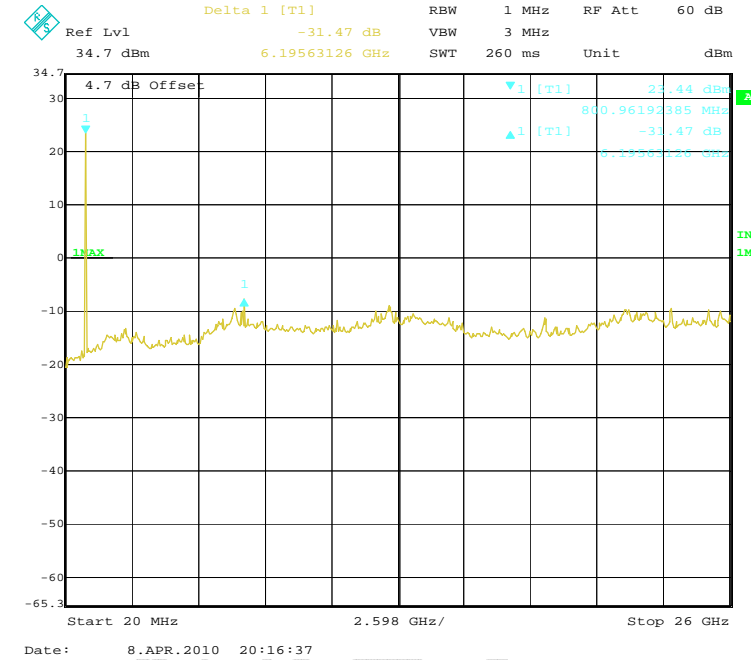

Channel 4175

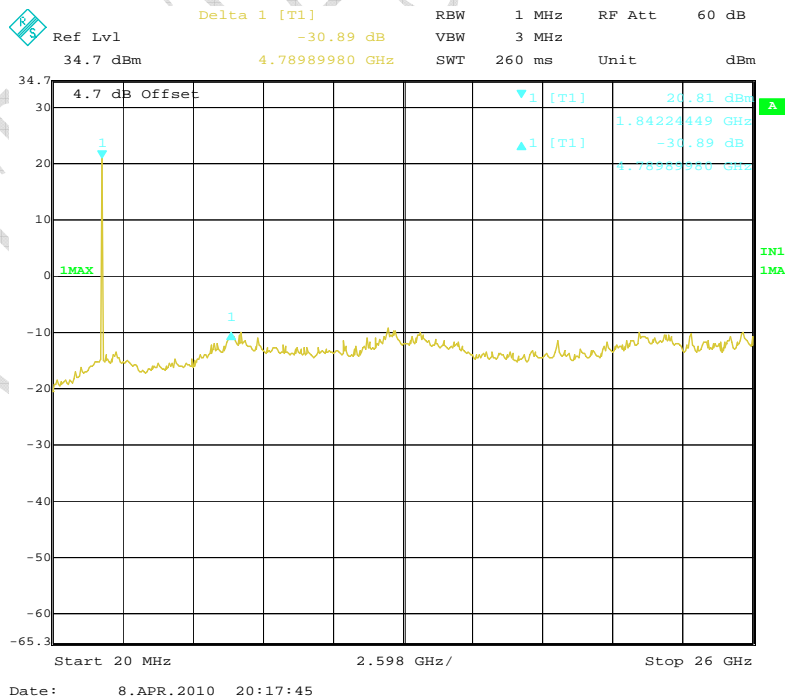

Channel 9400

4.8 Band Edge

Specifications:	2.1051, 24.238, 2.1053, 22.917					
Date of Tests	2010-4-8					
Test conditions:	Ambient Temperature: 15°C-35°C Relative Humidity: 30%-60% Air pressure: 86-106kPa					
Operation Mode	TX on maximum transmitting power level at channel 4132, 4233, 9262 and 9538 for WCDMA					
Test Results:	Pass					
Test equipment Used:						
Asset Number	Description	Manufacturer	Model Number	Serial Number	Cal Due	State
7805	EMI Test Receiver	R/S	ESI26	100211	2011-01-11	Normal
023	Wireless Communications Test Set	Agilent	8960(E5515C)	GB41450323	2010-06-09	Normal
---	Power splitter	Jie sai	---	1000132	2011-01-04	Normal
111835	Wireless Communications Test Set	R&S	CMU200	1100000802	--	Normal

Limit Level Construction:

According to Part 24.238 (a), i.e., Out of band emissions. The power of any emission outside of the authorized operating frequency ranges must be attenuated below the transmitting power (P) by a factor of at least $43 + 10 \log(P)$ dB, so the limit level is:
 $P(\text{dBm}) - (43 + 10 \log(P)) \text{ dB} = -13\text{dBm}$

Limits for Radiated spurious emissions(UE)

Frequency range	Limit Level /Resolution Bandwidth
30 MHz to 20000 MHz	-13dBm/1MHz

Test Setup:

During the process of testing, the EUT was controlled via the Wireless Communications Test Set to ensure max power transmission and proper modulation and measured by Rhode & Schwarz EMI test receiver (ESI26).

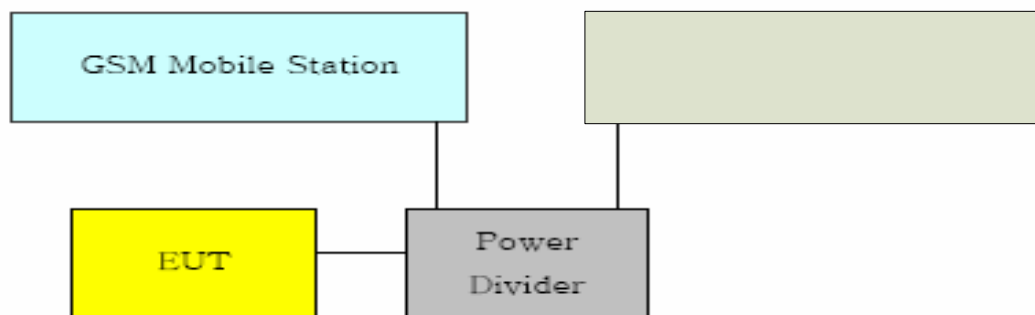

Test Method

- 1) The EUT was coupled to the EMI test receiver analyzer mode and the base station simulator through a power divider. The radio frequency load attached to the EUT antenna terminal was 50 Ohm. The lost of the cables the test system is calibrated to correct the readings.
- 2) The spectrum analyzer was set to Maxpeak Detector function and Maximum hold mode.
- 3) The resolution bandwidth of the spectrum analyzer was comparable to the emission bandwidth.

Note: --

Test Results:

HSDPA mode:

Band-edge emission		
EUT Channel	Frequency [MHz]	Level [dBm]
4132 Left band edge	822.2	-22.40
4233 Right band edge	850.8	-22.42
9262 Left band edge	1848.2	-21.10
9538 Right band edge	1911.8	-20.54

HSUPA mode:

Band-edge emission		
EUT Channel	Frequency [MHz]	Level [dBm]
4132 Left band edge	822.2	-22.90
4233 Right band edge	850.8	-23.03
9262 Left band edge	1848.2	-21.80
9538 Right band edge	1911.8	-21.88

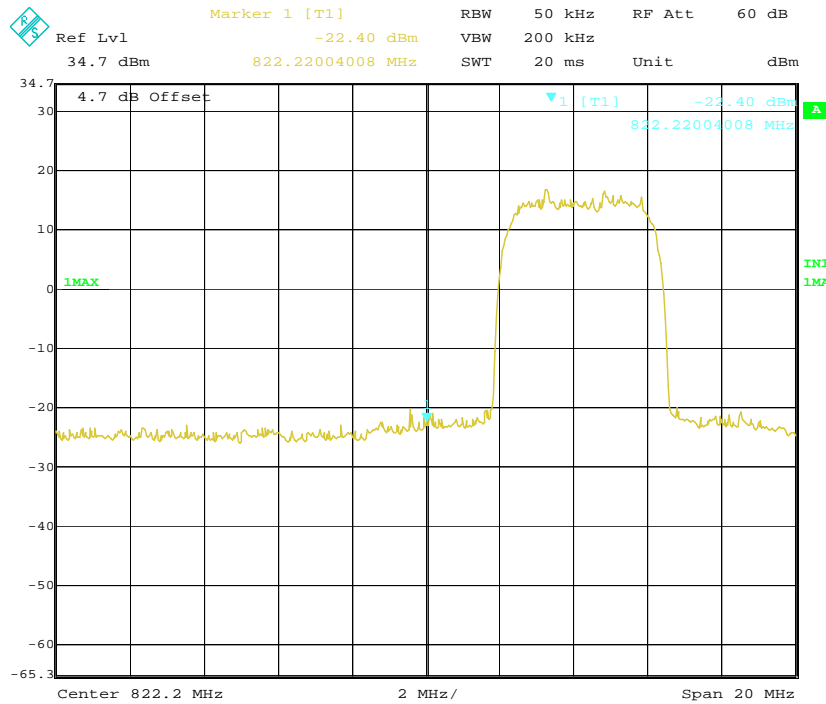

Date: 8.APR.2010 19:59:59

HSDPA channel 4132 left band edge

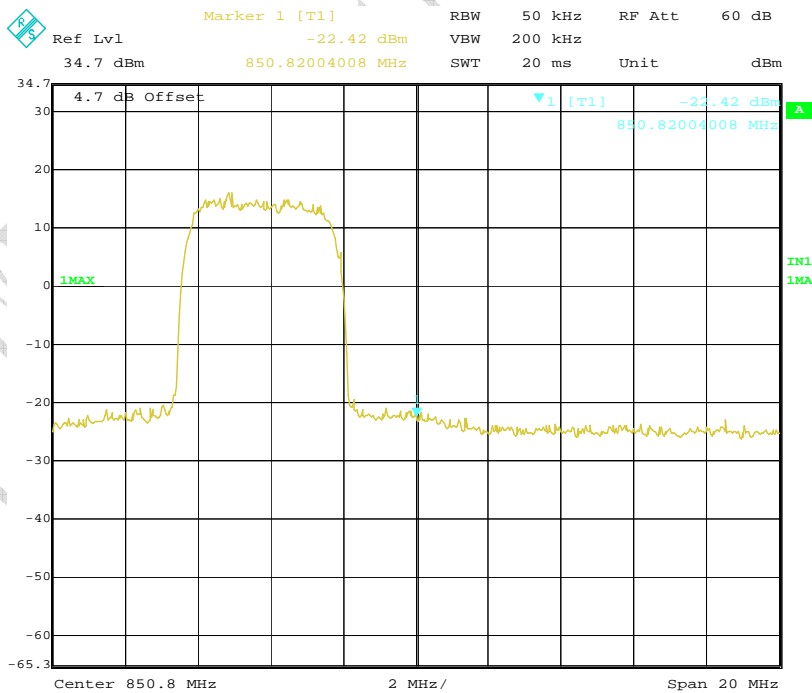

Date: 8.APR.2010 19:52:36

HSDPA channel 4233 right band edge

FCC Parts 2, 22, 24
Equipment: MC8795V

Supplement to Test Report I09GW6944-FCC-EMC-3

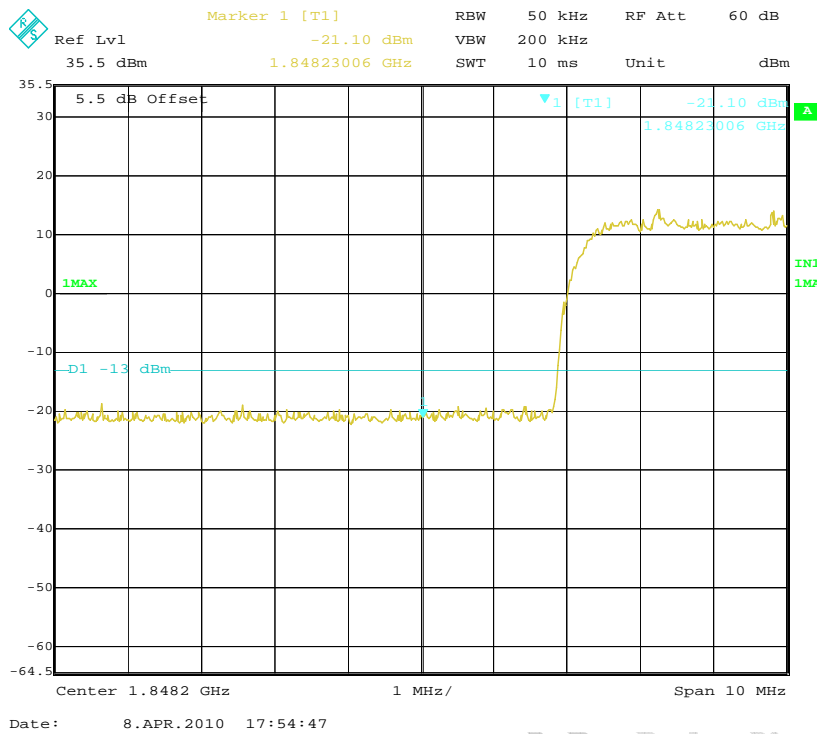

HSDPA channel 9262 left band edge

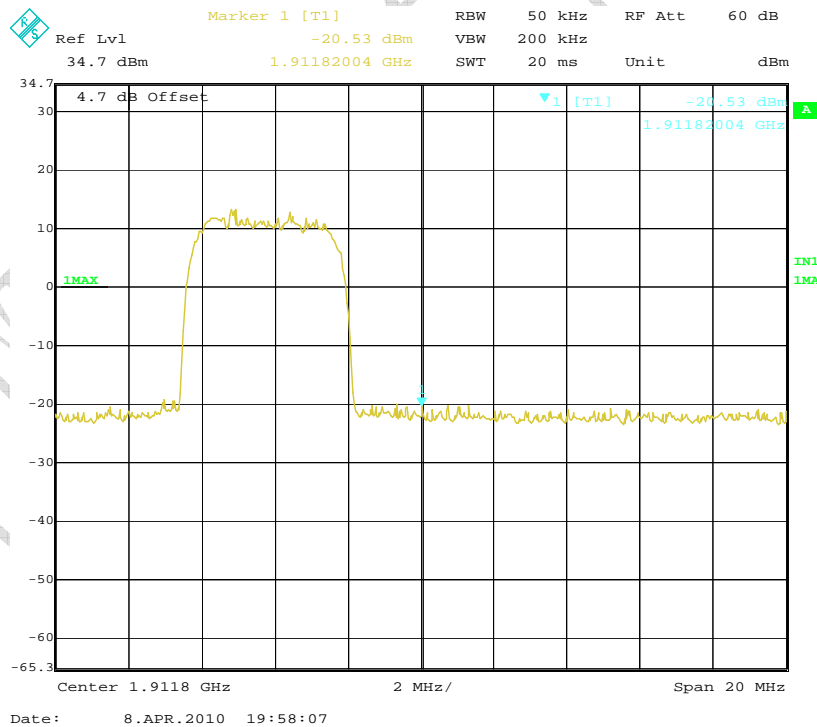

HSDPA channel 9538 right band edge

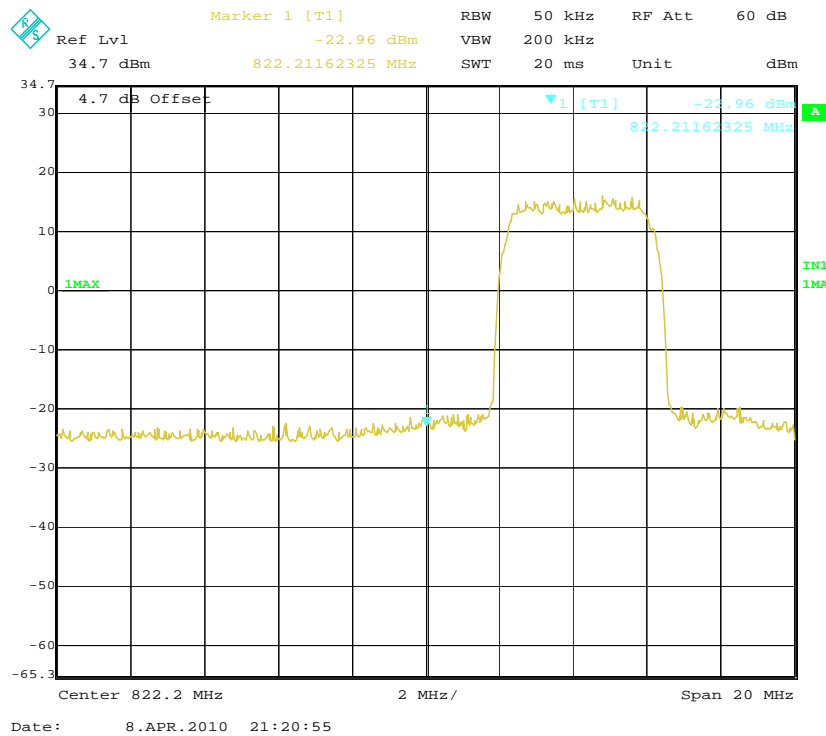

HSUPA channel 4132 left band edge

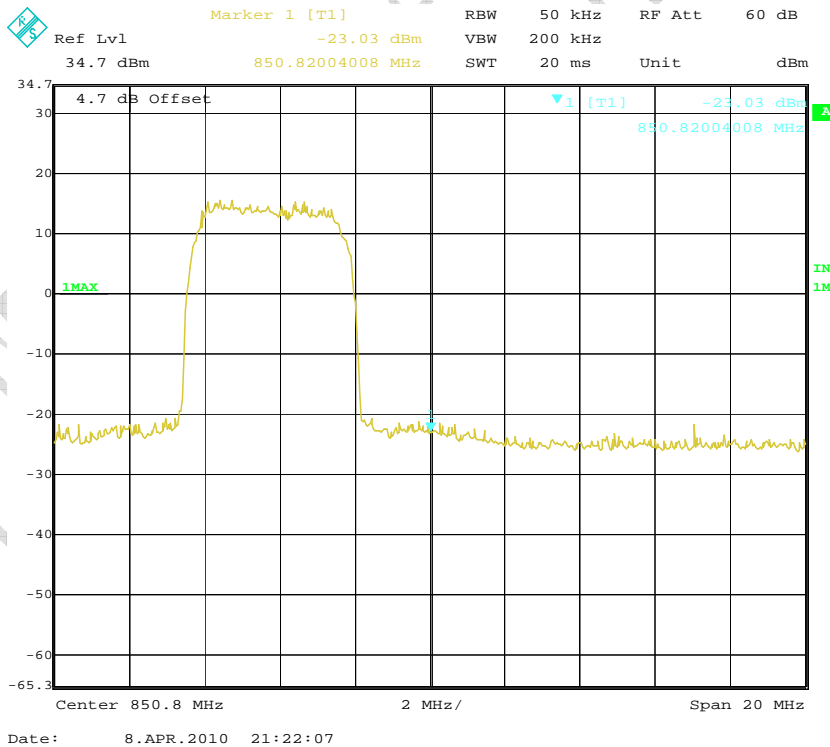

HSUPA channel 4233 right band edge

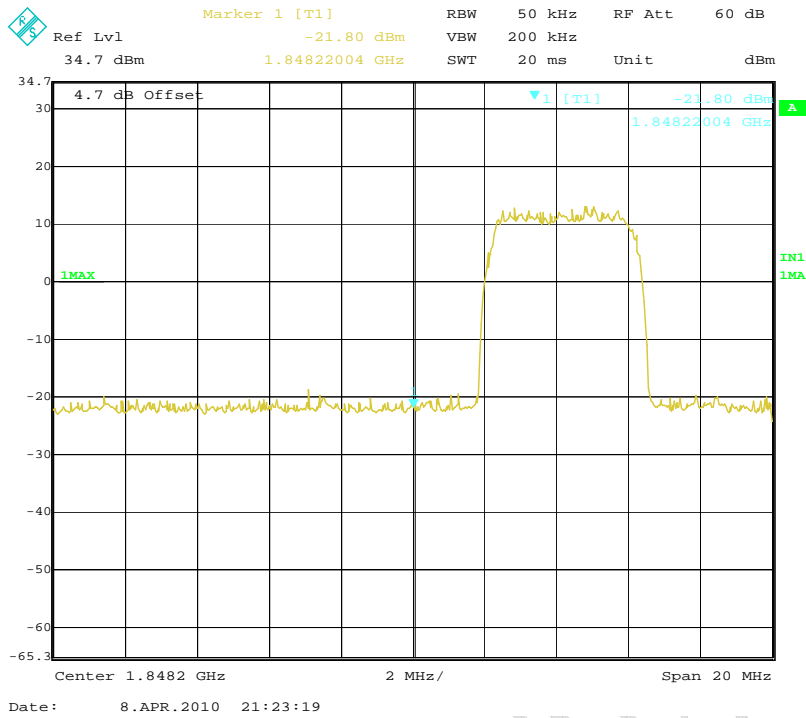

HSUPA channel 9262 left band edge

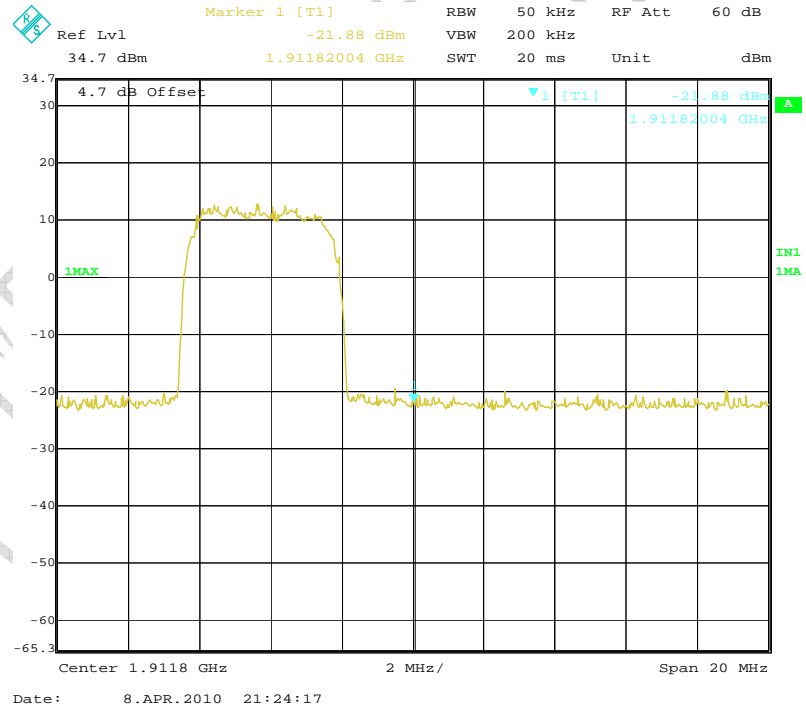

HSUPA channel 9538 right band edge

Annex A External Photos

The EUT is a PCI card. There is no enclosure. So there is no external photo.

TTL Test Report

ANNEX C Deviations from Prescribed Test Methods

No deviation from Prescribed Test Methods.

————— The End of this Report —————

TTL Test Report