

# HAC T-Coil Test Report

**Project Number:** 3719706

**Report Number:** 3719706EMC04

**Revision Level:** 0

**Client:** Intermec Technologies Corporation

**Equipment Under Test:** Mobile Computer

**Model Name:** CN70 / CN70e / CK70

**Model Number:** 1000CP01C-H1 / 1000CP02C-H1 / 1001CP01C-H1

**System Version:** W23.1.6.003

**FCC ID:** EHA-1000CP01CX2

**Applicable Standards:** ANSI C63.19-2011  
FCC Rule Parts: §20.19

**Report issued on:** 29 April 2015

**Test Result:**

Tested by:

  
\_\_\_\_\_  
Fabian Nica, Senior Engineering Technician

Reviewed by:

  
\_\_\_\_\_  
David Schramm, EMC/RF/SAR/HAC Manager

**Remarks:**

This report details the results of the testing carried out on one sample, the results contained in this test report do not relate to other samples of the same product. The manufacturer should ensure that all products in series production are in conformity with the product sample detailed in this report.

This report may only be reproduced and distributed in full. If the product in this report is used in any configuration other than that detailed in the report, the manufacturer must ensure the new system complies with all relevant standards. Any mention of SGS International Electrical Approvals or Testing done by SGS International Electrical Approvals in connection with distribution or use of the product described in this report must be approved by SGS international Electrical Approvals in writing.

## Table of Contents

<b>1</b>	<b>GENERAL INFORMATION</b> .....	<b>3</b>
1.1	CLIENT INFORMATION.....	3
1.2	TEST LABORATORY.....	3
1.3	GENERAL INFORMATION OF EUT.....	3
1.4	EQUIPMENT UNDER TEST .....	4
1.5	TEST RESULTS SUMMARY .....	4
1.6	TEST METHODOLOGY.....	4
<b>2</b>	<b>TEST EQUIPMENT</b> .....	<b>5</b>
2.1	MEASUREMENT UNCERTAINTY .....	6
<b>3</b>	<b>SYSTEM VALIDATION SETUP DIAGRAM</b> .....	<b>7</b>
<b>4</b>	<b>WIRELESS DEVICE POSITIONING</b> .....	<b>8</b>
<b>5</b>	<b>TEST PROCEDURE:</b> .....	<b>9</b>
<b>6</b>	<b>ESTABLISH WD REFERENCE LEVEL</b> .....	<b>11</b>
<b>7</b>	<b>RESULTS</b> .....	<b>12</b>
<b>8</b>	<b>FREQUENCY RESPONSE</b> .....	<b>12</b>
<b>9</b>	<b>SIGNAL TO NOISE</b> .....	<b>13</b>
<b>10</b>	<b>T-COIL TEST PLOTS</b> .....	<b>14</b>
<b>11</b>	<b>SETUP PHOTOGRAPHS</b> .....	<b>22</b>
<b>12</b>	<b>REFERENCES</b> .....	<b>23</b>
<b>13</b>	<b>REVISION HISTORY</b> .....	<b>24</b>

## 1 GENERAL INFORMATION

### 1.1 CLIENT INFORMATION

Name: Intermec Technologies Corp.  
Address: 6001 36<sup>th</sup> Avenue W  
City, State, Zip, Country: Everett, WA 988203, USA

### 1.2 TEST LABORATORY

Name: SGS North America, Inc.  
Address: 620 Old Peachtree Road NW, Suite 100  
City, State, Zip, Country: Suwanee, GA 30024, USA

Accrediting Body: A2LA  
Type of lab: Testing Laboratory  
Certificate Number: 3212.01

### 1.3 GENERAL INFORMATION OF EUT

Mode of Operation: CDMA 1xRTT BC0, BC1  
Frequency Range: CDMA BC0 (824.0-849MHz)  
CDMA BC1 (1850-1910MHz),  
Serial Number: 15621442244  
Build Version: CE OS 5.2.29077 (Build 29077.5.3.12.10)  
Firmware Version: System Version W23.1.6.003  
Antenna: Integral  
Battery Type: Li-Ion Battery  
Rated Voltage: 3.7 VDC, 4Ah, Rechargeable Battery  
Accessories: None

Sample Received Date: 13 April 2015  
Date of testing: 28 April 2015

### 1.4 EQUIPMENT UNDER TEST

<b>EUT</b>	Mobile Computer
<b>Normal operation:</b>	Held to head
<b>Body Worn Accessory</b>	NA
<b>Device category:</b>	Portable
<b>Exposure category:</b>	General Population/Uncontrolled Exposure
<b>Sample Modification:</b>	No modifications made. There is no power reduction for HAC support.
<b>Volume Level during test:</b>	Maximum setting and with microphone muted

Air Interface	Band MHz	Type	C63.19 Tested	Simultaneous Transmission	OTT	Power Reduction
CDMA	800	VO	Yes	BT/WiFi	NA	NA
	1900					
WiFi	2450	VD <sup>1</sup>	No	BT, GSM, WCDMA, CDMA	Yes	NA
BT	2450	DT	NA	WiFi, GSM, WCDMA, CDMA	NA	NA

VO = CMRS Voice Service  
DT = Digital Transport  
VD = CMRS IP Voice and Digital Transport  
1 = No associated T-Coil measurement has been made in accordance with 285076 D02 T-Coil testing for CMRS IP

### 1.5 TEST RESULTS SUMMARY

Mode	Ch. No/Freq. MHz	Probe orientation	ABM1 dBA/m	BWC Factor dB	ABM SNR dB	T-Rating
CDMA BC0	384 / 836.52MHz	z (Axial)	-12.05	0.15	38.69	T4
		y (Transversal)	-14.96	0.15	36.66	T4
CDMA BC1	600 / 1880MHz	z (Axial)	-4.86	0.15	32.96	T4
		y (Transversal)	-13.73	0.15	34.69	T4

### 1.6 TEST METHODOLOGY

Testing was performed in accordance with the ANSI C63.19-2011 methods of measurement of compatibility between a wireless device and hearing aids. FCC published KDB 285076 D01 HAC Guidance v03r02 were followed.

## 2 TEST EQUIPMENT

Equipment	Model	Manufacturer	Asset Number	Cal Due Date
CMW500 WIDEBAND RADIO	CMW500	ROHDE & SCHWARZ	B094874	6-Dec-2015

Equipment	Model	Manufacturer	Serial Number	Cal Due Date
Dasy5 Controller	SP1D	Stäubli	S-1188	NA
Probe Alignment Light Beam	LB5/80	SPEAG	SEUKS030A A	NA
Data Acquisition Electronics	DAE4	SPEAG	1287	20-Jan-2018
Device Holder	HAC Test Arch	SPEAG	1163	NA
PC	Compaq 8000 Elite	HP	CZC1231RW S	NA
Audio Magnetic Measurement Instrument	AMMI	SPEAG	1139	NA
ABM Probe	AM1DV3	SPEAG	3099	22-Jan-2018
Helmholz Coil	AMCC	SPEAG	1119	NA

## 2.1 MEASUREMENT UNCERTAINTY

<b>Uncertainty of Audio Band Magnetic Measurements</b>							
Error Description	Unc. Value	Prob. Dist.	Div.	( $c_i$ ) ABM1	( $c_i$ ) ABM2	Std. Unc. ABM1	Std. Unc. ABM2
<b>Probe Sensitivity</b>							
Reference Level	±3.0 %	N	1	1	1	±3.0 %	±3.0 %
AMCC Geometry	±0.4 %	R	$\sqrt{3}$	1	1	±0.2 %	±0.2 %
AMCC Current	±1.0 %	R	$\sqrt{3}$	1	1	±0.6 %	±0.6 %
Probe Positioning during Calibr.	±0.1 %	R	$\sqrt{3}$	1	1	±0.1 %	±0.1 %
Noise Contribution	±0.7 %	R	$\sqrt{3}$	0.0143	1	±0.0 %	±0.4 %
Frequency Slope	±5.9 %	R	$\sqrt{3}$	0.1	1.0	±0.3 %	±3.5 %
<b>Probe System</b>							
Repeatability / Drift	±1.0 %	R	$\sqrt{3}$	1	1	±0.6 %	±0.6 %
Linearity / Dynamic Range	±0.6 %	R	$\sqrt{3}$	1	1	±0.4 %	±0.4 %
Acoustic Noise	±1.0 %	R	$\sqrt{3}$	0.1	1	±0.1 %	±0.6 %
Probe Angle	±2.3 %	R	$\sqrt{3}$	1	1	±1.4 %	±1.4 %
Spectral Processing	±0.9 %	R	$\sqrt{3}$	1	1	±0.5 %	±0.5 %
Integration Time	±0.6 %	N	1	1	5	±0.6 %	±3.0 %
Field Disturbance	±0.2 %	R	$\sqrt{3}$	1	1	±0.1 %	±0.1 %
<b>Test Signal</b>							
Ref. Signal Spectral Response	±0.6 %	R	$\sqrt{3}$	0	1	±0.0 %	±0.4 %
<b>Positioning</b>							
Probe Positioning	±1.9 %	R	$\sqrt{3}$	1	1	±1.1 %	±1.1 %
Phantom Thickness	±0.9 %	R	$\sqrt{3}$	1	1	±0.5 %	±0.5 %
DUT Positioning	±1.9 %	R	$\sqrt{3}$	1	1	±1.1 %	±1.1 %
<b>External Contributions</b>							
RF Interference	±0.0 %	R	$\sqrt{3}$	1	0.3	±0.0 %	±0.0 %
Test Signal Variation	±2.0 %	R	$\sqrt{3}$	1	1	±1.2 %	±1.2 %
<b>Combined Uncertainty</b>							
Combined Std. Uncertainty (ABM Field)						±4.1 %	±6.1 %
<b>Expanded Std. Uncertainty</b>						<b>±8.1 %</b>	<b>±12.3 %</b>

Table 25.1: Uncertainty of audio band magnetic measurements.

### 3 SYSTEM VALIDATION SETUP DIAGRAM

SPEAG user manual 20 May 2014:

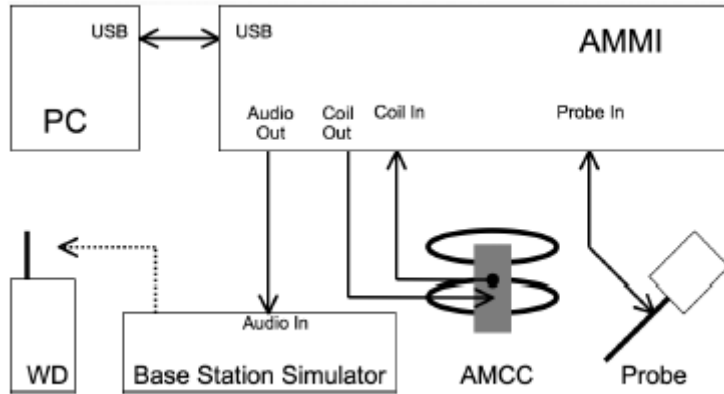

## 4 WIRELESS DEVICE POSITIONING

- Area 5 x 5 cm with 9 subgrids
- Parallel to speaker area
- 15 / 10 mm distance
- Centered to acoustic output

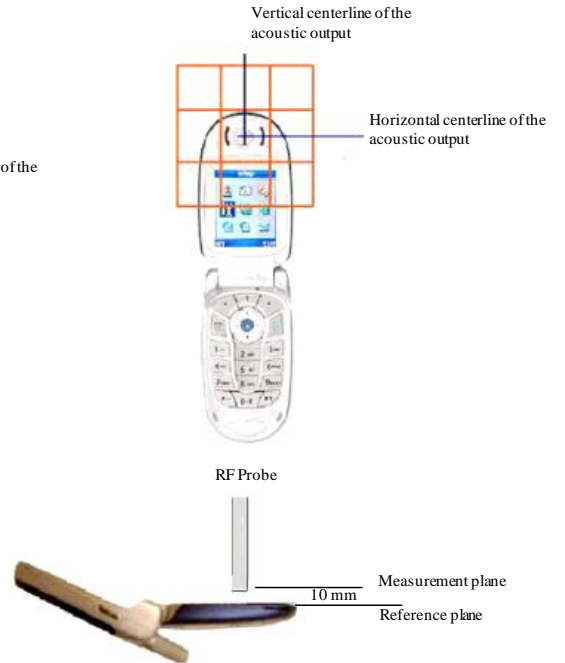



## 5 TEST PROCEDURE:

ANSI C63.19-2011  
American National Standard Methods of Measurement of Compatibility between  
Wireless Communication Devices and Hearing Aids

Measurements shall not include undesired properties from the WD's RF field; therefore, use of a coaxial connection to a base station simulator or nonradiating load might be necessary. However, even with a coaxial connection to a base station simulator or nonradiating load, there might still be RF leakage from the WD, which can interfere with the desired measurement. Premeasurement checks should be made to avoid this possibility. All measurements shall be performed with the WD operating on battery power with an appropriate normal speech audio signal input level given in Table 7.1. If the device display can be turned off during a phone call, then that may be done during the measurement as well, but this should be documented in the test report.

Measurements shall be performed at two locations specified in A.3, with the correct probe orientation for a particular location, in a multistage sequence by first measuring the field intensity of the desired T-Coil signal (ABM1) that is useful to a hearing aid T-Coil. The undesired magnetic components (ABM2) shall be examined for each probe orientation to determine the possible effects from the WD display and battery current paths that might disrupt the desired T-Coil signal. The undesired magnetic signal (ABM2) must be measured at the same location as the desired ABM or T-Coil signal (ABM1), and the ratio of desired to undesired ABM signals must be calculated. For the perpendicular field location, only the ABM1 frequency response shall be determined in a third measurement stage. The flowchart in Figure 7.3 illustrates this three-stage, two-orientation process.

The following steps summarize the basic test flow for determining ABM1 and ABM2. These steps assume that a sine-wave or narrowband 1/3 octave signal can be used for the measurement of ABM1. An alternative procedure yielding equivalent results utilizing a broadband excitation is specified in 7.5.

- a) A validation of the test setup and instrumentation may be performed using a TMFS or Helmholtz coil. Measure the emissions and confirm that they are within the specified tolerance.
- b) Position the WD in the test setup and connect the WD RF connector to a base station simulator or a nonradiating load as shown in Figure 7.1 or Figure 7.2. Confirm that the equipment that requires calibration has been calibrated and that the noise level meets the requirements of 7.3.1.
- c) The drive level to the WD is set such that the reference input level specified in Table 7.1 is input to the base station simulator (or manufacturer's test mode equivalent) in the 1 kHz, 1/3 octave band. This drive level shall be used for the T-Coil signal test (ABM1) at  $f = 1$  kHz. Either a sine wave at 1025 Hz or a voice-like signal, band-limited to the 1 kHz 1/3 octave, as defined in 7.4.2, shall be used for the reference audio signal. If interference is found at 1025 Hz, an alternative nearby reference audio signal frequency may be used.<sup>47</sup> The same drive level shall be used for the ABM1 frequency response measurements at each 1/3 octave band center frequency. The WD volume control may be set at any level up to maximum, provided that a signal at any frequency at maximum modulation would not result in clipping or signal overload.

- d) Determine the magnetic measurement locations for the WD device (A.3), if not already specified by the manufacturer, as described in 7.4.4.1.1 and 7.4.4.2.
- e) At each measurement location, measure and record the desired T-Coil magnetic signals (ABM1 at  $f_i$ ) as specified in 7.4.4.2 in each ISO 266-1975 R10 standard 1/3 octave band. The desired audio band input frequency ( $f_i$ ) shall be centered in each 1/3 octave band maintaining the same drive level as determined in item c) and the reading taken for that band.<sup>48</sup>

Equivalent methods of determining the frequency response may also be employed, such as fast Fourier transform (FFT) analysis using noise excitation or input-output comparison using simulated speech. The full-band integrated or half-band integrated probe output, as specified in D.9, may be used, as long as the appropriate calibration curve is applied to the measured result, so as to yield an accurate measurement of the field magnitude. (The resulting measurement shall be an accurate measurement in dB A/m.)

All measurements of the desired signal shall be shown to be of the desired signal and not of an undesired signal. This may be shown by turning the desired signal ON and OFF with the probe measuring the same location. If the scanning method is used, the scans shall show that all measurement points selected for the ABM1 measurement meet the ambient and test system noise criteria in 7.3.1.

- f) At the measurement location for each orientation, measure and record the undesired broadband audio magnetic signal (ABM2) as specified in 7.4.4.4 with no audio signal applied (or digital zero applied, if appropriate) using A-weighting<sup>49</sup> and the half-band integrator. Calculate the ratio of the desired to undesired signal strength (i.e., signal quality).
- g) Determine the category that properly classifies the signal quality, based on Table 8.5.

## 6 ESTABLISH WD REFERENCE LEVEL

- Find Uref which is 1 kHz signal output to base station.
- Measure Uref then measure U which is the signal from AMMI to base station.
- Connect Coil In of the AMMI to the Audio of the base station.
- Establish a conducted link between EUT and base station.
- Once link is established, change the bitstream setting to decoded cal in order for base station to produce the 1 kHz signal.
- Record reported value from Dasy and use this a Uref value.

Setup Diagram

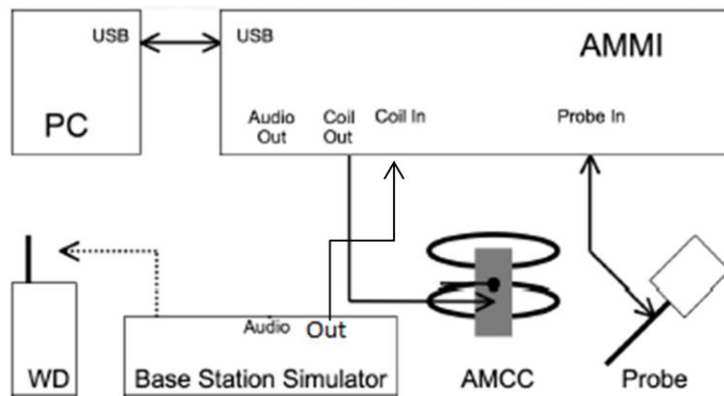

Measure U, which is the signal from AMMI to base station during testing. U for narrow band (Voice 1.025 kHz) and broad band (300 Hz – 300 kHz)

- Determine Dasy gain setting to achieve proper EUT signal level
- Connect Coil In of AMMI to Audio Out of AMMI.
- Run the narrow band job and record RMS coil signal. Adjust the gain by changing the gain value in Dasy job unit the coil signal reading reaches desired output signal level.
- Repeat above step for broad band job

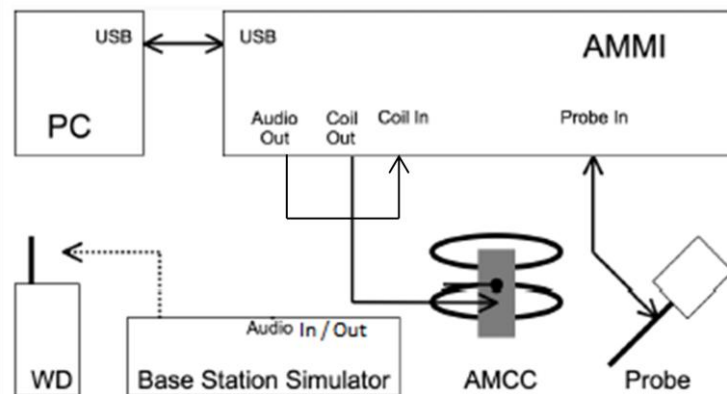

## 7 RESULTS

CDMA2000	Applied Signal	RMS V	Result Input Level (dBm0)	Reference Input Level (dBm0)		Adjusted Gain Setting	RMS dB V
				CDMA	-18		
1 kHz Voice Signal	U	0.098	-18.0	CDMA	-18	29.37	-20.17
	Uref	0.779					-2.17
300Hz-3kHz Voice Signal	U	0.099	-18.0	CDMA	-18	57.53	-20.13
	Uref	0.779					-2.17

## 8 FREQUENCY RESPONSE

The frequency response of the perpendicular component of the magnetic field, measured in 1/3 octave bands, shall follow the response curve specified in this subclause, over the frequency range 300 Hz to 3000 Hz.

Figure 8.1 and Figure 8.2 provide the boundaries as a function of frequency. These response curves are for true field-strength measurements of the T-Coil signal. Thus, the 6 dB/octave probe response has been corrected from the raw readings.

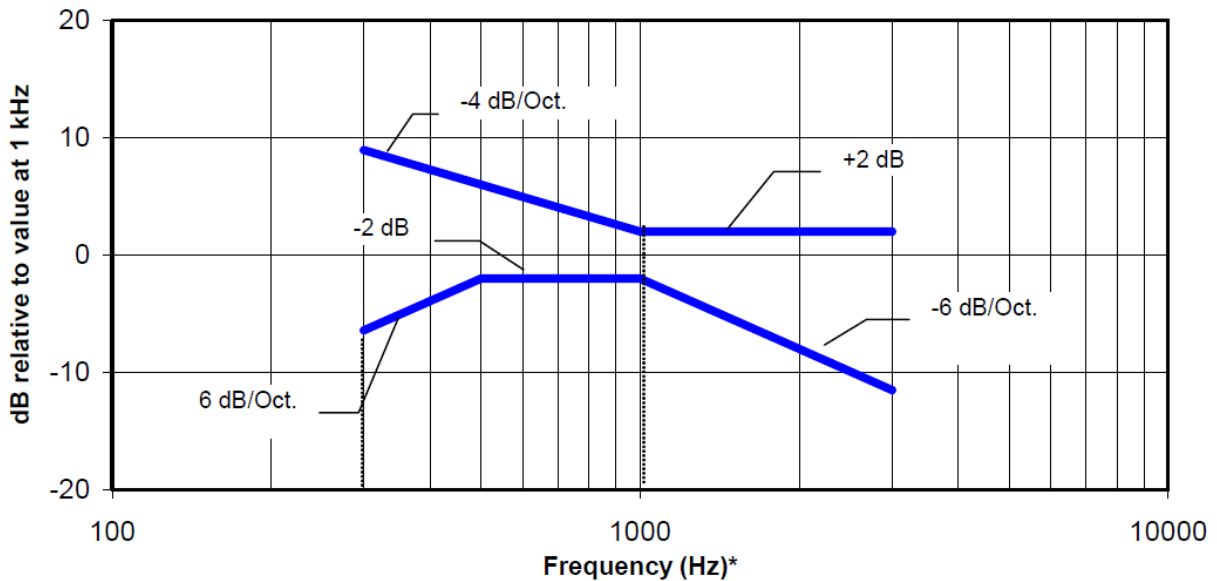

NOTE—The frequency response is between 300 Hz and 3000 Hz.

**Figure 8.1—Magnetic field frequency response for WDs with field strength  $\leq -15$  dB (A/m) at 1 kHz**

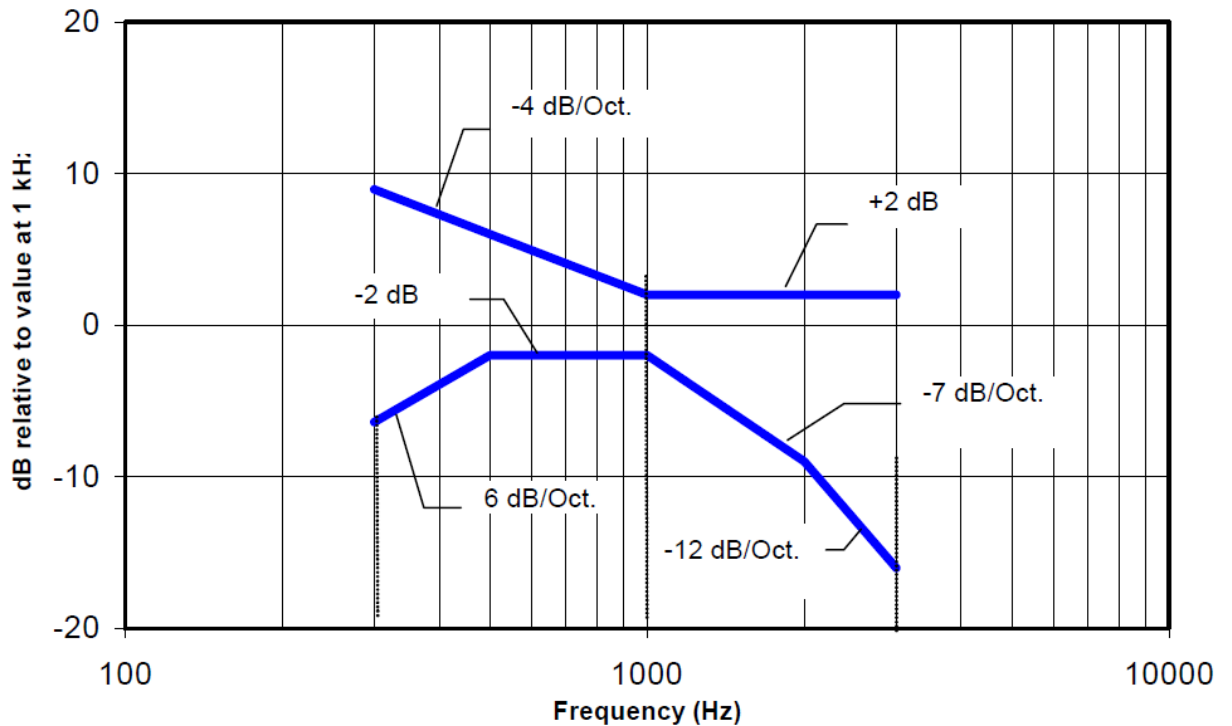

NOTE—The frequency response is between 300 Hz and 3000 Hz.

**Figure 8.2—Magnetic field frequency response for WDs with a field that exceeds  $-15 \text{ dB(A/m)}$  at 1 kHz**

## 9 SIGNAL TO NOISE

Only the RF immunity of the hearing aid is measured in T-Coil mode. It is assumed that a hearing aid can have no immunity to an interference signal in the audio band, which is the intended reception band for this mode. So, the only criterion that can be measured is the RF immunity in T-Coil mode. This is measured using the same procedure as for the audio coupling mode and at the same levels as specified in 6.4.

**Table 8.5—T-Coil signal-to-noise categories**

Category	Telephone parameters WD signal quality [(signal + noise)-to-noise ratio in decibels]
Category T1	0 dB to 10 dB
Category T2	10 dB to 20 dB
Category T3	20 dB to 30 dB
Category T4	>30 dB

## 10 T-COIL TEST PLOTS

CDMA BC 0

**DUT: Intermec CN70e; Type: Handheld PC; Serial: NA**

Communication System: UID 10039 - CAB, CDMA2000 BC 0; Communication System Band: Band Class 0 (815.0 - 849.0 MHz); Frequency: 836.52 MHz; Communication System PAR: 4.57 dB; PMF: 1.03157

Medium parameters used:  $\sigma = 0$  S/m,  $\epsilon_r = 1$ ;  $\rho = 1$  kg/m<sup>3</sup>

Phantom section: TCoil Section

Measurement Standard: DASYS (IEEE/IEC/ANSI C63.19-2011)

DASY Configuration:

- Probe: AM1DV3 - 3099; ; Calibrated: 1/22/2015
- Sensor-Surface: 0mm (Fix Surface), z = 3.0
- Electronics: DAE4 Sn1287; Calibrated: 1/20/2015
- Phantom: HAC Test Arch with AMCC; Type: SD HAC P01 BA; Serial: 1163
- DASYS 52.8.8(1222); SEMCAD X 14.6.10(7331)

**T-Coil scan (scan for ANSI C63.19-2011 compliance)/General Scans/z (axial) 4.2mm 50 x 50/ABM Interpolated SNR(x,y,z) (121x121x1):** Interpolated grid: dx=1.000 mm, dy=1.000 mm

Signal Type: Audio File (.wav) 48k\_voice\_1kHz\_1s.wav

Output Gain: 29.37

Measure Window Start: 300ms

Measure Window Length: 1000ms

BWC applied: 0.15 dB

Device Reference Point: 0, 0, -6.3 mm

Category	Telephone parameters WD signal quality [(signal+noise)-to-noise ratio in decibels]
Category T1	0 dB to 10 dB
Category T2	10 dB to 20 dB
Category T3	20 dB to 30 dB
Category T4	> 30 dB



**Cursor:**

ABM1/ABM2 = 38.69 dB  
 ABM1 comp = -12.05 dBA/m  
 BWC Factor = 0.15 dB  
 Location: -7.9, 0, 3.7 mm

**T-Coil scan (scan for ANSI C63.19-2011 compliance)/General Scans/y (transversal)**

**4.2mm 50 x 50/ABM Interpolated SNR(x,y,z) (121x121x1):** Interpolated grid: dx=1.000 mm, dy=1.000 mm

Signal Type: Audio File (.wav) 48k\_voice\_1kHz\_1s.wav

Output Gain: 29.37

Measure Window Start: 300ms

Measure Window Length: 1000ms

BWC applied: 0.15 dB

Device Reference Point: 0, 0, -6.3 mm

Category	Telephone parameters WD signal quality [(signal+noise)-to-noise ratio in decibels]
Category T1	0 dB to 10 dB
Category T2	10 dB to 20 dB
Category T3	20 dB to 30 dB
Category T4	> 30 dB

**Cursor:**

ABM1/ABM2 = 36.66 dB  
 ABM1 comp = -14.96 dBA/m  
 BWC Factor = 0.15 dB  
 Location: -0.8, 10.8, 3.7 mm

**T-Coil scan (scan for ANSI C63.19-2011 compliance)/General Scans/z (axial) wideband at best S/N/ABM Freq Resp(x,y,z,f) (1x1x1):** Measurement grid: dx=10mm, dy=10mm

Signal Type: Audio File (.wav) 48k\_voice\_300-3000\_2s.wav

Output Gain: 57.53

Measure Window Start: 300ms

Measure Window Length: 2000ms

BWC applied: 10.80 dB

Device Reference Point: 0, 0, -6.3 mm

Category	Telephone parameters WD signal quality [(signal+noise)-to-noise ratio in decibels]
Category T1	0 dB to 10 dB
Category T2	10 dB to 20 dB
Category T3	20 dB to 30 dB
Category T4	> 30 dB

**Cursor:**

Diff = 0.57 dB

BWC Factor = 10.80 dB

Location: -7.8, 0.2, 3.7 mm

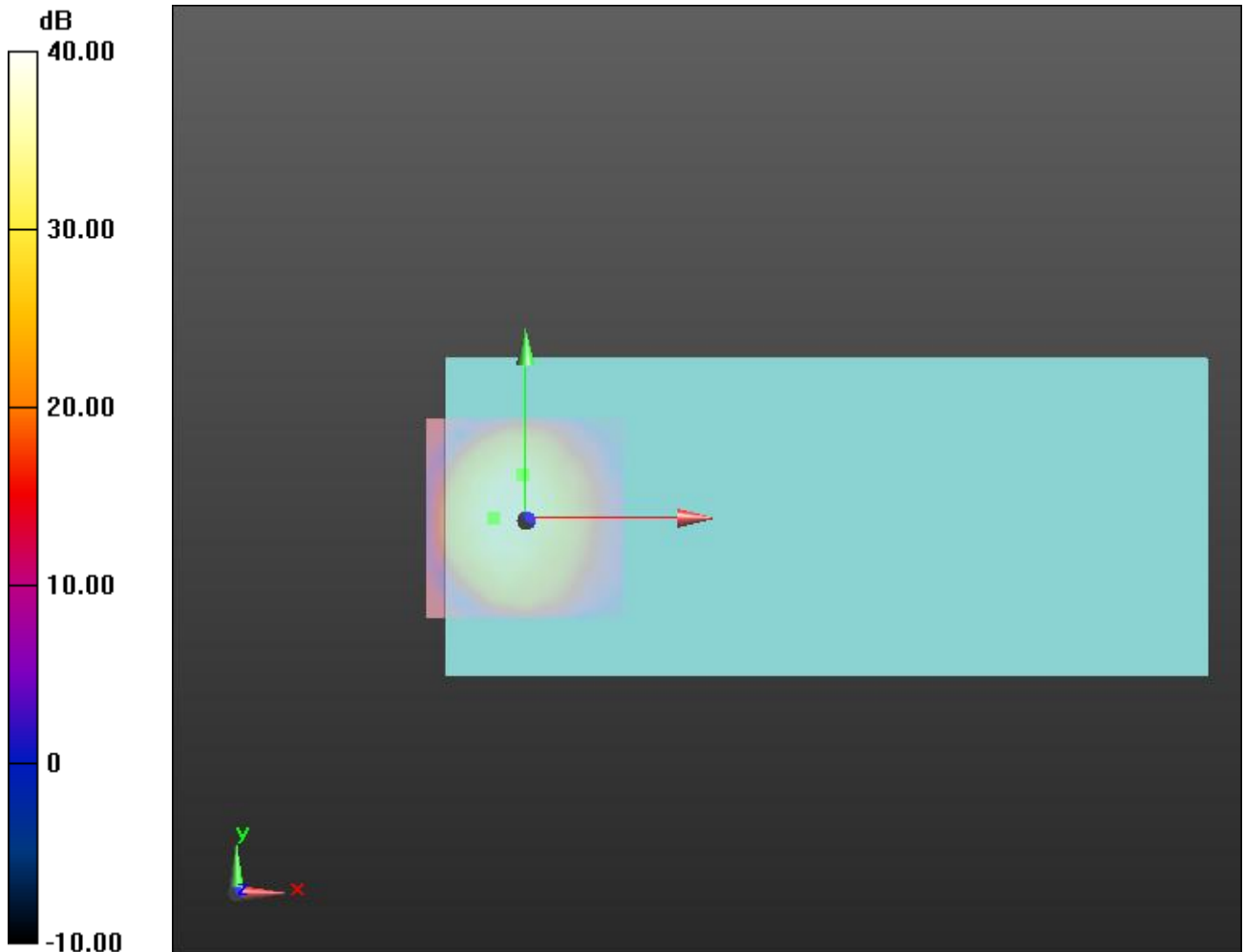

0 dB = 1.000 = 0.00 dB



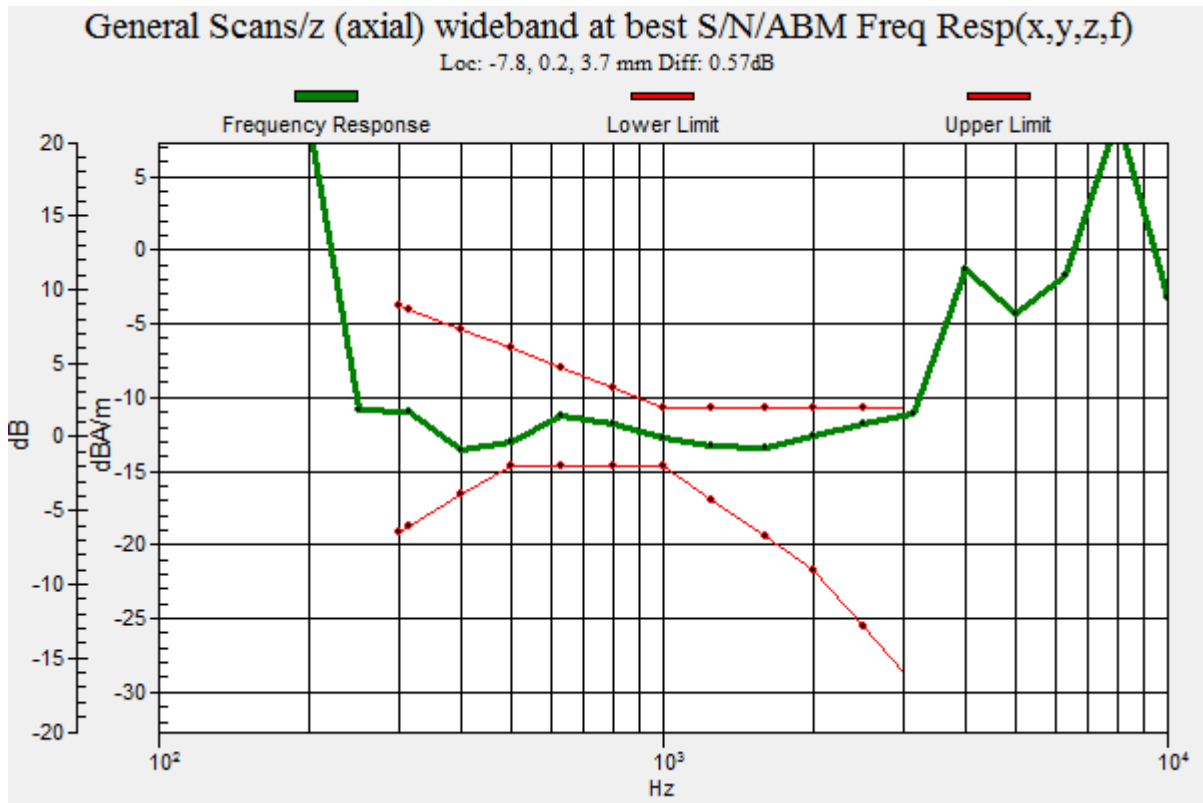

CDMA BC 1

**DUT: Intermec CN70e; Type: Handheld PC; Serial: NA**

Communication System: UID 10039 - CAB, CDMA2000 (1xRTT, RC1); Communication System Band: Band Class 1 (1850.0 - 1910.0 MHz); Frequency: 1880 MHz; Communication System PAR: 4.57 dB; PMF: 1.03157

Medium parameters used:  $\sigma = 0$  S/m,  $\epsilon_r = 1$ ;  $\rho = 1$  kg/m<sup>3</sup>

Phantom section: TCoil Section

Measurement Standard: DASYS (IEEE/IEC/ANSI C63.19-2011)

DASY Configuration:

- Probe: AM1DV3 - 3099; ; Calibrated: 1/22/2015
- Sensor-Surface: 0mm (Fix Surface), z = 3.0
- Electronics: DAE4 Sn1287; Calibrated: 1/20/2015
- Phantom: HAC Test Arch with AMCC; Type: SD HAC P01 BA; Serial: 1163
- DASYS 52.8.8(1222); SEMCAD X 14.6.10(7331)

**T-Coil scan (scan for ANSI C63.19-2011 compliance)/General Scans/z (axial) 4.2mm 50 x 50/ABM Interpolated SNR(x,y,z) (121x121x1):** Interpolated grid: dx=1.000 mm, dy=1.000 mm

Signal Type: Audio File (.wav) 48k\_voice\_1kHz\_1s.wav

Output Gain: 29.37

Measure Window Start: 300ms

Measure Window Length: 1000ms

BWC applied: 0.15 dB

Device Reference Point: 0, 0, -6.3 mm

Category	Telephone parameters WD signal quality [(signal+noise)-to-noise ratio in decibels]
Category T1	0 dB to 10 dB
Category T2	10 dB to 20 dB
Category T3	20 dB to 30 dB
Category T4	> 30 dB

**Cursor:**

ABM1/ABM2 = 32.96 dB  
 ABM1 comp = -4.86 dBA/m  
 BWC Factor = 0.15 dB  
 Location: 1.7, 1.2, 3.7 mm

**T-Coil scan (scan for ANSI C63.19-2011 compliance)/General Scans/y (transversal)**

**4.2mm 50 x 50/ABM Interpolated SNR(x,y,z) (121x121x1):** Interpolated grid: dx=1.000 mm, dy=1.000 mm

Signal Type: Audio File (.wav) 48k\_voice\_1kHz\_1s.wav

Output Gain: 29.37

Measure Window Start: 300ms

Measure Window Length: 1000ms

BWC applied: 0.15 dB

Device Reference Point: 0, 0, -6.3 mm

Category	Telephone parameters WD signal quality [(signal+noise)-to-noise ratio in decibels]
Category T1	0 dB to 10 dB
Category T2	10 dB to 20 dB
Category T3	20 dB to 30 dB
Category T4	> 30 dB

**Cursor:**

ABM1/ABM2 = 34.69 dB  
 ABM1 comp = -13.73 dBA/m  
 BWC Factor = 0.15 dB  
 Location: 0, 8.7, 3.7 mm

**T-Coil scan (scan for ANSI C63.19-2011 compliance)/General Scans/z (axial) wideband at best S/N/ABM Freq Resp(x,y,z,f) (1x1x1):** Measurement grid: dx=10mm, dy=10mm

Signal Type: Audio File (.wav) 48k\_voice\_300-3000\_2s.wav

Output Gain: 57.53

Measure Window Start: 300ms

Measure Window Length: 2000ms

BWC applied: 10.80 dB

Device Reference Point: 0, 0, -6.3 mm

Category	Telephone parameters WD signal quality [(signal+noise)-to-noise ratio in decibels]
Category T1	0 dB to 10 dB
Category T2	10 dB to 20 dB
Category T3	20 dB to 30 dB
Category T4	> 30 dB

**Cursor:**

Diff = 0.58 dB

BWC Factor = 10.80 dB

Location: 1.4, 1.1, 3.7 mm

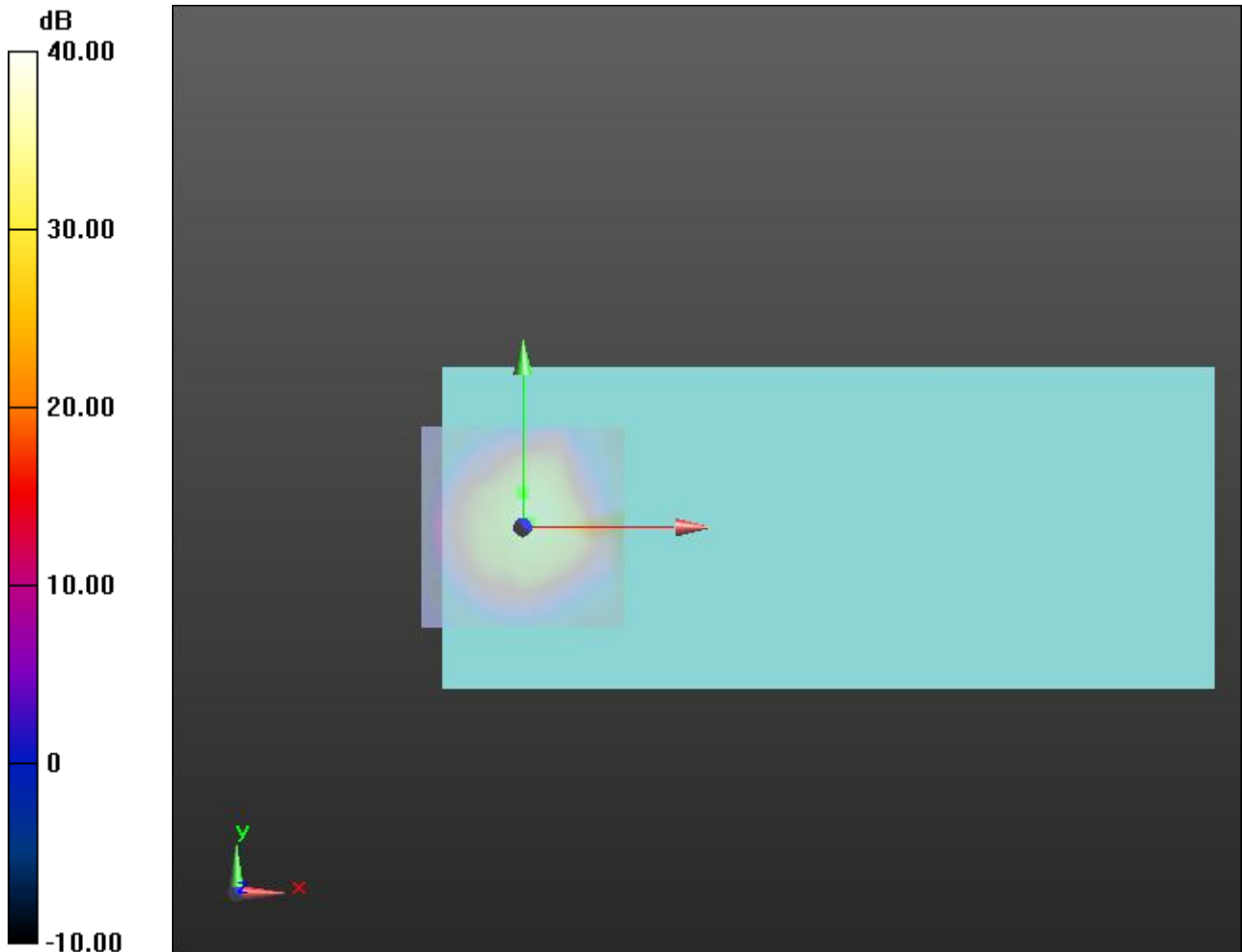

0 dB = 1.000 = 0.00 dB

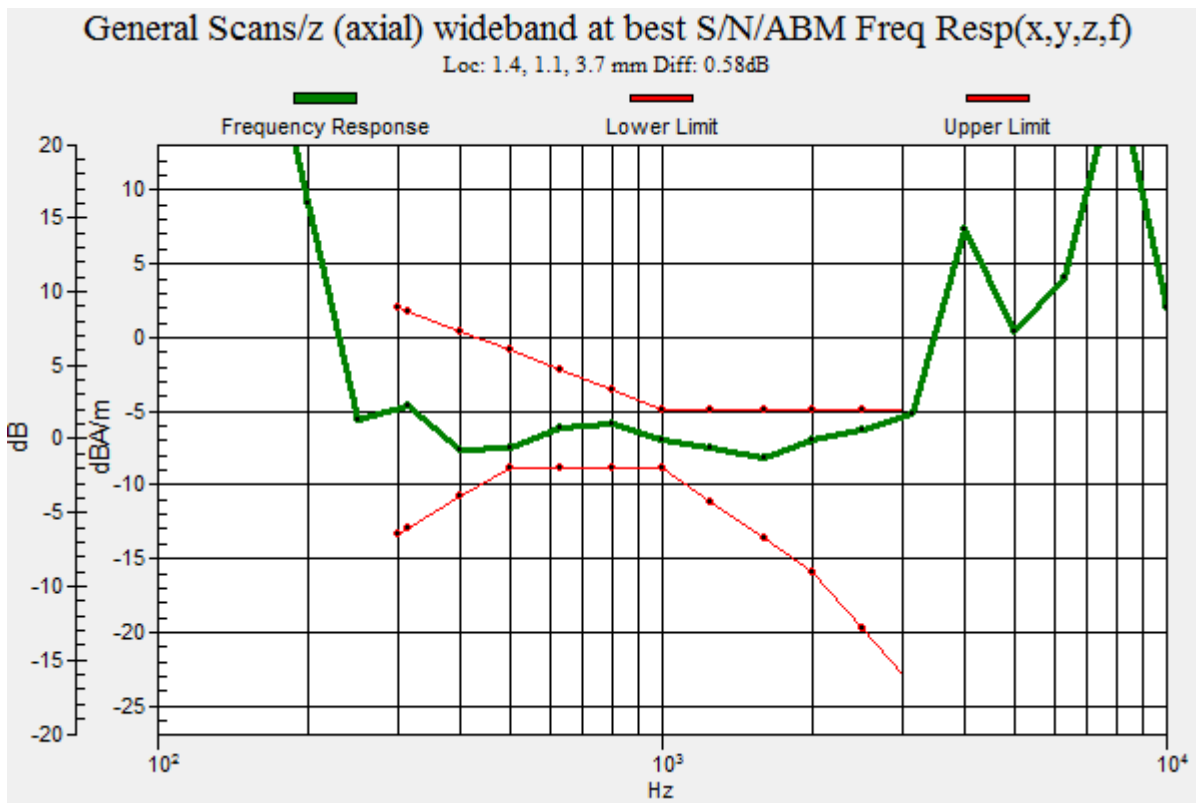

### 11 SETUP PHOTOGRAPHS

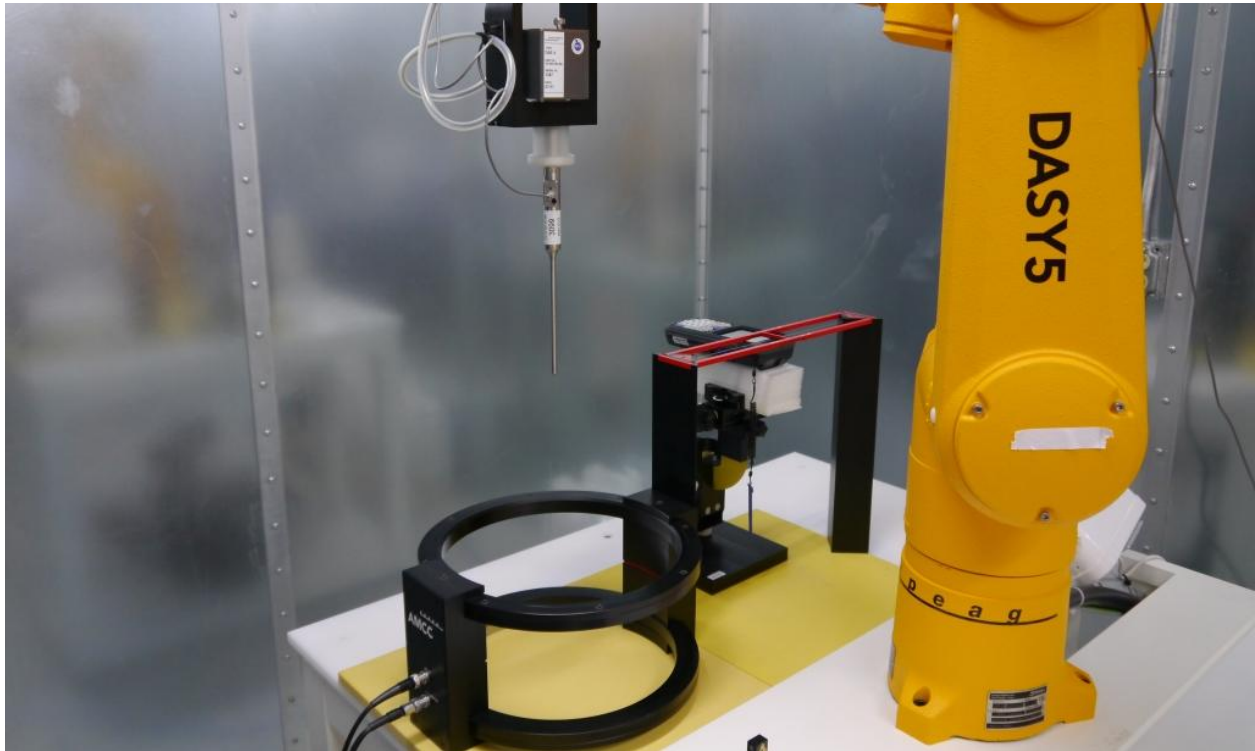

## 12 REFERENCES

1. SPEAG DASY V52.6 User manual, May 2014
2. ANSI C63.19-2011 " American National Standard for Methods of Measurement of Compatibility between Wireless Communication Devices and Hearing Aids".

### 13 REVISION HISTORY

Revision Level	Description of changes	Revision Date
0	Initial release	30 April 2015