

Intermec Technologies Corporation

Model: 1000CP01U

Evaluated to the following SAR Specifications:

FCC 2.1093: 2011
Health Safety Code 6:2009

Report No. INMC0681

Report Prepared By



www.nwemc.com
1-888-EMI-CERT

© 2011 Northwest EMC, Inc

SAR Evaluation Report

Certificate of Evaluation

Last Date of Test: January 31, 2011
Intermec Technologies Corporation
Model: 1000CP01U

Applicable Standards			
Test Description	Specification	Test Method	Pass/Fail
SAR Evaluation	FCC 2.1093:2011 FCC 15.247:2011 FCC 15.407:2011	FCC OET 65C:2001	Pass
		IEEE Std 1528:2003	
		FCC KDB 447498 D01 v04	
		FCC KDB 248227 D01 v01r02	
		FCC KDB 648474 D01 v01r05	
	FCC 865664		
	Health Safety Code 6:2009	RSS-102, Issue 4:2010	Pass

Highest SAR Values				
Frequency Band (GHz)	Head 1g (W/kg)	Body 1g (W/kg)	Limit 1g (W/kg)	Exposure Environment
2.4	0.039	0.293	1.6	General Population Uncontrolled
5.2, 5.3, 5.5. & 5.8	0.093	0.379		

Modifications made to the product
See the Modifications section of this report

Test Facility

The measurement facility used to collect the data is located at:

Northwest EMC, Inc.
22975 NW Evergreen Parkway, Suite 400
Hillsboro, OR 97124

Phone: (503) 844-4066 Fax: 844-3826

Approved By:



Don Facteau, IS Manager



NVLAP Lab Code: 200630-0

This report must not be used to claim product certification, approval, or endorsement by NVLAP, NIST, or any agency of the federal government of the United States of America.

Product compliance is the responsibility of the client, therefore the tests and equipment modes of operation represented in this report were agreed upon by the client, prior to testing. This Report may only be duplicated in its entirety. The results of this test pertain only to the sample(s) tested. The specific description is noted in each of the individual sections of the test report supporting this certificate of test.

Revision Number	Description	Date	Page Number
00	None		

Barometric Pressure

The recorded barometric pressure has been normalized to sea level.



Accreditations and Authorizations

FCC

Accredited by NVLAP for performance of FCC radio, digital, and ISM device testing. Our Open Area Test Sites, certification chambers, and conducted measurement facilities have been fully described in reports filed with the FCC and accepted by the FCC in letters maintained in our files. Northwest EMC has been accredited by ANSI to ISO / IEC Guide 65 as a product certifier. We have been designated by the FCC as a Telecommunications Certification Body (TCB). This allows Northwest EMC to certify transmitters to FCC specifications in accordance with 47 CFR 2.960 and 2.962.

NVLAP

Northwest EMC, Inc. is accredited under the National Voluntary Laboratory Accreditation Program (NVLAP) for satisfactory compliance with the requirements of ISO/IEC 17025 for Testing Laboratories. NVLAP is administered by the National Institute of Standards and Technology (NIST), an agency of the U.S. Commerce Department. The NVLAP accreditation encompasses Electromagnetic Compatibility Testing in accordance with the European Union EMC Directive 2004/108/EC, and ANSI C63.4. Additionally, Northwest EMC is accredited by NVLAP to perform radio testing in accordance with the European Union R&TTE Directive 1999/5/EEC, the requirements of FCC, and the RSS radio standards for Industry Canada.

Industry Canada

Accredited by NVLAP for performance of Industry Canada RSS and ICES testing. Our Open Area Test Sites and certification chambers comply with RSS-Gen, Issue 2 and have been filed with Industry Canada and accepted. Northwest EMC has been accredited by ANSI to ISO / IEC Guide 65 as a product certifier. We have been designated by NIST and recognized by Industry Canada as a Certification Body (CB) per the APEC Mutual Recognition Arrangement (MRA). This allows Northwest EMC to certify transmitters to Industry Canada technical requirements. (*Site Filing Numbers - Hillsboro: 2834D-1, 2834D-2, Sultan: 2834C-1, Irvine: 2834B-1, 2834B-2, Brooklyn Park: 2834E-1*)

CAB

Designated by NIST and validated by the European Commission as a Conformity Assessment Body (CAB) to conduct tests and approve products to the EMC directive and transmitters to the R&TTE directive, as described in the U.S. - EU Mutual Recognition Agreement.

Australia/New Zealand

The National Association of Testing Authorities (NATA), Australia has been appointed by the ACA as an accreditation body to accredit test laboratories and competent bodies for EMC standards. Accredited test reports or assessments by competent bodies must carry the NATA logo. Test reports made by an overseas laboratory that has been accredited for the relevant standards by an overseas accreditation body that has a Mutual Recognition Agreement (MRA) with NATA are also accepted as technical grounds for product conformity. The report should be endorsed with the respective logo of the accreditation body (NVLAP).



Accreditations and Authorizations

VCCI

Accepted as an Associate Member to the VCCI, Acceptance No. 564. Conducted and radiated measurement facilities have been registered in accordance with Regulations for Voluntary Control Measures, Article 8. (*Registration Numbers. - Hillsboro: C-1071, R-1025, G-84, C-2687, T-1658, and R-2318, Irvine: R-1943, G-85, C-2766, and T-1659, Sultan: R-871, G-83, C-1784, and T-1511, Brooklyn Park: R-3125, G-86, G-141, C-3464, and T-1634.*)

BSMI

Northwest EMC has been designated by NIST and validated by C-Taipei (BSMI) as a CAB to conduct tests as described in the APEC Mutual Recognition Agreement (US0017).

GOST

Northwest EMC, Inc. has been assessed and accredited by the Russian Certification bodies Certinform VNIINMASH, CERTINFO, SAMTES, and Federal CHEC, to perform EMC and Hygienic testing for Information Technology Products. As a result of their laboratory assessment, they will accept test results from Northwest EMC, Inc. for product certification

KCC

Northwest EMC, Inc is a CAB designated by MRA partners and recognized by Korea. (*Assigned Lab Numbers: Hillsboro: US0017, Irvine: US0158, Sultan: US0157, Brooklyn Park: US0175*)

VIETNAM

Vietnam MIC has approved Northwest EMC as an accredited test lab. Per Decision No. 194/QD-QLCL (dated December 15, 2009), Northwest EMC test reports can be used for Vietnam approval submissions.

SCOPE

For details on the Scopes of our Accreditations, please visit:

<http://www.nwemc.com/accreditations/>



Northwest EMC Locations



Oregon
Labs EV01-EV12
22975 NW Evergreen Pkwy
Suite 400
Hillsboro, OR 97124
(503) 844-4066

California
Labs OC01-OC13
41 Tesla
Irvine, CA 92618
(949) 861-8918

Minnesota
Labs MN01-MN08
9349 W Broadway Ave.
Brooklyn Park,
MN 55445
(763) 425-2281

Washington
Labs SU01-SU07
14128 339th Ave. SE
Sultan, WA 98294
(360) 793-8675

New York
Labs WA01-WA04
4939 Jordan Rd.
Elbridge, NY 13060
(315) 685-0796

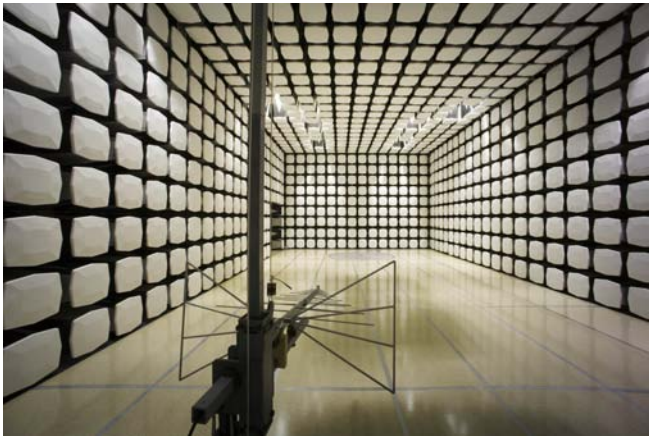

Party Requesting the Test

Company Name:	Intermec Technologies Corporation
Address:	6001 36 th Avenue West
City, State, Zip:	Everett, WA 98203-1264
Test Requested By:	Wayne Rieger
Model:	1000CP01U
First Date of Test:	January 14, 2011
Last Date of Test:	January 31, 2011
Receipt Date of Samples:	January 10, 2011
Equipment Design Stage:	Production
Equipment Condition:	No Damage

Information Provided by the Party Requesting the Test

Functional Description of the EUT (Equipment Under Test)

The EUT is a handheld computer containing two radio modules, Models RC12 and RW10, each with their own integral antenna.

The Intermec Model RC12 radio module is an 802.11a/b/g/n – Bluetooth radio. It is not capable of 40 MHz channel operation. The 802.11a/b/g/n and Bluetooth radios share the same antenna, but cannot transmit simultaneously. The frequency range of the 802.11a/b/g/n radio:

- 2412 – 2462 MHz
- 5180 – 5320 MHz
- 5500 – 5700 MHz
- 5745 – 5825 MHz

The frequency range of the Bluetooth radio:

- 2402 – 2480 MHz

The Intermec Model RW10 radio module is a UMTS radio. Its frequency range:

- 824.2 – 848.8 MHz
- 826.4 – 846.6 MHz
- 1850.2 – 1909.8 MHz
- 1852.4 – 1907.6 MHz

The closest spacing between the UMTS antenna and 802.11a/b/g/n antenna is 3.7cm. The 802.11a/b/g/n antenna is on the right side of the handheld computer and the UMTS antenna is on the left side.

In normal operation, the EUT can be held in the hand, or next to the head like a cellular handset, or worn on the body. The only Intermec approved accessory for body worn operation is a holster that contains metal. The EUT can only fit in the holster with the top end of the unit pointing down. The holster cup can be attached to the holster belt with either the keypad facing the user, or the side facing the user. In no case can the back of the EUT face the user.

An optional snap-on audio accessory is available. It connects to the bottom end of the unit and provides a standard audio jack for connection of a VR10 headset.

The EUT is powered by a lithium-ion battery, Model 1000AB01.

Overview of the SAR Evaluation

Objective

To demonstrate compliance with the SAR requirements of FCC 2.1093 and Canada's Health Safety Code 6.

Scope

The UMTS radio was evaluated under a separate SAR evaluation report.

Regarding the 802.11a/b/g/n-Bluetooth radio:

KDB 648474 D01 is the FCC's Policy for SAR evaluation of handsets with multiple transmitters and antennas. It states:

"When the output of an unlicensed transmitter is $\leq P_{ref}$, and its antenna(s) is ≥ 2.5 cm from other antennas, stand – alone SAR evaluation is not required for that unlicensed transmitter."

The power threshold P_{ref} is defined as the maximum conducted power available at the antenna according to source-based time averaging. P_{ref} is derived from $\frac{1}{2} * (60/f_{GHz})$

	2.45	5.15 - 5.35	5.47 - 5.85	GHz
P_{Ref}	12	6	5	mW
Device output power should be rounded to the nearest mW to compare with values specified in this table.				

Since the output power of Bluetooth is 7mW, and the antenna spacing is 3.7 cm, the Bluetooth radio does not require SAR evaluation.

However the output power of the 802.11a/b/g/n radio is greater than $2 * P_{ref}$ for all bands, so it does require stand-alone SAR evaluation.

The SAR evaluation documented in this report is for the 802.11a/b/g/n portion of the EUT.

CONFIGURATION 1**EUT**

Description	Manufacturer	Model/Part Number	Serial Number
Handheld Computer	Intermec Technologies	1000CP01U	24411047012

Peripherals in test setup boundary

Description	Manufacturer	Model/Part Number	Serial Number
Battery	Intermec Technologies	1000AB01	16961001722
Battery	Intermec Technologies	1000AB01	16960001720
Battery	Intermec Technologies	1000AB01	16961002513
Headset	Intermec Technologies	VR10	A351000021
Standard Audio Snap-On	Intermec Technologies	225-771-001	N/A
Holster	Intermec Technologies	X11183-V1-R1	N/A

Equipment modifications					
Item	Date	Test	Modification	Note	Disposition of EUT
1	1/14/2011	SAR Evaluation	Tested as delivered to Test Station.	No EMI suppression devices were added or modified during this test.	EUT remained at Northwest EMC following the test.
2	1/31/2010	SAR Evaluation	Tested as delivered to Test Station.	No EMI suppression devices were added or modified during this test.	Scheduled testing was completed.

2.4 GHz Band

Per FCC KDB 248227, the conducted output power was measured at the “default test channels” and at the “required test channels” in each band. Measurements were made while the EUT transmitted at the lowest, middle and the highest data rates for each channel.

Per KDB 648474, among the channels required for normal testing, SAR must be measured on the highest output channel (highlighted in green below). Since the SAR measured on the highest output channel is < 0.8 W/kg, SAR evaluation for the other required channels is unnecessary.

Channel	Frequency (MHz)	Data Rate (Mbps)	Modulation	Conducted Power (Average)	
				dBm	W
1	2412	1	BPSK	16.3	0.043
		11	CCK	16.0	0.040
		6	OFDM	13.3	0.021
		36	OFDM	13.0	0.020
		54	OFDM	13.0	0.020
		7.2 (MCS0)	OFDM	13.3	0.021
		72.2 (MCS7)	OFDM	12.5	0.018
6	2437	1	BPSK	16.5	0.045
		11	CCK	16.2	0.042
		6	OFDM	13.4	0.022
		36	OFDM	13.1	0.020
		54	OFDM	13.0	0.020
		7.2 (MCS0)	OFDM	13.4	0.022
		72.2 (MCS7)	OFDM	12.6	0.018
11	2462	1	BPSK	16.7	0.047
		11	CCK	16.3	0.043
		6	OFDM	13.6	0.023
		36	OFDM	13.4	0.022
		54	OFDM	13.2	0.021
		7.2 (MCS0)	OFDM	13.6	0.023
		72.2 (MCS7)	OFDM	12.8	0.019

5 GHz Bands

Channel	Frequency (MHz)	Data Rate (Mbps)	Modulation	Conducted Power (Average)	
				dBm	W
36	5180	6	OFDM	13.4	0.022
		54	OFDM	12.5	0.018
		7.2 (MCS0)	OFDM	13.3	0.021
		72.2 (MCS7)	OFDM	10.8	0.012
40	5200	6	OFDM	13.2	0.021
		54	OFDM	12.3	0.017
		7.2 (MCS0)	OFDM	13.2	0.021
		72.2 (MCS7)	OFDM	10.8	0.012
44	5220	6	OFDM	13.1	0.020
		54	OFDM	12.2	0.017
		7.2 (MCS0)	OFDM	13.1	0.020
		72.2 (MCS7)	OFDM	10.7	0.012
48	5240	6	OFDM	13.0	0.020
		54	OFDM	12.1	0.016
		7.2 (MCS0)	OFDM	13.0	0.020
		72.2 (MCS7)	OFDM	10.6	0.011
52	5260	6	OFDM	13.1	0.020
		54	OFDM	12.3	0.017
		7.2 (MCS0)	OFDM	13.2	0.021
		72.2 (MCS7)	OFDM	10.9	0.012
56	5280	6	OFDM	13.1	0.020
		54	OFDM	12.2	0.017
		7.2 (MCS0)	OFDM	13.1	0.020
		72.2 (MCS7)	OFDM	10.8	0.012
60	5300	6	OFDM	13.0	0.020
		54	OFDM	12.1	0.016
		7.2 (MCS0)	OFDM	13.0	0.020
		72.2 (MCS7)	OFDM	10.7	0.012
64	5320	6	OFDM	12.9	0.019
		54	OFDM	12.0	0.016
		7.2 (MCS0)	OFDM	12.9	0.019
		72.2 (MCS7)	OFDM	10.6	0.011
100	5500	6	OFDM	12.7	0.019
		7.2 (MCS0)	OFDM	12.8	0.019
104	5520	6	OFDM	12.8	0.019
		7.2 (MCS0)	OFDM	12.8	0.019
108	5540	6	OFDM	12.8	0.019
		7.2 (MCS0)	OFDM	12.9	0.019
112	5560	6	OFDM	12.8	0.019
		7.2 (MCS0)	OFDM	12.8	0.019
116	5580	6	OFDM	12.8	0.019
		7.2 (MCS0)	OFDM	12.8	0.019
120	5600	6	OFDM	12.9	0.019
		7.2 (MCS0)	OFDM	12.9	0.019
124	5620	6	OFDM	12.9	0.019
		7.2 (MCS0)	OFDM	12.9	0.019
128	5640	6	OFDM	12.7	0.019
		7.2 (MCS0)	OFDM	12.7	0.019
132	5660	6	OFDM	12.6	0.018
		7.2 (MCS0)	OFDM	12.6	0.018
136	5680	6	OFDM	12.4	0.017
		7.2 (MCS0)	OFDM	12.4	0.017
140	5700	6	OFDM	12.2	0.017
		7.2 (MCS0)	OFDM	12.2	0.017
149	5745	6	OFDM	11.6	0.014
		7.2 (MCS0)	OFDM	11.6	0.014
153	5765	6	OFDM	11.5	0.014
		7.2 (MCS0)	OFDM	11.5	0.014
157	5785	6	OFDM	11.3	0.013
		7.2 (MCS0)	OFDM	11.3	0.013
161	5805	6	OFDM	11.2	0.013
		7.2 (MCS0)	OFDM	11.2	0.013
165	5825	6	OFDM	11.1	0.013
		7.2 (MCS0)	OFDM	11.1	0.013

Characterization of tissue-equivalent liquid dielectric properties

Per IEEE 1528: 2003, Section 5.2.2, the permittivity and conductivity of the tissue material should be measured at least within 24 hours of any full-compliance test. The measured values must be within +/- 5% of the target values. The temperature variation in the liquid during SAR measurements must be within +/- 2 degrees C of that recorded when the dielectric properties were measured.

The dielectric parameters of the tissue-equivalent liquids were measured prior to testing using the HP85070E dielectric probe kit. The dielectric measurements were made at 50 MHz intervals. The attached data sheets show that the dielectric parameters of the liquid were within the required 5% tolerances.

Target values of dielectric parameters

Per FCC OET 65C, Appendix C:

“The head tissue dielectric parameters recommended by the IEEE SCC-34/SC-2 in P1528 have been incorporated in the following table. These head parameters are derived from planar layer models simulating the highest expected SAR for the dielectric properties and tissue thickness variations in a human head. Other head and body tissue parameters that have not been specified in P1528 are derived from the tissue dielectric parameters computed from the 4-Cole-Cole equations and extrapolated according to the head parameters specified in P1528.”

Target Frequency (MHz)	Head		Body	
	ϵ_r	σ (S/m)	ϵ_r	σ (S/m)
150	52.3	0.76	61.9	0.80
300	45.3	0.87	58.2	0.92
450	43.5	0.87	56.7	0.94
835	41.5	0.90	55.2	0.97
900	41.5	0.97	55.0	1.05
915	41.5	0.98	55.0	1.06
1450	40.5	1.20	54.0	1.30
1610	40.3	1.29	53.8	1.40
1800 – 2000	40.0	1.40	53.3	1.52
2450	39.2	1.80	52.7	1.95
3000	38.5	2.40	52.0	2.73
5800	35.3	5.27	48.2	6.00

(ϵ_r = relative permittivity, σ = conductivity and $\rho = 1000 \text{ kg/m}^3$)

Composition of Ingredients for Liquid Tissue Phantoms

Northwest EMC uses tissue-equivalent liquids prepared by SPEAG and confirmed by them to be within +/- 5% from the target values. Their recipes are based upon the following formulations as found in FCC OET 65C, Appendix C:

“The following tissue formulations are provided for reference only as some of the parameters have not been thoroughly verified. The composition of ingredients may be modified accordingly to achieve the desired target tissue parameters required for routine SAR evaluation.”

Ingredients (% by weight)	Frequency (MHz)									
	450		835		915		1900		2450	
Tissue Type	Head	Body	Head	Body	Head	Body	Head	Body	Head	Body
Water	38.56	51.16	41.45	52.4	41.05	56.0	54.9	40.4	62.7	73.2
Salt (NaCl)	3.95	1.49	1.45	1.4	1.35	0.76	0.18	0.5	0.5	0.04
Sugar	56.32	46.78	56.0	45.0	56.5	41.76	0.0	58.0	0.0	0.0
HEC	0.98	0.52	1.0	1.0	1.0	1.21	0.0	1.0	0.0	0.0
Bactericide	0.19	0.05	0.1	0.1	0.1	0.27	0.0	0.1	0.0	0.0
Triton X-100	0.0	0.0	0.0	0.0	0.0	0.0	0.0	0.0	36.8	0.0
DGBE	0.0	0.0	0.0	0.0	0.0	0.0	44.92	0.0	0.0	26.7
Dielectric Constant	43.42	58.0	42.54	56.1	42.0	56.8	39.9	54.0	39.8	52.5
Conductivity (S/m)	0.85	0.83	0.91	0.95	1.0	1.07	1.42	1.45	1.88	1.78

Salt: 99⁺% Pure Sodium Chloride

Sugar: 98⁺% Pure Sucrose

Water: De-ionized, 16 M Ω ⁺ resistivity

HEC: Hydroxyethyl Cellulose

DGBE: 99⁺% Di(ethylene glycol) butyl ether, [2-(2-butoxyethoxy)ethanol]

Triton X-100 (ultra pure): Polyethylene glycol mono [4-(1,1, 3, 3-tetramethylbutyl)phenyl]ether

EMC

Tissue - Equivalent Liquid

EUT: MSL2450	Work Order: INMC0570
Serial Number: 101119-2	Date: 01/14/11
Customer: Intermec Technologies Corporation	Temperature: 22
Attendees: None	Humidity: 43%
Project: None	Barometric Pres.: 1024.1
Tested by: Jennifer Herrett	Power: None
Job Site: Cal Lab	
TEST SPECIFICATIONS	
FCC 2.1093:2011	Test Method FCC OET 65C: 2001
COMMENTS	
None	
DEVIATIONS FROM TEST STANDARD	
None	
Configuration #	None
	Signature <i>Jennifer Herrett</i>
Tissue: Body	
Temperature: 21.9 C	

Frequency (GHz)	Actual Values		Target Values		Deviation (%)	
	Relative Permittivity	Conductivity	Relative Permittivity	Conductivity	Relative Permittivity	Conductivity
2.45	50.5117	1.9600	52.7	1.95	4.15	0.51

1.9	52.3688	1.2672
1.925	52.2927	1.2953
1.95	52.2241	1.3237
1.975	52.1551	1.3535
2	52.0881	1.3845
2.025	52.0048	1.4141
2.05	51.9142	1.4451
2.075	51.8228	1.4755
2.1	51.7423	1.5066
2.125	51.6716	1.5381
2.15	51.5998	1.5701
2.175	51.5205	1.6028
2.2	51.4179	1.6345
2.225	51.3226	1.6670
2.25	51.2235	1.7000
2.275	51.1294	1.7318
2.3	51.0432	1.7639
2.325	50.9585	1.7952
2.35	50.8701	1.8263
2.375	50.7837	1.8585
2.4	50.6933	1.8916
2.425	50.5971	1.9255
2.45	50.5117	1.9600
2.475	50.4249	1.9929
2.5	50.3338	2.0248
2.525	50.249	2.0569
2.55	50.1522	2.0924
2.575	50.0677	2.1278
2.6	49.9766	2.1635
2.625	49.89	2.1987
2.65	49.8012	2.2337
2.675	49.7009	2.2682
2.7	49.6043	2.3038

EMC**Tissue - Equivalent Liquid**

EUT: MSL2450	Work Order: INMC0570
Serial Number: 101119-2	Date: 01/17/11
Customer: Intermec Technologies Corporation	Temperature: 22
Attendees: None	Humidity: 50%
Project: None	Barometric Pres.: 1020.6
Tested by: Jennifer Herrett	Power: None
Job Site: Cal Lab	
TEST SPECIFICATIONS	
FCC 2.1093:2011	Test Method FCC OET 65C: 2001
COMMENTS	
None	
DEVIATIONS FROM TEST STANDARD	
None	
Configuration #	None
	Signature <i>Jennifer Herrett</i>
Tissue: Body	
Temperature: 22.1 C	

Frequency (GHz)	Actual Values		Target Values		Deviation (%)	
	Relative Permittivity	Conductivity	Relative Permittivity	Conductivity	Relative Permittivity	Conductivity
2.45	50.6757	1.9723	52.7	1.95	3.84	1.15

1.9	52.4621	1.2743
1.925	52.3743	1.3037
1.95	52.2992	1.3338
1.975	52.2294	1.3640
2	52.1537	1.3938
2.025	52.0727	1.4239
2.05	51.9787	1.4543
2.075	51.8843	1.4852
2.1	51.8048	1.5163
2.125	51.7344	1.5472
2.15	51.6657	1.5781
2.175	51.5967	1.6091
2.2	51.5131	1.6401
2.225	51.4252	1.6720
2.25	51.3336	1.7048
2.275	51.2468	1.7378
2.3	51.1778	1.7698
2.325	51.1043	1.8013
2.35	51.0297	1.8333
2.375	50.9412	1.8668
2.4	50.854	1.9015
2.425	50.766	1.9367
2.45	50.6757	1.9723
2.475	50.5875	2.0063
2.5	50.4897	2.0410
2.525	50.3883	2.0731
2.55	50.2903	2.1086
2.575	50.1918	2.1458
2.6	50.0957	2.1815
2.625	50.0035	2.2153
2.65	49.9115	2.2503
2.675	49.8099	2.2855
2.7	49.7036	2.3218

EMC

Tissue - Equivalent Liquid

EUT:	MSL2450	Work Order:	INMC0570
Serial Number:	101119-2	Date:	01/18/11
Customer:	Intermec Technologies Corporation	Temperature:	22
Attendees:	None	Humidity:	37%
Project:	None	Barometric Pres.:	1025.4
Tested by:	Jennifer Herrett	Power:	None
Job Site:		Cal Lab	
TEST SPECIFICATIONS			
FCC 2.1093:2011		Test Method	
		FCC OET 65C: 2001	
COMMENTS			
None			
DEVIATIONS FROM TEST STANDARD			
None			
Configuration #	None	Signature 	
Tissue: Body		Temperature: 22.3 C	

Frequency (GHz)	Actual Values		Target Values		Deviation (%)	
	Relative Permittivity	Conductivity	Relative Permittivity	Conductivity	Relative Permittivity	Conductivity
2.45	50.4833	2.0056	52.7	1.95	4.21	2.85

1.9	52.3998	1.2987
1.925	52.2997	1.3270
1.95	52.2018	1.3563
1.975	52.1156	1.3861
2	52.03	1.4157
2.025	51.9478	1.4457
2.05	51.8632	1.4762
2.075	51.7831	1.5061
2.1	51.7004	1.5365
2.125	51.6193	1.5671
2.15	51.5511	1.5990
2.175	51.4832	1.6319
2.2	51.4046	1.6664
2.225	51.3315	1.7004
2.25	51.2304	1.7345
2.275	51.1421	1.7691
2.3	51.0494	1.8021
2.325	50.9533	1.8354
2.35	50.8603	1.8694
2.375	50.7639	1.9023
2.4	50.6669	1.9371
2.425	50.5797	1.9721
2.45	50.4833	2.0056
2.475	50.394	2.0394
2.5	50.295	2.0740
2.525	50.1983	2.1086
2.55	50.1041	2.1442
2.575	50.0134	2.1802
2.6	49.9178	2.2159
2.625	49.8212	2.2517
2.65	49.7157	2.2866
2.675	49.6114	2.3227
2.7	49.5086	2.3567

EMC

Tissue - Equivalent Liquid

EUT:	HSL501	Work Order:	INMC0570
Serial Number:	101102-1	Date:	01/20/11
Customer:	Intermec Technologies Corporation	Temperature:	22
Attendees:	None	Humidity:	45%
Project:	None	Barometric Pres.:	1031.3
Tested by:	Jennifer Herrett	Power:	None
		Job Site:	Cal Lab
TEST SPECIFICATIONS		Test Method	
FCC 2.1093:2011		FCC OET 65C: 2001	
COMMENTS			
None			
DEVIATIONS FROM TEST STANDARD			
None			
Configuration #	None	Signature 	
Tissue: Head		Temperature: 22.4 C	

Frequency (GHz)	Actual Values		Target Values		Deviation (%)	
	Relative Permittivity	Conductivity	Relative Permittivity	Conductivity	Relative Permittivity	Conductivity
5.8	35.919	5.4211	35.3	5.27	1.75	2.87

3.4	39.4849	2.8905
3.45	39.4235	2.9316
3.5	39.3608	2.9729
3.55	39.2994	3.0149
3.6	39.2455	3.0573
3.65	39.189	3.0995
3.7	39.1372	3.1439
3.75	39.078	3.1880
3.8	39.03	3.2327
3.85	38.9813	3.2790
3.9	38.9259	3.3258
3.95	38.878	3.3737
4	38.8249	3.4225
4.05	38.77	3.4725
4.1	38.7065	3.5234
4.15	38.6497	3.5748
4.2	38.5929	3.6258
4.25	38.5312	3.6807
4.3	38.4645	3.7318
4.35	38.394	3.7858
4.4	38.32	3.8412
4.45	38.2523	3.8962
4.5	38.1795	3.9505
4.55	38.1028	4.0082
4.6	38.0269	4.0645
4.65	37.9488	4.1195
4.7	37.8624	4.1766
4.75	37.7806	4.2337
4.8	37.7046	4.2910
4.85	37.6195	4.3462
4.9	37.5301	4.4013
4.95	37.438	4.4580
5	37.3489	4.5159
5.05	37.2694	4.5724
5.1	37.1726	4.6304
5.15	37.0802	4.6876
5.2	36.9907	4.7456
5.25	36.9038	4.8010
5.3	36.8103	4.8553
5.35	36.7178	4.9113
5.4	36.6322	4.9682
5.45	36.5416	5.0259
5.5	36.4484	5.0809
5.55	36.3577	5.1371
5.6	36.2608	5.1952
5.65	36.1829	5.2513
5.7	36.094	5.3084
5.75	36.0029	5.3651
5.8	35.919	5.4211
5.85	35.8356	5.4779
5.9	35.7487	5.5341

EMC**Tissue - Equivalent Liquid**

EUT:	HSL2450	Work Order:	INMC0570
Serial Number:	101119-1	Date:	01/21/11
Customer:	Intermec Technologies Corporation	Temperature:	23
Attendees:	None	Humidity:	40%
Project:	None	Barometric Pres.:	1023.8
Tested by:	Jennifer Herrett	Power:	None
TEST SPECIFICATIONS		Test Method	
FCC 2.1093:2011		FCC OET 65C: 2001	
COMMENTS			
None			
DEVIATIONS FROM TEST STANDARD			
None			
Configuration #	None	Signature <i>Jennifer Herrett</i>	
Tissue: Head		Temperature: 22.7 C	

Frequency (GHz)	Actual Values		Target Values		Deviation (%)	
	Relative Permittivity	Conductivity	Relative Permittivity	Conductivity	Relative Permittivity	Conductivity
2.45	38.7918	1.8734	39.2	1.8	1.04	4.08

1.9	40.972	1.2618
1.925	40.8609	1.2878
1.95	40.7525	1.3135
1.975	40.647	1.3388
2	40.5427	1.3649
2.025	40.4419	1.3929
2.05	40.3491	1.4215
2.075	40.2583	1.4502
2.1	40.1622	1.4774
2.125	40.0684	1.5048
2.15	39.9645	1.5321
2.175	39.8609	1.5600
2.2	39.7597	1.5884
2.225	39.6638	1.6171
2.25	39.5719	1.6447
2.275	39.4733	1.6725
2.3	39.377	1.7002
2.325	39.2795	1.7282
2.35	39.1796	1.7567
2.375	39.0859	1.7860
2.4	38.9864	1.8146
2.425	38.8917	1.8443
2.45	38.7918	1.8734
2.475	38.6894	1.9024
2.5	38.5833	1.9320
2.525	38.473	1.9611
2.55	38.3679	1.9910
2.575	38.2671	2.0213
2.6	38.1636	2.0508
2.625	38.0674	2.0801
2.65	37.9619	2.1108
2.675	37.8594	2.1414
2.7	37.7462	2.1716

EMC

Tissue - Equivalent Liquid

EUT:	HSL501	Work Order:	INMC0570
Serial Number:	101102-1	Date:	01/24/11
Customer:	Intermec Technologies Corporation	Temperature:	22.8
Attendees:	None	Humidity:	34%
Project:	None	Barometric Pres.:	1023.2
Tested by:	Jennifer Herrett	Power:	None
TEST SPECIFICATIONS		Test Method	
FCC 2.1093:2011		FCC OET 65C: 2001	
COMMENTS			
None			
DEVIATIONS FROM TEST STANDARD			
None			
Configuration #	None	Signature <i>Jennifer Herrett</i>	
Tissue: Head		Temperature: 22.6 C	

Frequency (GHz)	Actual Values		Target Values		Deviation (%)	
	Relative Permittivity	Conductivity	Relative Permittivity	Conductivity	Relative Permittivity	Conductivity
5.8	36.5963	5.4546	35.3	5.27	3.67	3.50

3.4	39.9869	2.9145
3.45	39.9249	2.9584
3.5	39.872	3.0011
3.55	39.8242	3.0446
3.6	39.7759	3.0869
3.65	39.7255	3.1288
3.7	39.6734	3.1724
3.75	39.6321	3.2153
3.8	39.5797	3.2596
3.85	39.5336	3.3048
3.9	39.4962	3.3508
3.95	39.4373	3.3984
4	39.3849	3.4466
4.05	39.3376	3.4960
4.1	39.2768	3.5470
4.15	39.2201	3.5986
4.2	39.1614	3.6499
4.25	39.1123	3.7033
4.3	39.0452	3.7560
4.35	38.9795	3.8089
4.4	38.9157	3.8630
4.45	38.8457	3.9199
4.5	38.7794	3.9737
4.55	38.7043	4.0292
4.6	38.6337	4.0835
4.65	38.5557	4.1383
4.7	38.4775	4.1932
4.75	38.3935	4.2495
4.8	38.3037	4.3096
4.85	38.2229	4.3696
4.9	38.1416	4.4283
4.95	38.0649	4.4865
5	37.9862	4.5444
5.05	37.8892	4.6018
5.1	37.8099	4.6590
5.15	37.7254	4.7150
5.2	37.6424	4.7706
5.25	37.5591	4.8307
5.3	37.474	4.8824
5.35	37.3781	4.9357
5.4	37.293	4.9935
5.45	37.2047	5.0512
5.5	37.1185	5.1079
5.55	37.0285	5.1660
5.6	36.9376	5.2209
5.65	36.8601	5.2829
5.7	36.7717	5.3402
5.75	36.6864	5.3948
5.8	36.5963	5.4546
5.85	36.5251	5.5108
5.9	36.4292	5.5667

EMC

Tissue - Equivalent Liquid

EUT:	HSL501	Work Order:	INMC0570
Serial Number:	101102-1	Date:	01/25/11
Customer:	Intermec Technologies Corporation	Temperature:	22
Attendees:	None	Humidity:	34%
Project:	None	Barometric Pres.:	1028.5
Tested by:	Jennifer Herrett	Power:	None
TEST SPECIFICATIONS		Test Method	
FCC 2.1093:2011		FCC OET 65C: 2001	
COMMENTS			
None			
DEVIATIONS FROM TEST STANDARD			
None			
Configuration #	None	Signature <i>Jennifer Herrett</i>	
Tissue: Head		Temperature: 22 C	

Frequency (GHz)	Actual Values		Target Values		Deviation (%)	
	Relative Permittivity	Conductivity	Relative Permittivity	Conductivity	Relative Permittivity	Conductivity
5.8	36.32	5.4701	35.3	5.27	2.89	3.80

3.4	39.7864	2.9016
3.45	39.7239	2.9446
3.5	39.6705	2.9868
3.55	39.6203	3.0294
3.6	39.5678	3.0721
3.65	39.5129	3.1153
3.7	39.4662	3.1609
3.75	39.4226	3.2049
3.8	39.3704	3.2502
3.85	39.3232	3.2964
3.9	39.263	3.3436
3.95	39.2098	3.3920
4	39.1599	3.4415
4.05	39.0993	3.4929
4.1	39.0414	3.5431
4.15	38.9912	3.5951
4.2	38.9323	3.6461
4.25	38.8727	3.6997
4.3	38.8033	3.7524
4.35	38.7393	3.8082
4.4	38.6672	3.8633
4.45	38.6049	3.9185
4.5	38.5371	3.9721
4.55	38.4604	4.0289
4.6	38.384	4.0839
4.65	38.3025	4.1383
4.7	38.219	4.1951
4.75	38.1365	4.2516
4.8	38.048	4.3106
4.85	37.9594	4.3702
4.9	37.8767	4.4292
4.95	37.7965	4.4887
5	37.7086	4.5493
5.05	37.6156	4.6053
5.1	37.5236	4.6653
5.15	37.4457	4.7225
5.2	37.3587	4.7791
5.25	37.2812	4.8359
5.3	37.1873	4.8895
5.35	37.0912	4.9470
5.4	37.0084	5.0058
5.45	36.9156	5.0632
5.5	36.8278	5.1206
5.55	36.7455	5.1783
5.6	36.6506	5.2352
5.65	36.5626	5.2929
5.7	36.4795	5.3533
5.75	36.399	5.4114
5.8	36.32	5.4701
5.85	36.2318	5.5254
5.9	36.136	5.5815

EMC

Tissue - Equivalent Liquid

EUT:	HSL501	Work Order:	INMC0570
Serial Number:	101102-1	Date:	01/26/11
Customer:	Intermec Technologies Corporation	Temperature:	23
Attendees:	None	Humidity:	32%
Project:	None	Barometric Pres.:	1027.2
Tested by:	Jennifer Herrett	Power:	None
TEST SPECIFICATIONS		Test Method	
FCC 2.1093:2011		FCC OET 65C: 2001	
COMMENTS			
None			
DEVIATIONS FROM TEST STANDARD			
None			
Configuration #	None	Signature <i>Jennifer Herrett</i>	
Tissue: Head		Temperature: 23 C	

Frequency (GHz)	Actual Values		Target Values		Deviation (%)	
	Relative Permittivity	Conductivity	Relative Permittivity	Conductivity	Relative Permittivity	Conductivity
5.8	34.7339	5.3950	35.3	5.27	1.60	2.37

3.4	38.178	2.8553
3.45	38.1168	2.8990
3.5	38.0597	2.9408
3.55	37.9998	2.9840
3.6	37.944	3.0272
3.65	37.8808	3.0693
3.7	37.8309	3.1133
3.75	37.7766	3.1564
3.8	37.7196	3.2019
3.85	37.6629	3.2448
3.9	37.6062	3.2919
3.95	37.5495	3.3369
4	37.4889	3.3863
4.05	37.4282	3.4340
4.1	37.3676	3.4853
4.15	37.3159	3.5358
4.2	37.25	3.5872
4.25	37.1911	3.6405
4.3	37.1162	3.6932
4.35	37.0488	3.7457
4.4	36.9804	3.7997
4.45	36.9075	3.8547
4.5	36.8364	3.9089
4.55	36.7559	3.9637
4.6	36.6775	4.0185
4.65	36.6012	4.0713
4.7	36.5176	4.1259
4.75	36.4389	4.1814
4.8	36.3481	4.2394
4.85	36.2679	4.2979
4.9	36.1778	4.3548
4.95	36.0959	4.4134
5	36.0129	4.4730
5.05	35.9329	4.5303
5.1	35.8469	4.5880
5.15	35.7724	4.6442
5.2	35.691	4.7019
5.25	35.6127	4.7583
5.3	35.5276	4.8119
5.35	35.451	4.8708
5.4	35.3649	4.9281
5.45	35.284	4.9860
5.5	35.204	5.0458
5.55	35.125	5.1037
5.6	35.047	5.1620
5.65	34.9638	5.2208
5.7	34.8925	5.2794
5.75	34.8055	5.3375
5.8	34.7339	5.3950
5.85	34.6575	5.4557
5.9	34.5774	5.5132

EMC

Tissue - Equivalent Liquid

EUT:	HSL501	Work Order:	INMC0570
Serial Number:	101102-1	Date:	01/27/11
Customer:	Intermec Technologies Corporation	Temperature:	23
Attendees:	None	Humidity:	33%
Project:	None	Barometric Pres.:	1025.3
Tested by:	Jennifer Herrett	Power:	None
TEST SPECIFICATIONS		Test Method	
FCC 2.1093:2011		FCC OET 65C: 2001	
COMMENTS			
None			
DEVIATIONS FROM TEST STANDARD			
None			
Configuration #	None	Signature <i>Jennifer Herrett</i>	
Tissue: Head		Temperature: 22.4 C	

Frequency (GHz)	Actual Values		Target Values		Deviation (%)	
	Relative Permittivity	Conductivity	Relative Permittivity	Conductivity	Relative Permittivity	Conductivity
5.8	35.2662	5.4427	35.3	5.27	0.10	3.28

3.4	38.7098	2.9305
3.45	38.6508	2.9723
3.5	38.5899	3.0128
3.55	38.5243	3.0551
3.6	38.4747	3.1006
3.65	38.4347	3.1456
3.7	38.3977	3.1858
3.75	38.3325	3.2283
3.8	38.2832	3.2752
3.85	38.2423	3.3230
3.9	38.1966	3.3669
3.95	38.1421	3.4136
4	38.0964	3.4628
4.05	38.054	3.5120
4.1	37.9954	3.5596
4.15	37.9451	3.6098
4.2	37.8834	3.6603
4.25	37.8245	3.7132
4.3	37.7746	3.7642
4.35	37.7078	3.8141
4.4	37.6324	3.8662
4.45	37.5655	3.9205
4.5	37.4886	3.9730
4.55	37.4097	4.0302
4.6	37.3361	4.0865
4.65	37.2653	4.1410
4.7	37.1914	4.1960
4.75	37.1175	4.2469
4.8	37.0181	4.3025
4.85	36.9173	4.3633
4.9	36.828	4.4236
4.95	36.7371	4.4826
5	36.6419	4.5457
5.05	36.5645	4.6080
5.1	36.4945	4.6642
5.15	36.3937	4.7197
5.2	36.3176	4.7775
5.25	36.2405	4.8299
5.3	36.1441	4.8852
5.35	36.0575	4.9427
5.4	35.9828	4.9980
5.45	35.8827	5.0528
5.5	35.7895	5.1083
5.55	35.7265	5.1676
5.6	35.653	5.2193
5.65	35.5655	5.2736
5.7	35.4659	5.3266
5.75	35.3675	5.3834
5.8	35.2662	5.4427
5.85	35.2014	5.5050
5.9	35.1277	5.5602

EMC

Tissue - Equivalent Liquid

EUT:	HSL501	Work Order:	INMC0570
Serial Number:	101102-1	Date:	01/28/11
Customer:	Intermec Technologies Corporation	Temperature:	23
Attendees:	None	Humidity:	33%
Project:	None	Barometric Pres.:	1018.3
Tested by:	Jennifer Herrett	Power:	None
		Job Site:	Cal Lab
TEST SPECIFICATIONS		Test Method	
FCC 2.1093:2011		FCC OET 65C: 2001	
COMMENTS			
None			
DEVIATIONS FROM TEST STANDARD			
None			
Configuration #	None	Signature <i>Jennifer Herrett</i>	
Tissue: Head		Temperature: 23 C	

Frequency (GHz)	Actual Values		Target Values		Deviation (%)	
	Relative Permittivity	Conductivity	Relative Permittivity	Conductivity	Relative Permittivity	Conductivity
5.8	34.2209	5.4137	35.3	5.27	3.06	2.73

3.4	37.6503	2.9082
3.45	37.5749	2.9484
3.5	37.51	2.9914
3.55	37.4617	3.0325
3.6	37.3994	3.0726
3.65	37.3366	3.1166
3.7	37.2985	3.1596
3.75	37.2486	3.1999
3.8	37.1916	3.2444
3.85	37.156	3.2913
3.9	37.1135	3.3357
3.95	37.0592	3.3816
4	37.0134	3.4316
4.05	36.975	3.4804
4.1	36.9227	3.5308
4.15	36.8748	3.5830
4.2	36.8255	3.6341
4.25	36.7732	3.6878
4.3	36.7086	3.7419
4.35	36.6392	3.7937
4.4	36.5706	3.8486
4.45	36.5072	3.9052
4.5	36.4412	3.9601
4.55	36.3592	4.0151
4.6	36.2941	4.0702
4.65	36.2145	4.1213
4.7	36.1292	4.1760
4.75	36.0523	4.2320
4.8	35.9664	4.2858
4.85	35.8735	4.3424
4.9	35.7875	4.4000
4.95	35.7027	4.4560
5	35.6055	4.5134
5.05	35.5209	4.5746
5.1	35.4522	4.6296
5.15	35.3582	4.6864
5.2	35.2733	4.7450
5.25	35.1986	4.7984
5.3	35.1104	4.8509
5.35	35.0209	4.9078
5.4	34.9394	4.9634
5.45	34.845	5.0190
5.5	34.7552	5.0743
5.55	34.6779	5.1324
5.6	34.5817	5.1870
5.65	34.487	5.2460
5.7	34.4112	5.3007
5.75	34.3136	5.3541
5.8	34.2209	5.4137
5.85	34.1432	5.4697
5.9	34.0513	5.5236

EMC

Tissue - Equivalent Liquid

EUT:	MSL501	Work Order:	INMC0570
Serial Number:	101101-1	Date:	01/28/11
Customer:	Intermec Technologies Corporation	Temperature:	22.3
Attendees:	None	Humidity:	37%
Project:	None	Barometric Pres.:	1018.3
Tested by:	Jennifer Herrett	Power:	None
		Job Site:	Cal Lab
TEST SPECIFICATIONS		Test Method	
FCC 2.1093:2011		FCC OET 65C: 2001	
COMMENTS			
None			
DEVIATIONS FROM TEST STANDARD			
None			
Configuration #	None	Signature <i>Jennifer Herrett</i>	
Tissue: Body		Temperature: 22.3 C	

Frequency (GHz)	Actual Values		Target Values		Deviation (%)	
	Relative Permittivity	Conductivity	Relative Permittivity	Conductivity	Relative Permittivity	Conductivity
5.8	47.0582	6.2538	48.2	6	2.37	4.23

3.4	50.7532	3.1105
3.45		
3.5	50.6789	3.2201
3.55		
3.6	50.5864	3.3339
3.65		
3.7	50.4963	3.4595
3.75		
3.8	50.2988	3.5701
3.85		
3.9	50.182	3.6834
3.95		
4	50.0729	3.8058
4.05		
4.1	49.8632	3.9204
4.15		
4.2	49.7592	4.0486
4.25		
4.3	49.5523	4.1691
4.35		
4.4	49.4691	4.3053
4.45		
4.5	49.3671	4.4356
4.55		
4.6	49.1813	4.5729
4.65		
4.7	48.987	4.7054
4.75		
4.8	48.7868	4.8441
4.85	48.6938	4.9126
4.9	48.6937	4.9840
4.95	48.5914	5.0467
5	48.4902	5.1213
5.05	48.3908	5.1853
5.1	48.1801	5.2497
5.15	48.186	5.3259
5.2	48.1	5.3950
5.25	47.9812	5.4663
5.3	47.8931	5.5230
5.35	47.8031	5.5984
5.4	47.7111	5.6689
5.45	47.6074	5.7458
5.5	47.639	5.8176
5.55	47.5312	5.8814
5.6	47.4433	5.9490
5.65	47.3399	6.0301
5.7	47.2512	6.1014
5.75	47.1406	6.1665
5.8	47.0582	6.2538
5.85	46.9488	6.3293
5.9	46.9496	6.4100

EMC

Tissue - Equivalent Liquid

EUT:	MSL501	Work Order:	INMC0570
Serial Number:	101101-1	Date:	01/29/11
Customer:	Intermec Technologies Corporation	Temperature:	21.7
Attendees:	None	Humidity:	35%
Project:	None	Barometric Pres.:	1014.3
Tested by:	Jennifer Herrett	Power:	None
		Job Site:	Cal Lab
TEST SPECIFICATIONS			
FCC 2.1093:2011		Test Method	
		FCC OET 65C: 2001	
COMMENTS			
None			
DEVIATIONS FROM TEST STANDARD			
None			
Configuration #	None	Signature <i>Jennifer Herrett</i>	
Tissue: Body		Temperature: 21.7 C	

Frequency (GHz)	Actual Values		Target Values		Deviation (%)	
	Relative Permittivity	Conductivity	Relative Permittivity	Conductivity	Relative Permittivity	Conductivity
5.8	46.9055	6.2174	48.2	6	2.69	3.62

3.4	50.6871	3.1622
3.45		
3.5	50.5718	3.2659
3.55		
3.6	50.468	3.3719
3.65		
3.7	50.3686	3.4956
3.75		
3.8	50.1574	3.5983
3.85		
3.9	50.0748	3.7114
3.95		
4	49.9848	3.8284
4.05		
4.1	49.7847	3.9437
4.15		
4.2	49.6836	4.0730
4.25		
4.3	49.4895	4.1975
4.35		
4.4	49.3844	4.3334
4.45		
4.5	49.2946	4.4641
4.55		
4.6	49.0904	4.6018
4.65		
4.7	48.8914	4.7321
4.75		
4.8	48.6935	4.8652
4.85	48.5786	4.9313
4.9	48.5734	5.0006
4.95	48.4755	5.0627
5	48.3667	5.1366
5.05	48.2651	5.1995
5.1	48.0629	5.2576
5.15	48.0521	5.3335
5.2	47.9705	5.4027
5.25	47.8635	5.4688
5.3	47.765	5.5221
5.35	47.6753	5.5998
5.4	47.5878	5.6584
5.45	47.469	5.7353
5.5	47.478	5.8020
5.55	47.3923	5.8632
5.6	47.2913	5.9227
5.65	47.1931	6.0020
5.7	47.0983	6.0700
5.75	46.9891	6.1293
5.8	46.9055	6.2174
5.85	46.8125	6.2909
5.9	46.8254	6.3686

EMC**Tissue - Equivalent Liquid**

EUT:	MSL501	Work Order:	INMC0570
Serial Number:	101101-1	Date:	01/31/11
Customer:	Intermec Technologies Corporation	Temperature:	22.8
Attendees:	None	Humidity:	36%
Project:	None	Barometric Pres.:	1018.8
Tested by:	Jennifer Herrett	Power:	None
TEST SPECIFICATIONS		Test Method	
FCC 2.1093:2011		FCC OET 65C: 2001	
COMMENTS			
None			
DEVIATIONS FROM TEST STANDARD			
None			
Configuration #	None	Signature <i>Jennifer Herrett</i>	
Tissue: Body		Temperature: 22.4 C	

Frequency (GHz)	Actual Values		Target Values		Deviation (%)	
	Relative Permittivity	Conductivity	Relative Permittivity	Conductivity	Relative Permittivity	Conductivity
5.8	46.9055	6.2423	48.2	6	2.69	4.04

3.4	50.6871	3.1507
3.45		
3.5	50.5718	3.2574
3.55		
3.6	50.468	3.3625
3.65		
3.7	50.3686	3.4861
3.75		
3.8	50.1574	3.5887
3.85		
3.9	50.0748	3.6966
3.95		
4	49.9848	3.8160
4.05		
4.1	49.7847	3.9315
4.15		
4.2	49.6836	4.0591
4.25		
4.3	49.4895	4.1866
4.35		
4.4	49.3844	4.3221
4.45		
4.5	49.2946	4.4566
4.55		
4.6	49.0904	4.5936
4.65		
4.7	48.8914	4.7251
4.75		
4.8	48.6935	4.8561
4.85	48.5786	4.9237
4.9	48.5734	4.9946
4.95	48.4755	5.0560
5	48.3667	5.1259
5.05	48.2651	5.1938
5.1	48.0629	5.2528
5.15	48.0521	5.3300
5.2	47.9705	5.3976
5.25	47.8635	5.4684
5.3	47.765	5.5275
5.35	47.6753	5.6061
5.4	47.5878	5.6681
5.45	47.469	5.7450
5.5	47.478	5.8129
5.55	47.3923	5.8795
5.6	47.2913	5.9425
5.65	47.1931	6.0267
5.7	47.0983	6.0934
5.75	46.9891	6.1566
5.8	46.9055	6.2423
5.85	46.8125	6.3066
5.9	46.8254	6.3848

Requirement

Per IEEE 1528, Section 8.2.1, "System checks are performed prior to compliance tests and the results must always be within $\pm 10\%$ of the target value corresponding to the test frequency, liquid, and the source used. The target values are 1 g or 10 g averaged SAR values measured on systems having current system validation and calibration status, and using the system check setup as shown in Figure 14. These target values should be determined using a standard source."

Test Description

Prior to testing every day, Northwest EMC used the system validation kit (calibrated reference dipole) to test whether the system was operating within its specifications. The validation was performed in the indicated bands by making SAR measurements of the reference dipole with the phantom filled with the tissue-equivalent liquid. First, a signal generator and power amplifier were used to produce a 100mW level as measured with a power meter at the antenna terminals of the dipole. Then, the reference dipole was positioned below the bottom of the phantom and centered with its axis parallel to the longest side of the phantom. A low loss and low relative permittivity spacer was used to establish the correct distance between the center axis of the reference dipole and the liquid.

For the reference dipoles, the spacing distance s is given by:

$$s = 15\text{mm}, \pm 0.2\text{mm for } 300\text{MHz} \leq f \leq 1000 \text{ MHz:}$$

$$s = 10\text{mm}, \pm 0.2\text{mm for } 1000\text{MHz} \leq f \leq 6000\text{MHz}$$

The measured 1 g and 10 g spatial average SAR values were normalized to a 1W dipole input power for comparison to the calibration data. The results are summarized in the attached table. The deviation is less than 10% in all cases, indicating that the system performance check was within tolerance.

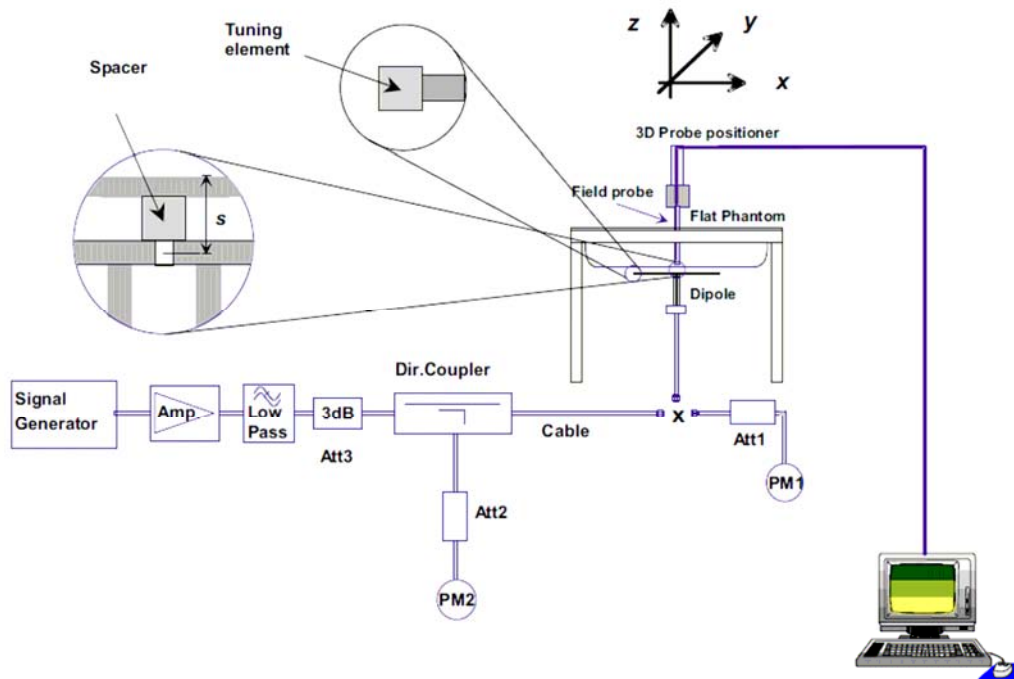

System Performance Check

EUT: System Performance Check		Work Order: INMC0570
Serial Number: Various		Date: See Below
Customer: Intermec Technologies Corporation		Temperature: See Below
Attendees: None		Humidity: See Below
Project: None		Barometric Pres.: 1014-1035.5mb
Tested by: Jennifer Herrett and Mark Baytan		Job Site: EV08
TEST SPECIFICATIONS		Test Method
FCC 2.1093:2011		FCC OET 65C:2001
COMMENTS		
None		
DEVIATIONS FROM TEST STANDARD		
None		
Configuration #	None	Signature <i>Jennifer Herrett</i>

Date	Frequency (MHz)	Tissue Type	Simulated Tissue		Measured (Actual)		Measured (Normalized to 1W)**		Target		Deviation (%)	
			Temp (C)	Depth (cm)	SAR (1 g)	SAR (10 g)	SAR (1 g)	SAR (10 g)	SAR (1 g)	SAR (10 g)	SAR (1 g)	SAR (10 g)
1/14/2011	2450	MSL2540	21.9	15	5.01	2.28	50.10	22.80	51.50	23.90	2.79	4.82
1/17/2011	2450	MSL2540	22.1	15	5.12	2.39	51.20	23.90	51.50	23.90	0.59	0.00
1/18/2011	2450	MSL2540	22.3	15	3.50	1.60	55.56	25.40	51.50	23.90	7.31	5.91
1/21/2011	2450	HSL2450	22.7	15	5.35	2.44	53.50	24.40	53.40	24.70	0.19	1.23
1/24/2011	5800	HSL501	22.6	15	6.97	2.00	87.78	25.19	82.90	23.30	5.56	7.50
1/25/2011	5500	HSL501	22.3	15	8.31	2.35	83.10	23.50	89.30	25.00	7.46	6.38
1/25/2011	5800	HSL501	22.3	15	7.02	2.00	76.90	21.90	82.90	23.30	7.80	6.39
1/26/2011	5200	HSL501	23.0	15	9.05	2.50	90.50	25.00	83.80	23.60	7.40	5.60
1/28/2011	5200	HSL501	22.4	15	9.19	2.55	91.90	25.50	83.80	23.60	8.81	7.45
1/30/2011	5500	MSL501	21.7	15	8.74	2.48	87.40	24.80	89.30	25.00	2.17	0.81
1/30/2011	5200	MSL501	21.4	15	9.06	2.57	90.60	25.70	83.80	23.60	7.51	8.17
1/31/2011	5200	MSL501	22.4	15	7.80	2.23	78.00	22.30	83.80	23.60	7.44	5.83

** Measured SAR Values normalized for the 1 W based on the actual input power used.

Room Temperature (°C):	22	Liquid Temperature (°C):	21.9	Humidity (%):	43	Test Date:	01/14/11
------------------------	----	--------------------------	------	---------------	----	------------	----------

MSL2450 SystemPerformanceCheck 1-14-11

DUT: Dipole 2450 MHz D2450V2; Type: D2450V2; Serial: D2450V2 - SN:855

Communication System: CW; Communication System Band: D2450 (2450.0 MHz); Frequency: 2450 MHz; Communication System PAR: 0 dB

Medium parameters used: $f = 2450$ MHz; $\sigma = 1.963$ mho/m; $\epsilon_r = 50.512$; $\rho = 1000$ kg/m³

Phantom section: Flat Section

Measurement Standard: DASYS (IEEE/IEC/ANSI C63.19-2007)

DASY5 Configuration:

Probe: EX3DV4 - SN3746; ConvF(6.81, 6.81, 6.81); Calibrated: 11/11/2010

Modulation Compensation: Not Used

Sensor-Surface: 3mm (Mechanical Surface Detection)

Electronics: DAE4 Sn1237; Calibrated: 11/10/2010

Phantom: ELI 4.0; Type: QDOVA001BA; Serial: 1096

Measurement SW: DASY52, Version 52.6 (1); SEMCAD X Version 14.4.2 (2595)

System Performance Check/d=15mm, Pin=20.0 dBm, dist=3.0mm (ES-Probe)/Zoom Scan (7x7x7) (7x7x7)/Cube 0: Measurement grid: dx=5mm, dy=5mm, dz=5mm

Reference Value = 53.318 V/m; Power Drift = -0.17 dB

Peak SAR (extrapolated) = 10.592 W/kg

SAR(1 g) = 5.01 mW/g; SAR(10 g) = 2.28 mW/g

Maximum value of SAR (measured) = 6.638 mW/g

System Performance Check/d=15mm, Pin=20.0 dBm, dist=3.0mm (ES-Probe)/Area Scan (61x81x1): Measurement grid: dx=15mm, dy=15mm

Maximum value of SAR (interpolated) = 6.718 mW/g

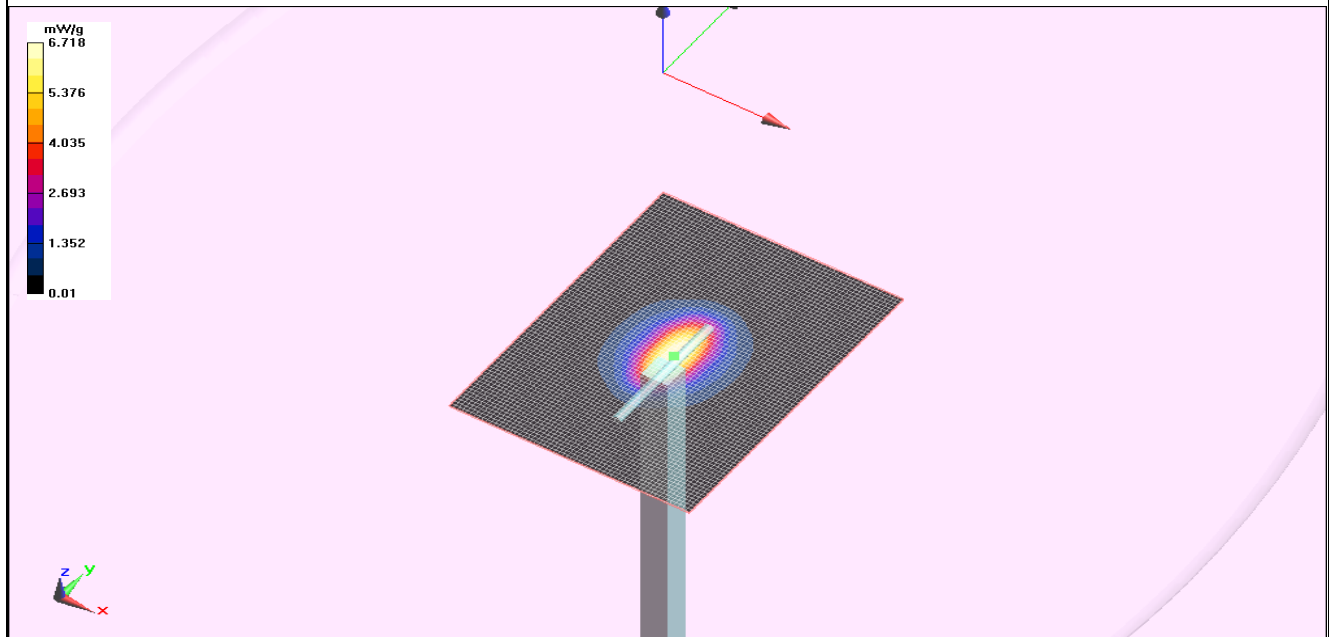

Room Temperature (°C):	22	Liquid Temperature (°C):	22.1	Humidity (%):	50	Test Date:	01/17/11
------------------------	----	--------------------------	------	---------------	----	------------	----------

MSL2450 SystemPerformanceCheck 1-17-11

DUT: Dipole 2450 MHz D2450V2; Type: D2450V2; Serial: D2450V2 - SN:855

Communication System: CW; Communication System Band: D2450 (2450.0 MHz); Frequency: 2450 MHz; Communication System PAR: 0 dB

Medium parameters used: $f = 2450$ MHz; $\sigma = 1.975$ mho/m; $\epsilon_r = 50.676$; $\rho = 1000$ kg/m³

Phantom section: Flat Section

Measurement Standard: DASYS (IEEE/IEC/ANSI C63.19-2007)

DASY5 Configuration:

Probe: EX3DV4 - SN3746; ConvF(6.81, 6.81, 6.81); Calibrated: 11/11/2010

Modulation Compensation: Not Used

Sensor-Surface: 3mm (Mechanical Surface Detection)

Electronics: DAE4 Sn1237; Calibrated: 11/10/2010

Phantom: ELI 4.0; Type: QDOVA001BA; Serial: 1096

Measurement SW: DASY52, Version 52.6 (1); SEMCAD X Version 14.4.2 (2595)

System Performance Check/d=15mm, Pin=20.0 dBm, dist=3.0mm (ES-Probe)/Zoom Scan (7x7x7) (7x7x7)/Cube 0: Measurement grid: dx=5mm, dy=5mm, dz=5mm

Reference Value = 59.037 V/m; Power Drift = 0.03 dB

Peak SAR (extrapolated) = 10.398 W/kg

SAR(1 g) = 5.12 mW/g; SAR(10 g) = 2.39 mW/g

Maximum value of SAR (measured) = 5.868 mW/g

System Performance Check/d=15mm, Pin=20.0 dBm, dist=3.0mm (ES-Probe)/Area Scan (61x81x1): Measurement grid: dx=15mm, dy=15mm

Maximum value of SAR (interpolated) = 6.905 mW/g

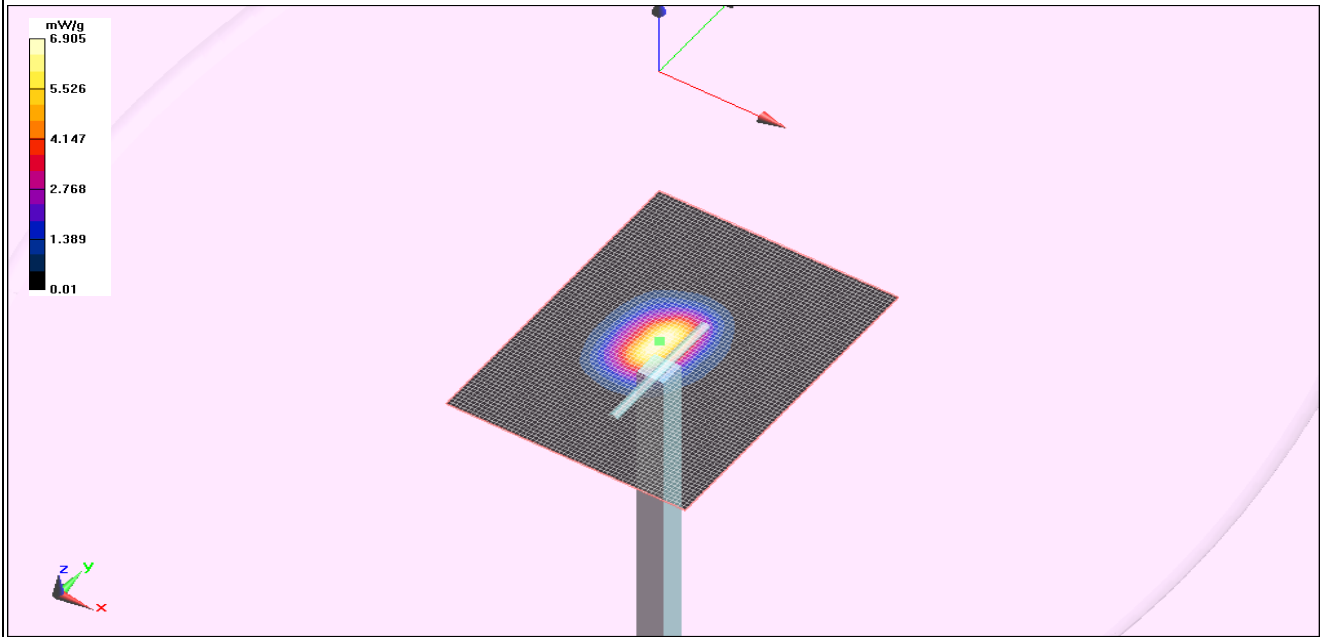

Room Temperature (°C):	22	Liquid Temperature (°C):	22.3	Humidity (%):	38	Test Date:	01/18/11
------------------------	----	--------------------------	------	---------------	----	------------	----------

MSL2450 SystemPerformanceCheck-d 1-18-11

DUT: Dipole 2450 MHz D2450V2; Type: D2450V2; Serial: D2450V2 - SN:855

Communication System: CW; Communication System Band: D2450 (2450.0 MHz); Frequency: 2450 MHz; Communication System PAR: 0 dB

Medium parameters used: $f = 2450$ MHz; $\sigma = 2.008$ mho/m; $\epsilon_r = 50.483$; $\rho = 1000$ kg/m³

Phantom section: Flat Section

Measurement Standard: DASYS (IEEE/IEC/ANSI C63.19-2007)

DASY5 Configuration:

Probe: EX3DV4 - SN3746; ConvF(6.81, 6.81, 6.81); Calibrated: 11/11/2010

Modulation Compensation: Not Used

Sensor-Surface: 3mm (Mechanical Surface Detection)

Electronics: DAE4 Sn1237; Calibrated: 11/10/2010

Phantom: ELI 4.0; Type: QDOVA001BA; Serial: 1096

Measurement SW: DASY52, Version 52.6 (1); SEMCAD X Version 14.4.2 (2595)

System Performance Check/d=15mm, Pin=20.0 dBm, dist=3.0mm (ES-Probe)/Zoom Scan (7x7x7) (7x7x7)/Cube 0: Measurement grid: dx=5mm, dy=5mm, dz=5mm

Reference Value = 49.456 V/m; Power Drift = -0.23 dB

Peak SAR (extrapolated) = 7.358 W/kg

SAR(1 g) = 3.5 mW/g; SAR(10 g) = 1.6 mW/g

Maximum value of SAR (measured) = 3.982 mW/g

System Performance Check/d=15mm, Pin=20.0 dBm, dist=3.0mm (ES-Probe)/Area Scan (61x81x1): Measurement grid: dx=15mm, dy=15mm

Maximum value of SAR (interpolated) = 4.771 mW/g

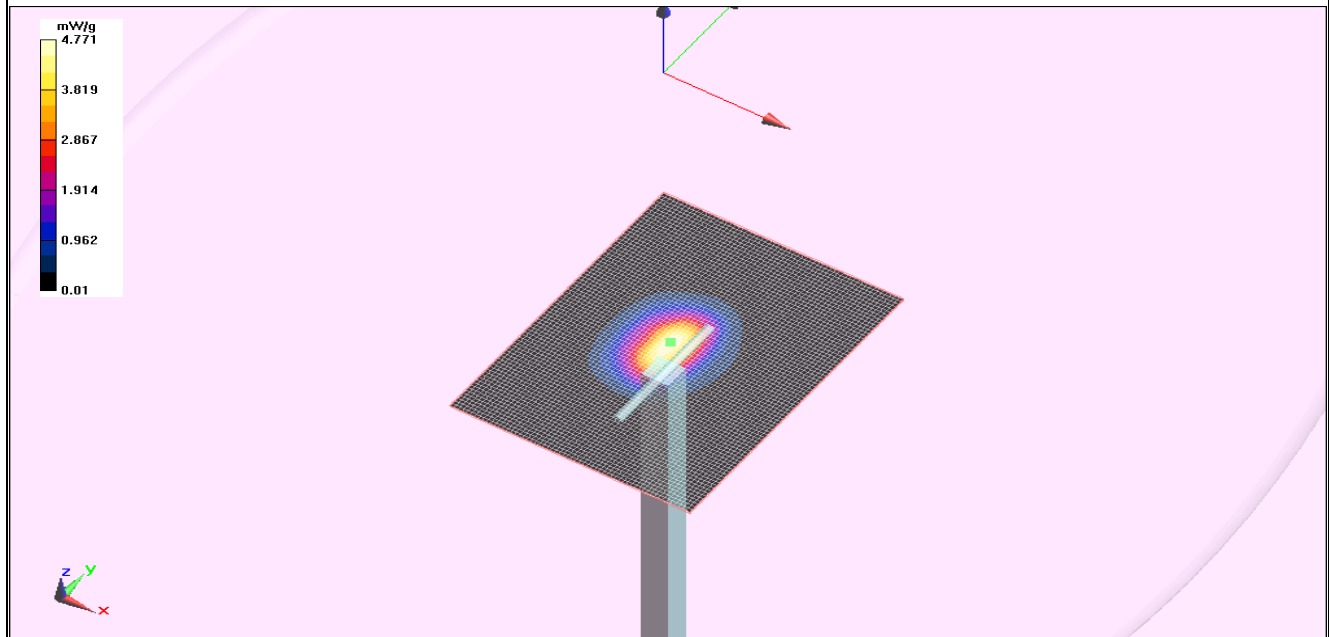

Room Temperature (°C):	23	Liquid Temperature (°C):	22.7	Humidity (%):	43	Test Date:	01/21/11
------------------------	----	--------------------------	------	---------------	----	------------	----------

HSL2450 SystemPerformanceCheck_1-21-11c

DUT: Dipole 2450 MHz D2450V2; Type: D2450V2; Serial: D2450V2 - SN:855

Communication System: CW; Communication System Band: D2450 (2450.0 MHz); Frequency: 2450 MHz; Communication System PAR: 0 dB

Medium parameters used: $f = 2450$ MHz; $\sigma = 1.876$ mho/m; $\epsilon_r = 38.792$; $\rho = 1000$ kg/m³

Phantom section: Flat Section

Measurement Standard: DASYS (IEEE/IEC/ANSI C63.19-2007)

DASY5 Configuration:

Probe: EX3DV4 - SN3746; ConvF(6.69, 6.69, 6.69); Calibrated: 11/11/2010

Modulation Compensation: Not Used

Sensor-Surface: 3mm (Mechanical Surface Detection)

Electronics: DAE4 Sn1237; Calibrated: 11/10/2010

Phantom: SAM with CRP; Type: QD 00 P40 CC; Serial: 1598

Measurement SW: DASY52, Version 52.6 (1); SEMCAD X Version 14.4.2 (2595)

System Performance Check/d=15mm, Pin=20.0 dBm, dist=3.0mm (ES-Probe)/Zoom Scan (7x7x7) (7x7x7)/Cube 0: Measurement grid: dx=5mm, dy=5mm, dz=5mm

Reference Value = 63.298 V/m; Power Drift = -0.30 dB

Peak SAR (extrapolated) = 11.632 W/kg

SAR(1 g) = 5.35 mW/g; SAR(10 g) = 2.44 mW/g

Maximum value of SAR (measured) = 6.058 mW/g

System Performance Check/d=15mm, Pin=20.0 dBm, dist=3.0mm (ES-Probe)/Area Scan (61x81x1): Measurement grid: dx=15mm, dy=15mm

Maximum value of SAR (interpolated) = 7.397 mW/g

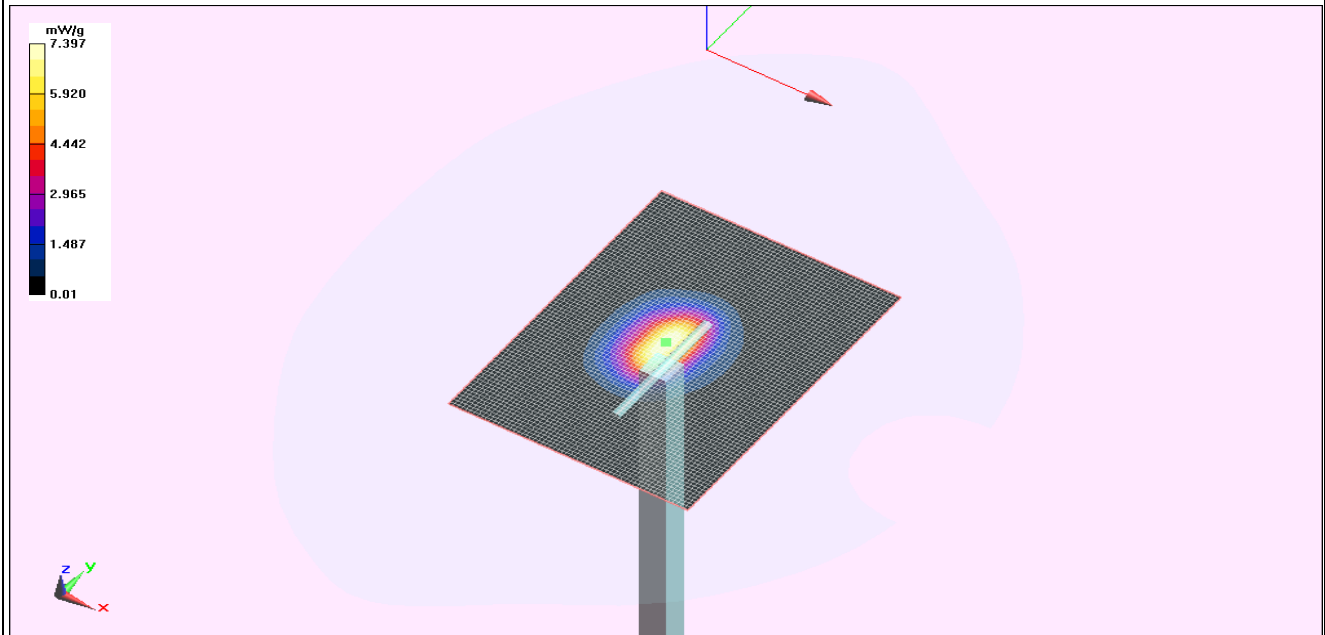

Room Temperature (°C):	20	Liquid Temperature (°C):	22.6	Humidity (%):	39	Test Date:	01/24/11
------------------------	----	--------------------------	------	---------------	----	------------	----------

HSL501 System Performance Check DASYS2_1-24-11b 5800MHz

DUT: Dipole D5GHzV2; Type: D5GHzV2; Serial: D5GHzV2 - SN:xxx

Communication System: CW; Communication System Band: ITD5500 (5000.0 - 5900.0 MHz); Frequency: 5800 MHz; Communication System PAR: 0 dB

Medium parameters used: $f = 5800$ MHz; $\sigma = 5.462$ mho/m; $\epsilon_r = 36.596$; $\rho = 1000$ kg/m³

Phantom section: Flat Section

Measurement Standard: DASYS (IEEE/IEC/ANSI C63.19-2007)

DASY5 Configuration:

Probe: EX3DV4 - SN3746; ConvF(4.14, 4.14, 4.14); Calibrated: 11/11/2010

Modulation Compensation: Not Used

Sensor-Surface: 2mm (Mechanical Surface Detection)

Electronics: DAE4 Sn1237; Calibrated: 11/10/2010

Phantom: SAM with CRP; Type: SAM; Serial: 1598

Measurement SW: DASYS2, Version 52.6 (1); SEMCAD X Version 14.4.2 (2595)

System verification/System Verification /Zoom Scan (7x7x9)/Cube 0: Measurement grid: dx=4.3mm, dy=4.3mm, dz=3mm

Reference Value = 38.922 V/m; Power Drift = -0.03 dB

Peak SAR (extrapolated) = 29.328 W/kg

SAR(1 g) = 6.97 mW/g; SAR(10 g) = 2 mW/g

Maximum value of SAR (measured) = 14.936 mW/g

System verification/System Verification 1-20-11/Area Scan (61x81x1): Measurement grid: dx=10mm, dy=10mm

Maximum value of SAR (interpolated) = 10.693 mW/g

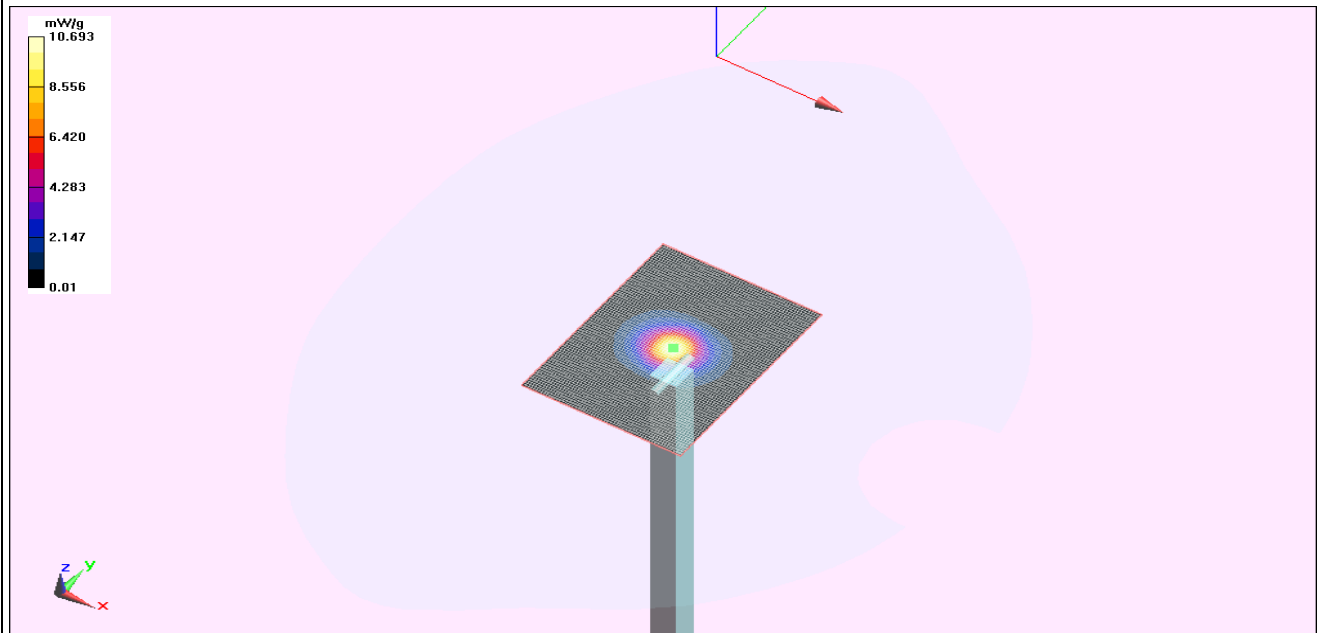

Room Temperature (°C):	20.8	Liquid Temperature (°C):	22.3	Humidity (%):	42	Test Date:	01/25/11
------------------------	------	--------------------------	------	---------------	----	------------	----------

HSL501 System Performance Check DASY52 1-25-11 5500MHz

DUT: Dipole D5GHzV2; Type: D5GHzV2; Serial: D5GHzV2 - SN:3746

Communication System: CW; Communication System Band: ITD5500 (5000.0 - 5900.0 MHz); Frequency: 5500 MHz; Communication System PAR: 0 dB
Medium parameters used: $f = 5500$ MHz; $\sigma = 5.128$ mho/m; $\epsilon_r = 36.828$; $\rho = 1000$ kg/m³

Phantom section: Flat Section

Measurement Standard: DASY5 (IEEE/IEC/ANSI C63.19-2007)

DASY5 Configuration:

Probe: EX3DV4 - SN3746; ConvF(4.37, 4.37, 4.37); Calibrated: 11/11/2010

Modulation Compensation: Not Used

Sensor-Surface: 2mm (Mechanical Surface Detection)

Electronics: DAE4 Sn1237; Calibrated: 11/10/2010

Phantom: SAM with CRP; Type: SAM; Serial:1598

Measurement SW: DASY52, Version 52.6 (1); SEMCAD X Version 14.4.2 (2595)

System verification/System Verification/Zoom Scan (7x7x9)/Cube 0: Measurement grid: dx=4.3mm, dy=4.3mm, dz=3mm

Reference Value = 40.408 V/m; Power Drift = 0.16 dB

Peak SAR (extrapolated) = 34.009 W/kg

SAR(1 g) = 8.31 mW/g; SAR(10 g) = 2.35 mW/g

Maximum value of SAR (measured) = 17.571 mW/g

System verification/System Verification 1-25-11/Area Scan (61x81x1): Measurement grid: dx=10mm, dy=10mm

Maximum value of SAR (interpolated) = 14.027 mW/g

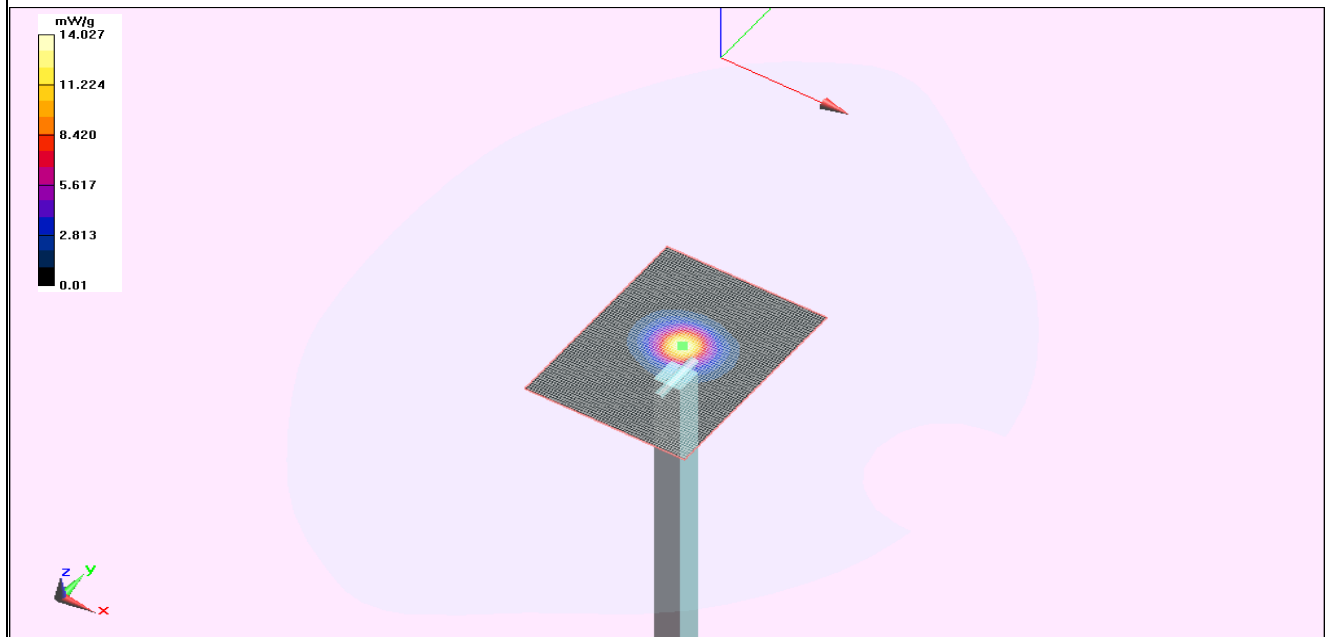

Room Temperature (°C): 20.8

Liquid Temperature (°C): 22.3

Humidity (%): 42

Test Date: 01/25/11

HSL501 System Performance Check DASY52 1-25-11

DUT: Dipole D5GHzV2; Type: D5GHzV2; Serial: D5GHzV2 -

Communication System: CW; Communication System Band: ITD5500 (5000.0 - 5900.0 MHz); Frequency: 5800 MHz; Communication System PAR: 0 dB

Medium parameters used: $f = 5800$ MHz; $\sigma = 5.478$ mho/m; $\epsilon_r = 36.32$; $\rho = 1000$ kg/m³

Phantom section: Flat Section

Measurement Standard: DASY5 (IEEE/IEC/ANSI C63.19-2007)

DASY5 Configuration:

Probe: EX3DV4 - SN3746; ConvF(4.14, 4.14, 4.14); Calibrated: 11/11/2010

Modulation Compensation: Not Used

Sensor-Surface: 2mm (Mechanical Surface Detection),

Electronics: DAE4 Sn1237; Calibrated: 11/10/2010

Phantom: SAM with CRP; Type: SAM; Serial:1598

Measurement SW: DASY52, Version 52.6 (1); SEMCAD X Version 14.4.2 (2595)

System verification/System Verification 1-20-11/Zoom Scan (7x7x9)/Cube 0: Measurement grid: dx=4.3mm, dy=4.3mm, dz=3mm

Reference Value = 38.829 V/m; Power Drift = -0.06 dB

Peak SAR (extrapolated) = 30.156 W/kg

SAR(1 g) = 7.02 mW/g; SAR(10 g) = 2 mW/g

Maximum value of SAR (measured) = 15.087 mW/g

System verification/System Verification 1-20-11/Area Scan (61x81x1): Measurement grid: dx=10mm, dy=10mm

Maximum value of SAR (interpolated) = 10.774 mW/g

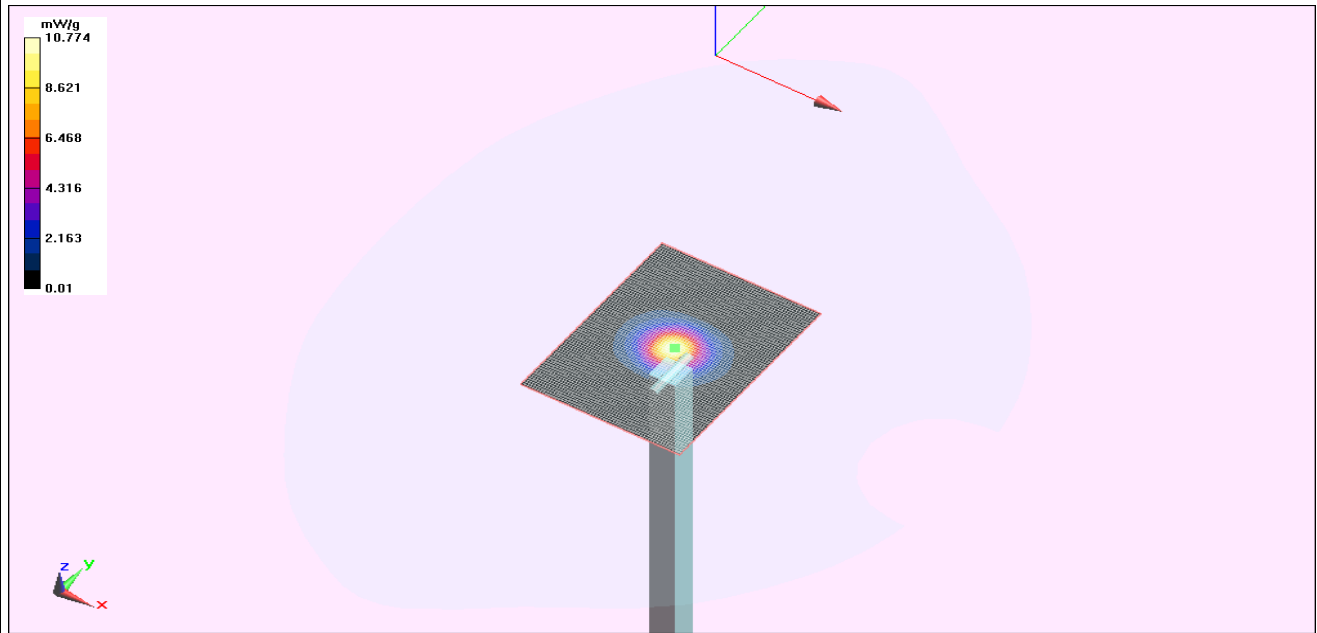

Room Temperature (°C):	23	Liquid Temperature (°C):	23	Humidity (%):	42	Test Date:	01/26/11
------------------------	----	--------------------------	----	---------------	----	------------	----------

HSL501 System Performance Check DASY52 1-26-11 5200MHz

DUT: Dipole D5GHzV2; Type: D5GHzV2; Serial: D5GHzV2 - SN: 3746

Communication System: CW; Communication System Band: ITD5500 (5000.0 - 5900.0 MHz); Frequency: 5200 MHz; Communication System PAR: 0 dB

Medium parameters used: $f = 5200$ MHz; $\sigma = 4.786$ mho/m; $\epsilon_r = 37.359$; $\rho = 1000$ kg/m³

Phantom section: Flat Section

Measurement Standard: DASY5 (IEEE/IEC/ANSI C63.19-2007)

DASY5 Configuration:

Probe: EX3DV4 - SN3746; ConvF(5.08, 5.08, 5.08); Calibrated: 11/11/2010

Modulation Compensation: Not Used

Sensor-Surface: 2mm (Mechanical Surface Detection)

Electronics: DAE4 Sn1237; Calibrated: 11/10/2010

Phantom: SAM with CRP; Type: SAM; Serial:1598

Measurement SW: DASY52, Version 52.6 (1); SEMCAD X Version 14.4.2 (2595)

System verification/System Verification /Zoom Scan (7x7x9)/Cube 0: Measurement grid: dx=4.3mm, dy=4.3mm, dz=3mm

Reference Value = 42.955 V/m; Power Drift = -0.09 dB

Peak SAR (extrapolated) = 50.517 W/kg

SAR(1 g) = 9.05 mW/g; SAR(10 g) = 2.5 mW/g

Maximum value of SAR (measured) = 8.694 mW/g

System verification/System Verification 1-25-11/Area Scan (61x81x1): Measurement grid: dx=10mm, dy=10mm

Maximum value of SAR (interpolated) = 12.043 mW/g

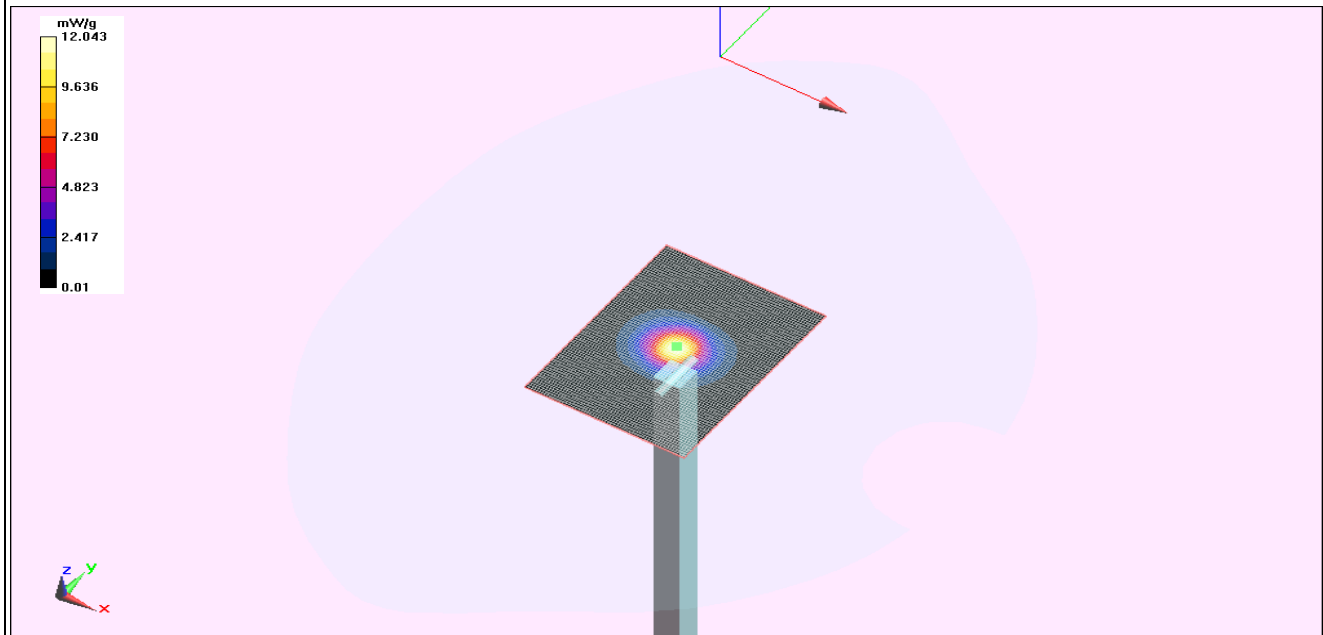

Room Temperature (°C):	22.4	Liquid Temperature (°C):	22.4	Humidity (%):	39	Test Date:	01/28/11
------------------------	------	--------------------------	------	---------------	----	------------	----------

HSL501 System Performance Check DASY52 5200MHz 1-28-11

DUT: Dipole D5GHzV2; Type: D5GHzV2; Serial: D5GHzV2

Communication System: CW; Communication System Band: ITD5500 (5000.0 - 5900.0 MHz); Frequency: 5200 MHz; Communication System PAR: 0 dB
 Medium parameters used: $f = 5200$ MHz; $\sigma = 4.752$ mho/m; $\epsilon_r = 35.273$; $\rho = 1000$ kg/m³

Phantom section: Flat Section

Measurement Standard: DASY5 (IEEE/IEC/ANSI C63.19-2007)

DASY5 Configuration:

Probe: EX3DV4 - SN3746; ConvF(5.08, 5.08, 5.08); Calibrated: 11/11/2010

Modulation Compensation: Not Used

Sensor-Surface: 4mm (Mechanical Surface Detection), Sensor-Surface: 3mm (Mechanical Surface Detection)

Electronics: DAE4 Sn1237; Calibrated: 11/10/2010

Phantom: SAM with CRP; Type: SAM; Serial:

Measurement SW: DASY52, Version 52.6 (1); SEMCAD X Version 14.4.2 (2595)

System verification/System Verification 1-20-11/Zoom Scan (7x7x7)/Cube 0: Measurement grid: dx=5mm, dy=5mm, dz=5mm

Reference Value = 43.538 V/m; Power Drift = -0.04 dB

Peak SAR (extrapolated) = 50.064 W/kg

SAR(1 g) = 9.19 mW/g; SAR(10 g) = 2.55 mW/g

Maximum value of SAR (measured) = 9.034 mW/g

System verification/System Verification 1-20-11/Area Scan (61x81x1): Measurement grid: dx=10mm, dy=10mm

Maximum value of SAR (interpolated) = 12.355 mW/g

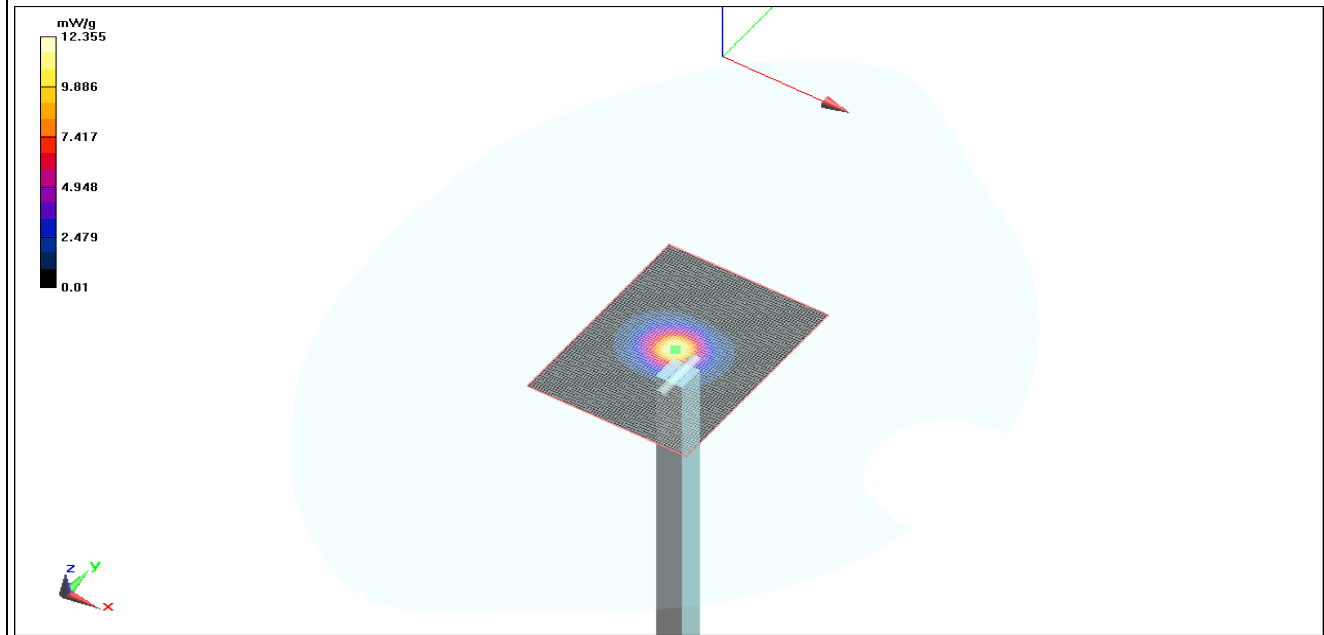

Room Temperature (°C):	22.2	Liquid Temperature (°C):	22.4	Humidity (%):	41	Test Date:	01/30/11
------------------------	------	--------------------------	------	---------------	----	------------	----------

MSL501 SystemPerformanceCheck 1-30-11 Verification

DUT: Dipole D5GHzV2; Type: D5GHzV2; Serial: D5GHzV2

Communication System: CW; Communication System Band: D5GHz (5000.0 - 6000.0 MHz); Frequency: 5500 MHz; Communication System PAR: 0 dB

Medium parameters used: $f = 5500$ MHz; $\sigma = 6.07$ mho/m; $\epsilon_r = 46$; $\rho = 1000$ kg/m³, Medium parameters used: $\sigma = 6.07$ mho/m, $\epsilon_r = 46$; $\rho = 1000$ kg/m³

Phantom section: Flat Section

Measurement Standard: DASYS (IEEE/IEC/ANSI C63.19-2007)

DASY5 Configuration:

Probe: EX3DV4 - SN3746; ConvF(3.87, 3.87, 3.87); Calibrated: 11/11/2010

Modulation Compensation: Not Used

Sensor-Surface: 2mm (Mechanical Surface Detection)

Electronics: DAE4 Sn1237; Calibrated: 11/10/2010

Phantom: ELI 4.0; Type: QDOVA001BA; Serial: xxxx

Measurement SW: DASY52, Version 52.6 (1); SEMCAD X Version 14.4.2 (2595)

System verification/System Verification /Zoom Scan (7x7x9)/Cube 0: Measurement grid: dx=4.3mm, dy=4.3mm, dz=3mm

Reference Value = 47.990 V/m; Power Drift = 0.12 dB

Peak SAR (extrapolated) = 33.397 W/kg

SAR(1 g) = 8.74 mW/g; SAR(10 g) = 2.48 mW/g

Maximum value of SAR (measured) = 18.890 mW/g

System Performance Check/d=15mm, Pin=20.0 dBm, dist=3.0mm (ES-Probe)/Area Scan (81x81x1): Measurement grid: dx=10mm, dy=10mm

Maximum value of SAR (interpolated) = 17.711 mW/g

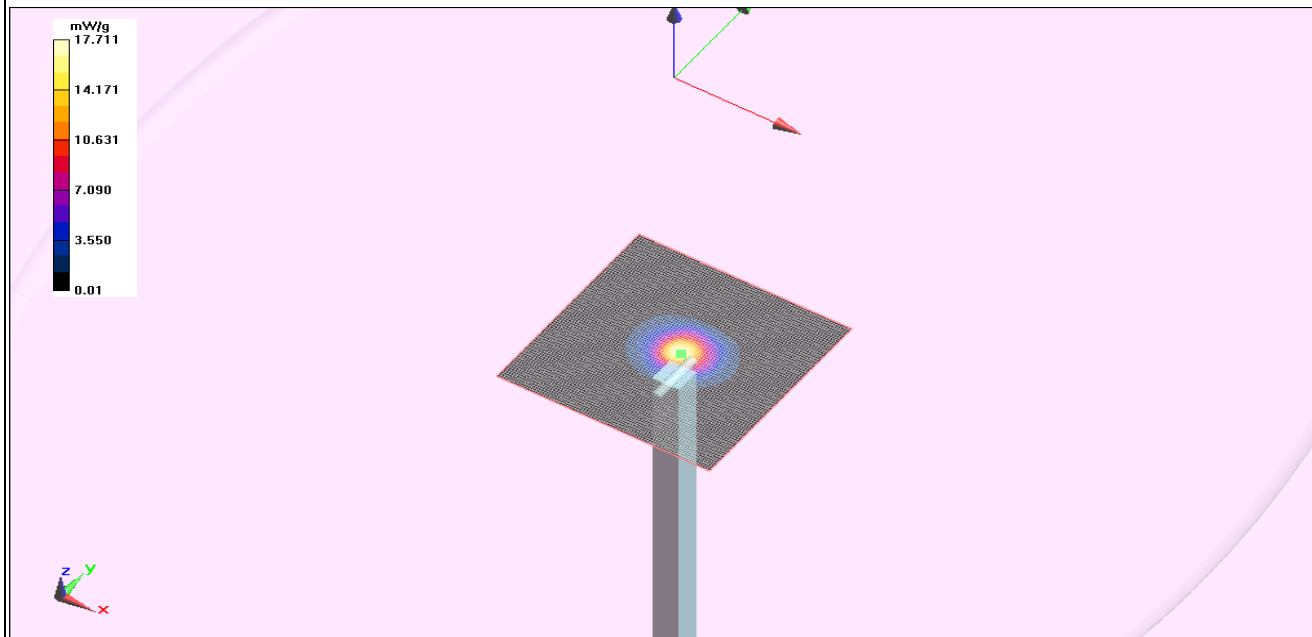

Room Temperature (°C):	24.3	Liquid Temperature (°C):	21.4	Humidity (%):	24	Test Date:	01/30/11
------------------------	------	--------------------------	------	---------------	----	------------	----------

MSL501 SystemPerformanceCheck @ 5200 1-30-11 Verification

DUT: Dipole D5GHzV2; Type: D5GHzV2; Serial: D5GHzV2 - SN:1066

Communication System: CW; Communication System Band: D5GHz (5000.0 - 6000.0 MHz); Frequency: 5200 MHz; Communication System PAR: 0 dB
Medium parameters used: $f = 5200$ MHz; $\sigma = 6.07$ mho/m; $\epsilon_r = 46$; $\rho = 1000$ kg/m³, Medium parameters used: $\sigma = 6.07$ mho/m, $\epsilon_r = 46$; $\rho = 1000$ kg/m³

Phantom section: Flat Section

Measurement Standard: DASYS (IEEE/IEC/ANSI C63.19-2007)

DASY5 Configuration:

Probe: EX3DV4 - SN3746; ConvF(3.87, 3.87, 3.87); Calibrated: 11/11/2010

Modulation Compensation: Not Used

Sensor-Surface: 2mm (Mechanical Surface Detection)

Electronics: DAE4 Sn1237; Calibrated: 11/10/2010

Phantom: ELI 4.0; Type: QDOVA001BA; Serial: 1096

Measurement SW: DASY52, Version 52.6 (1); SEMCAD X Version 14.4.2 (2595)

System verification/System Verification /Zoom Scan (7x7x9)/Cube 0: Measurement grid: dx=4.3mm, dy=4.3mm, dz=3mm

Reference Value = 51.278 V/m; Power Drift = -0.03 dB

Peak SAR (extrapolated) = 33.864 W/kg

SAR(1 g) = 9.06 mW/g; SAR(10 g) = 2.57 mW/g

Maximum value of SAR (measured) = 19.189 mW/g

System Performance Check/d=15mm, Pin=20.0 dBm, dist=3.0mm (ES-Probe)/Area Scan (81x81x1): Measurement grid: dx=10mm, dy=10mm

Maximum value of SAR (interpolated) = 19.055 mW/g

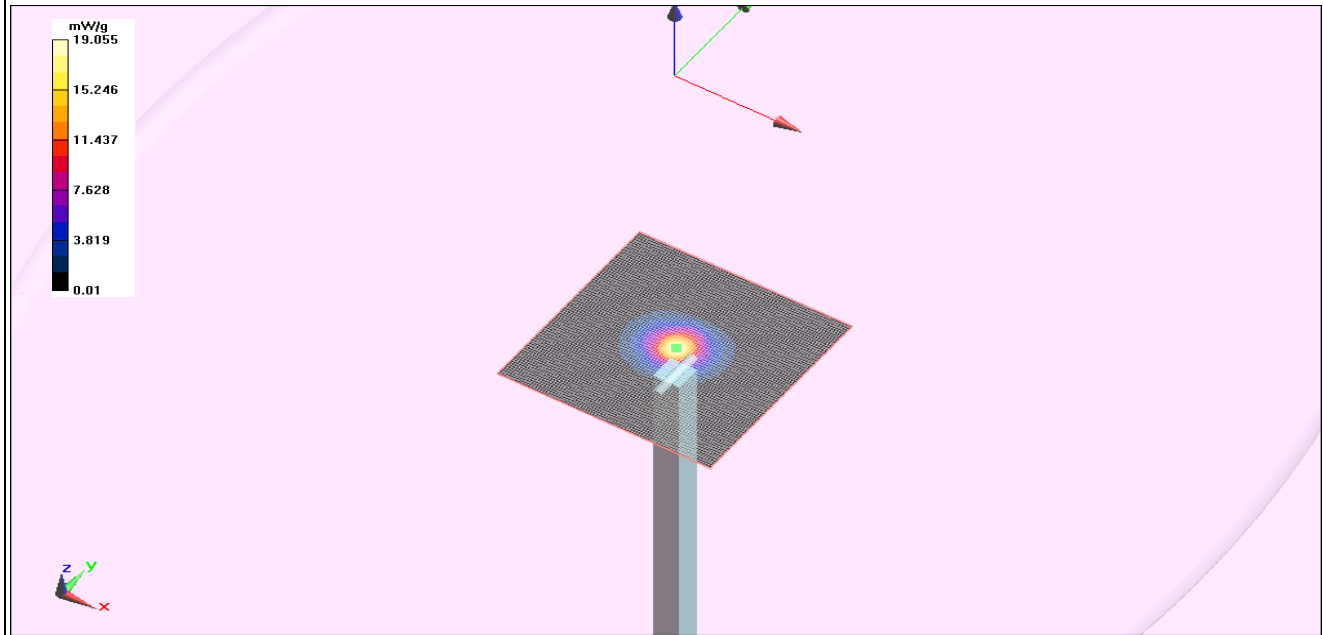

Room Temperature (°C):	24.5	Liquid Temperature (°C):	22.4	Humidity (%):	31.6	Test Date:	01/31/11
------------------------	------	--------------------------	------	---------------	------	------------	----------

MSL501 SystemPerformanceCheck 1-31-11 5200MHz

DUT: Dipole D5GHzV2; Type: D5GHzV2; Serial: D5GHzV2

Communication System: CW; Communication System Band: D5GHz (5000.0 - 6000.0 MHz); Frequency: 5200 MHz; Communication System PAR: 0 dB
 Medium parameters used: $f = 5200$ MHz; $\sigma = 5.398$ mho/m; $\epsilon_r = 47.136$; $\rho = 1000$ kg/m³, Medium parameters used: $\sigma = 5.39757$ mho/m, $\epsilon_r = 47.1358$; $\rho = 1000$ kg/m³
 Phantom section: Flat Section
 Measurement Standard: DASYS5 (IEEE/IEC/ANSI C63.19-2007)

DASY5 Configuration:

Probe: EX3DV4 - SN3746; ConvF(4.16, 4.16, 4.16); Calibrated: 11/11/2010
 Modulation Compensation: Not Used
 Sensor-Surface: 2mm (Mechanical Surface Detection)
 Electronics: DAE4 Sn1237; Calibrated: 11/10/2010
 Phantom: ELI 4.0; Type: QDOVA001BA; Serial:
 Measurement SW: DASYS2, Version 52.6 (1); SEMCAD X Version 14.4.2 (2595)

System Performance Check/d=15mm, Pin=20.0 dBm, dist=3.0mm (ES-Probe)/Zoom Scan (7x9x7) (7x7x9)/Cube 0: Measurement grid: dx=4mm, dy=4mm, dz=2.5mm
 Reference Value = 49.365 V/m; Power Drift = 0.11 dB
 Peak SAR (extrapolated) = 28.707 W/kg
SAR(1 g) = 7.8 mW/g; SAR(10 g) = 2.23 mW/g
 Maximum value of SAR (measured) = 16.140 mW/g

System Performance Check/d=15mm, Pin=20.0 dBm, dist=3.0mm (ES-Probe)/Z Scan (1x1x21): Measurement grid: dx=20mm, dy=20mm, dz=5mm
 Maximum value of Total (measured) = 50.081 V/m

System Performance Check/d=15mm, Pin=20.0 dBm, dist=3.0mm (ES-Probe)/Area Scan (51x61x1): Measurement grid: dx=10mm, dy=10mm
 Maximum value of SAR (interpolated) = 16.453 mW/g

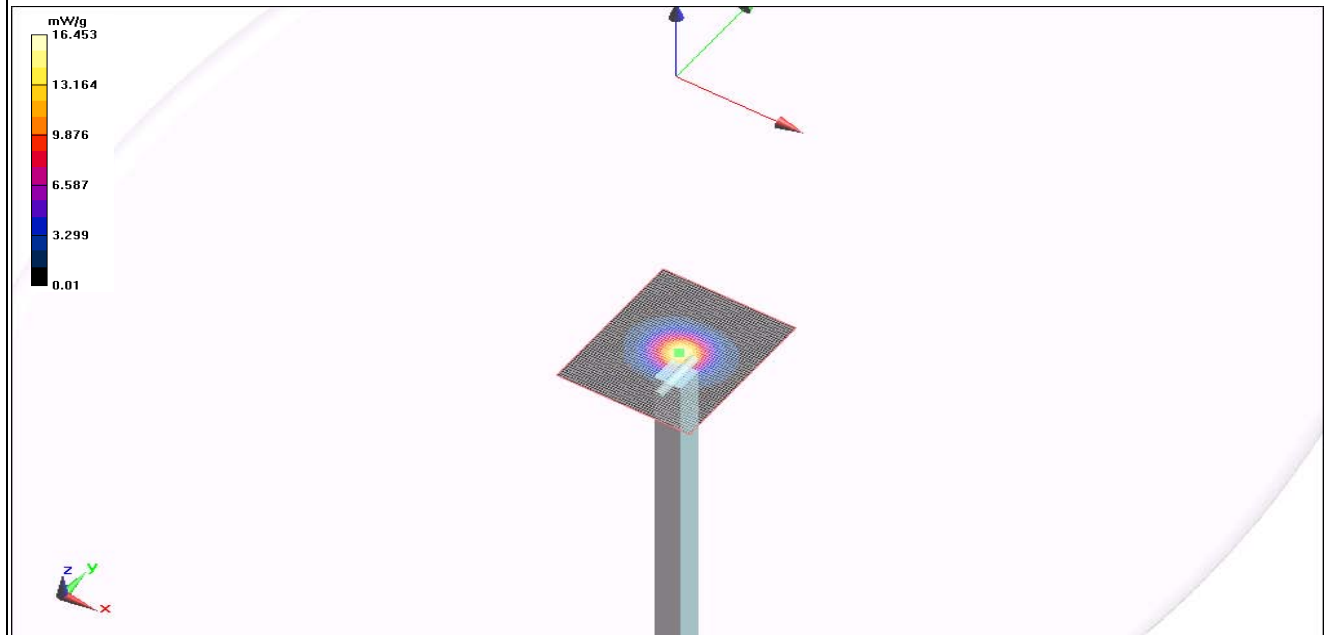

Test Configurations

In normal operation, the EUT can be held in the hand, or next to the head like a cellular handset, or worn on the body. The only Intermec approved accessory for body worn operation is a holster that contains metal. The EUT can only fit in the holster with the top end of the unit pointing down. The holster cup can be attached to the holster belt with either the keypad facing the user, or the side facing the user. In no case can the back of the EUT face the user. For body worn operation, the keypad side was tested. The holster provides 1.5 cm spacing from the keypad side to the flat phantom.

The 802.11a/b/g/n antenna is on the right side of the EUT. Preliminary testing showed the SAR distribution to be localized to the antenna so for body worn operation, the right side was also tested. The holster provides 1.2 cm spacing from the right side to the flat phantom.

An optional snap-on audio accessory is available. It connects to the bottom end of the unit and provides a standard audio jack for connection of a VR10 headset. Measurements were made with and without the headset. Its contribution to measured SAR was determined to be of no consequence.

The EUT is powered by a lithium-ion battery, Model 1000AB01. It was fully charged before each SAR evaluation.

Per KDB 648474, among the channels required for normal testing, SAR must be measured on the highest conducted output power channel in each band (see highlighted values in the Output Power section of this report). Since the measured SAR on the highest output channel is < 0.8 W/kg, SAR evaluation for the other required channels was not performed (reference also KDB 447498 Section 1(e))

All testing was performed with the EUT configured in a worst-case configuration and operating mode to produce the highest SAR levels. The EUT used Intermec test software that permitted the selection of transmit channel, modulation type, and data rate. It operated continuously at nearly 100% duty cycle.

Summary

The following tables summarize the measured SAR values.

EMC SAR TEST DATA

EUT: 1000CP01U	Work Order: INMC0570
Serial Number: 24411047012	Date: See Data Sheets
Customer: Intermec Technologies	Temperature: See Data Sheets
Attendees: None	Humidity: See Data Sheets
Project: INMC0570	Barometric Pres.: See Data Sheets
Tested by: Jennifer Herrett	Job Site: EV08

TEST SPECIFICATIONS	Test Method
FCC 2.1093:2011	FCC OET 65C:2001
FCC 15.247:2011	IEEE Std 1528:2003
FCC 15.407:2001	FCC KDB 447498 D01 v04
	FCC KDB 248227 D01 V01r02
	FCC KDB 648474 D01 V01r05
	FCC 865664
Health Safety Code 6:2009	RSS-102, Issue 4:2010

COMMENTS
None

DEVIATIONS FROM TEST STANDARD
No Deviations

Configuration #	1	<i>Signature</i>
------------------------	---	------------------

Test Configuration	Frequency Band	Form Factor	Transmit Frequency	Transmit Channel	Transmit Mode	Data Rate (Mbps)	EUT Position		Start Power (Conducted)	SAR Drift During Test (dB)	1g SAR Level	Test #
							Left Head	Right Head				
Head	2450	A1	2462MHz	Ch 11	BPSK	1Mbps	Touch	Tilt	16.7	-0.23	0.039	1
							Tilt	Touch	16.7	Note 2	0.034	2
							Touch	Tilt	16.7	Note 2	0.028	3
							Tilt	Tilt	16.7	Note 2	0.030	4

Note 1: Zoom scan not performed, no hot spots detected, area scan results were less than the required system sensitivity of 0.01 mW/g.
 Note 2: Due to the low value of measured SAR, the SAR drift measurement was made close to the measurement noise floor and is therefore inaccurate

2400MHz band Ch11 1Mbps Left Head A1 1-21-11

DUT: 1000CP01U Hand Held Computer; Type: CN70; Serial: 24411047012

Communication System: CW; Communication System Band: D2450 (2450.0 MHz); Frequency: 2462 MHz; Communication System PAR: 0 dB

Medium parameters used: $\sigma = 1.876$ mho/m, $\epsilon_r = 38.7918$; $\rho = 1000$ kg/m³, Medium parameters used (interpolated): $f = 2462$ MHz; $\sigma = 1.89$ mho/m; $\epsilon_r = 38.743$; $\rho = 1000$ kg/m³

Phantom section: Left Section

Measurement Standard: DASYS (IEEE/IEC/ANSI C63.19-2007)

DASYS Configuration:

Probe: EX3DV4 - SN3746; ConvF(6.69, 6.69, 6.69); Calibrated: 11/11/2010

Modulation Compensation: Not Used

Sensor-Surface: 3mm (Mechanical Surface Detection)

Electronics: DAE4 Sn1237; Calibrated: 11/10/2010

Phantom: SAM with CRP; Type: SAM QD 000 P40 CC; Serial: TP-1598

Measurement SW: DASYS2, Version 52.6 (1); SEMCAD X Version 14.4.2 (2595)

Left Head/Touch/Zoom Scan (7x7x7)/Cube 0: Measurement grid: dx=5mm, dy=5mm, dz=5mm

Reference Value = 3.755 V/m; Power Drift = -0.23 dB

Peak SAR (extrapolated) = 0.080 W/kg

SAR(1 g) = 0.039 mW/g; SAR(10 g) = 0.021 mW/g

Info: Interpolated medium parameters used for SAR evaluation.

Maximum value of SAR (measured) = 0.043 mW/g

Left Head/Touch/Area scan (81x131x1): Measurement grid: dx=15mm, dy=15mm

Info: Interpolated medium parameters used for SAR evaluation.

Maximum value of SAR (interpolated) = 0.051 mW/g

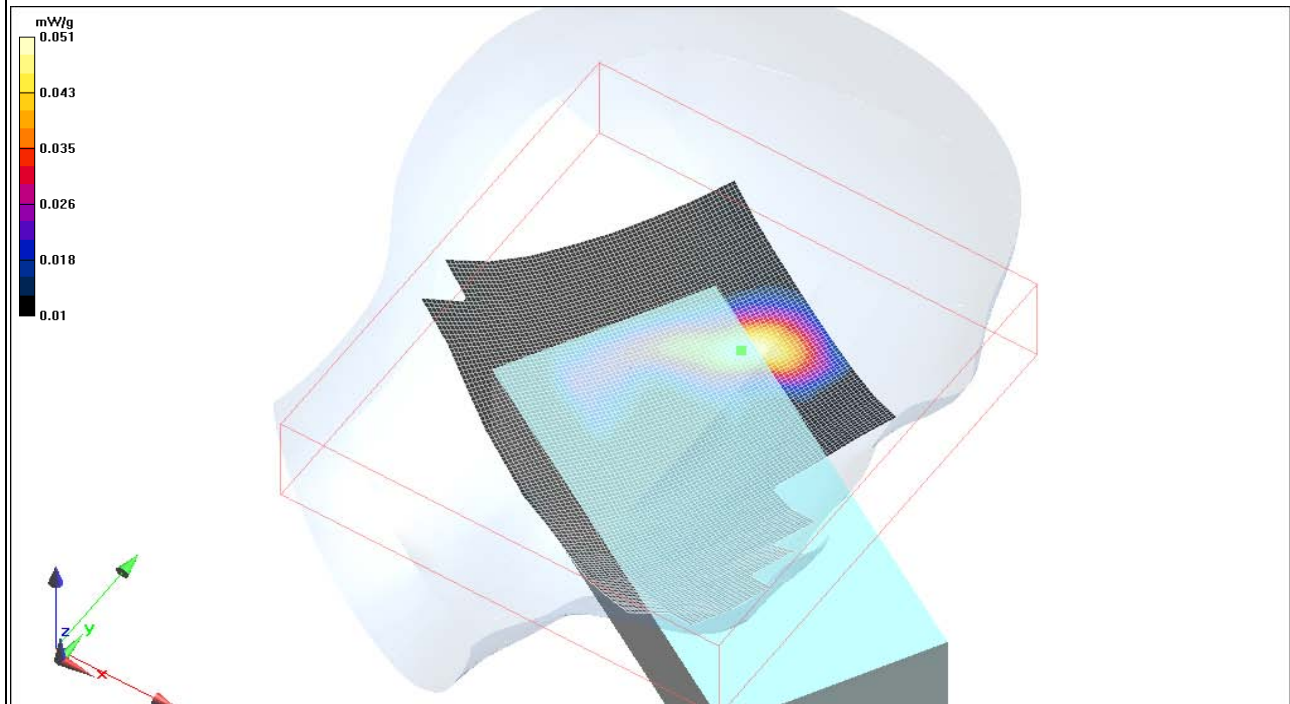

EMC

Room Temperature (°C):	23	Liquid Temperature (°C):	22.5	Humidity:	43	Test Date:	01/21/11
------------------------	----	--------------------------	------	-----------	----	------------	----------

DUT: 1000CP01U Hand Held Computer; Type: CN70; Serial: 24411047012

Communication System: CW; Communication System Band: D2450 (2450.0 MHz); Frequency: 2462 MHz; Communication System PAR: 0 dB

Medium parameters used: $\sigma = 1.876$ mho/m, $\epsilon_r = 38.7918$; $\rho = 1000$ kg/m³, Medium parameters used (interpolated): $f = 2462$ MHz; $\sigma = 1.89$ mho/m; $\epsilon_r = 38.743$; $\rho = 1000$ kg/m³

Phantom section: Left Section

Measurement Standard: DASYS5 (IEEE/IEC/ANSI C63.19-2007)

DASY5 Configuration:

Probe: EX3DV4 - SN3746; ConvF(6.69, 6.69, 6.69); Calibrated: 11/11/2010

Modulation Compensation: Not Used

Sensor-Surface: 3mm (Mechanical Surface Detection)

Electronics: DAE4 Sn1237; Calibrated: 11/10/2010

Phantom: SAM with CRP; Type: SAM QD 000 P40 CC; Serial: TP-1598

Measurement SW: DASY52, Version 52.6 (1); SEMCAD X Version 14.4.2 (2595)

Left Head/Tilt/Zoom Scan (7x7x7)/Cube 0: Measurement grid: dx=5mm, dy=5mm, dz=5mm

Reference Value = 4.399 V/m; Power Drift = 0.09 dB

Peak SAR (extrapolated) = 0.059 W/kg

SAR(1 g) = 0.033 mW/g; SAR(10 g) = 0.017 mW/g

Info: Interpolated medium parameters used for SAR evaluation.

Maximum value of SAR (measured) = 0.037 mW/g

Left Head/Tilt/Zoom Scan 2 (7x7x7)/Cube 0: Measurement grid: dx=5mm, dy=5mm, dz=5mm

Reference Value = 4.399 V/m; Power Drift = 0.47 dB

Peak SAR (extrapolated) = 0.061 W/kg

SAR(1 g) = 0.034 mW/g; SAR(10 g) = 0.017 mW/g

Info: Interpolated medium parameters used for SAR evaluation.

Maximum value of SAR (measured) = 0.039 mW/g

Left Head/Tilt/Area scan (81x131x1): Measurement grid: dx=15mm, dy=15mm

Info: Interpolated medium parameters used for SAR evaluation.

Maximum value of SAR (interpolated) = 0.047 mW/g

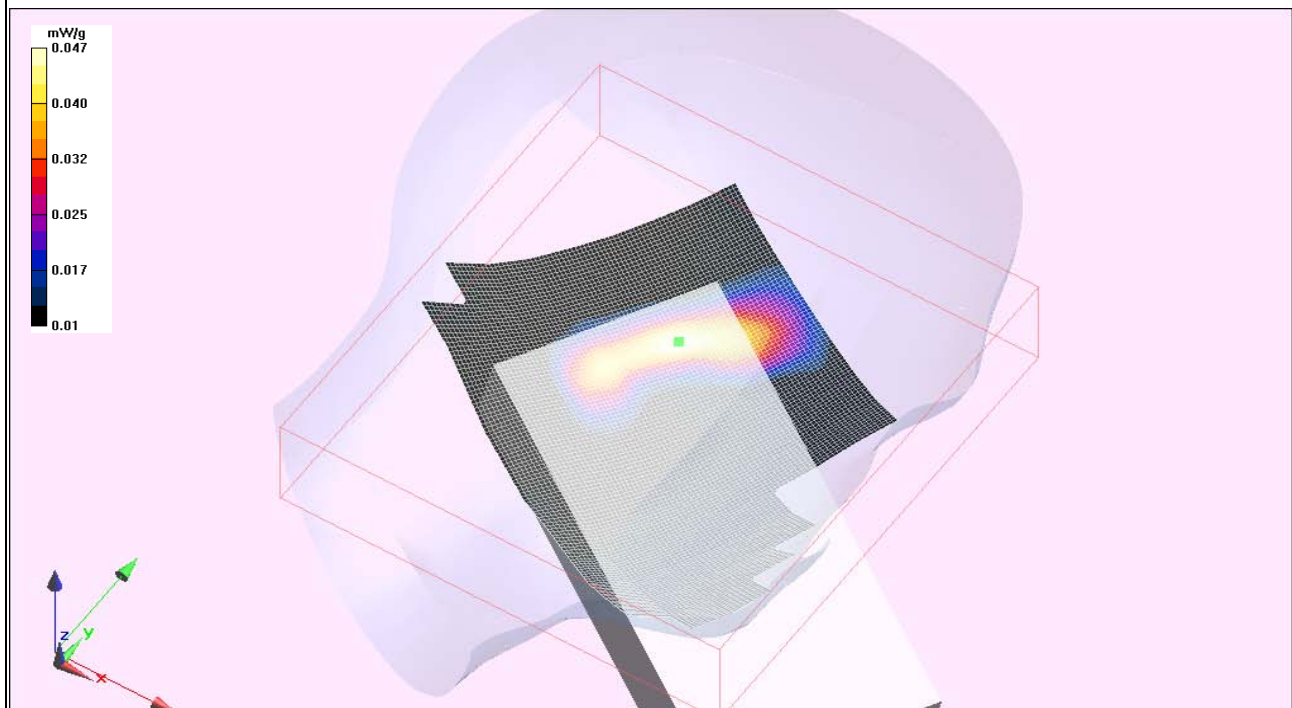

Room Temperature (°C):	23	Liquid Temperature (°C):	22.5	Humidity:	43	Test Date:	01/21/11
------------------------	----	--------------------------	------	-----------	----	------------	----------

2400MHz band Ch11 1Mbps Right Head A1 1-21-11

DUT: 1000CP01U Hand Held Computer; Type: CN70; Serial: 24411047012

Communication System: CW; Communication System Band: D2450 (2450.0 MHz); Frequency: 2462 MHz; Communication System PAR: 0 dB

Medium parameters used: $\sigma = 1.876$ mho/m, $\epsilon_r = 38.7918$; $\rho = 1000$ kg/m³, Medium parameters used (interpolated): $f = 2462$ MHz; $\sigma = 1.89$ mho/m; $\epsilon_r = 38.743$; $\rho = 1000$ kg/m³

Phantom section: Right Section

Measurement Standard: DASYS (IEEE/IEC/ANSI C63.19-2007)

DASYS Configuration:

Probe: EX3DV4 - SN3746; ConvF(6.69, 6.69, 6.69); Calibrated: 11/11/2010

Modulation Compensation: Not Used

Sensor-Surface: 3mm (Mechanical Surface Detection)

Electronics: DAE4 Sn1237; Calibrated: 11/10/2010

Phantom: SAM with CRP; Type: SAM QD 000 P40 CC; Serial: TP-1598

Measurement SW: DASYS2, Version 52.6 (1); SEMCAD X Version 14.4.2 (2595)

Right Head/Touch/Zoom Scan (7x7x7)/Cube 0: Measurement grid: dx=5mm, dy=5mm, dz=5mm

Reference Value = 4.030 V/m; Power Drift = 0.64 dB

Peak SAR (extrapolated) = 0.047 W/kg

SAR(1 g) = 0.028 mW/g; SAR(10 g) = 0.015 mW/g

Info: Interpolated medium parameters used for SAR evaluation.

Maximum value of SAR (measured) = 0.032 mW/g

Right Head/Touch/Area scan (61x121x1): Measurement grid: dx=15mm, dy=15mm

Info: Interpolated medium parameters used for SAR evaluation.

Maximum value of SAR (interpolated) = 0.046 mW/g

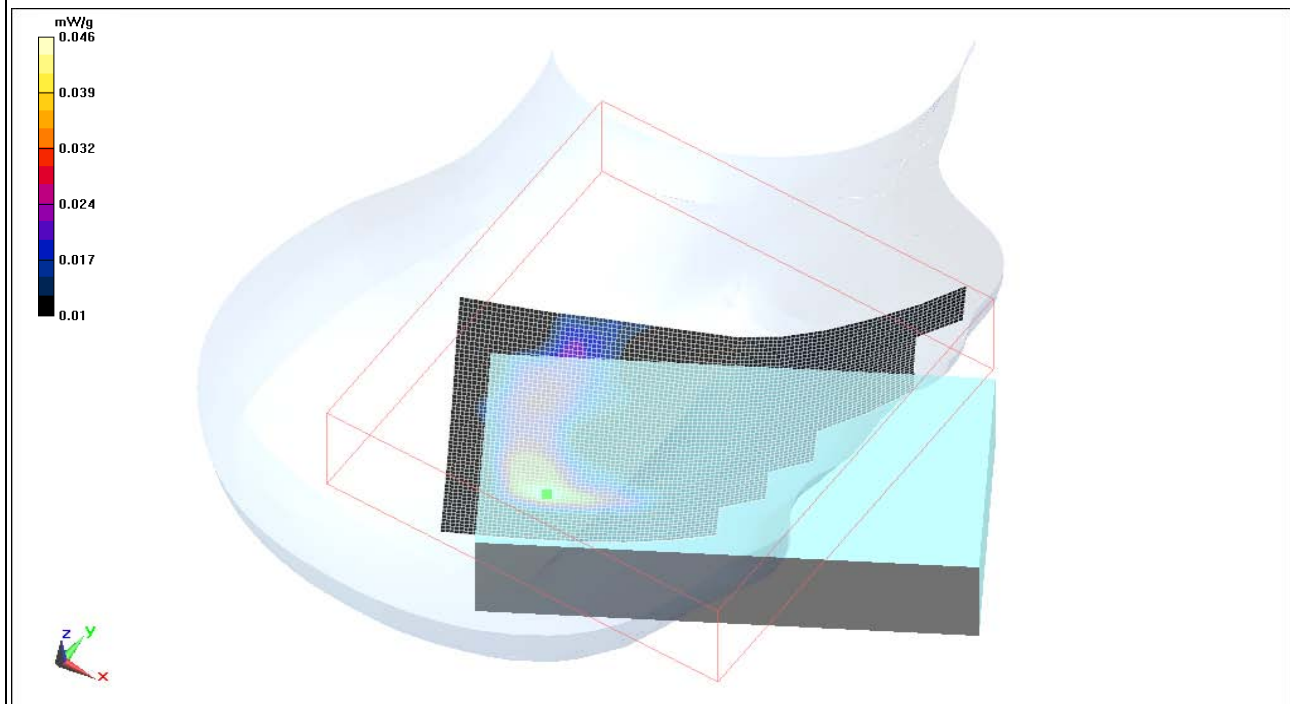

Room Temperature (°C):	23	Liquid Temperature (°C):	22.5	Humidity:	43	Test Date:	01/21/11
------------------------	----	--------------------------	------	-----------	----	------------	----------

2400MHz band Ch11 1Mbps Right Head A1 1-21-11

DUT: 1000CP01U Hand Held Computer; Type: CN70; Serial: 24411047012

Communication System: CW; Communication System Band: D2450 (2450.0 MHz); Frequency: 2462 MHz; Communication System PAR: 0 dB

Medium parameters used: $\sigma = 1.876$ mho/m, $\epsilon_r = 38.7918$; $\rho = 1000$ kg/m³, Medium parameters used (interpolated): $f = 2462$ MHz; $\sigma = 1.89$ mho/m; $\epsilon_r = 38.743$; $\rho = 1000$ kg/m³

Phantom section: Right Section

Measurement Standard: DASYS (IEEE/IEC/ANSI C63.19-2007)

DASY5 Configuration:

Probe: EX3DV4 - SN3746; ConvF(6.69, 6.69, 6.69); Calibrated: 11/11/2010

Modulation Compensation: Not Used

Sensor-Surface: 3mm (Mechanical Surface Detection)

Electronics: DAE4 Sn1237; Calibrated: 11/10/2010

Phantom: SAM with CRP; Type: SAM QD 000 P40 CC; Serial: TP-1598

Measurement SW: DASY52, Version 52.6 (1); SEMCAD X Version 14.4.2 (2595)

Right Head/Tilt/Zoom Scan (7x7x7)/Cube 0: Measurement grid: dx=5mm, dy=5mm, dz=5mm

Reference Value = 3.863 V/m; Power Drift = -0.25 dB

Peak SAR (extrapolated) = 0.053 W/kg

SAR(1 g) = 0.030 mW/g; SAR(10 g) = 0.014 mW/g

Info: Interpolated medium parameters used for SAR evaluation.

Maximum value of SAR (measured) = 0.033 mW/g

Right Head/Tilt/Area scan (61x121x1): Measurement grid: dx=15mm, dy=15mm

Info: Interpolated medium parameters used for SAR evaluation.

Maximum value of SAR (interpolated) = 0.042 mW/g

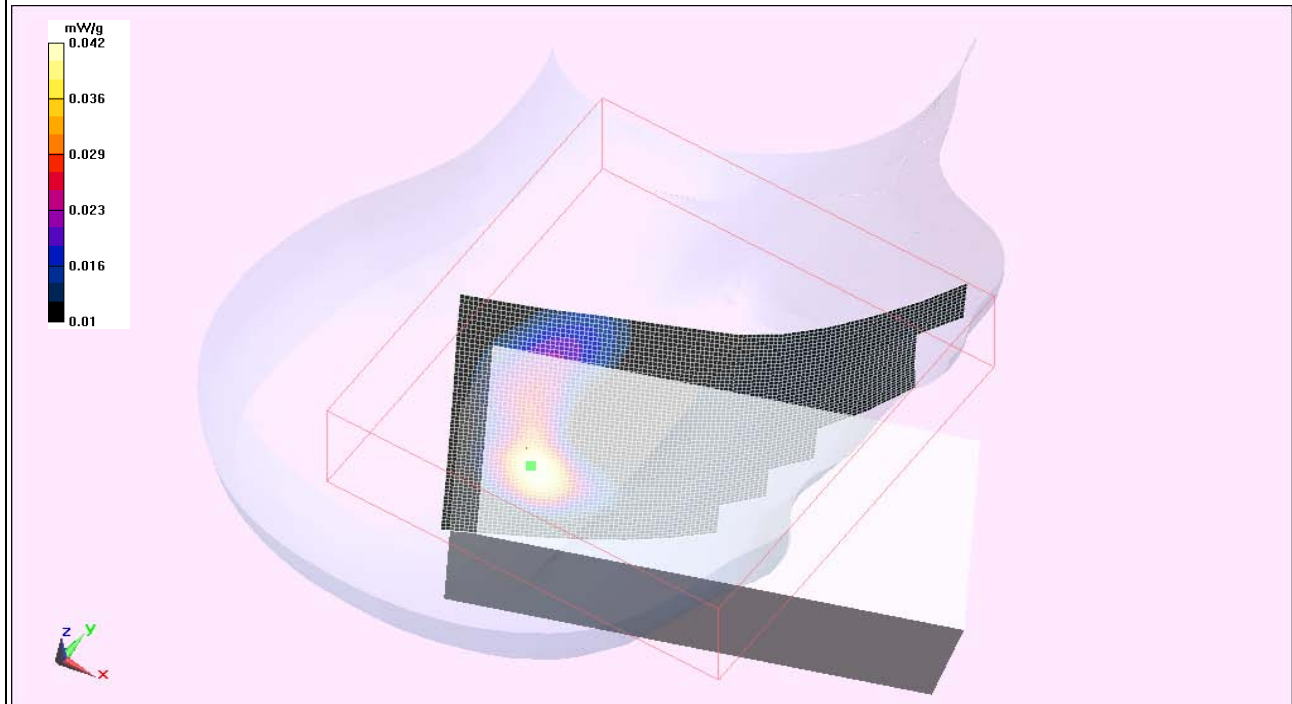

Room Temperature (°C):	23	Liquid Temperature (°C):	22.5	Humidity (%):	43	Test Date:	01/21/11
------------------------	----	--------------------------	------	---------------	----	------------	----------

2400MHz band Ch11 1Mbps Left Head A1 1-21-11

DUT: 1000CP01U Hand Held Computer; Type: CN70; Serial: 24411047012

Left Head/Touch/Z Scan (1x1x21): Measurement grid: dx=20mm, dy=20mm, dz=5mm
Maximum value of Total (measured) = 5.224 V/m

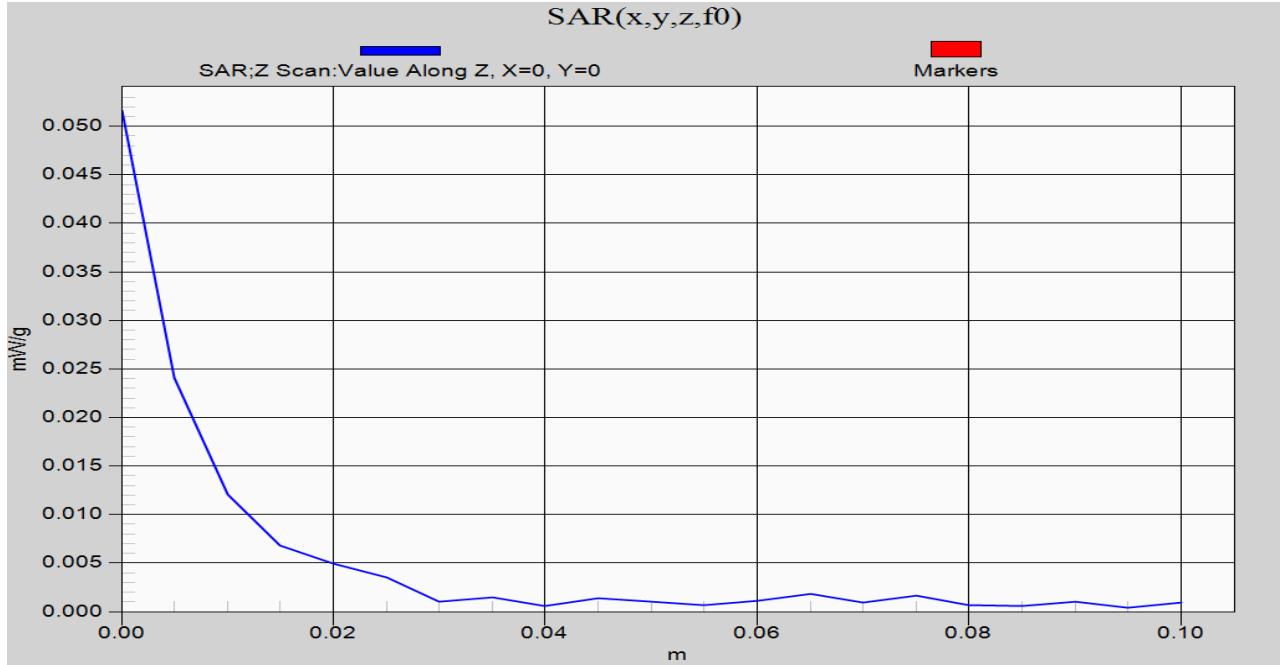

NORTHWEST **EMC** **SAR TEST DATA** XMit 2011.01.18

EUT: 1000CP01U	Work Order: INMC0570
Serial Number: 24411047012	Date: See Data Sheets
Customer: Intermec Technologies	Temperature: See Data Sheets
Attendees: None	Humidity: See Data Sheets
Project: INMC0570	Barometric Pres.: See Data Sheets
Tested by: Jennifer Herrett	Job Site: EV08

TEST SPECIFICATIONS	Test Method
FCC 2.1093:2011	FCC OET 65C:2001
FCC 15.247:2011	IEEE Std 1528:2003
FCC 15.407:2001	FCC KDB 447498 D01 v04
Health Safety Code 6:2009	FCC KDB 248227 D01 V01r02
	FCC KDB 648474 D01 V01r05
	FCC 865664
	RSS-102, Issue 4:2010

COMMENTS

None

DEVIATIONS FROM TEST STANDARD

No Deviations

Configuration #	1	<i>Jennifer Herrett</i> Signature
-----------------	---	--------------------------------------

Test Configuration	Frequency Band	Body-Worn Accessory	Transmit Frequency	Transmit Channel	Transmit Mode	Data Rate (Mbps)	Audio Accessory	EUT Position	Start Power (Conducted)	SAR Drift During Test (dB)	1g SAR Level	Test #
Body	2450	Holster	2462MHz	Ch 11	BPSK	1Mbps	VR10 Headset	Right	16.7	-0.18	0.178	1
								Front	16.7	Note 2	Note 1	2
							none	Right	16.7	-0.04	0.293	3
								Front	16.7	Note 2	0.015	4

Note 1: Zoom scan not performed, no hot spots detected, area scan results were less than the required system sensitivity of 0.01 mW/g.
 Note 2: Due to the low value of measured SAR, the SAR drift measurement was made close to the measurement noise floor and is therefore inaccurate

2400MHz band 1 Mbps Body Holstered and Headset, Right 1-18-11 Test 1

DUT: 1000CP01U Hand Held Computer; Type: CN70; Serial: 24411047012

Communication System: CW; Communication System Band: D2450 (2450.0 MHz); Frequency: 2462 MHz; Communication System PAR: 0 dB

Medium parameters used: $\sigma = 2.00835$ mho/m, $\epsilon_r = 50.4833$; $\rho = 1000$ kg/m³, Medium parameters used (interpolated): $f = 2462$ MHz; $\sigma = 2.025$ mho/m; $\epsilon_r = 50.44$; $\rho = 1000$ kg/m³

Phantom section: Flat Section

Measurement Standard: DASYS (IEEE/IEC/ANSI C63.19-2007)

DASYS Configuration:

Probe: EX3DV4 - SN3746; ConvF(6.81, 6.81, 6.81); Calibrated: 11/11/2010

Modulation Compensation: Not Used

Sensor-Surface: 3mm (Mechanical Surface Detection)

Electronics: DAE4 Sn1237; Calibrated: 11/10/2010

Phantom: ELI 4.0; Type: QDOVA001BA; Serial: 1598

Measurement SW: DASYS2, Version 52.6 (1); SEMCAD X Version 14.4.2 (2595)

Body WLAN 802.11b, 1 Mbps/Right Holstered/Zoom Scan 2 (7x7x7)/Cube 0: Measurement grid: dx=5mm, dy=5mm, dz=5mm

Reference Value = 10.236 V/m; Power Drift = -0.18 dB

Peak SAR (extrapolated) = 0.342 W/kg

SAR(1 g) = 0.178 mW/g; SAR(10 g) = 0.088 mW/g

Info: Interpolated medium parameters used for SAR evaluation.

Maximum value of SAR (measured) = 0.201 mW/g

Info: Interpolated medium parameters used for SAR evaluation.

Body WLAN 802.11b, 1 Mbps/Right Holstered/Area scan (61x181x1): Measurement grid: dx=15mm, dy=15mm

Info: Interpolated medium parameters used for SAR evaluation.

Maximum value of SAR (interpolated) = 0.236 mW/g

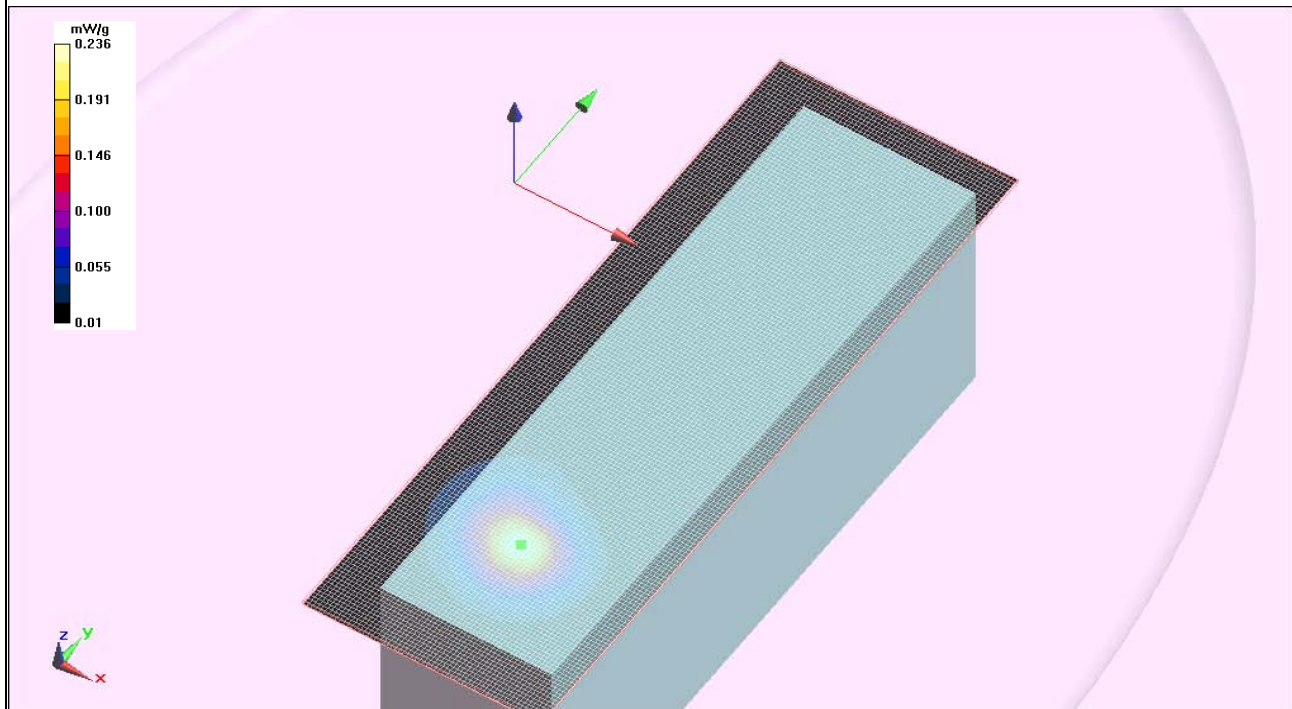

Room Temperature (°C):	22	Liquid Temperature (°C):	22	Humidity (%):	50	Test Date:	01/17/11
------------------------	----	--------------------------	----	---------------	----	------------	----------

2400MHz band 1 Mbps Body Holstered test 3 1-17-11

DUT: 1000CP01U Hand Held Computer; Type: CN70; Serial: 24411047012

Communication System: CW; Communication System Band: D2450 (2450.0 MHz); Frequency: 2462 MHz; Communication System PAR: 0 dB

Medium parameters used: $\sigma = 1.97502$ mho/m, $\epsilon_r = 50.6757$; $\rho = 1000$ kg/m³, Medium parameters used (interpolated): $f = 2462$ MHz; $\sigma = 1.991$ mho/m; $\epsilon_r = 50.633$; $\rho = 1000$ kg/m³

Phantom section: Flat Section

Measurement Standard: DASYS (IEEE/IEC/ANSI C63.19-2007)

DASY5 Configuration:

Probe: EX3DV4 - SN3746; ConvF(6.81, 6.81, 6.81); Calibrated: 11/11/2010

Modulation Compensation: Not Used

Sensor-Surface: 3mm (Mechanical Surface Detection)

Electronics: DAE4 Sn1237; Calibrated: 11/10/2010

Phantom: ELI 4.0; Type: QDOVA001BA; Serial: 1598

Measurement SW: DASY52, Version 52.6 (1); SEMCAD X Version 14.4.2 (2595)

Body WLAN 802.11b, 1 Mbps/Right Holstered/Zoom Scan 2 (7x7x7)/Cube 0: Measurement grid: dx=5mm, dy=5mm, dz=5mm

Reference Value = 9.576 V/m; Power Drift = -0.04 dB

Peak SAR (extrapolated) = 0.558 W/kg

SAR(1 g) = 0.293 mW/g; SAR(10 g) = 0.142 mW/g

Info: Interpolated medium parameters used for SAR evaluation.

Maximum value of SAR (measured) = 0.330 mW/g

Body WLAN 802.11b, 1 Mbps/Right Holstered/Area scan (51x161x1): Measurement grid: dx=15mm, dy=15mm

Info: Interpolated medium parameters used for SAR evaluation.

Maximum value of SAR (interpolated) = 0.367 mW/g

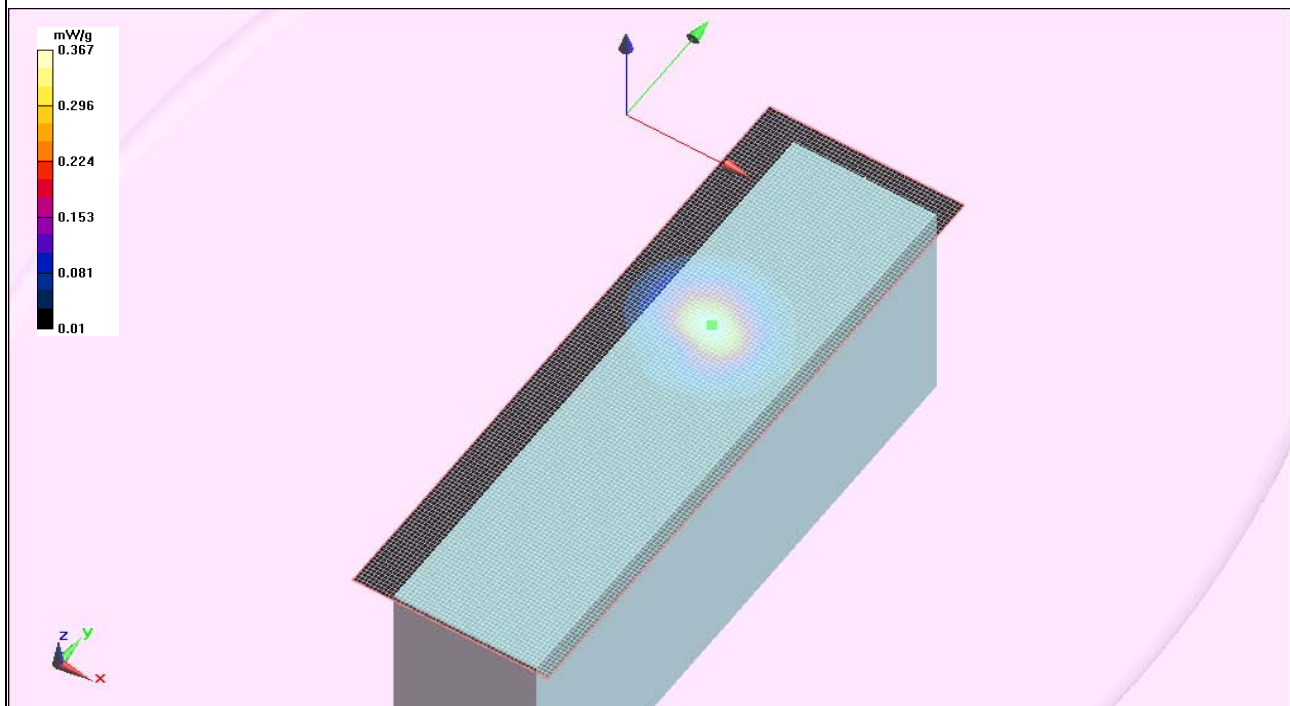

Room Temperature (°C):	22	Liquid Temperature (°C):	22	Humidity (%):	50	Test Date:	01/17/11
------------------------	----	--------------------------	----	---------------	----	------------	----------

2400MHz band 1 Mbps Body Holstered test 4 1-17-11

DUT: 1000CP01U Hand Held Computer; Type: CN70; Serial: 24411047012

Communication System: CW; Communication System Band: D2450 (2450.0 MHz); Frequency: 2462 MHz; Communication System PAR: 0 dB

Medium parameters used: $\sigma = 1.97502$ mho/m, $\epsilon_r = 50.6757$; $\rho = 1000$ kg/m³, Medium parameters used (interpolated): $f = 2462$ MHz; $\sigma = 1.991$ mho/m; $\epsilon_r = 50.633$; $\rho = 1000$ kg/m³

Phantom section: Flat Section

Measurement Standard: DASYS (IEEE/IEC/ANSI C63.19-2007)

DASYS Configuration:

Probe: EX3DV4 - SN3746; ConvF(6.81, 6.81, 6.81); Calibrated: 11/11/2010

Modulation Compensation: Not Used

Sensor-Surface: 3mm (Mechanical Surface Detection)

Electronics: DAE4 Sn1237; Calibrated: 11/10/2010

Phantom: ELI 4.0; Type: QDOVA001BA; Serial: 1598

Measurement SW: DASYS2, Version 52.6 (1); SEMCAD X Version 14.4.2 (2595)

Body WLAN 802.11b, 1 Mbps/Front Holstered/Zoom Scan 2 (7x7x7)/Cube 0: Measurement grid: dx=5mm, dy=5mm, dz=5mm

Reference Value = 2.676 V/m; Power Drift = 0.56 dB

Peak SAR (extrapolated) = 0.022 W/kg

SAR(1 g) = 0.015 mW/g; SAR(10 g) = 0.00798 mW/g

Body WLAN 802.11b, 1 Mbps/Front Holstered/Zoom Scan (7x7x7)/Cube 0: Measurement grid: dx=5mm, dy=5mm, dz=5mm

Reference Value = 2.676 V/m; Power Drift = 0.77 dB

Peak SAR (extrapolated) = 0.027 W/kg

SAR(1 g) = 0.015 mW/g; SAR(10 g) = 0.00861 mW/g

Info: Interpolated medium parameters used for SAR evaluation.

Body WLAN 802.11b, 1 Mbps/Front Holstered/Area scan (91x181x1): Measurement grid: dx=15mm, dy=15mm

Info: Interpolated medium parameters used for SAR evaluation.

Maximum value of SAR (interpolated) = 0.024 mW/g

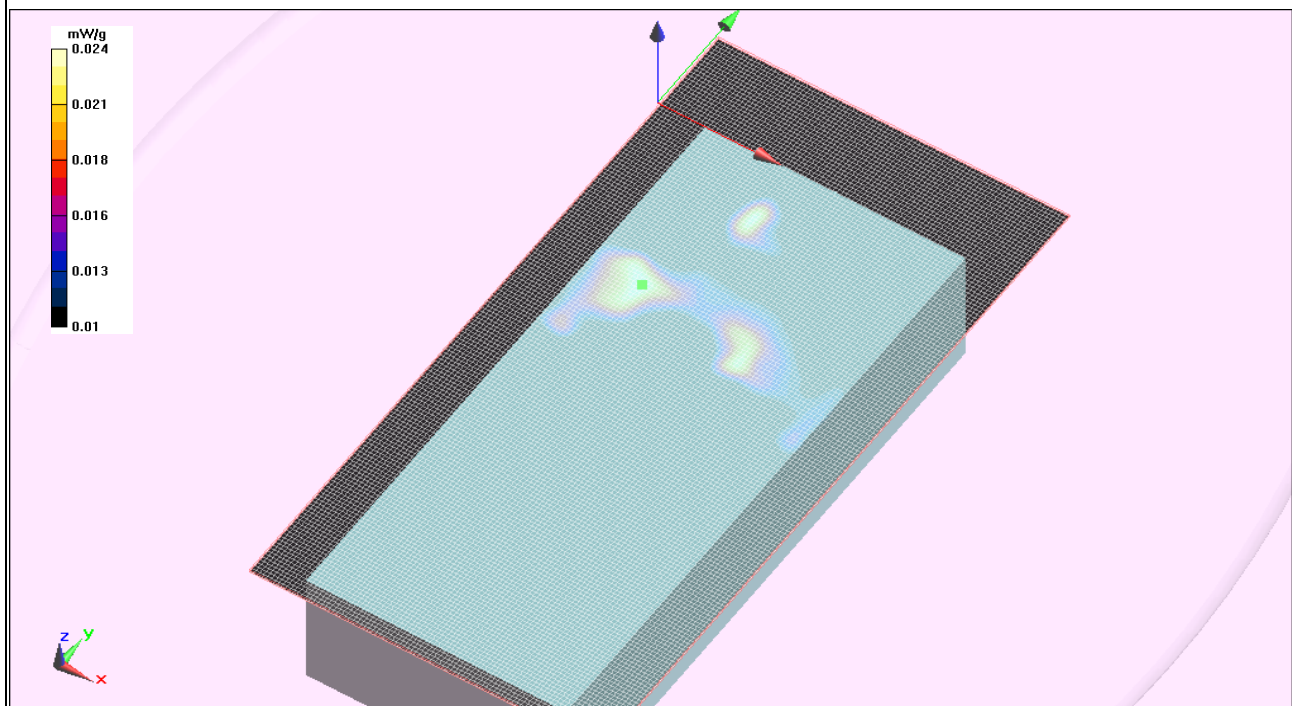

Room Temperature (°C):	22	Liquid Temperature (°C):	22	Humidity (%):	50	Test Date:	01/17/11
------------------------	----	--------------------------	----	---------------	----	------------	----------

2400MHz band 1 Mbps Body Holstered test 3 1-17-11

DUT: 1000CP01U Hand Held Computer; Type: CN70; Serial: 24411047012

Body WLAN 802.11b, 1 Mbps/Right Holstered/Z Scan (1x1x21): Measurement grid: dx=20mm, dy=20mm, dz=5mm
Maximum value of Total (measured) = 13.836 V/m

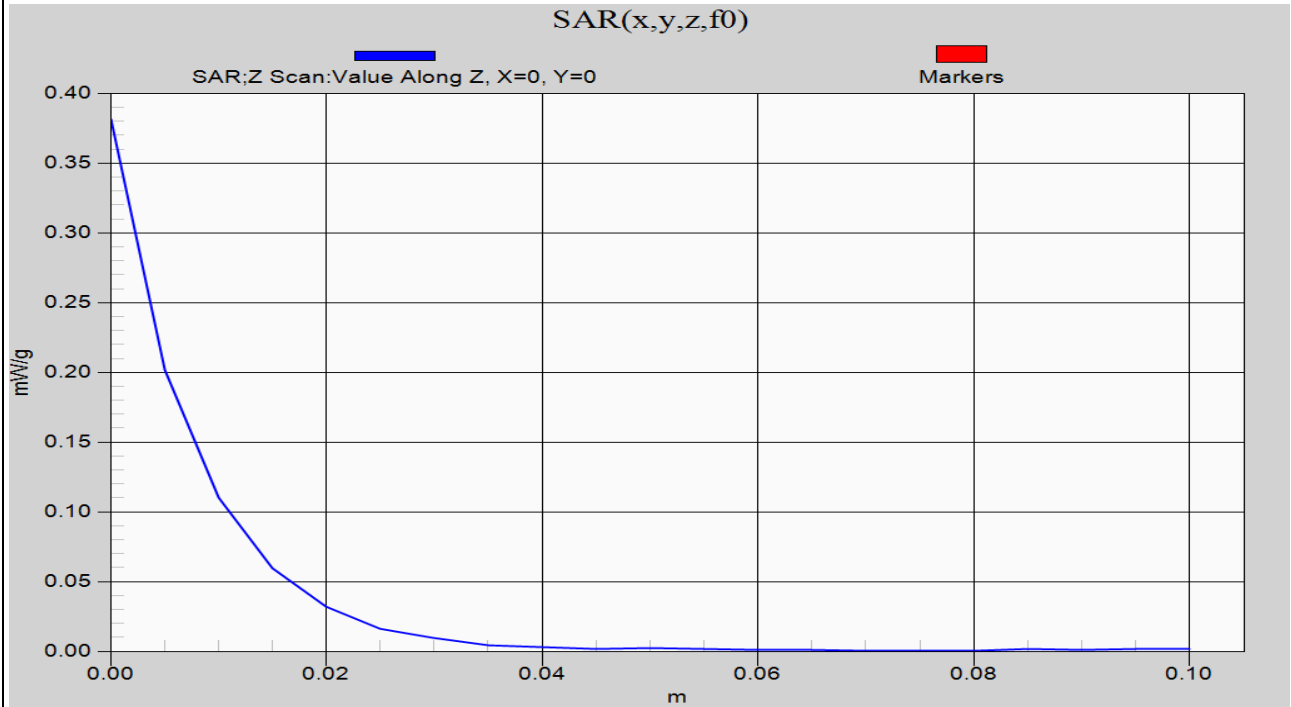

NORTHWEST **EMC** **SAR TEST DATA** XMit 2011.01.18

EUT: 1000CP01U	Work Order: INMC0570
Serial Number: 24411047012	Date: See Data Sheets
Customer: Intermec Technologies	Temperature: See Data Sheets
Attendees: None	Humidity: See Data Sheets
Project: INMC0570	Barometric Pres.: See Data Sheets
Tested by: Jennifer Herrett	Job Site: EV08

TEST SPECIFICATIONS	Test Method
FCC 2.1093:2011	FCC OET 65C:2001
FCC 15.247:2011	IEEE Std 1528:2003
FCC 15.407:2001	FCC KDB 447498 D01 v04
	FCC KDB 248227 D01 V01r02
	FCC KDB 648474 D01 V01r05
	FCC 865664
Health Safety Code 6:2009	RSS-102, Issue 4:2010

COMMENTS
None

DEVIATIONS FROM TEST STANDARD
No Deviations

Configuration #	1	<i>Jennifer Herrett</i> Signature
-----------------	---	--------------------------------------

Test Configuration	Frequency Band	Form Factor	Transmit Frequency	Transmit Channel	Transmit Mode	Data Rate (Mbps)	EUT Position	Start Power (Conducted)	SAR Drift During Test (dB)	1g SAR Level	Test #	
Head	5200	A1	5180MHz	Ch 36	OFDM	6Mbps	Left Head	Touch	13.4	Note 2	Note 1	13
								Tilt	13.4	Note 2	0.026	14
							Right Head	Touch	13.4	Note 2	0.015	15
								Tilt	13.4	Note 2	0.022	16
Head	5300	A1	5260MHz	Ch 52	OFDM	7.2Mbps	Left Head	Touch	13.2	-0.27	0.081	25
								Tilt	13.2	Note 2	0.041	26
							Right Head	Touch	13.2	Note 2	0.021	27
								Tilt	13.2	Note 2	0.013	28
Head	5600	A1	5600MHz	Ch 120	OFDM	6Mbps	Left Head	Touch	12.9	-0.23	0.093	37
								Tilt	12.9	Note 2	0.035	38
							Right Head	Touch	12.9	Note 2	0.027	39
								Tilt	12.9	Note 2	0.011	40
Head	5800	A1	5745MHz	Ch 149	OFDM	6Mbps	Left Head	Touch	11.6	-0.34	0.081	49
								Tilt	11.6	0.23	0.065	50
							Right Head	Touch	11.6	Note 2	0.025	51
								Tilt	11.6	Note 2	0.030	52

Note 1: Zoom scan not performed, no hot spots detected, area scan results were less than the required system sensitivity of 0.01 mW/g.
 Note 2: Due to the low value of measured SAR, the SAR drift measurement was made close to the measurement noise floor and is therefore inaccurate

EMC

Room Temperature (°C):	22.9	Liquid Temperature (°C):	21.4	Humidity (%):	37	Test Date:	01/27/11
------------------------	------	--------------------------	------	---------------	----	------------	----------

5200MHz band CW-6 Mbps Left Head A1 Tests 13-14 1-27-11

DUT: 1000CP01U Hand Held Computer; Type: CN70; Serial: 24411047012

Communication System: CW; Communication System Band: D5GHz (5000.0 - 6000.0 MHz); Frequency: 5180 MHz; Communication System PAR: 0 dB

Medium parameters used: $\sigma = 4.78402$ mho/m, $\epsilon_r = 36.3176$; $\rho = 1000$ kg/m³, Medium parameters used (interpolated): $f = 5180$ MHz; $\sigma = 4.761$ mho/m; $\epsilon_r = 36.348$; $\rho = 1000$ kg/m³

Phantom section: Left Section

Measurement Standard: DASYS (IEEE/IEC/ANSI C63.19-2007)

DASY5 Configuration:

Probe: EX3DV4 - SN3746; ConvF(5.08, 5.08, 5.08); Calibrated: 11/11/2010

Modulation Compensation: Not Used

Sensor-Surface: 2mm (Mechanical Surface Detection)

Electronics: DAE4 Sn1237; Calibrated: 11/10/2010

Phantom: SAM with CRP; Type: SAM QD 000 P40 CC; Serial: TP-1598

Measurement SW: DASYS2, Version 52.6 (1); SEMCAD X Version 14.4.2 (2595)

Left Head/Tilt/Zoom Scan (8x8x9)/Cube 0: Measurement grid: dx=4.3mm, dy=4.3mm, dz=3mm

Reference Value = 1.971 V/m; Power Drift = 0.76 dB

Peak SAR (extrapolated) = 0.206 W/kg

SAR(1 g) = 0.026 mW/g; SAR(10 g) = 0.00946 mW/g

Info: Interpolated medium parameters used for SAR evaluation.

Maximum value of SAR (measured) = 0.056 mW/g

Left Head/Tilt/Area scan (91x81x1): Measurement grid: dx=15mm, dy=15mm

Info: Interpolated medium parameters used for SAR evaluation.

Maximum value of SAR (interpolated) = 0.041 mW/g

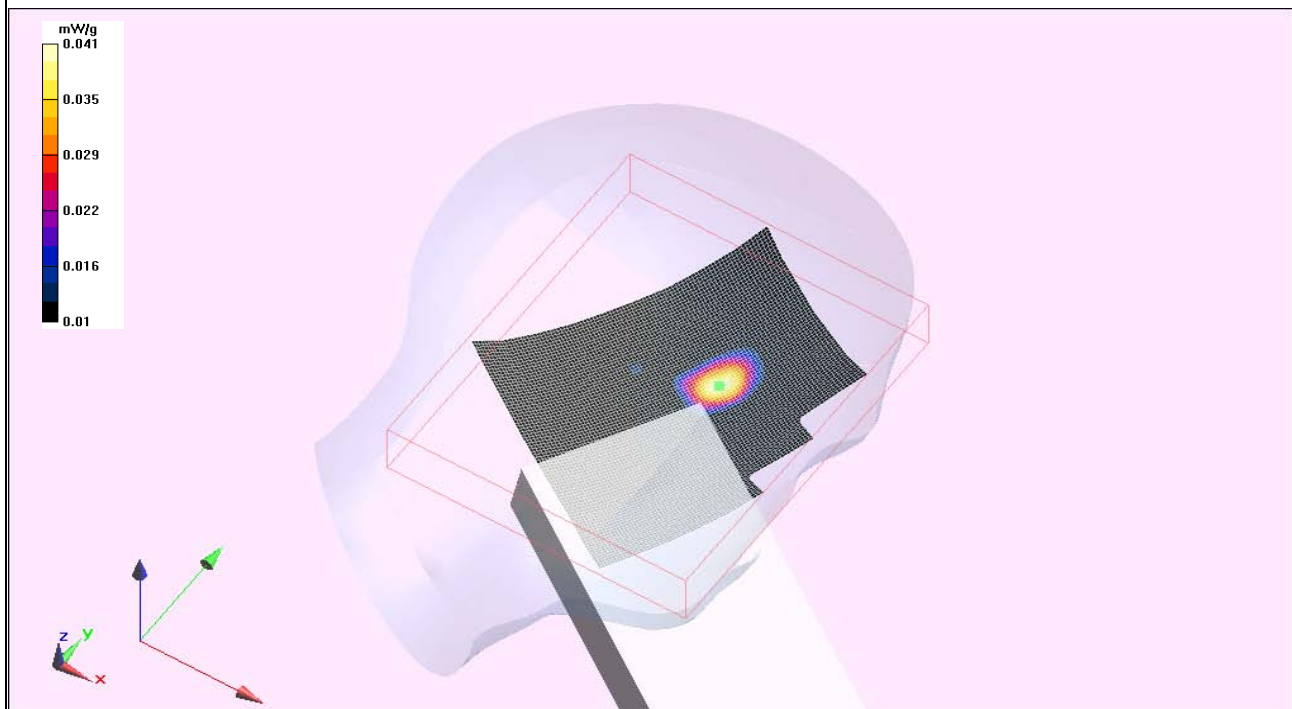

Room Temperature (°C):	22.3	Liquid Temperature (°C):	22.4	Humidity:	43.5	Test Date:	01/28/11
------------------------	------	--------------------------	------	-----------	------	------------	----------

5200MHz band CW-6 Right Head A1 Tests 15-16 1-28-11

DUT: 1000CP01U Hand Held Computer; Type: CN70; Serial: 24411047012

Communication System: CW; Communication System Band: D5GHz (5000.0 - 6000.0 MHz); Frequency: 5180 MHz; Communication System PAR: 0 dB

Medium parameters used: $\sigma = 4.7515$ mho/m, $\epsilon_r = 35.2733$; $\rho = 1000$ kg/m³, Medium parameters used (interpolated): $f = 5180$ MHz; $\sigma = 4.728$ mho/m; $\epsilon_r = 35.307$; $\rho = 1000$ kg/m³

Phantom section: Right Section

Measurement Standard: DASYS (IEEE/IEC/ANSI C63.19-2007)

DASYS Configuration:

Probe: EX3DV4 - SN3746; ConvF(5.08, 5.08, 5.08); Calibrated: 11/11/2010

Modulation Compensation: Not Used

Sensor-Surface: 2mm (Mechanical Surface Detection)

Electronics: DAE4 Sn1237; Calibrated: 11/10/2010

Phantom: SAM with CRP; Type: SAM QD 000 P40 CC; Serial: TP-1598

Measurement SW: DASYS2, Version 52.6 (1); SEMCAD X Version 14.4.2 (2595)

Right Head/Touch/Zoom Scan (10x9x9)/Cube 0: Measurement grid: dx=4.3mm, dy=4.3mm, dz=3mm

Reference Value = 2.058 V/m; Power Drift = 0.05 dB

Peak SAR (extrapolated) = 0.133 W/kg

SAR(1 g) = 0.015 mW/g; SAR(10 g) = 0.0037 mW/g

Info: Interpolated medium parameters used for SAR evaluation.

Maximum value of SAR (measured) = 0.031 mW/g

Right Head/Touch/Area scan (161x141x1): Measurement grid: dx=7.5mm, dy=7.5mm

Info: Interpolated medium parameters used for SAR evaluation.

Maximum value of SAR (interpolated) = 0.030 mW/g

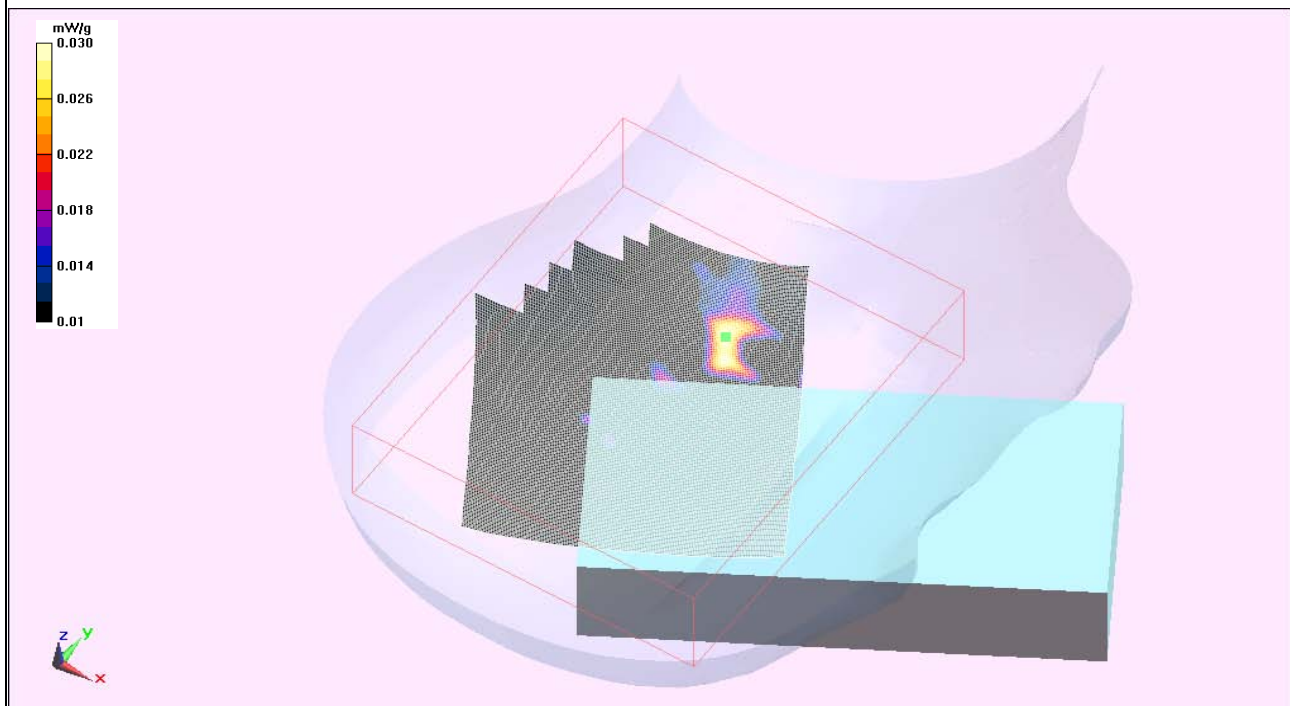

Room Temperature (°C):	22.3	Liquid Temperature (°C):	22.4	Humidity:	43.5	Test Date:	01/28/11
------------------------	------	--------------------------	------	-----------	------	------------	----------

5200MHz band CW-6 Right Head A1 Tests 15-16 1-28-11

DUT: 1000CP01U Hand Held Computer; Type: CN70; Serial: 24411047012

Communication System: CW; Communication System Band: D5GHz (5000.0 - 6000.0 MHz); Frequency: 5180 MHz ;Communication System PAR: 0 dB

Medium parameters used: $\sigma = 4.7515$ mho/m, $\epsilon_r = 35.2733$; $\rho = 1000$ kg/m³, Medium parameters used (interpolated): $f = 5180$ MHz; $\sigma = 4.728$ mho/m; $\epsilon_r = 35.307$; $\rho = 1000$ kg/m³

Phantom section: Right Section

Measurement Standard: DASYS (IEEE/IEC/ANSI C63.19-2007)

DASY5 Configuration:

Probe: EX3DV4 - SN3746; ConvF(5.08, 5.08, 5.08); Calibrated: 11/11/2010

Modulation Compensation: Not Used

Sensor-Surface: 2mm (Mechanical Surface Detection)

Electronics: DAE4 Sn1237; Calibrated: 11/10/2010

Phantom: SAM with CRP; Type: SAM QD 000 P40 CC; Serial: TP-1598

Measurement SW: DASY52, Version 52.6 (1); SEMCAD X Version 14.4.2 (2595)

Right Head/Tilt/Zoom Scan (7x7x9)/Cube 0: Measurement grid: dx=4.3mm, dy=4.3mm, dz=3mm

Reference Value = 2.188 V/m; Power Drift = -2.00 dB

Peak SAR (extrapolated) = 0.127 W/kg

SAR(1 g) = 0.022 mW/g; SAR(10 g) = 0.015 mW/g

Info: Interpolated medium parameters used for SAR evaluation.

Right Head/Tilt/Area scan (161x121x1): Measurement grid: dx=7.5mm, dy=7.5mm

Info: Interpolated medium parameters used for SAR evaluation.

Maximum value of SAR (interpolated) = 0.055 mW/g

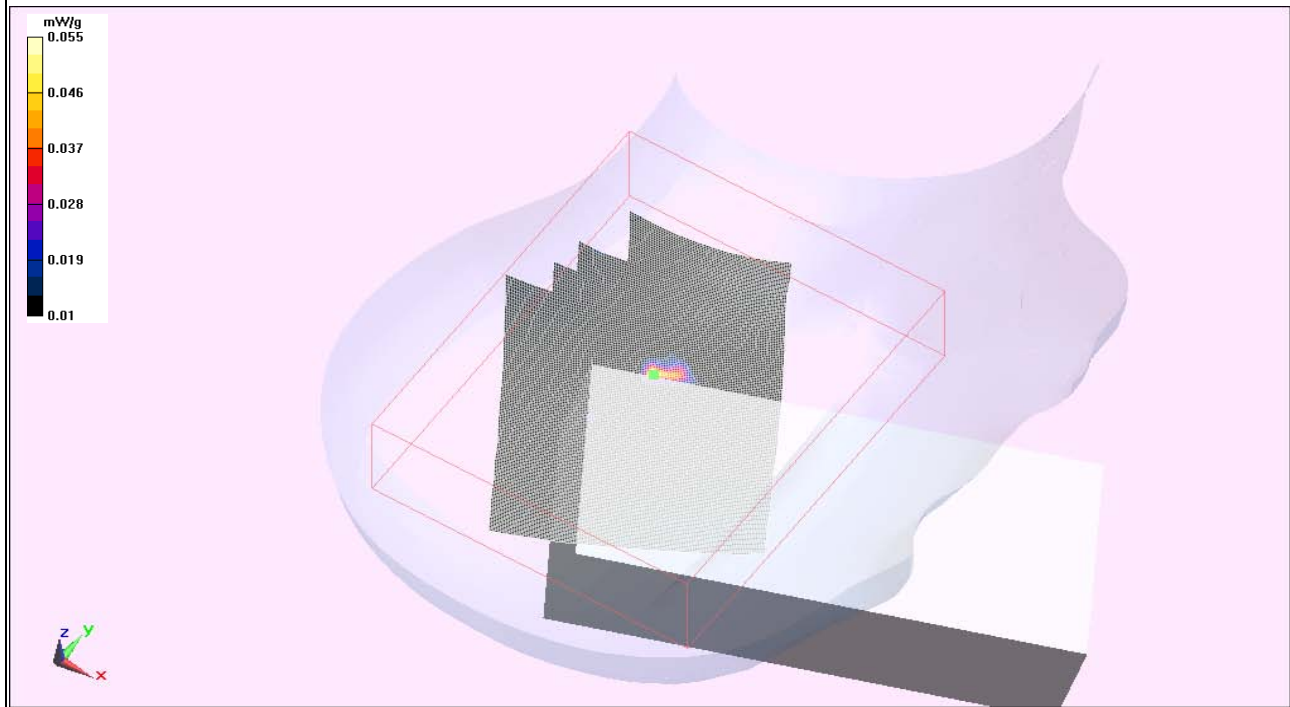

Room Temperature (°C):	22.9	Liquid Temperature (°C):	21.4	Humidity (%):	37	Test Date:	01/27/11
------------------------	------	--------------------------	------	---------------	----	------------	----------

5300MHz band CW-7.2Mbps Left Head A1 Tests 25-26 1-27-11

DUT: 1000CP01U Hand Held Computer; Type: CN70; Serial: 24411047012

Communication System: CW; Communication System Band: D5GHz (5000.0 - 6000.0 MHz); Frequency: 5260 MHz; Communication System PAR: 0 dB

Medium parameters used: $\sigma = 4.83647$ mho/m, $\epsilon_r = 36.2405$; $\rho = 1000$ kg/m³, Medium parameters used (interpolated): $f = 5260$ MHz; $\sigma = 4.848$ mho/m; $\epsilon_r = 36.221$; $\rho = 1000$ kg/m³

Phantom section: Left Section

Measurement Standard: DASYS (IEEE/IEC/ANSI C63.19-2007)

DASYS Configuration:

Probe: EX3DV4 - SN3746; ConvF(4.59, 4.59, 4.59); Calibrated: 11/11/2010

Modulation Compensation: Not Used

Sensor-Surface: 2mm (Mechanical Surface Detection)

Electronics: DAE4 Sn1237; Calibrated: 11/10/2010

Phantom: SAM with CRP; Type: SAM QD 000 P40 CC; Serial: TP-1598

Measurement SW: DASYS2, Version 52.6 (1); SEMCAD X Version 14.4.2 (2595)

Left Head/Touch/Zoom Scan 2 (8x10x9)/Cube 0: Measurement grid: dx=4.3mm, dy=4.3mm, dz=3mm

Reference Value = 4.181 V/m; Power Drift = -0.34 dB

Peak SAR (extrapolated) = 0.314 W/kg

SAR(1 g) = 0.072 mW/g; SAR(10 g) = 0.027 mW/g

Info: Interpolated medium parameters used for SAR evaluation.

Maximum value of SAR (measured) = 0.128 mW/g

Left Head/Touch/Zoom Scan (9x9x9)/Cube 0: Measurement grid: dx=4.3mm, dy=4.3mm, dz=3mm

Reference Value = 4.181 V/m; Power Drift = -0.27 dB

Peak SAR (extrapolated) = 0.242 W/kg

SAR(1 g) = 0.081 mW/g; SAR(10 g) = 0.029 mW/g

Info: Interpolated medium parameters used for SAR evaluation.

Maximum value of SAR (measured) = 0.149 mW/g

Left Head/Touch/Area scan (91x81x1): Measurement grid: dx=15mm, dy=15mm

Info: Interpolated medium parameters used for SAR evaluation.

Maximum value of SAR (interpolated) = 0.146 mW/g

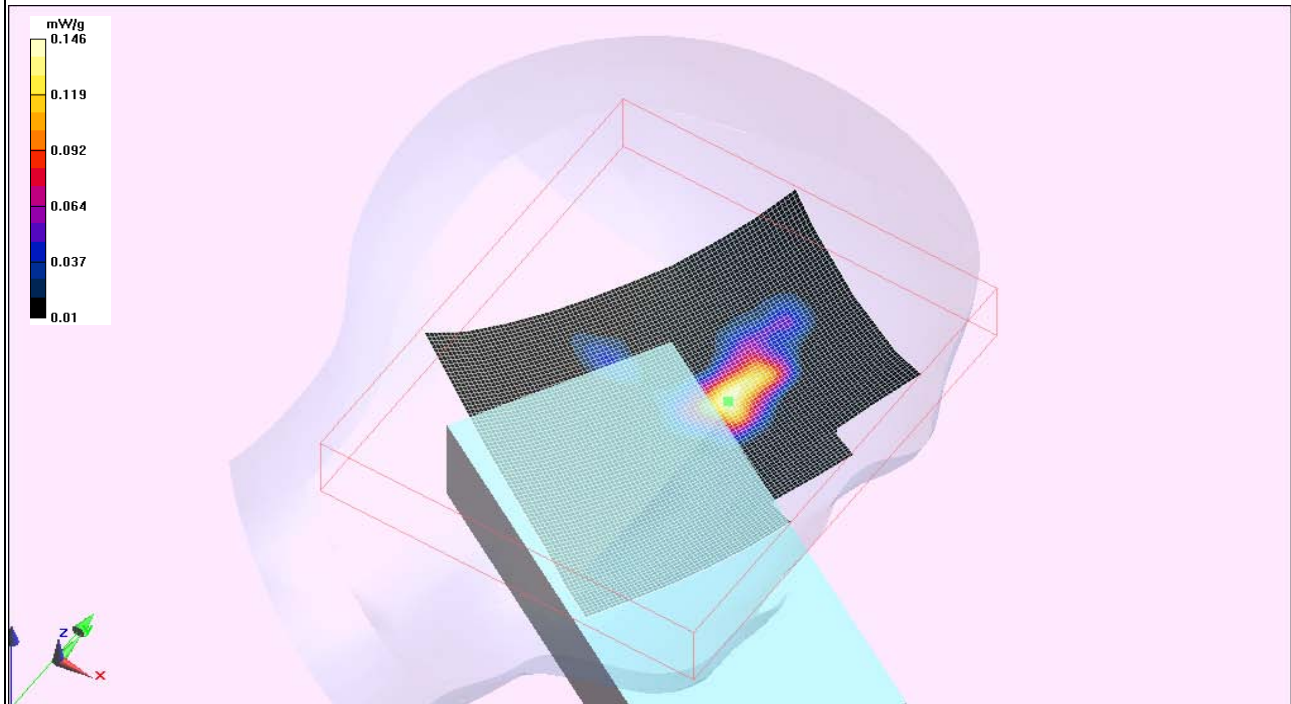

Room Temperature (°C):	22.9	Liquid Temperature (°C):	21.4	Humidity (%):	37	Test Date:	01/27/11
------------------------	------	--------------------------	------	---------------	----	------------	----------

5300MHz band CW-7.2Mbps Left Head A1 Tests 25-26 1-27-11

DUT: 1000CP01U Hand Held Computer; Type: CN70; Serial: 24411047012

Communication System: CW; Communication System Band: D5GHz (5000.0 - 6000.0 MHz); Frequency: 5260 MHz; Communication System PAR: 0 dB

Medium parameters used: $\sigma = 4.83647$ mho/m, $\epsilon_r = 36.2405$; $\rho = 1000$ kg/m³, Medium parameters used (interpolated): $f = 5260$ MHz; $\sigma = 4.848$ mho/m; $\epsilon_r = 36.221$; $\rho = 1000$ kg/m³

Phantom section: Left Section

Measurement Standard: DASYS (IEEE/IEC/ANSI C63.19-2007)

DASY5 Configuration:

Probe: EX3DV4 - SN3746; ConvF(4.59, 4.59, 4.59); Calibrated: 11/11/2010

Modulation Compensation: Not Used

Sensor-Surface: 2mm (Mechanical Surface Detection)

Electronics: DAE4 Sn1237; Calibrated: 11/10/2010

Phantom: SAM with CRP; Type: SAM QD 000 P40 CC; Serial: TP-1598

Measurement SW: DASYS2, Version 52.6 (1); SEMCAD X Version 14.4.2 (2595)

Left Head/Tilt/Zoom Scan (11x10x9)/Cube 0: Measurement grid: dx=4.3mm, dy=4.3mm, dz=3mm

Reference Value = 3.285 V/m; Power Drift = 0.07 dB

Peak SAR (extrapolated) = 0.159 W/kg

SAR(1 g) = 0.041 mW/g; SAR(10 g) = 0.016 mW/g

Info: Interpolated medium parameters used for SAR evaluation.

Maximum value of SAR (measured) = 0.073 mW/g

Left Head/Tilt/Area scan (91x101x1): Measurement grid: dx=15mm, dy=15mm

Info: Interpolated medium parameters used for SAR evaluation.

Maximum value of SAR (interpolated) = 0.088 mW/g

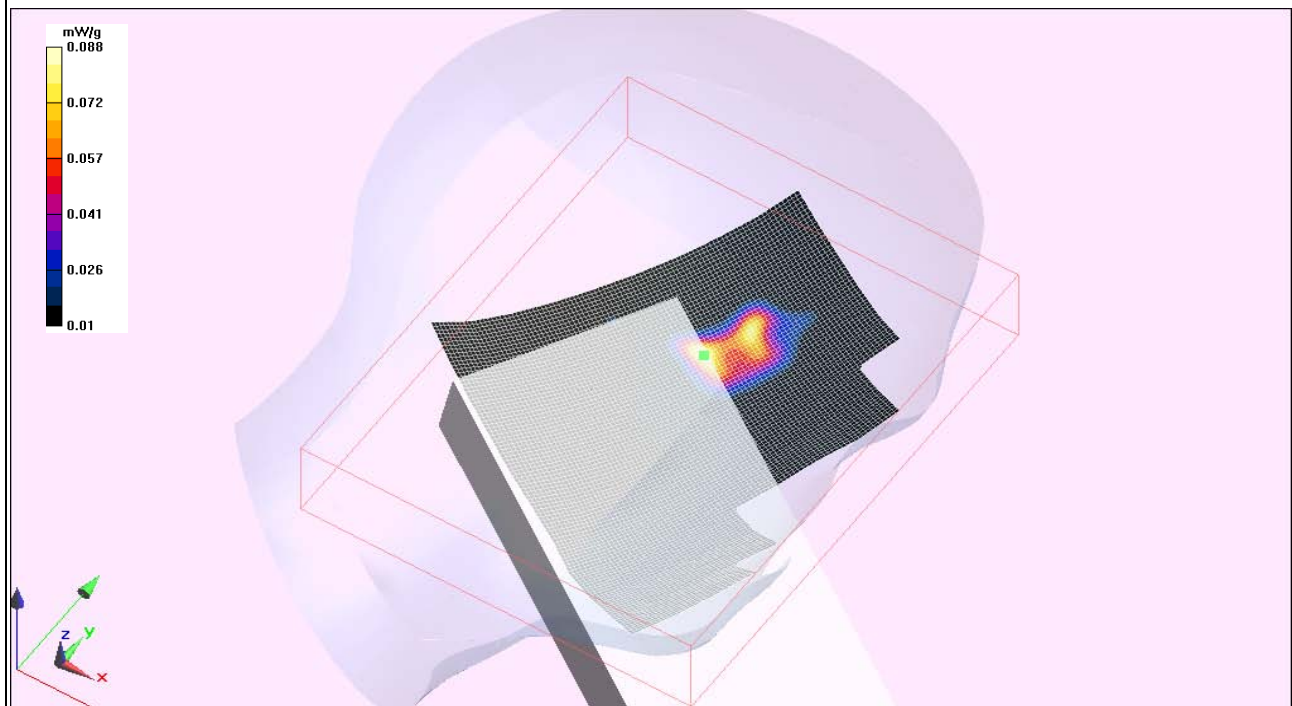

Room Temperature (°C):	22.9	Liquid Temperature (°C):	21.4	Humidity (%):	37	Test Date:	01/27/11
------------------------	------	--------------------------	------	---------------	----	------------	----------

5300MHz band 7.2Mbps Right Head A1 Tests 27-28 1-27-11

DUT: 1000CP01U Hand Held Computer; Type: CN70; Serial: 24411047012

Communication System: CW; Communication System Band: D5GHz (5000.0 - 6000.0 MHz); Frequency: 5260 MHz; Communication System PAR: 0 dB

Medium parameters used: $\sigma = 4.83647$ mho/m, $\epsilon_r = 36.2405$; $\rho = 1000$ kg/m³, Medium parameters used (interpolated): $f = 5260$ MHz; $\sigma = 4.848$ mho/m; $\epsilon_r = 36.221$; $\rho = 1000$ kg/m³

Phantom section: Right Section

Measurement Standard: DASYS (IEEE/IEC/ANSI C63.19-2007)

DASYS Configuration:

Probe: EX3DV4 - SN3746; ConvF(4.37, 4.37, 4.37); Calibrated: 11/11/2010

Modulation Compensation: Not Used

Sensor-Surface: 2mm (Mechanical Surface Detection)

Electronics: DAE4 Sn1237; Calibrated: 11/10/2010

Phantom: SAM with CRP; Type: SAM QD 000 P40 CC; Serial: TP-1598

Measurement SW: DASYS2, Version 52.6 (1); SEMCAD X Version 14.4.2 (2595)

Right Head/Touch/Zoom Scan 3 (9x8x11)/Cube 0: Measurement grid: dx=4.3mm, dy=4.3mm, dz=3mm

Reference Value = 2.522 V/m; Power Drift = -1.34 dB

Peak SAR (extrapolated) = 0.187 W/kg

SAR(1 g) = 0.021 mW/g; SAR(10 g) = 0.00717 mW/g

Maximum value of SAR (measured) = 0.044 mW/g

Right Head/Touch/Area scan (91x81x1): Measurement grid: dx=15mm, dy=15mm

Maximum value of SAR (interpolated) = 0.089 mW/g

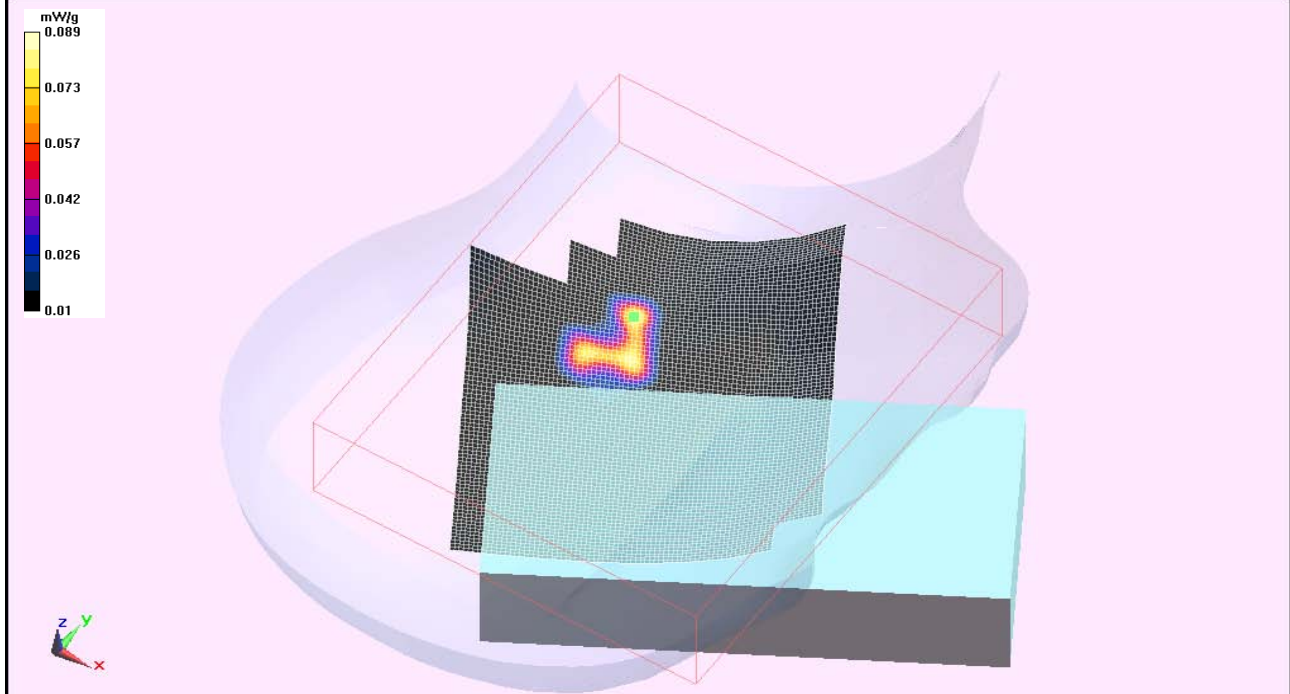

Room Temperature (°C):	22.9	Liquid Temperature (°C):	21.4	Humidity (%):	37	Test Date:	01/27/11
------------------------	------	--------------------------	------	---------------	----	------------	----------

5300MHz band 7.2Mbps Right Head A1 Tests 27-28 1-27-11

DUT: 1000CP01U Hand Held Computer; Type: CN70; Serial: 24411047012

Communication System: CW; Communication System Band: D5GHz (5000.0 - 6000.0 MHz); Frequency: 5260 MHz; Communication System PAR: 0 dB

Medium parameters used: $\sigma = 4.83647$ mho/m, $\epsilon_r = 36.2405$; $\rho = 1000$ kg/m³, Medium parameters used (interpolated): $f = 5260$ MHz; $\sigma = 4.848$ mho/m; $\epsilon_r = 36.221$; $\rho = 1000$ kg/m³

Phantom section: Right Section

Measurement Standard: DASYS (IEEE/IEC/ANSI C63.19-2007)

DASY5 Configuration:

Probe: EX3DV4 - SN3746; ConvF(4.37, 4.37, 4.37); Calibrated: 11/11/2010

Modulation Compensation: Not Used

Sensor-Surface: 2mm (Mechanical Surface Detection)

Electronics: DAE4 Sn1237; Calibrated: 11/10/2010

Phantom: SAM with CRP; Type: SAM QD 000 P40 CC; Serial: TP-1598

Measurement SW: DASY52, Version 52.6 (1); SEMCAD X Version 14.4.2 (2595)

Right Head/Tilt/Zoom Scan (10x12x9)/Cube 0: Measurement grid: dx=4.3mm, dy=4.3mm, dz=3mm

Reference Value = 2.272 V/m; Power Drift = 0.33 dB

Peak SAR (extrapolated) = 0.171 W/kg

SAR(1 g) = 0.013 mW/g; SAR(10 g) = 0.00218 mW/g

Maximum value of SAR (measured) = 0.046 mW/g

Right Head/Tilt/Area scan (91x101x1): Measurement grid: dx=15mm, dy=15mm

Maximum value of SAR (interpolated) = 0.050 mW/g

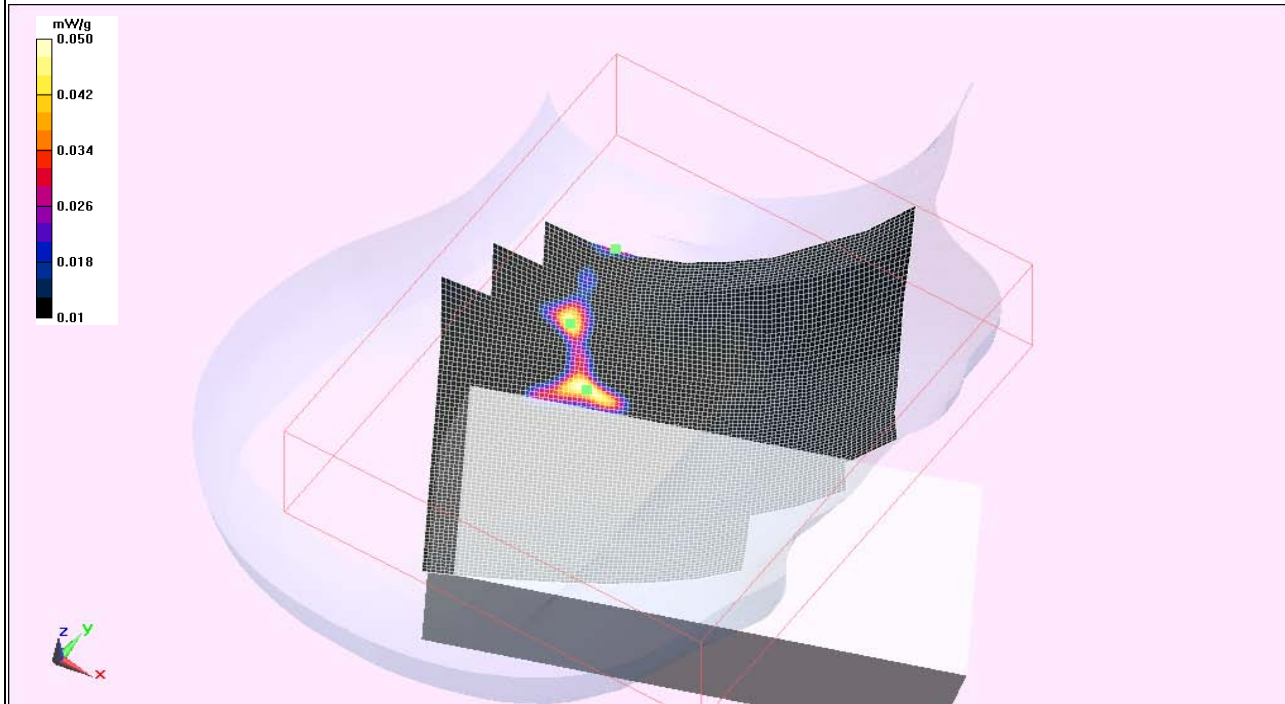

5600MHz band 6 Mbps Left Head A1 Tests 37 1-25-11

DUT: 1000CP01U Hand Held Computer; Type: CN70; Serial: 24411047012

Communication System: CW; Communication System Band: D5GHz (5000.0 - 6000.0 MHz); Frequency: 5600 MHz; Communication System PAR: 0 dB
Medium parameters used: $\sigma = 5.12761$ mho/m, $\epsilon_r = 36.8278$; $\rho = 1000$ kg/m³, Medium parameters used: $f = 5600$ MHz; $\sigma = 5.128$ mho/m; $\epsilon_r = 36.828$; $\rho = 1000$ kg/m³
Phantom section: Left Section
Measurement Standard: DASYS (IEEE/IEC/ANSI C63.19-2007)

DASYS Configuration:

Probe: EX3DV4 - SN3746; ConvF(4.37, 4.37, 4.37); Calibrated: 11/11/2010
Modulation Compensation: Not Used
Sensor-Surface: 2mm (Mechanical Surface Detection)
Electronics: DAE4 Sn1237; Calibrated: 11/10/2010
Phantom: SAM with CRP; Type: SAM; Serial: 1598
Measurement SW: DASYS2, Version 52.6 (1); SEMCAD X Version 14.4.2 (2595)

Left Head/Touch/Zoom Scan (8x8x9)/Cube 0: Measurement grid: dx=4.3mm, dy=4.3mm, dz=3mm
Reference Value = 3.847 V/m; Power Drift = -0.23 dB
Peak SAR (extrapolated) = 0.289 W/kg
SAR(1 g) = 0.093 mW/g; SAR(10 g) = 0.045 mW/g
Maximum value of SAR (measured) = 0.156 mW/g

Left Head/Touch/Area scan (121x101x1): Measurement grid: dx=10mm, dy=10mm
Maximum value of SAR (interpolated) = 0.175 mW/g

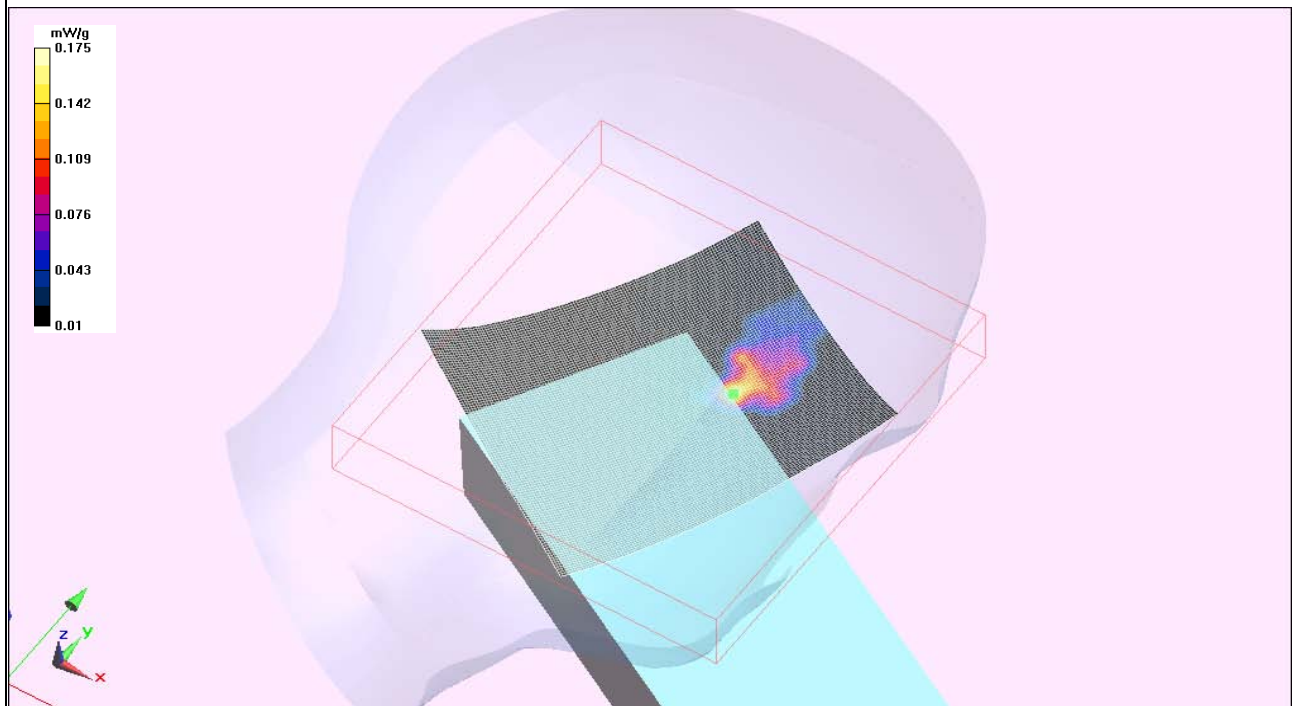

Room Temperature (°C):	22.3	Liquid Temperature (°C):	22.4	Humidity (%):	42	Test Date:	01/25/11
------------------------	------	--------------------------	------	---------------	----	------------	----------

5600MHz band 6 Mbps Left Head A1 Tests 38 1-25-11

DUT: 1000CP01U Hand Held Computer; Type: CN70; Serial: 24411047012

Communication System: CW; Communication System Band: D5GHz (5000.0 - 6000.0 MHz); Frequency: 5600 MHz; Communication System PAR: 0 dB

Medium parameters used: $\sigma = 5.12761$ mho/m, $\epsilon_r = 36.8278$; $\rho = 1000$ kg/m³, Medium parameters used: $f = 5600$ MHz; $\sigma = 5.128$ mho/m; $\epsilon_r = 36.828$; $\rho = 1000$ kg/m³

Phantom section: Left Section

Measurement Standard: DASYS (IEEE/IEC/ANSI C63.19-2007)

DASY5 Configuration:

Probe: EX3DV4 - SN3746; ConvF(4.37, 4.37, 4.37); Calibrated: 11/11/2010

Modulation Compensation: Not Used

-Surface: 2mm (Mechanical Surface Detection)

Electronics: DAE4 Sn1237; Calibrated: 11/10/2010

Phantom: SAM with CRP; Type: SAM; Serial: 1598

Measurement SW: DASYS2, Version 52.6 (1); SEMCAD X Version 14.4.2 (2595)

Left Head/Tilt/Zoom Scan (8x9x9)/Cube 0: Measurement grid: dx=4.3mm, dy=4.3mm, dz=3mm

Reference Value = 2.805 V/m; Power Drift = 0.08 dB

Peak SAR (extrapolated) = 0.146 W/kg

SAR(1 g) = 0.035 mW/g; SAR(10 g) = 0.020 mW/g

Maximum value of SAR (measured) = 0.060 mW/g

Left Head/Tilt/Area scan (121x101x1): Measurement grid: dx=10mm, dy=10mm

Maximum value of SAR (interpolated) = 0.060 mW/g

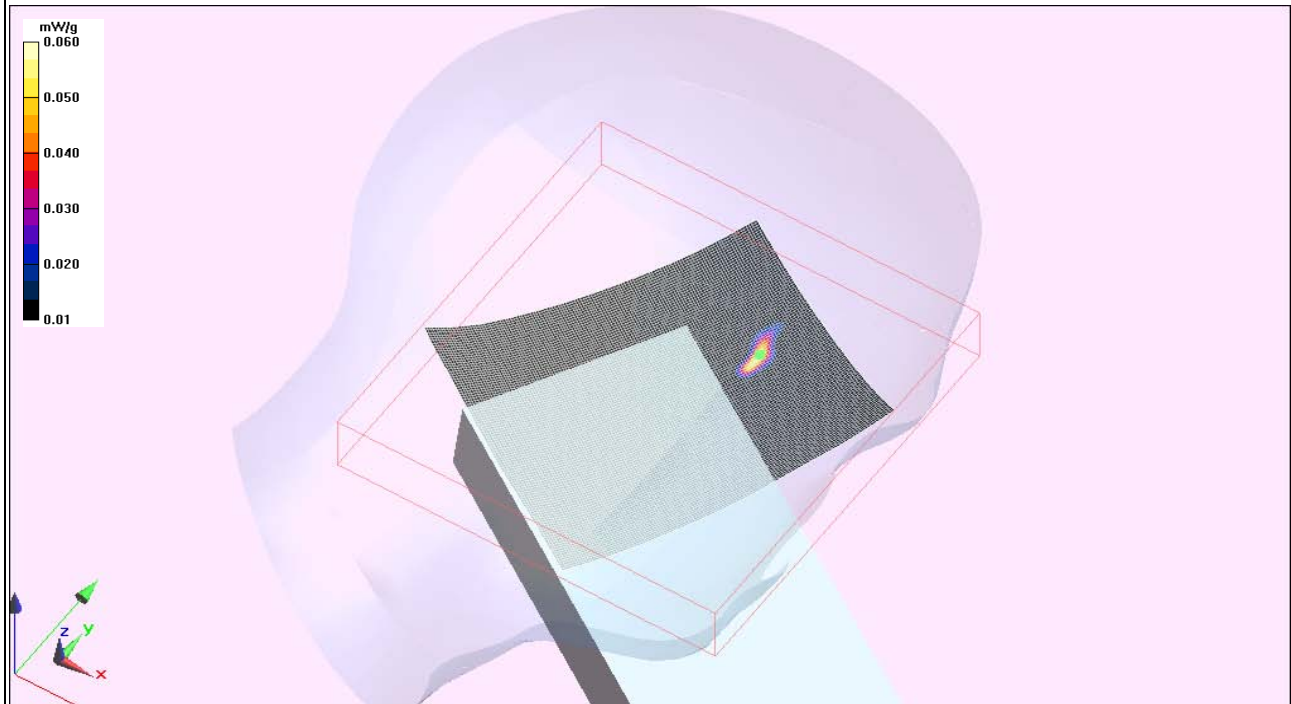

Room Temperature (°C):	23	Liquid Temperature (°C):	20.8	Humidity (%):	42	Test Date:	01/26/11
------------------------	----	--------------------------	------	---------------	----	------------	----------

5600MHz band 6 Mbps Right Head A1 Tests 39-40 1-25-11

DUT: 1000CP01U Hand Held Computer; Type: CN70; Serial: 24411047012

Communication System: CW; Communication System Band: D5GHz (5000.0 - 6000.0 MHz); Frequency: 5600 MHz; Communication System PAR: 0 dB
 Medium parameters used: $\sigma = 5.16906$ mho/m, $\epsilon_r = 35.047$; $\rho = 1000$ kg/m³, Medium parameters used: $f = 5600$ MHz; $\sigma = 5.169$ mho/m; $\epsilon_r = 35.047$; $\rho = 1000$ kg/m³
 Phantom section: Right Section
 Measurement Standard: DASYS (IEEE/IEC/ANSI C63.19-2007)

DASYS Configuration:

Probe: EX3DV4 - SN3746; ConvF(4.37, 4.37, 4.37); Calibrated: 11/11/2010
 Modulation Compensation: Not Used
 Sensor-Surface: 2mm (Mechanical Surface Detection)
 Electronics: DAE4 Sn1237; Calibrated: 11/10/2010
 Phantom: SAM with CRP; Type: SAM QD 000 P40 CC; Serial: TP-1598
 Measurement SW: DASYS2, Version 52.6 (1); SEMCAD X Version 14.4.2 (2595)

Right Head/Touch/Zoom Scan 2 (10x9x9)/Cube 0: Measurement grid: dx=4.3mm, dy=4.3mm, dz=3mm
 Reference Value = 1.341 V/m; Power Drift = 1.95 dB
 Peak SAR (extrapolated) = 0.216 W/kg
SAR(1 g) = 0.027 mW/g; SAR(10 g) = 0.00839 mW/g
 Maximum value of SAR (measured) = 0.046 mW/g

Right Head/Touch/Zoom Scan (10x10x9)/Cube 0: Measurement grid: dx=4.3mm, dy=4.3mm, dz=3mm
 Reference Value = 1.341 V/m; Power Drift = 2.38 dB
 Peak SAR (extrapolated) = 0.197 W/kg
 SAR(1 g) = 0.023 mW/g; SAR(10 g) = 0.00896 mW/g
 Maximum value of SAR (measured) = 0.042 mW/g

Right Head/Touch/Area scan (91x81x1): Measurement grid: dx=15mm, dy=15mm
 Maximum value of SAR (interpolated) = 0.070 mW/g

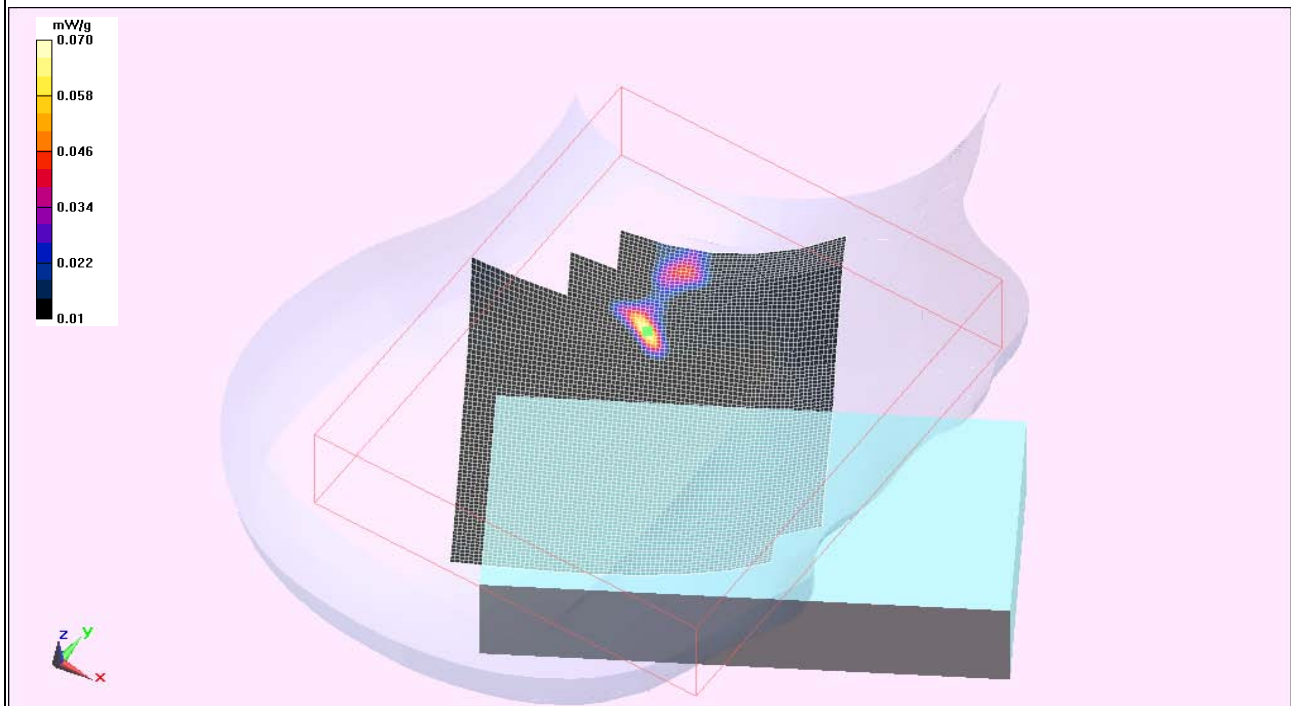

Room Temperature (°C):	23	Liquid Temperature (°C):	20.8	Humidity (%):	42	Test Date:	01/26/11
------------------------	----	--------------------------	------	---------------	----	------------	----------

5600MHz band 6 Mbps Right Head A1 Tests 39-40 1-25-11

DUT: 1000CP01U Hand Held Computer; Type: CN70; Serial: 24411047012

Communication System: CW; Communication System Band: D5GHz (5000.0 - 6000.0 MHz); Frequency: 5600 MHz; Communication System PAR: 0 dB
 Medium parameters used: $\sigma = 5.16906$ mho/m, $\epsilon_r = 35.047$; $\rho = 1000$ kg/m³, Medium parameters used: $f = 5600$ MHz; $\sigma = 5.169$ mho/m; $\epsilon_r = 35.047$; $\rho = 1000$ kg/m³
 Phantom section: Right Section
 Measurement Standard: DASYS (IEEE/IEC/ANSI C63.19-2007)

DASY5 Configuration:

Probe: EX3DV4 - SN3746; ConvF(4.37, 4.37, 4.37); Calibrated: 11/11/2010
 Modulation Compensation: Not Used
 Sensor-Surface: 2mm (Mechanical Surface Detection)
 Electronics: DAE4 Sn1237; Calibrated: 11/10/2010
 Phantom: SAM with CRP; Type: SAM QD 000 P40 CC; Serial: TP-1598
 Measurement SW: DASY52, Version 52.6 (1); SEMCAD X Version 14.4.2 (2595)

Right Head/Tilt/Zoom Scan (10x9x9)/Cube 0: Measurement grid: dx=4.3mm, dy=4.3mm, dz=3mm
 Reference Value = 2.097 V/m; Power Drift = -0.04 dB
 Peak SAR (extrapolated) = 0.183 W/kg
 SAR(1 g) = 0.00331 mW/g; SAR(10 g) = 0.000333 mW/g
 Maximum value of SAR (measured) = 0.183 mW/g

Right Head/Tilt/Zoom Scan 2 (9x9x9)/Cube 0: Measurement grid: dx=4.3mm, dy=4.3mm, dz=3mm
 Reference Value = 2.097 V/m; Power Drift = -0.42 dB
 Peak SAR (extrapolated) = 0.131 W/kg
SAR(1 g) = 0.011 mW/g; SAR(10 g) = 0.00175 mW/g
 Maximum value of SAR (measured) = 0.029 mW/g

Right Head/Tilt/Area scan (91x101x1): Measurement grid: dx=15mm, dy=15mm
 Maximum value of SAR (interpolated) = 0.025 mW/g

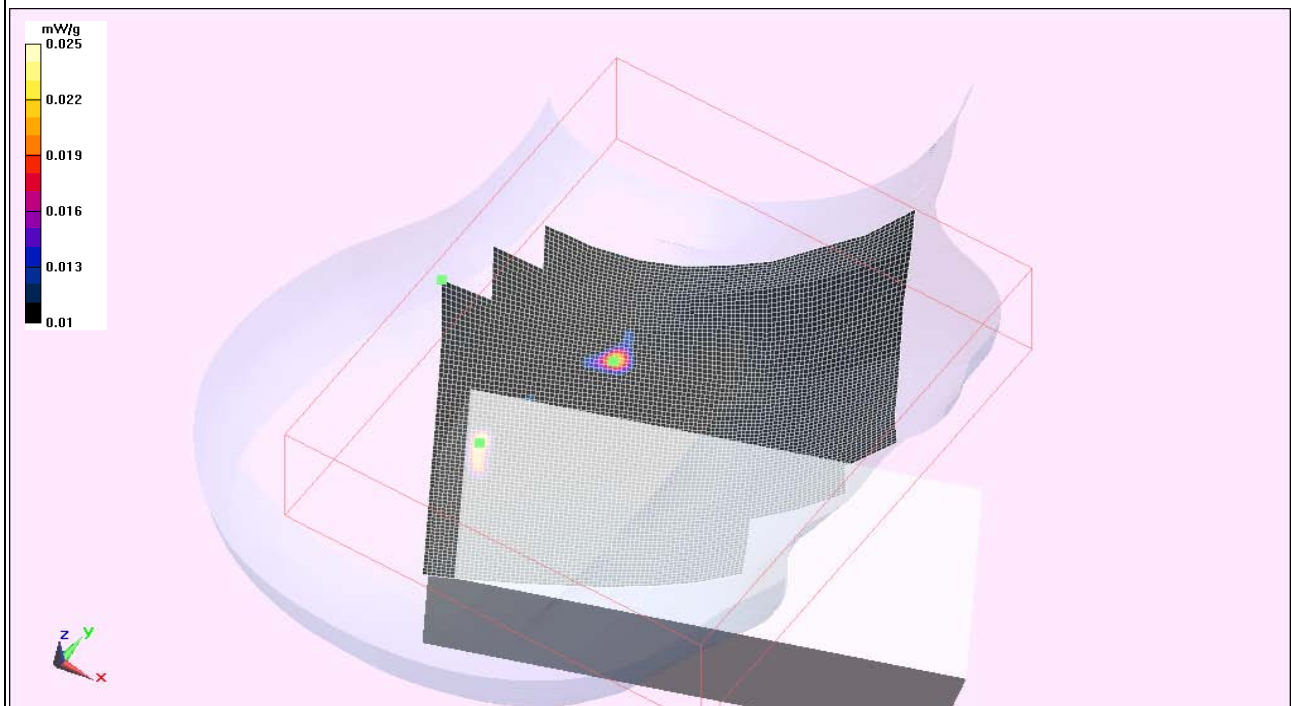

Room Temperature (°C):	22.3	Liquid Temperature (°C):	22.4	Humidity (%):	42	Test Date:	01/25/11
------------------------	------	--------------------------	------	---------------	----	------------	----------

5800MHz band 6 Mbps Left Head A1 Tests 49 1-25-11

DUT: 1000CP01U Hand Held Computer; Type: CN70; Serial: 24411047012

Communication System: CW; Communication System Band: D5GHz (5000.0 - 6000.0 MHz); Frequency: 5745 MHz; Communication System PAR: 0 dB
Medium parameters used: $\sigma = 5.46208$ mho/m, $\epsilon_r = 36.5963$; $\rho = 1000$ kg/m³, Medium parameters used: $f = 5745$ MHz; $\sigma = 5.462$ mho/m; $\epsilon_r = 36.596$; $\rho = 1000$ kg/m³
Phantom section: Left Section
Measurement Standard: DASYS (IEEE/IEC/ANSI C63.19-2007)

DASYS Configuration:

Probe: EX3DV4 - SN3746; ConvF(4.14, 4.14, 4.14); Calibrated: 11/11/2010
Modulation Compensation: Not Used
Sensor-Surface: 2mm (Mechanical Surface Detection)
Electronics: DAE4 Sn1237; Calibrated: 11/10/2010
Phantom: SAM with CRP; Type: SAM; Serial: 1598
Measurement SW: DASYS2, Version 52.6 (1); SEMCAD X Version 14.4.2 (2595)

Left Head/Touch/Zoom Scan (10x10x9)/Cube 0: Measurement grid: dx=4.3mm, dy=4.3mm, dz=3mm
Reference Value = 4.687 V/m; Power Drift = -0.34 dB
Peak SAR (extrapolated) = 0.275 W/kg
SAR(1 g) = 0.081 mW/g; SAR(10 g) = 0.030 mW/g
Maximum value of SAR (measured) = 0.165 mW/g

Left Head/Touch/Area scan (141x101x1): Measurement grid: dx=10mm, dy=10mm
Maximum value of SAR (interpolated) = 0.326 mW/g

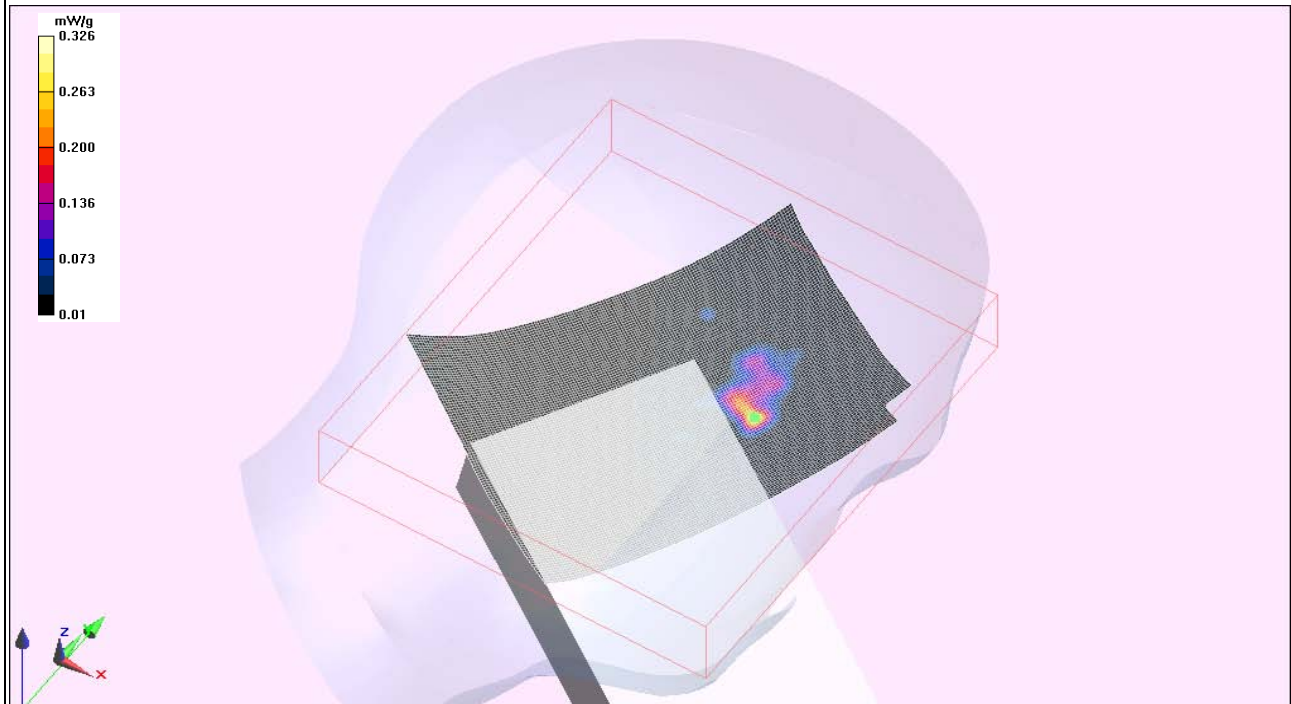

Room Temperature (°C):	22.3	Liquid Temperature (°C):	22.4	Humidity (%):	42	Test Date:	01/25/11
------------------------	------	--------------------------	------	---------------	----	------------	----------

5800MHz band 6 Mbps Left Head A1 Tests 50 1-25-11

DUT: 1000CP01U Hand Held Computer; Type: CN70; Serial: 24411047012

Communication System: CW; Communication System Band: D5GHz (5000.0 - 6000.0 MHz); Frequency: 5745 MHz; Communication System PAR: 0 dB

Medium parameters used: $\sigma = 5.46208$ mho/m, $\epsilon_r = 36.5963$; $\rho = 1000$ kg/m³, Medium parameters used: $f = 5745$ MHz; $\sigma = 5.462$ mho/m; $\epsilon_r = 36.596$; $\rho = 1000$ kg/m³

Phantom section: Left Section

Measurement Standard: DASYS (IEEE/IEC/ANSI C63.19-2007)

DASY5 Configuration:

Probe: EX3DV4 - SN3746; ConvF(4.14, 4.14, 4.14); Calibrated: 11/11/2010

Modulation Compensation: Not Used

Sensor-Surface: 2mm (Mechanical Surface Detection)

Electronics: DAE4 Sn1237; Calibrated: 11/10/2010

Phantom: SAM with CRP; Type: SAM; Serial: 1598

Measurement SW: DASYS2, Version 52.6 (1); SEMCAD X Version 14.4.2 (2595)

Left Head/Tilt/Zoom Scan (10x10x9)/Cube 0: Measurement grid: dx=4.3mm, dy=4.3mm, dz=3mm

Reference Value = 3.698 V/m; Power Drift = 0.23 dB

Peak SAR (extrapolated) = 0.197 W/kg

SAR(1 g) = 0.065 mW/g; SAR(10 g) = 0.034 mW/g

Maximum value of SAR (measured) = 0.103 mW/g

Left Head/Tilt/Area scan (121x101x1): Measurement grid: dx=10mm, dy=10mm

Maximum value of SAR (interpolated) = 0.103 mW/g

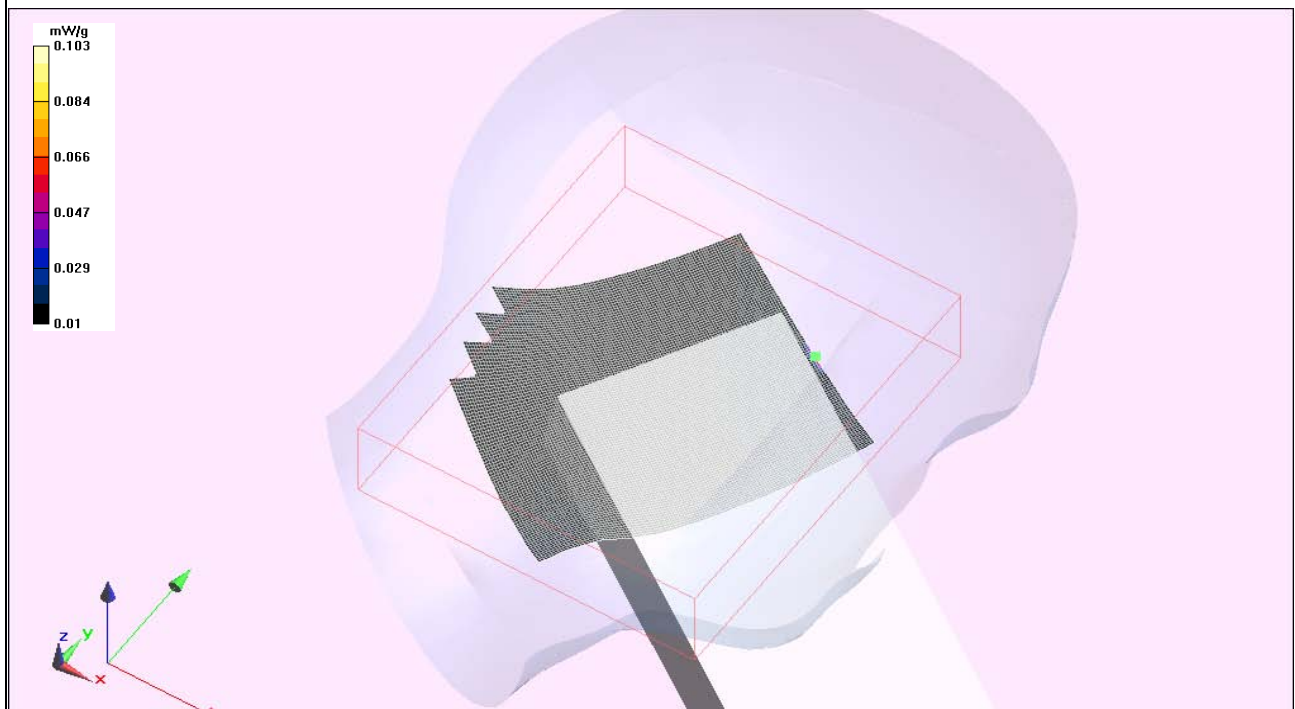

Room Temperature (°C):	22.5	Liquid Temperature (°C):	22.5	Humidity (%):	39	Test Date:	01/24/11
------------------------	------	--------------------------	------	---------------	----	------------	----------

5800MHz band 1Mbps Right Head A1 Tests 51 1-24-11

DUT: 1000CP01U Hand Held Computer; Type: CN70; Serial: 24411047012

Communication System: CW; Communication System Band: D5GHz (5000.0 - 6000.0 MHz); Frequency: 5745 MHz; Communication System PAR: 0 dB
Medium parameters used: $\sigma = 5.46208$ mho/m, $\epsilon_r = 36.5963$; $\rho = 1000$ kg/m³, Medium parameters used: $f = 5745$ MHz; $\sigma = 5.462$ mho/m; $\epsilon_r = 36.596$; $\rho = 1000$ kg/m³

Phantom section: Right Section

Measurement Standard: DASYS (IEEE/IEC/ANSI C63.19-2007)

DASYS Configuration:

Probe: EX3DV4 - SN3746; ConvF(4.14, 4.14, 4.14); Calibrated: 11/11/2010

Modulation Compensation: Not Used

Sensor-Surface: 2mm (Mechanical Surface Detection)

Electronics: DAE4 Sn1237; Calibrated: 11/10/2010

Phantom: SAM with CRP; Type: SAM QD 000 P40 CC; Serial: TP-1598

Measurement SW: DASYS2, Version 52.6 (1); SEMCAD X Version 14.4.2 (2595)

Right Head/Touch/Z Scan (1x1x21): Measurement grid: dx=20mm, dy=20mm, dz=5mm

Maximum value of Total (measured) = 2.799 V/m

Right Head/Touch/Zoom Scan (7x7x9)/Cube 0: Measurement grid: dx=4.3mm, dy=4.3mm, dz=3mm

Reference Value = 2.436 V/m; Power Drift = -0.57 dB

Peak SAR (extrapolated) = 0.236 W/kg

SAR(1 g) = 0.025 mW/g; SAR(10 g) = 0.00789 mW/g

Maximum value of SAR (measured) = 0.052 mW/g

Right Head/Touch/Area scan (71x121x1): Measurement grid: dx=15mm, dy=15mm

Maximum value of SAR (interpolated) = 0.078 mW/g

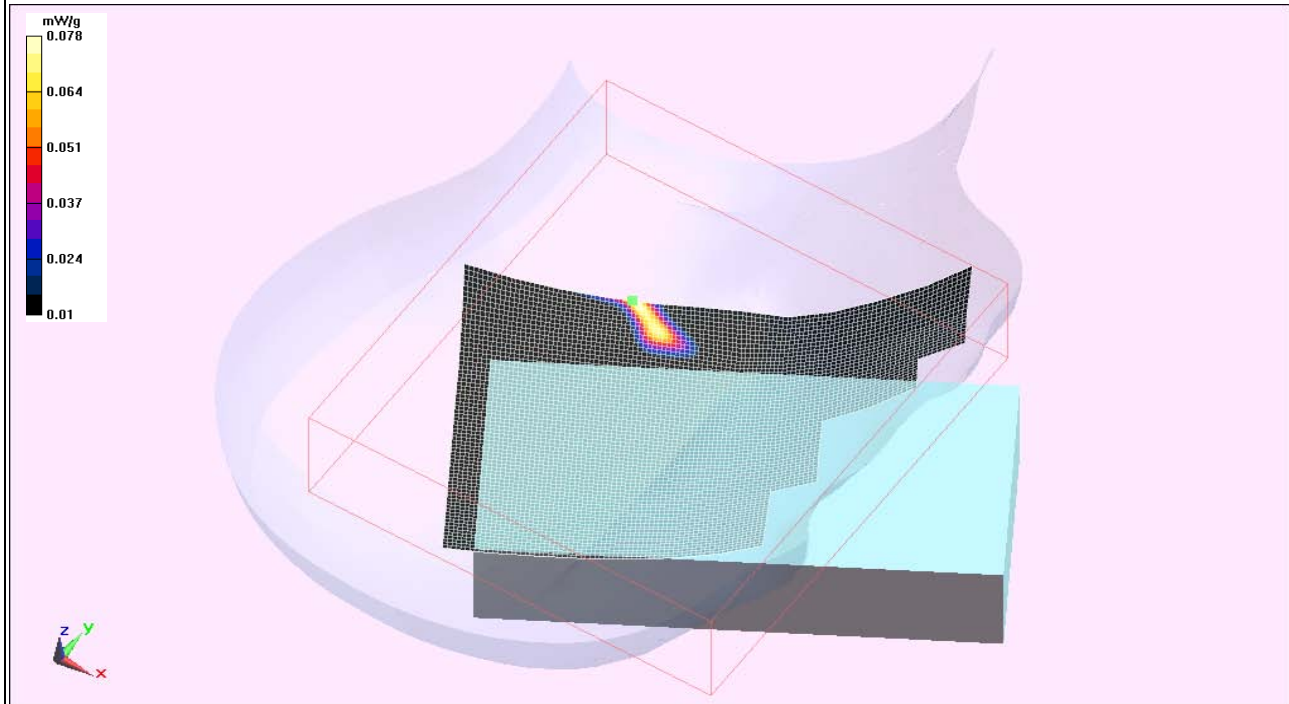

Room Temperature (°C):	22.5	Liquid Temperature (°C):	22.5	Humidity (%):	39	Test Date:	01/24/11
------------------------	------	--------------------------	------	---------------	----	------------	----------

5800MHz band 1Mbps Right Head A1 Tests 52 1-24-11

DUT: 1000CP01U Hand Held Computer; Type: CN70; Serial: 24411047012

Communication System: CW; Communication System Band: D5GHz (5000.0 - 6000.0 MHz); Frequency: 5745 MHz; Communication System PAR: 0 dB

Medium parameters used: $\sigma = 5.46208$ mho/m, $\epsilon_r = 36.5963$; $\rho = 1000$ kg/m³, Medium parameters used: $f = 5745$ MHz; $\sigma = 5.462$ mho/m; $\epsilon_r = 36.596$; $\rho = 1000$ kg/m³

Phantom section: Right Section

Measurement Standard: DASYS (IEEE/IEC/ANSI C63.19-2007)

DASY5 Configuration:

Probe: EX3DV4 - SN3746; ConvF(4.14, 4.14, 4.14); Calibrated: 11/11/2010

Modulation Compensation: Not Used

-Surface: 2mm (Mechanical Surface Detection)

Electronics: DAE4 Sn1237; Calibrated: 11/10/2010

Phantom: SAM with CRP; Type: SAM QD 000 P40 CC; Serial: TP-1598

Measurement SW: DASY52, Version 52.6 (1); SEMCAD X Version 14.4.2 (2595)

Right Head/Tilt/Zoom Scan (9x9x9)/Cube 0: Measurement grid: dx=4.3mm, dy=4.3mm, dz=3mm

Reference Value = 2.950 V/m; Power Drift = -0.89 dB

Peak SAR (extrapolated) = 0.240 W/kg

SAR(1 g) = 0.030 mW/g; SAR(10 g) = 0.013 mW/g

Maximum value of SAR (measured) = 0.051 mW/g

Right Head/Tilt/Area scan (141x101x1): Measurement grid: dx=10mm, dy=10mm

Maximum value of SAR (interpolated) = 0.039 mW/g

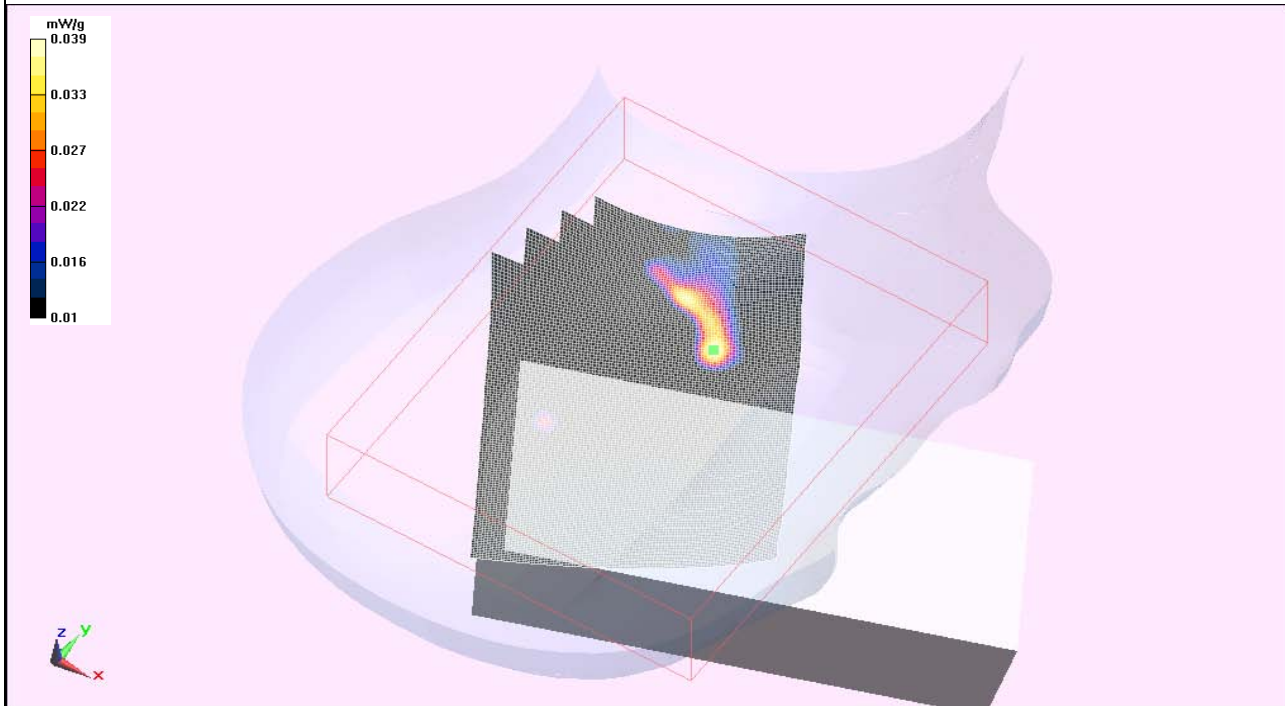

Room Temperature (°C):	22.3	Liquid Temperature (°C):	22.4	Humidity (%):	42	Test Date:	01/25/11
------------------------	------	--------------------------	------	---------------	----	------------	----------

5600MHz band 6 Mbps Left Head A1 Tests 37 1-25-11

DUT: 1000CP01U Hand Held Computer; Type: CN70; Serial: 24411047012

Left Head/Touch/Z Scan (1x1x21): Measurement grid: dx=20mm, dy=20mm, dz=5mm
Maximum value of Total (measured) = 2.390 V/m

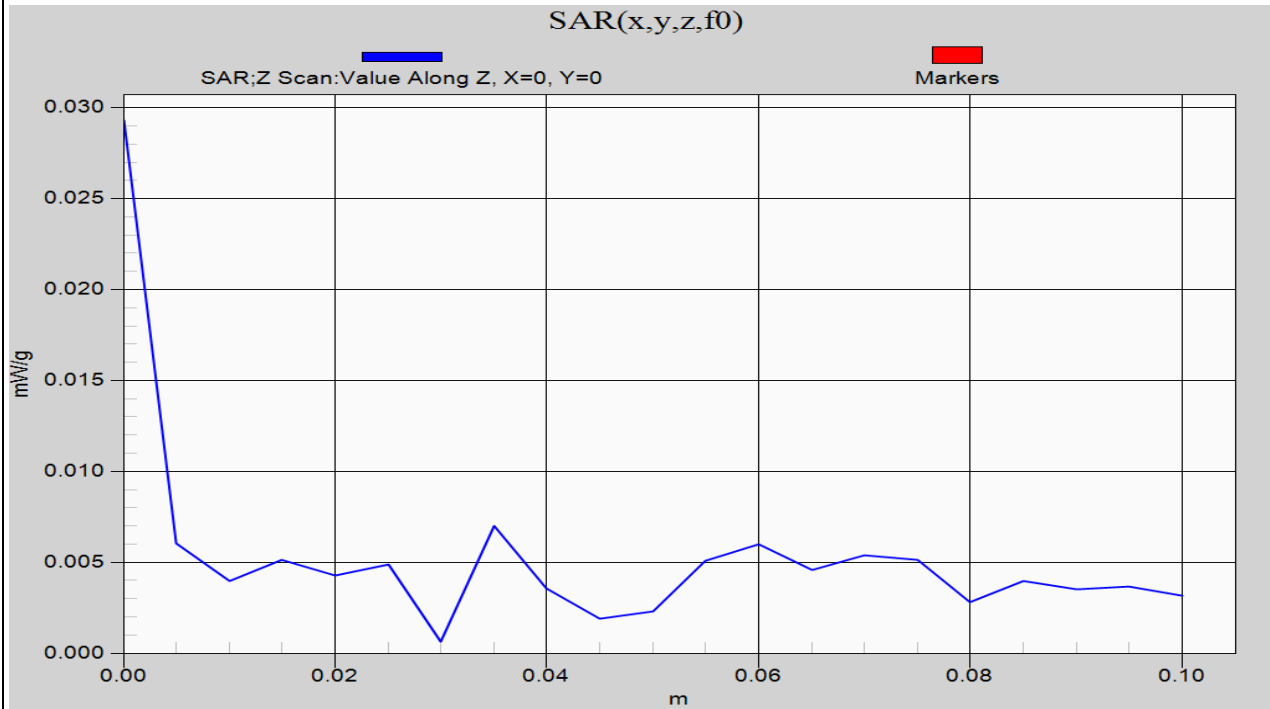

NORTHWEST		EMC		SAR TEST DATA				XMit 2011.01.18			
EUT:	1000CP01U	Work Order:	INMC0570								
Serial Number:	24411047012	Date:	See Data Sheets								
Customer:	Intermec Technologies	Temperature:	See Data Sheets								
Attendees:	None	Humidity:	See Data Sheets								
Project:	INMC0570	Barometric Pres.:	See Data Sheets								
Tested by:	Jennifer Herrett	Job Site:	EV08								
TEST SPECIFICATIONS				Test Method							
FCC 2.1093:2011				FCC OET 65C:2001							
FCC 15.247:2011				IEEE Std 1528:2003							
FCC 15.407:2001				FCC KDB 447498 D01 v04							
Health Safety Code 6:2009				FCC KDB 248227 D01 V01r02							
COMMENTS				FCC KDB 648474 D01 V01r05							
None				FCC 865664							
DEVIATIONS FROM TEST STANDARD				RSS-102, Issue 4:2010							
No Deviations											
Configuration #	1	Signature <i>Jennifer Herrett</i>									

Test Configuration	Frequency Band	Body-Worn Accessory	Transmit Frequency	Transmit Channel	Transmit Mode	Data Rate (Mbps)	Audio Accessory	EUT Position	Start Power (Conducted)	SAR Drift During Test (dB)	1g SAR Level	Test #
Body	5200	Holster	5180	36	OFDM	6Mbps	None	Right	13.4	-0.2	0.303	13
								Front	13.4	Note 2	0.080	14
	5300	Holster	5260	52	OFDM	7.2Mbps	None	Right	13.2	-0.08	0.340	19
								Front	13.2	Note 2	0.068	20
	5600	Holster	5600	120	OFDM	6Mbps	None	Right	12.9	0.03	0.379	25
								Front	12.9	Note 2	0.065	26
	5800	Holster	5745	149	OFDM	6Mbps	None	Right	11.6	0.26	0.362	31
								Front	11.6	Note 2	0.062	32

Note 1: Zoom scan not performed, no hot spots detected, area scan results were less than the required system sensitivity of 0.01 mW/g.
 Note 2: Due to the low value of measured SAR, the SAR drift measurement was made close to the measurement noise floor and is therefore inaccurate

Room Temperature (°C):	22.1	Liquid Temperature (°C):	20.8	Humidity (%):	46	Test Date:	01/31/11
------------------------	------	--------------------------	------	---------------	----	------------	----------

5180MHz band CW-6Mbps Body Holstered Front A1 1-31-11 Test 14

DUT: 1000CP01U Hand Held Computer; Type: CN70; Serial: 24411047012

Communication System: CW; Communication System Band: D5GHz (5000.0 - 6000.0 MHz); Frequency: 5180 MHz; Communication System PAR: 0 dB

Medium parameters used: $\sigma = 5.39757$ mho/m, $\epsilon_r = 47.1358$; $\rho = 1000$ kg/m³, Medium parameters used (interpolated): $f = 5180$ MHz; $\sigma = 5.371$ mho/m; $\epsilon_r = 47.171$; $\rho = 1000$ kg/m³

Phantom section: Flat Section

Measurement Standard: DASYS (IEEE/IEC/ANSI C63.19-2007)

DASYS Configuration:

Probe: EX3DV4 - SN3746; ConvF(4.16, 4.16, 4.16); Calibrated: 11/11/2010

Modulation Compensation: Not Used

Sensor-Surface: 2mm (Mechanical Surface Detection)

Electronics: DAE4 Sn1237; Calibrated: 11/10/2010

Phantom: ELI 4.0; Type: QDOVA001BA; Serial:

Measurement SW: DASYS2, Version 52.6 (1); SEMCAD X Version 14.4.2 (2595)

Body/Front Holstered/Zoom Scan (8x9x9)/Cube 0: Measurement grid: dx=4mm, dy=4mm, dz=2.5mm

Reference Value = 0.938 V/m; Power Drift = 0.99 dB

Peak SAR (extrapolated) = 0.843 W/kg

SAR(1 g) = 0.080 mW/g; SAR(10 g) = 0.026 mW/g

Info: Interpolated medium parameters used for SAR evaluation.

Maximum value of SAR (measured) = 0.201 mW/g

Body/Front Holstered/Area scan (81x61x1): Measurement grid: dx=15mm, dy=15mm

Info: Interpolated medium parameters used for SAR evaluation.

Maximum value of SAR (interpolated) = 0.161 mW/g

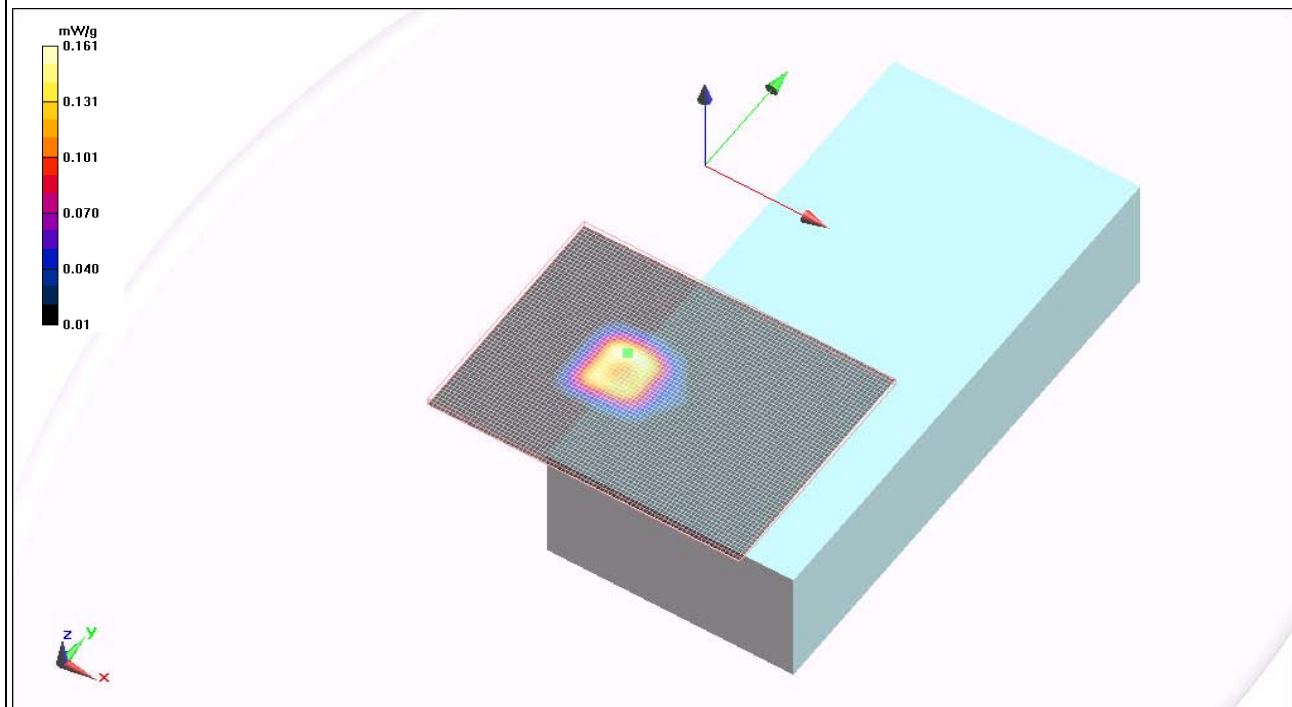

Room Temperature (°C):	22.1	Liquid Temperature (°C):	20.8	Humidity (%):	46	Test Date:	01/31/11
------------------------	------	--------------------------	------	---------------	----	------------	----------

5180MHz band CW-6Mbps Body Holstered Right A1 1-31-11 Test 13

DUT: 1000CP01U Hand Held Computer; Type: CN70; Serial: 24411047012

Communication System: CW; Communication System Band: D5GHz (5000.0 - 6000.0 MHz); Frequency: 5260 MHz; Communication System PAR: 0 dB

Medium parameters used: $\sigma = 5.46837$ mho/m, $\epsilon_r = 47.0231$; $\rho = 1000$ kg/m³, Medium parameters used (interpolated): $f = 5260$ MHz; $\sigma = 5.479$ mho/m; $\epsilon_r = 47.204$; $\rho = 1000$ kg/m³

Phantom section: Flat Section

Measurement Standard: DASYS (IEEE/IEC/ANSI C63.19-2007)

DASY5 Configuration:

Probe: EX3DV4 - SN3746; ConvF(3.8, 3.8, 3.8); Calibrated: 11/11/2010

Modulation Compensation: Not Used

Sensor-Surface: 2mm (Mechanical Surface Detection)

Electronics: DAE4 Sn1237; Calibrated: 11/10/2010

Phantom: ELI 4.0; Type: QDOVA001BA; Serial:

Measurement SW: DASY52, Version 52.6 (1); SEMCAD X Version 14.4.2 (2595)

Body/Right Holstered/Zoom Scan (8x8x9)/Cube 0: Measurement grid: dx=4mm, dy=4mm, dz=2.5mm

Reference Value = 9.125 V/m; Power Drift = -0.20 dB

Peak SAR (extrapolated) = 0.883 W/kg

SAR(1 g) = 0.303 mW/g; SAR(10 g) = 0.132 mW/g

Info: Interpolated medium parameters used for SAR evaluation.

Maximum value of SAR (measured) = 0.527 mW/g

Body/Right Holstered/Area scan (61x61x1): Measurement grid: dx=15mm, dy=15mm

Info: Interpolated medium parameters used for SAR evaluation.

Maximum value of SAR (interpolated) = 0.508 mW/g

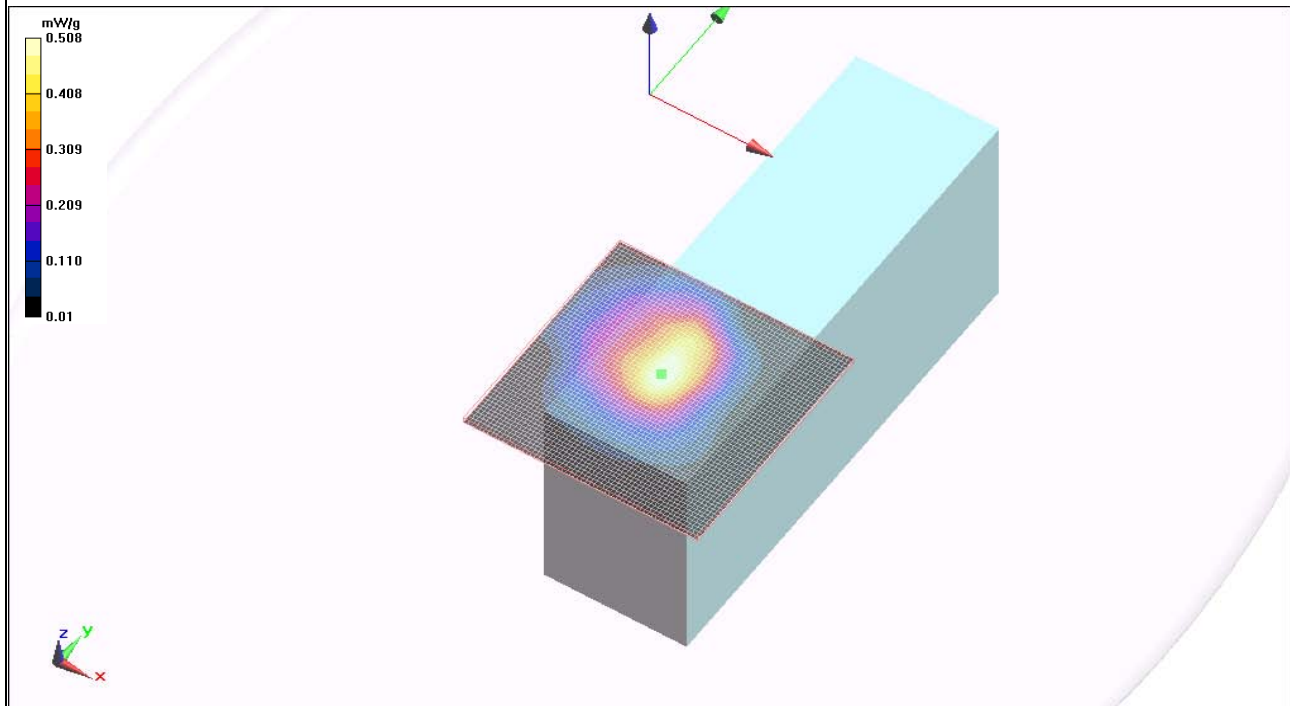

Room Temperature (°C):	22.1	Liquid Temperature (°C):	20.8	Humidity (%):	46	Test Date:	01/31/11
------------------------	------	--------------------------	------	---------------	----	------------	----------

5260MHz band CW-7.2Mbps Body Holstered Front A1 1-31-11 Test 20

DUT: 1000CP01U Hand Held Computer; Type: CN70; Serial: 24411047012

Communication System: CW; Communication System Band: D5GHz (5000.0 - 6000.0 MHz); Frequency: 5260 MHz; Communication System PAR: 0 dB

Medium parameters used: $\sigma = 5.46837$ mho/m, $\epsilon_r = 47.0231$; $\rho = 1000$ kg/m³, Medium parameters used (interpolated): $f = 5260$ MHz; $\sigma = 5.479$ mho/m; $\epsilon_r = 47.204$; $\rho = 1000$ kg/m³

Phantom section: Flat Section

Measurement Standard: DASYS (IEEE/IEC/ANSI C63.19-2007)

DASYS Configuration:

Probe: EX3DV4 - SN3746; ConvF(3.8, 3.8, 3.8); Calibrated: 11/11/2010

Modulation Compensation: Not Used

Sensor-Surface: 2mm (Mechanical Surface Detection)

Electronics: DAE4 Sn1237; Calibrated: 11/10/2010

Phantom: ELI 4.0; Type: QDOVA001BA; Serial:

Measurement SW: DASYS2, Version 52.6 (1); SEMCAD X Version 14.4.2 (2595)

Body/Front Holstered/Zoom Scan (10x8x9)/Cube 0: Measurement grid: dx=4mm, dy=4mm, dz=2.5mm

Reference Value = 0.730 V/m; Power Drift = 2.62 dB

Peak SAR (extrapolated) = 0.237 W/kg

SAR(1 g) = 0.068 mW/g; SAR(10 g) = 0.030 mW/g

Info: Interpolated medium parameters used for SAR evaluation.

Maximum value of SAR (measured) = 0.122 mW/g

Body/Front Holstered/Area scan (81x61x1): Measurement grid: dx=15mm, dy=15mm

Info: Interpolated medium parameters used for SAR evaluation.

Maximum value of SAR (interpolated) = 0.163 mW/g

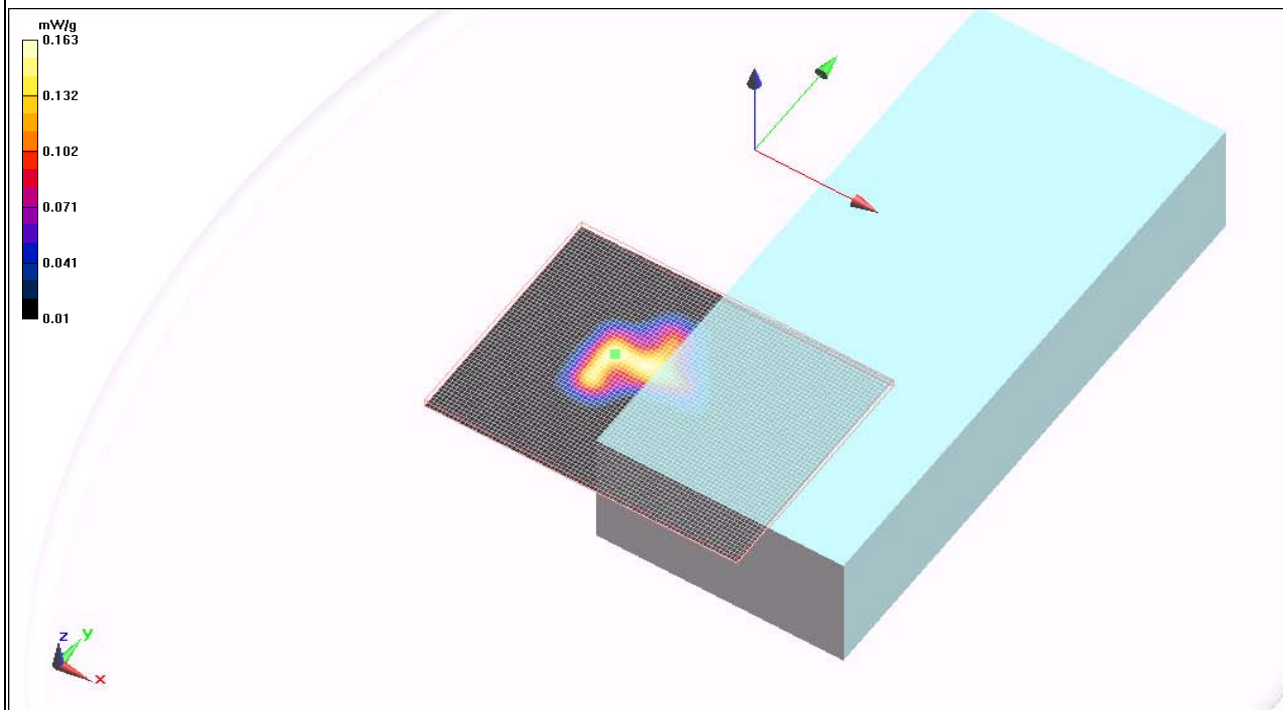

Room Temperature (°C):	22.1	Liquid Temperature (°C):	20.8	Humidity (%):	46	Test Date:	01/31/11
------------------------	------	--------------------------	------	---------------	----	------------	----------

5260MHz band CW-7.2Mbps Body Holstered Right A1 1-31-11 Test 19

DUT: 1000CP01U Hand Held Computer; Type: CN70; Serial: 24411047012

Communication System: CW; Communication System Band: D5GHz (5000.0 - 6000.0 MHz); Frequency: 5260 MHz; Communication System PAR: 0 dB

Medium parameters used: $\sigma = 5.46837$ mho/m, $\epsilon_r = 47.0231$; $\rho = 1000$ kg/m³, Medium parameters used (interpolated): $f = 5260$ MHz; $\sigma = 5.479$ mho/m; $\epsilon_r = 47.204$; $\rho = 1000$ kg/m³

Phantom section: Flat Section

Measurement Standard: DASYS (IEEE/IEC/ANSI C63.19-2007)

DASY5 Configuration:

Probe: EX3DV4 - SN3746; ConvF(3.8, 3.8, 3.8); Calibrated: 11/11/2010

Modulation Compensation: Not Used

Sensor-Surface: 2mm (Mechanical Surface Detection)

Electronics: DAE4 Sn1237; Calibrated: 11/10/2010

Phantom: ELI 4.0; Type: QDOVA001BA; Serial:

Measurement SW: DASY52, Version 52.6 (1); SEMCAD X Version 14.4.2 (2595)

Body/Right Holstered/Zoom Scan (8x8x9)/Cube 0: Measurement grid: dx=4mm, dy=4mm, dz=2.5mm

Reference Value = 9.265 V/m; Power Drift = -0.08 dB

Peak SAR (extrapolated) = 1.079 W/kg

SAR(1 g) = 0.340 mW/g; SAR(10 g) = 0.140 mW/g

Info: Interpolated medium parameters used for SAR evaluation.

Maximum value of SAR (measured) = 0.611 mW/g

Body/Right Holstered/Area scan (91x91x1): Measurement grid: dx=10mm, dy=10mm

Info: Interpolated medium parameters used for SAR evaluation.

Maximum value of SAR (interpolated) = 0.601 mW/g

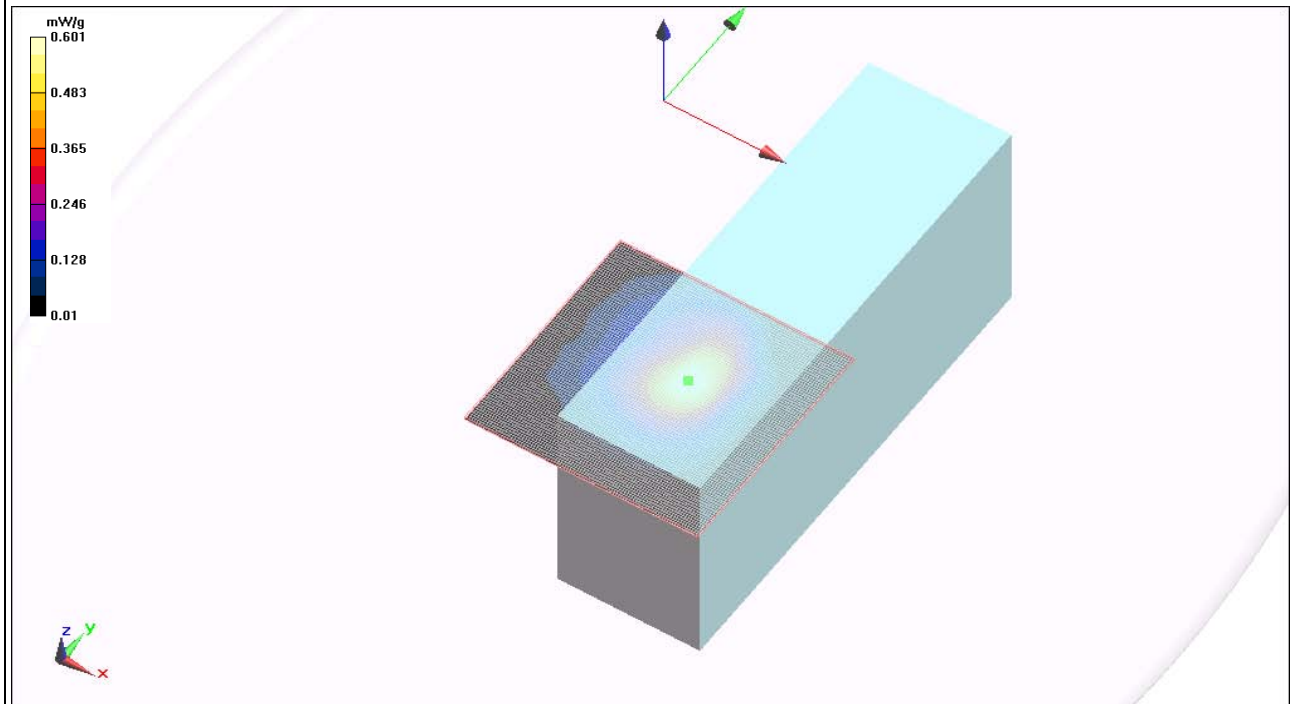

Room Temperature (°C):	22.2	Liquid Temperature (°C):	21.4	Humidity (%):	44	Test Date:	01/30/11
------------------------	------	--------------------------	------	---------------	----	------------	----------

5600MHz band 6Mbps Body Holstered Front 1-30-11 Test 26

DUT: 1000CP01U Hand Held Computer; Type: CN70; Serial: 24511047012

Communication System: CW; Communication System Band: D5GHz (5000.0 - 6000.0 MHz); Frequency: 5600 MHz; Communication System PAR: 0 dB

Medium parameters used: $\sigma = 5.9227$ mho/m, $\epsilon_r = 47.2913$; $\rho = 1000$ kg/m³, Medium parameters used: $f = 5600$ MHz; $\sigma = 5.923$ mho/m; $\epsilon_r = 47.291$; $\rho = 1000$ kg/m³

Phantom section: Flat Section

Measurement Standard: DASYS (IEEE/IEC/ANSI C63.19-2007)

DASYS Configuration:

Probe: EX3DV4 - SN3746; ConvF(3.69, 3.69, 3.69); Calibrated: 11/11/2010

Modulation Compensation: Not Used

Sensor-Surface: 2mm (Mechanical Surface Detection)

Electronics: DAE4 Sn1237; Calibrated: 11/10/2010

Phantom: ELI 4.0; Type: QDOVA001BA; Serial:

Measurement SW: DASYS2, Version 52.6 (1); SEMCAD X Version 14.4.2 (2595)

Body/Front Holstered/Zoom Scan (8x9x9)/Cube 0: Measurement grid: dx=4mm, dy=4mm, dz=2.5mm

Reference Value = 0.839 V/m; Power Drift = 1.35 dB

Peak SAR (extrapolated) = 0.270 W/kg

SAR(1 g) = 0.065 mW/g; SAR(10 g) = 0.025 mW/g

Maximum value of SAR (measured) = 0.144 mW/g

Body/Front Holstered/Area scan (101x101x1): Measurement grid: dx=10mm, dy=10mm

Maximum value of SAR (interpolated) = 0.181 mW/g

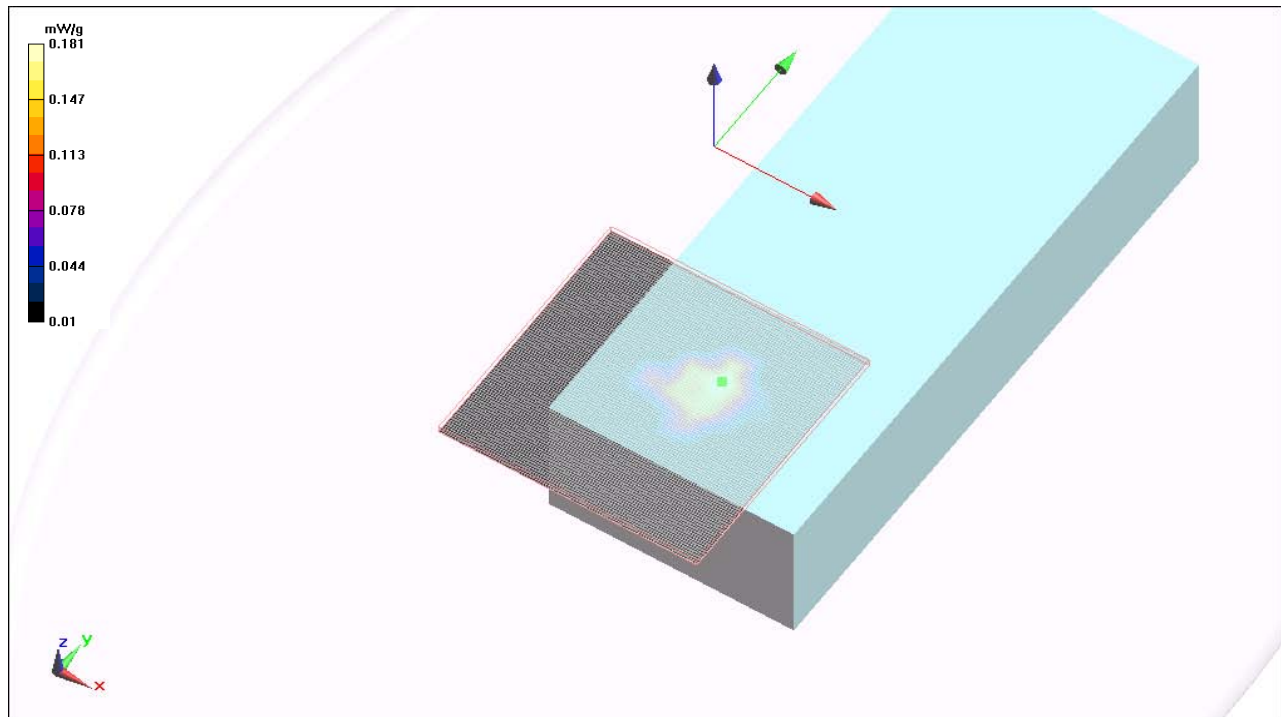

Room Temperature (°C):	22.2	Liquid Temperature (°C):	21.4	Humidity (%):	44	Test Date:	01/30/11
------------------------	------	--------------------------	------	---------------	----	------------	----------

5600MHz band 6Mbps Body Holstered Right 1-30-11 Test 25

DUT: 1000CP01U Hand Held Computer; Type: CN70; Serial: 24511047012

Communication System: CW; Communication System Band: D5GHz (5000.0 - 6000.0 MHz); Frequency: 5600 MHz; Communication System PAR: 0 dB

Medium parameters used: $\sigma = 5.9227$ mho/m, $\epsilon_r = 47.2913$; $\rho = 1000$ kg/m³, Medium parameters used: $f = 5600$ MHz; $\sigma = 5.923$ mho/m; $\epsilon_r = 47.291$; $\rho = 1000$ kg/m³

Phantom section: Flat Section

Measurement Standard: DASYS (IEEE/IEC/ANSI C63.19-2007)

DASY5 Configuration:

Probe: EX3DV4 - SN3746; ConvF(3.69, 3.69, 3.69); Calibrated: 11/11/2010

Modulation Compensation: Not Used

Sensor-Surface: 2mm (Mechanical Surface Detection)

Electronics: DAE4 Sn1237; Calibrated: 11/10/2010

Phantom: ELI 4.0; Type: QDOVA001BA; Serial:

Measurement SW: DASYS2, Version 52.6 (1); SEMCAD X Version 14.4.2 (2595)

Body/Right Holstered/Zoom Scan (8x8x9)/Cube 0: Measurement grid: dx=4mm, dy=4mm, dz=2.5mm

Reference Value = 5.806 V/m; Power Drift = 0.03 dB

Peak SAR (extrapolated) = 1.293 W/kg

SAR(1 g) = 0.379 mW/g; SAR(10 g) = 0.141 mW/g

Info: Interpolated medium parameters used for SAR evaluation.

Maximum value of SAR (measured) = 0.718 mW/g

Body/Right Holstered/Area scan (81x81x1): Measurement grid: dx=10mm, dy=10mm

Info: Interpolated medium parameters used for SAR evaluation.

Maximum value of SAR (interpolated) = 0.751 mW/g

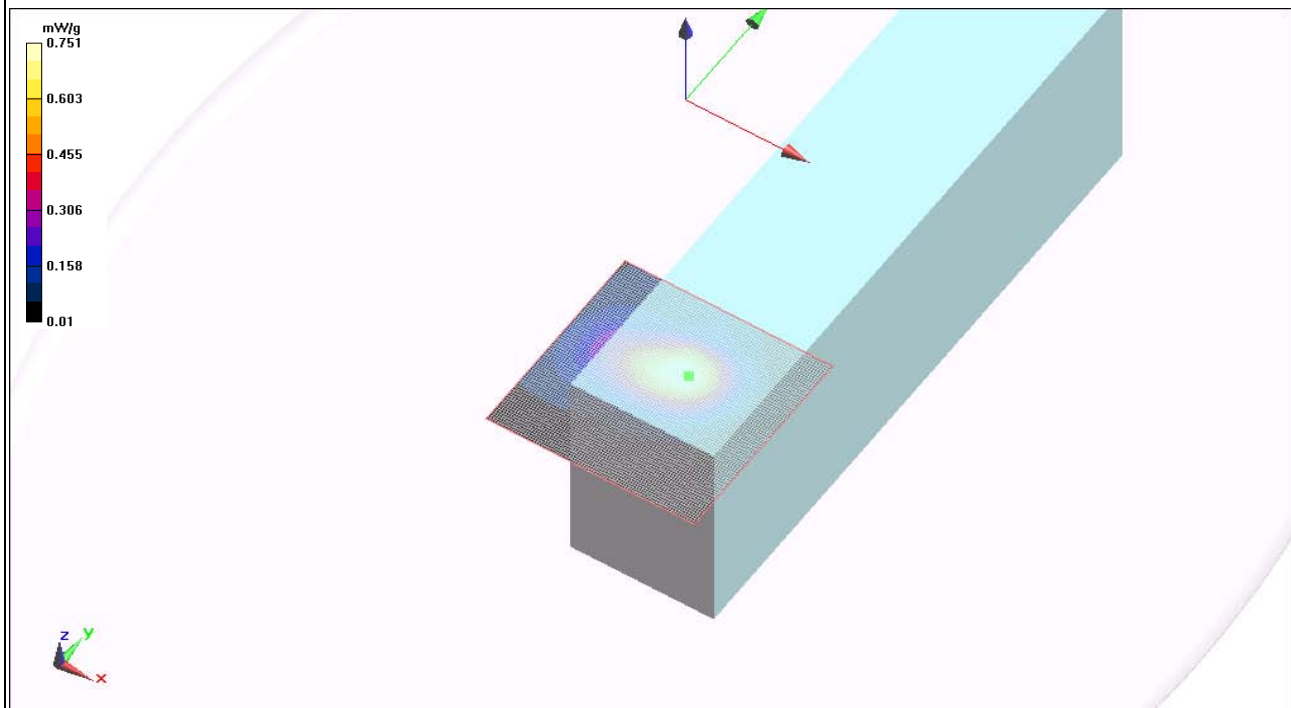

Room Temperature (°C):	22.4	Liquid Temperature (°C):	21.5	Humidity (%):	44	Test Date:	01/29/11
------------------------	------	--------------------------	------	---------------	----	------------	----------

5745MHz band 6Mbps Body Holstered Front 1-29-11 Test 32

DUT: 1000CP01U Hand Held Computer; Type: CN70; Serial: 245110471012

Communication System: CW; Communication System Band: D5GHz (5000.0 - 6000.0 MHz); Frequency: 5745 MHz; Communication System PAR: 0 dB

Medium parameters used: $\sigma = 6.12928$ mho/m, $\epsilon_r = 46.9891$; $\rho = 1000$ kg/m³, Medium parameters used (interpolated): $f = 5745$ MHz; $\sigma = 6.123$ mho/m; $\epsilon_r = 47$; $\rho = 1000$ kg/m³

Phantom section: Flat Section

Measurement Standard: DASYS (IEEE/IEC/ANSI C63.19-2007)

DASYS Configuration:

Probe: EX3DV4 - SN3746; ConvF(3.87, 3.87, 3.87); Calibrated: 11/11/2010

Modulation Compensation: Not Used

Sensor-Surface: 2mm (Mechanical Surface Detection)

Electronics: DAE4 Sn1237; Calibrated: 11/10/2010

Phantom: ELI 4.0; Type: QDOVA001BA; Serial:

Measurement SW: DASYS2, Version 52.6 (1); SEMCAD X Version 14.4.2 (2595)

Body/Front Holstered/Zoom Scan (7x7x9)/Cube 0: Measurement grid: dx=4mm, dy=4mm, dz=2.5mm

Reference Value = 0.602 V/m; Power Drift = 3.66 dB

Peak SAR (extrapolated) = 0.477 W/kg

SAR(1 g) = 0.062 mW/g; SAR(10 g) = 0.021 mW/g

Info: Interpolated medium parameters used for SAR evaluation.

Maximum value of SAR (measured) = 0.139 mW/g

Body/Front Holstered/Area scan (101x91x1): Measurement grid: dx=10mm, dy=10mm

Info: Interpolated medium parameters used for SAR evaluation.

Maximum value of SAR (interpolated) = 0.187 mW/g

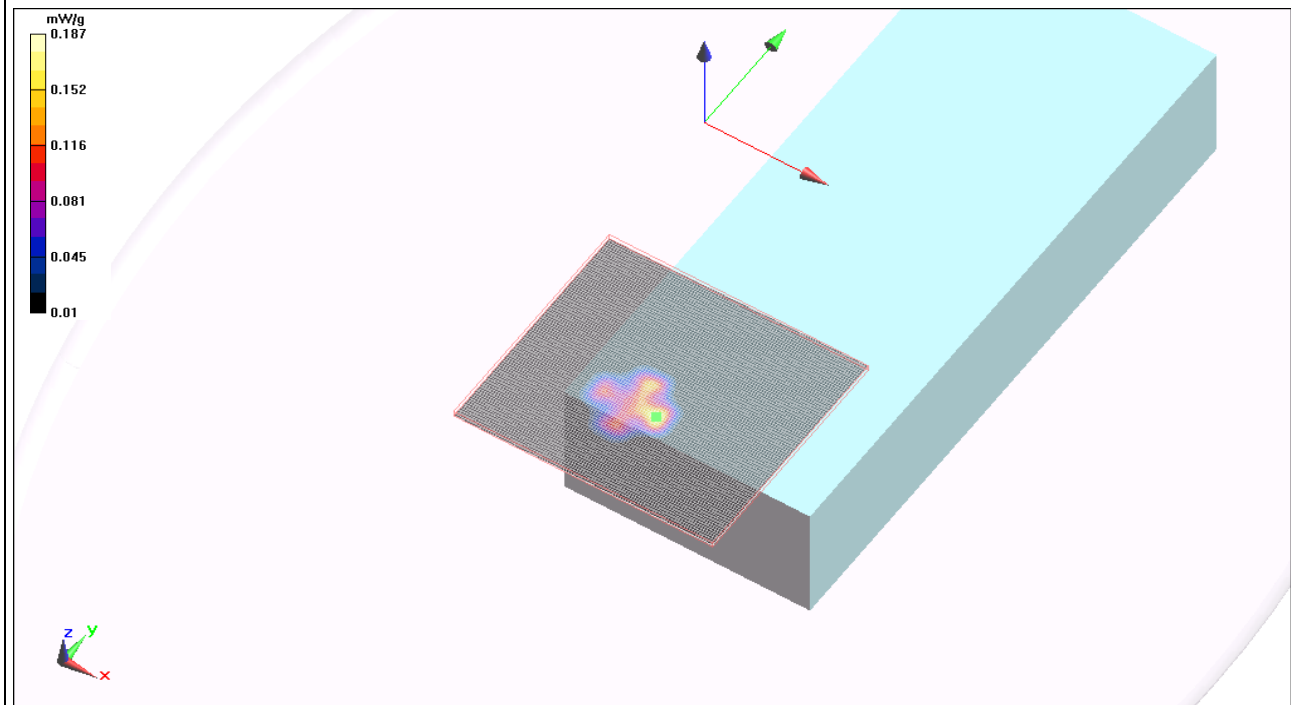

Room Temperature (°C):	22.4	Liquid Temperature (°C):	21.5	Humidity (%):	44	Test Date:	01/29/11
------------------------	------	--------------------------	------	---------------	----	------------	----------

5745MHz band 6Mbps Body Holstered Right 1-30-11 Test 31

DUT: 1000CP01U Hand Held Computer; Type: CN70; Serial: 24511047012

Communication System: CW; Communication System Band: D5GHz (5000.0 - 6000.0 MHz); Frequency: 5745 MHz; Communication System PAR: 0 dB

Medium parameters used: $\sigma = 6.1721$ mho/m, $\epsilon_r = 47.1406$; $\rho = 1000$ kg/m³, Medium parameters used (interpolated): $f = 5745$ MHz; $\sigma = 6.162$ mho/m; $\epsilon_r = 47.136$; $\rho = 1000$ kg/m³

Phantom section: Flat Section

Measurement Standard: DASYS (IEEE/IEC/ANSI C63.19-2007)

DASY5 Configuration:

Probe: EX3DV4 - SN3746; ConvF(3.87, 3.87, 3.87); Calibrated: 11/11/2010

Modulation Compensation: Not Used

Sensor-Surface: 2mm (Mechanical Surface Detection)

Electronics: DAE4 Sn1237; Calibrated: 11/10/2010

Phantom: ELI 4.0; Type: QDOVA001BA; Serial:

Measurement SW: DASY52, Version 52.6 (1); SEMCAD X Version 14.4.2 (2595)

Body/Right Holstered/Zoom Scan (8x8x9)/Cube 0: Measurement grid: dx=4mm, dy=4mm, dz=2.5mm

Reference Value = 4.409 V/m; Power Drift = 0.26 dB

Peak SAR (extrapolated) = 1.213 W/kg

SAR(1 g) = 0.362 mW/g; SAR(10 g) = 0.151 mW/g

Info: Interpolated medium parameters used for SAR evaluation.

Maximum value of SAR (measured) = 0.663 mW/g

Body/Right Holstered/Area scan (81x81x1): Measurement grid: dx=10mm, dy=10mm

Info: Interpolated medium parameters used for SAR evaluation.

Maximum value of SAR (interpolated) = 0.691 mW/g

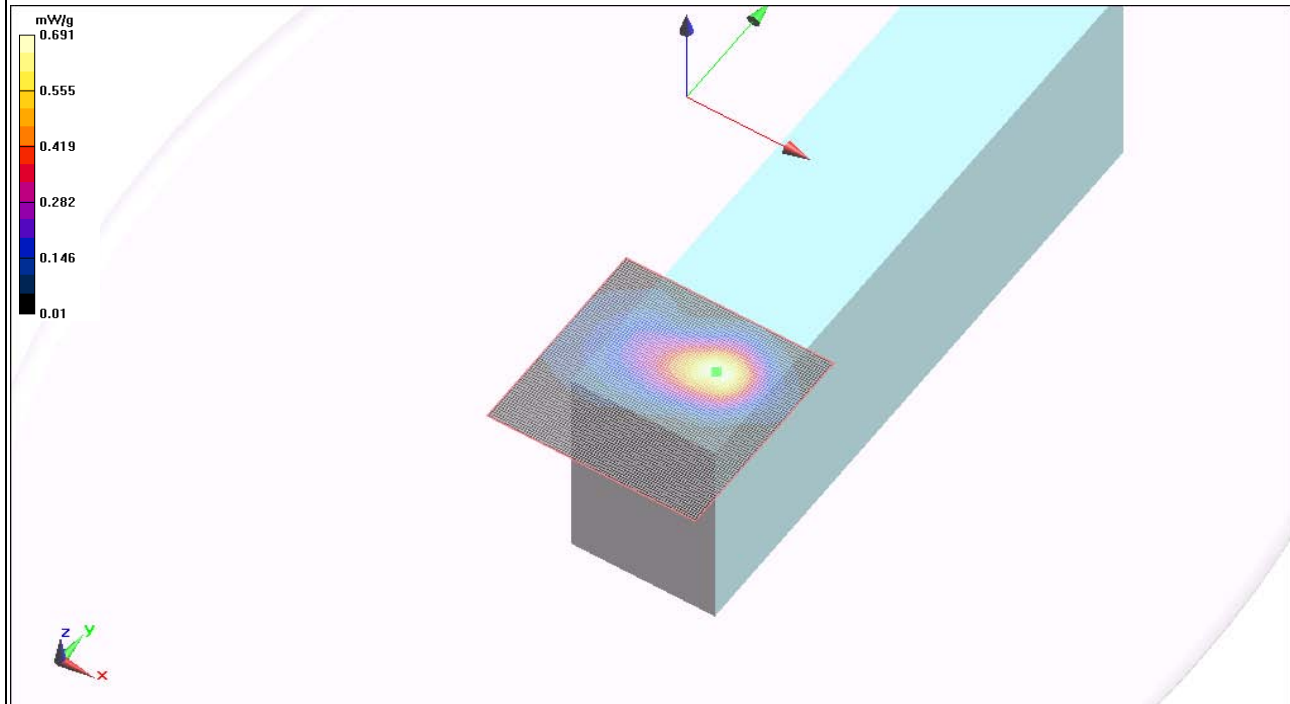

EMC

Room Temperature (°C):	22.2	Liquid Temperature (°C):	21.4	Humidity (%):	44	Test Date:	01/30/11
------------------------	------	--------------------------	------	---------------	----	------------	----------

5600MHz band 6Mbps Body Holstered Right 1-30-11 Test 25

DUT: 1000CP01U Hand Held Computer; Type: CN70; Serial: 24511047012

Communication System: CW; Communication System Band: D5GHz (5000.0 - 6000.0 MHz); Frequency: 5600 MHz; Communication System PAR: 0 dB
 Medium parameters used: $\sigma = 6.1721$ mho/m, $\epsilon_r = 47.1406$; $\rho = 1000$ kg/m³
 Phantom section: Flat Section
 Measurement Standard: DASYS5 (IEEE/IEC/ANSI C63.19-2007)

DASY5 Configuration:

Probe: EX3DV4 - SN3746; ConvF(3.87, 3.87, 3.87); Calibrated: 11/11/2010
 Modulation Compensation: Not Used
 Sensor-Surface: 0mm (Fix Surface)
 Electronics: DAE4 Sn1237; Calibrated: 11/10/2010
 Phantom: ELI 4.0; Type: QDOVA001BA; Serial:
 Measurement SW: DASYS2, Version 52.6 (1); SEMCAD X Version 14.4.2 (2595)

Body/Right Holstered/Z Scan (1x1x21): Measurement grid: dx=20mm, dy=20mm, dz=5mm

Maximum value of Total (measured) = 9.874 V/m

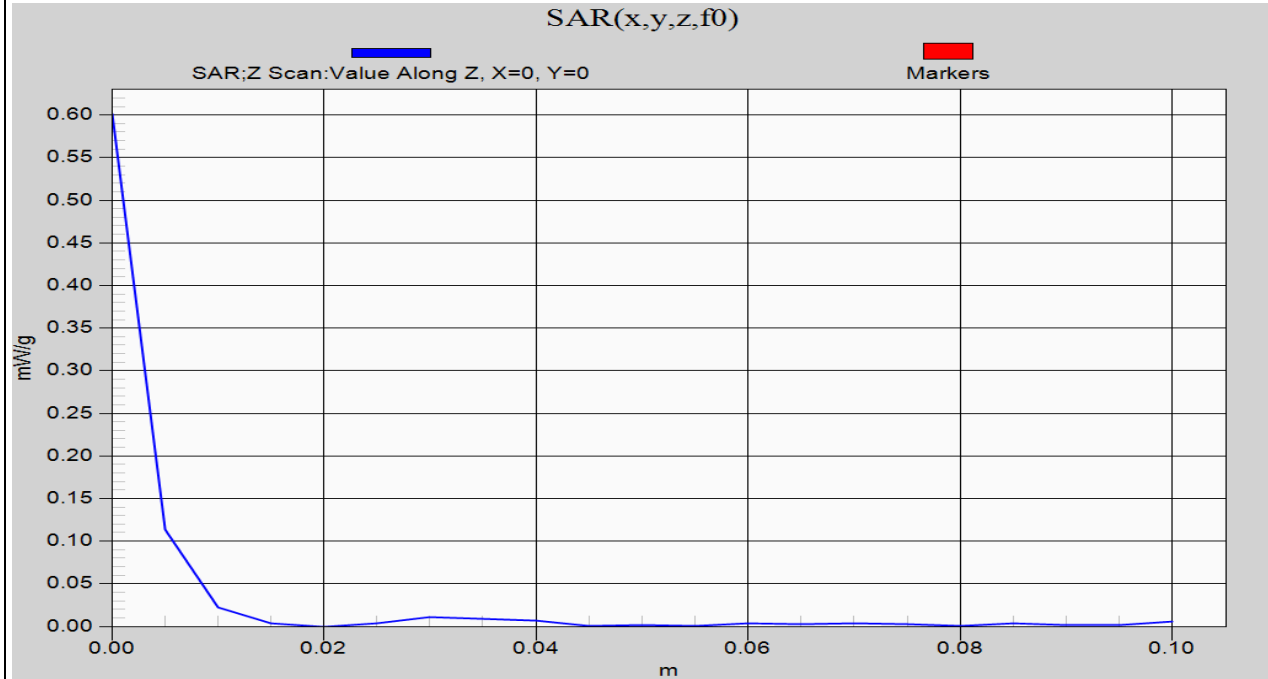

SAR Measurement System

Schmid & Partner Engineering AG, DASY52

Northwest EMC selected the leader in SAR evaluation systems to provide the measurement tools for this evaluation. SPEAG's DASY52 is the fastest and most accurate scanner on the market. It is fully compatible with all world-wide standards for transmitters operating at the ear or within 20cm of the body. It provides full compatibility with IEC 62209-1, IEC 62209-2, IEEE 1528 as well as national adaptations such as FCC OET-65c and Korean Std. MIC #2000-93

The DASY52 system for performing compliance tests consists of the following items:

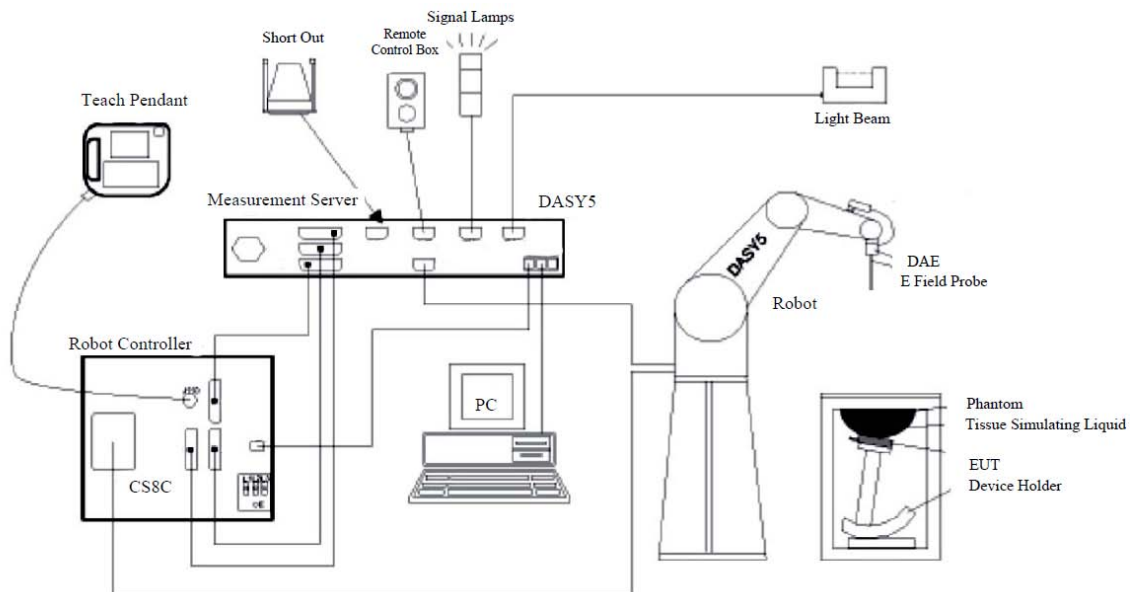

- A standard high precision 6-axis robot (Staubli TX=RX family) with controller, teach pendant and software. An arm extension for accommodating the data acquisition electronics (DAE).
- An isotropic field probe optimized and calibrated for the targeted measurement.
- A data acquisition electronics (DAE) which performs the signal amplification, signal multiplexing, AD-conversion, offset measurements, mechanical surface detection, collision detection, etc. The unit is battery powered with standard or rechargeable batteries. The signal is optically transmitted to the EOC.
- The Electro-optical converter (EOC) performs the conversion from optical to electrical signals for the digital communication to the DAE. To use optical surface detection, a special version of the EOC is required. The EOC signal is transmitted to the measurement server.
- The function of the measurement server is to perform the time critical tasks such as signal filtering, control of the robot operation and fast movement interrupts.
- The Light Beam used is for probe alignment. This improves the (absolute) accuracy of the probe positioning.
- A computer running WinXP and the DASY5 software.
- Remote control and teach pendant as well as additional circuitry for robot safety such as warning lamps, etc.
- The SAM twin phantom, oval flat phantom, device holder, tissue simulating liquids, and validation dipole kits.

Test Site

Northwest EMC, Lab EV08

The SAR measurement system is located in a semi-anechoic chamber. This provides an ambient free environment that also eliminates reflections.

The chamber is 12 ft wide by 16 ft long x 8 ft high. A dedicated HVAC unit provides +/- 1 degree C temperature control.



Test Equipment List

Description	Manufacturer	Model	ID	Last Cal.	Interval
SAR Measurement System	SPEAG	DASY52 SAR TX60L	SAA	see below	
Robot and power Supply	Staeubli	N/A	SAJ	NCR	0
DASY5 Measurement Server	Staeubli	DAYS5	SAK	NCR	0
Robot Controller	Staeubli	CS8C	SAI	11/11/2010	12
DASY5 Computer System	Hewlett Packard	N/A	SAX	NCR	0
DAE	SPEAG	SD 000 D04 EJ	SAH	11/11/2010	12
Light Beam Unit	SPEAG	SE UKS 030 AA	SAD	NCR	0
Phantom, 2mm Oval ELI4 (Body)	SPEAG	QD OVA 001 BB	SAC	NCR	0
Phantom, Twin SAM (Head)	SPEAG	QD 000 P40 CC	SAB	NCR	0
Device Holder	SPEAG	N/A	SAW	NCR	0
SAR Probe	SPEAG	EX3DV4	SAG	11/11/2010	12
Validation Dipole 5.1-5.8GHz	SPEAG	D5GHzV2	ADM	11/16/2010	12
Validation Dipole 2450MHz	SPEAG	D2450V2	ADL	11/11/2010	12
Body Solution	SPEAG	MSL 501	SAV	Before the first test, then every 24 hours	
Head Solution	SPEAG	HSL 501	SAU		
Body Solution	SPEAG	MSL 2450	SAM		
Head Solution	SPEAG	HSL 2450	SAL		
Power Sensor	Gigatronics	80701A	SPL	1/7/2010	13
Power Meter	Gigatronics	8651A	SPM	1/7/2010	13
Network Analyzer	Agilent	N5230A	NAD	9/8/2010	13
Dielectric Probe Kit	Agilent	85070E	IPP	9/8/2010	13
RF Amplifier	Varian	VZC6961K11195	TAF	NCR	0
RF Amplifier	Amplifier Research	25S1G4A	TRO	NCR	0
Signal Generator	Agilent	E8257D	TGX	12/10/2008	27
Humidity Temperature Meter	Omegaette	HH311	DTX	10/4/2010	12
Spectrum Analyzer - reference only	Hewlett-Packard	8593E	AAN	NCR	0

Measurement Uncertainty Budgets per IEEE 1528:2003

300 – 3000 MHz range

Uncertainty Component	Tolerance (+/- %)	Probability Distribution	Divisor	c_i (1g)	c_i (10g)	u_i (1g) (+/-%)	u_i (10g) (+/-%)	v_i
Measurement System								
Probe calibration (k=1)	5.5	normal	1	1	1	5.5	5.5	∞
Axial isotropy	4.7	rectangular	1.732	0.707	0.707	1.9	1.9	∞
Hemispherical isotropy	9.6	rectangular	1.732	0.707	0.707	3.9	3.9	∞
Boundary effect	1.0	rectangular	1.732	1	1	0.6	0.6	∞
Linearity	4.7	rectangular	1.732	1	1	2.7	2.7	∞
System detection limits	1.0	rectangular	1.732	1	1	0.6	0.6	∞
Readout electronics	0.3	normal	1	1	1	0.3	0.3	∞
Response time	0.8	rectangular	1.732	1	1	0.5	0.5	∞
Integration time	2.6	rectangular	1.732	1	1	1.5	1.5	∞
RF ambient conditions - noise	1.7	rectangular	1.732	1	1	1.0	1.0	∞
RF Ambient Reflections	0.0	rectangular	1.732	1	1	0.0	0.0	∞
Probe positioner mechanical tolerance	0.4	rectangular	1.732	1	1	0.2	0.2	∞
Probe positioner with respect to phantom shell	2.9	rectangular	1.732	1	1	1.7	1.7	∞
Extrapolation, interpolation, and integration algorithms for max. SAR evaluation	1.0	rectangular	1.732	1	1	0.6	0.6	∞
Test Sample Related								
Device Positioning	2.9	normal	1	1	1	2.9	2.9	145
Device Holder	3.6	normal	1	1	1	3.6	3.6	5
Power Drift	5.0	rectangular	1.732	1	1	2.9	2.9	∞
Phantom and tissue parameters								
Phantom Uncertainty - shell thickness tolerances	4.0	rectangular	1.732	1	1	2.3	2.3	∞
Liquid conductivity - deviation from target values	5.0	rectangular	1.732	0.64	0.43	1.8	1.2	∞
Liquid conductivity - measurement uncertainty	6.5	normal	1	0.64	0.43	4.2	2.8	∞
Liquid permittivity - deviation from target values	5.0	rectangular	1.732	0.6	0.49	1.7	1.4	∞
Liquid permittivity - measurement uncertainty	3.2	normal	1	0.6	0.49	1.9	1.6	∞
Combined Standard Uncertainty	RSS					11.2	10.6	387
Expanded Measurement Uncertainty (95% Confidence/	normal (k=2)					22.5	21.2	

3 – 6 GHz range

Uncertainty Component	Tolerance (+/- %)	Probability Distribution	Divisor	c_i (1g)	c_i (10g)	u_i (1g) (+/-%)	u_i (10g) (+/-%)	v_i
Measurement System								
Probe calibration (k=1)	6.55	normal	1	1	1	6.6	6.6	∞
Axial isotropy	4.7	rectangular	1.732	0.707	0.707	1.9	1.9	∞
Hemispherical isotropy	9.6	rectangular	1.732	0.707	0.707	3.9	3.9	∞
Boundary effect	2.0	rectangular	1.732	1	1	1.2	1.2	∞
Linearity	4.7	rectangular	1.732	1	1	2.7	2.7	∞
System detection limits	1.0	rectangular	1.732	1	1	0.6	0.6	∞
Readout electronics	0.3	normal	1	1	1	0.3	0.3	∞
Response time	0.8	rectangular	1.732	1	1	0.5	0.5	∞
Integration time	2.6	rectangular	1.732	1	1	1.5	1.5	∞
RF ambient conditions - noise	1.7	rectangular	1.732	1	1	1.0	1.0	∞
RF Ambient Reflections	0.0	rectangular	1.732	1	1	0.0	0.0	∞
Probe positioner mechanical tolerance	0.8	rectangular	1.732	1	1	0.5	0.5	∞
Probe positioner with respect to phantom shell	9.9	rectangular	1.732	1	1	5.7	5.7	∞
Extrapolation, interpolation, and integration algorithms for max. SAR evaluation	4.0	rectangular	1.732	1	1	2.3	2.3	∞
Test Sample Related								
Device Positioning	2.9	normal	1	1	1	2.9	2.9	145
Device Holder	3.6	normal	1	1	1	3.6	3.6	5
Power Drift	5.0	rectangular	1.732	1	1	2.9	2.9	∞
Phantom and tissue parameters								
Phantom Uncertainty - shell thickness tolerances	4.0	rectangular	1.732	1	1	2.3	2.3	∞
Liquid conductivity - deviation from target values	5.0	rectangular	1.732	0.64	0.43	1.8	1.2	∞
Liquid conductivity - measurement uncertainty	6.5	normal	1	0.64	0.43	4.2	2.8	∞
Liquid permittivity - deviation from target values	5.0	rectangular	1.732	0.6	0.49	1.7	1.4	∞
Liquid permittivity - measurement uncertainty	3.2	normal	1	0.6	0.49	1.9	1.6	∞
Combined Standard Uncertainty	RSS					13.2	12.7	330
Expanded Measurement Uncertainty (95% Confidence/	normal (k=2)					26.5	25.4	

Probe Calibration

Please see attached calibration data

**Calibration Laboratory of
Schmid & Partner
Engineering AG**
Zeughausstrasse 43, 8004 Zurich, Switzerland



S Schweizerischer Kalibrierdienst
C Service suisse d'étalonnage
S Servizio svizzero di taratura
S Swiss Calibration Service

Accredited by the Swiss Accreditation Service (SAS)
The Swiss Accreditation Service is one of the signatories to the EA
Multilateral Agreement for the recognition of calibration certificates

Accreditation No.: **SCS 108**

Client **Northwest EMC**

Certificate No: **EX3-3746_Nov10**

CALIBRATION CERTIFICATE

Object **EX3DV4 - SN:3746**

Calibration procedure(s) **QA CAL-01.v6, QA CAL-14.v3, QA CAL-23.v3 and QA CAL-25.v2
Calibration procedure for dosimetric E-field probes**

Calibration date: **November 11, 2010**

This calibration certificate documents the traceability to national standards, which realize the physical units of measurements (SI).
The measurements and the uncertainties with confidence probability are given on the following pages and are part of the certificate.

All calibrations have been conducted in the closed laboratory facility: environment temperature (22 ± 3)°C and humidity < 70%.

Calibration Equipment used (M&TE critical for calibration)

Primary Standards	ID #	Cal Date (Certificate No.)	Scheduled Calibration
Power meter E4419B	GB41293874	1-Apr-10 (No. 217-01136)	Apr-11
Power sensor E4412A	MY41495277	1-Apr-10 (No. 217-01136)	Apr-11
Power sensor E4412A	MY41498087	1-Apr-10 (No. 217-01136)	Apr-11
Reference 3 dB Attenuator	SN: S5054 (3c)	30-Mar-10 (No. 217-01159)	Mar-11
Reference 20 dB Attenuator	SN: S5086 (20b)	30-Mar-10 (No. 217-01161)	Mar-11
Reference 30 dB Attenuator	SN: S5129 (30b)	30-Mar-10 (No. 217-01160)	Mar-11
Reference Probe ES3DV2	SN: 3013	30-Dec-09 (No. ES3-3013_Dec09)	Dec-10
DAE4	SN: 660	20-Apr-10 (No. DAE4-660_Apr10)	Apr-11
Secondary Standards	ID #	Check Date (in house)	Scheduled Check
RF generator HP 8648C	US3642U01700	4-Aug-99 (in house check Oct-09)	In house check: Oct-11
Network Analyzer HP 8753E	US37390585	18-Oct-01 (in house check Oct-10)	In house check: Oct-11

	Name	Function	Signature
Calibrated by:	Katja Pokovic	Technical Manager	
Approved by:	Niels Kuster	Quality Manager	

Issued: November 11, 2010

This calibration certificate shall not be reproduced except in full without written approval of the laboratory.



Accredited by the Swiss Accreditation Service (SAS)

The Swiss Accreditation Service is one of the signatories to the EA
Multilateral Agreement for the recognition of calibration certificates

Accreditation No.: **SCS 108**

Glossary:

TSL	tissue simulating liquid
NORM _{x,y,z}	sensitivity in free space
ConvF	sensitivity in TSL / NORM _{x,y,z}
DCP	diode compression point
CF	crest factor (1/duty_cycle) of the RF signal
A, B, C	modulation dependent linearization parameters
Polarization φ	φ rotation around probe axis
Polarization ϑ	ϑ rotation around an axis that is in the plane normal to probe axis (at measurement center), i.e., $\vartheta = 0$ is normal to probe axis

Calibration is Performed According to the Following Standards:

- IEEE Std 1528-2003, "IEEE Recommended Practice for Determining the Peak Spatial-Averaged Specific Absorption Rate (SAR) in the Human Head from Wireless Communications Devices: Measurement Techniques", December 2003
- IEC 62209-1, "Procedure to measure the Specific Absorption Rate (SAR) for hand-held devices used in close proximity to the ear (frequency range of 300 MHz to 3 GHz)", February 2005

Methods Applied and Interpretation of Parameters:

- NORM_{x,y,z}**: Assessed for E-field polarization $\vartheta = 0$ ($f \leq 900$ MHz in TEM-cell; $f > 1800$ MHz: R22 waveguide). NORM_{x,y,z} are only intermediate values, i.e., the uncertainties of NORM_{x,y,z} does not effect the E^2 -field uncertainty inside TSL (see below *ConvF*).
- NORM(f)_{x,y,z}** = NORM_{x,y,z} * *frequency_response* (see Frequency Response Chart). This linearization is implemented in DASY4 software versions later than 4.2. The uncertainty of the frequency response is included in the stated uncertainty of *ConvF*.
- DCP_{x,y,z}**: DCP are numerical linearization parameters assessed based on the data of power sweep with CW signal (no uncertainty required). DCP does not depend on frequency nor media.
- A_{x,y,z}; B_{x,y,z}; C_{x,y,z}; VR_{x,y,z}**: A, B, C are numerical linearization parameters assessed based on the data of power sweep for specific modulation signal. The parameters do not depend on frequency nor media. VR is the maximum calibration range expressed in RMS voltage across the diode.
- ConvF and Boundary Effect Parameters**: Assessed in flat phantom using E-field (or Temperature Transfer Standard for $f \leq 800$ MHz) and inside waveguide using analytical field distributions based on power measurements for $f > 800$ MHz. The same setups are used for assessment of the parameters applied for boundary compensation (alpha, depth) of which typical uncertainty values are given. These parameters are used in DASY4 software to improve probe accuracy close to the boundary. The sensitivity in TSL corresponds to NORM_{x,y,z} * *ConvF* whereby the uncertainty corresponds to that given for *ConvF*. A frequency dependent *ConvF* is used in DASY version 4.4 and higher which allows extending the validity from ± 50 MHz to ± 100 MHz.
- Spherical isotropy (3D deviation from isotropy)**: in a field of low gradients realized using a flat phantom exposed by a patch antenna.
- Sensor Offset**: The sensor offset corresponds to the offset of virtual measurement center from the probe tip (on probe axis). No tolerance required.

Probe EX3DV4

SN:3746

Manufactured:	March 26, 2010
Calibrated:	November 11, 2010

Calibrated for DASY/EASY Systems

(Note: non-compatible with DASY2 system!)

DASY/EASY - Parameters of Probe: EX3DV4 SN:3746

Basic Calibration Parameters

	Sensor X	Sensor Y	Sensor Z	Unc (k=2)
Norm ($\mu\text{V}/(\text{V}/\text{m})^2$) ^A	0.47	0.49	0.50	± 10.1%
DCP (mV) ^B	94.5	94.5	95.5	

Modulation Calibration Parameters

UID	Communication System Name	PAR		A dB	B dBuV	C	VR mV	Unc ^E (k=2)
10000	CW	0.00	X	0.00	0.00	1.00	110.5	± 2.9 %
			Y	0.00	0.00	1.00	114.3	
			Z	0.00	0.00	1.00	111.2	
10061	IEEE 802.11b WiFi 2.4 GHz (DSSS, 11 Mbps)	3.60	X	3.86	70.08	19.28	77.9	± 2.1 %
			Y	2.62	65.07	16.74	78.0	
			Z	3.03	66.48	17.70	77.6	
10069	IEEE 802.11a/h WiFi 5 GHz (OFDM, 54 Mbps)	12.20	X	11.72	66.82	21.98	80.1	± 6.1 %
			Y	10.64	65.22	21.04	73.9	
			Z	11.40	66.10	21.47	79.3	
10077	IEEE 802.11g WiFi 2.4 GHz (DSSS/OFDM, 54 Mbps)	13.12	X	11.10	65.64	21.82	69.7	± 6.9 %
			Y	11.26	67.57	23.06	93.9	
			Z	10.95	65.59	21.88	69.1	

The reported uncertainty of measurement is stated as the standard uncertainty of measurement multiplied by the coverage factor k=2, which for a normal distribution corresponds to a coverage probability of approximately 95%.

^A The uncertainties of NormX,Y,Z do not affect the E²-field uncertainty inside TSL (see Pages 5 and 6).

^B Numerical linearization parameter: uncertainty not required.

^E Uncertainty is determined using the maximum deviation from linear response applying recatangular distribution and is expressed for the square of the field value.

DASY/EASY - Parameters of Probe: EX3DV4 SN:3746

Calibration Parameter Determined in Head Tissue Simulating Media

f [MHz]	Validity [MHz] ^c	Permittivity	Conductivity	ConvF X	ConvF Y	ConvF Z	Alpha	Depth Unc (k=2)
2450	± 50 / ± 100	39.2 ± 5%	1.80 ± 5%	6.69	6.69	6.69	0.43	0.76 ± 11.0%
5200	± 50 / ± 100	36.0 ± 5%	4.66 ± 5%	5.08	5.08	5.08	0.99	0.67 ± 13.1%
5300	± 50 / ± 100	35.9 ± 5%	4.76 ± 5%	4.59	4.59	4.59	0.49	1.39 ± 13.1%
5500	± 50 / ± 100	35.6 ± 5%	4.96 ± 5%	4.37	4.37	4.37	0.47	1.59 ± 13.1%
5800	± 50 / ± 100	35.3 ± 5%	5.27 ± 5%	4.14	4.14	4.14	0.47	1.76 ± 13.1%

^c The validity of ± 100 MHz only applies for DASY v4.4 and higher (see Page 2). The uncertainty is the RSS of the ConvF uncertainty at calibration frequency and the uncertainty for the indicated frequency band.

DASY/EASY - Parameters of Probe: EX3DV4 SN:3746

Calibration Parameter Determined in Body Tissue Simulating Media

f [MHz]	Validity [MHz] ^c	Permittivity	Conductivity	ConvF X	ConvF Y	ConvF Z	Alpha	Depth Unc (k=2)
2450	± 50 / ± 100	52.7 ± 5%	1.95 ± 5%	6.81	6.81	6.81	0.48	0.73 ± 11.0%
5200	± 50 / ± 100	49.0 ± 5%	5.30 ± 5%	4.16	4.16	4.16	0.51	1.76 ± 13.1%
5300	± 50 / ± 100	48.9 ± 5%	5.42 ± 5%	3.80	3.80	3.80	0.54	1.88 ± 13.1%
5500	± 50 / ± 100	48.6 ± 5%	5.65 ± 5%	3.69	3.69	3.69	0.54	2.02 ± 13.1%
5800	± 50 / ± 100	48.2 ± 5%	6.00 ± 5%	3.87	3.87	3.87	0.53	1.94 ± 13.1%

^c The validity of ± 100 MHz only applies for DASY v4.4 and higher (see Page 2). The uncertainty is the RSS of the ConvF uncertainty at calibration frequency and the uncertainty for the indicated frequency band.

Frequency Response of E-Field

(TEM-Cell:ifi110 EXX, Waveguide: R22)

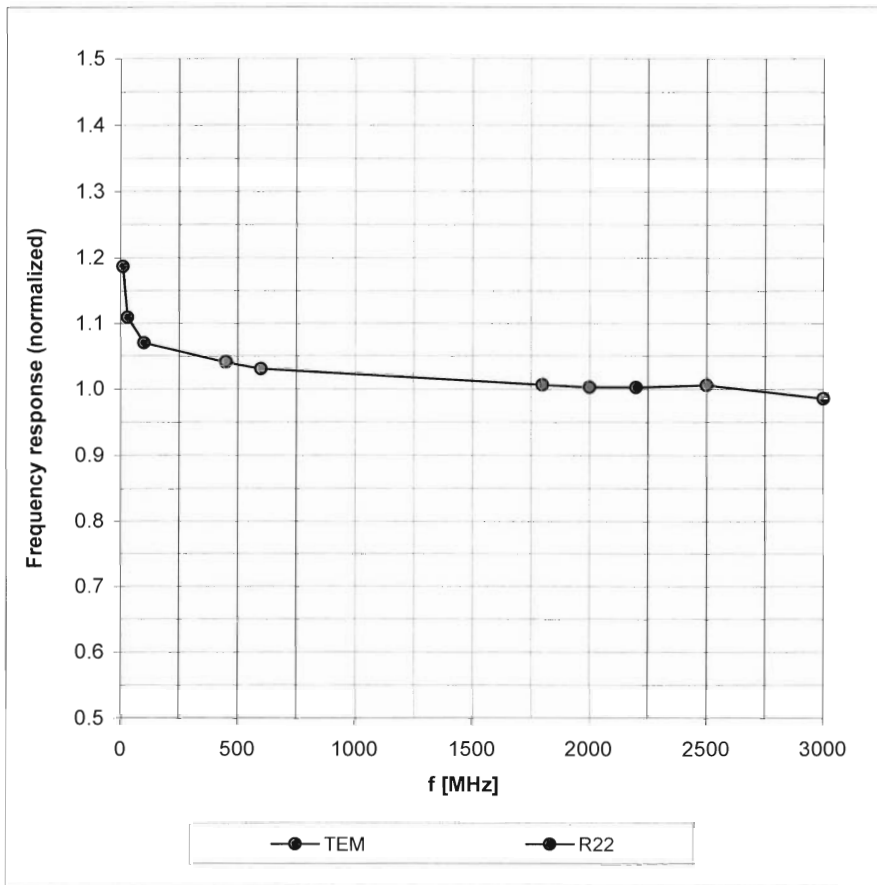

Uncertainty of Frequency Response of E-field: $\pm 6.3\%$ (k=2)

Receiving Pattern (ϕ), $\vartheta = 0^\circ$

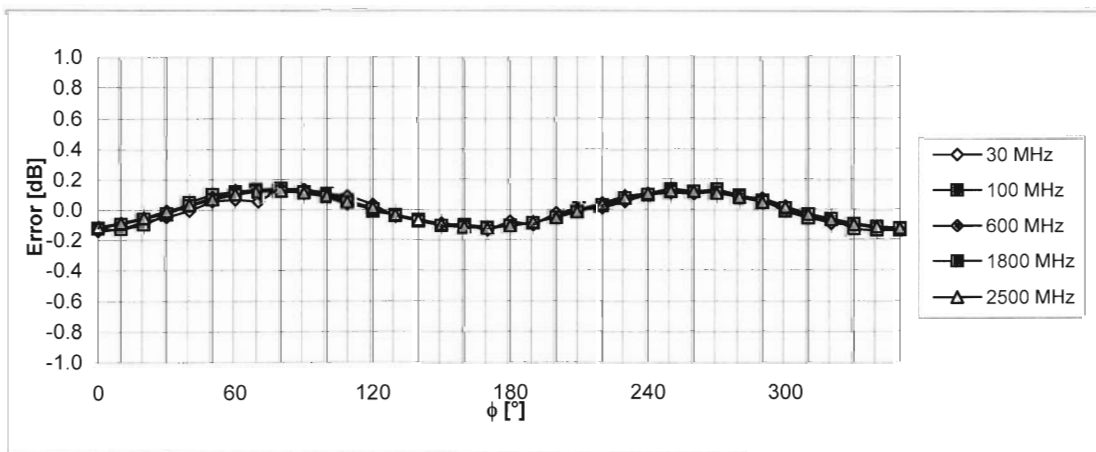
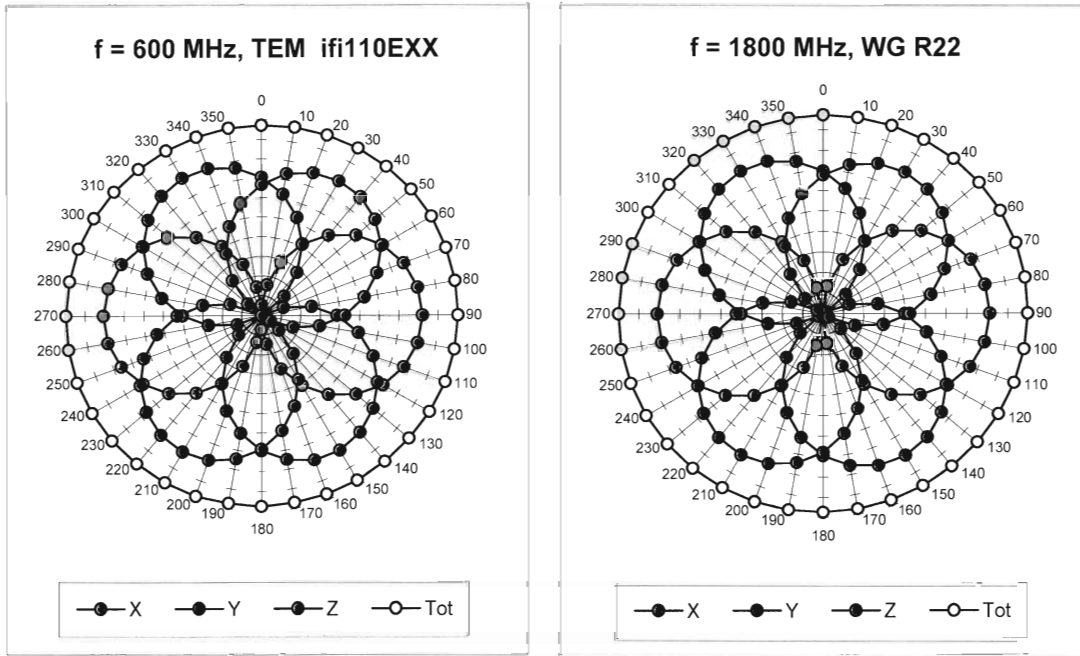

Uncertainty of Axial Isotropy Assessment: $\pm 0.5\%$ ($k=2$)

Dynamic Range f(SAR_{head}) (Waveguide R22, f = 1800 MHz)

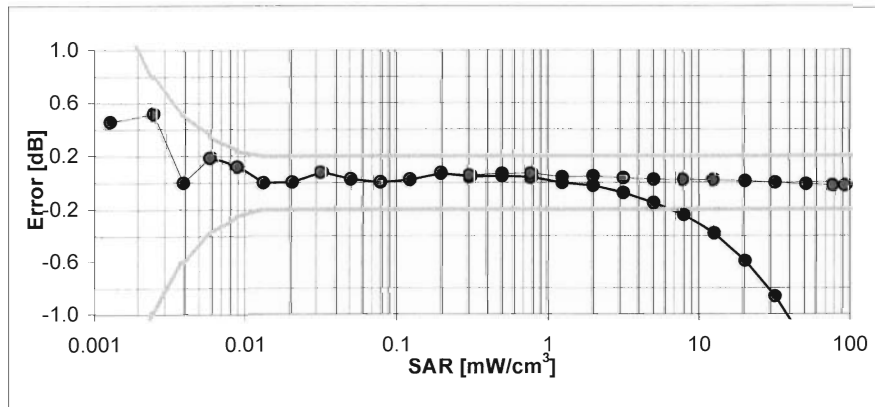
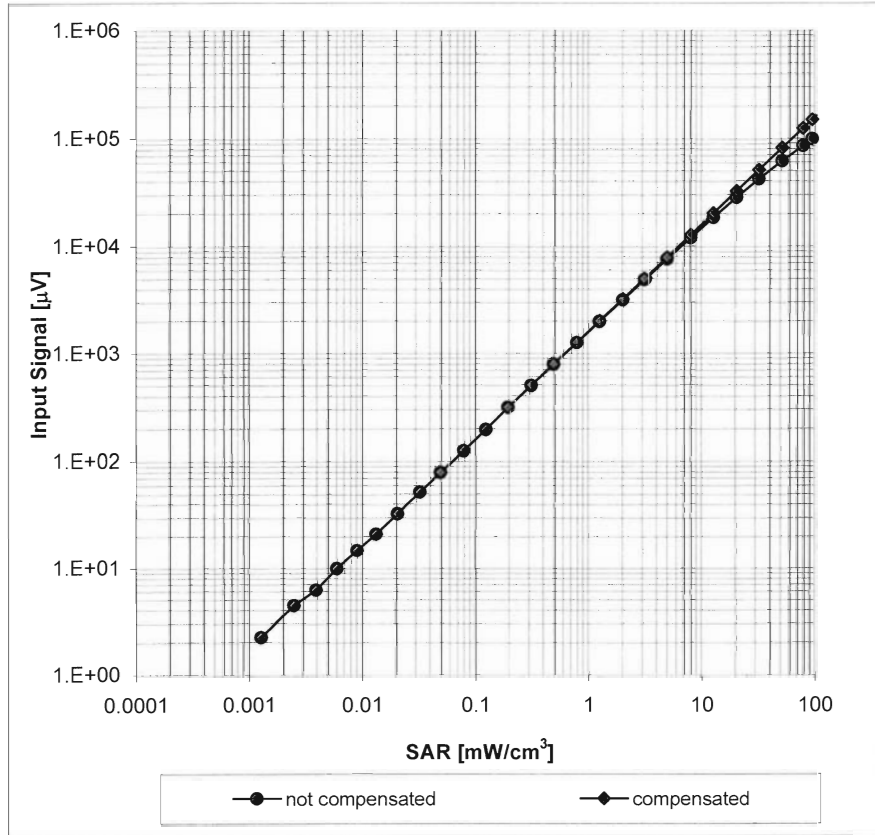

Uncertainty of Linearity Assessment: $\pm 0.6\%$ (k=2)

Conversion Factor Assessment

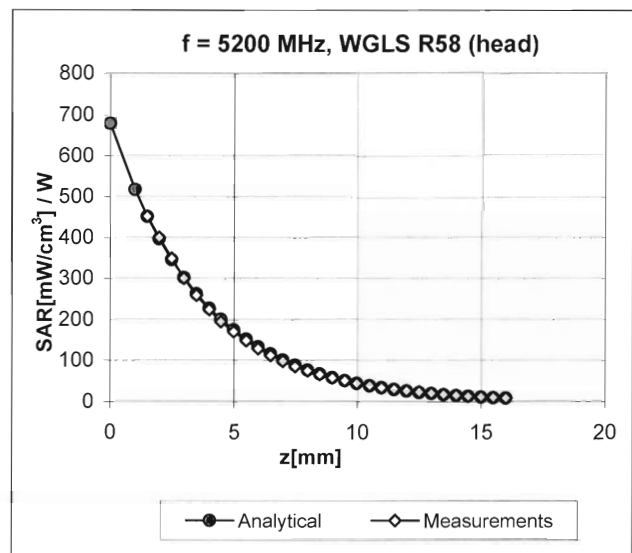
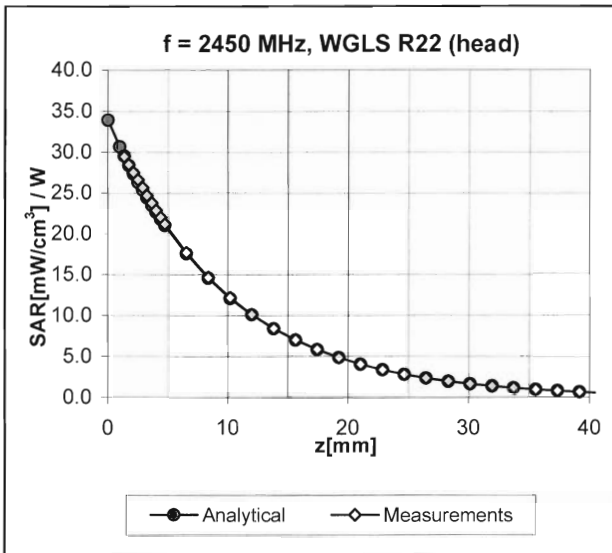

Deviation from Isotropy in HSL

Error (ϕ, ϑ), f = 900 MHz

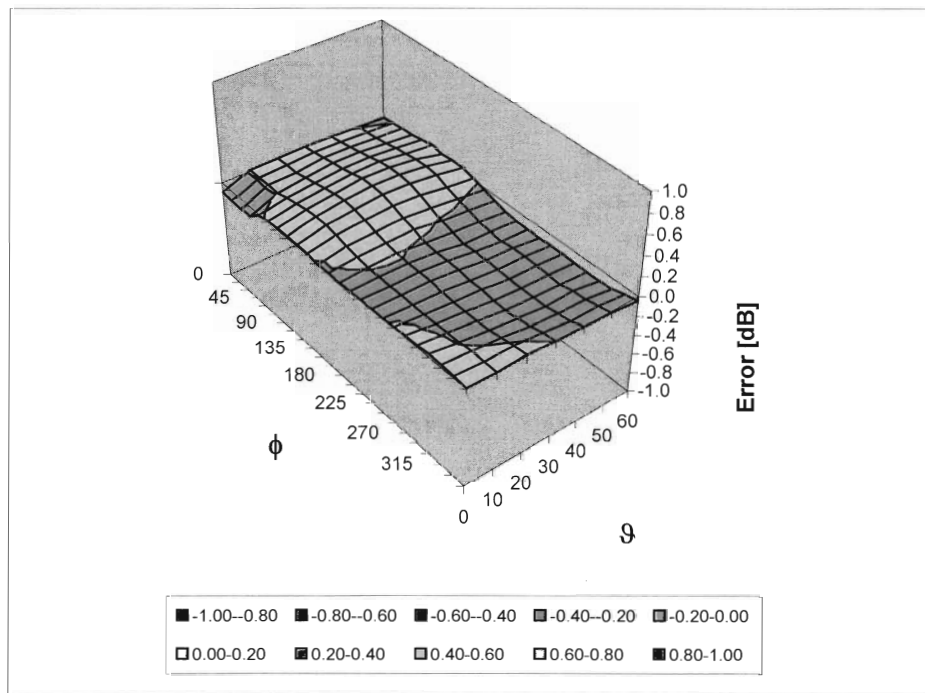

Uncertainty of Spherical Isotropy Assessment: $\pm 2.6\%$ (k=2)

Other Probe Parameters

Sensor Arrangement	Triangular
Connector Angle (°)	Not applicable
Mechanical Surface Detection Mode	enabled
Optical Surface Detection Mode	disabled
Probe Overall Length	337 mm
Probe Body Diameter	10 mm
Tip Length	9 mm
Tip Diameter	2.5 mm
Probe Tip to Sensor X Calibration Point	1 mm
Probe Tip to Sensor Y Calibration Point	1 mm
Probe Tip to Sensor Z Calibration Point	1 mm
Recommended Measurement Distance from Surface	2 mm

Dipole Calibration

Please see attached calibration data

Calibration Laboratory of Schmid & Partner Engineering AG
 Zeughausstrasse 43, 8004 Zurich, Switzerland



S Schweizerischer Kalibrierdienst
C Service suisse d'étalonnage
S Servizio svizzero di taratura
S Swiss Calibration Service

Accredited by the Swiss Accreditation Service (SAS)
 The Swiss Accreditation Service is one of the signatories to the EA Multilateral Agreement for the recognition of calibration certificates

Accreditation No.: **SCS 108**

Client **Northwest EMC**

Certificate No: **D2450V2-855_Nov10**

CALIBRATION CERTIFICATE

Object **D2450V2 - SN: 855**

Calibration procedure(s) **QA CAL-05.v7
 Calibration procedure for dipole validation kits**

Calibration date: **November 11, 2010**

This calibration certificate documents the traceability to national standards, which realize the physical units of measurements (SI). The measurements and the uncertainties with confidence probability are given on the following pages and are part of the certificate.

All calibrations have been conducted in the closed laboratory facility: environment temperature (22 ± 3)°C and humidity < 70%.

Calibration Equipment used (M&TE critical for calibration)

Primary Standards	ID #	Cal Date (Certificate No.)	Scheduled Calibration
Power meter EPM-442A	GB37480704	06-Oct-10 (No. 217-01266)	Oct-11
Power sensor HP 8481A	US37292783	06-Oct-10 (No. 217-01266)	Oct-11
Reference 20 dB Attenuator	SN: 5086 (20g)	30-Mar-10 (No. 217-01158)	Mar-11
Type-N mismatch combination	SN: 5047.2 / 06327	30-Mar-10 (No. 217-01162)	Mar-11
Reference Probe ES3DV3	SN: 3205	30-Apr-10 (No. ES3-3205_Apr10)	Apr-11
DAE4	SN: 601	10-Jun-10 (No. DAE4-601_Jun10)	Jun-11
Secondary Standards	ID #	Check Date (in house)	Scheduled Check
Power sensor HP 8481A	MY41092317	18-Oct-02 (in house check Oct-09)	In house check: Oct-11
RF generator R&S SMT-06	100005	4-Aug-99 (in house check Oct-09)	In house check: Oct-11
Network Analyzer HP 8753E	US37390585 S4206	18-Oct-01 (in house check Oct-10)	In house check: Oct-11

	Name	Function	Signature
Calibrated by:	Jeton Kastrati	Laboratory Technician	
Approved by:	Katja Pokovic	Technical Manager	

Issued: November 12, 2010

This calibration certificate shall not be reproduced except in full without written approval of the laboratory.

Measurement Conditions

DASY system configuration, as far as not given on page 1.

DASY Version	DASY5	V52.2
Extrapolation	Advanced Extrapolation	
Phantom	Modular Flat Phantom V5.0	
Distance Dipole Center - TSL	10 mm	with Spacer
Zoom Scan Resolution	dx, dy, dz = 5 mm	
Frequency	2450 MHz ± 1 MHz	

Head TSL parameters

The following parameters and calculations were applied.

	Temperature	Permittivity	Conductivity
Nominal Head TSL parameters	22.0 °C	39.2	1.80 mho/m
Measured Head TSL parameters	(22.0 ± 0.2) °C	38.8 ± 6 %	1.72 mho/m ± 6 %
Head TSL temperature during test	(22.5 ± 0.2) °C	----	----

SAR result with Head TSL

SAR averaged over 1 cm³ (1 g) of Head TSL	Condition	
SAR measured	250 mW input power	13.1 mW / g
SAR normalized	normalized to 1W	52.4 mW / g
SAR for nominal Head TSL parameters	normalized to 1W	53.4 mW / g ± 17.0 % (k=2)

SAR averaged over 10 cm³ (10 g) of Head TSL	condition	
SAR measured	250 mW input power	6.13 mW / g
SAR normalized	normalized to 1W	24.5 mW / g
SAR for nominal Head TSL parameters	normalized to 1W	24.7 mW / g ± 16.5 % (k=2)

Body TSL parameters

The following parameters and calculations were applied.

	Temperature	Permittivity	Conductivity
Nominal Body TSL parameters	22.0 °C	52.7	1.95 mho/m
Measured Body TSL parameters	(22.0 ± 0.2) °C	52.3 ± 6 %	1.92 mho/m ± 6 %
Body TSL temperature during test	(22.0 ± 0.2) °C	----	----

SAR result with Body TSL

SAR averaged over 1 cm ³ (1 g) of Body TSL	Condition	
SAR measured	250 mW input power	12.8 mW / g
SAR normalized	normalized to 1W	51.2 mW / g
SAR for nominal Body TSL parameters	normalized to 1W	51.5 mW / g ± 17.0 % (k=2)

SAR averaged over 10 cm ³ (10 g) of Body TSL	condition	
SAR measured	250 mW input power	5.96 mW / g
SAR normalized	normalized to 1W	23.8 mW / g
SAR for nominal Body TSL parameters	normalized to 1W	23.9 mW / g ± 16.5 % (k=2)

Appendix

Antenna Parameters with Head TSL

Impedance, transformed to feed point	54.0 Ω + 2.1 j Ω
Return Loss	- 27.2 dB

Antenna Parameters with Body TSL

Impedance, transformed to feed point	49.5 Ω + 5.0 j Ω
Return Loss	- 26.0 dB

General Antenna Parameters and Design

Electrical Delay (one direction)	1.158 ns
----------------------------------	----------

After long term use with 100W radiated power, only a slight warming of the dipole near the feedpoint can be measured.

The dipole is made of standard semirigid coaxial cable. The center conductor of the feeding line is directly connected to the second arm of the dipole. The antenna is therefore short-circuited for DC-signals.

No excessive force must be applied to the dipole arms, because they might bend or the soldered connections near the feedpoint may be damaged.

Additional EUT Data

Manufactured by	SPEAG
Manufactured on	November 10, 2009

DASY5 Validation Report for Head TSL

Date/Time: 11.11.2010 12:05:34

Test Laboratory: SPEAG, Zurich, Switzerland

DUT: Dipole 2450 MHz; Type: D2450V2; Serial: D2450V2 - SN:855

Communication System: CW; Frequency: 2450 MHz; Duty Cycle: 1:1

Medium: HSL U12 BB

Medium parameters used: $f = 2450$ MHz; $\sigma = 1.72$ mho/m; $\epsilon_r = 38.8$; $\rho = 1000$ kg/m³

Phantom section: Flat Section

Measurement Standard: DASY5 (IEEE/IEC/ANSI C63.19-2007)

DASY5 Configuration:

- Probe: ES3DV3 - SN3205; ConvF(4.53, 4.53, 4.53); Calibrated: 30.04.2010
- Sensor-Surface: 3mm (Mechanical Surface Detection)
- Electronics: DAE4 Sn601; Calibrated: 10.06.2010
- Phantom: Flat Phantom 5.0 (front); Type: QD000P50AA; Serial: 1001
- Measurement SW: DASY52, V52.2 Build 0, Version 52.2.0 (163)
- Postprocessing SW: SEMCAD X, V14.2 Build 2, Version 14.2.2 (1685)

Pin=250 mW/d=10mm, dist=3.0mm (ES-Probe)/Zoom Scan (7x7x7)/Cube 0: Measurement grid: dx=5mm, dy=5mm, dz=5mm

Reference Value = 102.4 V/m; Power Drift = 0.031 dB

Peak SAR (extrapolated) = 26.8 W/kg

SAR(1 g) = 13.1 mW/g; SAR(10 g) = 6.13 mW/g

Maximum value of SAR (measured) = 16.7 mW/g

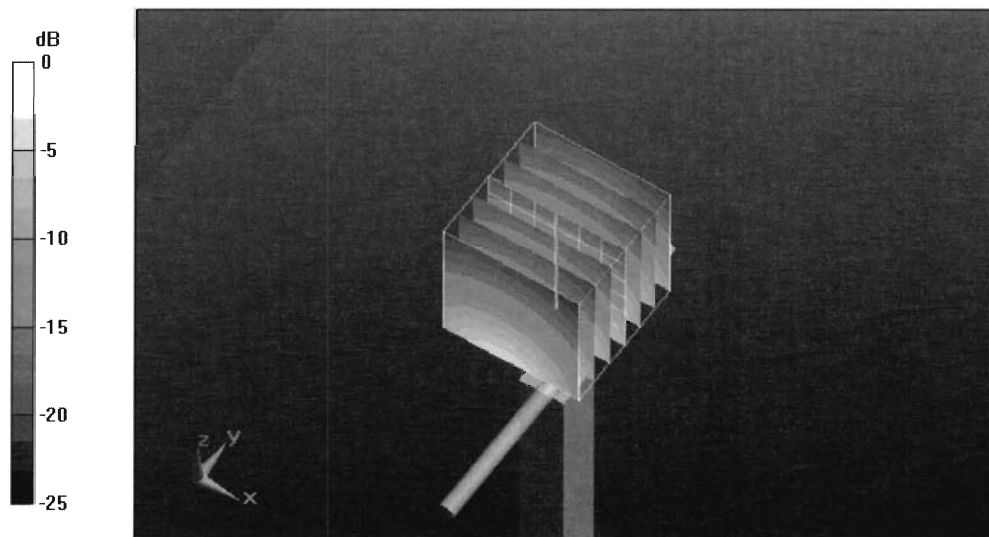

0 dB = 16.7mW/g

Impedance Measurement Plot for Head TSL

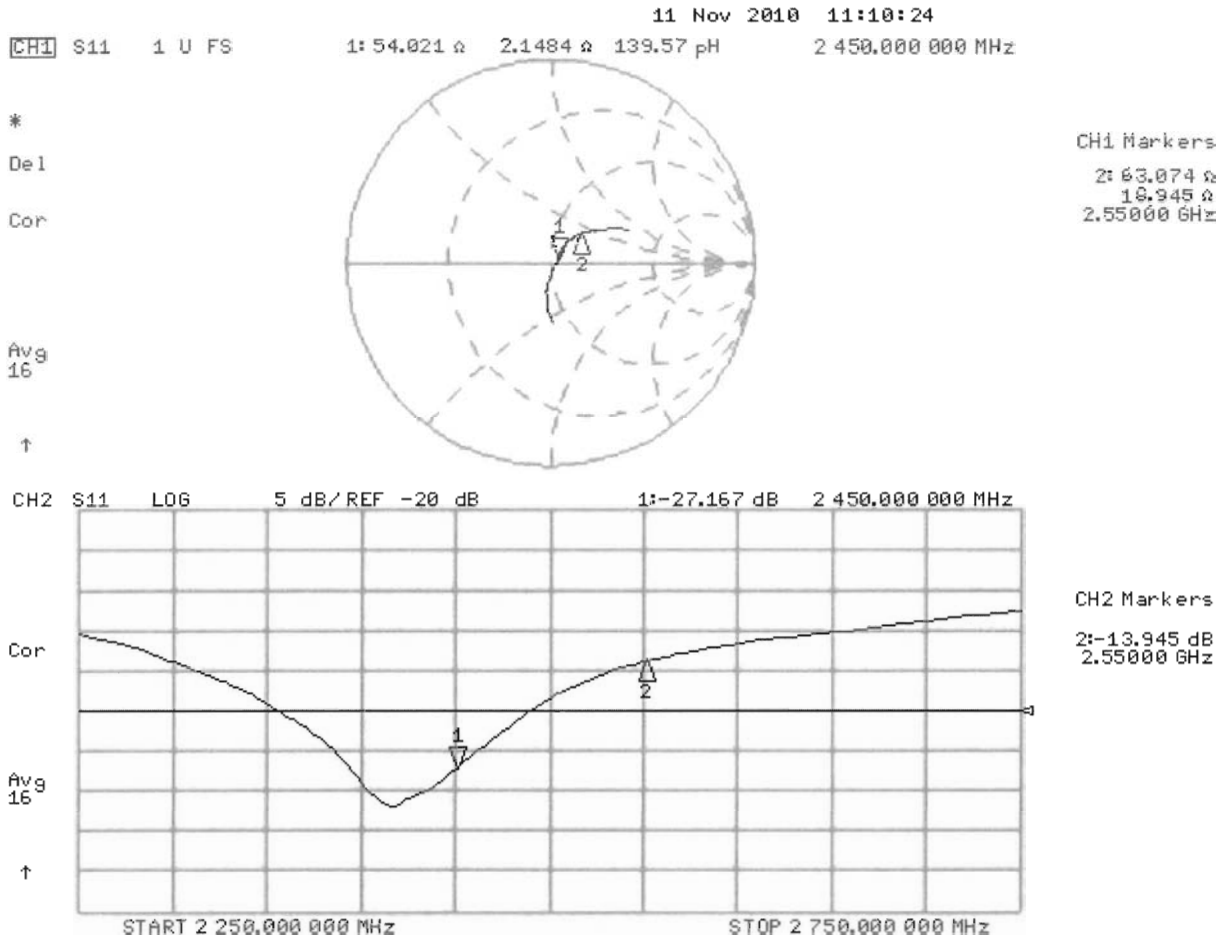

DASY5 Validation Report for Body

Date/Time: 11.11.2010 14:17:34

Test Laboratory: SPEAG, Zurich, Switzerland

DUT: Dipole 2450 MHz; Type: D2450V2; Serial: D2450V2 - SN:855

Communication System: CW; Frequency: 2450 MHz; Duty Cycle: 1:1

Medium: MSL U12 BB

Medium parameters used: $f = 2450$ MHz; $\sigma = 1.92$ mho/m; $\epsilon_r = 52.3$; $\rho = 1000$ kg/m³

Phantom section: Flat Section

Measurement Standard: DASY5 (IEEE/IEC/ANSI C63.19-2007)

DASY5 Configuration:

- Probe: ES3DV3 - SN3205; ConvF(4.31, 4.31, 4.31); Calibrated: 30.04.2010
- Sensor-Surface: 3mm (Mechanical Surface Detection)
- Electronics: DAE4 Sn601; Calibrated: 10.06.2010
- Phantom: Flat Phantom 5.0 (back); Type: QD000P50AA; Serial: 1002
- Measurement SW: DASY52, V52.2 Build 0, Version 52.2.0 (163)
- Postprocessing SW: SEMCAD X, V14.2 Build 2, Version 14.2.2 (1685)

Pin=250 mW /d=10mm, dist=3.0mm (ES-Probe)/Zoom Scan (7x7x7)/Cube 0: Measurement
grid: dx=5mm, dy=5mm, dz=5mm

Reference Value = 96.4 V/m; Power Drift = 0.034 dB

Peak SAR (extrapolated) = 26.7 W/kg

SAR(1 g) = 12.8 mW/g; SAR(10 g) = 5.96 mW/g

Maximum value of SAR (measured) = 16.9 mW/g

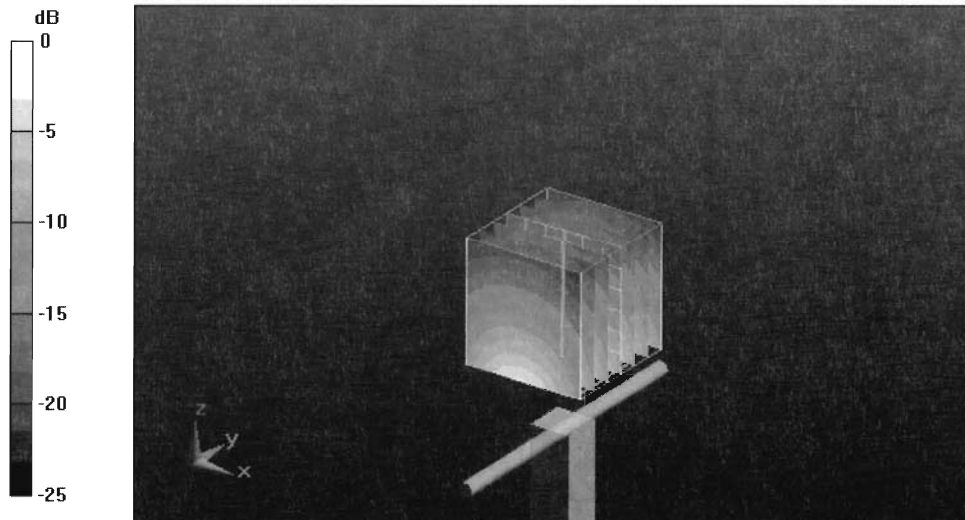

0 dB = 16.9mW/g

Impedance Measurement Plot for Body TSL

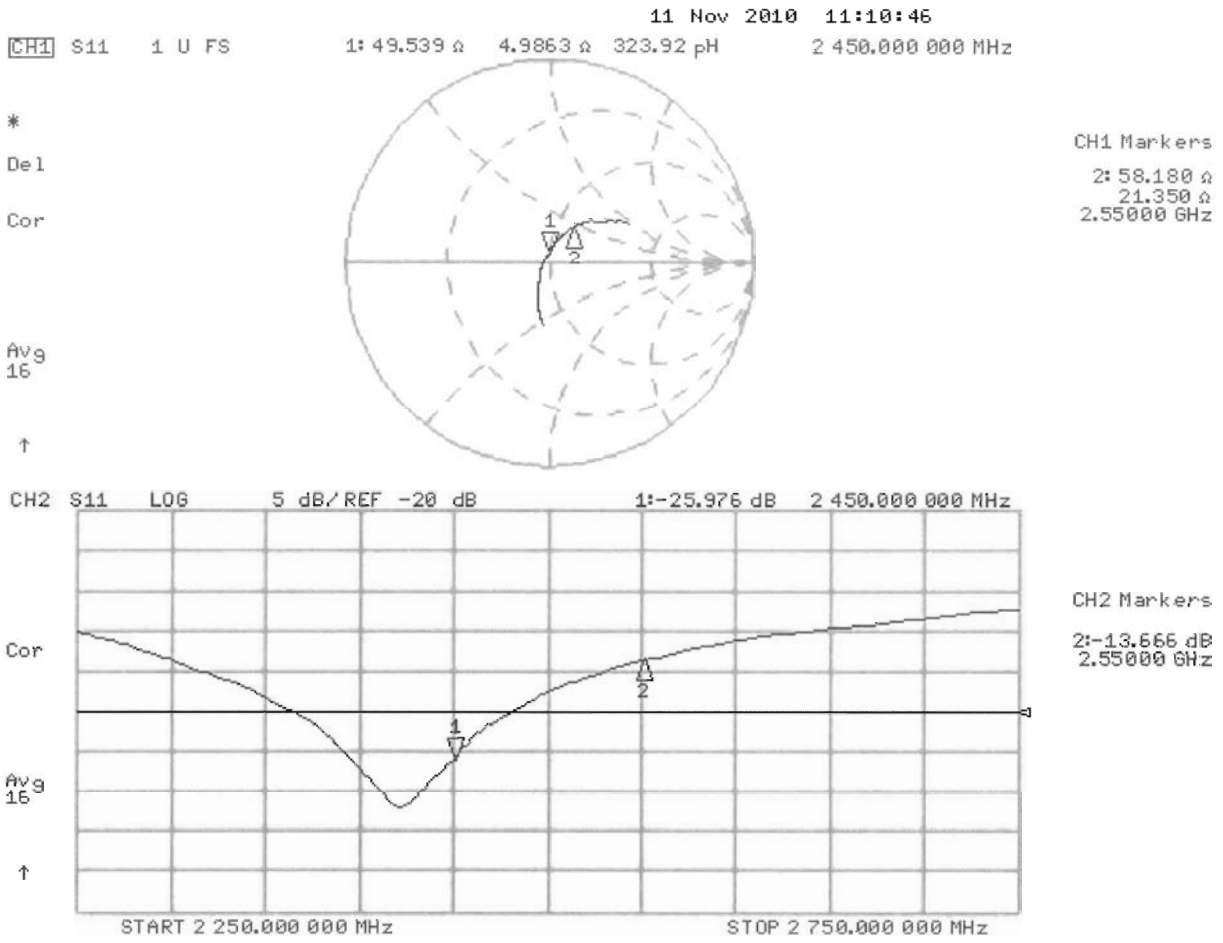

**Calibration Laboratory of
Schmid & Partner
Engineering AG**
Zeughausstrasse 43, 8004 Zurich, Switzerland



S Schweizerischer Kalibrierdienst
C Service suisse d'étalonnage
S Servizio svizzero di taratura
S Swiss Calibration Service

Accredited by the Swiss Accreditation Service (SAS)
The Swiss Accreditation Service is one of the signatories to the EA
Multilateral Agreement for the recognition of calibration certificates

Accreditation No.: **SCS 108**

Client **Northwest EMC**

Certificate No: **D5GHzV2-1066_Nov10**

CALIBRATION CERTIFICATE

Object **D5GHzV2 - SN: 1066**

Calibration procedure(s) **QA CAL-22.v1
Calibration procedure for dipole validation kits between 3-6 GHz**

Calibration date: **November 16, 2010**

This calibration certificate documents the traceability to national standards, which realize the physical units of measurements (SI).
The measurements and the uncertainties with confidence probability are given on the following pages and are part of the certificate.

All calibrations have been conducted in the closed laboratory facility: environment temperature (22 ± 3)°C and humidity < 70%.

Calibration Equipment used (M&TE critical for calibration)

Primary Standards	ID #	Cal Date (Certificate No.)	Scheduled Calibration
Power meter EPM-442A	GB37480704	06-Oct-10 (No. 217-01266)	Oct-11
Power sensor HP 8481A	US37292783	06-Oct-10 (No. 217-01266)	Oct-11
Reference 20 dB Attenuator	SN: 5086 (20g)	30-Mar-10 (No. 217-01158)	Mar-11
Type-N mismatch combination	SN: 5047.2 / 06327	30-Mar-10 (No. 217-01162)	Mar-11
Reference Probe EX3DV4	SN: 3503	05-Mar-10 (No. EX3-3503_Mar10)	Mar-11
DAE4	SN: 601	10-Jun-10 (No. DAE4-601_Jun10)	Jun-11

Secondary Standards	ID #	Check Date (in house)	Scheduled Check
Power sensor HP 8481A	MY41092317	18-Oct-02 (in house check Oct-09)	In house check: Oct-11
RF generator R&S SMT-06	100005	4-Aug-99 (in house check Oct-09)	In house check: Oct-11
Network Analyzer HP 8753E	US37390585 S4206	18-Oct-01 (in house check Oct-10)	In house check: Oct 11

Calibrated by: **Claudio Leubler** **Laboratory Technician**

Signature
CL

Approved by: **Katja Pokovic** **Technical Manager**

Signature
KP

Issued: November 17, 2010



Accredited by the Swiss Accreditation Service (SAS)
The Swiss Accreditation Service is one of the signatories to the EA
Multilateral Agreement for the recognition of calibration certificates

Accreditation No.: **SCS 108**

Glossary:

TSL	tissue simulating liquid
ConvF	sensitivity in TSL / NORM x,y,z
N/A	not applicable or not measured

Calibration is Performed According to the Following Standards:

- IEC Std 62209 Part 2, "Evaluation of Human Exposure to Radio Frequency Fields from Handheld and Body-Mounted Wireless Communication Devices in the Frequency Range of 30 MHz to 6 GHz: Human models, Instrumentation, and Procedures"; Part 2: "Procedure to determine the Specific Absorption Rate (SAR) for including accessories and multiple transmitters", Draft Version 0.9, December 2004
- Federal Communications Commission Office of Engineering & Technology (FCC OET), "Evaluating Compliance with FCC Guidelines for Human Exposure to Radiofrequency Electromagnetic Fields; Additional Information for Evaluating Compliance of Mobile and Portable Devices with FCC Limits for Human Exposure to Radiofrequency Emissions", Supplement C (Edition 01-01) to Bulletin 65

Additional Documentation:

- DASY4/5 System Handbook

Methods Applied and Interpretation of Parameters:

- Measurement Conditions:* Further details are available from the Validation Report at the end of the certificate. All figures stated in the certificate are valid at the frequency indicated.
- Antenna Parameters with TSL:* The dipole is mounted with the spacer to position its feed point exactly below the center marking of the flat phantom section, with the arms oriented parallel to the body axis.
- Feed Point Impedance and Return Loss:* These parameters are measured with the dipole positioned under the liquid filled phantom. The impedance stated is transformed from the measurement at the SMA connector to the feed point. The Return Loss ensures low reflected power. No uncertainty required.
- Electrical Delay:* One-way delay between the SMA connector and the antenna feed point. No uncertainty required.
- SAR measured:* SAR measured at the stated antenna input power.
- SAR normalized:* SAR as measured, normalized to an input power of 1 W at the antenna connector.
- SAR for nominal TSL parameters:* The measured TSL parameters are used to calculate the nominal SAR result.

Measurement Conditions

DASY system configuration, as far as not given on page 1.

DASY Version	DASY5	V52.2
Extrapolation	Advanced Extrapolation	
Phantom	Modular Flat Phantom V5.0	
Distance Dipole Center - TSL	10 mm	with Spacer
Area Scan resolution	dx, dy = 10 mm	
Zoom Scan Resolution	dx, dy = 4.0 mm, dz = 2.0 mm	
Frequency	5200 MHz ± 1 MHz 5500 MHz ± 1 MHz 5800 MHz ± 1 MHz	

Head TSL parameters at 5200 MHz

The following parameters and calculations were applied.

	Temperature	Permittivity	Conductivity
Nominal Head TSL parameters	22.0 °C	36.0	4.66 mho/m
Measured Head TSL parameters	(22.0 ± 0.2) °C	37.2 ± 6 %	4.59 mho/m ± 6 %
Head TSL temperature during test	(21.7 ± 0.2) °C	----	----

SAR result with Head TSL at 5200 MHz

SAR averaged over 1 cm³ (1 g) of Head TSL	condition	
SAR measured	100 mW input power	8.33 mW / g
SAR normalized	normalized to 1W	83.3 mW / g
SAR for nominal Head TSL parameters	normalized to 1W	83.8 mW / g ± 19.9 % (k=2)

SAR averaged over 10 cm³ (10 g) of Head TSL	condition	
SAR measured	100 mW input power	2.35 mW / g
SAR normalized	normalized to 1W	23.5 mW / g
SAR for nominal Head TSL parameters	normalized to 1W	23.6 mW / g ± 19.5 % (k=2)

Head TSL parameters at 5500 MHz

The following parameters and calculations were applied.

	Temperature	Permittivity	Conductivity
Nominal Head TSL parameters	22.0 °C	35.6	4.96 mho/m
Measured Head TSL parameters	(22.0 ± 0.2) °C	36.7 ± 6 %	4.90 mho/m ± 6 %
Head TSL temperature during test	(21.7 ± 0.2) °C	----	----

SAR result with Head TSL at 5500 MHz

SAR averaged over 1 cm ³ (1 g) of Head TSL	condition	
SAR measured	100 mW input power	8.88 mW / g
SAR normalized	normalized to 1W	88.8 mW / g
SAR for nominal Head TSL parameters	normalized to 1W	89.3 mW / g ± 19.9 % (k=2)

SAR averaged over 10 cm ³ (10 g) of Head TSL	condition	
SAR measured	100 mW input power	2.49 mW / g
SAR normalized	normalized to 1W	24.9 mW / g
SAR for nominal Head TSL parameters	normalized to 1W	25.0 mW / g ± 19.5 % (k=2)

Head TSL parameters at 5800 MHz

The following parameters and calculations were applied.

	Temperature	Permittivity	Conductivity
Nominal Head TSL parameters	22.0 °C	35.3	5.27 mho/m
Measured Head TSL parameters	(22.0 ± 0.2) °C	36.3 ± 6 %	5.21 mho/m ± 6 %
Head TSL temperature during test	(21.7 ± 0.2) °C	----	----

SAR result with Head TSL at 5800 MHz

SAR averaged over 1 cm ³ (1 g) of Head TSL	condition	
SAR measured	100 mW input power	8.25 mW / g
SAR normalized	normalized to 1W	82.5 mW / g
SAR for nominal Head TSL parameters	normalized to 1W	82.9 mW / g ± 19.9 % (k=2)

SAR averaged over 10 cm ³ (10 g) of Head TSL	condition	
SAR measured	100 mW input power	2.32 mW / g
SAR normalized	normalized to 1W	23.2 mW / g
SAR for nominal Head TSL parameters	normalized to 1W	23.3 mW / g ± 19.5 % (k=2)

Body TSL parameters at 5200 MHz

The following parameters and calculations were applied.

	Temperature	Permittivity	Conductivity
Nominal Body TSL parameters	22.0 °C	49.0	5.30 mho/m
Measured Body TSL parameters	(22.0 ± 0.2) °C	47.4 ± 6 %	5.32 mho/m ± 6 %
Body TSL temperature during test	(22.3 ± 0.2) °C	----	----

SAR result with Body TSL at 5200 MHz

SAR averaged over 1 cm ³ (1 g) of Body TSL	condition	
SAR measured	100 mW input power	7.86 mW / g
SAR normalized	normalized to 1W	78.6 mW / g
SAR for nominal Body TSL parameters	normalized to 1W	78.1 mW / g ± 19.9 % (k=2)

SAR averaged over 10 cm ³ (10 g) of Body TSL	condition	
SAR measured	100 mW input power	2.18 mW / g
SAR normalized	normalized to 1W	21.8 mW / g
SAR for nominal Body TSL parameters	normalized to 1W	21.6 mW / g ± 19.5 % (k=2)

Body TSL parameters at 5500 MHz

The following parameters and calculations were applied.

	Temperature	Permittivity	Conductivity
Nominal Body TSL parameters	22.0 °C	48.6	5.65 mho/m
Measured Body TSL parameters	(22.0 ± 0.2) °C	46.9 ± 6 %	5.70 mho/m ± 6 %
Body TSL temperature during test	(22.3 ± 0.2) °C	----	----

SAR result with Body TSL at 5500 MHz

SAR averaged over 1 cm ³ (1 g) of Body TSL	condition	
SAR measured	100 mW input power	8.54 mW / g
SAR normalized	normalized to 1W	85.4 mW / g
SAR for nominal Body TSL parameters	normalized to 1W	84.8 mW / g ± 19.9 % (k=2)

SAR averaged over 10 cm ³ (10 g) of Body TSL	condition	
SAR measured	100 mW input power	2.35 mW / g
SAR normalized	normalized to 1W	23.5 mW / g
SAR for nominal Body TSL parameters	normalized to 1W	23.3 mW / g ± 19.5 % (k=2)

Body TSL parameters at 5800 MHz

The following parameters and calculations were applied.

	Temperature	Permittivity	Conductivity
Nominal Body TSL parameters	22.0 °C	48.2	6.00 mho/m
Measured Body TSL parameters	(22.0 ± 0.2) °C	46.5 ± 6 %	6.10 mho/m ± 6 %
Body TSL temperature during test	(22.3 ± 0.2) °C	----	----

SAR result with Body TSL at 5800 MHz

SAR averaged over 1 cm ³ (1 g) of Body TSL	condition	
SAR measured	100 mW input power	7.61 mW / g
SAR normalized	normalized to 1W	76.1 mW / g
SAR for nominal Body TSL parameters	normalized to 1W	75.6 mW / g ± 19.9 % (k=2)

SAR averaged over 10 cm ³ (10 g) of Body TSL	condition	
SAR measured	100 mW input power	2.09 mW / g
SAR normalized	normalized to 1W	20.9 mW / g
SAR for nominal Body TSL parameters	normalized to 1W	20.7 mW / g ± 19.5 % (k=2)

Appendix

Antenna Parameters with Head TSL at 5200 MHz

Impedance, transformed to feed point	$51.2 \Omega - 7.0 j\Omega$
Return Loss	-23.1 dB

Antenna Parameters with Head TSL at 5500 MHz

Impedance, transformed to feed point	$52.6 \Omega - 2.8 j\Omega$
Return Loss	-28.6 dB

Antenna Parameters with Head TSL at 5800 MHz

Impedance, transformed to feed point	$56.0 \Omega - 0.4 j\Omega$
Return Loss	-24.9 dB

Antenna Parameters with Body TSL at 5200 MHz

Impedance, transformed to feed point	$51.4 \Omega - 5.6 j\Omega$
Return Loss	-24.8 dB

Antenna Parameters with Body TSL at 5500 MHz

Impedance, transformed to feed point	$52.9 \Omega - 2.0 j\Omega$
Return Loss	-29.4 dB

Antenna Parameters with Body TSL at 5800 MHz

Impedance, transformed to feed point	$56.7 \Omega + 1.2 j\Omega$
Return Loss	-23.9 dB

General Antenna Parameters and Design

Electrical Delay (one direction)	1.198 ns
----------------------------------	----------

After long term use with 40 W radiated power, only a slight warming of the dipole near the feedpoint can be measured.

The dipole is made of standard semirigid coaxial cable. The center conductor of the feeding line is directly connected to the second arm of the dipole. The antenna is therefore short-circuited for DC-signals.

No excessive force must be applied to the dipole arms, because they might bend or the soldered connections near the feedpoint may be damaged.

Additional EUT Data

Manufactured by	SPEAG
Manufactured on	November 27, 2006

DASY5 Validation Report for Head TSL

/Time: 15.11.2010 13:45:25

Test Laboratory: SPEAG, Zurich, Switzerland

DUT: Dipole 5GHz; Type: D5GHzV2; Serial: D5GHzV2 - SN:1066

Communication System: CW; Frequency: 5200 MHz, Frequency: 5500 MHz, Frequency: 5800 MHz; Duty Cycle: 1:1

Medium: HSL 501

Medium parameters used: $f = 5200$ MHz; $\sigma = 4.6$ mho/m; $\epsilon_r = 37.2$; $\rho = 1000$ kg/m³,

Medium parameters used: $f = 5500$ MHz; $\sigma = 4.91$ mho/m; $\epsilon_r = 36.7$; $\rho = 1000$ kg/m³,

Medium parameters used: $f = 5800$ MHz; $\sigma = 5.22$ mho/m; $\epsilon_r = 36.3$; $\rho = 1000$ kg/m³

Phantom section: Flat Section

Measurement Standard: DASY5 (IEEE/IEC/ANSI C63.19-2007)

DASY5 Configuration:

- Probe: EX3DV4 - SN3503; ConvF(5.36, 5.36, 5.36), ConvF(4.85, 4.85, 4.85), ConvF(4.74, 4.74, 4.74); Calibrated: 05.03.2010
- Sensor-Surface: 2mm (Mechanical Surface Detection)
- Electronics: DAE4 Sn601; Calibrated: 10.06.2010
- Phantom: Flat Phantom 5.0 (front); Type: QD000P50AA; Serial: 1001
- Measurement SW: DASY52, V52.2 Build 0, Version 52.2.0 (163)
- Postprocessing SW: SEMCAD X, V14.2 Build 2, Version 14.2.2 (1685)

Configuration D5GHzV2 Dipole (Head)/d=10mm, Pin=100mW, f=5200 MHz/Zoom Scan (4x4x2mm), dist=2mm (8x8x12)/Cube 0:

Measurement grid: dx=4mm, dy=4mm, dz=2mm

Reference Value = 64.7 V/m; Power Drift = 0.075 dB

Peak SAR (extrapolated) = 32.1 W/kg

SAR(1 g) = 8.33 mW/g; SAR(10 g) = 2.35 mW/g

Maximum value of SAR (measured) = 16.2 mW/g

Configuration D5GHzV2 Dipole (Head)/d=10mm, Pin=100mW, f=5500 MHz/Zoom Scan (4x4x2mm), dist=2mm (8x8x12)/Cube 0:

Measurement grid: dx=4mm, dy=4mm, dz=2mm

Reference Value = 65 V/m; Power Drift = 0.077 dB

Peak SAR (extrapolated) = 36.3 W/kg

SAR(1 g) = 8.88 mW/g; SAR(10 g) = 2.49 mW/g

Maximum value of SAR (measured) = 17.7 mW/g

Configuration D5GHzV2 Dipole (Head)/d=10mm, Pin=100mW, f=5800 MHz/Zoom Scan (4x4x2mm), dist=2mm (8x8x12)/Cube 0:

Measurement grid: dx=4mm, dy=4mm, dz=2mm

Reference Value = 61.5 V/m; Power Drift = 0.062 dB

Peak SAR (extrapolated) = 34.8 W/kg

SAR(1 g) = 8.25 mW/g; SAR(10 g) = 2.32 mW/g

Maximum value of SAR (measured) = 16.4 mW/g

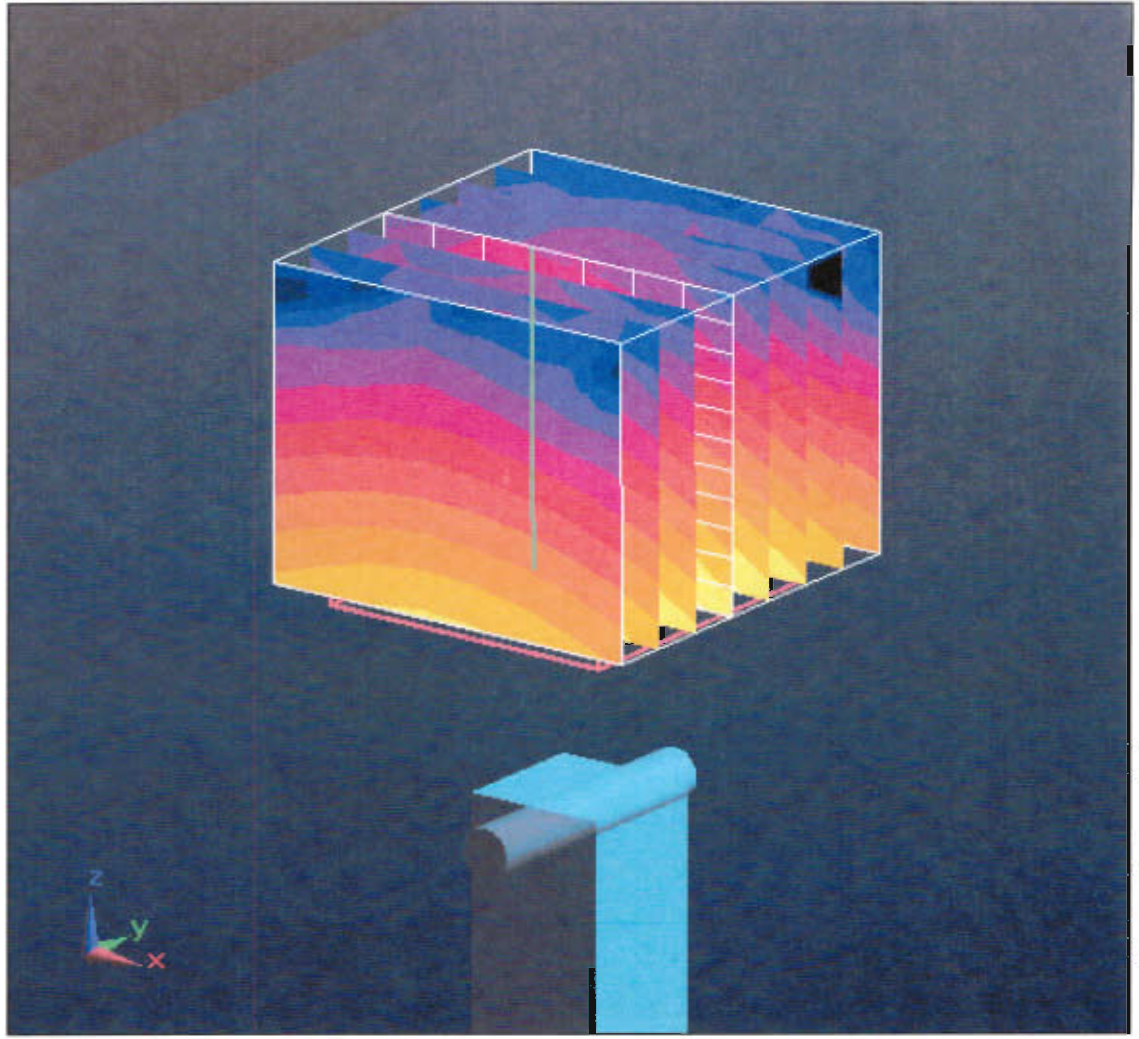

0 dB = 16.4mW/g

Impedance Measurement Plot for Head TSL

15 Nov 2010 09:44:56

CH1 S11 1 U FS

3: 51.168 Ω -6.9785 Ω 4.3859 pF 5 200.000 000 MHz

*
Del
Cor
Avg
16

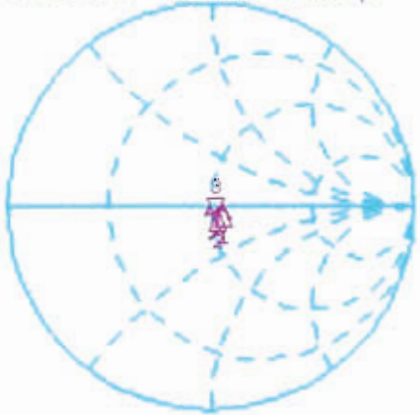

CH1 Markers

1: 55.984 Ω
-365.23 $m\Omega$
5.00000 GHz
2: 52.637 Ω
-2.7676 Ω
5.50000 GHz

CH2 S11 LOG 5 dB/REF -20 dB 3: -23.124 dB 5 200.000 000 MHz

Con
Avg
16

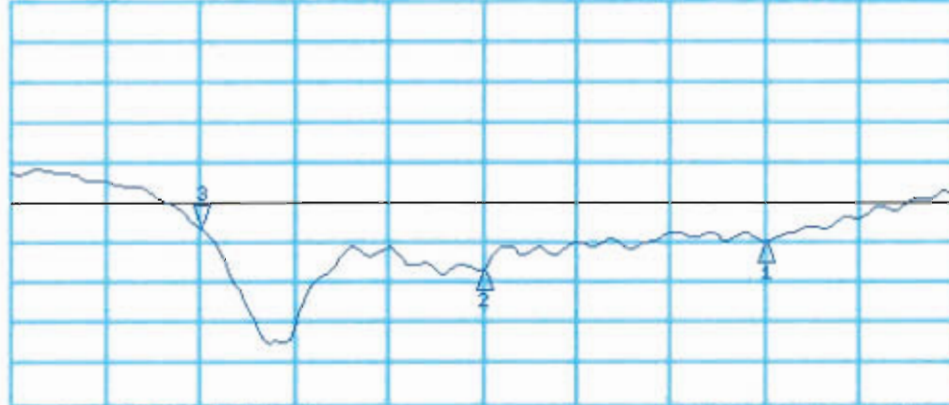

CH2 Markers

1: -24.942 dB
5.00000 GHz
2: -26.572 dB
5.50000 GHz

START 5 000.000 000 MHz

STOP 5 000.000 000 MHz

DASY5 Validation Report for Body TSL

Date/Time: 16.11.2010 15:06:09

Test Laboratory: SPEAG, Zurich, Switzerland

DUT: Dipole 5GHz; Type: D5GHzV2; Serial: D5GHzV2 - SN:1066

Communication System: CW; Frequency: 5200 MHz, Frequency: 5500 MHz, Frequency: 5800 MHz; Duty Cycle: 1:1

Medium: MSL 5000 MHz

Medium parameters used: $f = 5200$ MHz; $\sigma = 5.3$ mho/m; $\epsilon_r = 47.4$; $\rho = 1000$ kg/m³,

Medium parameters used: $f = 5500$ MHz; $\sigma = 5.68$ mho/m; $\epsilon_r = 46.9$; $\rho = 1000$ kg/m³,

Medium parameters used: $f = 5800$ MHz; $\sigma = 6.08$ mho/m; $\epsilon_r = 46.5$; $\rho = 1000$ kg/m³

Phantom section: Flat Section

Measurement Standard: DASY5 (IEEE/IEC/ANSI C63.19-2007)

DASY5 Configuration:

- Probe: EX3DV4 - SN3503; ConvF(4.88, 4.88, 4.88), ConvF(4.37, 4.37, 4.37), ConvF(4.57, 4.57, 4.57); Calibrated: 05.03.2010
- Sensor-Surface: 2mm (Mechanical Surface Detection)
- Electronics: DAE4 Sn601; Calibrated: 10.06.2010
- Phantom: Flat Phantom 5.0 (back); Type: QD000P50AA; Serial: 1002
- Measurement SW: DASY52, V52.2 Build 0, Version 52.2.0 (163)
- Postprocessing SW: SEMCAD X, V14.2 Build 2, Version 14.2.2 (1685)

Configuration D5GHzV2 Dipole (Body)/d=10mm, Pin=100mW, f=5200 MHz/Zoom Scan (4x4x2mm), dist=2mm (8x8x12)/Cube 0:

Measurement grid: dx=4mm, dy=4mm, dz=2mm

Reference Value = 60.6 V/m; Power Drift = 0.011 dB

Peak SAR (extrapolated) = 32 W/kg

SAR(1 g) = 7.86 mW/g; SAR(10 g) = 2.18 mW/g

Maximum value of SAR (measured) = 15.4 mW/g

Configuration D5GHzV2 Dipole (Body)/d=10mm, Pin=100mW, f=5500 MHz/Zoom Scan (4x4x2mm), dist=2mm (8x8x12)/Cube 0:

Measurement grid: dx=4mm, dy=4mm, dz=2mm

Reference Value = 61.2 V/m; Power Drift = -0.016 dB

Peak SAR (extrapolated) = 36.6 W/kg

SAR(1 g) = 8.54 mW/g; SAR(10 g) = 2.35 mW/g

Maximum value of SAR (measured) = 16.8 mW/g

Configuration D5GHzV2 Dipole (Body)/d=10mm, Pin=100mW, f=5800 MHz/Zoom Scan (4x4x2mm), dist=2mm (8x8x12)/Cube 0:

Measurement grid: dx=4mm, dy=4mm, dz=2mm

Reference Value = 56.3 V/m; Power Drift = 0.033 dB

Peak SAR (extrapolated) = 34.4 W/kg

SAR(1 g) = 7.61 mW/g; SAR(10 g) = 2.09 mW/g

Maximum value of SAR (measured) = 15.1 mW/g

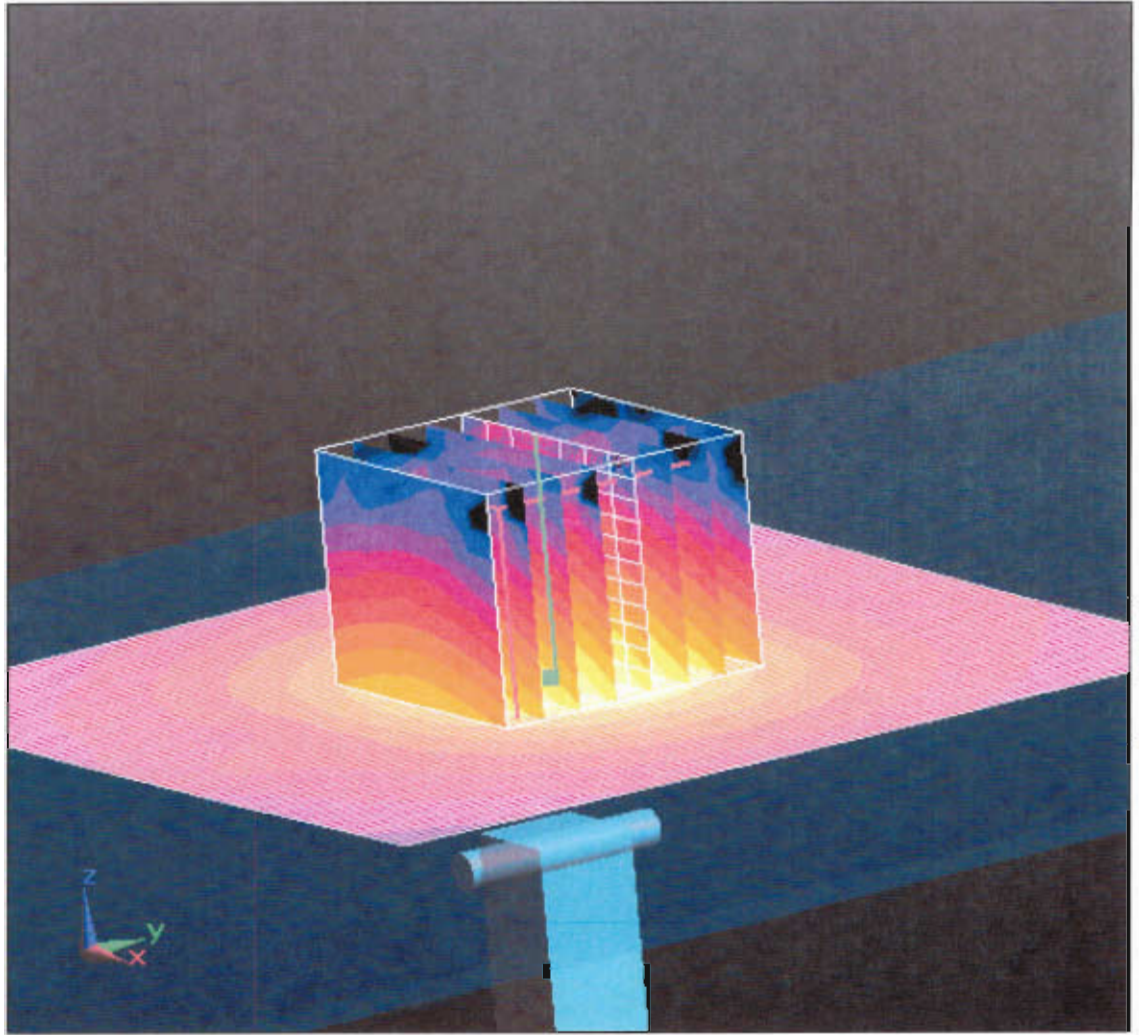

0 dB = 15.1mW/g

Impedance Measurement Plot for Body TSL

16 Nov 2010 12:14:24

CH1 S11 1 U FS

3: 51.412 Ω -5.6426 Ω 5.4242 μF 5 200.000 000 MHz

*
Del
Cor
Avg
16
†

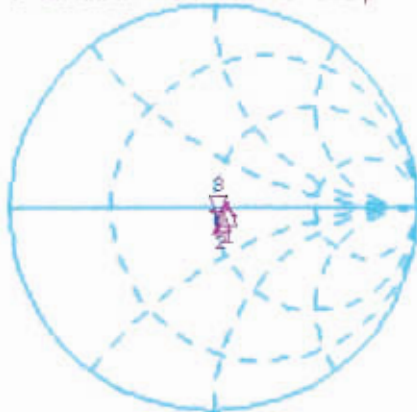

CH1 Markers

1: 56.717 Ω
1.2324 Ω
5.00000 GHz
2: 52.065 Ω
-1.9766 Ω
5.50000 GHz

CH2 S11 LOG 5 dB/REF -20 dB 3: -24.835 dB 5 200.000 000 MHz

Cor
Avg
16
†

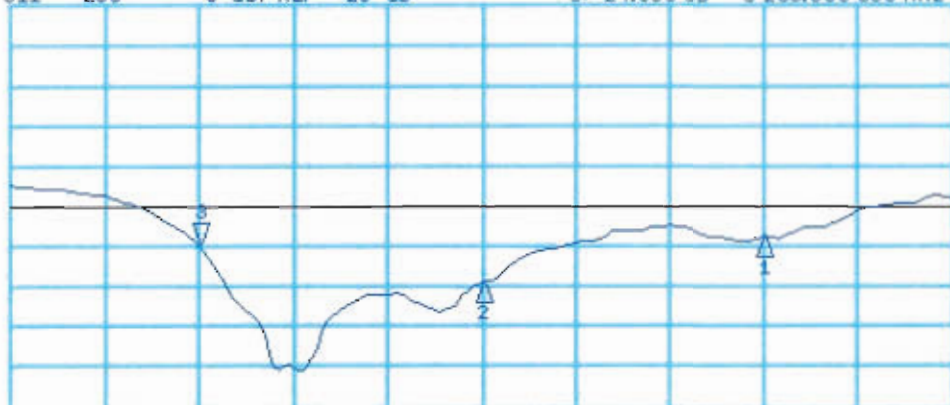

CH2 Markers

1: -23.876 dB
5.00000 GHz
2: -29.399 dB
5.50000 GHz