REPORT ON

Specific Absorption Rate Testing of the Intermec Technologies Corporation
CN3 Mobile Computer

Report No WS615435/01 Issue 2

September 2006



Product Service





Product Service

Competence. Certainty. Quality.

TUV Product Service Ltd, Octagon House, Concorde Way, Segensworth North,
Fareham, Hampshire, United Kingdom, PO15 5RL
Tel: +44 (0) 1489 558100. Website: www.tuvps.co.uk; www.babt.com

REPORT ON Specific Absorption Rate Testing of the Intermec Technologies Corporation
CN3 Mobile Computer

Report No: WS615435/01 Issue 2

PREPARED FOR Intermec Technologies Corporation
550 Second Street. SE
CEDAR RAPIDS
IA 52401-2023
USA

ATTESTATION The wireless portable device described within this report has been shown to be capable of compliance for localised specific absorption rate (SAR) for General Population/Uncontrolled Exposure Limits as defined in the Following standards; FCC standard Supplement C (Edition 01-01) to OET Bulletin 65 (Edition 97-01) and RSS-102 Issue 2 (Provisional) September 25, 1999 of 1.6 W/kg.
The measurements shown in this report were made in accordance with the procedures specified in Supplement C (Edition 01-01) to OET Bulletin 65 (Edition 97-01), RSS-102 Issue 2 (Provisional) September 25, 1999.
All reported testing was carried out on a sample of equipment to demonstrate compliance with the above standards. The sample tested was found to comply with the requirements in the applied rules.

A Miller
SAR Test Engineer

APPROVED BY

M Jenkins
Authorised Signatory

DATED

1st September 2006

Note: The test results reported herein relate only to the item tested as identified above and on the Status Page.

This report has been re-issued as Issue 2 to rectify typographical errors.

CONTENTS

Section	Page No
1	REPORT SUMMARY
1.1	Status 4
1.2	Summary 5
1.3	Test Results Summary 7
1.4	Output Power Measurements..... 11
2	TEST DETAILS
2.1	SAR Measurement System 14
	2.1.1 Robot System Specification
	2.1.2 Probe and Amplifier Specification
	2.1.3 SAR Measurement Procedure
2.2	Test Positions 19
2.3	850MHz GSM Head SAR Test Result Including Course Area Scan – 2D..... 20
2.3.1	850MHz GPRS Body SAR Test Result Including Course Area Scan – 2D 26
2.3.2	850MHz EGPRS Body SAR Test Result Including Course Area Scan – 2D..... 30
2.3.3	850MHz GPRS Body Holster SAR Test Result Including Course Area Scan – 2D..... 31
2.4	1900MHz GSM Head SAR Test Result Including Course Area Scan – 2D..... 32
2.4.1	1900MHz GSM Body SAR Test Result Including Course Area Scan – 2D 38
2.4.2	1900MHz EGPRS Body SAR Test Result Including Course Area Scan – 2D..... 42
2.4.3	1900MHz GPRS Body Holster SAR Test Result Including Course Area Scan – 2D..... 43
2.5	2450MHz WLAN Head SAR Test Result Including Course Area Scan – 2D..... 44
2.5.1	2450MHz WLAN Body SAR Test Result Including Course Area Scan – 2D 50
2.5.2	2450MHz WLAN Body Holster SAR Test Result Including Course Area Scan – 2D 54
3	TEST EQUIPMENT
3.1	Test Equipment 56
3.2	Test Software 56
3.3	Dielectric Properties of Simulant Liquids..... 57
3.4	Test Conditions..... 58
3.5	Measurement Uncertainty 59
4	PHOTOGRAPHS
4.1	Test Positional Photographs..... 61
4.2	Photographs of Equipment Under Test (EUT)... 64
5	ACCREDITATION, DISCLAIMERS AND COPYRIGHT
5.1	Accreditation, Disclaimers and Copyright..... 68
ANNEX A	Probe Calibration Information..... A.2

SECTION 1

REPORT SUMMARY

Specific Absorption Rate Testing of the Intermec Technologies Corporation
CN3 Mobile Computer

Max 1g SAR (W/kg)	1.031
The maximum 1g volume averaged SAR level measured for all the tests performed did not exceed the limits for General Population/Uncontrolled Exposure (W/kg) Partial Body of 1.6 W/kg. Level defined in Supplement C (Edition 01-01) to OET Bulletin 65 (97-01).	

1.1 STATUS

MANUFACTURING DESCRIPTION	Mobile Computer
STATUS OF TEST	Specific Absorption Rate Testing
APPLICANT	Intermec Technologies Corporation
POWER CLASS	GSM 850 Class 4 (+33dBm) PCS 1900 Class 1 (+30dBm) EGPRS GSM 850 (+27dBm) PCS1900 Class E2 (+26dBm)
GPRS CLASS	Class B
GPRS MULTI-SLOT CLASS	12 (4Dn;4Up;Sum5)
EGPRS CLASS	Class B
EGPRS MULTI-SLOT CLASS	10 (4Dn;2Up;Sum5)
MANUFACTURER	Intermec Technologies Corporation
TYPE OR MODEL NUMBER	Intermec CN3
CN3 HARDWARE VERSION	004
CN3 SOFTWARE VERSION	15096
CN3 SERIAL NUMBER	21590600241
MC75 HARDWARE VERSION	B2.5
MC75 SOFTWARE VERSION	02.002 (SV12)
MC75 IMEI NUMBER	IMEI 355634001531257
BATTERY MODEL	P/N: 318-016-002 (Li-ion 3.7V / 4000mHA)
BATTERY MANUFACTURER	Intermec Technologies Corporation

TEST SPECIFICATIONS:

1. Federal Communications Commission (FCC) OET Bulletin 65c, Edition 01-01, Evaluating Compliance with FCC Guidelines for Human Exposure to Radiofrequency Electromagnetic Fields – Additional Information for Evaluating Compliance of Mobile and Portable Devices with FCC Limits for Human Exposure to Radiofrequency Emissions.
2. RSS-102 Issue 2 (Provisional) September 25, 1999: Evaluation Procedure for Mobile and Portable Radio Transmitters with respect to Health Canada's Safety Code 6 for Exposure of Humans to radio Frequency Fields.

REFERENCES:

3. US Federal Government, Code of Federal Regulations, Title 47 Telecommunication, Chapter I Federal Communications Commission, part 2, section 1093.
4. IEEE 1528 – 2003: Recommended Practice for Determining the Peak Spatial-Average Specific Absorption Rate (SAR) in the Human Body Due to Wireless Communications Devices: Experimental Techniques.

BABT REGISTRATION NUMBER:	WS615435_01
RECEIPT OF TEST SAMPLES:	14 th August 2006
START OF TEST:	14 th August 2006
FINISH OF TEST:	25 th August 2006

1.2 SUMMARY

The unit supplied for testing is an Intermec CN3 Mobile Computer with a high capacity battery fitted, which offers Dual-Band (GSM/GPRS/EDGE 850/1900) WLAN and Bluetooth connectivity.

The following accessories were supplied for assessment with the device, these were: -

- CN3 Belt Clip Holster – Manufactured by Koszegi (ITC Part/No 815-060-001)

For Head SAR assessment, testing was performed with the device in the following modes GSM mode, WLAN 802.11 and Bluetooth CW test mode only using a Specific Anthropomorphic Mannequin (SAM) phantom, as specified in IEEE 1528-2003[4]. The phantom was filled with different simulant liquid appropriate to each frequency band. The dielectric properties were measured and found to be in accordance with the requirements for the dielectric properties specified in IEEE 1528-2003[8]. The Intermec CN3 Mobile Computer had a fixed external antenna so that the requirement for testing with antenna extended and retracted was not applicable

For head SAR assessment, testing was performed at both the left and right ear of the phantom at both handset positions stated in the above specification. Testing was performed at the middle frequency of each band and at the top and the bottom frequencies for the position giving maximum SAR. The sequence used accorded with the block diagram of tests given in IEEE 1528-2003 [4]. Testing was performed in the following modes of operation at the maximum power. For both the GSM850 and PCS1900 bands testing, this was achieved using a GSM test set, which controlled the handset at power level 5 and power level 0 respectively. For WLAN and Bluetooth assessment power level control was achieved via supplied customer software.

For Body SAR assessment, the device was tested for typical body-worn operation either separation of 15mm or placed in the belt-clip holster provided. Flat Phantom dimensions 220mmx200mmx150mm and with a sidewall thickness of 2.0mm. The phantom was filled to a depth of >150mm with the appropriate Body simulant liquid. The dielectric properties were in accordance with the requirements for the dielectric properties specified in Supplement C (Edition 01-01) to OET Bulletin 65 (Edition 97-01)[1].

For GPRS Body SAR assessment the device was placed into a GPRS Multislot Class 12 configuration, with 4 timeslots transmitting at maximum power for both the GSM850 and GSM1900. This was achieved using a Universal Radio Communication Tester (CMU200), which controlled the number of transmit slots and the handset power at level 4 (GSM850)(+33dBm), and power level 0 (GSM1900) (+30dBm) respectively.

For EGPRS (EDGE) Body SAR assessment the device was placed into an EGPRS Multislot Class 10 configuration, with 2 timeslots transmitting at maximum power for both the GSM850 and GSM1900. This was achieved using a Universal Radio Communication Tester (CMU200), which controlled the number of transmit slots and the handset power at level E2 (GSM850)(+27dBm), and power level E2 (GSM1900)(+26dBm) respectively.

For WLAN 802.11 Head and Body SAR assessment the device was placed in to a test mode configuration with test software supplied by the Client. The test software called FCC test utility version 1.01 enabled the radio module to be configured for Power; bit rate; and channel allocation. After evaluation of the bit rate it was shown that 1Mbps produced the higher SAR reading. Therefore for the purpose of this report testing was carried out with the radio module configured for 1Mbps

1.2 SUMMARY - Continued

For Bluetooth Head and Body assessment the device was placed into a test mode configuration with test software supplied by the client. The test software called BroadTest version 1.1 enabled the radio to be configured for frequency; modulation and power level. After initial scans it was shown that with the device placed either against the head or at 0.0mm separation from the Body the SAR was in the noise floor. The client stated that the maximum power for the device is 5 mW; therefore no further SAR evaluations were carried out.

The belt clip of the Mobile Computer Holster contains a metal spring enclosed within a plastic housing, with nominal dimensions: Overall length 152mm (formed into a semi-closed U shape); width 22mm and thickness 0.75mm.

Included in this report are descriptions of the test method; the equipment used and an analysis of the test uncertainties applicable and diagrams indicating the locations of maximum SAR for each test position along with photographs indicating the positioning of the handset against either the right or left ear, and/or distance and from the body as appropriate.

The maximum 1g volume averaged SAR level measured for all the tests performed did not exceed the limits for General Population/Uncontrolled Exposure (W/kg) Partial Body of 1.6 W/kg. Level defined in Supplement C (Edition 01-01) to OET Bulletin 65 (97-01)[2].

1.3 TEST RESULT SUMMARY

System Performance / Validation Check Results

Prior to formal testing being performed a System Check was performed in accordance with OET 65 Supplement C (Edition 01-01) [1] and the results were compared against published data in Standard IEEE 1528-2003 [4]. The following results were obtained: -

Date	Dipole Used	Frequency (MHz)	Max 1g SAR (W/kg)*	Percentage Drift on Reference (%)	Max 10g SAR (W/kg)*	Percentage Drift on Reference (%)
14/08/2006	900	907.5	10.63	-1.58%	6.88	-0.36%
16/08/2006	1900	1929	38.59	-2.80%	20.12	-1.87%
18/08/2006	2450	2450	47.33	-9.68%	22.63	-5.70%

*Normalised to a forward power of 1W

GSM 850MHz HEAD Specific Absorption Rate (Maximum SAR) 1g & 10g Results for the Intermec CN3 Mobile Computer.

Position		Channel Number	Frequency (MHz)	Max Spot SAR (W/kg)	Max 1g SAR (W/kg)	Max 10g SAR (W/kg)	SAR Drift (%)	Area scan (Figure number)
Left or Right Hand Ear	Mobile Position							
LH	Cheek	189	836.4	0.340	0.318	0.225	-1.620	Figure 7
LH	15°	189	836.4	0.160	0.147	0.110	2.410	Figure 8
RH	Cheek	189	836.4	0.470	0.448	0.325	-3.640	Figure 9
RH	15°	189	836.4	0.250	0.229	0.145	0.110	Figure 10
RH	Cheek	128	824.2	0.370	0.356	0.249	-0.040	Figure 11
RH	Cheek	251	848.8	0.560	0.528	0.369	4.740	Figure 12
Limit for General Population (Uncontrolled Exposure) 1.6 W/kg (1g) & 2.0 W/kg (10g)								

GPRS 850MHz BODY Specific Absorption Rate (Maximum SAR) 1g & 10g Results for the Intermec CN3 Mobile Computer – No Holster.

Position		Channel Number	Frequency (MHz)	Max Spot SAR (W/kg)	Max 1g SAR (W/kg)	Max 10g SAR (W/kg)	SAR Drift (%)	Area scan (Figure number)
Spacing From Phantom	Mobile Position							
15.0mm	Front facing	128	824.2	0.130	0.140	0.106	-2.540	Figure 13
15.0mm	Rear facing	189	836.4	0.140	0.159	0.113	0.730	Figure 14
15.0mm	Rear facing	251	848.8	0.110	0.126	0.090	0.000	Figure 15
15.0mm	Rear facing	251	848.8	0.180	0.203	0.145	0.470	Figure 16
Limit for General Population (Uncontrolled Exposure) 1.6 W/kg (1g) & 2.0 W/kg (10g)								

1.3 TEST RESULT SUMMARY - Continued

EGPRS 850MHz BODY Specific Absorption Rate (Maximum SAR) 1g & 10g Results for the Intermec CN3 Mobile Computer – No Holster.

Position		Channel Number	Frequency (MHz)	Max Spot SAR (W/kg)	Max 1g SAR (W/kg)	Max 10g SAR (W/kg)	SAR Drift (%)	Area scan (Figure number)
Spacing From Phantom	Mobile Position							
15.0mm	Rear facing	251	848.8	0.080	0.085	0.060	-0.260	Figure 17
Limit for General Population (Uncontrolled Exposure) 1.6 W/kg (1g) & 2.0 W/kg (10g)								

GPRS 850MHz BODY Specific Absorption Rate (Maximum SAR) 1g & 10g Results for the Intermec CN3 Mobile Computer Configured with CN3 Belt Clip Holster Part No: 815-060-001.

Position		Channel Number	Frequency (MHz)	Max Spot SAR (W/kg)	Max 1g SAR (W/kg)	Max 10g SAR (W/kg)	SAR Drift (%)	Area scan (Figure number)
Spacing From Phantom	Mobile Position							
0.0mm	Rear facing	251	848.8	0.240	0.271	0.190	2.270	Figure 18
Limit for General Population (Uncontrolled Exposure) 1.6 W/kg (1g) & 2.0 W/kg (10g)								

GSM 1900MHz HEAD Specific Absorption Rate (Maximum SAR) 1g & 10g Results for the Intermec CN3 Mobile Computer.

Position		Channel Number	Frequency (MHz)	Max Spot SAR (W/kg)	Max 1g SAR (W/kg)	Max 10g SAR (W/kg)	SAR Drift (%)	Area scan (Figure number)
Left or Right Hand Ear	Mobile Position							
LH	Cheek	661	1880.0	0.040	0.038	0.023	0.000	Figure 19
LH	15°	661	1880.0	0.050	0.039	0.024	1.260	Figure 20
RH	Cheek	661	1880.0	0.050	0.048	0.030	1.890	Figure 21
RH	15°	661	1880.0	0.060	0.049	0.032	-1.510	Figure 22
RH	Cheek	512	1850.2	0.060	0.046	0.029	-1.700	Figure 23
RH	Cheek	810	1909.8	0.040	0.040	0.025	0.000	Figure 24
Limit for General Population (Uncontrolled Exposure) 1.6 W/kg (1g) & 2.0 W/kg (10g)								

1.3 TEST RESULT SUMMARY - Continued

GPRS 1900MHz BODY Specific Absorption Rate (Maximum SAR) 1g & 10g Results for the Intermec CN3 Mobile Computer – No Holster.

Position		Channel Number	Frequency (MHz)	Max Spot SAR (W/kg)	Max 1g SAR (W/kg)	Max 10g SAR (W/kg)	SAR Drift (%)	Area scan (Figure number)
Spacing From Phantom	Mobile Position							
0.0mm	Front facing	661	1880.0	0.060	0.074	0.050	-1.100	Figure 25
15.0mm	Rear facing	661	1880.0	0.310	0.379	0.222	1.500	Figure 26
15.0mm	Rear facing	512	1850.2	0.280	0.339	0.199	0.070	Figure 27
15.0mm	Rear facing	810	1909.8	0.320	0.391	0.226	-1.200	Figure 28
Limit for General Population (Uncontrolled Exposure) 1.6 W/kg (1g) & 2.0 W/kg (10g)								

EGPRS 1900MHz BODY Specific Absorption Rate (Maximum SAR) 1g & 10g Results for the Intermec CN3 Mobile Computer – No Holster.

Position		Channel Number	Frequency (MHz)	Max Spot SAR (W/kg)	Max 1g SAR (W/kg)	Max 10g SAR (W/kg)	SAR Drift (%)	Area scan (Figure number)
Spacing From Phantom	Mobile Position							
15.0mm	Rear facing	810	1909.8	0.140	0.173	0.100	-3.690	Figure 29
Limit for General Population (Uncontrolled Exposure) 1.6 W/kg (1g) & 2.0 W/kg (10g)								

GPRS 1900MHz BODY Specific Absorption Rate (Maximum SAR) 1g & 10g Results for the Intermec CN3 Mobile Computer Configured with CN3 Belt Clip Holster Part No: 815-060-001.

Position		Channel Number	Frequency (MHz)	Max Spot SAR (W/kg)	Max 1g SAR (W/kg)	Max 10g SAR (W/kg)	SAR Drift (%)	Area scan (Figure number)
Spacing From Phantom	Mobile Position							
0.0mm	Rear facing	810	1909.8	0.450	0.543	0.292	-0.910	Figure 30
Limit for General Population (Uncontrolled Exposure) 1.6 W/kg (1g) & 2.0 W/kg (10g)								

1.3 TEST RESULT SUMMARY - Continued

WLAN 2450MHz HEAD Specific Absorption Rate (Maximum SAR) 1g & 10g Results for the Intermec CN3 Mobile Computer.

Position		Channel Number	Frequency (MHz)	Max Spot SAR (W/kg)	Max 1g SAR (W/kg)	Max 10g SAR (W/kg)	SAR Drift (%)	Area scan (Figure number)
Left or Right Hand Ear	Mobile Position							
LH	Cheek	6	2437.0	1.200	0.976	0.472	2.110	Figure 31
LH	15°	6	2437.0	1.100	0.930	0.411	0.950	Figure 32
RH	Cheek	6	2437.0	0.560	0.424	0.235	0.800	Figure 33
RH	15°	6	2437.0	0.380	0.340	0.183	-1.250	Figure 34
LH	Cheek	1	2412.0	1.310	1.031	0.508	-0.160	Figure 35
LH	Cheek	11	2472.0	1.290	1.028	0.467	1.760	Figure 36
Limit for General Population (Uncontrolled Exposure) 1.6 W/kg (1g) & 2.0 W/kg (10g)								

WLAN 2450MHz BODY Specific Absorption Rate (Maximum SAR) 1g & 10g Results for the Intermec CN3 Mobile Computer – No Holster.

Position		Channel Number	Frequency (MHz)	Max Spot SAR (W/kg)	Max 1g SAR (W/kg)	Max 10g SAR (W/kg)	SAR Drift (%)	Area scan (Figure number)
Spacing From Phantom	Mobile Position							
15.0mm	Front facing	6	2437.0	0.060	0.075	0.044	0.000	Figure 37
15.0mm	Rear facing	6	2437.0	0.020	0.020	0.012	0.000	Figure 38
15.0mm	Front facing	1	2412.0	0.070	0.087	0.050	0.000	Figure 39
15.0mm	Front facing	11	2472.0	0.060	0.073	0.042	0.000	Figure 40
Limit for General Population (Uncontrolled Exposure) 1.6 W/kg (1g) & 2.0 W/kg (10g)								

WLAN 2450MHz BODY Specific Absorption Rate (Maximum SAR) 1g & 10g Results for the Intermec CN3 Mobile Computer Configured with CN3 Belt Clip Holster Part No: 815-060-001.

Position		Channel Number	Frequency (MHz)	Max Spot SAR (W/kg)	Max 1g SAR (W/kg)	Max 10g SAR (W/kg)	SAR Drift (%)	Area scan (Figure number)
Spacing From Phantom	Mobile Position							
15.0mm	Front facing	1	2412.0	0.040	0.057	0.035	0.000	Figure 41
Limit for General Population (Uncontrolled Exposure) 1.6 W/kg (1g) & 2.0 W/kg (10g)								

1.4 OUTPUT POWER OF TEST DEVICE MEASUREMENT METHOD

The EUT was set up to Transmit on all of the following frequencies (See Table Below).

A peak measurement of the carrier frequency was recorded with the EUT in its worse case orientation using a RES B/W of 1MHz and Vid B/W of 1MHz at a distance of 3m.

A signal generator was then connected to a horn antenna at a fixed height of 1.5m, replacing the EUT. The measuring receive horn and the substituting transmit horn were then electronically aligned (height search at the received frequency until maximum correlation is achieved).

The signal generator level was adjusted until the recorded peak level (raw peak) was reproduced. The cable was then removed from the substitution transmit horn and attached to the measurement receiver input. The measured level into the substitution transmit horn and its isotropic gain was used to calculate the maximum radiated peak output power (ERP for 850) or (EIRP for 1900).

Table for GPRS 850 / 1900

Channel	Output Power (dBm)	Output Power (mW)
128	19.6	91.2
190	21.1	128.8
251	22.5	177.8
512	27.8	602.6
661	27.4	549.5
810	27.3	537.0

Table for EGPRS 850 / 1900

Channel	Output Power (dBm)	Output Power (mW)
128	20.7	117.5
190	22.3	158.5
251	23.5	223.9
512	26.5	446.7
661	27.5	562.3
810	28.1	645.7

Table for GSM 850

Channel	Output Power (dBm)	Output Power (mW)
128	26.3	427.6
190	27.3	537.0
251	28.3	676.1

1.4 OUTPUT POWER OF TEST DEVICE MEASUREMENT METHOD - Continued

Table for GSM 1900

Channel	Output Power (dBm)	Output Power (mW)
512	31.9	1514.0
661	31.7	1479.0
810	31.8	1514.0

Table for WLAN (1MBPS)

Channel	Output Power (dBm)	Output Power (mW)
1	13.5	22.4
6	18.3	67.6
11	19.6	91.2

Table for WLAN (18MBPS)

Channel	Output Power (dBm)	Output Power (mW)
1	14.0	25.1
6	20.8	120.2
11	21.7	147.9

Table for WLAN (54MBPS)

Channel	Output Power (dBm)	Output Power (mW)
1	18.1	64.6
6	17.0	50.1
11	18.4	69.2

Table for BT

Channel	Output Power (dBm)	Output Power (mW)
2	-1.6	0.7
41	-3.2	0.5
80	-9.5	0.1

SECTION 2

TEST DETAILS

Specific Absorption Rate Testing of the Intermec Technologies Corporation
CN3 Mobile Computer

2.1 SAR MEASUREMENT SYSTEM

2.1.1 ROBOT SYSTEM SPECIFICATION

The SAR measurement system being used is the IndexSAR SARA2 system, which consists of a Mitsubishi RV-E2 6-axis robot arm and controller, IndexSAR probe and amplifier and SAM phantom Head Shape. The robot is used to articulate the probe to programmed positions inside the phantom head to obtain the SAR readings from the DUT.

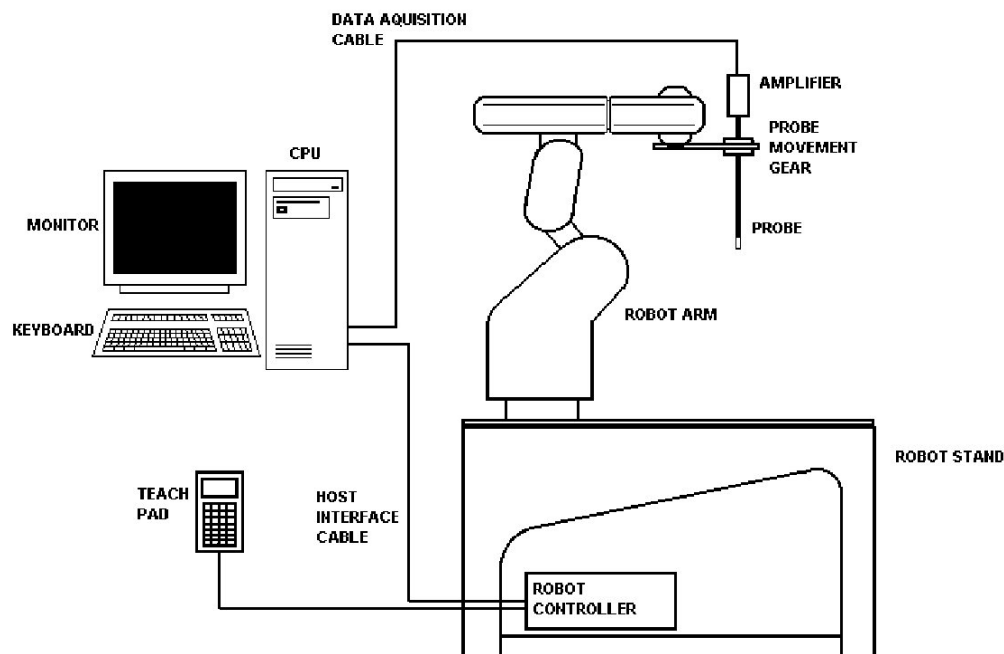

Figure 1: Schematic diagram of the SAR measurement system

The system is controlled remotely from a PC, which contains the software to control the robot and data acquisition equipment. The software also displays the data obtained from test scans.

The position and digitised shape of the phantom heads are made available to the software for accurate positioning of the probe and reduction of set-up time.

The SAM phantom heads are individually digitised using a Mitutoyo CMM machine to a precision of 0.001mm. The data is then converted into a shape format for the software, providing an accurate description of the phantom shell.

In operation, the system first does an area (2D) scan at a fixed depth within the liquid from the inside wall of the phantom. When the maximum SAR point has been found, the system will then carry out a 3D scan centred at that point to determine volume averaged SAR level.

2.1 SAR MEASUREMENT SYSTEM - Continued

2.1.2 PROBE AND AMPLIFIER SPECIFICATION

IXP-050 IndexSAR Isotropic Immersible SAR probe

The probes are constructed using three orthogonal dipole sensors arranged on an interlocking, triangular prism core. The probes have built-in shielding against static charges and are contained within a PEEK cylindrical enclosure material at the tip. Probe calibration is described in the following section.

IFA-010 Fast Amplifier

Technical description of IndexSAR IFA-010 Fast probe amplifier

A block diagram of the fast probe amplifier electronics is shown below.

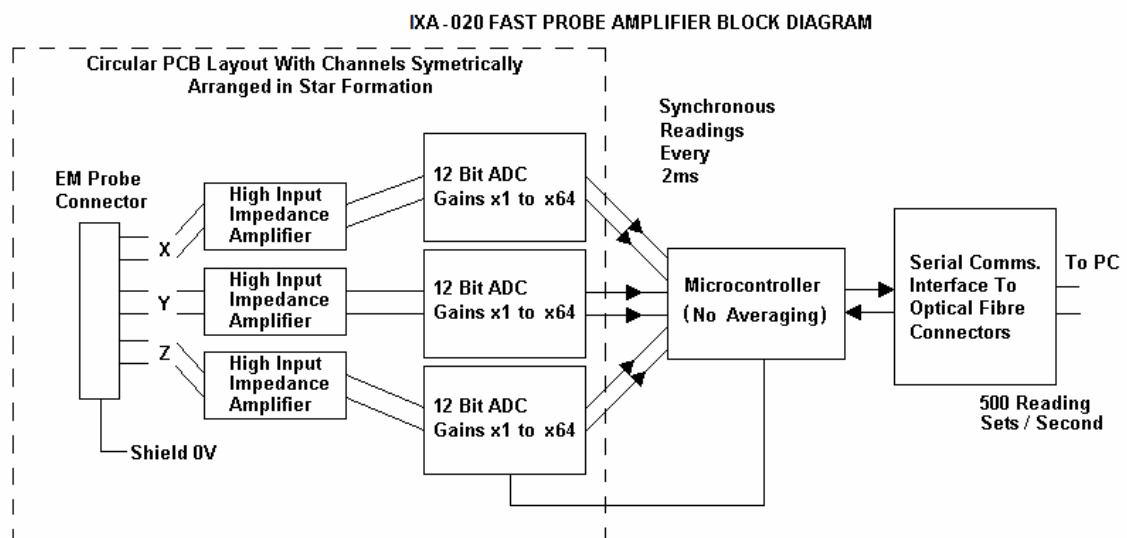

Figure 2: Block diagram of the fast probe amplifier electronic

This amplifier has a time constant of approx. $50\mu\text{s}$, which is much faster than the SAR probe response time. The overall system time constant is therefore that of the probe ($<1\text{ms}$) and reading sets for all three channels (simultaneously) are returned every 2ms to the PC. The conversion period is approx. $1\mu\text{s}$ at the start of each 2ms period. This enables the probe to follow pulse modulated signals of periods $\gg 2\text{ms}$. The PC software applies the linearization procedure separately to each reading, so no linearization corrections for the averaging of modulated signals are needed in this case. It is important to ensure that the probe reading frequency and the pulse period are not synchronised and the behaviour with pulses of short duration in comparison with the measurement interval need additional consideration.

Phantoms

The Cube phantom used is a Perspex Box IndexSAR item IXB-070. Dimensions of 200w x 200d x 200h (mm). This phantom is used with IndexSAR side bench IXM-030.

The Flat phantom used is a Rectangular Perspex Box IndexSAR item. Dimensions of 210w x 150d x 200h (mm). This phantom is used with IndexSAR upright bench. The phantom and robot alignment is assured by both mechanical and laser registration systems.

2.1 SAR MEASUREMENT SYSTEM - Continued

2.1.3 SAR MEASUREMENT PROCEDURE

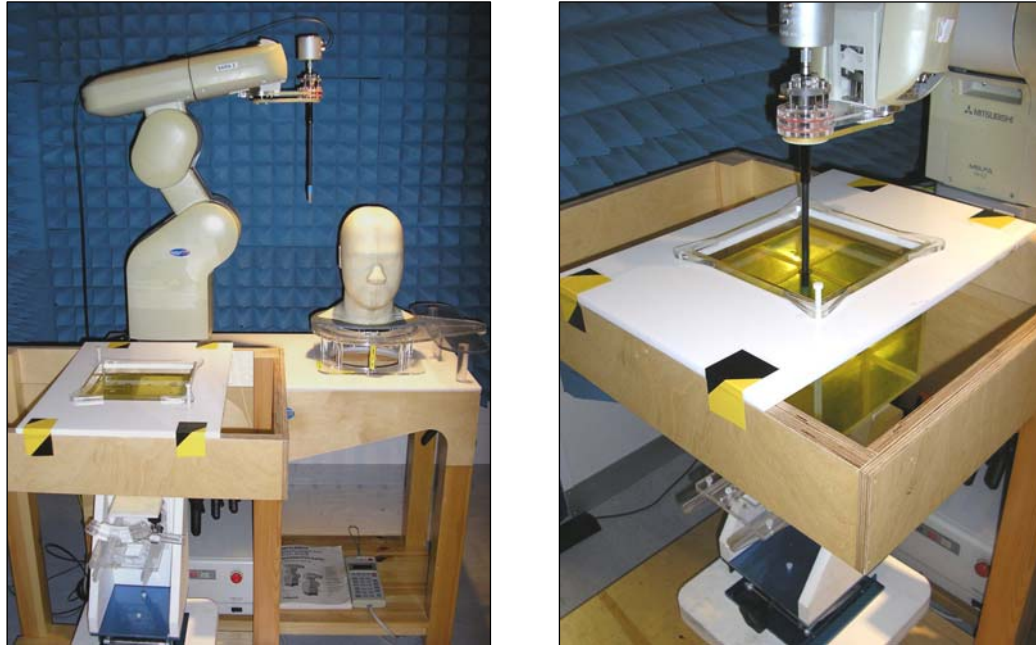

Figure 3: Principal components of the SAR measurement test bench

The major components of the test bench are shown in the picture above. A test set and dipole antenna control the handset via an air link and a low-mass phone holder can position the phone at either ear. Graduated scales are provided to set the phone in the 15 degree position. The upright phantom head holds approx. 7 litres of simulant liquid. The phantom is filled and emptied through a 45mm diameter penetration hole in the top of the head.

After an area scan has been done at a fixed distance of 8mm from the surface of the phantom on the source side, a 3D scan is set up around the location of the maximum spot SAR. First, a point within the scan area is visited by the probe and a SAR reading taken at the start of testing. At the end of testing, the probe is returned to the same point and a second reading is taken. Comparison between these start and end readings enables the power drift during measurement to be assessed.

SARA2 Interpolation and Extrapolation schemes

SARA2 software contains support for both 2D cubic B-spline interpolation as well as 3D cubic B-spline interpolation. In addition, for extrapolation purposes, a general n^{th} order polynomial fitting routine is implemented following a singular value decomposition algorithm presented in [4]. A 4th order polynomial fit is used by default for data extrapolation, but a linear-logarithmic fitting function can be selected as an option. The polynomial fitting procedures have been tested by comparing the fitting coefficients generated by the SARA2 procedures with those obtained using the polynomial fit functions of Microsoft Excel when applied to the same test input data.

Interpolation of 2D area scan

The 2D cubic B-spline interpolation is used after the initial area scan at fixed distance from the phantom shell wall. The initial scan data are collected with approx. 115mm spatial resolution and spline interpolation is used to find the location of the local maximum to within a 1mm resolution for positioning the subsequent 3D scanning.

2.1 SAR MEASUREMENT SYSTEM - Continued

2.1.3 SAR MEASUREMENT PROCEDURE

Extrapolation of 3D scan

For the 3D scan, data are collected on a spatially regular 3D grid having (by default) 6.4 mm steps in the lateral dimensions and 3.5 mm steps in the depth direction (away from the source). SARA2 enables full control over the selection of alternative step sizes in all directions.

The digitised shape of the head is available to the SARA2 software, which decides which points in the 3D array are sufficiently well within the shell wall to be 'visited' by the SAR probe. After the data collection, the data are extrapolated in the depth direction to assign values to points in the 3D array closer to the shell wall. A notional extrapolation value is also assigned to the first point outside the shell wall so that subsequent interpolation schemes will be applicable right up to the shell wall boundary.

Interpolation of 3D scan and volume averaging

The procedure used for defining the shape of the volumes used for SAR averaging in the SARA2 software follow the method of adapting the surface of the 'cube' to conform with the curved inner surface of the phantom (see Appendix C.2.2.1 in EN 50361:2001). This is called, here, the conformal scheme.

For each row of data in the depth direction, the data are extrapolated and interpolated to less than 1mm spacing and average values are calculated from the phantom surface for the row of data over distances corresponding to the requisite depth for 10g and 1g cubes. This results in two 2D arrays of data, which are then cubic B-spline interpolated to sub mm lateral resolution. A search routine then moves an averaging square around through the 2D array and records the maximum value of the corresponding 1g and 10g volume averages. For the definition of the surface in this procedure, the digitised position of the headshell surface is used for measurement in head-shaped phantoms. For measurements in rectangular, box phantoms, the distance between the phantom wall and the closest set of gridded data points is entered into the software.

For measurements in box-shaped phantoms, this distance is under the control of the user. The effective distance must be greater than 2.5mm as this is the tip-sensor distance and to avoid interface proximity effects, it should be at least 5mm. A value of 6 or 8mm is recommended. This distance is called **dbe** in EN 50361:2001.

For automated measurements inside the head, the distance cannot be less than 2.5mm, which is the radius of the probe tip and to avoid interface proximity effects, a minimum clearance distance of x mm is retained. The actual value of **dbe** will vary from point to point depending upon how the spatially-regular 3D grid points fit within the shell. The greatest separation is when a grid point is just not visited due to the probe tip dimensions. In this case the distance could be as large as the step-size plus the minimum clearance distance (i.e with $x=5$ and a step size of 3.5, **dbe** will be between 3.5 and 8.5mm).

The default step size (**dstep** in EN 50361:2001) used is 3.5mm, but this is under user-control. The compromise is with time of scan, so it is not practical to make it much smaller or scan times become long and power-drop influences become larger.

The robot positioning system specification for the repeatability of the positioning (**dss** in EN50361:2001) is +/- 0.04mm.

2.1 SAR MEASUREMENT SYSTEM - Continued

2.1.3 SAR MEASUREMENT PROCEDURE

The phantom shell is made by an industrial moulding process from the CAD files of the SAM shape, with both internal and external moulds. For the upright phantoms, the external shape is subsequently digitised on a Mitutoyo CMM machine (Euro C574) to a precision of 0.001mm. Wall thickness measurements made non-destructively with an ultrasonic sensor indicate that the shell thickness (**dph**) away from the ear is 2.0 +/- 0.1mm. The ultrasonic measurements were calibrated using additional mechanical measurements on available cut surfaces of the phantom shells.

For the upright phantom, the alignment is based upon registration of the rotation axis of the phantom on its 253mm-diameter baseplate bearing and the position of the probe axis when commanded to go to the axial position. A laser alignment tool is provided (procedure detailed elsewhere). This enables the registration of the phantom tip (**dmis**) to be assured to within approx. 0.2mm. This alignment is done with reference to the actual probe tip after installation and probe alignment. The rotational positioning of the phantom is variable – offering advantages for special studies, but locating pins ensure accurate repositioning at the principal positions (LH and RH ears).

2.2 TEST POSITIONS

This recommended practice specifies exactly two test positions for the handset against the head phantom, the “cheek” position and the “tilted” position. These two test positions are defined in the following sub-clauses. The handset should be tested in both positions on the left and right sides of the SAM phantom. In each test position the centre of the earpiece of the device is placed directly at the entrance of the auditory canal. The angles mentioned in the test positions used are referenced to the line connecting both auditory canal openings. The plane this line is on is known as the reference plane. Testing is performed on the right and left-hand sides of the generic phantom head.

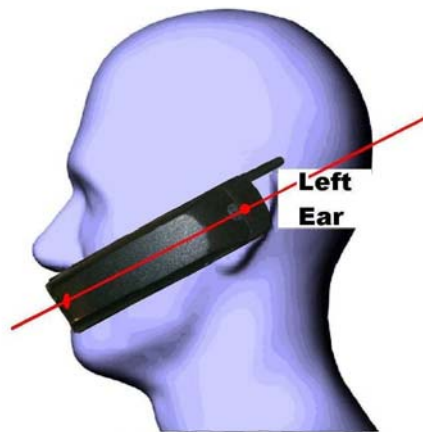

Figure 4. – Side View of Mobile next to head showing alignment.

The Cheek Position

The Cheek Position is where the mobile is in the reference plane and the line between the mobile and the line connecting both auditory canal openings is reduced until any part of the mobile touches any part of the generic twin phantom head.

The 15° Position

The 15° Position is where the mobile is in the reference cheek position and the phone is kept in contact with the auditory canal at the earpiece, the bottom of the phone is then tilted away from the phantom mouth by 15°.

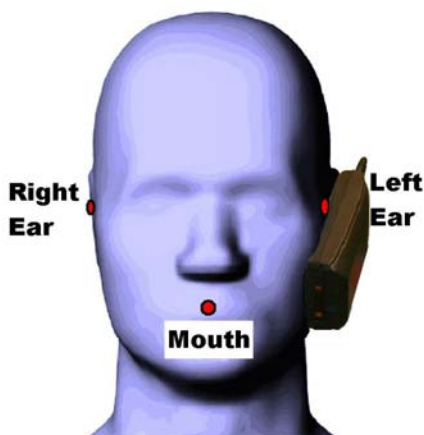

Figure 5. – Cheek Position.

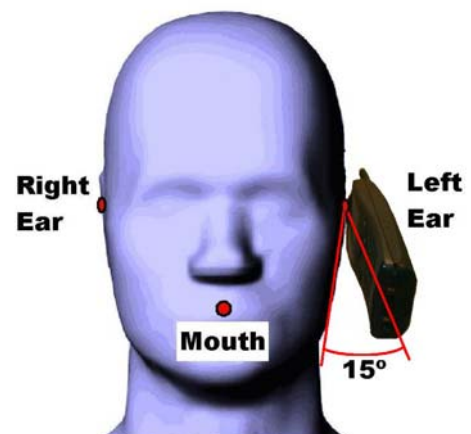

Figure 6. – 15° Tilt Position.

2.3 850MHz GSM HEAD SAR TEST RESULT INCLUDING COURSE AREA SCAN – 2D

SYSTEM / SOFTWARE:	SARA2 / 2.39 VPM	INPUT POWER DRIFT:	0.0 dB
DATE / TIME:	15/08/2006 09:20:46	DUT BATTERY MODEL/NO:	N/A
FILENAME:	WS615435_F_01.txt	PROBE SERIAL NUMBER:	187
AMBIENT TEMPERATURE:	22.9°C	LIQUID SIMULANT:	835 Head
DEVICE UNDER TEST:	Intermec CN3	RELATIVE PERMITTIVITY:	42.54
RELATIVE HUMIDITY:	46.2%	CONDUCTIVITY:	0.919
PHANTOM S/NO:	Head_04_35.csv	LIQUID TEMPERATURE:	21.8°C
PHANTOM ROTATION:	0°	MAX SAR Y-AXIS LOCATION:	-22.80 mm
DUT POSITION:	LH-Cheek	MAX SAR Z-AXIS LOCATION:	-142.50 mm
ANTENNA CONFIGURATION:	Fixed Internal	MAX E FIELD:	19.19 V/m
TEST FREQUENCY:	836.4MHz	SAR 1g:	0.318 W/kg
AIR FACTORS:	345 / 442 / 414	SAR 10g:	0.225 W/kg
CONVERSION FACTORS:	0.312 / 0.312 / 0.312	SAR START:	0.168 W/kg
TYPE OF MODULATION:	GMSK (GSM mode)	SAR END:	0.165 W/kg
MODN. DUTY CYCLE:	12.5%	SAR DRIFT DURING SCAN:	-1.62 %
DIODE COMPRESSION FACTORS (V*200):	20 / 20 / 20	PROBE BATTERY LAST CHANGED:	14/08/2006
INPUT POWER LEVEL:	5	EXTRAPOLATION:	poly4

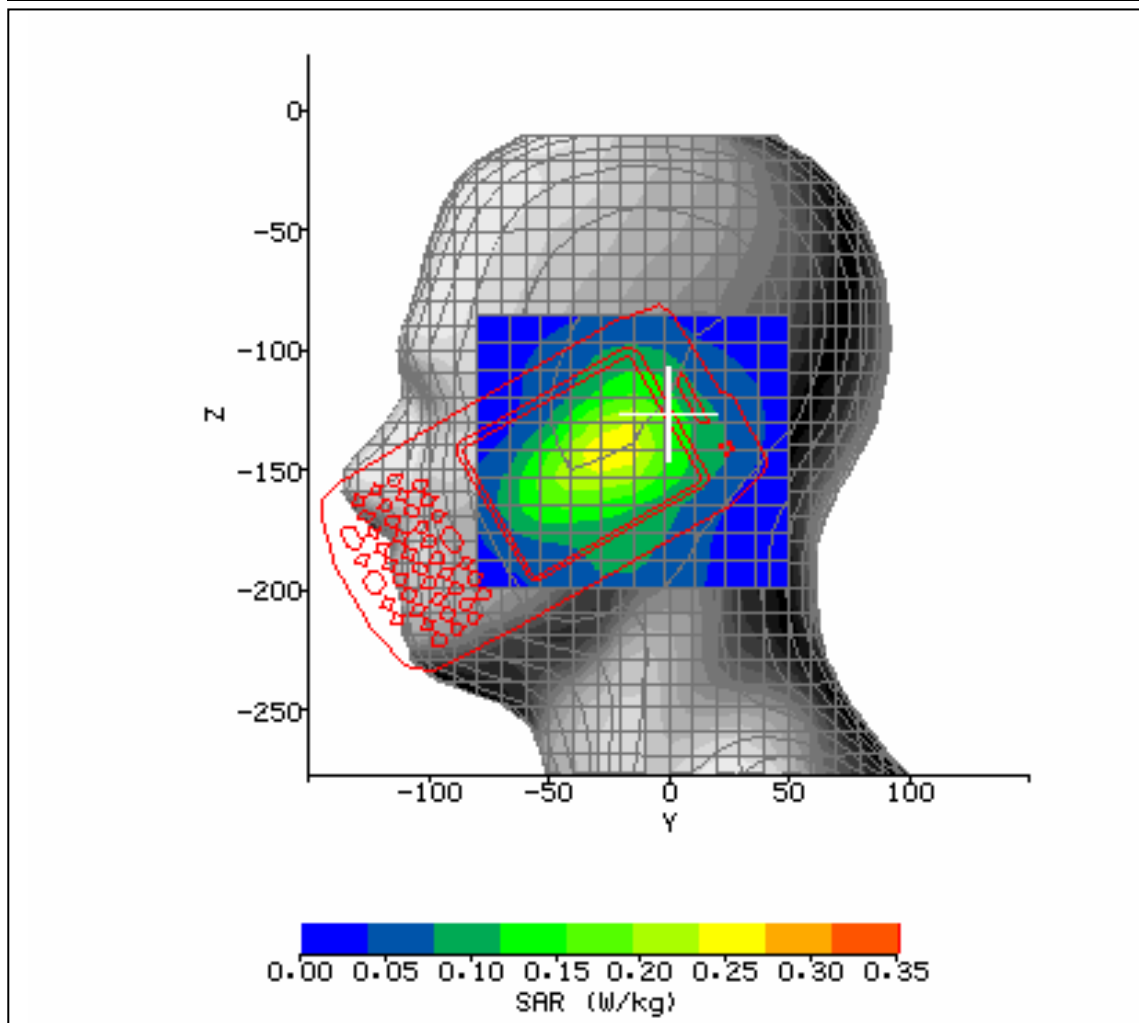

Figure 7: SAR Head Testing Results for the Intermec CN3 Mobile Computer in Left Hand Cheek Position; Tested at 836.4MHz (850MHz GSM Middle Channel).

2.3 850MHz GSM HEAD SAR TEST RESULT INCLUDING COURSE AREA SCAN – 2D

SYSTEM / SOFTWARE:	SARA2 / 2.39 VPM	INPUT POWER DRIFT:	0.0 dB
DATE / TIME:	15/08/2006 10:08:37	DUT BATTERY MODEL/NO:	318-016-002
FILENAME:	WS615435_F_02.txt	PROBE SERIAL NUMBER:	187
AMBIENT TEMPERATURE:	22.7°C	LIQUID SIMULANT:	835 Head
DEVICE UNDER TEST:	Intermec CN3	RELATIVE PERMITTIVITY:	42.54
RELATIVE HUMIDITY:	44.2%	CONDUCTIVITY:	0.919
PHANTOM S/NO:	Head_04_35.csv	LIQUID TEMPERATURE:	21.7°C
PHANTOM ROTATION:	0°	MAX SAR Y-AXIS LOCATION:	-8.63 mm
DUT POSITION:	LH-Cheek 15°	MAX SAR Z-AXIS LOCATION:	-131.73 mm
ANTENNA CONFIGURATION:	Fixed Internal	MAX E FIELD:	13.28 V/m
TEST FREQUENCY:	836.4MHz	SAR 1g:	0.147 W/kg
AIR FACTORS:	345 / 442 / 414	SAR 10g:	0.110 W/kg
CONVERSION FACTORS:	0.312 / 0.312 / 0.312	SAR START:	0.079 W/kg
TYPE OF MODULATION:	GMSK (GSM mode)	SAR END:	0.081 W/kg
MODN. DUTY CYCLE:	12.5%	SAR DRIFT DURING SCAN:	2.41 %
DIODE COMPRESSION FACTORS (V*200):	20 / 20 / 20	PROBE BATTERY LAST CHANGED:	14/08/2006
INPUT POWER LEVEL:	5	EXTRAPOLATION:	poly4

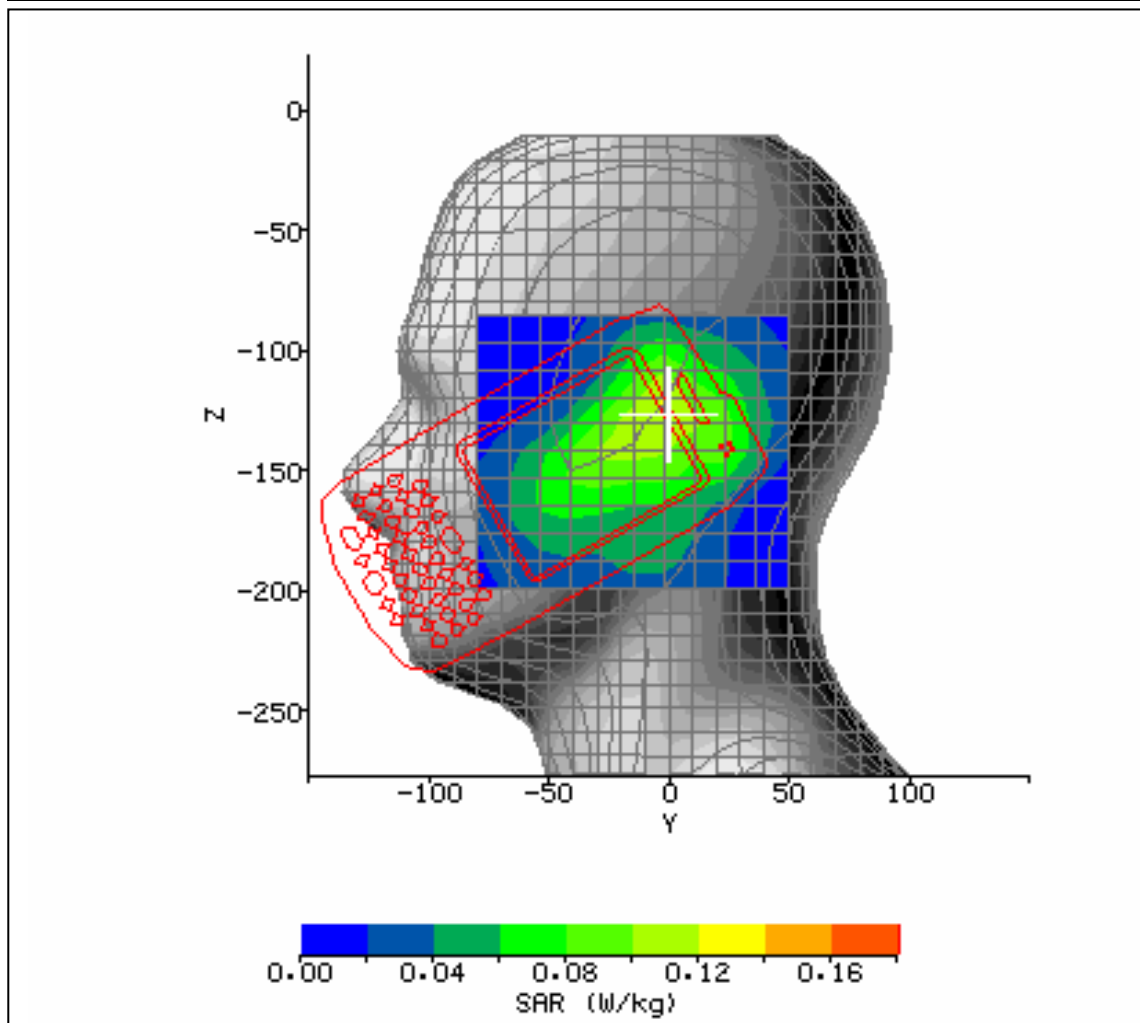

Figure 8: SAR Head Testing Results for the Intermec CN3 Mobile Computer in Left Hand Cheek 15° Position; Tested at 836.4MHz (850MHz GSM Middle Channel).

2.3 850MHz GSM HEAD SAR TEST RESULT INCLUDING COURSE AREA SCAN – 2D

SYSTEM / SOFTWARE:	SARA2 / 2.39 VPM	INPUT POWER DRIFT:	0.0 dB
DATE / TIME:	15/08/2006 10:41:29	DUT BATTERY MODEL/NO:	318-016-002
FILENAME:	WS615435_F_03.txt	PROBE SERIAL NUMBER:	187
AMBIENT TEMPERATURE:	22.7°C	LIQUID SIMULANT:	835 Head
DEVICE UNDER TEST:	Intermec CN3	RELATIVE PERMITTIVITY:	42.54
RELATIVE HUMIDITY:	43.0%	CONDUCTIVITY:	0.919
PHANTOM S/NO:	Head_04_35.csv	LIQUID TEMPERATURE:	21.7°C
PHANTOM ROTATION:	180°	MAX SAR Y-AXIS LOCATION:	27.87 mm
DUT POSITION:	RH-Cheek	MAX SAR Z-AXIS LOCATION:	-152.43 mm
ANTENNA CONFIGURATION:	Fixed Internal	MAX E FIELD:	22.61 V/m
TEST FREQUENCY:	836.4MHz	SAR 1g:	0.448 W/kg
AIR FACTORS:	345 / 442 / 414	SAR 10g:	0.325 W/kg
CONVERSION FACTORS:	0.312 / 0.312 / 0.312	SAR START:	0.264 W/kg
TYPE OF MODULATION:	GMSK (GSM Mode)	SAR END:	0.254 W/kg
MODN. DUTY CYCLE:	12.5%	SAR DRIFT DURING SCAN:	-3.64 %
DIODE COMPRESSION FACTORS (V*200):	20 / 20 / 20	PROBE BATTERY LAST CHANGED:	14/08/2006
INPUT POWER LEVEL:	5	EXTRAPOLATION:	poly4

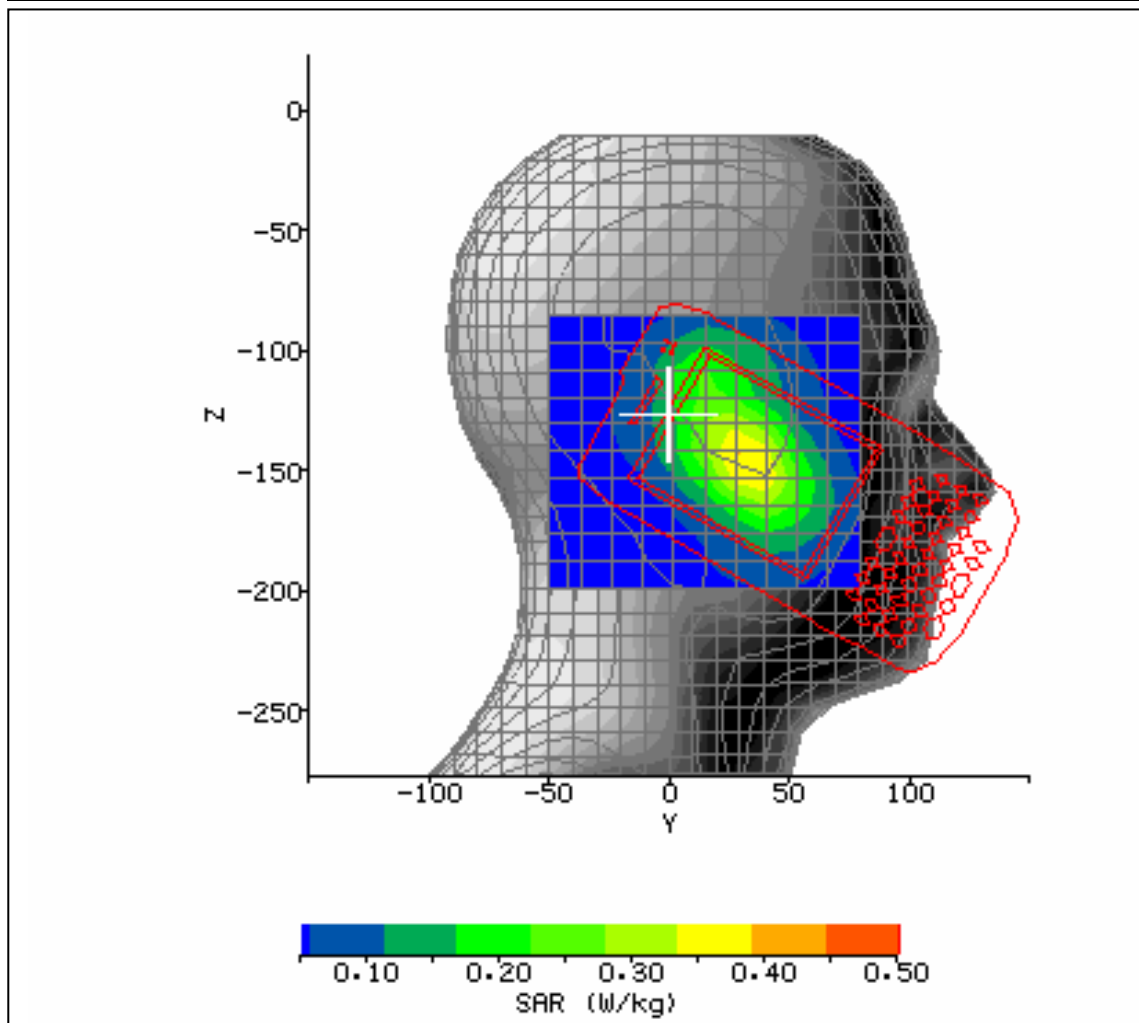

Figure 9: SAR Head Testing Results for the Intermec CN3 Mobile Computer in Right Hand Cheek Position; Tested at 836.4MHz (850MHz GSM Middle Channel).

2.3 850MHz GSM HEAD SAR TEST RESULT INCLUDING COURSE AREA SCAN – 2D

SYSTEM / SOFTWARE:	SARA2 / 2.39 VPM	INPUT POWER DRIFT:	0.0 dB
DATE / TIME:	15/08/2006 11:10:10	DUT BATTERY MODEL/NO:	318-016-002
FILENAME:	WS615435_F_04.txt	PROBE SERIAL NUMBER:	187
AMBIENT TEMPERATURE:	22.6°C	LIQUID SIMULANT:	835 Head
DEVICE UNDER TEST:	Intermec CN3	RELATIVE PERMITTIVITY:	42.54
RELATIVE HUMIDITY:	44.0%	CONDUCTIVITY:	0.919
PHANTOM S/NO:	Head_04_35.csv	LIQUID TEMPERATURE:	21.7°C
PHANTOM ROTATION:	180°	MAX SAR Y-AXIS LOCATION:	0.57 mm
DUT POSITION:	RH-Cheek 15°	MAX SAR Z-AXIS LOCATION:	-108.00 mm
ANTENNA CONFIGURATION:	Fixed Internal	MAX E FIELD:	16.39 V/m
TEST FREQUENCY:	836.4MHz	SAR 1g:	0.229 W/kg
AIR FACTORS:	345 / 442 / 414	SAR 10g:	0.145 W/kg
CONVERSION FACTORS:	0.312 / 0.312 / 0.312	SAR START:	0.103 W/kg
TYPE OF MODULATION:	GMSK (GSM mode)	SAR END:	0.103 W/kg
MODN. DUTY CYCLE:	12.5%	SAR DRIFT DURING SCAN:	0.11 %
DIODE COMPRESSION FACTORS (V*200):	20 / 20 / 20	PROBE BATTERY LAST CHANGED:	14/08/2006
INPUT POWER LEVEL:	5	EXTRAPOLATION:	poly4

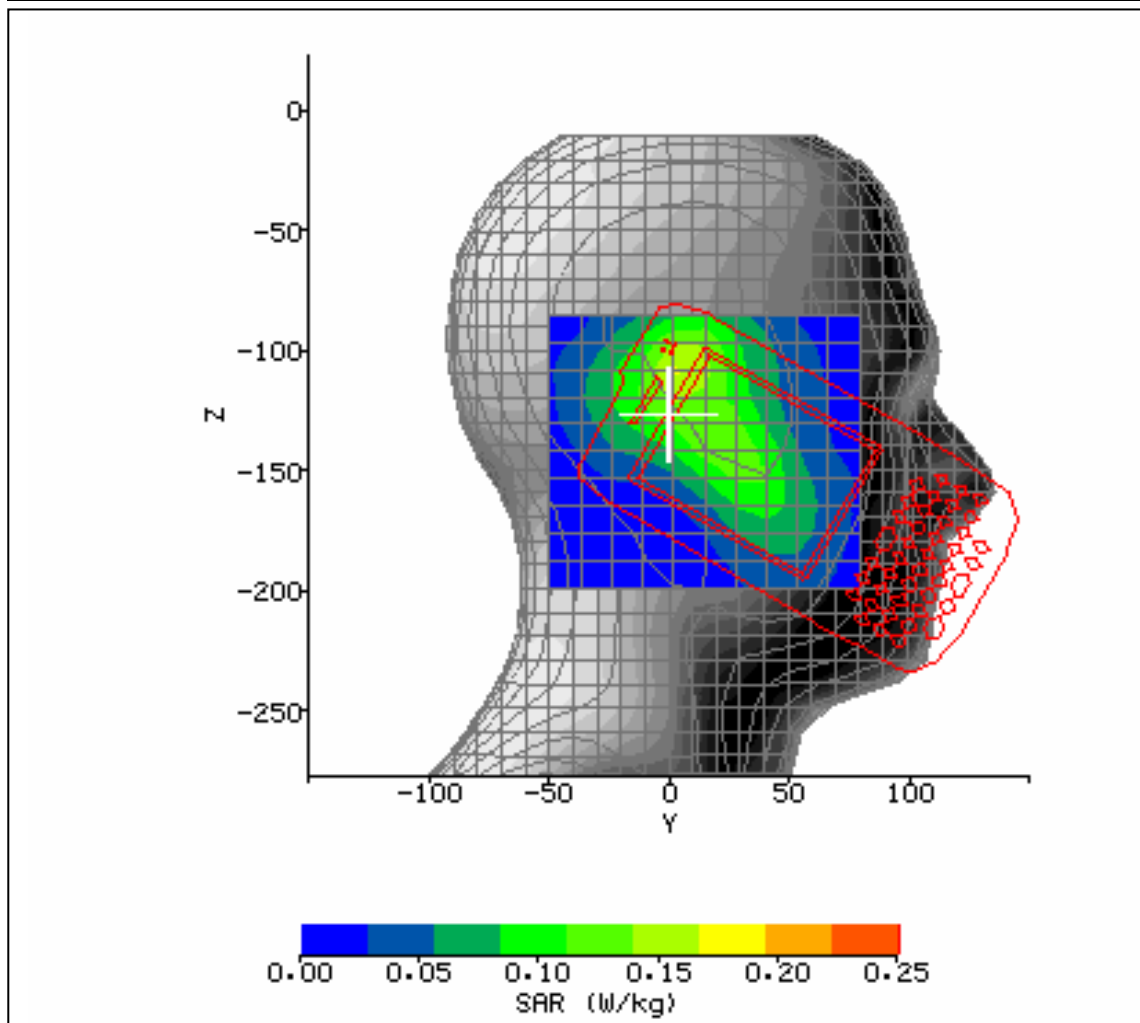

Figure 10: SAR Head Testing Results for the Intermec CN3 Mobile Computer in Right Hand 15° Cheek Position; Tested at 836.4MHz (850MHz GSM Middle Channel).

2.3 850MHz GSM HEAD SAR TEST RESULT INCLUDING COURSE AREA SCAN – 2D

SYSTEM / SOFTWARE:	SARA2 / 2.39 VPM	INPUT POWER DRIFT:	0.0 dB
DATE / TIME:	15/08/2006 13:29:36	DUT BATTERY MODEL/NO:	318-016-002
FILENAME:	WS615435_F_05.txt	PROBE SERIAL NUMBER:	187
AMBIENT TEMPERATURE:	22.3°C	LIQUID SIMULANT:	835 Head
DEVICE UNDER TEST:	Intermec CN3	RELATIVE PERMITTIVITY:	42.54
RELATIVE HUMIDITY:	52.00%	CONDUCTIVITY:	0.919
PHANTOM S/NO:	Head_04_35.csv	LIQUID TEMPERATURE:	21.5°C
PHANTOM ROTATION:	180°	MAX SAR Y-AXIS LOCATION:	33.20 mm
DUT POSITION:	RH-Cheek	MAX SAR Z-AXIS LOCATION:	-155.47 mm
ANTENNA CONFIGURATION:	Fixed Internal	MAX E FIELD:	20.13 V/m
TEST FREQUENCY:	824.2MHz	SAR 1g:	0.356 W/kg
AIR FACTORS:	345 / 442 / 414	SAR 10g:	0.249 W/kg
CONVERSION FACTORS:	0.312 / 0.312 / 0.312	SAR START:	0.192 W/kg
TYPE OF MODULATION:	GMSK (GSM mode)	SAR END:	0.192 W/kg
MODN. DUTY CYCLE:	12.5%	SAR DRIFT DURING SCAN:	-0.04 %
DIODE COMPRESSION FACTORS (V*200):	20 / 20 / 20	PROBE BATTERY LAST CHANGED:	14/08/2006
INPUT POWER LEVEL:	5	EXTRAPOLATION:	poly4

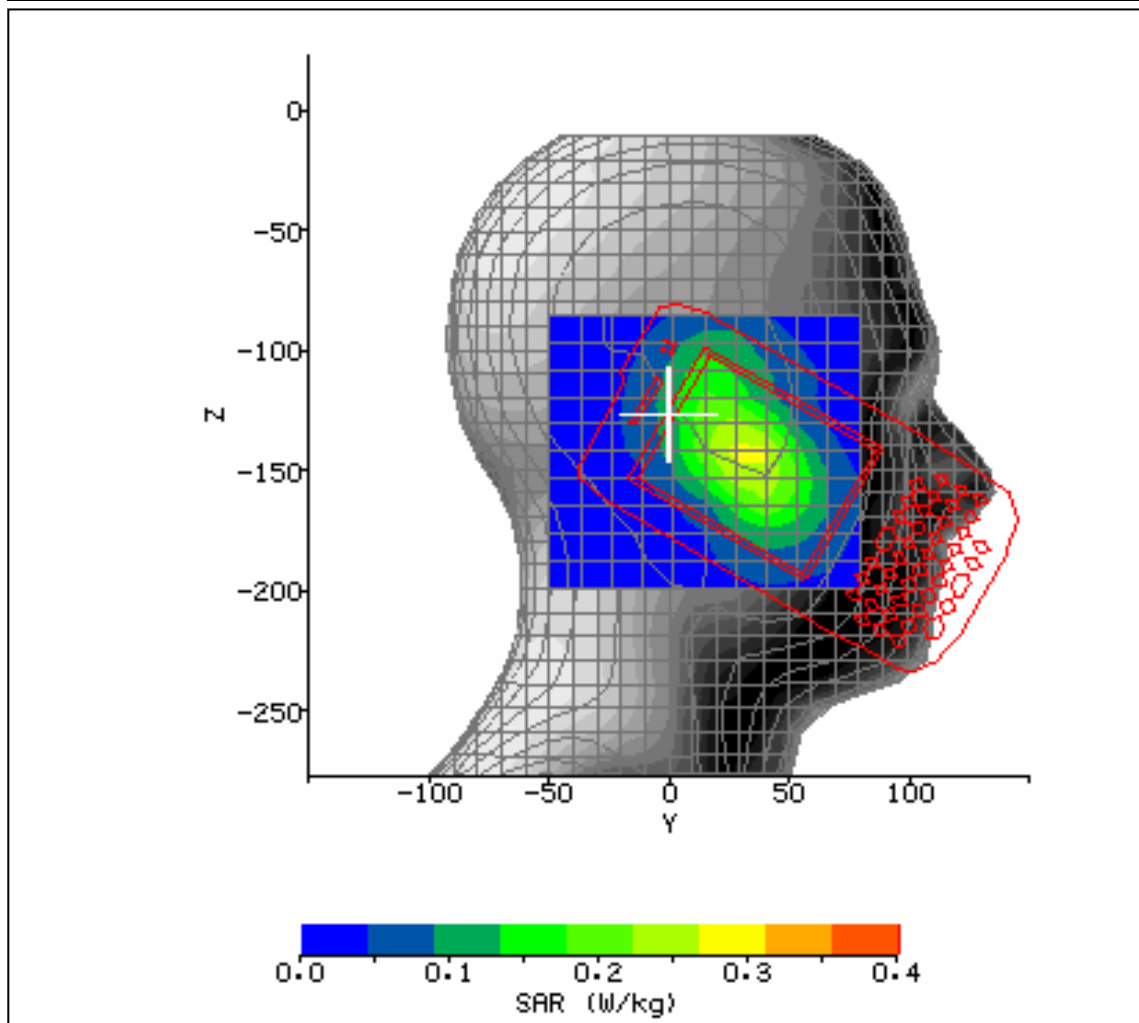

Figure 11: SAR Head Testing Results for the Intermec CN3 Mobile Computer in Right Hand 15° Cheek Position; Tested at 824.2MHz (850MHz GSM Low Channel).

2.3 850MHz GSM HEAD SAR TEST RESULT INCLUDING COURSE AREA SCAN – 2D

SYSTEM / SOFTWARE:	SARA2 / 2.39 VPM	INPUT POWER DRIFT:	0.0 dB
DATE / TIME:	15/08/2006 12:33:51	DUT BATTERY MODEL/NO:	318-016-002
FILENAME:	WS615435_F_06.txt	PROBE SERIAL NUMBER:	187
AMBIENT TEMPERATURE:	21.8°C	LIQUID SIMULANT:	835 Head
DEVICE UNDER TEST:	Intermec CN3	RELATIVE PERMITTIVITY:	42.54
RELATIVE HUMIDITY:	45.4%	CONDUCTIVITY:	0.919
PHANTOM S/NO:	Head_04_35.csv	LIQUID TEMPERATURE:	21.6°C
PHANTOM ROTATION:	180°	MAX SAR Y-AXIS LOCATION:	31.90 mm
DUT POSITION:	RH-Cheek	MAX SAR Z-AXIS LOCATION:	-155.47 mm
ANTENNA CONFIGURATION:	Fixed Internal	MAX E FIELD:	24.65 V/m
TEST FREQUENCY:	848.8MHz	SAR 1g:	0.528 W/kg
AIR FACTORS:	345 / 442 / 414	SAR 10g:	0.369 W/kg
CONVERSION FACTORS:	0.312 / 0.312 / 0.312	SAR START:	0.271 W/kg
TYPE OF MODULATION:	GMSK (GSM mode)	SAR END:	0.284 W/kg
MODN. DUTY CYCLE:	12.5%	SAR DRIFT DURING SCAN:	4.74 %
DIODE COMPRESSION FACTORS (V*200):	20 / 20 / 20	PROBE BATTERY LAST CHANGED:	14/08/2006
INPUT POWER LEVEL:	5	EXTRAPOLATION:	poly4

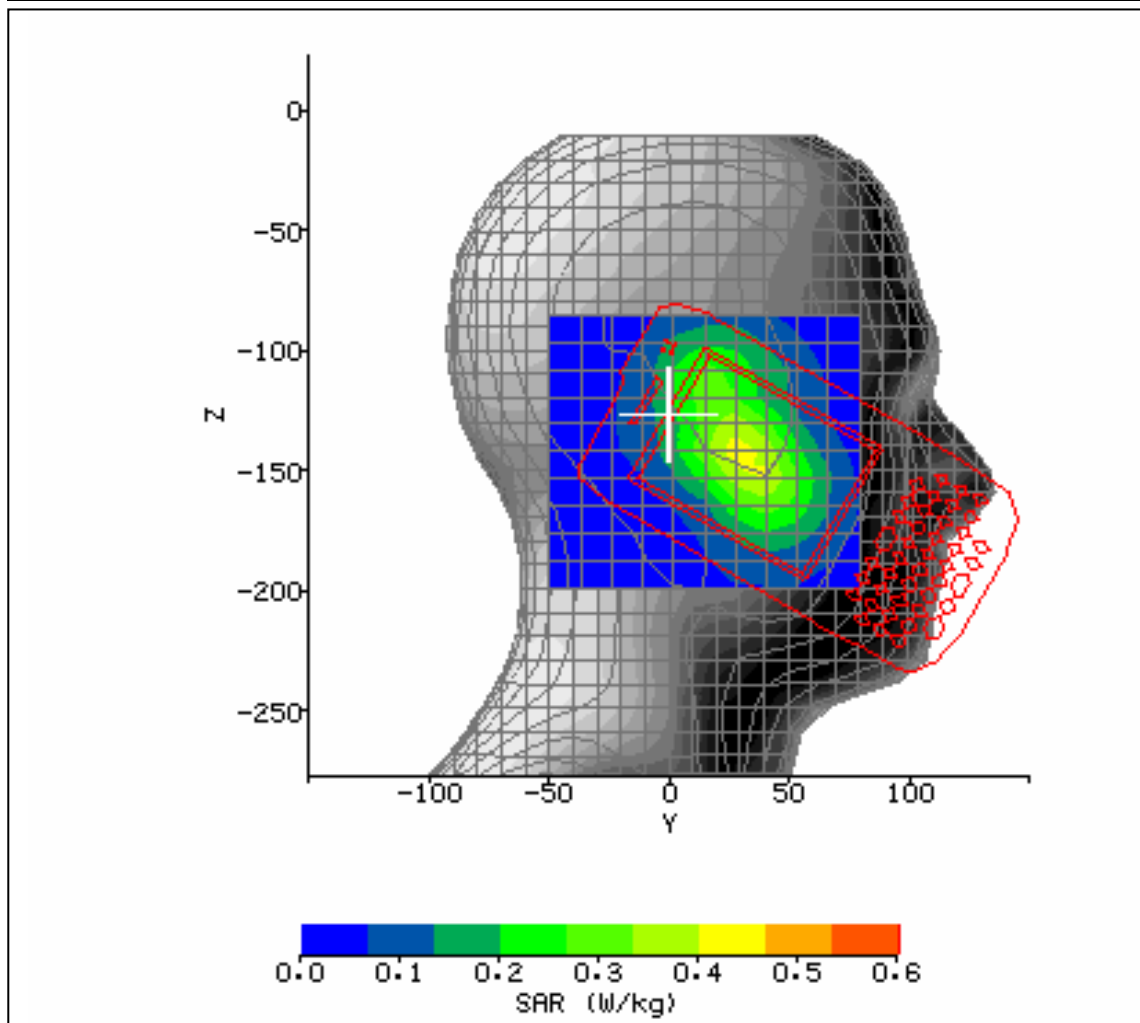

Figure 12: SAR Head Testing Results for the Intermec CN3 Mobile Computer in Right Hand 15° Cheek Position; Tested at 848.8MHz (850MHz GSM High Channel).

2.3.1 850MHz GPRS BODY SAR TEST RESULT INCLUDING COURSE AREA SCAN – 2D

SYSTEM / SOFTWARE:	SARA2 / 2.39 VPM	INPUT POWER DRIFT:	0.0 dB
DATE / TIME:	16/08/2006 10:23:15	DUT BATTERY MODEL/NO:	318-016-002
FILENAME:	WS615435_F_25.txt	PROBE SERIAL NUMBER:	187
AMBIENT TEMPERATURE:	22.1°C	LIQUID SIMULANT:	835 Body
DEVICE UNDER TEST:	Intermec CN3	RELATIVE PERMITTIVITY:	56.86
RELATIVE HUMIDITY:	58.3%	CONDUCTIVITY:	0.967
PHANTOM S/NO:	HeadBox02.csv	LIQUID TEMPERATURE:	20.8°C
PHANTOM ROTATION:	0°	MAX SAR X-AXIS LOCATION:	32.00 mm
DUT POSITION:	Front facing 15mm spacing	MAX SAR Y-AXIS LOCATION:	5.00 mm
ANTENNA CONFIGURATION:	Fixed Internal	MAX E FIELD:	11.35 V/m
TEST FREQUENCY:	836.4MHz	SAR 1g:	0.140 W/kg
AIR FACTORS:	345 / 442 / 414	SAR 10g:	0.106 W/kg
CONVERSION FACTORS:	0.307 / 0.307 / 0.307	SAR START:	0.054 W/kg
TYPE OF MODULATION:	GMSK (GPRS mode)	SAR END:	0.053 W/kg
MODN. DUTY CYCLE:	50%	SAR DRIFT DURING SCAN:	-2.54 %
DIODE COMPRESSION FACTORS (V*200):	20 / 20 / 20	PROBE BATTERY LAST CHANGED:	16/08/2006
INPUT POWER LEVEL:	4x 33dBm	EXTRAPOLATION:	poly4

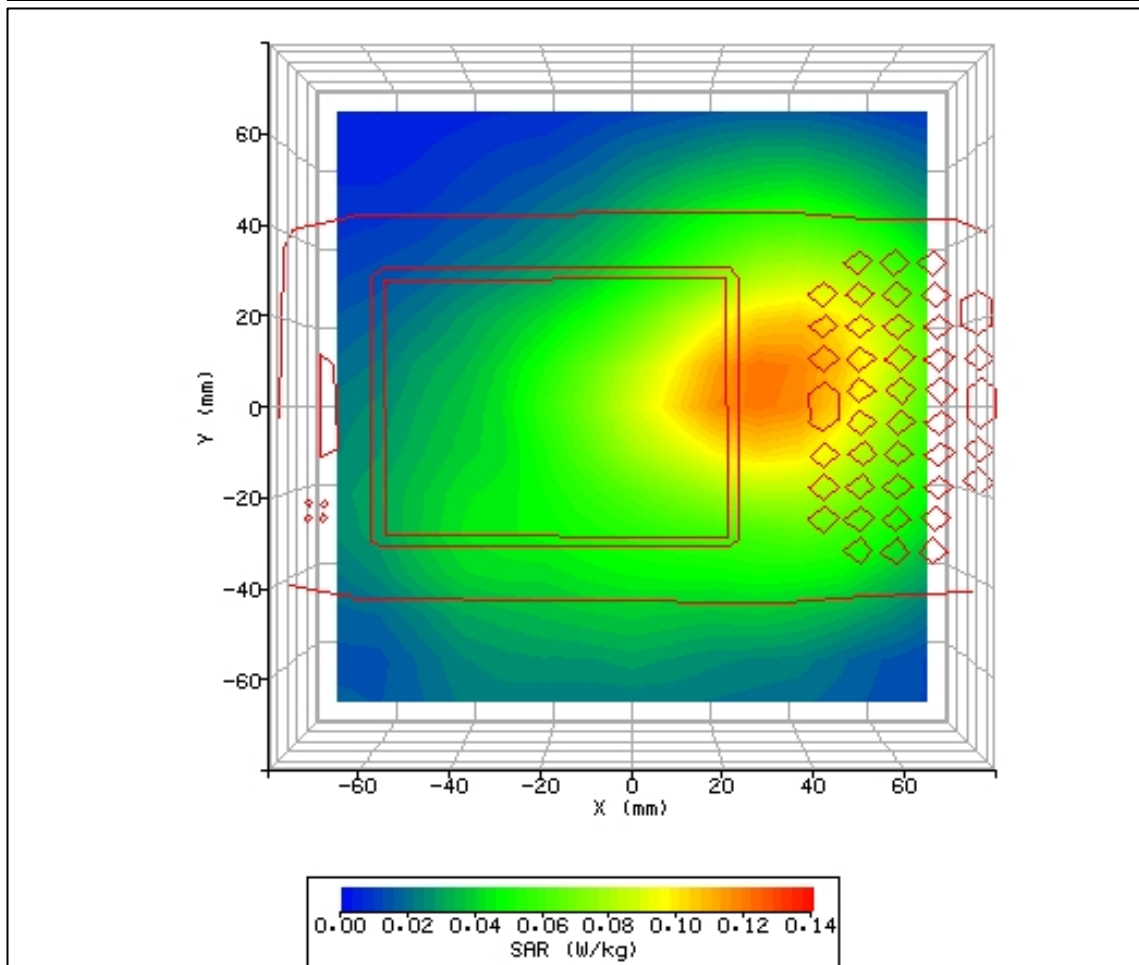

Figure 13: SAR Body GPRS Testing Results for the Intermec CN3 Mobile Computer in Front Facing Phantom Position; Tested at 836.4MHz (850MHz GSM Middle Channel) with 15.0mm Separation.

2.3.1 850MHz GPRS BODY SAR TEST RESULT INCLUDING COURSE AREA SCAN – 2D

SYSTEM / SOFTWARE:	SARA2 / 2.39 VPM	INPUT POWER DRIFT:	0.0 dB
DATE / TIME:	16/08/2006 10:56:16	DUT BATTERY MODEL/NO:	318-016-002
FILENAME:	WS615435_F_26.txt	PROBE SERIAL NUMBER:	187
AMBIENT TEMPERATURE:	22.5°C	LIQUID SIMULANT:	835 Body
DEVICE UNDER TEST:	Intermec CN3	RELATIVE PERMITTIVITY:	56.86
RELATIVE HUMIDITY:	55.8%	CONDUCTIVITY:	0.967
PHANTOM S/NO:	HeadBox02.csv	LIQUID TEMPERATURE:	20.8°C
PHANTOM ROTATION:	0°	MAX SAR X-AXIS LOCATION:	-6.00 mm
DUT POSITION:	Rear facing 15mm spacing	MAX SAR Y-AXIS LOCATION:	-25.00 mm
ANTENNA CONFIGURATION:	Fixed Internal	MAX E FIELD:	11.93 V/m
TEST FREQUENCY:	836.4MHz	SAR 1g:	0.159 W/kg
AIR FACTORS:	345 / 442 / 414	SAR 10g:	0.113 W/kg
CONVERSION FACTORS:	0.307 / 0.307 / 0.307	SAR START:	0.049 W/kg
TYPE OF MODULATION:	GMSk (GPRS mode)	SAR END:	0.050 W/kg
MODN. DUTY CYCLE:	50%	SAR DRIFT DURING SCAN:	0.73 %
DIODE COMPRESSION FACTORS (V*200):	20 / 20 / 20	PROBE BATTERY LAST CHANGED:	16/08/2006
INPUT POWER LEVEL:	4x 33dBm	EXTRAPOLATION:	poly4

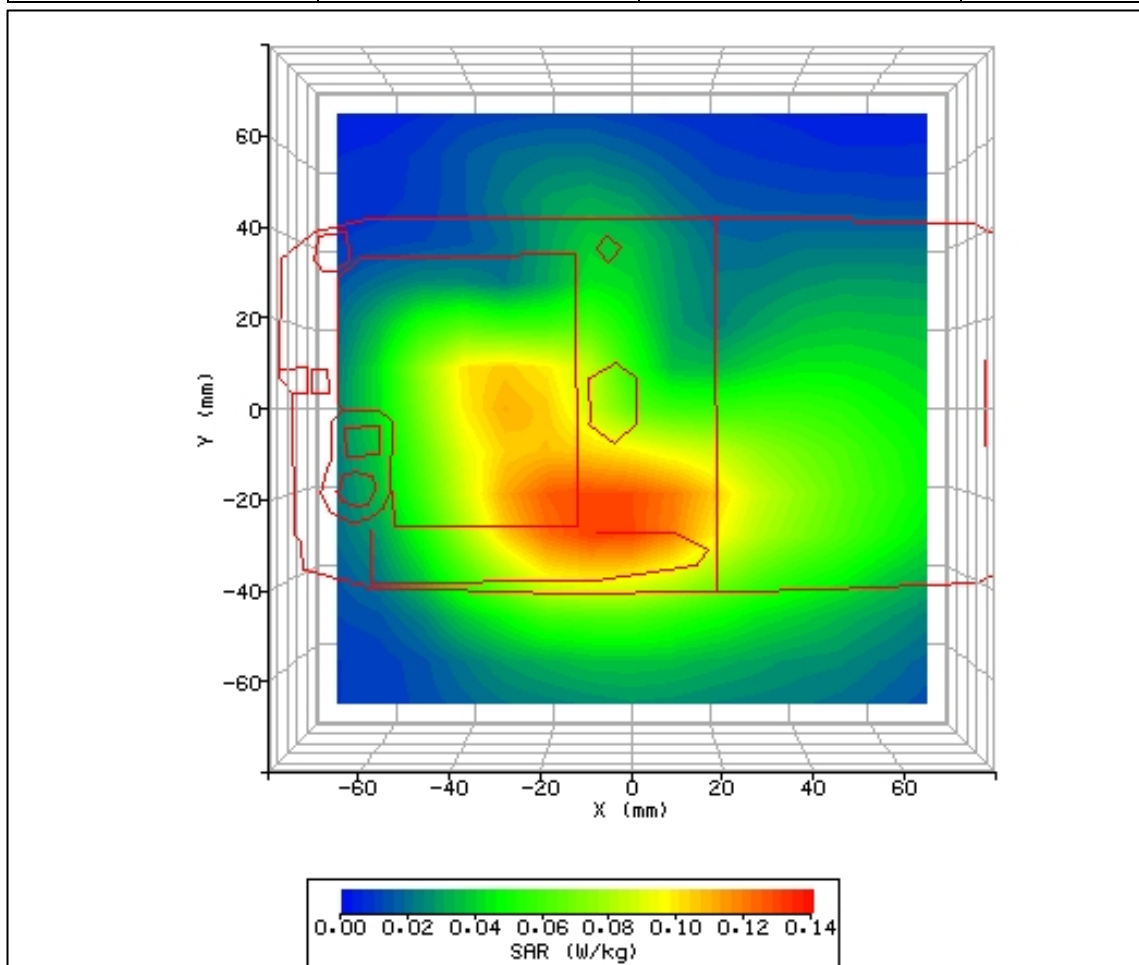

Figure 14: SAR Body GPRSTesting Results for the Intermec CN3 Mobile Computer in Rear Facing Phantom Position; Tested at 836.4MHz (850MHz GSM Middle Channel) with 15.0mm Separation.

2.3.1 850MHz GPRS BODY SAR TEST RESULT INCLUDING COURSE AREA SCAN – 2D

SYSTEM / SOFTWARE:	SARA2 / 2.39 VPM	INPUT POWER DRIFT:	0.0 dB
DATE / TIME:	16/08/2006 11:25:07	DUT BATTERY MODEL/NO:	318-016-002
FILENAME:	WS615435_F_27.txt	PROBE SERIAL NUMBER:	187
AMBIENT TEMPERATURE:	22.6°C	LIQUID SIMULANT:	835 Body
DEVICE UNDER TEST:	Intermec CN3	RELATIVE PERMITTIVITY:	56.86
RELATIVE HUMIDITY:	54.3%	CONDUCTIVITY:	0.967
PHANTOM S/NO:	HeadBox02.csv	LIQUID TEMPERATURE:	20.7°C
PHANTOM ROTATION:	0°	MAX SAR X-AXIS LOCATION:	-7.00 mm
DUT POSITION:	Rear facing 15mm spacing	MAX SAR Y-AXIS LOCATION:	-24.00 mm
ANTENNA CONFIGURATION:	Fixed Internal	MAX E FIELD:	10.58 V/m
TEST FREQUENCY:	824.2MHz	SAR 1g:	0.126 W/kg
AIR FACTORS:	345 / 442 / 414	SAR 10g:	0.090 W/kg
CONVERSION FACTORS:	0.307 / 0.307 / 0.307	SAR START:	0.040 W/kg
TYPE OF MODULATION:	GMSK (GPRS mode)	SAR END:	0.040 W/kg
MODN. DUTY CYCLE:	50%	SAR DRIFT DURING SCAN:	0.00 %
DIODE COMPRESSION FACTORS (V*200):	20 / 20 / 20	PROBE BATTERY LAST CHANGED:	16/08/2006
INPUT POWER LEVEL:	4x 33dBm	EXTRAPOLATION:	poly4

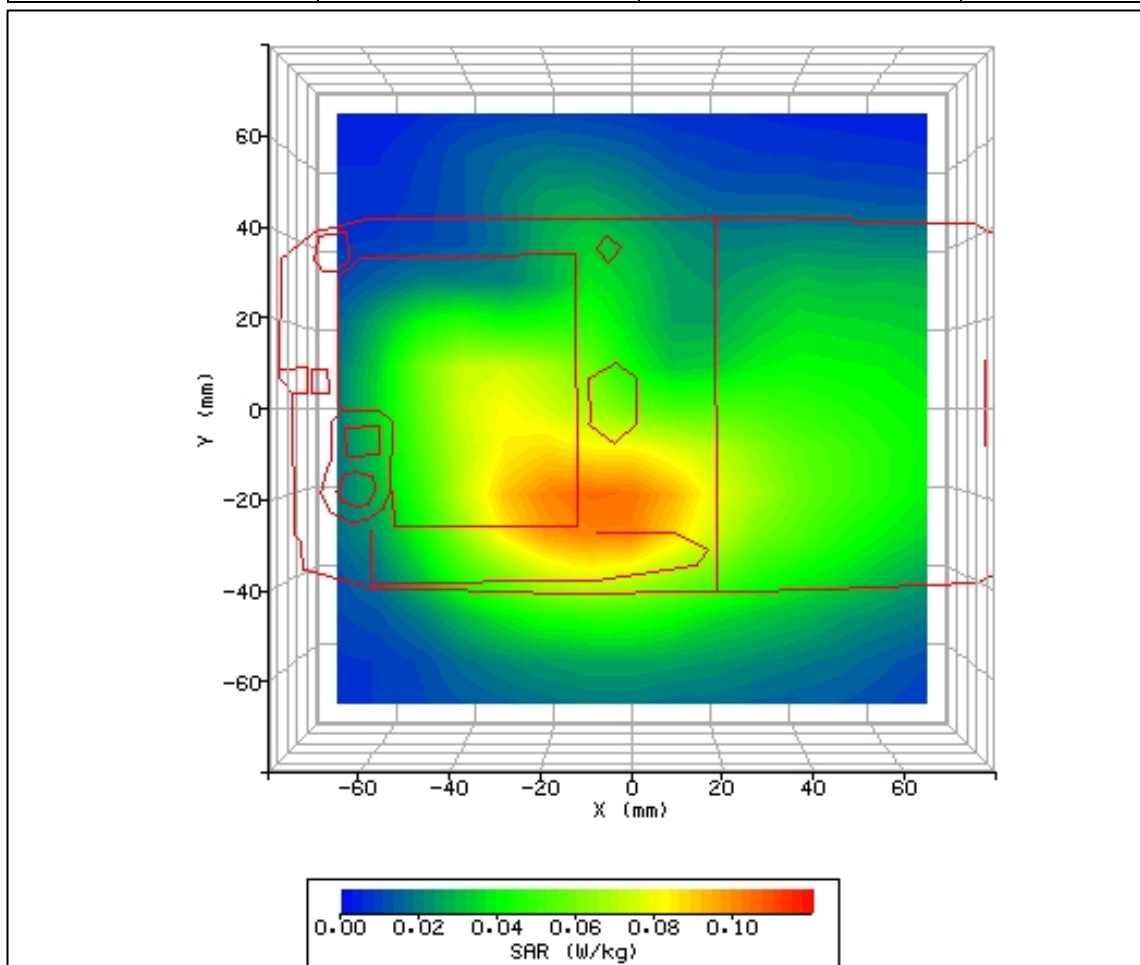

Figure 15: SAR Body GPRS Testing Results for the Intermec CN3 Mobile Computer in Rear Facing Phantom Position; Tested at 824.4MHz (850MHz GSM Bottom Channel) with 15.0mm Separation.

2.3.1 850MHz GPRS BODY SAR TEST RESULT INCLUDING COURSE AREA SCAN – 2D

SYSTEM / SOFTWARE:	SARA2 / 2.39 VPM	INPUT POWER DRIFT:	0.0 dB
DATE / TIME:	16/08/2006 11:58:43	DUT BATTERY MODEL/NO:	318-016-002
FILENAME:	WS615435_F_28.txt	PROBE SERIAL NUMBER:	187
AMBIENT TEMPERATURE:	22.6°C	LIQUID SIMULANT:	835 Body
DEVICE UNDER TEST:	Intermec CN3	RELATIVE PERMITTIVITY:	56.86
RELATIVE HUMIDITY:	53.1%	CONDUCTIVITY:	0.967
PHANTOM S/NO:	HeadBox02.csv	LIQUID TEMPERATURE:	20.7°C
PHANTOM ROTATION:	0°	MAX SAR X-AXIS LOCATION:	-9.00 mm
DUT POSITION:	Rear facing 15mm spacing	MAX SAR Y-AXIS LOCATION:	-25.00 mm
ANTENNA CONFIGURATION:	Fixed Internal	MAX E FIELD:	13.58 V/m
TEST FREQUENCY:	848.8MHz	SAR 1g:	0.203 W/kg
AIR FACTORS:	345 / 442 / 414	SAR 10g:	0.145 W/kg
CONVERSION FACTORS:	0.307 / 0.307 / 0.307	SAR START:	0.064 W/kg
TYPE OF MODULATION:	GMSK (GPRS mode)	SAR END:	0.064 W/kg
MODN. DUTY CYCLE:	50%	SAR DRIFT DURING SCAN:	0.47 %
DIODE COMPRESSION FACTORS (V*200):	20 / 20 / 20	PROBE BATTERY LAST CHANGED:	16/08/2006
INPUT POWER LEVEL:	4x 33dBm	EXTRAPOLATION:	poly4

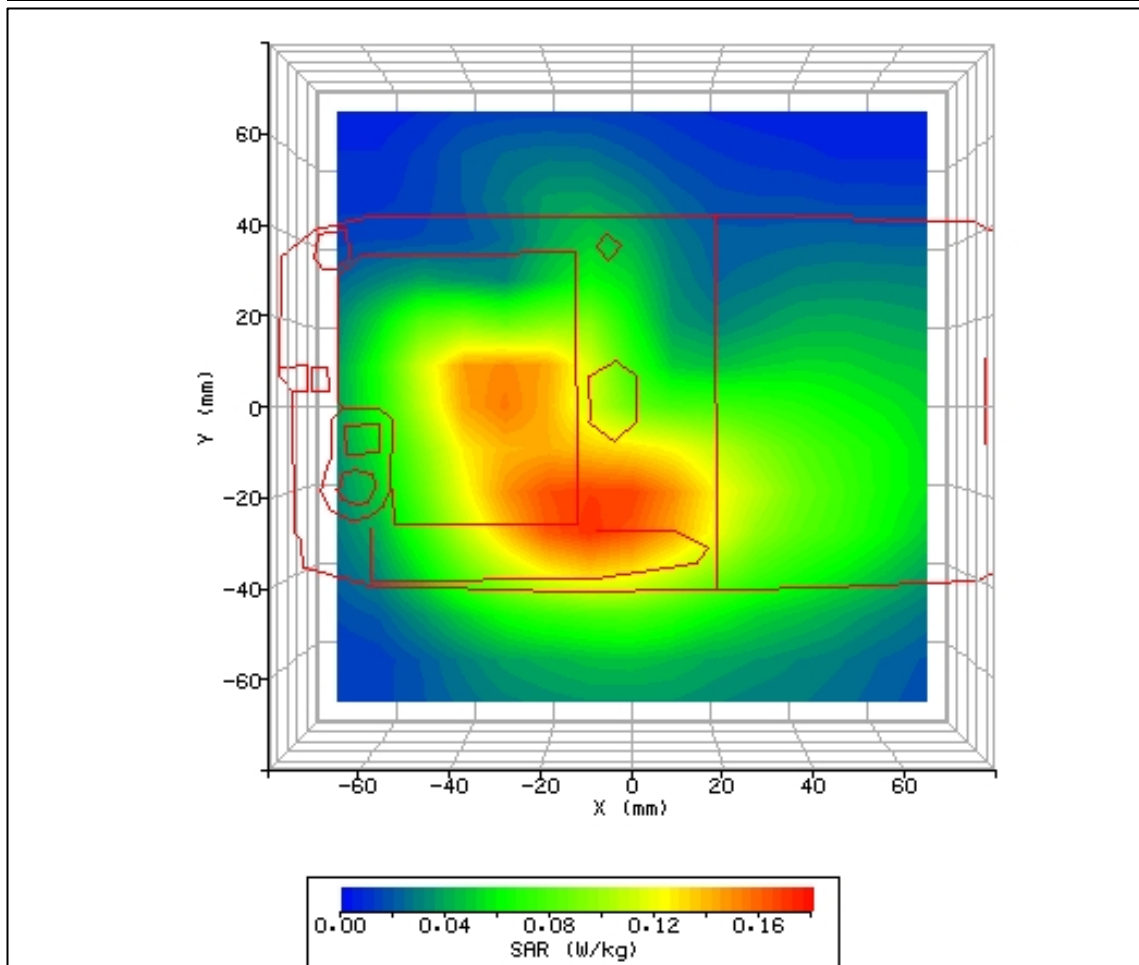

Figure 16: SAR Body GPRS Testing Results for the Intermec CN3 Mobile Computer in Rear Facing Phantom Position; Tested at 848.8MHz (850MHz GSM Top Channel) with 15.0mm Separation..

2.3.2 850MHz EGPRS BODY SAR TEST RESULT INCLUDING COURSE AREA SCAN – 2D

SYSTEM / SOFTWARE:	SARA2 / 2.39 VPM	INPUT POWER DRIFT:	0.0 dB
DATE / TIME:	16/08/2006 14:34:21	DUT BATTERY MODEL/NO:	318-016-002
FILENAME:	WS615435_F_29.txt	PROBE SERIAL NUMBER:	187
AMBIENT TEMPERATURE:	21.7°C	LIQUID SIMULANT:	835 Body
DEVICE UNDER TEST:	Intermec CN3	RELATIVE PERMITTIVITY:	56.86
RELATIVE HUMIDITY:	45.2%	CONDUCTIVITY:	0.967
PHANTOM S/NO:	HeadBox02.csv	LIQUID TEMPERATURE:	20.6°C
PHANTOM ROTATION:	0°	MAX SAR X-AXIS LOCATION:	-11.00 mm
DUT POSITION:	Rear facing 15mm spacing	MAX SAR Y-AXIS LOCATION:	-20.00 mm
ANTENNA CONFIGURATION:	Fixed Internal	MAX E FIELD:	8.79 V/m
TEST FREQUENCY:	848.8MHz	SAR 1g:	0.085 W/kg
AIR FACTORS:	345 / 442 / 414	SAR 10g:	0.060 W/kg
CONVERSION FACTORS:	0.307 / 0.307 / 0.307	SAR START:	0.025 W/kg
TYPE OF MODULATION:	8PSK (EGPRS mode)	SAR END:	0.025 W/kg
MODN. DUTY CYCLE:	25%	SAR DRIFT DURING SCAN:	-0.26 %
DIODE COMPRESSION FACTORS (V*200):	20 / 20 / 20	PROBE BATTERY LAST CHANGED:	16/08/2006
INPUT POWER LEVEL:	2x 27dBm	EXTRAPOLATION:	poly4

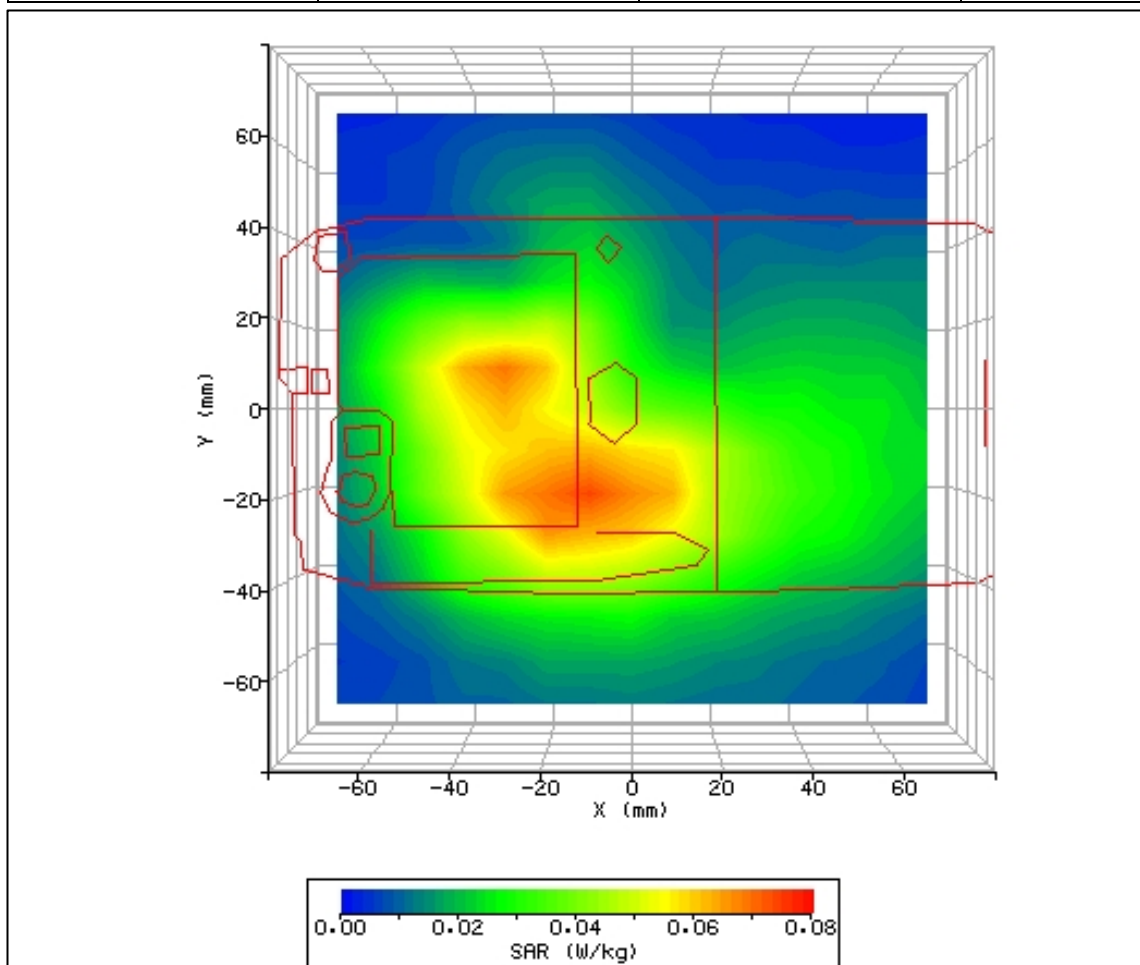

Figure 17: SAR Body EGPRS Testing Results for the Intermec CN3 Mobile Computer in Rear Facing Phantom Position; Tested at 848.8MHz (850MHz GSM Top Channel) with 15.0mm Separation.

2.3.3 850MHz GPRS BODY HOLSTER SAR TEST RESULT INCLUDING COURSE AREA SCAN – 2D

SYSTEM / SOFTWARE:	SARA2 / 2.39 VPM	INPUT POWER DRIFT:	0.0 dB
DATE / TIME:	16/08/2006 15:04:26	DUT BATTERY MODEL/NO:	318-016-002
FILENAME:	WS615435_F_30.txt	PROBE SERIAL NUMBER:	187
AMBIENT TEMPERATURE:	21.7°C	LIQUID SIMULANT:	835 Body
DEVICE UNDER TEST:	Intermec CN3	RELATIVE PERMITTIVITY:	56.86
RELATIVE HUMIDITY:	48.3%	CONDUCTIVITY:	0.967
PHANTOM S/NO:	HeadBox02.csv	LIQUID TEMPERATURE:	20.6°C
PHANTOM ROTATION:	0°	MAX SAR X-AXIS LOCATION:	14.00 mm
DUT POSITION:	Rear in holster 0mm spacing	MAX SAR Y-AXIS LOCATION:	-8.00 mm
ANTENNA CONFIGURATION:	Fixed Internal	MAX E FIELD:	15.69 V/m
TEST FREQUENCY:	848.8MHz	SAR 1g:	0.271 W/kg
AIR FACTORS:	345 / 442 / 414	SAR 10g:	0.190 W/kg
CONVERSION FACTORS:	0.307 / 0.307 / 0.307	SAR START:	0.087 W/kg
TYPE OF MODULATION:	GMSK (GPRS mode)	SAR END:	0.089 W/kg
MODN. DUTY CYCLE:	50%	SAR DRIFT DURING SCAN:	2.27 %
DIODE COMPRESSION FACTORS (V*200):	20 / 20 / 20	PROBE BATTERY LAST CHANGED:	16/08/2006
INPUT POWER LEVEL:	4x 33dBm	EXTRAPOLATION:	poly4

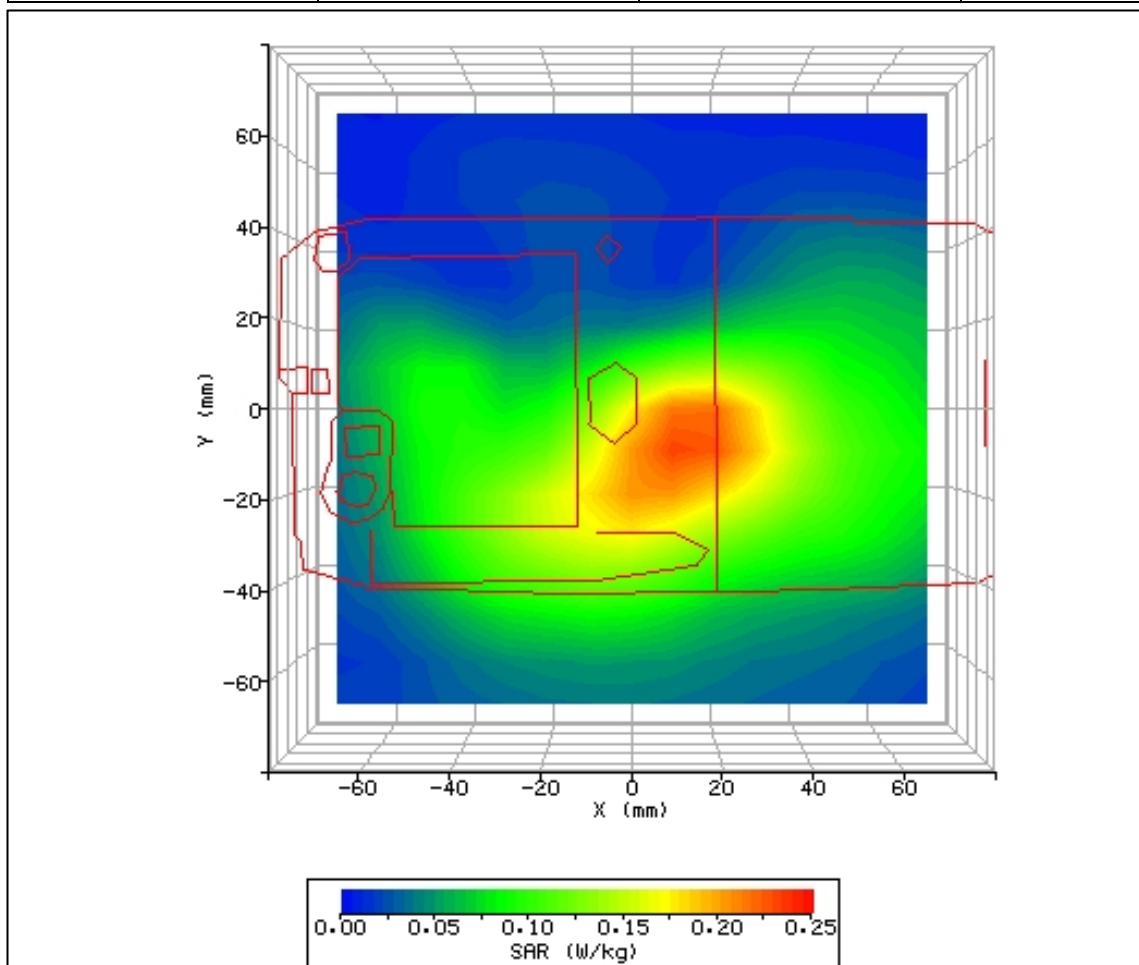

Figure 18: SAR Body GPRS Testing Results for the Intermec CN3 Mobile Computer in Rear Facing Phantom Positioned in belt-clip holster; Tested at 848.8MHz (850MHz GSM Top Channel) with 0.0mm Separation.

2.4 1900MHz GSM HEAD SAR TEST RESULT INCLUDING COURSE AREA SCAN – 2D

SYSTEM / SOFTWARE:	SARA2 / 2.39 VPM	INPUT POWER DRIFT:	0.0 dB
DATE / TIME:	16/08/2006 16:41:25	DUT BATTERY MODEL/NO:	318-016-002
FILENAME:	WS615435_F_07.txt	PROBE SERIAL NUMBER:	0187
AMBIENT TEMPERATURE:	22.9°C	LIQUID SIMULANT:	1900 Head
DEVICE UNDER TEST:	Intermec CN3	RELATIVE PERMITTIVITY:	39.83
RELATIVE HUMIDITY:	46.2%	CONDUCTIVITY:	1.431
PHANTOM S/NO:	HeadFT04.csv	LIQUID TEMPERATURE:	21.8°C
PHANTOM ROTATION:	0°	MAX SAR Y-AXIS LOCATION:	-8.50 mm
DUT POSITION:	LH-Cheek	MAX SAR Z-AXIS LOCATION:	-122.95 mm
ANTENNA CONFIGURATION:	Fixed Internal	MAX E FIELD:	5.32 V/m
TEST FREQUENCY:	1880.0MHz	SAR 1g:	0.038 W/kg
AIR FACTORS:	345 / 442 / 414	SAR 10g:	0.023 W/kg
CONVERSION FACTORS:	0.382 / 0.382 / 0.382	SAR START:	0.015 W/kg
TYPE OF MODULATION:	GMSK (GSM mode)	SAR END:	0.014 W/kg
MODN. DUTY CYCLE:	12.5%	SAR DRIFT DURING SCAN:	0.00 %
DIODE COMPRESSION FACTORS (V*200):	20 / 20 / 20	PROBE BATTERY LAST CHANGED:	16/08/06
INPUT POWER LEVEL:	5	EXTRAPOLATION:	poly4

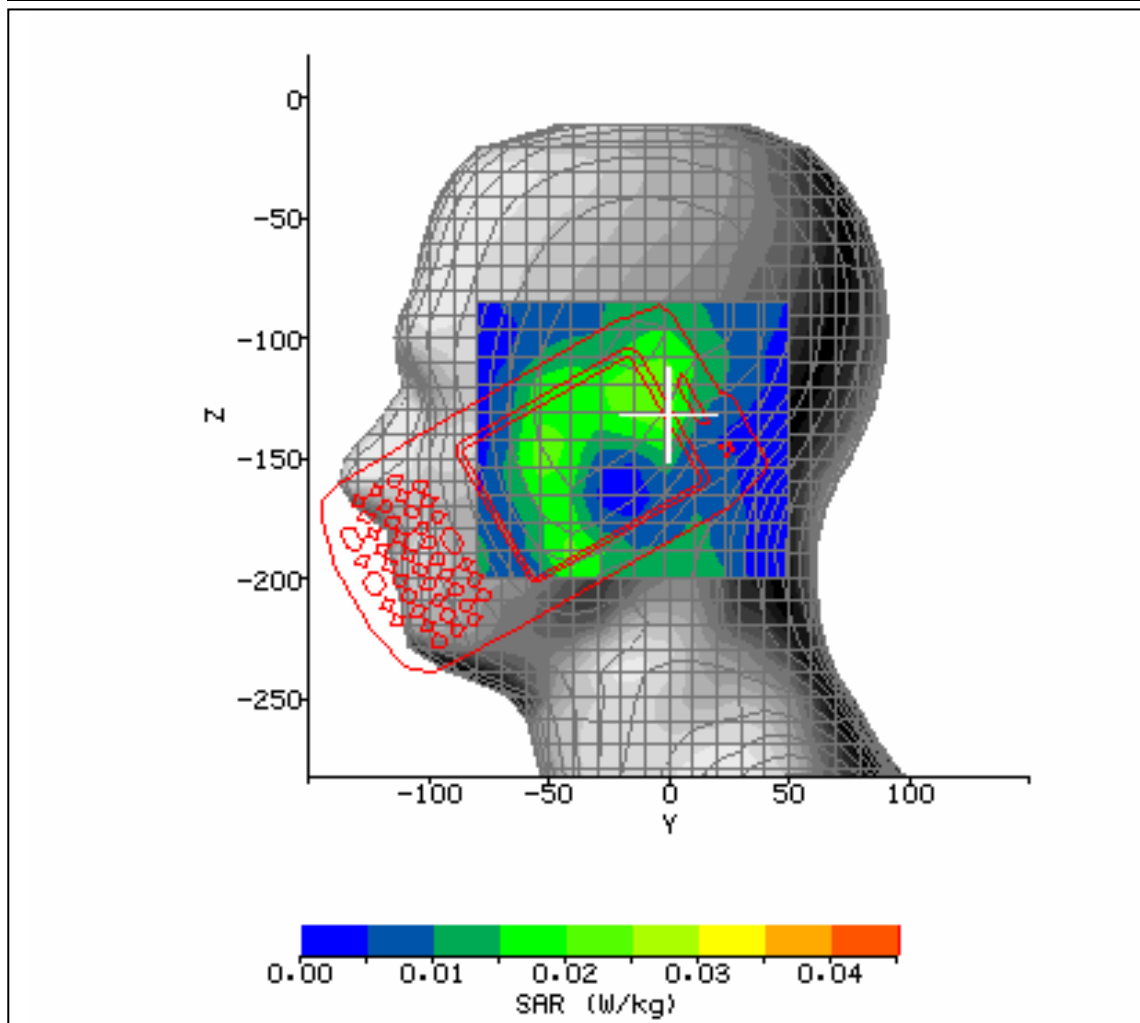

Figure 19: SAR Head Testing Results for the Intermec CN3 Mobile Computer in Left Hand Cheek Position; Tested at 1880.0MHz (1900MHz PCS Middle Channel).

2.4 1900MHz GSM HEAD SAR TEST RESULT INCLUDING COURSE AREA SCAN – 2D

SYSTEM / SOFTWARE:	SARA2 / 2.39 VPM	INPUT POWER DRIFT:	0.0 dB
DATE / TIME:	16/08/2006 17:08:45	DUT BATTERY MODEL/NO:	318-016-002
FILENAME:	WS615435_F_08.txt	PROBE SERIAL NUMBER:	0187
AMBIENT TEMPERATURE:	22.8°C	LIQUID SIMULANT:	1900 Head
DEVICE UNDER TEST:	Intermec CN3	RELATIVE PERMITTIVITY:	39.83
RELATIVE HUMIDITY:	46.4%	CONDUCTIVITY:	1.431
PHANTOM S/NO:	HeadFT04.csv	LIQUID TEMPERATURE:	21.8°C
PHANTOM ROTATION:	0°	MAX SAR Y-AXIS LOCATION:	-0.70 mm
DUT POSITION:	LH-Cheek15°	MAX SAR Z-AXIS LOCATION:	-116.05 mm
ANTENNA CONFIGURATION:	Fixed Internal	MAX E FIELD:	5.66 V/m
TEST FREQUENCY:	1880.0MHz	SAR 1g:	0.039 W/kg
AIR FACTORS:	345 / 442 / 414	SAR 10g:	0.024 W/kg
CONVERSION FACTORS:	0.382 / 0.382 / 0.382	SAR START:	0.017 W/kg
TYPE OF MODULATION:	GMSK (GSM mode)	SAR END:	0.017 W/kg
MODN. DUTY CYCLE:	12.5%	SAR DRIFT DURING SCAN:	1.26 %
DIODE COMPRESSION FACTORS (V*200):	20 / 20 / 20	PROBE BATTERY LAST CHANGED:	14/08/06
INPUT POWER LEVEL:	0	EXTRAPOLATION:	poly4

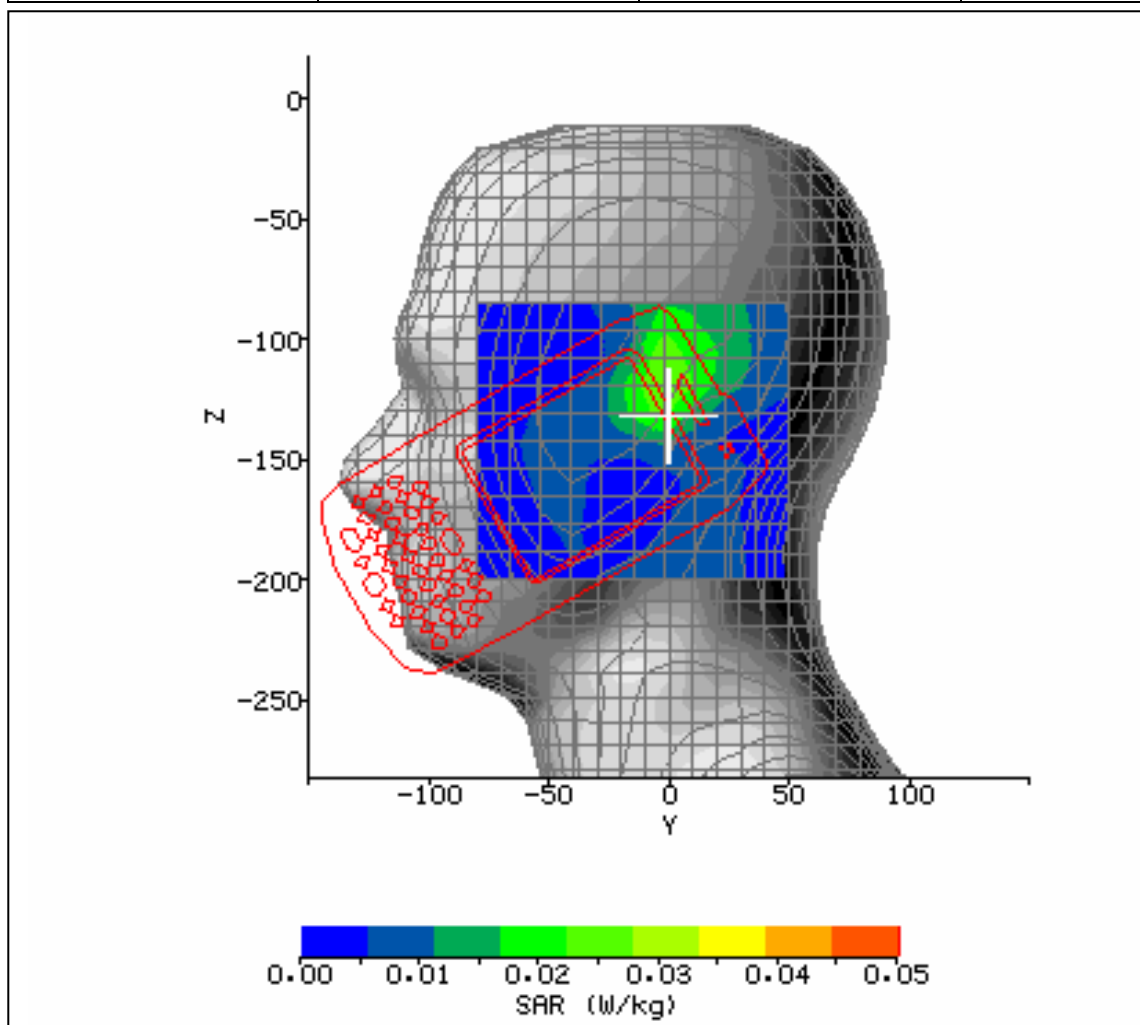

Figure 20 SAR Head Testing Results for the Intermec CN3 Mobile Computer in Left Hand Cheek 15° Position; Tested at 1880.0MHz (1900MHz PCS Middle Channel).

2.4 1900MHz GSM HEAD SAR TEST RESULT INCLUDING COURSE AREA SCAN – 2D

SYSTEM / SOFTWARE:	SARA2 / 2.39 VPM	INPUT POWER DRIFT:	0.0 dB
DATE / TIME:	16/08/2006 17:43:29	DUT BATTERY MODEL/NO:	318-016-002
FILENAME:	WS615435_F_09.txt	PROBE SERIAL NUMBER:	0187
AMBIENT TEMPERATURE:	22.6°C	LIQUID SIMULANT:	1900 Head
DEVICE UNDER TEST:	Intermec CN3	RELATIVE PERMITTIVITY:	39.83
RELATIVE HUMIDITY:	52.6%	CONDUCTIVITY:	1.431
PHANTOM S/NO:	HeadFT04.csv	LIQUID TEMPERATURE:	21.3°C
PHANTOM ROTATION:	180°	MAX SAR Y-AXIS LOCATION:	3.30 mm
DUT POSITION:	RH-Cheek	MAX SAR Z-AXIS LOCATION:	-122.95 mm
ANTENNA CONFIGURATION:	Fixed Internal	MAX E FIELD:	6.04 V/m
TEST FREQUENCY:	1880.0MHz	SAR 1g:	0.048 W/kg
AIR FACTORS:	345 / 442 / 414	SAR 10g:	0.030 W/kg
CONVERSION FACTORS:	0.382 / 0.382 / 0.382	SAR START:	0.022 W/kg
TYPE OF MODULATION:	GMSK (GSM mode)	SAR END:	0.022 W/kg
MODN. DUTY CYCLE:	12.5%	SAR DRIFT DURING SCAN:	1.89 %
DIODE COMPRESSION FACTORS (V*200):	20 / 20 / 20	PROBE BATTERY LAST CHANGED:	16/08/06
INPUT POWER LEVEL:	0	EXTRAPOLATION:	poly4

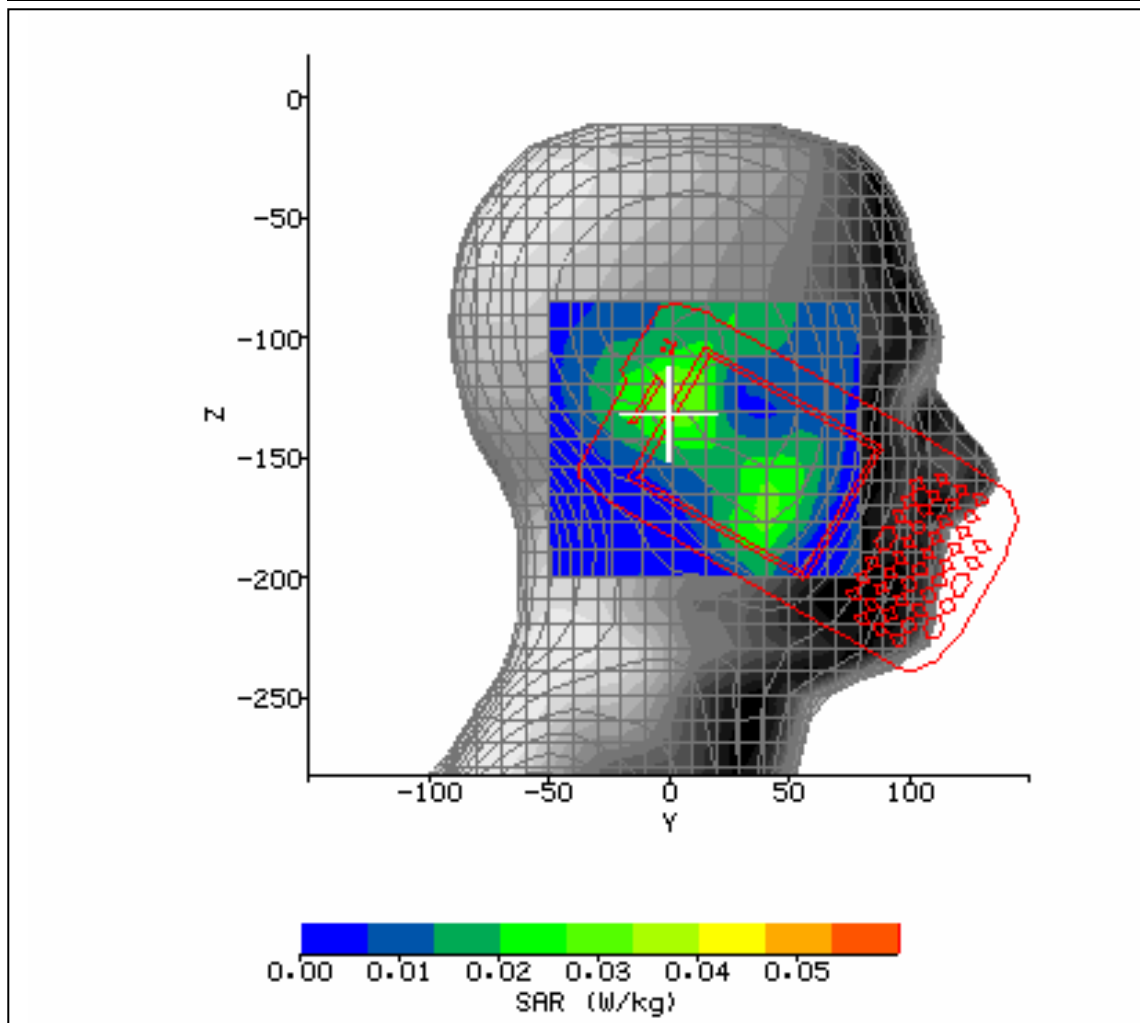

Figure 21: SAR Head Testing Results for the Intermec CN3 Mobile Computer in Right Hand Cheek Position; Tested at 1880.0MHz (1900MHz PCS Middle Channel).

2.4 1900MHz GSM HEAD SAR TEST RESULT INCLUDING COURSE AREA SCAN – 2D

SYSTEM / SOFTWARE:	SARA2 / 2.39 VPM	INPUT POWER DRIFT:	0.0 dB
DATE / TIME:	16/08/2006 17:43:29	DUT BATTERY MODEL/NO:	318-016-002
FILENAME:	WS615435_F_10.txt	PROBE SERIAL NUMBER:	0187
AMBIENT TEMPERATURE:	22.5°C	LIQUID SIMULANT:	1900 Head
DEVICE UNDER TEST:	Intermec CN3	RELATIVE PERMITTIVITY:	39.83
RELATIVE HUMIDITY:	57.5%	CONDUCTIVITY:	1.431
PHANTOM S/NO:	HeadFT04.csv	LIQUID TEMPERATURE:	21.3°C
PHANTOM ROTATION:	180°	MAX SAR Y-AXIS LOCATION:	-1.90 mm
DUT POSITION:	RH-Cheek 15°	MAX SAR Z-AXIS LOCATION:	-124.10 mm
ANTENNA CONFIGURATION:	Fixed Internal	MAX E FIELD:	6.25 V/m
TEST FREQUENCY:	1880.0MHz	SAR 1g:	0.049 W/kg
AIR FACTORS:	345 / 442 / 414	SAR 10g:	0.032 W/kg
CONVERSION FACTORS:	0.382 / 0.382 / 0.382	SAR START:	0.025 W/kg
TYPE OF MODULATION:	GMSK (GSM mode)	SAR END:	0.025 W/kg
MODN. DUTY CYCLE:	12.5%	SAR DRIFT DURING SCAN:	-1.51 %
DIODE COMPRESSION FACTORS (V*200):	20 / 20 / 20	PROBE BATTERY LAST CHANGED:	16/08/06
INPUT POWER LEVEL:	0	EXTRAPOLATION:	poly4

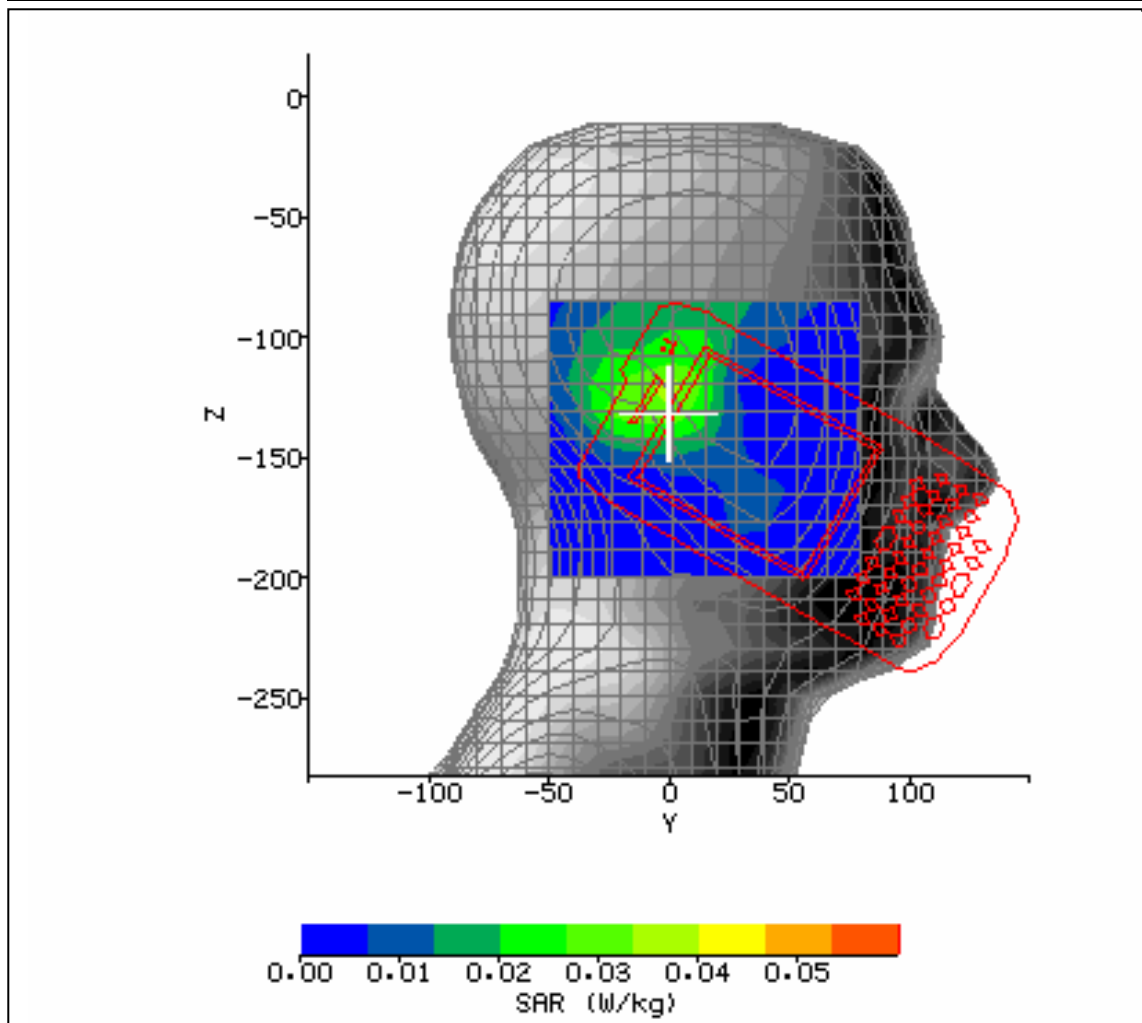

Figure 22: SAR Head Testing Results for the Intermec CN3 Mobile Computer in Right Hand Cheek 15° Position; Tested at 1880.0MHz (1900MHz PCS Middle Channel).

2.4 1900MHz GSM HEAD SAR TEST RESULT INCLUDING COURSE AREA SCAN – 2D

SYSTEM / SOFTWARE:	SARA2 / 2.39 VPM	INPUT POWER DRIFT:	0.0 dB
DATE / TIME:	16/08/2006 18:41:49	DUT BATTERY MODEL/NO:	318-016-002
FILENAME:	WS615435_F_11.txt	PROBE SERIAL NUMBER:	0187
AMBIENT TEMPERATURE:	22.7°C	LIQUID SIMULANT:	1900 Head
DEVICE UNDER TEST:	Intermec CN3	RELATIVE PERMITTIVITY:	39.83
RELATIVE HUMIDITY:	56.2%	CONDUCTIVITY:	1.431
PHANTOM S/NO:	HeadFT04.csv	LIQUID TEMPERATURE:	21.1°C
PHANTOM ROTATION:	180°	MAX SAR Y-AXIS LOCATION:	-3.20 mm
DUT POSITION:	RH-Cheek 15°	MAX SAR Z-AXIS LOCATION:	-124.10 mm
ANTENNA CONFIGURATION:	Fixed Internal	MAX E FIELD:	6.35 V/m
TEST FREQUENCY:	1850.2MHz	SAR 1g:	0.046 W/kg
AIR FACTORS:	345 / 442 / 414	SAR 10g:	0.029 W/kg
CONVERSION FACTORS:	0.382 / 0.382 / 0.382	SAR START:	0.024 W/kg
TYPE OF MODULATION:	GMSK (GSM mode)	SAR END:	0.024 W/kg
MODN. DUTY CYCLE:	12.5%	SAR DRIFT DURING SCAN:	-1.70 %
DIODE COMPRESSION FACTORS (V*200):	20 / 20 / 20	PROBE BATTERY LAST CHANGED:	16/08/06
INPUT POWER LEVEL:	0	EXTRAPOLATION:	poly4

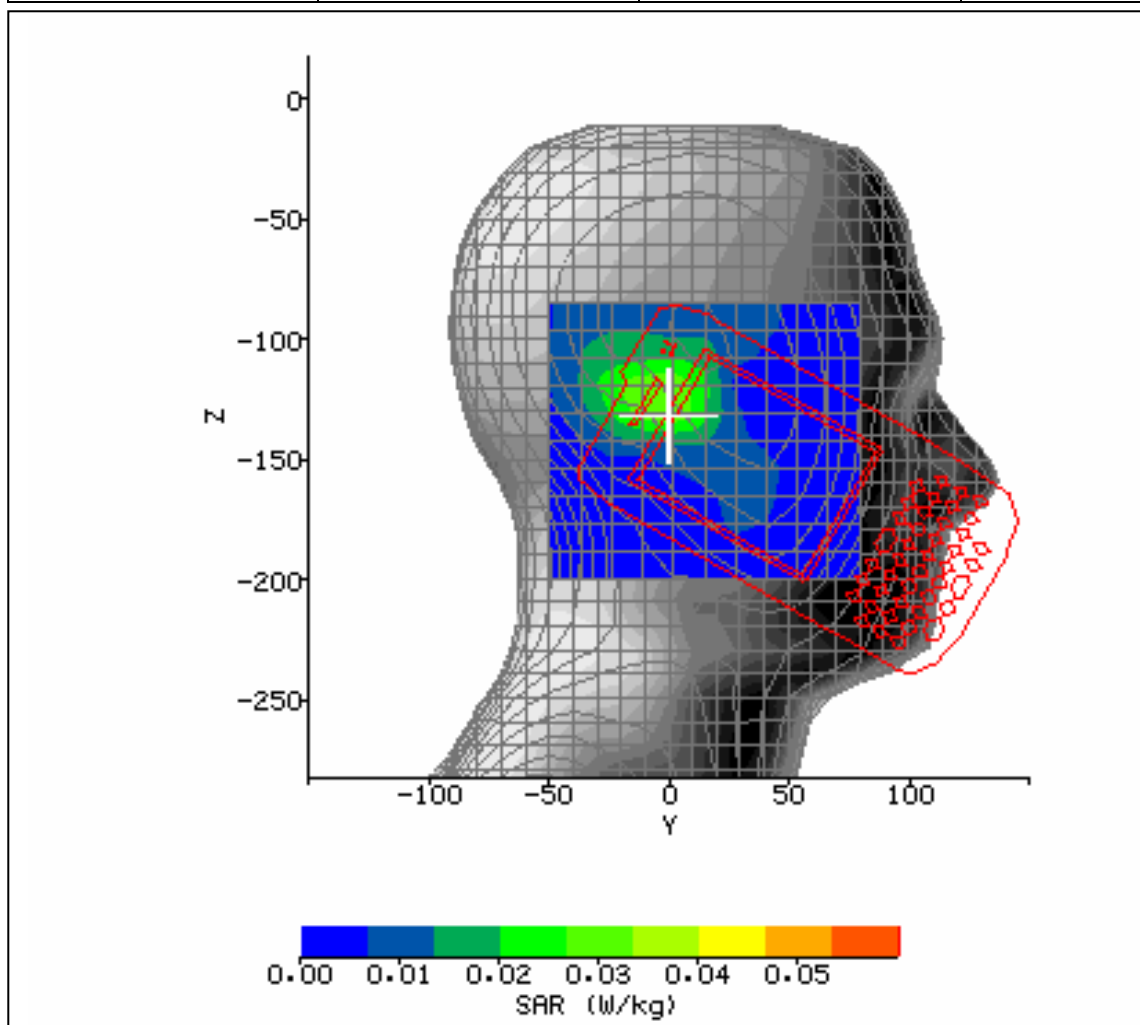

Figure 23: SAR Head Testing Results for the Intermec CN3 Mobile Computer in Right Hand Cheek 15° Position; Tested at 1850.2MHz (1900MHz PCS Bottom Channel).

2.4 1900MHz GSM HEAD SAR TEST RESULT INCLUDING COURSE AREA SCAN – 2D

SYSTEM / SOFTWARE:	SARA2 / 2.39 VPM	INPUT POWER DRIFT:	0.0 dB
DATE / TIME:	16/08/2006 19:10:55	DUT BATTERY MODEL/NO:	318-016-002
FILENAME:	WS615435_F_12.txt	PROBE SERIAL NUMBER:	0187
AMBIENT TEMPERATURE:	21.9°C	LIQUID SIMULANT:	1900 Head
DEVICE UNDER TEST:	Intermec CN3	RELATIVE PERMITTIVITY:	39.83
RELATIVE HUMIDITY:	55.8%	CONDUCTIVITY:	1.431
PHANTOM S/NO:	HeadFT04.csv	LIQUID TEMPERATURE:	21.1°C
PHANTOM ROTATION:	180°	MAX SAR Y-AXIS LOCATION:	-1.90 mm
DUT POSITION:	RH-Cheek 15°	MAX SAR Z-AXIS LOCATION:	-124.10 mm
ANTENNA CONFIGURATION:	Fixed Internal	MAX E FIELD:	5.58 V/m
TEST FREQUENCY:	1909.8MHz	SAR 1g:	0.040 W/kg
AIR FACTORS:	345 / 442 / 414	SAR 10g:	0.025 W/kg
CONVERSION FACTORS:	0.382 / 0.382 / 0.382	SAR START:	0.017 W/kg
TYPE OF MODULATION:	GMSK (GSM mode)	SAR END:	0.018 W/kg
MODN. DUTY CYCLE:	12.5%	SAR DRIFT DURING SCAN:	0.00 %
DIODE COMPRESSION FACTORS (V*200):	20 / 20 / 20	PROBE BATTERY LAST CHANGED:	16/08/06
INPUT POWER LEVEL:	0	EXTRAPOLATION:	poly4

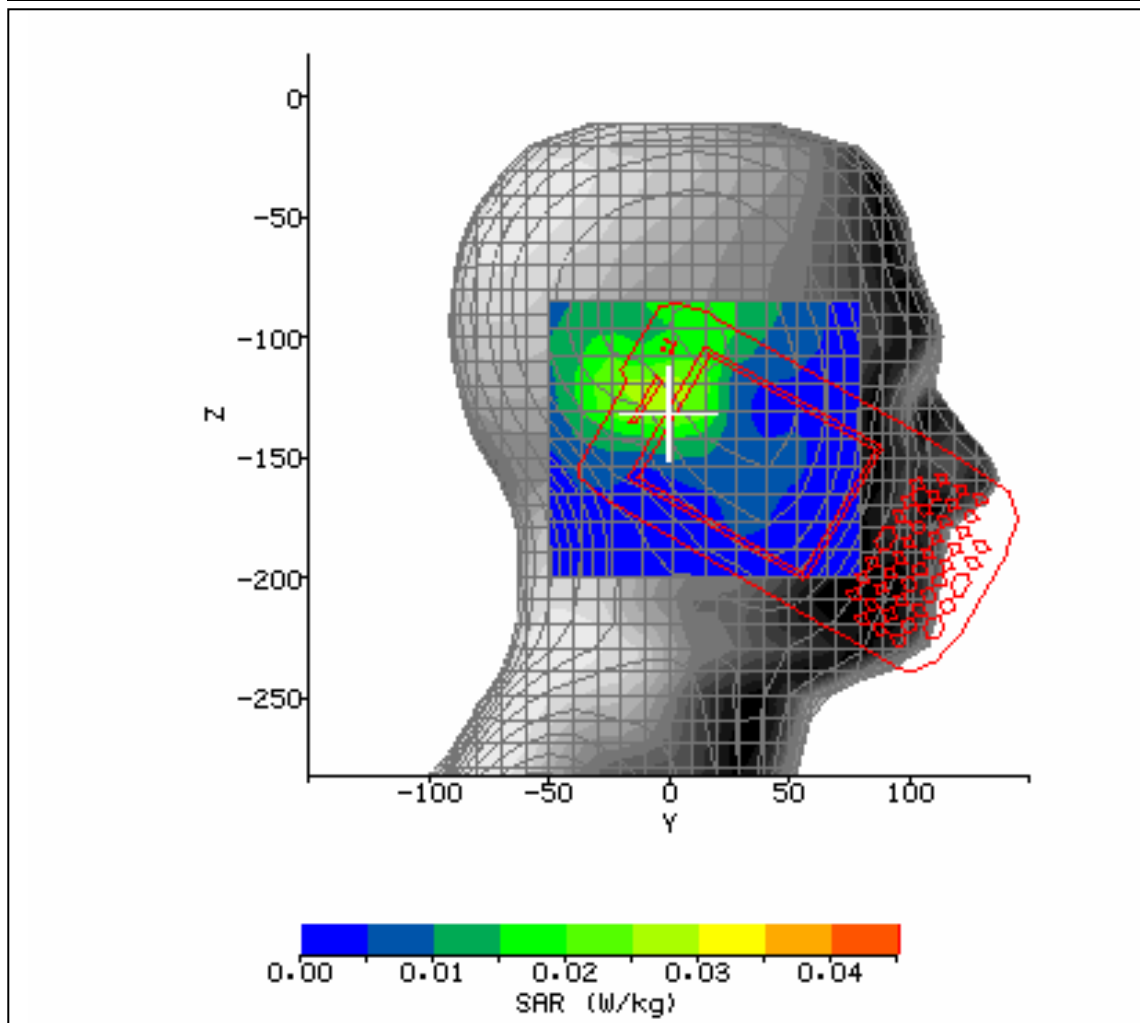

Figure 24: SAR Head Testing Results for the Intermec CN3 Mobile Computer in Left Hand Cheek Position; Tested at 1909.8MHz (1900MHz PCS Top Channel).

2.4.1 1900MHz GPRS BODY SAR TEST RESULT INCLUDING COURSE AREA SCAN – 2D

SYSTEM / SOFTWARE:	SARA2 / 2.39 VPM	INPUT POWER DRIFT:	0.0 dB
DATE / TIME:	17/08/2006 10:17:09	DUT BATTERY MODEL/NO:	318-016-002
FILENAME:	WS615435_F_32.txt	PROBE SERIAL NUMBER:	187
AMBIENT TEMPERATURE:	21.7°C	LIQUID SIMULANT:	1900 Body
DEVICE UNDER TEST:	Intermec CN3	RELATIVE PERMITTIVITY:	53.48
RELATIVE HUMIDITY:	57.2%	CONDUCTIVITY:	0.967
PHANTOM S/NO:	HeadBox02.csv	LIQUID TEMPERATURE:	21.6°C
PHANTOM ROTATION:	0°	MAX SAR X-AXIS LOCATION:	53.00 mm
DUT POSITION:	Front facing 0.0mm spacing	MAX SAR Y-AXIS LOCATION:	--11.00 mm
ANTENNA CONFIGURATION:	Fixed Internal	MAX E FIELD:	6.34 V/m
TEST FREQUENCY:	1880.0MHz	SAR 1g:	0.074 W/kg
AIR FACTORS:	345 / 442 / 414	SAR 10g:	0.050 W/kg
CONVERSION FACTORS:	0.420 / 0.420 / 0.420	SAR START:	0.021 W/kg
TYPE OF MODULATION:	GMSK (GPRS mode)	SAR END:	0.021 W/kg
MODN. DUTY CYCLE:	50%	SAR DRIFT DURING SCAN:	-1.10 %
DIODE COMPRESSION FACTORS (V*200):	20 / 20 / 20	PROBE BATTERY LAST CHANGED:	16/08/2006
INPUT POWER LEVEL:	4x 30dBm	EXTRAPOLATION:	poly4

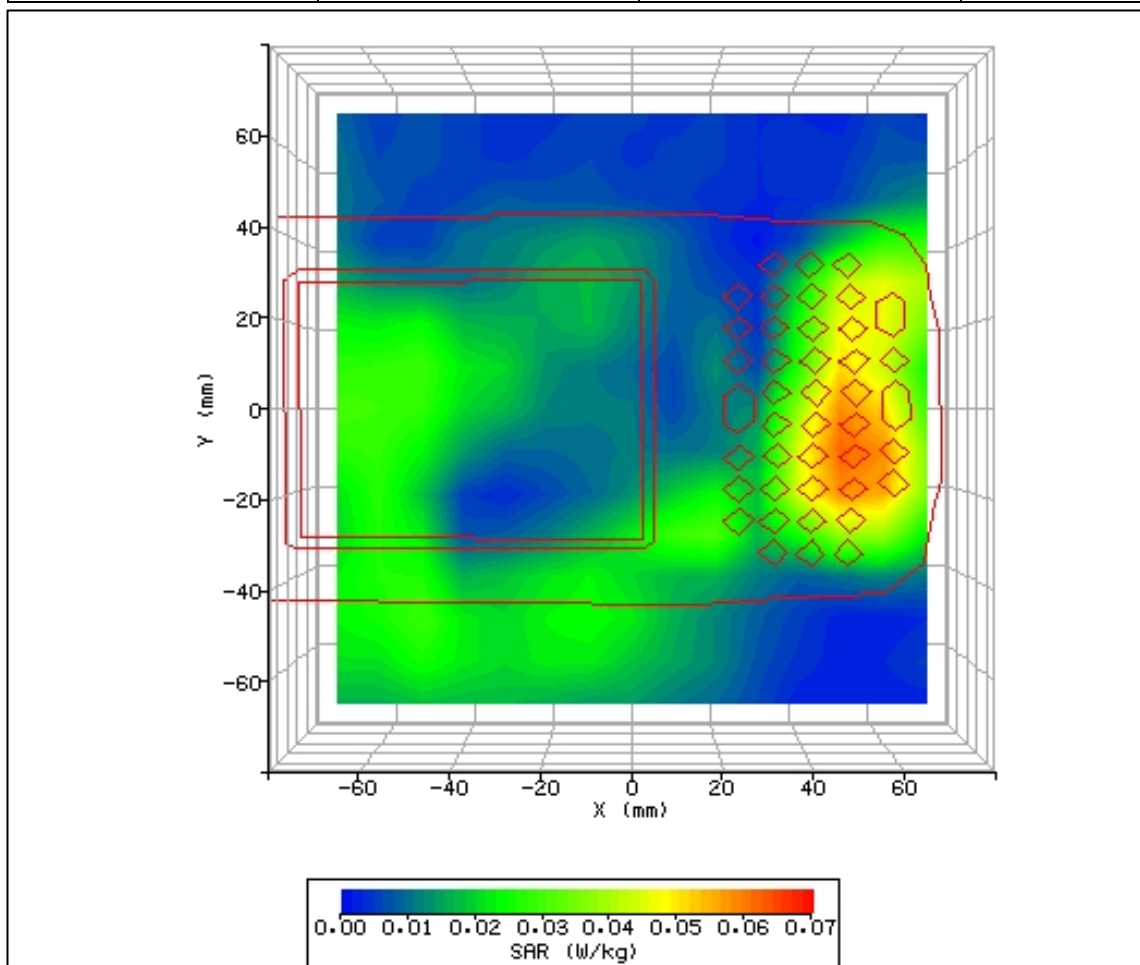

Figure 25: SAR Body GPRS Testing Results for the Intermec CN3 Mobile Computer in Front Facing Phantom Position; Tested at 1880.0MHz (1900MHz GSM Middle Channel) with 0.0mm Separation.

2.4.1 1900MHz GPRS BODY SAR TEST RESULT INCLUDING COURSE AREA SCAN – 2D

SYSTEM / SOFTWARE:	SARA2 / 2.39 VPM	INPUT POWER DRIFT:	0.0 dB
DATE / TIME:	17/08/2006 11:24:36	DUT BATTERY MODEL/NO:	318-016-002
FILENAME:	WS615435_F_34.txt	PROBE SERIAL NUMBER:	187
AMBIENT TEMPERATURE:	22.6°C	LIQUID SIMULANT:	1900 Body
DEVICE UNDER TEST:	Intermec CN3	RELATIVE PERMITTIVITY:	53.48
RELATIVE HUMIDITY:	63.6%	CONDUCTIVITY:	0.967
PHANTOM S/NO:	HeadBox02.csv	LIQUID TEMPERATURE:	21.7°C
PHANTOM ROTATION:	0°	MAX SAR X-AXIS LOCATION:	-38.00 mm
DUT POSITION:	Rear facing 15mm spacing	MAX SAR Y-AXIS LOCATION:	14.00 mm
ANTENNA CONFIGURATION:	Fixed Internal	MAX E FIELD:	14.23 V/m
TEST FREQUENCY:	1880.0MHz	SAR 1g:	0.379 W/kg
AIR FACTORS:	345 / 442 / 414	SAR 10g:	0.222 W/kg
CONVERSION FACTORS:	0.420 / 0.420 / 0.420	SAR START:	0.066 W/kg
TYPE OF MODULATION:	GMSK (GPRS mode)	SAR END:	0.067 W/kg
MODN. DUTY CYCLE:	50%	SAR DRIFT DURING SCAN:	1.50 %
DIODE COMPRESSION FACTORS (V*200):	20 / 20 / 20	PROBE BATTERY LAST CHANGED:	16/08/2006
INPUT POWER LEVEL:	4x 30dBm	EXTRAPOLATION:	poly4

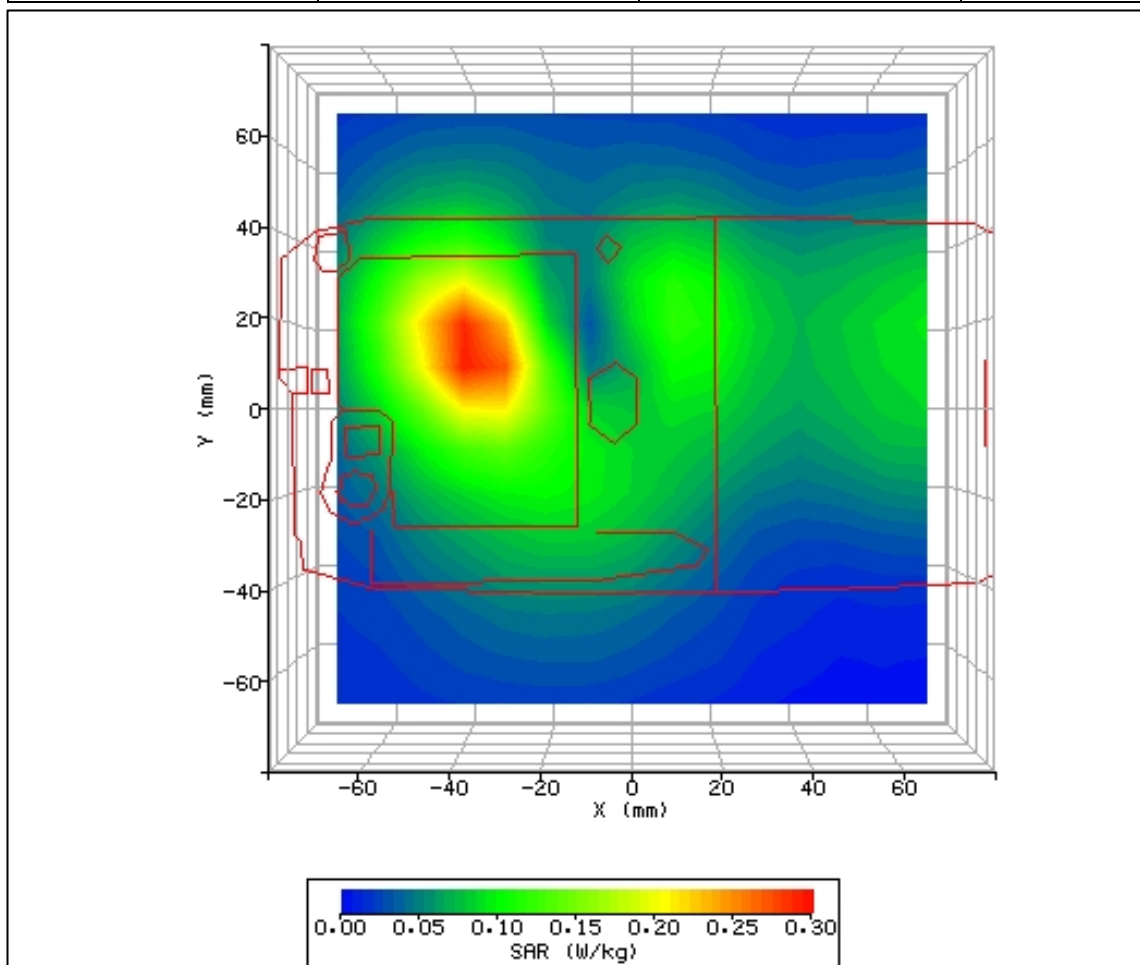

Figure 26: SAR Body GPRS Testing Results for the Intermec CN3 Mobile Computer in Rear Facing Phantom Position; Tested at 1880.0MHz (1900MHz GSM Middle Channel) with 15.0mm Separation.

2.4.1 1900MHz GPRS BODY SAR TEST RESULT INCLUDING COURSE AREA SCAN – 2D

SYSTEM / SOFTWARE:	SARA2 / 2.39 VPM	INPUT POWER DRIFT:	0.0 dB
DATE / TIME:	17/08/2006 11:56:59	DUT BATTERY MODEL/NO:	318-016-002
FILENAME:	WS615435_F_35.txt	PROBE SERIAL NUMBER:	187
AMBIENT TEMPERATURE:	23.1°C	LIQUID SIMULANT:	1900 Body
DEVICE UNDER TEST:	Intermec CN3	RELATIVE PERMITTIVITY:	53.48
RELATIVE HUMIDITY:	62.8%	CONDUCTIVITY:	0.967
PHANTOM S/NO:	HeadBox02.csv	LIQUID TEMPERATURE:	21.7°C
PHANTOM ROTATION:	0°	MAX SAR X-AXIS LOCATION:	-44.00 mm
DUT POSITION:	Rear facing 15mm spacing	MAX SAR Y-AXIS LOCATION:	2.00 mm
ANTENNA CONFIGURATION:	Fixed Internal	MAX E FIELD:	13.53 V/m
TEST FREQUENCY:	1850.2MHz	SAR 1g:	0.339 W/kg
AIR FACTORS:	345 / 442 / 414	SAR 10g:	0.199 W/kg
CONVERSION FACTORS:	0.420 / 0.420 / 0.420	SAR START:	0.058 W/kg
TYPE OF MODULATION:	GMSK (GPRS mode)	SAR END:	0.058 W/kg
MODN. DUTY CYCLE:	50%	SAR DRIFT DURING SCAN:	0.07 %
DIODE COMPRESSION FACTORS (V*200):	20 / 20 / 20	PROBE BATTERY LAST CHANGED:	16/08/2006
INPUT POWER LEVEL:	4x 30dBm	EXTRAPOLATION:	poly4

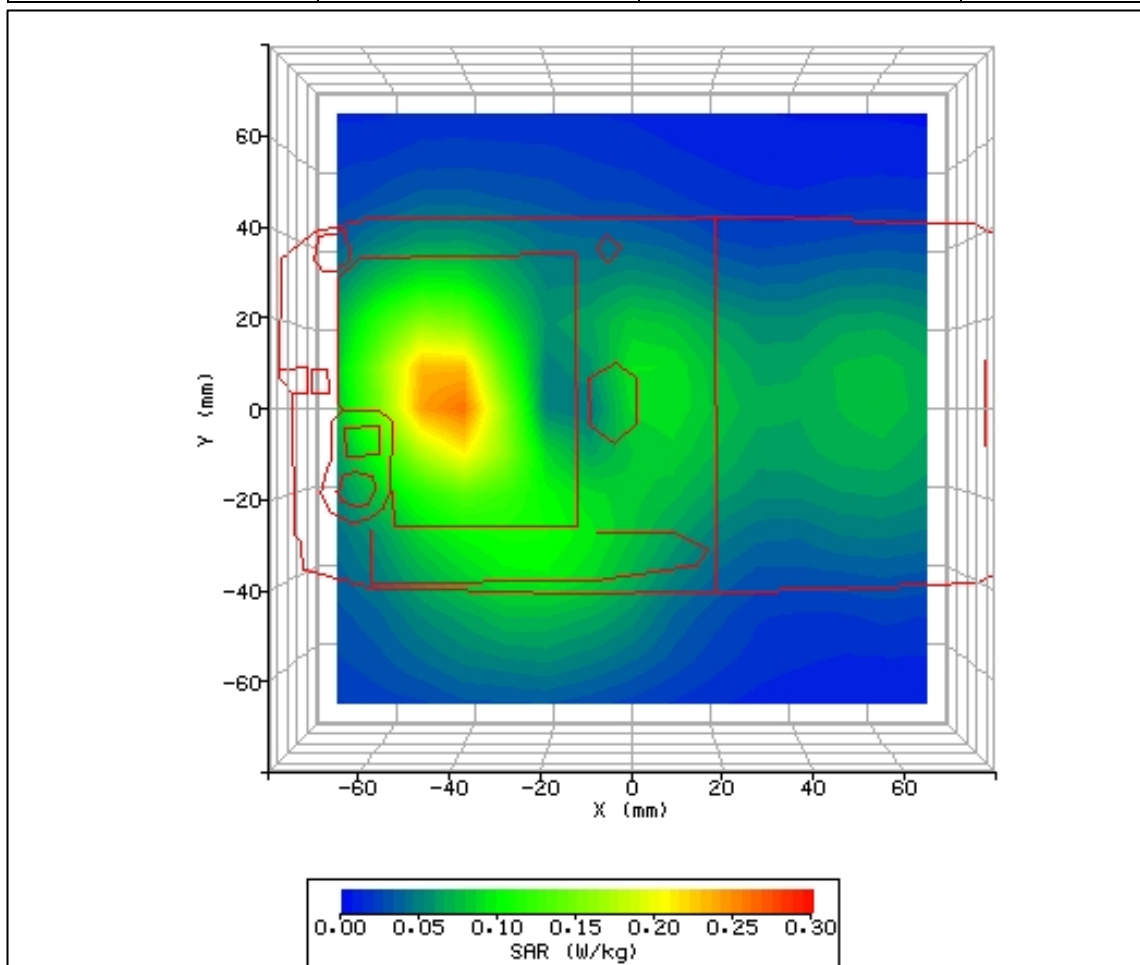

Figure 27: SAR Body GPRS Testing Results for the Intermec CN3 Mobile Computer in Rear Facing Phantom Position; Tested at 1850.2MHz (1900MHz GSM Bottom Channel) with 15.0mm Separation.

2.4.1 1900MHz GPRS BODY SAR TEST RESULT INCLUDING COURSE AREA SCAN – 2D

SYSTEM / SOFTWARE:	SARA2 / 2.39 VPM	INPUT POWER DRIFT:	0.0 dB
DATE / TIME:	17/08/2006 13:06:06	DUT BATTERY MODEL/NO:	318-016-002
FILENAME:	WS615435_F_36.txt	PROBE SERIAL NUMBER:	187
AMBIENT TEMPERATURE:	21.5°C	LIQUID SIMULANT:	1900 Body
DEVICE UNDER TEST:	Intermec CN3	RELATIVE PERMITTIVITY:	53.48
RELATIVE HUMIDITY:	55.2%	CONDUCTIVITY:	0.967
PHANTOM S/NO:	HeadBox02.csv	LIQUID TEMPERATURE:	21.4°C
PHANTOM ROTATION:	0°	MAX SAR X-AXIS LOCATION:	-44.00 mm
DUT POSITION:	Rear facing 15mm spacing	MAX SAR Y-AXIS LOCATION:	9.00 mm
ANTENNA CONFIGURATION:	Fixed Internal	MAX E FIELD:	14.42 V/m
TEST FREQUENCY:	1909.8MHz	SAR 1g:	0.391 W/kg
AIR FACTORS:	345 / 442 / 414	SAR 10g:	0.226 W/kg
CONVERSION FACTORS:	0.420 / 0.420 / 0.420	SAR START:	0.064 W/kg
TYPE OF MODULATION:	GMSK (GPRS mode)	SAR END:	0.064 W/kg
MODN. DUTY CYCLE:	50%	SAR DRIFT DURING SCAN:	-1.20 %
DIODE COMPRESSION FACTORS (V*200):	20 / 20 / 20	PROBE BATTERY LAST CHANGED:	16/08/2006
INPUT POWER LEVEL:	4x 30dBm	EXTRAPOLATION:	poly4

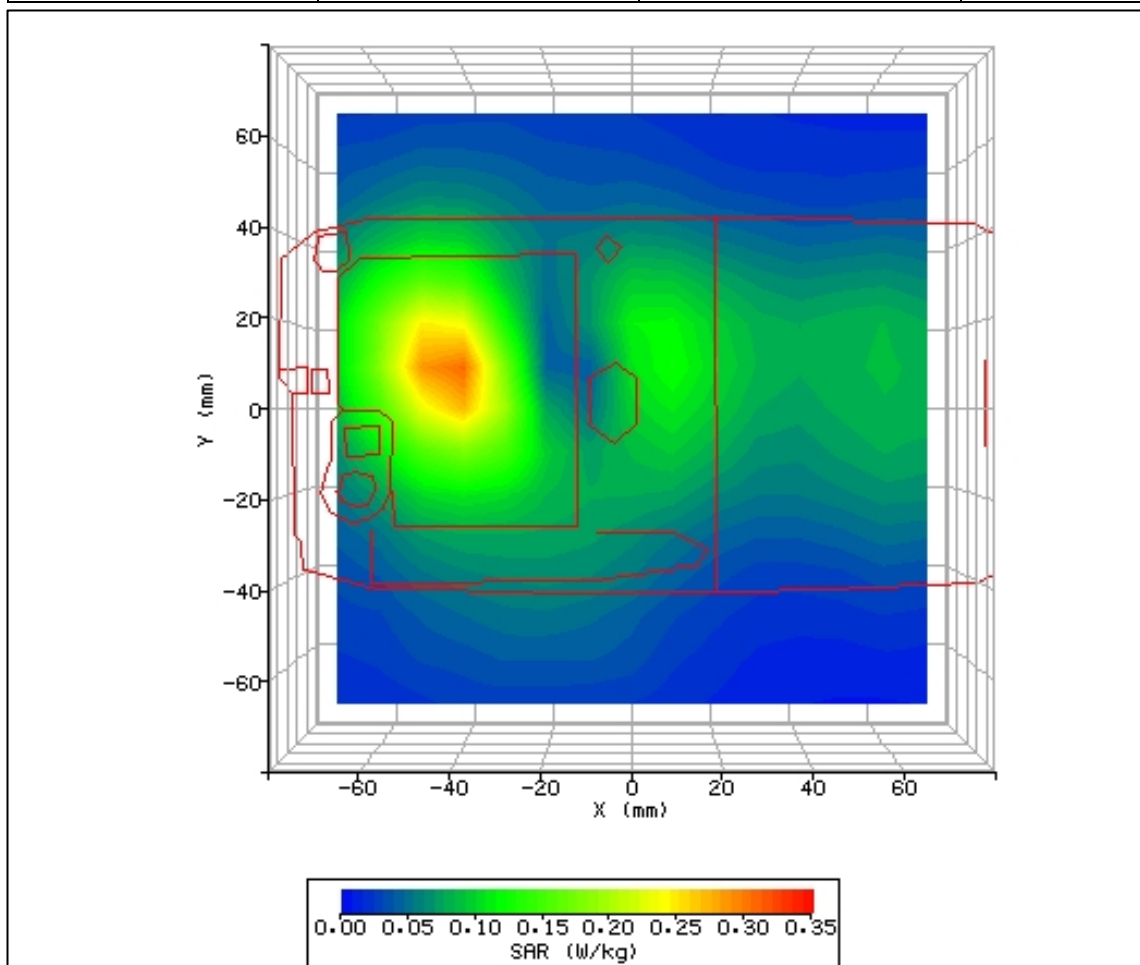

Figure 28: SAR Body GPRS Testing Results for the Intermec CN3 Mobile Computer in Rear Facing Phantom Position; Tested at 1909.8MHz (1900MHz GSM Top Channel) with 15.0mm Separation.

2.4.2 1900MHz EGPRS BODY SAR TEST RESULT INCLUDING COURSE AREA SCAN – 2D

SYSTEM / SOFTWARE:	SARA2 / 2.39 VPM	INPUT POWER DRIFT:	0.0 dB
DATE / TIME:	17/08/2006 13:37:33	DUT BATTERY MODEL/NO:	318-016-002
FILENAME:	WS615435_F_37.txt	PROBE SERIAL NUMBER:	187
AMBIENT TEMPERATURE:	21.8°C	LIQUID SIMULANT:	1900 Body
DEVICE UNDER TEST:	Intermec CN3	RELATIVE PERMITTIVITY:	53.48
RELATIVE HUMIDITY:	64.2%	CONDUCTIVITY:	0.967
PHANTOM S/NO:	HeadBox02.csv	LIQUID TEMPERATURE:	21.4°C
PHANTOM ROTATION:	0°	MAX SAR X-AXIS LOCATION:	-41.00 mm
DUT POSITION:	Rear facing 15mm spacing	MAX SAR Y-AXIS LOCATION:	9.00 mm
ANTENNA CONFIGURATION:	Fixed Internal	MAX E FIELD:	9.64 V/m
TEST FREQUENCY:	1909.8MHz	SAR 1g:	0.173 W/kg
AIR FACTORS:	345 / 442 / 414	SAR 10g:	0.100 W/kg
CONVERSION FACTORS:	0.420 / 0.420 / 0.420	SAR START:	0.028 W/kg
TYPE OF MODULATION:	8PSK (EGPRS mode)	SAR END:	0.027 W/kg
MODN. DUTY CYCLE:	25%	SAR DRIFT DURING SCAN:	-3.69 %
DIODE COMPRESSION FACTORS (V*200):	20 / 20 / 20	PROBE BATTERY LAST CHANGED:	16/08/2006
INPUT POWER LEVEL:	2x 26dBm	EXTRAPOLATION:	poly4

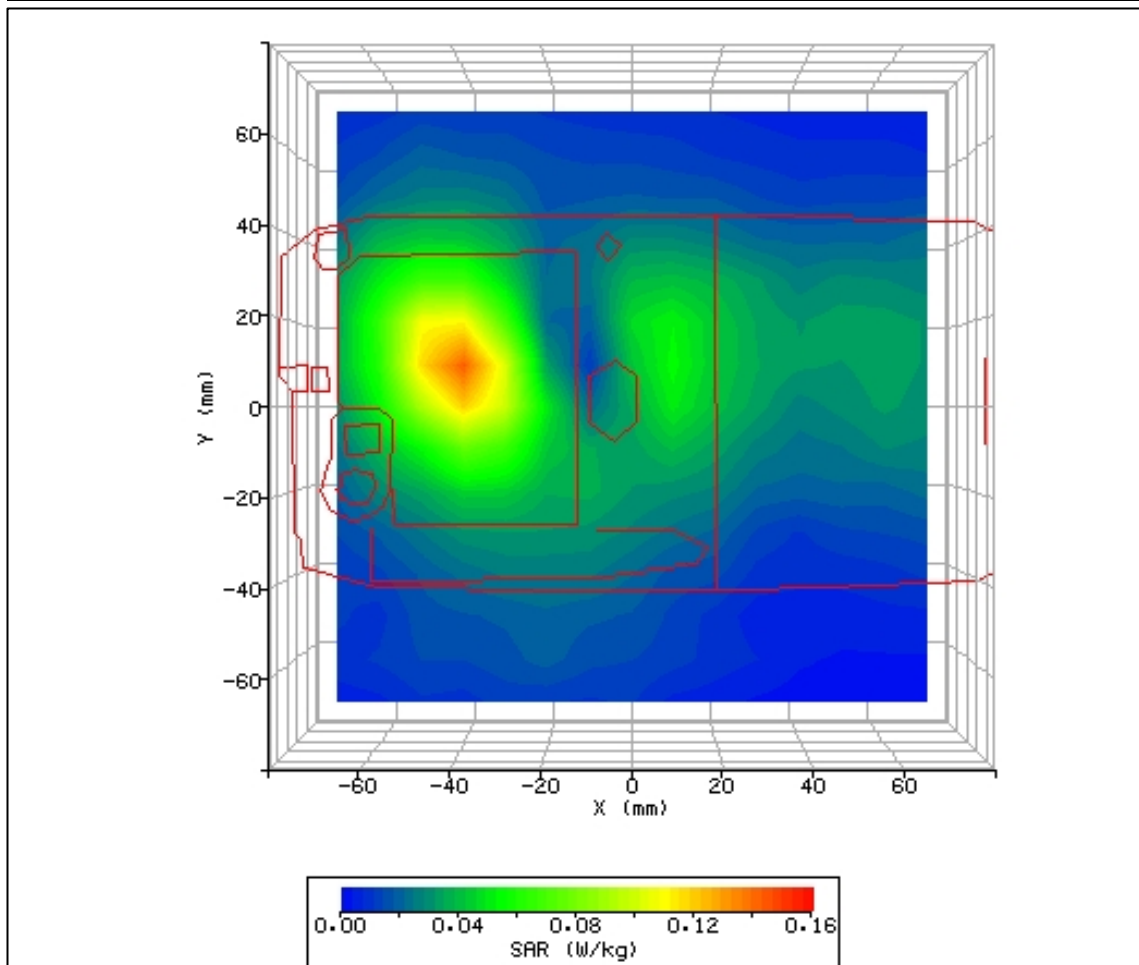

Figure 29: SAR Body EGPRS Testing Results for the Intermec CN3 Mobile Computer in Rear Facing Phantom Position; Tested at 1909.8MHz (1900MHz GSM Top Channel) with 15.0mm Separation.

2.4.3 1900MHz GPRS BODY SAR TEST RESULT INCLUDING COURSE AREA SCAN – 2D

SYSTEM / SOFTWARE:	SARA2 / 2.39 VPM	INPUT POWER DRIFT:	0.0 dB
DATE / TIME:	17/08/2006 14:09:31	DUT BATTERY MODEL/NO:	318-016-002
FILENAME:	WS615435_F_38.txt	PROBE SERIAL NUMBER:	187
AMBIENT TEMPERATURE:	22.7°C	LIQUID SIMULANT:	1900 Body
DEVICE UNDER TEST:	Intermec CN3	RELATIVE PERMITTIVITY:	53.48
RELATIVE HUMIDITY:	59.80%	CONDUCTIVITY:	0.967
PHANTOM S/NO:	HeadBox02.csv	LIQUID TEMPERATURE:	21.4°C
PHANTOM ROTATION:	0°	MAX SAR X-AXIS LOCATION:	-44.00 mm
DUT POSITION:	Rear facing 15mm spacing	MAX SAR Y-AXIS LOCATION:	6.00 mm
ANTENNA CONFIGURATION:	Fixed Internal	MAX E FIELD:	17.16 V/m
TEST FREQUENCY:	1909.8MHz	SAR 1g:	0.543 W/kg
AIR FACTORS:	345 / 442 / 414	SAR 10g:	0.292 W/kg
CONVERSION FACTORS:	0.420 / 0.420 / 0.420	SAR START:	0.067 W/kg
TYPE OF MODULATION:	GMSK (GPRS mode)	SAR END:	0.066 W/kg
MODN. DUTY CYCLE:	50%	SAR DRIFT DURING SCAN:	-0.91 %
DIODE COMPRESSION FACTORS (V*200):	20 / 20 / 20	PROBE BATTERY LAST CHANGED:	16/08/2006
INPUT POWER LEVEL:	4x 30dBm	EXTRAPOLATION:	poly4

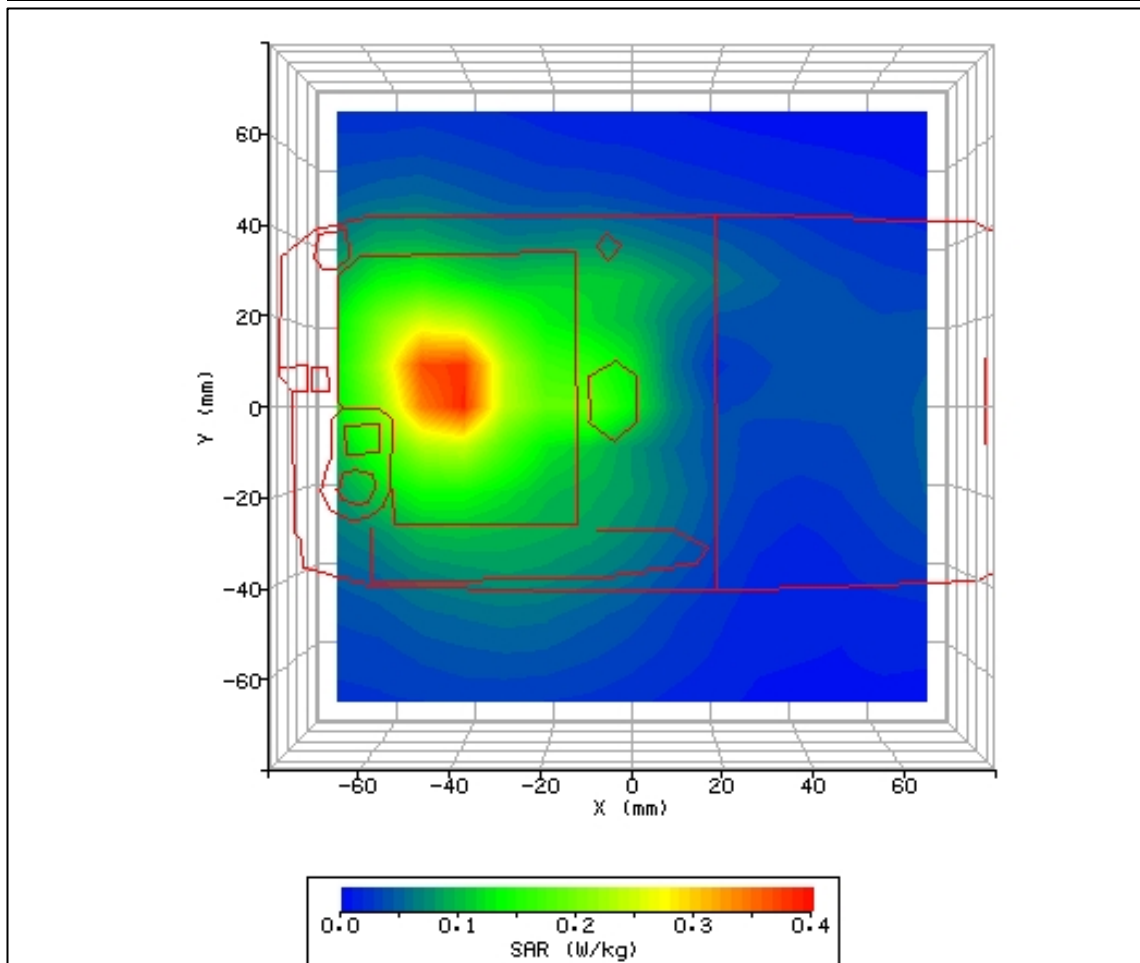

Figure 30: SAR Body GPRS Testing Results for the Intermec CN3 Mobile Computer in Rear Facing Phantom Positioned in belt-clip holster; Tested at 1909.8MHz (1900MHz GSM Top Channel) with 0.0mm Separation

2.5 2450MHz WLAN HEAD SAR TEST RESULT INCLUDING COURSE AREA SCAN – 2D

SYSTEM / SOFTWARE:	SARA2 / 2.39 VPM	INPUT POWER DRIFT:	0.0 dB
DATE / TIME:	18/08/2006 09:21:17	DUT BATTERY MODEL/NO:	318-016-002
FILENAME:	WS615435_F_13.txt	PROBE SERIAL NUMBER:	0187
AMBIENT TEMPERATURE:	23.3°C	LIQUID SIMULANT:	2450 Head
DEVICE UNDER TEST:	Intermec CN3	RELATIVE PERMITTIVITY:	38.81
RELATIVE HUMIDITY:	54.2%	CONDUCTIVITY:	1.834
PHANTOM S/NO:	HeadFT04.csv	LIQUID TEMPERATURE:	22.1°C
PHANTOM ROTATION:	0°	MAX SAR Y-AXIS LOCATION:	-18.90 mm
DUT POSITION:	LH-Cheek	MAX SAR Z-AXIS LOCATION:	-110.30 mm
ANTENNA CONFIGURATION:	Fixed Internal	MAX E FIELD:	25.57 V/m
TEST FREQUENCY:	2437MHz	SAR 1g:	0.976 W/kg
AIR FACTORS:	345 / 442 / 414	SAR 10g:	0.472 W/kg
CONVERSION FACTORS:	0.397 / 0.397 / 0.397	SAR START:	0.153 W/kg
TYPE OF MODULATION:	DSSS	SAR END:	0.156 W/kg
MODN. DUTY CYCLE:	100%	SAR DRIFT DURING SCAN:	2.11 %
DIODE COMPRESSION FACTORS (V*200):	20 / 20 / 20	PROBE BATTERY LAST CHANGED:	18/08/06
INPUT POWER LEVEL:	19.24	EXTRAPOLATION:	poly4

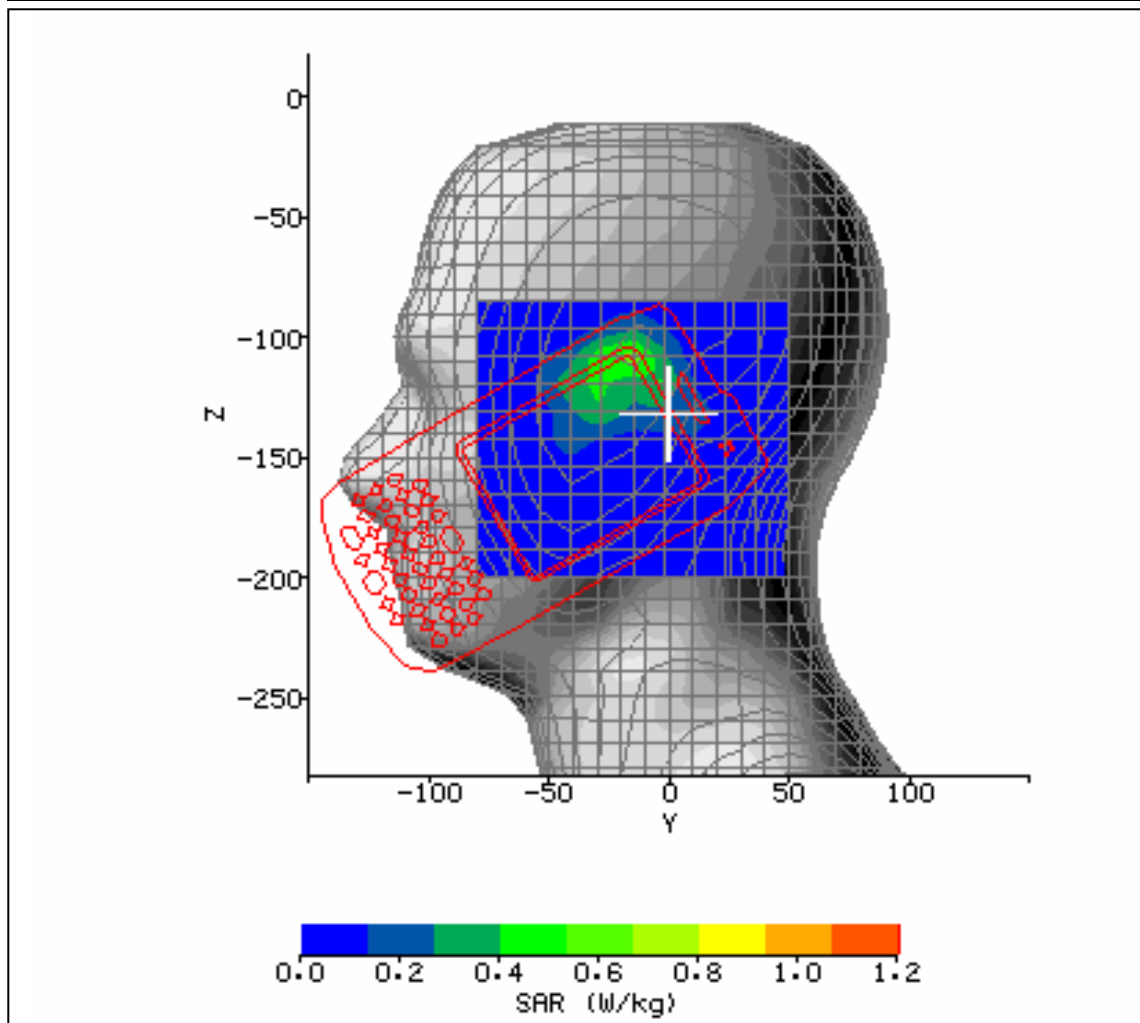

Figure 31: SAR Head Testing Results for the Intermec CN3 Mobile Computer in Left Hand Cheek Position; Tested at 2437.0MHz (2450MHz WLAN Middle Channel).

2.5 2450MHz WLAN HEAD SAR TEST RESULT INCLUDING COURSE AREA SCAN – 2D

SYSTEM / SOFTWARE:	SARA2 / 2.39 VPM	INPUT POWER DRIFT:	0.0 dB
DATE / TIME:	18/08/2006 09:55:38	DUT BATTERY MODEL/NO:	318-016-002
FILENAME:	WS615435_F_14.txt	PROBE SERIAL NUMBER:	0187
AMBIENT TEMPERATURE:	23.2°C	LIQUID SIMULANT:	2450 Head
DEVICE UNDER TEST:	Intermec CN3	RELATIVE PERMITTIVITY:	38.81
RELATIVE HUMIDITY:	57.2%	CONDUCTIVITY:	1.834
PHANTOM S/NO:	HeadFT04.csv	LIQUID TEMPERATURE:	22.1°C
PHANTOM ROTATION:	0°	MAX SAR Y-AXIS LOCATION:	-13.70 mm
DUT POSITION:	LH-Cheek 15°	MAX SAR Z-AXIS LOCATION:	-108.00 mm
ANTENNA CONFIGURATION:	Fixed Internal	MAX E FIELD:	24.50 V/m
TEST FREQUENCY:	2437MHz	SAR 1g:	0.930 W/kg
AIR FACTORS:	345 / 442 / 414	SAR 10g:	0.411 W/kg
CONVERSION FACTORS:	0.397 / 0.397 / 0.397	SAR START:	0.188 W/kg
TYPE OF MODULATION:	DSSS	SAR END:	0.189 W/kg
MODN. DUTY CYCLE:	100%	SAR DRIFT DURING SCAN:	0.95 %
DIODE COMPRESSION FACTORS (V*200):	20 / 20 / 20	PROBE BATTERY LAST CHANGED:	18/08/06
INPUT POWER LEVEL:	19.24	EXTRAPOLATION:	poly4

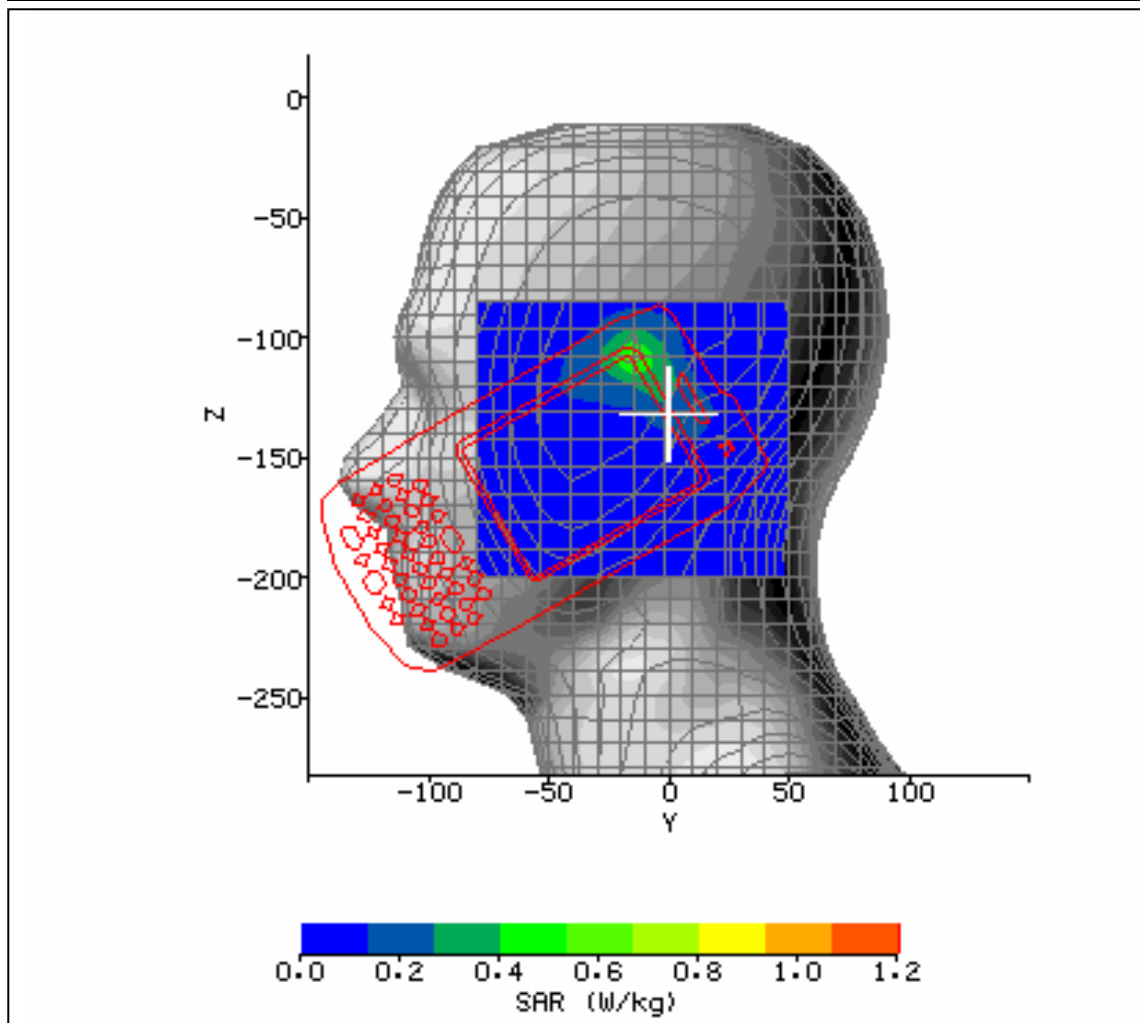

Figure 32: SAR Head Testing Results for the Intermec CN3 Mobile Computer in Left Hand 15° Cheek Position; Tested at 2437.0MHz (2450MHz WLAN Middle Channel).

2.5 2450MHz WLAN HEAD SAR TEST RESULT INCLUDING COURSE AREA SCAN – 2D

SYSTEM / SOFTWARE:	SARA2 / 2.39 VPM	INPUT POWER DRIFT:	0.0 dB
DATE / TIME:	18/08/2006 10:32:12	DUT BATTERY MODEL/NO:	318-016-002
FILENAME:	WS615435_F_15.txt	PROBE SERIAL NUMBER:	0187
AMBIENT TEMPERATURE:	22.6°C	LIQUID SIMULANT:	2450 Head
DEVICE UNDER TEST:	Intermec CN3	RELATIVE PERMITTIVITY:	38.81
RELATIVE HUMIDITY:	65.5%	CONDUCTIVITY:	1.834
PHANTOM S/NO:	HeadFT04.csv	LIQUID TEMPERATURE:	22.1°C
PHANTOM ROTATION:	180°	MAX SAR Y-AXIS LOCATION:	-0.73 mm
DUT POSITION:	RH-Cheek	MAX SAR Z-AXIS LOCATION:	-158.60 mm
ANTENNA CONFIGURATION:	Fixed Internal	MAX E FIELD:	17.47 V/m
TEST FREQUENCY:	2437MHz	SAR 1g:	0.424 W/kg
AIR FACTORS:	345 / 442 / 414	SAR 10g:	0.235 W/kg
CONVERSION FACTORS:	0.397 / 0.397 / 0.397	SAR START:	0.172 W/kg
TYPE OF MODULATION:	DSSS	SAR END:	0.173 W/kg
MODN. DUTY CYCLE:	100%	SAR DRIFT DURING SCAN:	0.80 %
DIODE COMPRESSION FACTORS (V*200):	20 / 20 / 20	PROBE BATTERY LAST CHANGED:	18/08/06
INPUT POWER LEVEL:	19.24	EXTRAPOLATION:	poly4

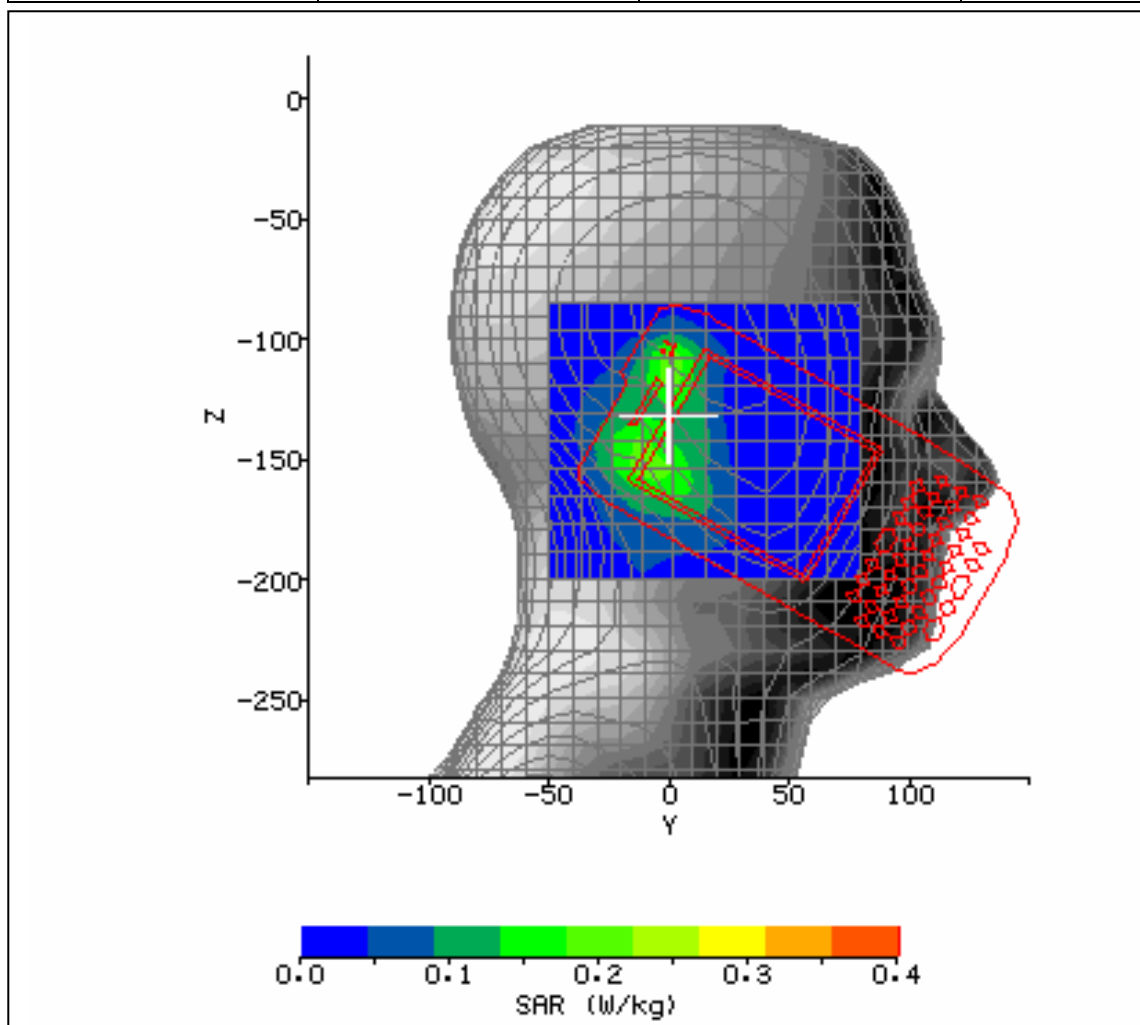

Figure 33: SAR Head Testing Results for the Intermec CN3 Mobile Computer in Right Hand Cheek Position; Tested at 2437.0MHz (2450MHz WLAN Middle Channel).

2.5 2450MHz WLAN HEAD SAR TEST RESULT INCLUDING COURSE AREA SCAN – 2D

SYSTEM / SOFTWARE:	SARA2 / 2.39 VPM	INPUT POWER DRIFT:	0.0 dB
DATE / TIME:	18/08/2006 11:08:32	DUT BATTERY MODEL/NO:	318-016-002
FILENAME:	WS615435_F_16.txt	PROBE SERIAL NUMBER:	0187
AMBIENT TEMPERATURE:	22.3°C	LIQUID SIMULANT:	2450 Head
DEVICE UNDER TEST:	Intermec CN3	RELATIVE PERMITTIVITY:	38.81
RELATIVE HUMIDITY:	61.4%	CONDUCTIVITY:	1.834
PHANTOM S/NO:	HeadFT04.csv	LIQUID TEMPERATURE:	22.1°C
PHANTOM ROTATION:	180°	MAX SAR Y-AXIS LOCATION:	-8.40 mm
DUT POSITION:	RH-Cheek 15°	MAX SAR Z-AXIS LOCATION:	-150.55 mm
ANTENNA CONFIGURATION:	Fixed Internal	MAX E FIELD:	14.34 V/m
TEST FREQUENCY:	2437MHz	SAR 1g:	0.340 W/kg
AIR FACTORS:	345 / 442 / 414	SAR 10g:	0.183 W/kg
CONVERSION FACTORS:	0.397 / 0.397 / 0.397	SAR START:	0.126 W/kg
TYPE OF MODULATION:	DSSS	SAR END:	0.124 W/kg
MODN. DUTY CYCLE:	100%	SAR DRIFT DURING SCAN:	-1.25 %
DIODE COMPRESSION FACTORS (V*200):	20 / 20 / 20	PROBE BATTERY LAST CHANGED:	18/08/06
INPUT POWER LEVEL:	19.24	EXTRAPOLATION:	poly4

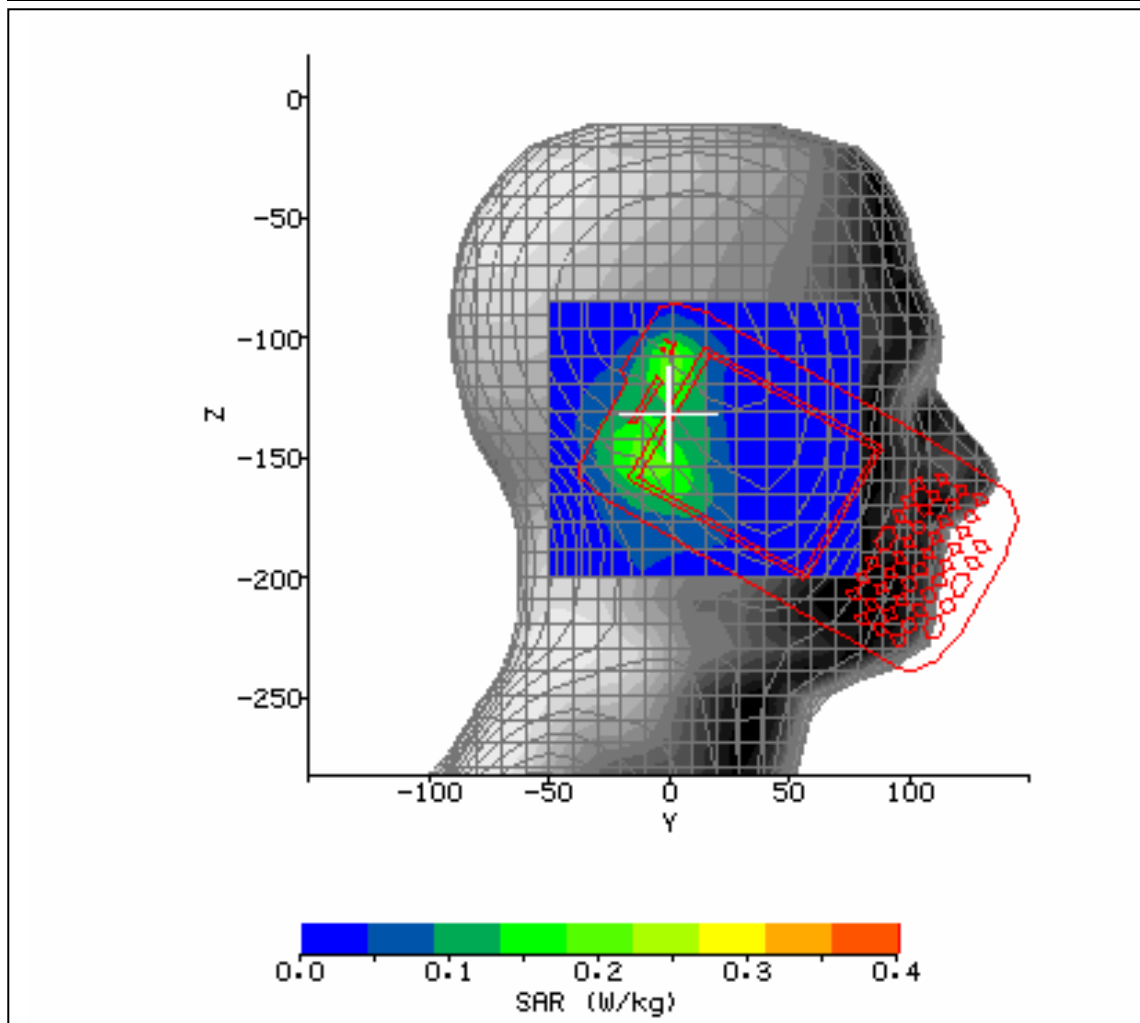

Figure 34: SAR Head Testing Results for the Intermec CN3 Mobile Computer in Right Hand 15° Cheek Position; Tested at 2437.0MHz (2450MHz WLAN Middle Channel).

2.5 2450MHz WLAN HEAD SAR TEST RESULT INCLUDING COURSE AREA SCAN – 2D

SYSTEM / SOFTWARE:	SARA2 / 2.39 VPM	INPUT POWER DRIFT:	0.0 dB
DATE / TIME:	18/08/2006 11:45:43	DUT BATTERY MODEL/NO:	318-016-002
FILENAME:	WS615435_F_17.txt	PROBE SERIAL NUMBER:	0187
AMBIENT TEMPERATURE:	22.8°C	LIQUID SIMULANT:	2450 Head
DEVICE UNDER TEST:	Intermec CN3	RELATIVE PERMITTIVITY:	38.81
RELATIVE HUMIDITY:	59.6%	CONDUCTIVITY:	1.834
PHANTOM S/NO:	HeadFT04.csv	LIQUID TEMPERATURE:	22.2°C
PHANTOM ROTATION:	0°	MAX SAR Y-AXIS LOCATION:	-18.90 mm
DUT POSITION:	LH-Cheek	MAX SAR Z-AXIS LOCATION:	-109.15 mm
ANTENNA CONFIGURATION:	Fixed Internal	MAX E FIELD:	26.72 V/m
TEST FREQUENCY:	2412MHz	SAR 1g:	1.031 W/kg
AIR FACTORS:	345 / 442 / 414	SAR 10g:	0.508 W/kg
CONVERSION FACTORS:	0.397 / 0.397 / 0.397	SAR START:	0.181 W/kg
TYPE OF MODULATION:	DSSS	SAR END:	0.181 W/kg
MODN. DUTY CYCLE:	100%	SAR DRIFT DURING SCAN:	-0.16 %
DIODE COMPRESSION FACTORS (V*200):	20 / 20 / 20	PROBE BATTERY LAST CHANGED:	18/08/06
INPUT POWER LEVEL:	19.24	EXTRAPOLATION:	poly4

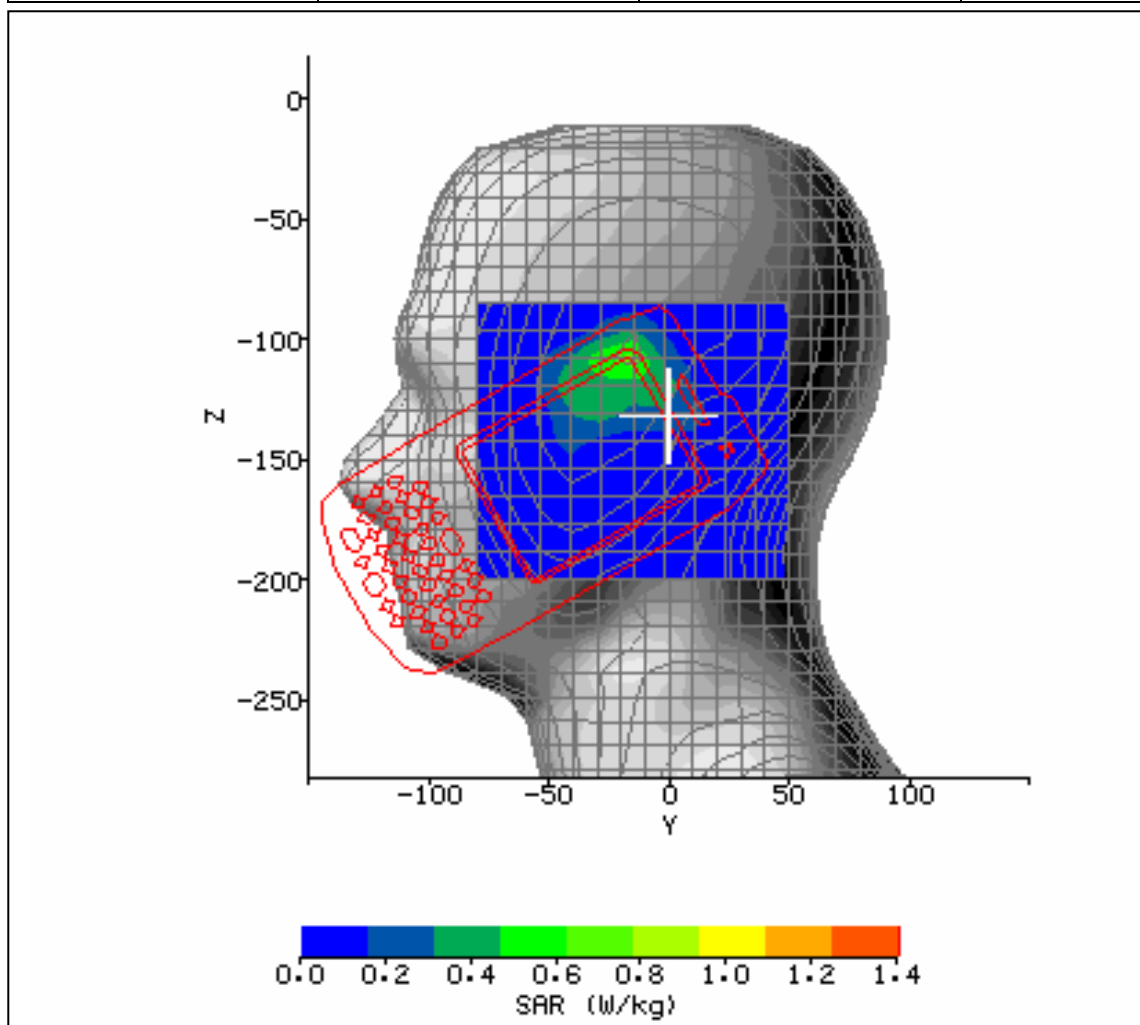

Figure 35: SAR Head Testing Results for the Intermec CN3 Mobile Computer in Right Hand 15° Cheek Position; Tested at 2412.0MHz (2450MHz WLAN Bottom Channel).

2.5 2450MHz WLAN HEAD SAR TEST RESULT INCLUDING COURSE AREA SCAN – 2D

SYSTEM / SOFTWARE:	SARA2 / 2.39 VPM	INPUT POWER DRIFT:	0.0 dB
DATE / TIME:	18/08/2006 12:18:48	DUT BATTERY MODEL/NO:	318-016-002
FILENAME:	WS615435_F_18.txt	PROBE SERIAL NUMBER:	0187
AMBIENT TEMPERATURE:	22.7°C	LIQUID SIMULANT:	2450 Head
DEVICE UNDER TEST:	Intermec CN3	RELATIVE PERMITTIVITY:	38.81
RELATIVE HUMIDITY:	62.0%	CONDUCTIVITY:	1.834
PHANTOM S/NO:	HeadFT04.csv	LIQUID TEMPERATURE:	22.2°C
PHANTOM ROTATION:	0°	MAX SAR Y-AXIS LOCATION:	-17.60 mm
DUT POSITION:	LH-Cheek	MAX SAR Z-AXIS LOCATION:	-109.15 mm
ANTENNA CONFIGURATION:	Fixed Internal	MAX E FIELD:	26.57 V/m
TEST FREQUENCY:	2462MHz	SAR 1g:	1.028 W/kg
AIR FACTORS:	345 / 442 / 414	SAR 10g:	0.467 W/kg
CONVERSION FACTORS:	0.397 / 0.397 / 0.397	SAR START:	0.165 W/kg
TYPE OF MODULATION:	DSSS	SAR END:	0.168 W/kg
MODN. DUTY CYCLE:	100%	SAR DRIFT DURING SCAN:	1.76 %
DIODE COMPRESSION FACTORS (V*200):	20 / 20 / 20	PROBE BATTERY LAST CHANGED:	18/08/06
INPUT POWER LEVEL:	19.24	EXTRAPOLATION:	poly4

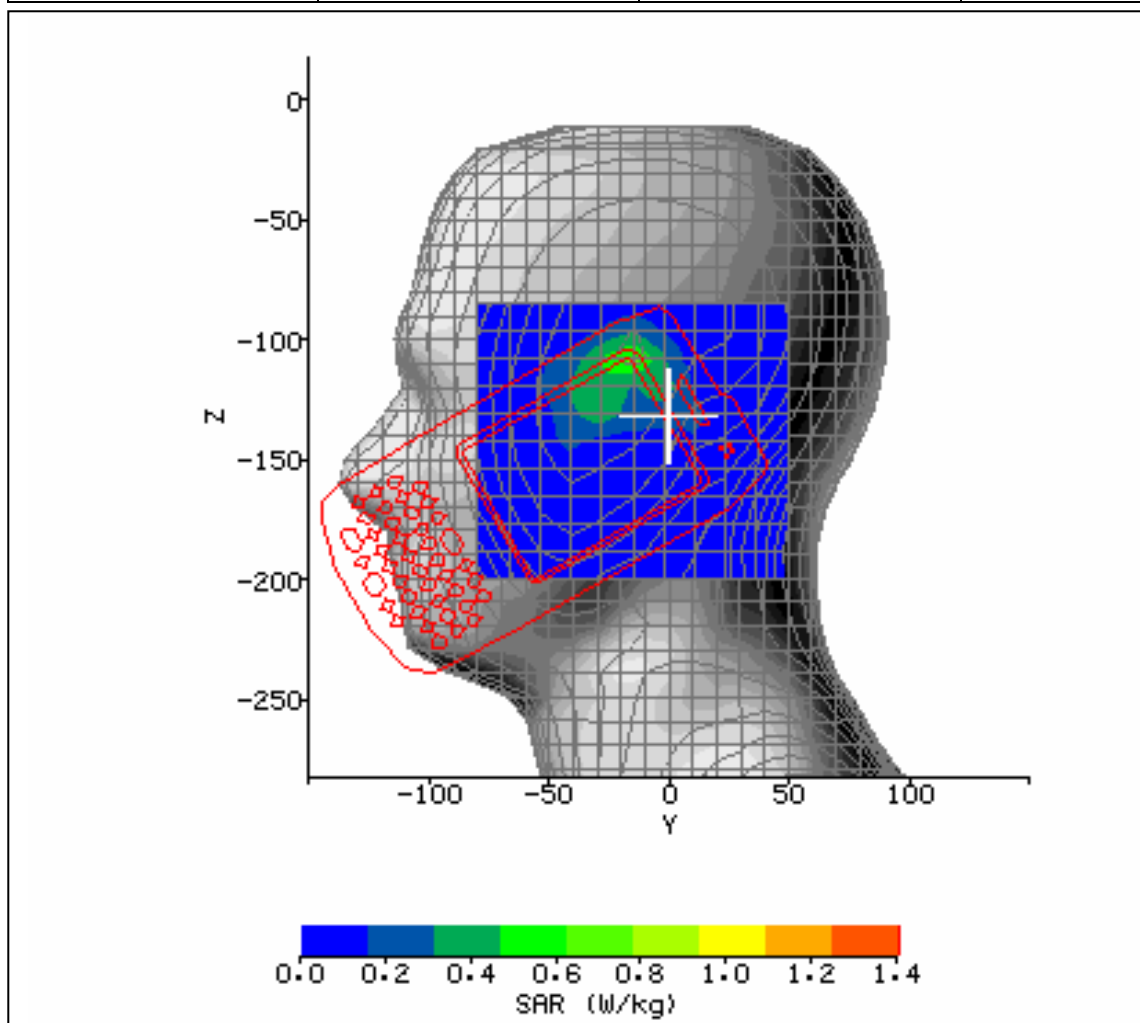

Figure 36: SAR Head Testing Results for the Intermec CN3 Mobile Computer in Right Hand 15° Cheek Position; Tested at 2462.0MHz (2450MHz WLAN Top Channel).

2.5.1 2450MHz WLAN BODY SAR TEST RESULT INCLUDING COURSE AREA SCAN – 2D

SYSTEM / SOFTWARE:	SARA2 / 2.39 VPM	INPUT POWER DRIFT:	0.0 dB
DATE / TIME:	18/08/2006 14:09:42	DUT BATTERY MODEL/NO:	318-016-002
FILENAME:	WS615435_F_39.txt	PROBE SERIAL NUMBER:	187
AMBIENT TEMPERATURE:	22.3°C	LIQUID SIMULANT:	2450 Body
DEVICE UNDER TEST:	Intermec CN3	RELATIVE PERMITTIVITY:	53.04
RELATIVE HUMIDITY:	63.7%	CONDUCTIVITY:	0.967
PHANTOM S/NO:	HeadBox02.csv	LIQUID TEMPERATURE:	20.3°C
PHANTOM ROTATION:	0°	MAX SAR X-AXIS LOCATION:	-44.00 mm
DUT POSITION:	Front facing 15.0mm spacing	MAX SAR Y-AXIS LOCATION:	38.00 mm
ANTENNA CONFIGURATION:	Fixed Internal	MAX E FIELD:	5.30 V/m
TEST FREQUENCY:	2437.0MHz	SAR 1g:	0.075 W/kg
AIR FACTORS:	345 / 442 / 414	SAR 10g:	0.044 W/kg
CONVERSION FACTORS:	0.457 / 0.457 / 0.457	SAR START:	0.008 W/kg
TYPE OF MODULATION:	DSSS	SAR END:	0.008 W/kg
MODN. DUTY CYCLE:	100%	SAR DRIFT DURING SCAN:	0.00 %
DIODE COMPRESSION FACTORS (V*200):	20 / 20 / 20	PROBE BATTERY LAST CHANGED:	18/08/2006
INPUT POWER LEVEL:	19.24	EXTRAPOLATION:	poly4

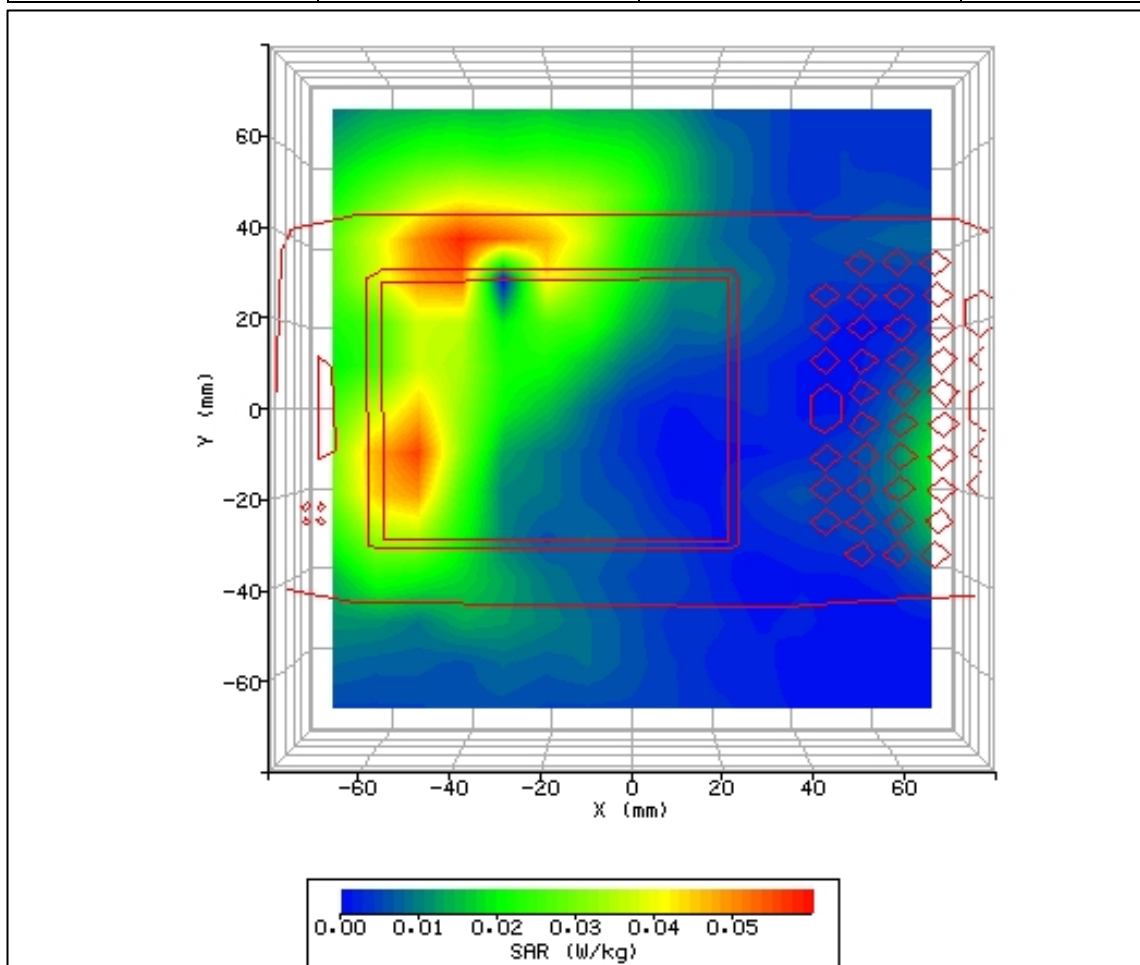

Figure 37: SAR Body WLAN Testing Results for the Intermec CN3 Mobile Computer in Front Facing Phantom Position; Tested at 2437.0MHz (2450MHz WLAN Middle Channel) with 15.0mm Separation.

2.5.1 2450MHz WLAN BODY SAR TEST RESULT INCLUDING COURSE AREA SCAN – 2D

SYSTEM / SOFTWARE:	SARA2 / 2.39 VPM	INPUT POWER DRIFT:	0.0 dB
DATE / TIME:	18/08/2006 14:36:56	DUT BATTERY MODEL/NO:	318-016-002
FILENAME:	WS615435_F_40.txt	PROBE SERIAL NUMBER:	187
AMBIENT TEMPERATURE:	22.1°C	LIQUID SIMULANT:	2450 Body
DEVICE UNDER TEST:	Intermec CN3	RELATIVE PERMITTIVITY:	53.04
RELATIVE HUMIDITY:	57.2%	CONDUCTIVITY:	0.967
PHANTOM S/NO:	HeadBox02.csv	LIQUID TEMPERATURE:	20.3°C
PHANTOM ROTATION:	0°	MAX SAR X-AXIS LOCATION:	-12.00 mm
DUT POSITION:	Rear facing 15.0mm spacing	MAX SAR Y-AXIS LOCATION:	-34.00 mm
ANTENNA CONFIGURATION:	Fixed Internal	MAX E FIELD:	2.82 V/m
TEST FREQUENCY:	2437.0MHz	SAR 1g:	0.020 W/kg
AIR FACTORS:	345 / 442 / 414	SAR 10g:	0.012 W/kg
CONVERSION FACTORS:	0.457 / 0.457 / 0.457	SAR START:	0.003 W/kg
TYPE OF MODULATION:	DSSS	SAR END:	0.003 W/kg
MODN. DUTY CYCLE:	100%	SAR DRIFT DURING SCAN:	0.00 %
DIODE COMPRESSION FACTORS (V*200):	20 / 20 / 20	PROBE BATTERY LAST CHANGED:	18/08/2006
INPUT POWER LEVEL:	19.24	EXTRAPOLATION:	poly4

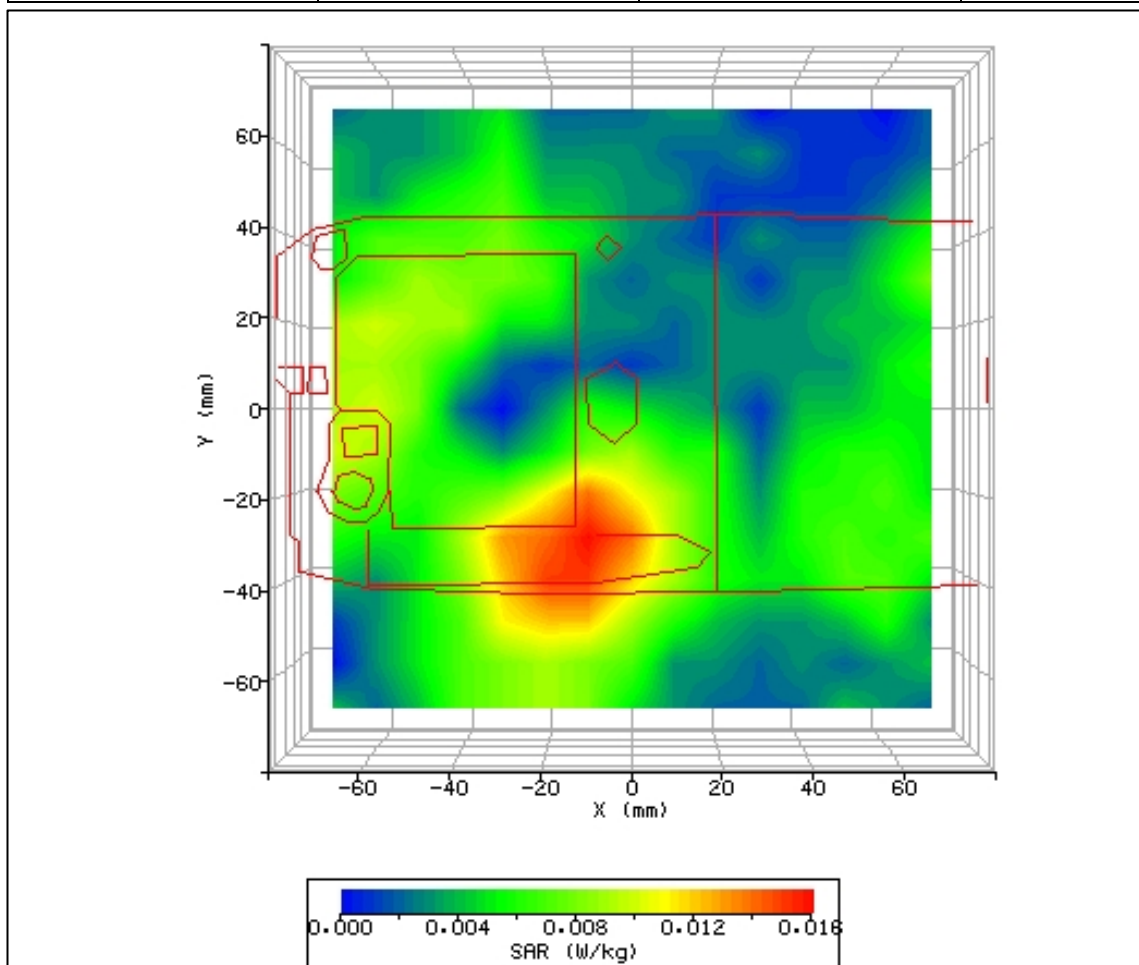

Figure 38: SAR Body WLAN Testing Results for the Intermec CN3 Mobile Computer in Rear Facing Phantom Position; Tested at 2437.0MHz (2450MHz WLAN Middle Channel) with 15.0mm Separation.

2.5.1 2450MHz WLAN BODY SAR TEST RESULT INCLUDING COURSE AREA SCAN – 2D

SYSTEM / SOFTWARE:	SARA2 / 2.39 VPM	INPUT POWER DRIFT:	0.0 dB
DATE / TIME:	18/08/2006 15:03:13	DUT BATTERY MODEL/NO:	318-016-002
FILENAME:	WS615435_F_41.txt	PROBE SERIAL NUMBER:	187
AMBIENT TEMPERATURE:	23.6°C	LIQUID SIMULANT:	2450 Body
DEVICE UNDER TEST:	Intermec CN3	RELATIVE PERMITTIVITY:	53.04
RELATIVE HUMIDITY:	58.4%	CONDUCTIVITY:	0.967
PHANTOM S/NO:	HeadBox02.csv	LIQUID TEMPERATURE:	20.4°C
PHANTOM ROTATION:	0°	MAX SAR X-AXIS LOCATION:	-40.00 mm
DUT POSITION:	Front facing 15.0mm spacing	MAX SAR Y-AXIS LOCATION:	37.00 mm
ANTENNA CONFIGURATION:	Fixed Internal	MAX E FIELD:	5.70 V/m
TEST FREQUENCY:	2412.0MHz	SAR 1g:	0.087 W/kg
AIR FACTORS:	345 / 442 / 414	SAR 10g:	0.050 W/kg
CONVERSION FACTORS:	0.457 / 0.457 / 0.457	SAR START:	0.010 W/kg
TYPE OF MODULATION:	DSSS	SAR END:	0.010 W/kg
MODN. DUTY CYCLE:	100%	SAR DRIFT DURING SCAN:	0.00 %
DIODE COMPRESSION FACTORS (V*200):	20 / 20 / 20	PROBE BATTERY LAST CHANGED:	18/08/2006
INPUT POWER LEVEL:	19.24	EXTRAPOLATION:	poly4

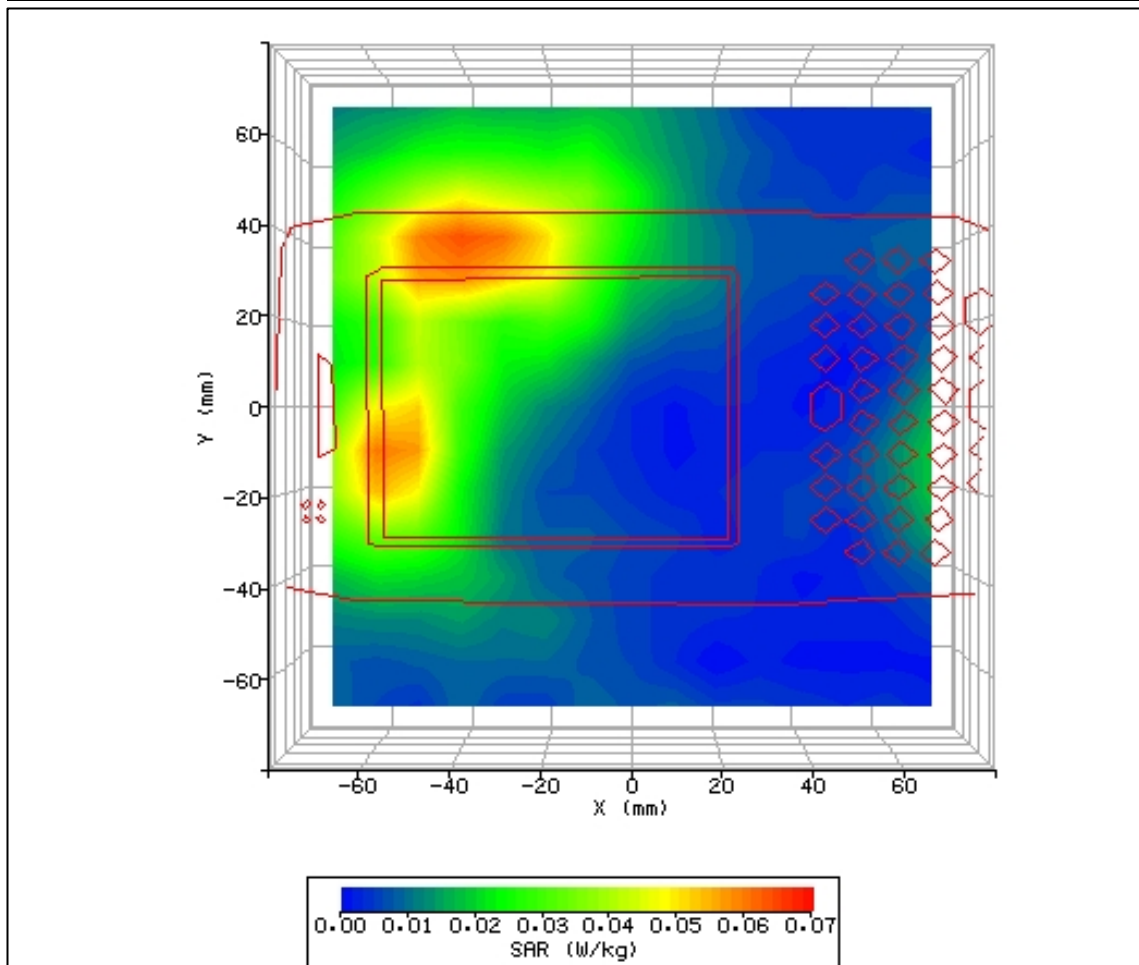

Figure 39: SAR Body WLAN Testing Results for the Intermec CN3 Mobile Computer in Rear Facing Phantom Position; Tested at 2412.0MHz (2450MHz WLAN Bottom Channel) with 15.0mm Separation.

2.5.1 2450MHz WLAN BODY SAR TEST RESULT INCLUDING COURSE AREA SCAN – 2D

SYSTEM / SOFTWARE:	SARA2 / 2.39 VPM	INPUT POWER DRIFT:	0.0 dB
DATE / TIME:	18/08/2006 15:31:32	DUT BATTERY MODEL/NO:	318-016-002
FILENAME:	WS615435_F_42.txt	PROBE SERIAL NUMBER:	187
AMBIENT TEMPERATURE:	22.9°C	LIQUID SIMULANT:	2450 Body
DEVICE UNDER TEST:	Intermec CN3	RELATIVE PERMITTIVITY:	53.04
RELATIVE HUMIDITY:	58.3%	CONDUCTIVITY:	0.967
PHANTOM S/NO:	HeadBox02.csv	LIQUID TEMPERATURE:	20.4°C
PHANTOM ROTATION:	0°	MAX SAR X-AXIS LOCATION:	-37.00 mm
DUT POSITION:	Front facing 15.0mm spacing	MAX SAR Y-AXIS LOCATION:	37.00 mm
ANTENNA CONFIGURATION:	Fixed Internal	MAX E FIELD:	5.20 V/m
TEST FREQUENCY:	2462.0MHz	SAR 1g:	0.073 W/kg
AIR FACTORS:	345 / 442 / 414	SAR 10g:	0.042 W/kg
CONVERSION FACTORS:	0.457 / 0.457 / 0.457	SAR START:	0.008 W/kg
TYPE OF MODULATION:	DSSS	SAR END:	0.008 W/kg
MODN. DUTY CYCLE:	100%	SAR DRIFT DURING SCAN:	0.00 %
DIODE COMPRESSION FACTORS (V*200):	20 / 20 / 20	PROBE BATTERY LAST CHANGED:	18/08/2006
INPUT POWER LEVEL:	19.24	EXTRAPOLATION:	poly4

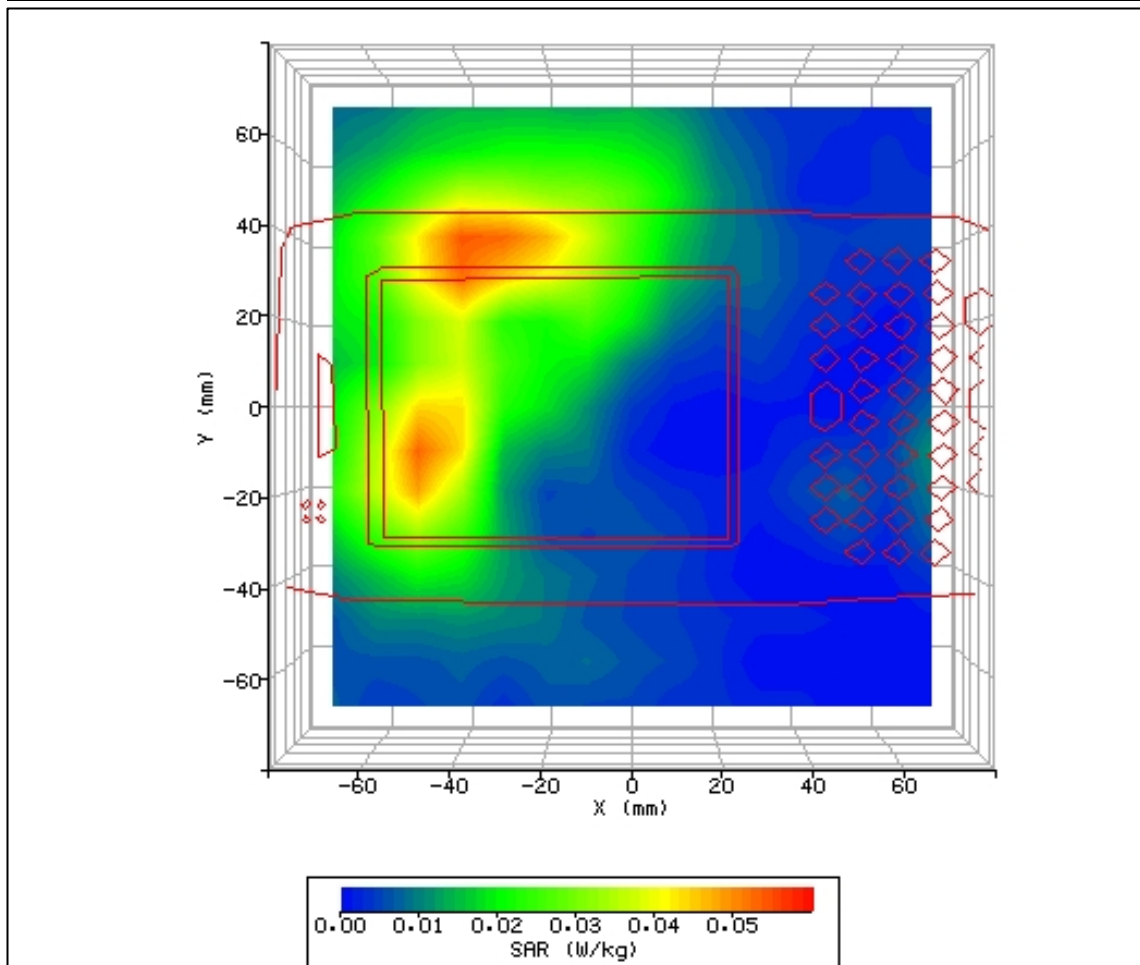

Figure 40: SAR Body WLAN Testing Results for the Intermec CN3 Mobile Computer in Rear Facing Phantom Position; Tested at 2462.0MHz (2450MHz WLAN Top Channel) with 15.0mm Separation.

2.5.2 2450MHz WLAN BODY SAR TEST RESULT INCLUDING COURSE AREA SCAN – 2D

SYSTEM / SOFTWARE:	SARA2 / 2.39 VPM	INPUT POWER DRIFT:	0.0 dB
DATE / TIME:	18/08/2006 16:08:48	DUT BATTERY MODEL/NO:	318-016-002
FILENAME:	WS615435_F_43.txt	PROBE SERIAL NUMBER:	187
AMBIENT TEMPERATURE:	22.9°C	LIQUID SIMULANT:	2450 Body
DEVICE UNDER TEST:	Intermec CN3	RELATIVE PERMITTIVITY:	53.04
RELATIVE HUMIDITY:	57.1%	CONDUCTIVITY:	0.967
PHANTOM S/NO:	HeadBox02.csv	LIQUID TEMPERATURE:	20.4°C
PHANTOM ROTATION:	0°	MAX SAR X-AXIS LOCATION:	-30.00 mm
DUT POSITION:	Front facing in holster @ 0.0mm	MAX SAR Y-AXIS LOCATION:	43.00 mm
ANTENNA CONFIGURATION:	Fixed Internal	MAX E FIELD:	4.64 V/m
TEST FREQUENCY:	2412.0MHz	SAR 1g:	0.057 W/kg
AIR FACTORS:	345 / 442 / 414	SAR 10g:	0.035 W/kg
CONVERSION FACTORS:	0.457 / 0.457 / 0.457	SAR START:	0.008 W/kg
TYPE OF MODULATION:	DSSS	SAR END:	0.008 W/kg
MODN. DUTY CYCLE:	100%	SAR DRIFT DURING SCAN:	0.00 %
DIODE COMPRESSION FACTORS (V*200):	20 / 20 / 20	PROBE BATTERY LAST CHANGED:	18/08/2006
INPUT POWER LEVEL:	19.24	EXTRAPOLATION:	poly4

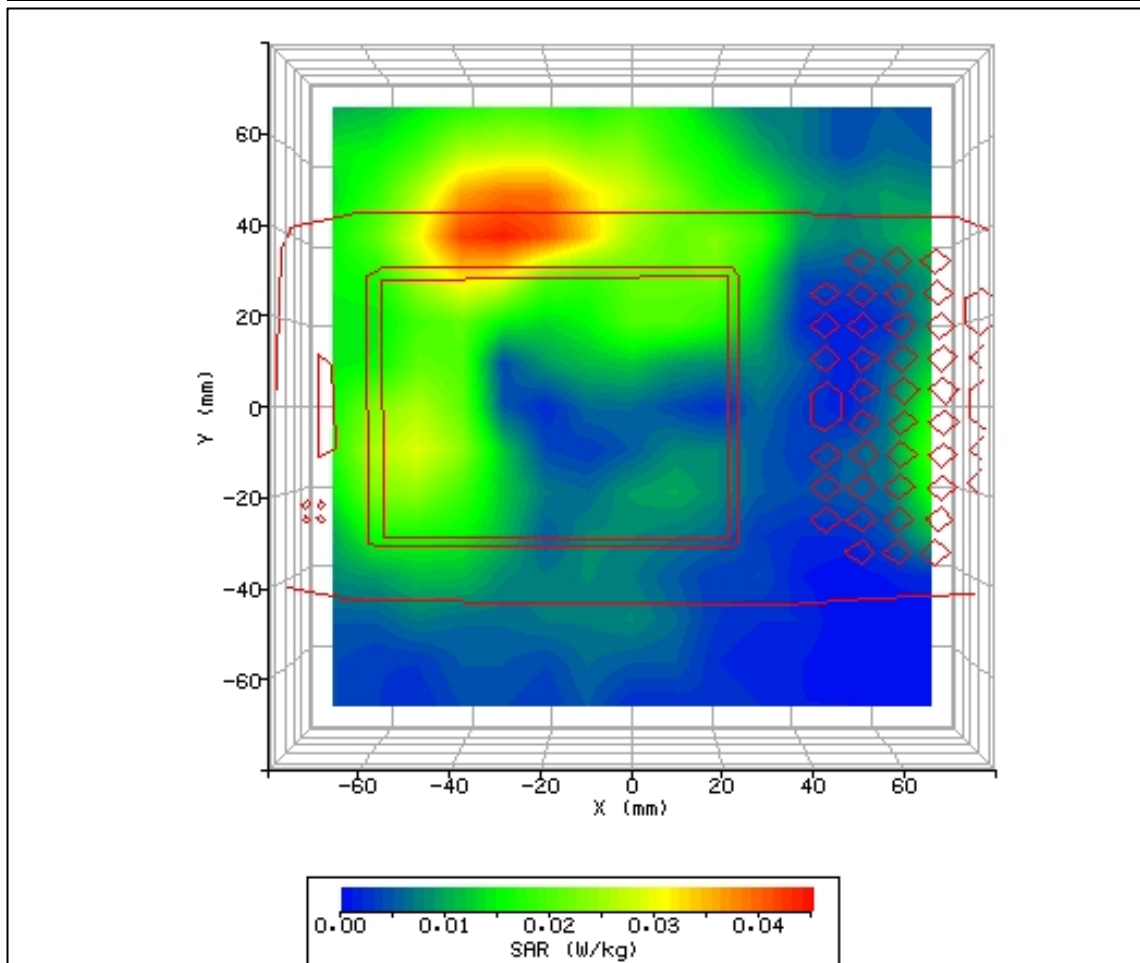

Figure 41: SAR Body GPRS Testing Results for the Intermec CN3 Mobile Computer in Front Facing Phantom Positioned in belt-clip holster; Tested at 2412MHz (2450MHz WLAN Bottom Channel) with 0.0mm Separation.

SECTION 3

TEST EQUIPMENT

3.1 TEST EQUIPMENT

The following test equipment was used at BABT:

INSTRUMENT DESCRIPTION	MANUFACTURER	MODEL TYPE	TEST EQUIPMENT NO.	CALIBRATION DATES	
Bench-top Robot	Mitsubishi	RV-E2	156	N/A	N/A
Fast Probe Amplifier	IndexSAR Ltd.	IFA-010	1557	N/A	N/A
Side Bench 2	IndexSAR Ltd.	IXM-030	1571	N/A	N/A
Upright Bench 1	IndexSAR Ltd.	SARA2 system	1568	N/A	N/A
SAR Probe	IndexSAR Ltd.	IXP-050	S/No 0187	19/05/2006	19/05/2007
Radio Communication Tester	Rohde & Schwarz	CMU 200	3035	11/03/06	11/03/07
Signal Generator	Hewlett Packard	E4422A	61	15/02/2006	22/02/2007
Power Meter	Rohde & Schwarz	NRV	747	03/05/2006	03/05/2007
RF Pre-Amplifier	IndexSAR Ltd.	0.8-3G	2415	N/A	N/A
Bi-Directional Coupler	Krytar	1850	58	N/A	N/A
20dB Attenuator	Weinschel	37-20-34	482	01/02/2006	01/02/2007
Hygrometer	Rotronic	I-1000	2784	15/06/2006	15/06/2007
Digital Thermometer	Digitron	T208	64	18/10/2005	18/10/2006
Thermocouple	Rohde & Schwarz	K	65	18/10/2005	18/10/2006
835MHz Body TEM	BABT	Batch 7	N/A	10/08/2006	25/08/2006
835MHz Head TEM	BABT	Batch 10	N/A	10/08/2006	25/08/2006
1900MHz Head TEM	BABT	Batch 2	N/A	10/08/2006	25/08/2006
1900MHz Body TEM	BABT	Batch 3	N/A	10/08/2006	25/08/2006
907.5 MHz Dipole	IndexSAR Ltd.	IEEE1528	N/A	14/08/2006	21/08/2006
1812 MHz Dipole	IndexSAR Ltd.	IEEE1528	N/A	16/08/2006	23/08/2006
1929 MHz Dipole	IndexSAR Ltd.	IEEE1528	N/A	18/08/2006	25/08/2006
Flat Phantom 2mm Side	IndexSAR Ltd.	HeadBox01	1563	N/A	N/A
200mm Cube Box Phantom	IndexSAR Ltd.	IXB-070	1565	N/A	N/A

3.2 TEST SOFTWARE

The following software was used to control the BABT SARA2 System:

INSTRUMENT	VERSION NO.	DATE
SARA2 system	v.2.39 VPM	06/07/2005
Mitsubishi robot controller firmware revision	RV-E2 Version C9a	-
IFA-10 Probe amplifier	Version 2.5	-

3.3 DIELECTRIC PROPERTIES OF SIMULANT LIQUIDS

The fluid properties of the simulant fluids used during routine SAR evaluation meet the dielectric properties required by EN50361:2001 & OET Bulletin 65 (Edition 97-01).

The fluids were calibrated in our Laboratory and re-checked prior to any measurements being made against reference fluids stated in IEEE 1528-2003 of 0.9% NaCl (Salt Solution) at 23°C and also for Dimethylsulphoxide (DMS) at 21°C.

The fluids were made at BABT under controlled conditions from the following OET(65)c formulae and IEEE1528-2003. The composition of ingredients may have been modified accordingly to achieve the desired target tissue parameters required for routine SAR evaluation:

OET 65(c) Recipes

Ingredients (% by weight)	Frequency (MHz)									
	450		835		915		1900		2450	
Tissue Type	Head	Body	Head	Body	Head	Body	Head	Body	Head	Body
Water	38.56	51.16	41.45	52.4	41.05	56.0	54.9	40.4	62.7	73.2
Salt (NaCl)	3.95	1.49	1.45	1.4	1.35	0.76	0.18	0.5	0.5	0.04
Sugar	56.32	46.78	56.0	45.0	56.5	41.76	0.0	58.0	0.0	0.0
HEC	0.98	0.52	1.0	1.0	1.0	1.21	0.0	1.0	0.0	0.0
Bactericide	0.19	0.05	0.1	0.1	0.1	0.27	0.0	0.1	0.0	0.0
Triton X-100	0.0	0.0	0.0	0.0	0.0	0.0	0.0	0.0	36.8	0.0
DGBE	0.0	0.0	0.0	0.0	0.0	0.0	44.92	0.0	0.0	26.7
Dielectric Constant	43.42	58.0	42.54	56.1	42.0	56.8	39.9	54.0	39.8	52.5
Conductivity (S/m)	0.85	0.83	0.91	0.95	1.0	1.07	1.42	1.45	1.88	1.78

IEEE 1528 Recipes

Frequency (MHz)	300	450	835	900			1450	1800				1900	1950	2000	2100		2450			3000	
Recipe #	1	1	3	1	1	2	3	1	1	2	2	3	1	2	4	1	1	2	2	3	1
Ingredients (% by weight)																					
1,2-Propanediol							64.81														
Bactericide	0.19	0.19	0.5	0.1	0.1		0.5				0.5										0.5
Diacetin			48.9				49.2				49.43										49.75
DGBE								45.41	47	13.84	44.92		44.92	13.84	45	50	50	7.99	7.99		7.99
HEC	0.98	0.98		1	1																
NaCl	5.95	3.95	1.7	1.45	1.48	0.79	1.1	0.67	0.36	0.35	0.18	0.64	0.18	0.35					0.16	0.16	0.16
Sucrose	55.32	56.32		57	56.5																
Triton X-100											30.45									19.97	19.97
Water	37.56	38.56	48.9	40.45	40.92	34.4	49.2	53.82	52.64	55.36	54.9	49.43	54.9	55.36	55	50	50	71.88	71.88	49.75	71.88
Measured dielectric parameters																					
ϵ'	46	43.4	44.3	41.6	41.2	41.8	42.7	40.9	39.3	41	40.4	39.2	39.9	41	40.1	37	36.8	41.1	40.3	39.2	37.9
σ (S/m)	0.86	0.85	0.9	0.9	0.98	0.97	0.99	1.21	1.39	1.38	1.4	1.4	1.42	1.38	1.41	1.4	1.51	1.55	1.88	1.82	2.46
Temp. (°C)	22	22	20	22	22	22	20	22	22	21	22	20	21	21	20	22	22	20	20	20	20
Target dielectric parameters (Table 5-1)																					
ϵ'	45.3	43.5	41.5	41.5			40.5	40				39.8			39.2	38.5					
σ (S/m)	0.87	0.87	0.9	0.97			1.2	1.4				1.49			1.8	2.4					

3.3 DIELECTRIC PROPERTIES OF SIMULANT LIQUIDS

The dielectric properties of the tissue simulant liquids used for the SAR testing at BABT are as follows:-

FLUID TYPE	FREQUENCY	RELATIVE PERMITTIVITY ϵ_r (e') TARGET	RELATIVE PERMITTIVITY ϵ_r (e') MEASURED	CONDUCTIVITY σ TARGET	CONDUCTIVITY σ MEASURED
Head	835 MHz	41.5	42.54	0.90	0.919
Body	835 MHz	55.0	56.86	1.05	0.967
Head	1900 MHz	40.0	39.83	1.40	1.431
Body	1900 MHz	53.3	53.48	1.52	1.532
Head	2450 MHz	39.2	38.81	1.80	1.834
Body	2450 MHz	52.7	53.04	1.95	2.057

3.4 TEST CONDITIONS

TEST LABORATORY CONDITIONS

Ambient Temperature: Within +15°C to +35°C at 20% RH to 75% RH.
 The actual Temperature during the testing ranged from 21.5°C to 23.6 °C.
 The actual Humidity during the testing ranged from 42.9% to 66.1% RH.

TEST FLUID TEMPERATURE RANGE

FREQUENCY (MHz)	835	835	1900	1900	2450	2450
BODY / HEAD FLUID	Head	Body	Head	Body	Head	Body
MIN TEMPERATURE (°C)	21.5	20.6	21.1	21.4	22.2	20.3
MAX TEMPERATURE (°C)	21.8	20.8	21.8	21.7	22.2	20.4

SAR DRIFT

The SAR Drift was within acceptable limits during scans. The maximum SAR Drift, drift due to the handset electronics, was recorded as 6.13% (0.260dB) for all of the testing. The value of 6.13% has been included in the measurement uncertainty budget.

3.5 MEASUREMENT UNCERTAINTY

ERROR SOURCES	EN 50361 Description (Subclause)	Uncertainty (%)	Probability Distribution	Divisor	ci	ci ²	Standard Uncertainty (%)	Stand Uncert ²	(Stand Uncert ²) X (ci ²)	
Measurement Equipment										
Calibration	7.2.1.1	10	Normal	2.00	1	1	5.00	25.00	25.00	
Isotropy	7.2.1.2	10.6	Rectangular	1.73	1	1	6.12	37.45	37.45	
Linearity	7.2.1.3	2.92	Rectangular	1.73	1	1	1.69	2.84	2.84	
Probe Stability	-	2.46	Rectangular	1.73	1	1	1.42	2.02	2.02	
Detection limits	7.2.1.4	0	Rectangular	1.73	1	1	0.00	0.00	0.00	
Boundary effect	7.2.1.5	1.7	Rectangular	1.73	1	1	0.98	0.96	0.96	
Measurement device	7.2.1.6	0	Normal	1.00	1	1	0.00	0.00	0.00	
Response time	7.2.1.7	0	Normal	1.00	1	1	0.00	0.00	0.00	
Noise	7.2.1.8	0	Normal	1.00	1	1	0.00	0.00	0.00	
Integration time	7.2.1.9	2.3	Normal	1.00	1	1	2.30	5.29	5.29	
Mechanical constraints										
Scanning system	7.2.2.1	0.57	Rectangular	1.73	1	1	0.33	0.11	0.11	
Phantom shell	7.2.2.2	1.43	Rectangular	1.73	1	1	0.83	0.68	0.68	
Matching between probe and phantom	7.2.2.3	2.86	Rectangular	1.73	1	1	1.65	2.73	2.73	
Positioning of the phone 'Y' Co-ordinate	7.2.2.4	1.5	Normal	1.00	1	1	1.50	2.25	2.25	
Positioning of the phone 'Z' Co-ordinate	7.2.2.4	1.73	Normal	1.00	1	1	1.73	2.99	2.99	
Physical Parameters										
Liquid conductivity (deviation from target)	7.2.3.2	5	Rectangular	1.73	0.5	0.25	2.89	8.33	2.08	
Liquid conductivity (measurement error)	7.2.3.2	15.3	Rectangular	1.73	0.5	0.25	8.83	78.03	19.51	
Liquid permittivity (deviation from target)	7.2.3.3	5	Rectangular	1.73	0.5	0.25	2.89	8.33	2.08	
Liquid permittivity (measurement error)	7.2.3.3	5	Rectangular	1.73	0.5	0.25	2.89	8.33	2.08	
Drifts in output power of the phone, probe, temperature and humidity	7.2.3.4	6.13	Rectangular	1.73	1	1	3.54	12.53	12.53	
Perturbation by the environment	7.2.3.5	3	Rectangular	1.73	1	1	1.73	3.00	3.00	
Post-Processing										
SAR interpolation and extrapolation	7.2.4.1	2.4	Rectangular	1.73	1	1	1.39	1.92	1.92	
Maximum SAR evaluation	7.2.4.2	2.4	Rectangular	1.73	1	1	1.39	1.92	1.92	
Combined standard uncertainty	11.29						Total	127.45		
Expanded uncertainty = 22.58 % (Using a Coverage Factor of K=2) (confidence interval of 95 %)										

SECTION 4

PHOTOGRAPHS

4.1 TEST POSITIONAL PHOTOGRAPHS

OET65(c) HEAD PHANTOM TEST POSITIONS

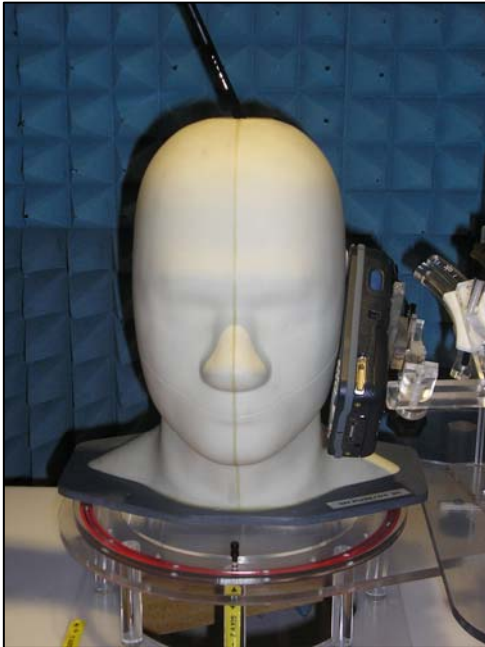

Figure 42. Positional photograph of the Intermec CN3
Left Hand Cheek Touch Position



Figure 43. Positional photograph of the Intermec CN3
Left Hand Cheek 15° Position



Figure 44. Positional photograph of the Intermec CN3
Right Hand Cheek Touch Position



Figure 45. Positional photograph of the Intermec CN3
Right Hand Cheek 15° Position

4.1 TEST POSITIONAL PHOTOGRAPHS

OET65(c) FLAT PHANTOM TEST POSITIONS



Figure 46. Positional photograph of the Interdec CN3 0.0mm front facing position.



Figure 47. Positional photograph of the Interdec CN3 0.0mm rear facing position.



Figure 48. Positional photograph of the Interdec CN3 15.0mm front facing position.



Figure 49. Positional photograph of the Interdec CN3 15.0mm rear facing position.

4.1 TEST POSITIONAL PHOTOGRAPHS - Continued

OET65(c) FLAT PHANTOM TEST POSITIONS



Figure 50. Positional photograph of the Intermec CN3 0.0mm front facing position in holster.



Figure 51. Positional photograph of the Intermec CN3 0.0mm rear facing position in holster.

4.2 PHOTOGRAPHS OF EQUIPMENT UNDER TEST (EUT)



Figure 52 Front View of the Intermec CN3



Figure 53: Rear View of the Intermec CN3

4.2 PHOTOGRAPHS OF EQUIPMENT UNDER TEST (EUT) - Continued



Figure 54: Rear View of the Intermec CN3 – Battery removed.



Figure 55: Front View of the Intermec CN3 Holster.

4.2 PHOTOGRAPHS OF EQUIPMENT UNDER TEST (EUT) - Continued

Figure 56: Rear View of the Intermec CN3 Holster.

SECTION 5

ACCREDITATION, DISCLAIMERS AND COPYRIGHT

5.1 ACCREDITATION, DISCLAIMERS AND COPYRIGHT

This report relates only to the actual item/items tested.

This report must not be reproduced, except in its entirety, without the written permission of
TUV Product Service Limited

© 2006 TUV Product Service Limited

ANNEX A

PROBE 187 (TYPE IXP-050) CALIBRATION INFORMATION



IMMERSIBLE SAR PROBE

CALIBRATION REPORT

Part Number: IXP – 050

S/N 0187

May 2006

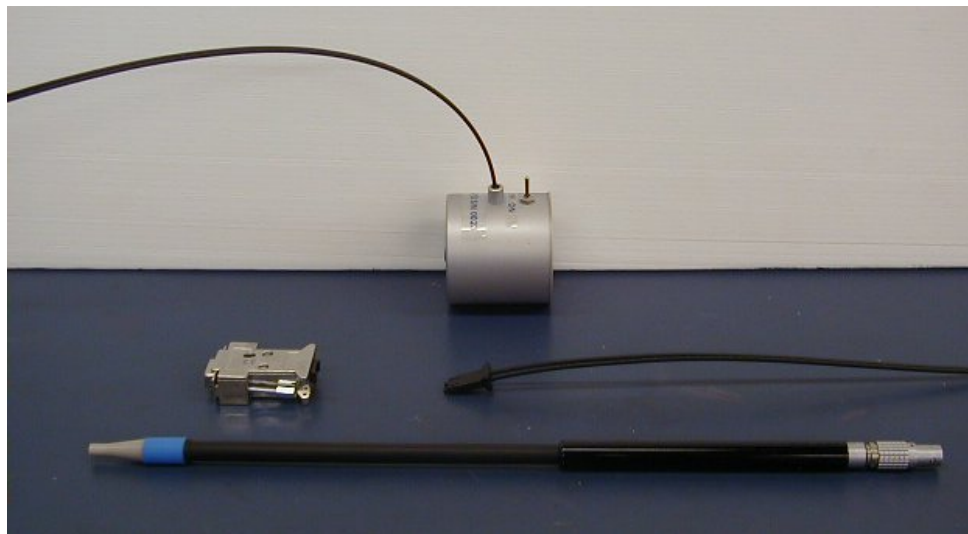

IndexSAR Limited
Oakfield House
Cudworth Lane
Newdigate
Surrey RH5 5BG
Tel: +44 (0) 1306 632 870
Fax: +44 (0) 1306 631 834
e-mail: enquiries@indexsar.com

INTRODUCTION

This Report presents measured calibration data for a particular IndexSAR SAR probe (S/N 0187) and describes the procedures used for characterisation and calibration.

IndexSAR probes are characterised using procedures that, where applicable, follow the recommendations of CENELEC [1] and IEEE [2] standards. The procedures incorporate techniques for probe linearisation, isotropy assessment and determination of liquid factors (conversion factors). Calibrations are determined by comparing probe readings with analytical computations in canonical test geometries (waveguides) using normalised power inputs.

Each step of the calibration procedure and the equipment used is described in the sections below.

CALIBRATION PROCEDURE

1. Objectives

The calibration process comprises three stages

- 1) Determination of the channel sensitivity factors which optimise the probe's overall rotational isotropy in 1800MHz brain fluid
- 2) At each frequency of interest, application of these channel sensitivity factors to model the exponential decay of SAR in a waveguide fluid cell, and hence derive the liquid conversion factors at that frequency
- 3) Determination of the effective tip radius and angular offset of the X channel which together optimise the probe's spherical isotropy in 900MHz brain fluid

2. Probe Output

The probe channel output signals are linearised in the manner set out in Refs [1] and [2]. The following equation is utilized for each channel:

$$U_{lin} = U_{o/p} + U_{o/p}^2 / DCP \quad (1)$$

where U_{lin} is the linearised signal, $U_{o/p}$ is the raw output signal in voltage units and DCP is the diode compression potential in similar voltage units.

DCP is determined from fitting equation (1) to measurements of U_{lin} versus source feed power over the full dynamic range of the probe. The DCP is a characteristic of the Schottky diodes used as the sensors. For the IXP-050 probes with CW signals the DCP values are typically 0.10V (or 20 in the voltage units used by IndexSAR software, which are V*200).

In turn, measurements of E-field are determined using the following equation (where output voltages are also in units of V*200):

$$\begin{aligned} E_{liq}^2 \text{ (V/m)} = & U_{linx} * \text{Air Factor}_x * \text{Liq Factor}_x \\ & + U_{liny} * \text{Air Factor}_y * \text{Liq Factor}_y \\ & + U_{linz} * \text{Air Factor}_z * \text{Liq Factor}_z \end{aligned} \quad (3)$$

Here, "Air Factor" represents each channel's sensitivity, while "Liq Factor" represents the enhancement in signal level when the probe is immersed in tissue-simulant liquids at each frequency of interest.

CALIBRATION PROCEDURE - Continued

3. Selecting Channel Sensitivity Factors To Optimise Isotropic Response

After manufacture, the first stage of the calibration process is to balance the three channels' Air Factor values, thereby optimising the probe's overall axial response ("rotational isotropy").

To do this, an 1800MHz waveguide containing head-fluid simulant is selected. Like all waveguides used during probe calibration, this particular waveguide contains two distinct sections: an air-filled launcher section, and a liquid cell section, separated by a dielectric matching window designed to minimise reflections at the air-liquid interface.

The waveguide stands in an upright position and the liquid cell section is filled with 1800MHz brain fluid to within 10 mm of the open end. The depth of liquid ensures there is negligible radiation from the waveguide open top and that the probe calibration is not influenced by reflections from nearby objects.

During the measurement, a TE_{01} mode is launched into the waveguide by means of an N-type-to-waveguide adapter. The probe is then lowered vertically into the liquid until the tip is exactly 10mm above the centre of the dielectric window. This particular separation ensures that the probe is operating in a part of the waveguide where boundary corrections are not necessary.

Care must also be taken that the probe tip is centred while rotating.

The exact power applied to the input of the waveguide during this stage of the probe calibration is immaterial since only relative values are of interest while the probe rotates. However, the power must be sufficiently above the noise floor and free from drift.

The dedicated IndexSAR calibration software rotates the probe in 10 degree steps about its axis, and at each position, an IndexSAR 'Fast' amplifier samples the probe channels 500 times per second for 0.4 s. The raw $U_{o/p}$ data from each sample are packed into 10 bytes and transmitted back to the PC controller via an optical cable. U_{linx} , U_{liny} and U_{linz} are derived from the raw $U_{o/p}$ values and written to an Excel template.

Once data have been collected from a full probe rotation, the Air Factors are adjusted using a special Excel Solver routine to equalise the output from each channel and hence minimise the rotational isotropy. This automated approach to optimisation removes the effect of human bias.

Figure 5 represents the output from each diode sensor as a function of probe rotation angle. The directionality of the orthogonally-arranged sensors can be checked by analysing the data using dedicated IndexSAR software, which displays the data in 3D format, a representative image of which is shown in Figure 3. The left-hand side of this diagram shows the individual channel outputs after linearisation (see above). The program uses these data to balance the channel outputs and then applies an optimisation process, which makes fine adjustments to the channel factors for optimum isotropic response.

CALIBRATION PROCEDURE - Continued

4. Determination Of Conversion (“Liquid”) Factors At Each Frequency Of Interest

A lookup table of conversion factors for a probe allows a SAR value to be derived at the measured frequencies, and for either brain or body fluid-simulant.

The method by which the conversion factors are assessed is based on the comparison between measured and analytical rates of decay of SAR with height above a dielectric window. This way, not only can the conversion factors for that frequency/fluid combination be determined, but an allowance can also be made for the scale and range of boundary layer effects.

The theoretical relationship between the SAR at the cross-sectional centre of the lossy waveguide as a function of the longitudinal distance (z) from the dielectric separator is given by Equation 4:

$$SAR(z) = \frac{4(P_f - P_b)}{\rho ab\delta} e^{-2z/\delta} \quad (4)$$

Here, the density ρ is conventionally assumed to be 1000 kg/m^3 , ab is the cross-sectional area of the waveguide, and P_f and P_b are the forward and reflected power inside the lossless section of the waveguide, respectively. The penetration depth δ (which is the reciprocal of the waveguide-mode attenuation coefficient) is a property of the lossy liquid and is given by Equation (5).

$$\delta = \left[\text{Re} \left\{ \sqrt{(\pi/a)^2 + j\omega\mu_o(\sigma + j\omega\epsilon_o\epsilon_r)} \right\} \right]^{-1} \quad (5)$$

where σ is the conductivity of the tissue-simulant liquid in S/m, ϵ_r is its relative permittivity, and ω is the radial frequency (rad/s). Values for σ and ϵ_r are obtained prior to each waveguide test using an IndexSAR DiLine measurement kit, which uses the TEM method as recommended in [2]. σ and ϵ_r are both temperature- and fluid-dependent, so are best measured using a sample of the tissue-simulant fluid immediately prior to the actual calibration.

Wherever possible, all DiLine and calibration measurements should be made in the open laboratory at $22 \pm 2.0^\circ\text{C}$; if this is not possible, the values of σ and ϵ_r should reflect the actual temperature. Values employed for calibration are listed in the tables below.

By ensuring the liquid height in the waveguide is at least three penetration depths, reflections at the upper surface of the liquid are negligible. The power absorbed in the liquid is therefore determined solely from the waveguide forward and reflected power.

Different waveguides are used for 835/900MHz, 1800/1900MHz, 2450MHz and 5200/5800MHz measurements. Table A.1 of [1] can be used for designing calibration waveguides with a return loss greater than 20 dB at the most important frequencies used for personal wireless communications, and better than 15dB for frequencies

CALIBRATION PROCEDURE - Continued

4. Determination Of Conversion (“Liquid”) Factors At Each Frequency Of Interest - Continued

greater than 5GHz. Values for the penetration depth for these specific fixtures and tissue-simulating mixtures are also listed in Table A.1.

According to [1], this calibration technique provides excellent accuracy, with standard uncertainty of less than 3.6% depending on the frequency and medium. The calibration itself is reduced to power measurements traceable to a standard calibration procedure. The practical limitation to the frequency band of 800 to 5800 MHz because of the waveguide size is not severe in the context of compliance testing.

During calibration, the probe is lowered carefully until it is just touching the cross-sectional centre of the dielectric window. 200 samples are then taken and written to an Excel template file before moving the probe vertically upwards. This cycle is repeated 50 times. The vertical separation between readings is determined from practical considerations of the expected SAR decay rate, and range from 1mm steps at low frequency, through 0.5mm at 2450MHz, down to 0.2mm at 5GHz.

Once the data collection is complete, a Solver routine is run which optimises the measured-theoretical fit by varying the conversion factor, and the boundary correction size and range.

5. Measurement of Spherical Isotropy

The setup for measuring the probe’s spherical isotropy is shown in Figure 2.

A box phantom containing 900MHz head fluid is irradiated by a vertically-polarised, tuned dipole, mounted to the side of the phantom on the robot’s seventh axis. During calibration, the spherical response is generated by rotating the probe about its axis in 20 degree steps and changing the dipole polarisation in 10 degree steps.

By using the VPM technique discussed below, an allowance can also be made for the effect of E-field gradient across the probe’s spatial extent. This permits values for the probe’s effective tip radius and X-channel angular offset to be modelled until the overall spherical isotropy figure is optimised.

The dipole is connected to a signal generator and amplifier via a directional coupler and power meter. As with the determination of rotational isotropy, the absolute power level is not important as long as it is stable.

The probe is positioned within the fluid so that its sensors are at the same vertical height as the centre of the source dipole. The line joining probe to dipole should be perpendicular to the phantom wall, while the horizontal separation between the two should be small enough for VPM corrections to be applicable, without encroaching near the boundary layer of the phantom wall. VPM corrections require a knowledge of the fluid skin depth. This is measured during the calibration by recording the E-field strength while systematically moving the probe away from the dipole in 2mm steps over a 20mm range.

VPM (Virtual Probe Miniaturisation)

SAR probes with 3 diode-sensors in an orthogonal arrangement are designed to display an isotropic response when exposed to a uniform field. However, the probes are ordinarily used for measurements in non-uniform fields and isotropy is not

CALIBRATION PROCEDURE – Continued

5. Measurement of Spherical Isotropy - Continued

assured when the field gradients are significant compared to the dimensions of the tip containing the three orthogonally-arranged dipole sensors.

It becomes increasingly important to assess the effects of field gradients on SAR probe readings when higher frequencies are being used. For IndexSAR IXP-050 probes, which are of 5mm tip diameter, field gradient effects are minor at GSM frequencies, but are major above 5GHz. Smaller probes are less affected by field gradients and so probes, which are significantly less than 5mm diameter, would be better for applications above 5GHz.

The IndexSAR report IXS0223 describes theoretical and experimental studies to evaluate the issues associated with the use of probes at arbitrary angles to surfaces and field directions. Based upon these studies, the procedures and uncertainty analyses referred to in P1528 are addressed for the full range of probe presentation angles.

In addition, generalized procedures for correcting for the finite size of immersible SAR probes are developed. Use of these procedures enables application of schemes for virtual probe miniaturization (VPM) – allowing probes of a specific size to be used where physically-smaller probes would otherwise be required.

Given the typical dimensions of 3-channel SAR probes presently available, use of the VPM technique extends the satisfactory measurement range to higher frequencies.

CALIBRATION FACTORS MEASURED FOR PROBE S/N 0170

The probe was calibrated at 450, 835, 900, 1800, 1900 and 2450 MHz in liquid samples representing both brain liquid and body fluid at these frequencies. The calibration was for CW signals only, and the axis of the probe was parallel to the direction of propagation of the incident field i.e. end-on to the incident radiation. The axial isotropy of the probe was measured by rotating the probe about its axis in 10 degree steps through 360 degrees in this orientation.

The reference point for the calibration is in the centre of the probe's cross-section at a distance of 2.7 mm from the probe tip in the direction of the probe amplifier. A value of 2.7 mm should be used for the tip to sensor offset distance in the software. The distance of 2.7mm for assembled probes has been confirmed by taking X-ray images of the probe tips (see Figure 8).

It is important that the diode compression point and air factors used in the software are the same as those quoted in the results tables, as these are used to convert the diode output voltages to a SAR value.

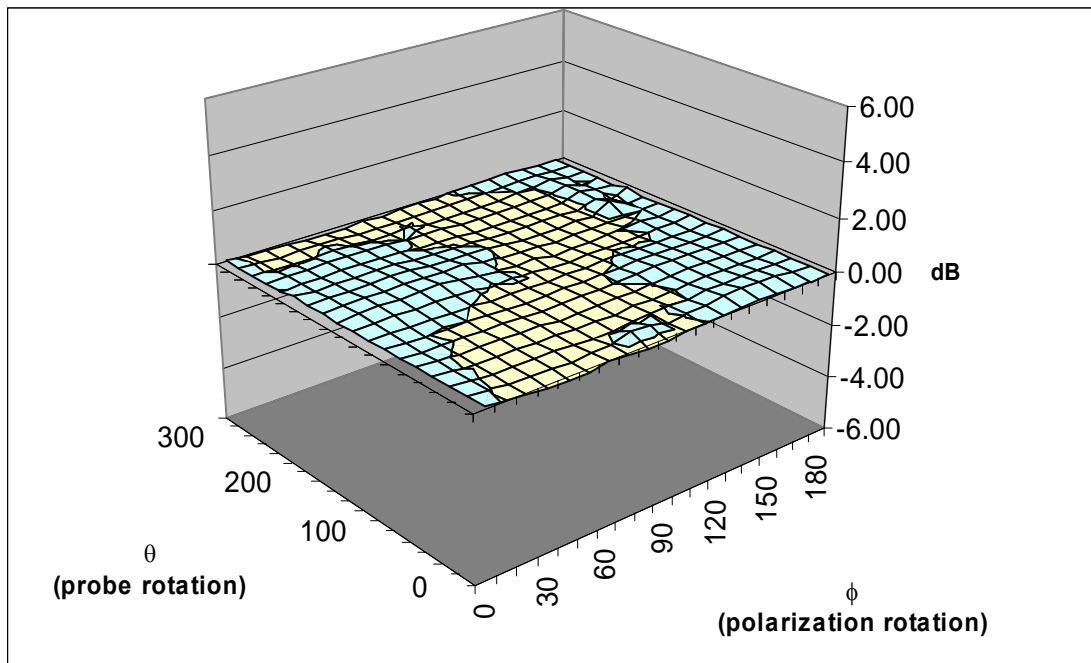

Surface Isotropy diagram of IXP-050 Probe S/N 0187 at 900MHz after VPM
(rotational isotropy at side +/-0.05dB, spherical isotropy +/-0.23dB)

Probe tip radius	1.25
X Ch. Angle to red dot	5

CALIBRATION FACTORS MEASURED FOR PROBE S/N 0170 - Continued

Frequency	Head		Body	
	Bdy. Corr. - f(0)	Bdy. Corr. - d(mm)	Bdy. Corr. - f(0)	Bdy. Corr. - d(mm)
450	-	-	-	-
835	1.07	1.3	1.26	1.2
900	1.15	1.2	1.37	1.2
1800	0.96	1.3	0.78	1.6
1900	0.88	1.4	0.73	1.7
2100	0.88	1.4	0.74	1.6
2450	0.79	1.5	0.48	2.1

SUMMARY OF CALIBRATION FACTORS FOR PROBE IXP-050 S/N 0187

Spherical isotropy measured at 900MHz	0.23	(+/-) dB
---------------------------------------	------	----------

	X	Y	Z	
Air Factors	345	442	414	(V*200)
CW DCPs	20	20	20	(V*200)

Freq (MHz)	Axial Isotropy (+/- dB)		SAR ConvF (liq/air)		Notes
	Head	Body	Head	Body	
	450	-	-	0.340	
835	-	-	0.312	0.307	1,2
900	0.05	-	0.314	0.307	1,2
1800	-	-	0.375	0.407	1,2
1900	-	-	0.382	0.420	1,2
2000	-	-	0.390	0.452	1,2
2450	-	-	0.397	0.457	1,2

Notes	
1)	Calibrations done at 22°C +/-2°C
2)	Waveguide calibration

PROBE SPECIFICATIONS

IndexSAR probe 0187, along with its calibration, is compared with CENELEC and IEEE standards recommendations (Refs [1] and [2]) in the Tables below. A listing of relevant specifications is contained in the tables below:

Dimensions	S/N 0171	CENELEC [1]	IEEE [2]
Overall length (mm)	350		
Tip length (mm)	10		
Body diameter (mm)	12		
Tip diameter (mm)	5.2	8	8
Distance from probe tip to dipole centers (mm)	2.7		

Dynamic range	S/N 0171	CENELEC [1]	IEEE [2]
Minimum (W/kg)	0.01	<0.02	0.01
Maximum (W/kg) N.B. only measured to > 100 W/kg on representative probes	>100	>100	100

Isotropy (measured at 900MHz)	S/N 0187	CENELEC [1]	IEEE [2]
Axial rotation with probe normal to source (+/- dB)	0.05 Max (See table above)	0.5	0.25
Spherical isotropy covering all orientations to source (+/- dB)	0.23	1.0	0.50

Construction	Each probe contains three orthogonal dipole sensors arranged on a triangular prism core, protected against static charges by built-in shielding, and covered at the tip by PEEK cylindrical enclosure material. No adhesives are used in the immersed section. Outer case materials are PEEK and heat-shrink sleeving.
Chemical resistance	Tested to be resistant to glycol and alcohol containing simulant liquids but probes should be removed, cleaned and dried when not in use.

REFERENCES

[1] CENELEC, EN 50361, July 2001. Basic Standard for the measurement of specific absorption rate related to human exposure to electromagnetic fields from mobile phones.

[2] IEEE 1528, Recommended practice for determining the spatial-peak specific absorption rate (SAR) in the human body due to wireless communications devices: Experimental techniques.

FIGURES

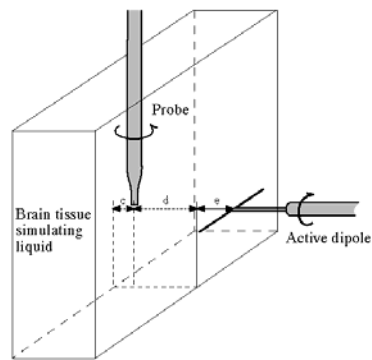

Figure 1. Spherical isotropy jig showing probe, dipole and box filled with simulated brain liquid (see Ref [2], Section A.5.2.1)

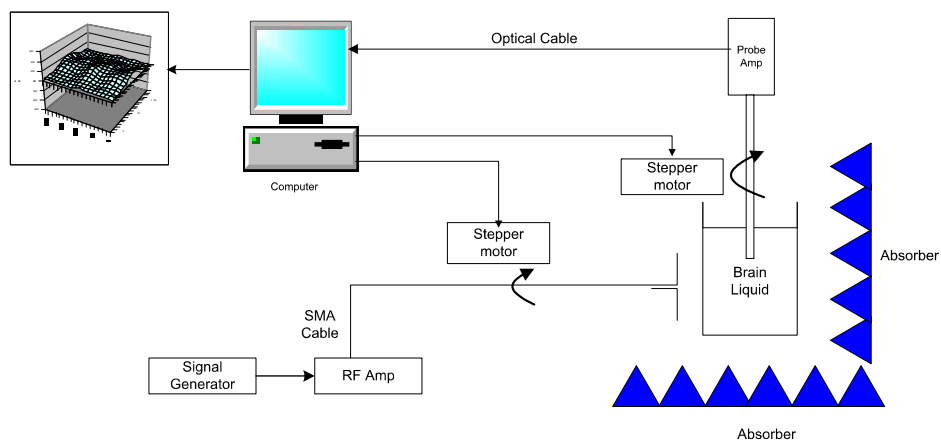

Figure 2. Schematic diagram of the test geometry used for isotropy determination

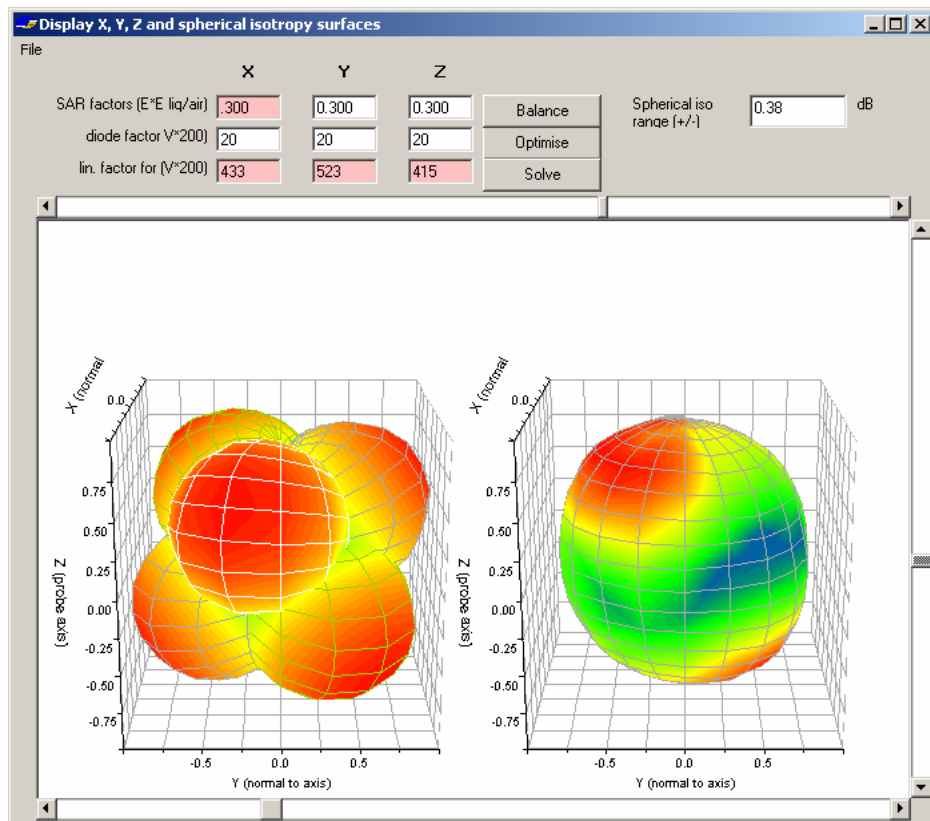

Figure 3. Graphical representation of a probe's response to fields applied from each direction. The diagram on the left shows the individual response characteristics of each of the three channels and the diagram on the right shows the resulting probe sensitivity in each direction. The colour range in the figure images the lowest values as blue and the maximum values as red. For the probe S/N 0187, this range is (+/-) 0.23 dB.

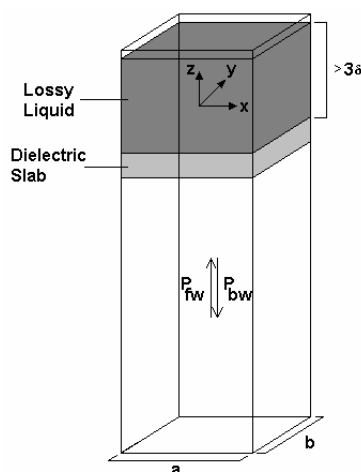

Figure 4. Geometry used for waveguide calibration (after Ref [2]. Section A.3.2.2)

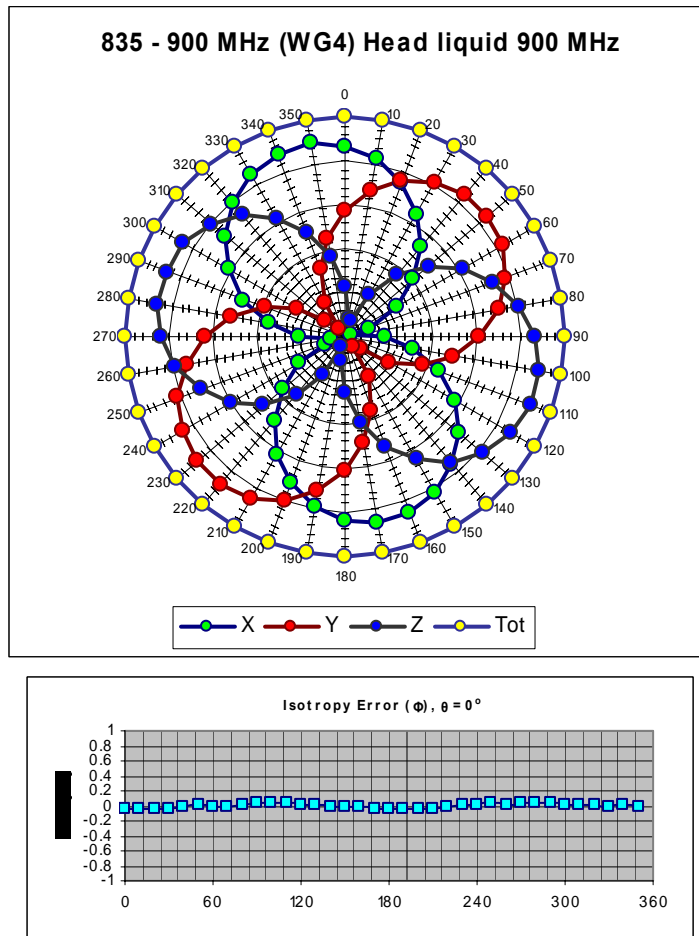

Figure 5. The rotational isotropy of probe S/N 0187 obtained by rotating the probe in a liquid-filled waveguide at 900 MHz.

SAR DECAY FUNCTION – Analytical and Measurements

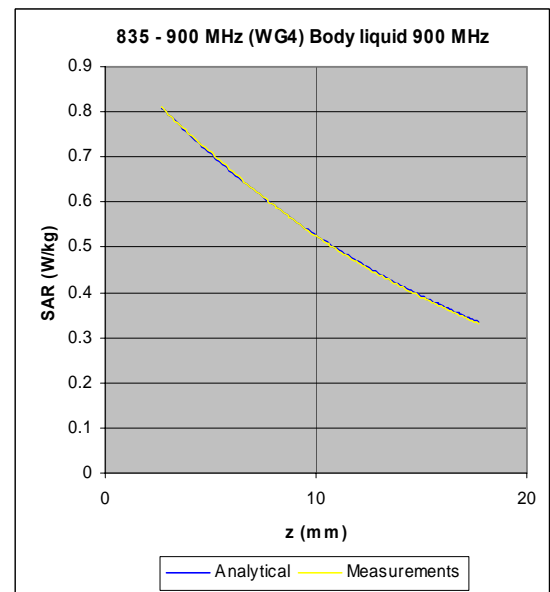
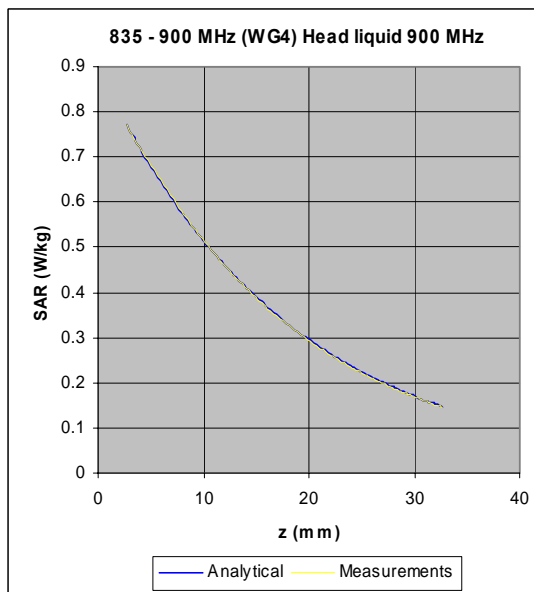
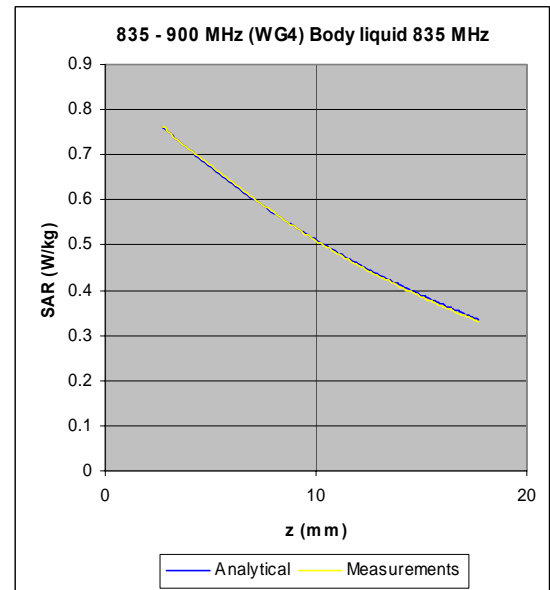
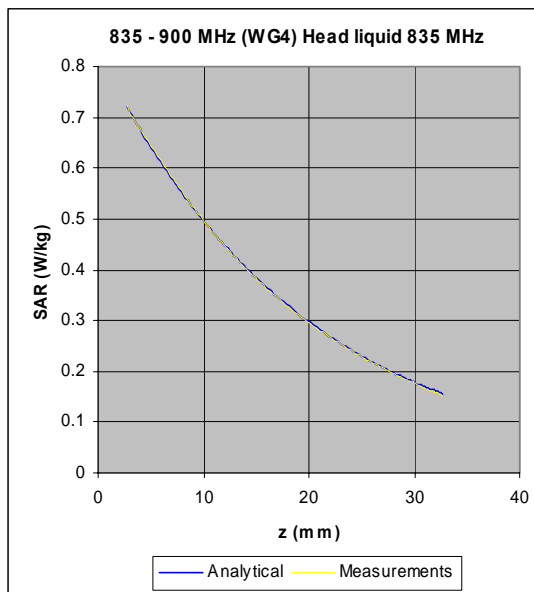

Figure 6a. The measured SAR decay function along the centreline of the WG4 waveguide with conversion factors adjusted to fit to the theoretical function for the particular dimension, frequency, power and liquid properties employed.

SAR DECAY FUNCTION – Analytical and Measurements - Continued

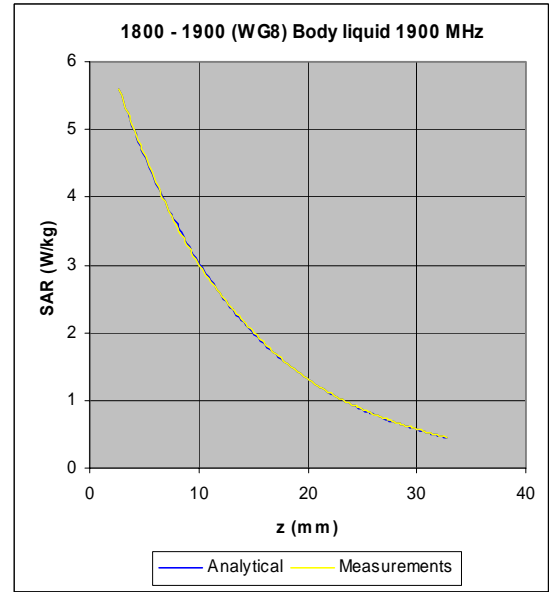
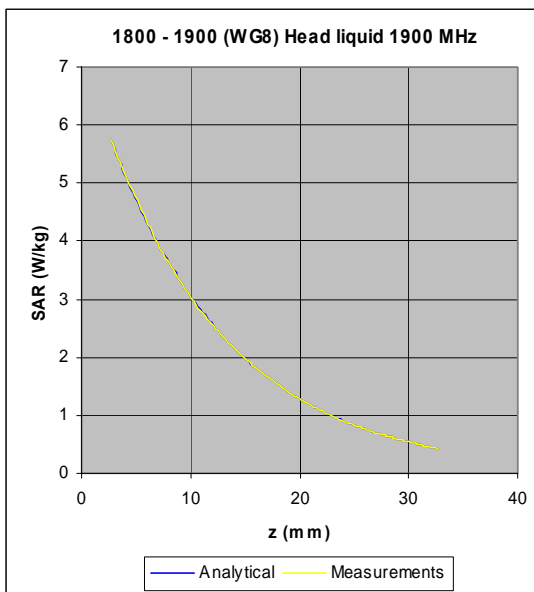
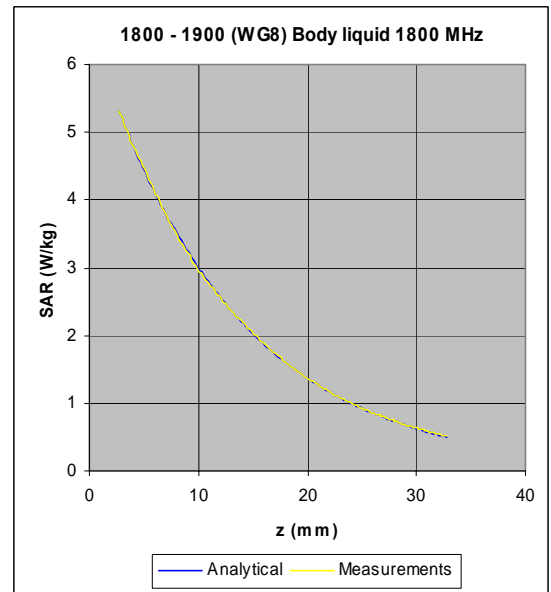
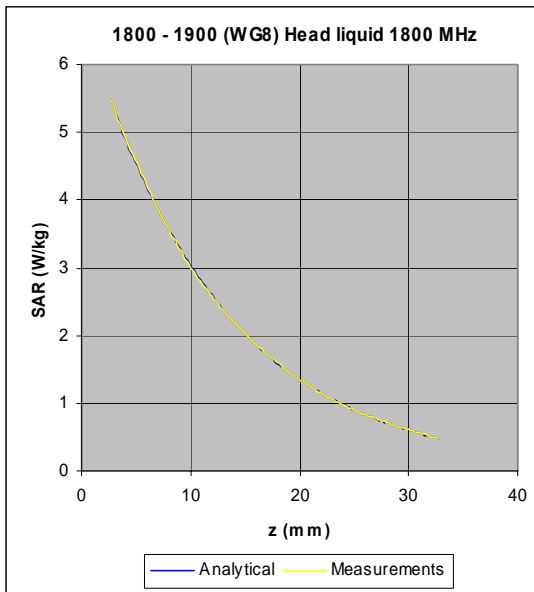

Figure 6b The measured SAR decay function along the centreline of the WG8 waveguide with conversion factors adjusted to fit to the theoretical function for the particular dimension, frequency, power and liquid properties employed.

SAR DECAY FUNCTION – Analytical and Measurements - Continued

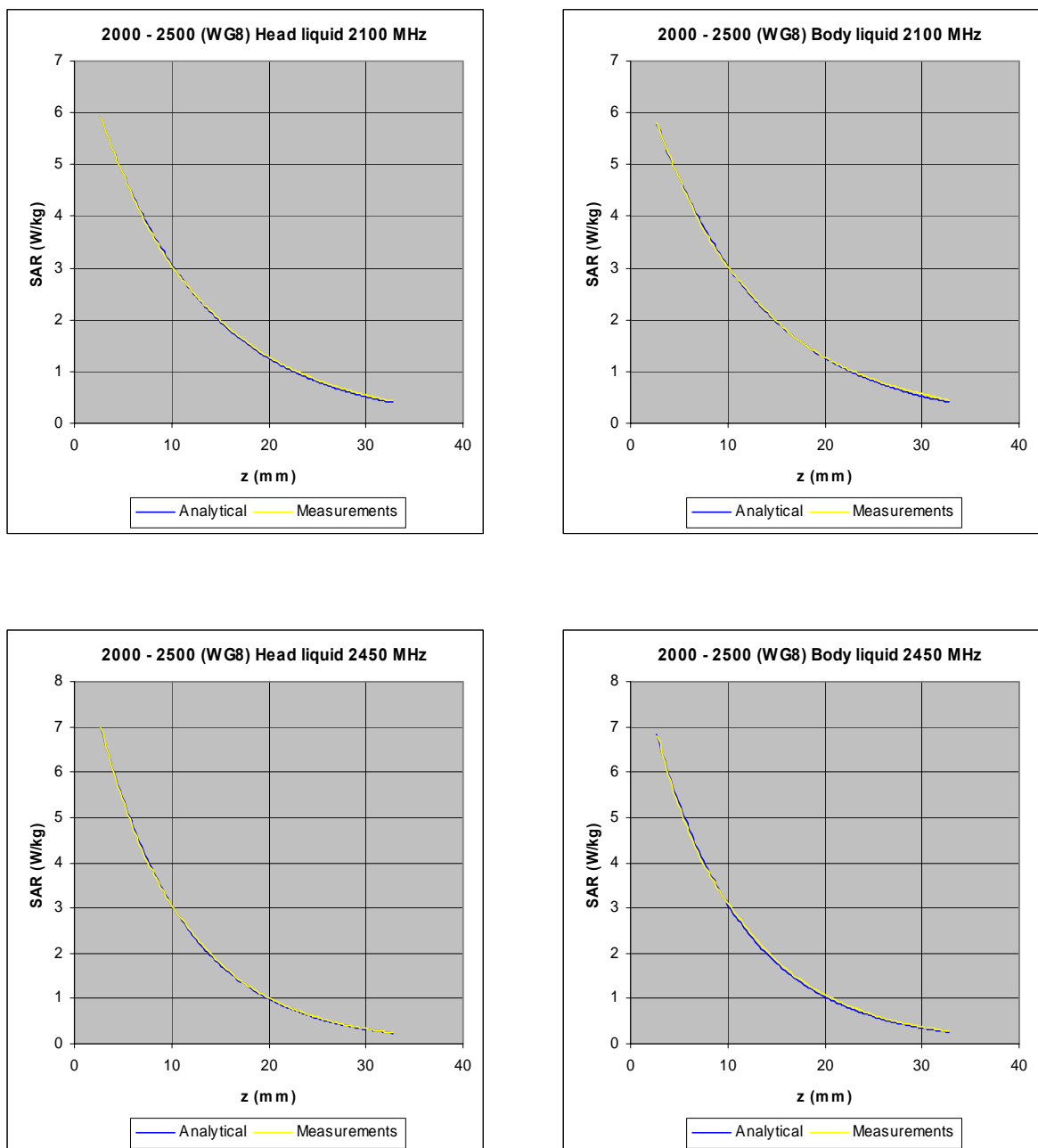

Figure 6c The measured SAR decay function along the centreline of the WG8 waveguide with conversion factors adjusted to fit to the theoretical function for the particular dimension, frequency, power and liquid properties employed.

SAR DECAY FUNCTION – Analytical And Measurements - Continued

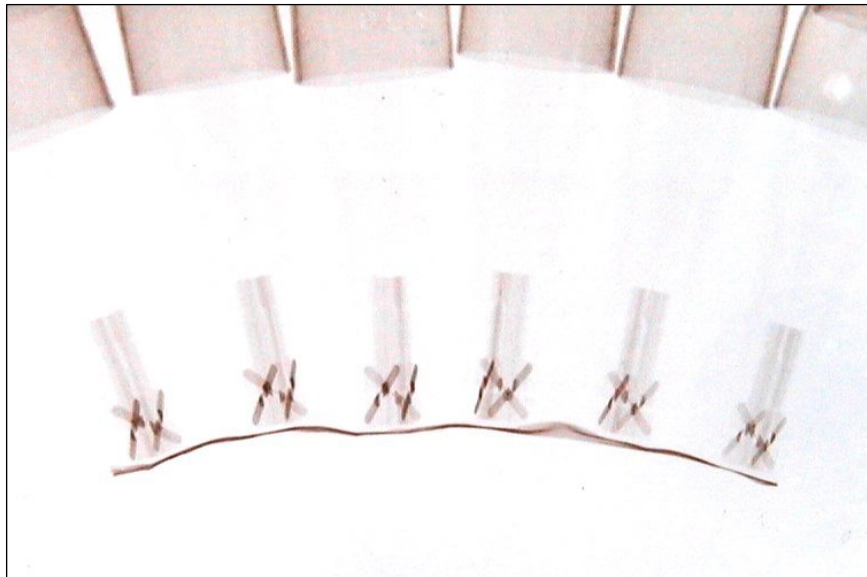

Figure 8: X-ray positive image of 5mm probes

TABLE INDICATING THE DIELECTRIC PARAMETERS OF THE LIQUIDS USED FOR CALIBRATIONS AT EACH FREQUENCY

<i>Liquid used</i>	<i>Relative permittivity (measured)</i>	<i>Conductivity (S/m) (measured)</i>
835 MHz BRAIN	42.05	0.91
835 MHz BODY	49.30	1.05
900 MHz BRAIN	40.97	0.97
900 MHz BODY	48.55	1.12
1800 MHz BRAIN	38.95	1.37
1800 MHz BODY	54.32	1.56
1900 MHz BRAIN	38.53	1.46
1900 MHz BODY	54.00	1.66
2100 MHz BRAIN	40.39	1.54
2100 MHz BODY	53.88	1.74
2450 MHz BRAIN	39.04	1.91
2450 MHz BODY	52.83	2.13