

EMC Test Report

Application for Grant of Equipment Authorization

FCC Part 15 Subpart C

Model: OZMO2000WM014A1

FCC ID: EFU-OZMO-WM014-A2

APPLICANT: Ozmo, Inc.
2595 E. Bayshore Rd Suite 100
Palo Alto, CA 94303

TEST SITE(S): NTS Silicon Valley
41039 Boyce Road.
Fremont, CA. 94538-2435

IC SITE REGISTRATION #: 2845B-3; 2845B-4, 2845B-5, 2845B-7

REPORT DATE: August 7, 2012

FINAL TEST DATES: July 5, 11 and 12, 2012

TOTAL NUMBER OF PAGES: 42

PROGRAM MGR /
TECHNICAL REVIEWER:



Mark E Hill
Staff Engineer

QUALITY ASSURANCE DELEGATE /
FINAL REPORT PREPARER:



David Guidotti
Senior Technical Writer



NTS Silicon Valley is accredited by the A2LA, certificate number 0214.26, to perform the test(s) listed in this report, except where noted otherwise. This report and the information contained herein represent the results of testing test articles identified and selected by the client performed to specifications and/or procedures selected by the client. National Technical Systems (NTS) makes no representations, expressed or implied, that such testing is adequate (or inadequate) to demonstrate efficiency, performance, reliability, or any other characteristic of the articles being tested, or similar products. This report should not be relied upon as an endorsement or certification by NTS of the equipment tested, nor does it represent any statement whatsoever as to its merchantability or fitness of the test article, or similar products, for a particular purpose. This report shall not be reproduced except in full

REVISION HISTORY

Rev#	Date	Comments	Modified By
-	08-07-2012	First release	

TABLE OF CONTENTS

REVISION HISTORY2

TABLE OF CONTENTS3

SCOPE.....4

OBJECTIVE4

STATEMENT OF COMPLIANCE.....5

DEVIATIONS FROM THE STANDARDS.....5

TEST RESULTS SUMMARY6

 DIGITAL TRANSMISSION SYSTEMS (5725 –5850 MHZ)6

 GENERAL REQUIREMENTS APPLICABLE TO ALL BANDS6

 MEASUREMENT UNCERTAINTIES7

EQUIPMENT UNDER TEST (EUT) DETAILS.....8

 GENERAL.....8

 OTHER EUT DETAILS.....8

 ANTENNA SYSTEM8

 ENCLOSURE.....8

 MODIFICATIONS.....8

 SUPPORT EQUIPMENT.....9

 EUT INTERFACE PORTS9

 EUT OPERATION9

TEST SITE.....10

 GENERAL INFORMATION.....10

 CONDUCTED EMISSIONS CONSIDERATIONS10

 RADIATED EMISSIONS CONSIDERATIONS10

MEASUREMENT INSTRUMENTATION11

 RECEIVER SYSTEM11

 INSTRUMENT CONTROL COMPUTER11

 LINE IMPEDANCE STABILIZATION NETWORK (LISN).....11

 FILTERS/ATTENUATORS12

 ANTENNAS.....12

 ANTENNA MAST AND EQUIPMENT TURNTABLE.....12

 INSTRUMENT CALIBRATION.....12

TEST PROCEDURES13

 EUT AND CABLE PLACEMENT13

 CONDUCTED EMISSIONS.....13

 RADIATED EMISSIONS.....14

 CONDUCTED EMISSIONS FROM ANTENNA PORT16

 BANDWIDTH MEASUREMENTS16

 SPECIFICATION LIMITS AND SAMPLE CALCULATIONS17

 GENERAL TRANSMITTER RADIATED EMISSIONS SPECIFICATION LIMITS18

 OUTPUT POWER LIMITS – DIGITAL TRANSMISSION SYSTEMS18

 TRANSMIT MODE SPURIOUS RADIATED EMISSIONS LIMITS – FHSS AND DTS SYSTEMS.....18

 SAMPLE CALCULATIONS - CONDUCTED EMISSIONS19

 SAMPLE CALCULATIONS - RADIATED EMISSIONS.....19

 SAMPLE CALCULATIONS - FIELD STRENGTH TO EIRP CONVERSION.....20

APPENDIX A TEST EQUIPMENT CALIBRATION DATA21

APPENDIX B TEST DATA22

END OF REPORT42

SCOPE

An electromagnetic emissions test has been performed on the Ozmo, Inc. model OZMO2000WM014A1, pursuant to the following rules:

FCC Part 15 Subpart C

Conducted and radiated emissions data has been collected, reduced, and analyzed within this report in accordance with measurement guidelines set forth in the following reference standards and as outlined in NTS Silicon Valley test procedures:

ANSI C63.4:2003

FCC DTS Measurement Procedure KDB558074, January 2012 (as modified by DR01)

The intentional radiator above has been tested in a simulated typical installation to demonstrate compliance with the relevant Industry Canada performance and procedural standards.

Final system data was gathered in a mode that tended to maximize emissions by varying orientation of EUT, orientation of power and I/O cabling, antenna search height, and antenna polarization.

Every practical effort was made to perform an impartial test using appropriate test equipment of known calibration. All pertinent factors have been applied to reach the determination of compliance.

OBJECTIVE

The primary objective of the manufacturer is compliance with the regulations outlined in the previous section.

Prior to marketing in the USA, all unlicensed transmitters and transceivers require certification. Receive-only devices operating between 30 MHz and 960 MHz are subject to either certification or a manufacturer's declaration of conformity, with all other receive-only devices exempt from the technical requirements.

Certification is a procedure where the manufacturer submits test data and technical information to a certification body and receives a certificate or grant of equipment authorization upon successful completion of the certification body's review of the submitted documents. Once the equipment authorization has been obtained, the label indicating compliance must be attached to all identical units, which are subsequently manufactured.

Maintenance of compliance is the responsibility of the manufacturer. Any modification of the product which may result in increased emissions should be checked to ensure compliance has been maintained (i.e., printed circuit board layout changes, different line filter, different power supply, harnessing or I/O cable changes, etc.).

STATEMENT OF COMPLIANCE

The tested sample of Ozmo, Inc. model OZMO2000WM014A1 complied with the requirements of the following regulations:

FCC Part 15 Subpart C

Maintenance of compliance is the responsibility of the manufacturer. Any modifications to the product should be assessed to determine their potential impact on the compliance status of the device with respect to the standards detailed in this test report.

The test results recorded herein are based on a single type test of Ozmo, Inc. model OZMO2000WM014A1 and therefore apply only to the tested sample. The sample was selected and prepared by Michael Schwartz of Ozmo, Inc.

DEVIATIONS FROM THE STANDARDS

No deviations were made from the published requirements listed in the scope of this report.

TEST RESULTS SUMMARY

DIGITAL TRANSMISSION SYSTEMS (5725 –5850 MHz)

FCC Rule Part	RSS Rule Part	Description	Measured Value / Comments	Limit / Requirement	Result
15.247(a)	RSS 210 A8.2	Digital Modulation	Systems uses OFDM techniques	System must utilize a digital transmission technology	Complies
15.247 (a) (2)	RSS 210 A8.2 (1)	6dB Bandwidth	16.3 MHz	>500kHz	Complies
15.247 (b)	RSS 210 A8.2 (4)	Output Power (multipoint systems)	1.0 dBm (1.2 mW) EIRP = 2 mW ^{Note 1}	1 Watt, EIRP limited to 4 Watts.	Complies
15.247(d)	RSS 210 A8.2 (2)	Power Spectral Density	-31.9 dBm / 3kHz	Maximum permitted is 8dBm/3kHz	Complies
15.247(c)	RSS 210 A8.5	Antenna Port Spurious Emissions – 30MHz – 40 GHz	All spurious emissions < -20dBc	< -30dBc ^{Note 2}	Complies
15.247(c) / 15.209	RSS 210 A8.5 Table 2, 3	Radiated Spurious Emissions 30MHz – 40 GHz	48.5 dBµV/m @ 11650.1 MHz (-5.5 dB)	15.207 in restricted bands, all others <-30dBc ^{Note 2}	Complies
Note 1: EIRP calculated using antenna gain of 2 dBi () for the highest EIRP system multi-point system. Note 2: Limit of -30dBc used because the power was measured using the UNII test procedure (maximum power averaged over a transmission burst).					

GENERAL REQUIREMENTS APPLICABLE TO ALL BANDS

FCC Rule Part	RSS Rule part	Description	Measured Value / Comments	Limit / Requirement	Result (margin)
15.203	-	RF Connector	Antennas are integral to the device	Unique or integral antenna required	Complies
15.207	RSS GEN Table 2	AC Conducted Emissions	31.6 dBµV @ 0.335 MHz (-17.7 dB)	-	Complies
15.109	RSS GEN 7.2.3 Table 1	Receiver spurious emissions	N/A – tunes above 960MHz	-	N/A
15.247 (b) (5) 15.407 (f)	RSS 102	RF Exposure Requirements	Refer to MPE calculations in Exhibit 11, RSS 102 declaration and User Manual statements.	Refer to OET 65, FCC Part 1 and RSS 102	Complies
-	RSP 100 RSS GEN 7.1.5	User Manual	-	Statement required regarding non-interference	Complies
-	RSP 100 RSS GEN 7.1.5	User Manual	-	Statement for products with detachable antenna	N/A
-	RSP 100 RSS GEN 4.4.1	99% Bandwidth	17.1 MHz	Information only	N/A

MEASUREMENT UNCERTAINTIES

ISO/IEC 17025 requires that an estimate of the measurement uncertainties associated with the emissions test results be included in the report. The measurement uncertainties given below are based on a 95% confidence level and were calculated in accordance with UKAS document LAB 34.

Measurement Type	Measurement Unit	Frequency Range	Expanded Uncertainty
RF power, conducted (power meter)	dBm	25 to 7000 MHz	± 0.52 dB
RF power, conducted (Spectrum analyzer)	dBm	25 to 7000 MHz	± 0.7 dB
Conducted emission of transmitter	dBm	25 to 26500 MHz	± 0.7 dB
Conducted emission of receiver	dBm	25 to 26500 MHz	± 0.7 dB
Radiated emission (substitution method)	dBm	25 to 26500 MHz	± 2.5 dB
Radiated emission (field strength)	dB μ V/m	25 to 1000 MHz	± 3.6 dB
		1000 to 40000 MHz	± 6.0 dB
Conducted Emissions (AC Power)	dB μ V	0.15 to 30 MHz	± 2.4 dB

EQUIPMENT UNDER TEST (EUT) DETAILS**GENERAL**

The Ozmo, Inc. model OZMO2000WM014A1 is a 5GHz WiFi Direct Transceiver which is designed to be used as a peripheral in wireless personal area networks (mouse, keyboard, audio headsets, speakers, etc.). Normally, the EUT would be placed on a tabletop during operation. The EUT was, therefore, placed in this position during emissions testing to simulate the end user environment. The electrical rating of the EUT is 3.3 V, DC, 0.3 Amps.

The sample was received on July 3, 2012 and tested on July 5, 11 and 12, 2012. The EUT consisted of the following component(s):

Company	Model	Description	Serial Number	FCC ID
Ozmo	OZMO2000W M014A1	5GHz WiFi direct module (antenna port)	0126000595E3	EFU-OZMO- WM014-A2
Ozmo	OZMO2000W M014A1	5GHz WiFi direct module (radiated)	012600059604	EFU-OZMO- WM014-A2

OTHER EUT DETAILS

The following EUT details should be noted:

- (1) Single Tx chain
- (2) Operation bands: 5150-5250, 5725-5850 MHz

ANTENNA SYSTEM

The antenna is pcb trace antenna integral to the device. There are two antennas for transmit diversity.

Gain = 2dBi

ENCLOSURE

The EUT does not have an enclosure as it is designed to be installed within the enclosure of a host computer or system.

MODIFICATIONS

No modifications were made to the EUT during the time the product was at NTS Silicon Valley.

SUPPORT EQUIPMENT

The following equipment was used as support equipment for testing:

Company	Model	Description	Serial Number	FCC ID
Dell	Vostro 1520	Laptop	7CH6QK1 (service tag)	-
Dell	PA-1650-05D2	AC/DC Adapter	CN-0F7970- 71615-54P- 6D4F	-
First Silicon Solutions	SNAV- CAST51-USB	USB/Serial Adapter	40735	-
Ozmo	-	USB+JTAG reference design board	-	-
Ozmo	2000EVB	Evaluation Board/Test Fixture	-	-

No remote support equipment was used during testing.

EUT INTERFACE PORTS

The I/O cabling configuration during testing was as follows:

Port	Connected To	Description	Cable(s)	
			Shielded or Unshielded	Length(m)
USB Laptop Computer	USB/Serial Adapter	USB - multiconductor	Shielded	1.5
USB Laptop Computer	Evaluation Board/test fixture	USB - multiconductor	Shielded	1.5
USB/Serial Adapter	Evaluation Board/test fixture	USB - multiconductor	Shielded	1.5
DC Power - Laptop	USB+JTAG board	Ribbon Cable	Unshielded	0.05
USB+JTAG board	EUT	Ribbon Cable	Unshielded	0.2

EUT OPERATION

During testing, the EUT was configured to transmit continuously on the noted channel using the lowest data rate available for the modulation, as this was the worst case condition.

TEST SITE

GENERAL INFORMATION

Final test measurements were taken at the test sites listed below. Pursuant to section 2.948 of the FCC’s Rules and section 3.3 of RSP-100, construction, calibration, and equipment data has been filed with the Commission and with industry Canada.

Site	Registration Numbers		Location
	FCC	Canada	
Chamber 4	211948	2845B-4	41039 Boyce Road Fremont, CA 94538-2435

ANSI C63.4:2003 recommends that ambient noise at the test site be at least 6 dB below the allowable limits. Ambient levels are below this requirement. The test site(s) contain separate areas for radiated and conducted emissions testing. Considerable engineering effort has been expended to ensure that the facilities conform to all pertinent requirements of ANSI C63.4:2003.

CONDUCTED EMISSIONS CONSIDERATIONS

Conducted emissions testing is performed in conformance with ANSI C63.4:2003. Measurements are made with the EUT connected to the public power network through a nominal, standardized RF impedance, which is provided by a line impedance stabilization network, known as a LISN. A LISN is inserted in series with each current-carrying conductor in the EUT power cord.

RADIATED EMISSIONS CONSIDERATIONS

The FCC has determined that radiation measurements made in a shielded enclosure are not suitable for determining levels of radiated emissions. Radiated measurements are performed in an open field environment or in a semi-anechoic chamber. The test sites are maintained free of conductive objects within the CISPR defined elliptical area incorporated in ANSI C63.4:2003 guidelines and meet the Normalized Site Attenuation (NSA) requirements of ANSI C63.4:2003.

MEASUREMENT INSTRUMENTATION

RECEIVER SYSTEM

An EMI receiver as specified in CISPR 16-1-1 is used for emissions measurements. The receivers used can measure over the frequency range of 9 kHz up to 2000 MHz. These receivers allow both ease of measurement and high accuracy to be achieved. The receivers have Peak, Average, and CISPR (Quasi-peak) detectors built into their design so no external adapters are necessary. The receiver automatically sets the required bandwidth for the CISPR detector used during measurements. If the repetition frequency of the signal being measured is below 20Hz, peak measurements are made in lieu of Quasi-Peak measurements.

For measurements above the frequency range of the receivers, a spectrum analyzer is utilized because it provides visibility of the entire spectrum along with the precision and versatility required to support engineering analysis. Average measurements above 1000MHz are performed on the spectrum analyzer using the linear-average method with a resolution bandwidth of 1 MHz and a video bandwidth of 10 Hz, unless the signal is pulsed in which case the average (or video) bandwidth of the measuring instrument is reduced to onset of pulse desensitization and then increased.

INSTRUMENT CONTROL COMPUTER

The receivers utilize either a Rohde & Schwarz EZM Spectrum Monitor/Controller or contain an internal Spectrum Monitor/Controller to view and convert the receiver measurements to the field strength at an antenna or voltage developed at the LISN measurement port, which is then compared directly with the appropriate specification limit. This provides faster, more accurate readings by performing the conversions described under Sample Calculations within the Test Procedures section of this report. Results are printed in a graphic and/or tabular format, as appropriate. A personal computer is used to record all measurements made with the receivers.

The Spectrum Monitor provides a visual display of the signal being measured. In addition, the controller or a personal computer run automated data collection programs which control the receivers. This provides added accuracy since all site correction factors, such as cable loss and antenna factors are added automatically.

LINE IMPEDANCE STABILIZATION NETWORK (LISN)

Line conducted measurements utilize a fifty microhenry Line Impedance Stabilization Network as the monitoring point. The LISN used also contains a 250 uH CISPR adapter. This network provides for calibrated radio frequency noise measurements by the design of the internal low pass and high pass filters on the EUT and measurement ports, respectively.

FILTERS/ATTENUATORS

External filters and precision attenuators are often connected between the receiving antenna or LISN and the receiver. This eliminates saturation effects and non-linear operation due to high amplitude transient events.

ANTENNAS

A loop antenna is used below 30 MHz. For the measurement range 30 MHz to 1000 MHz either a combination of a biconical antenna and a log periodic or a bi-log antenna is used. Above 1000 MHz, horn antennas are used. The antenna calibration factors to convert the received voltage to an electric field strength are included with appropriate cable loss and amplifier gain factors to determine an overall site factor, which is then programmed into the test receivers or incorporated into the test software.

ANTENNA MAST AND EQUIPMENT TURNTABLE

The antennas used to measure the radiated electric field strength are mounted on a non-conductive antenna mast equipped with a motor-drive to vary the antenna height. Measurements below 30 MHz are made with the loop antenna at a fixed height of 1m above the ground plane.

ANSI C63.4:2003 specifies that the test height above ground for table mounted devices shall be 80 centimeters. Floor mounted equipment shall be placed on the ground plane if the device is normally used on a conductive floor or separated from the ground plane by insulating material from 3 to 12 mm if the device is normally used on a non-conductive floor. During radiated measurements, the EUT is positioned on a motorized turntable in conformance with this requirement.

INSTRUMENT CALIBRATION

All test equipment is regularly checked to ensure that performance is maintained in accordance with the manufacturer's specifications. All antennas are calibrated at regular intervals with respect to tuned half-wave dipoles. An exhibit of this report contains the list of test equipment used and calibration information.

TEST PROCEDURES

EUT AND CABLE PLACEMENT

The regulations require that interconnecting cables be connected to the available ports of the unit and that the placement of the unit and the attached cables simulate the worst case orientation that can be expected from a typical installation, so far as practicable. To this end, the position of the unit and associated cabling is varied within the guidelines of ANSI C63.4:2003, and the worst-case orientation is used for final measurements.

CONDUCTED EMISSIONS

Conducted emissions are measured at the plug end of the power cord supplied with the EUT. Excess power cord length is wrapped in a bundle between 30 and 40 centimeters in length near the center of the cord. Preliminary measurements are made to determine the highest amplitude emission relative to the specification limit for all the modes of operation. Placement of system components and varying of cable positions are performed in each mode. A final peak mode scan is then performed in the position and mode for which the highest emission was noted on all current carrying conductors of the power cord.

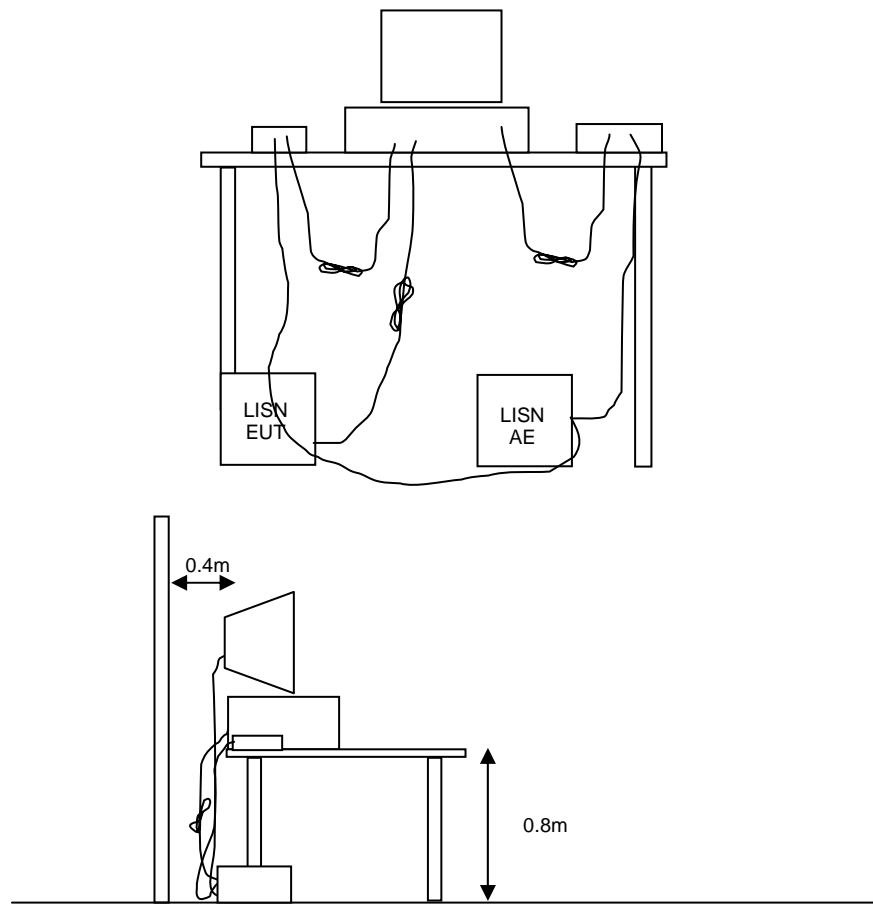

Figure 1 Typical Conducted Emissions Test Configuration

RADIATED EMISSIONS

A preliminary scan of the radiated emissions is performed in which all significant EUT frequencies are identified with the system in a nominal configuration. At least two scans are performed, one scan for each antenna polarization (horizontal and vertical; loop parallel and perpendicular to the EUT). During the preliminary scans, the EUT is rotated through 360°, the antenna height is varied (for measurements above 30 MHz) and cable positions are varied to determine the highest emission relative to the limit. Preliminary scans may be performed in a fully anechoic chamber for the purposes of identifying the frequencies of the highest emissions from the EUT.

A speaker is provided in the receiver to aid in discriminating between EUT and ambient emissions. Other methods used during the preliminary scan for EUT emissions involve scanning with near field magnetic loops, monitoring I/O cables with RF current clamps, and cycling power to the EUT.

Final maximization is a phase in which the highest amplitude emissions identified in the spectral search are viewed while the EUT azimuth angle is varied from 0 to 360 degrees relative to the receiving antenna. The azimuth, which results in the highest emission is then maintained while varying the antenna height from one to four meters (for measurements above 30 MHz, measurements below 30 MHz are made with the loop antenna at a fixed height of 1m). The result is the identification of the highest amplitude for each of the highest peaks. Each recorded level is corrected in the receiver using appropriate factors for cables, connectors, antennas, and preamplifier gain.

When testing above 18 GHz, the receive antenna is located at 1meter from the EUT and the antenna height is restricted to a maximum of 2.5 meters.

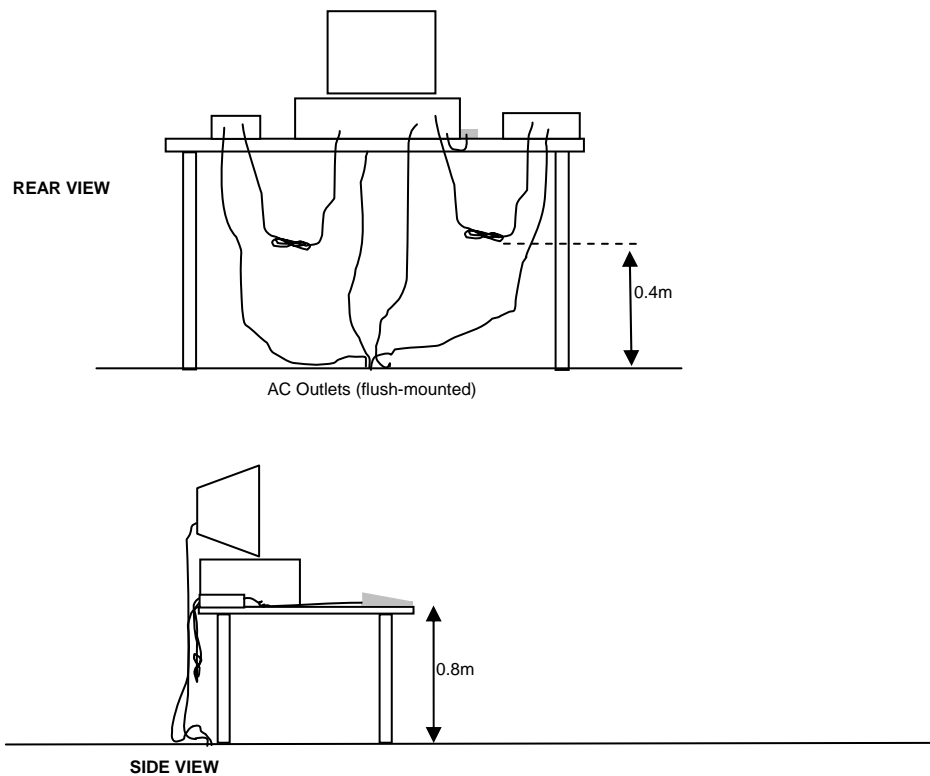

Typical Test Configuration for Radiated Field Strength Measurements

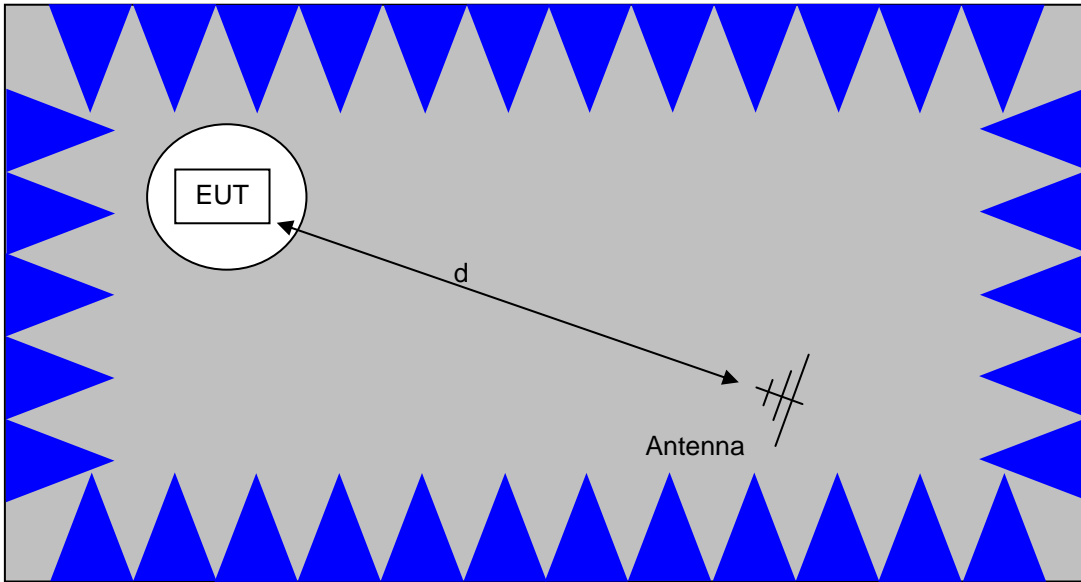

The anechoic materials on the walls and ceiling ensure compliance with the normalized site attenuation requirements of CISPR 16 / CISPR 22 / ANSI C63.4 for an alternate test site at the measurement distances used.

Floor-standing equipment is placed on the floor with insulating supports between the unit and the ground plane.

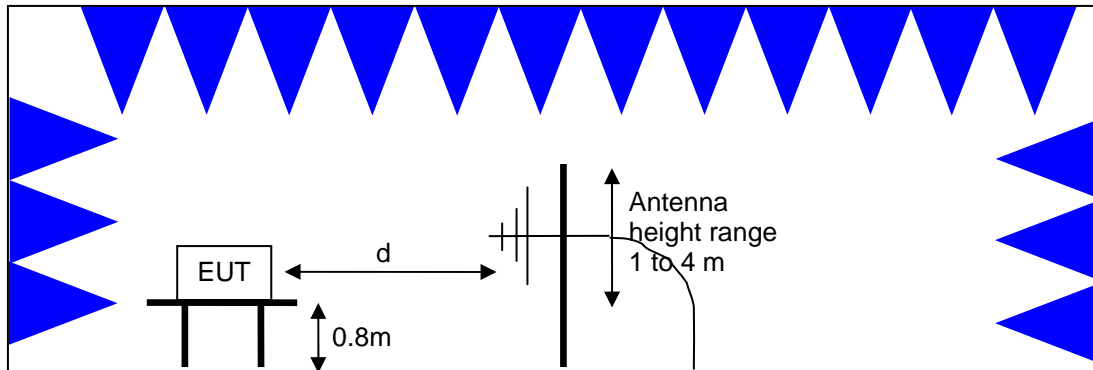

Test Configuration for Radiated Field Strength Measurements
Semi-Anechoic Chamber, Plan and Side Views

CONDUCTED EMISSIONS FROM ANTENNA PORT

Direct measurements of power, bandwidth and power spectral density are performed, where possible, with the antenna port of the EUT connected to either the power meter or spectrum analyzer via a suitable attenuator and/or filter. These are used to ensure that the front end of the measurement instrument is not overloaded by the fundamental transmission.

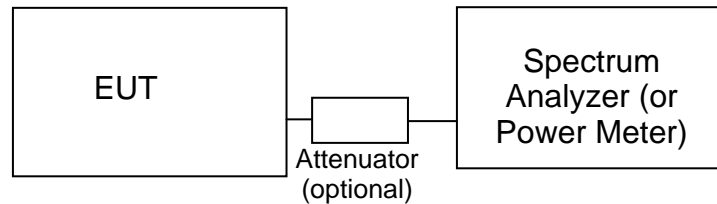
**Test Configuration for Antenna Port Measurements**

Measurement bandwidths (video and resolution) are set in accordance with the relevant standards and NTS Silicon Valley's test procedures for the type of radio being tested. When power measurements are made using a resolution bandwidth less than the signal bandwidth the power is calculated by summing the power across the signal bandwidth using either the analyzer channel power function or by capturing the trace data and calculating the power using software. In both cases the summed power is corrected to account for the equivalent noise bandwidth (ENBW) of the resolution bandwidth used.

If power averaging is used (typically for certain digital modulation techniques), the EUT is configured to transmit continuously. Power averaging is performed using either the built-in function of the analyzer or, if the analyzer does not feature power averaging, using external software. In both cases the average power is calculated over a number of sweeps (typically 100). When the EUT cannot be configured to continuously transmit then either the analyzer is configured to perform a gated sweep to ensure that the power is averaged over periods that the device is transmitting or power averaging is disabled and a max-hold feature is used.

If a power meter is used to make output power measurements the sensor head type (peak or average) is stated in the test data table.

BANDWIDTH MEASUREMENTS

The 6dB, 20dB and/or 26dB signal bandwidth is measured in using the bandwidths recommended by ANSI C63.4. When required, the 99% bandwidth is measured using the methods detailed in RSS GEN.

SPECIFICATION LIMITS AND SAMPLE CALCULATIONS

The limits for conducted emissions are given in units of microvolts, and the limits for radiated emissions are given in units of microvolts per meter at a specified test distance. Data is measured in the logarithmic form of decibels relative to one microvolt, or dB microvolts (dBuV). For radiated emissions, the measured data is converted to the field strength at the antenna in dB microvolts per meter (dBuV/m). The results are then converted to the linear forms of uV and uV/m for comparison to published specifications.

For reference, converting the specification limits from linear to decibel form is accomplished by taking the base ten logarithm, then multiplying by 20. These limits in both linear and logarithmic form are as follows:

GENERAL TRANSMITTER RADIATED EMISSIONS SPECIFICATION LIMITS

The table below shows the limits for the spurious emissions from transmitters that fall in restricted bands¹ (with the exception of transmitters operating under FCC Part 15 Subpart D and RSS 210 Annex 9), the limits for all emissions from a low power device operating under the general rules of RSS 310 (tables 3 and 4), RSS 210 (table 2) and FCC Part 15 Subpart C section 15.209.

Frequency Range (MHz)	Limit (uV/m)	Limit (dBuV/m @ 3m)
0.009-0.490	2400/F _{KHz} @ 300m	67.6-20*log ₁₀ (F _{KHz}) @ 300m
0.490-1.705	24000/F _{KHz} @ 30m	87.6-20*log ₁₀ (F _{KHz}) @ 30m
1.705 to 30	30 @ 30m	29.5 @ 30m
30 to 88	100 @ 3m	40 @ 3m
88 to 216	150 @ 3m	43.5 @ 3m
216 to 960	200 @ 3m	46.0 @ 3m
Above 960	500 @ 3m	54.0 @ 3m

OUTPUT POWER LIMITS – DIGITAL TRANSMISSION SYSTEMS

The table below shows the limits for output power and output power density. Where the signal bandwidth is less than 20 MHz the maximum output power is reduced to the power spectral density limit plus 10 times the log of the bandwidth (in MHz).

Operating Frequency (MHz)	Output Power	Power Spectral Density
902 – 928	1 Watt (30 dBm)	8 dBm/3kHz
2400 – 2483.5	1 Watt (30 dBm)	8 dBm/3kHz
5725 – 5850	1 Watt (30 dBm)	8 dBm/3kHz

The maximum permitted output power is reduced by 1dB for every dB the antenna gain exceeds 6dBi. Fixed point-to-point applications using the 5725 – 5850 MHz band are not subject to this restriction.

TRANSMIT MODE SPURIOUS RADIATED EMISSIONS LIMITS – FHSS and DTS SYSTEMS

The limits for unwanted (spurious) emissions from the transmitter falling in the restricted bands are those specified in the general limits sections of FCC Part 15 and RSS 210. All other unwanted (spurious) emissions shall be at least 20dB below the level of the highest in-band signal level (30dB if the power is measured using the sample detector/power averaging method).

¹ The restricted bands are detailed in FCC 15.203, RSS 210 Table 1 and RSS 310 Table 2

SAMPLE CALCULATIONS - CONDUCTED EMISSIONS

Receiver readings are compared directly to the conducted emissions specification limit (decibel form) as follows:

$$R_r - S = M$$

where:

R_r = Receiver Reading in dBuV

S = Specification Limit in dBuV

M = Margin to Specification in +/- dB

SAMPLE CALCULATIONS - RADIATED EMISSIONS

Receiver readings are compared directly to the specification limit (decibel form). The receiver internally corrects for cable loss, preamplifier gain, and antenna factor. The calculations are in the reverse direction of the actual signal flow, thus cable loss is added and the amplifier gain is subtracted. The Antenna Factor converts the voltage at the antenna coaxial connector to the field strength at the antenna elements.

A distance factor, when used for electric field measurements above 30MHz, is calculated by using the following formula:

$$F_d = 20 * \text{LOG}_{10} (D_m/D_s)$$

where:

F_d = Distance Factor in dB

D_m = Measurement Distance in meters

D_s = Specification Distance in meters

For electric field measurements below 30MHz the extrapolation factor is either determined by making measurements at multiple distances or a theoretical value is calculated using the formula:

$$F_d = 40 * \text{LOG}_{10} (D_m/D_s)$$

Measurement Distance is the distance at which the measurements were taken and Specification Distance is the distance at which the specification limits are based. The antenna factor converts the voltage at the antenna coaxial connector to the field strength at the antenna elements.

The margin of a given emission peak relative to the limit is calculated as follows:

$$R_c = R_r + F_d$$

and

$$M = R_c - L_s$$

where:

R_r = Receiver Reading in dBuV/m

F_d = Distance Factor in dB

R_c = Corrected Reading in dBuV/m

L_S = Specification Limit in dBuV/m

M = Margin in dB Relative to Spec

SAMPLE CALCULATIONS - FIELD STRENGTH TO EIRP CONVERSION

Where the radiated electric field strength is expressed in terms of the equivalent isotropic radiated power (eirp), or where a field strength measurement of output power is made in lieu of a direct measurement, the following formula is used to convert between eirp and field strength at a distance of d (meters) from the equipment under test:

$$E = \frac{1000000 \sqrt{30 P}}{d} \quad \text{microvolts per meter}$$

where P is the eirp (Watts)

For a measurement at 3m the conversion from a logarithmic value for field strength (dBuV/m) to an eirp power (dBm) is -95.3dB.

Appendix A Test Equipment Calibration Data**Radiated Emissions, 1000 - 40,000 MHz, 04-Jul-12**

<u>Manufacturer</u>	<u>Description</u>	<u>Model</u>	<u>Asset #</u>	<u>Cal Due</u>
Hewlett Packard	Microwave Preamplifier, 1-26.5GHz	8449B	263	3/29/2013
EMCO	Antenna, Horn, 1-18 GHz (SA40-Red)	3115	1142	8/2/2012
Hewlett Packard	SpecAn 9 kHz - 40 GHz, FT (SA40) Blue	8564E (84125C)	1393	5/1/2013
Hewlett Packard	Head (Inc flex cable, (1742,1743) Blue	84125C	1620	5/17/2013
A.H. Systems	Spare System Horn, 18-40GHz	SAS-574, p/n: 2581	2162	5/8/2013
Micro-Tronics	Band Reject Filter, 5725-5875 MHz	BRC50705-02	2241	10/4/2012

Tx Radiated Spurious, 1000 - 40,000 MHz, 05-Jul-12

<u>Manufacturer</u>	<u>Description</u>	<u>Model</u>	<u>Asset #</u>	<u>Cal Due</u>
Hewlett Packard	Microwave Preamplifier, 1-26.5GHz	8449B	263	3/29/2013
Narda West	High Pass Filter, 8 GHz	HPF 180	821	3/22/2013
EMCO	Antenna, Horn, 1-18 GHz (SA40-Red)	3115	1142	8/2/2012
Hewlett Packard	SpecAn 9 kHz - 40 GHz, FT (SA40) Blue	8564E (84125C)	1393	5/1/2013
Hewlett Packard	Head (Inc flex cable, (1742,1743) Blue	84125C	1620	5/17/2013
A.H. Systems	Spare System Horn, 18-40GHz	SAS-574, p/n: 2581	2162	5/8/2013
Micro-Tronics	Band Reject Filter, 5150-5350 MHz	BRC50703-02	2239	10/4/2012

Radiated Emissions, 1000 - 18,000 MHz, 12-Jul-12

<u>Manufacturer</u>	<u>Description</u>	<u>Model</u>	<u>Asset #</u>	<u>Cal Due</u>
Hewlett Packard	Microwave Preamplifier, 1-26.5GHz	8449B	263	3/29/2013
EMCO	Antenna, Horn, 1-18 GHz (SA40-Blu)	3115	1386	9/21/2012
Hewlett Packard	SpecAn 9 kHz - 40 GHz, FT (SA40) Blue	8564E (84125C)	1393	5/1/2013
Micro-Tronics	Band Reject Filter, 5725-5875 MHz	BRC50705-02	2241	10/4/2012
Micro-Tronics	Band Reject Filter, 5150-5350 MHz	BRC50703-02	2251	10/11/2012

Conducted Emissions – AC Power, 12-Apr-12

Rohde & Schwarz	Pulse Limiter	ESH3 Z2	1401	4/21/12
Rohde & Schwarz	EMI Test Receiver, 20 Hz-7 GHz	ESIB7	1756	5/25/12
Fischer Custom Comm	LISN, 25A, 150kHz to 30MHz, 25 Amp,	FCC-LISN-50-25-2-09	2001	2/15/13

Appendix B Test Data

T87368 Pages 23 – 41



EMC Test Data

Client:	Ozmo, Inc.	Job Number:	J87040
Model:	OZMO2000WM014A1 (RD014V4)	T-Log Number:	T87366
		Account Manager:	Sheareen Jacobs
Contact:	Mike Schwartz		-
Emissions Standard(s):	FCC/IC 15.247, 15.407	Class:	-
Immunity Standard(s):	-	Environment:	-

EMC Test Data

For The

Ozmo, Inc.

Model

OZMO2000WM014A1 (RD014V4)

Date of Last Test: 7/30/2012



EMC Test Data

Client:	Ozmo, Inc.	Job Number:	J87040
Model:	OZMO2000WM014A1 (RD014V4)	T-Log Number:	T87366
		Account Manager:	Sheareen Jacobs
Contact:	Mike Schwartz		
Standard:	FCC/IC 15.247, 15.407	Class:	N/A

RSS 210 and FCC 15.247 (DTS) Radiated Spurious Emissions

Test Specific Details

Objective: The objective of this test session is to perform final qualification testing of the EUT with respect to the specification listed above.

General Test Configuration

The EUT and all local support equipment were located on the turntable for radiated spurious emissions testing.

For radiated emissions testing the measurement antenna was located 3 meters from the EUT.

Ambient Conditions:

Temperature: 22.4 °C
 Rel. Humidity: 38 %

Summary of Results - Device Operating in the 5725 - 5850 MHz Band

Run #	Mode	Channel	Power Setting	Measured Power	Test Performed	Limit	Result / Margin
Run # 1	802.11a Chain A	#149 5745MHz	Gain_index 1	-	Radiated Emissions, 1 - 40 GHz	FCC 15.209 / 15.247	47.9 dBµV/m @ 11489.9 MHz (-6.1 dB)
	802.11a Chain B	#149 5745MHz	Gain_index 1	-			46.8 dBµV/m @ 11489.8 MHz (-7.2 dB)
	802.11a Chain A	#157 5785MHz	Gain_index 1	-			48.4 dBµV/m @ 11570.0 MHz (-5.6 dB)
	802.11a Chain B	#157 5785MHz	Gain_index 1	-			45.2 dBµV/m @ 11569.9 MHz (-8.8 dB)
	802.11a Chain A	#165 5825MHz	Gain_index 1	-			48.5 dBµV/m @ 11650.1 MHz (-5.5 dB)



EMC Test Data

Client:	Ozmo, Inc.	Job Number:	J87040
Model:	OZMO2000WM014A1 (RD014V4)	T-Log Number:	T87366
		Account Manager:	Sheareen Jacobs
Contact:	Mike Schwartz		
Standard:	FCC/IC 15.247, 15.407	Class:	N/A

Modifications Made During Testing

No modifications were made to the EUT during testing

Deviations From The Standard

No deviations were made from the requirements of the standard.

Notes:

Sample: s/n: 012600059604

EUT Software:



EMC Test Data

Client: Ozmo, Inc.	Job Number: J87040
Model: OZMO2000WM014A1 (RD014V4)	T-Log Number: T87366
	Account Manager: Sheareen Jacobs
Contact: Mike Schwartz	
Standard: FCC/IC 15.247, 15.407	Class: N/A

Run # 1: Radiated Spurious Emissions, 1-40GHz, 802.11a

Date of Test: 7/11/2012

Test Location: FT Chamber #4

Test Engineer: Rafael Varelas

Config Change: None

Run # 1a: EUT on Channel #149 5745MHz - 802.11a, Chain A

	Target (dBm)	Power Settings Measured (dBm)	Software Setting
Chain A			Gain_index 1

Spurious Radiated Emissions:

Frequency MHz	Level dBμV/m	Pol v/h	15.209/15.247 Limit Margin	Detector Pk/QP/Avg	Azimuth degrees	Height meters	Comments
11489.900	47.9	V	54.0 -6.1	AVG	172	1.3	RB 1 MHz;VB 10 Hz;Peak
11490.160	56.4	V	74.0 -17.6	PK	172	1.3	RB 1 MHz;VB 3 MHz;Peak
5427.150	37.2	V	54.0 -16.8	AVG	325	1.3	RB 1 MHz;VB 10 Hz;Peak
5417.550	47.8	V	74.0 -26.2	PK	325	1.3	RB 1 MHz;VB 3 MHz;Peak
1488.210	44.4	H	54.0 -9.6	AVG	38	0.9	RB 1 MHz;VB 10 Hz;Peak
1488.130	46.1	H	74.0 -27.9	PK	38	0.9	RB 1 MHz;VB 3 MHz;Peak

Note 1: For emissions in restricted bands, the limit of 15.209 was used. For all other emissions, the limit is -30dBc for peak measurements in a measurement bandwidth of 100kHz.

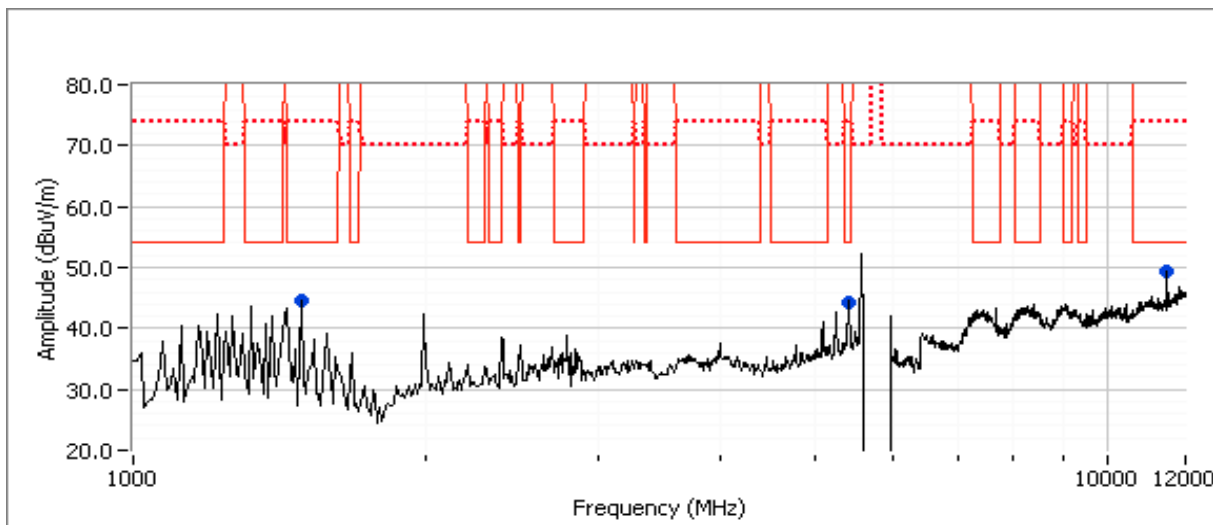



EMC Test Data

Client: Ozmo, Inc.	Job Number: J87040
Model: OZMO2000WM014A1 (RD014V4)	T-Log Number: T87366
	Account Manager: Sheareen Jacobs
Contact: Mike Schwartz	
Standard: FCC/IC 15.247, 15.407	Class: N/A

Run # 1b: EUT on Channel #149 5745MHz - 802.11a, Chain B

	Target (dBm)	Power Settings Measured (dBm)	Software Setting
Chain B			Gain_index 1

Spurious Radiated Emissions:

Frequency	Level	Pol	15.209/15.247		Detector	Azimuth	Height	Comments
MHz	dB μ V/m	v/h	Limit	Margin	PK/QP/Avg	degrees	meters	
11489.800	46.8	V	54.0	-7.2	AVG	64	1.2	RB 1 MHz;VB 10 Hz;Peak
11489.690	55.6	V	74.0	-18.4	PK	64	1.2	RB 1 MHz;VB 3 MHz;Peak
1200.100	29.9	V	54.0	-24.1	AVG	54	1.9	RB 1 MHz;VB 10 Hz;Peak
1197.570	46.7	V	74.0	-27.3	PK	54	1.9	RB 1 MHz;VB 3 MHz;Peak
5432.650	39.3	V	54.0	-14.7	AVG	206	1.4	RB 1 MHz;VB 10 Hz;Peak
5429.380	50.6	V	74.0	-23.4	PK	206	1.4	RB 1 MHz;VB 3 MHz;Peak

Note 1: For emissions in restricted bands, the limit of 15.209 was used. For all other emissions, the limit is -30dBc for peak measurements in a measurement bandwidth of 100kHz.

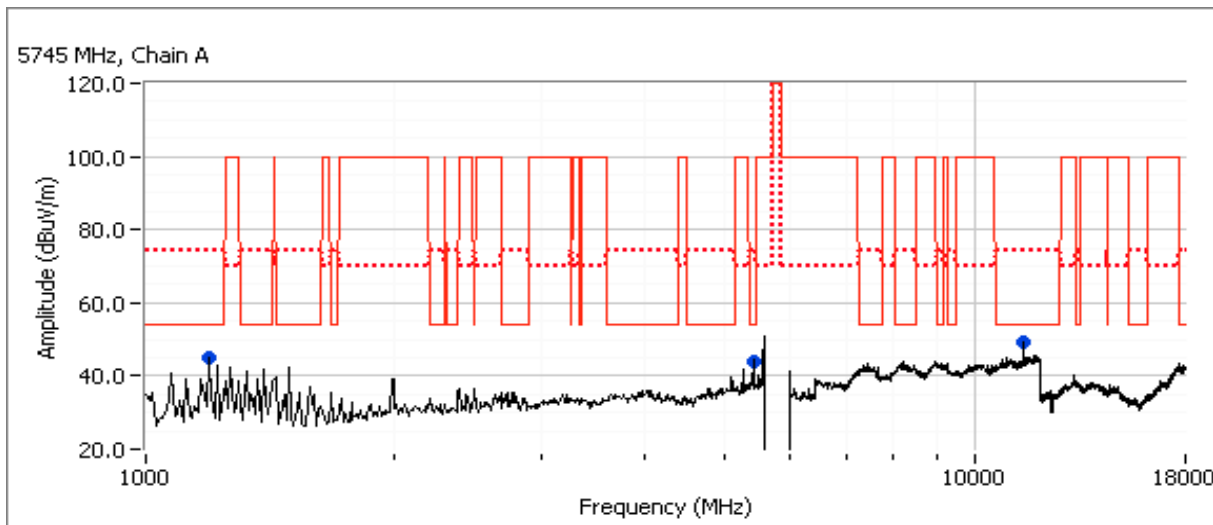



EMC Test Data

Client:	Ozmo, Inc.	Job Number:	J87040
Model:	OZMO2000WM014A1 (RD014V4)	T-Log Number:	T87366
Contact:	Mike Schwartz	Account Manager:	Sheareen Jacobs
Standard:	FCC/IC 15.247, 15.407	Class:	N/A

Run # 1c: EUT on Channel #157 5785MHz - 802.11a, Chain A

	Target (dBm)	Power Settings Measured (dBm)	Software Setting
Chain A			Gain_index 1

Spurious Radiated Emissions:

Frequency MHz	Level dB μ V/m	Pol v/h	15.209/15.247		Detector PK/QP/Avg	Azimuth degrees	Height meters	Comments
			Limit	Margin				
11569.960	48.4	V	54.0	-5.6	AVG	181	1.4	RB 1 MHz;VB 10 Hz;Peak
11569.880	56.9	V	74.0	-17.1	PK	181	1.4	RB 1 MHz;VB 3 MHz;Peak
1323.030	43.8	H	54.0	-10.2	AVG	167	1.0	RB 1 MHz;VB 10 Hz;Peak
1323.010	45.4	H	74.0	-28.6	PK	167	1.0	RB 1 MHz;VB 3 MHz;Peak
5457.330	38.1	V	54.0	-15.9	AVG	206	1.3	RB 1 MHz;VB 10 Hz;Peak
5456.850	49.8	V	74.0	-24.2	PK	206	1.3	RB 1 MHz;VB 3 MHz;Peak

- Note 1: For emissions in restricted bands, the limit of 15.209 was used. For all other emissions, the limit is -30dBc for peak measurements in a measurement bandwidth of 100kHz.
- Note 2: Scans made between 18 - 40GHz with the measurement antenna moved around the card and its antennas 20-50cm from the device indicated there were no significant emissions in this frequency range

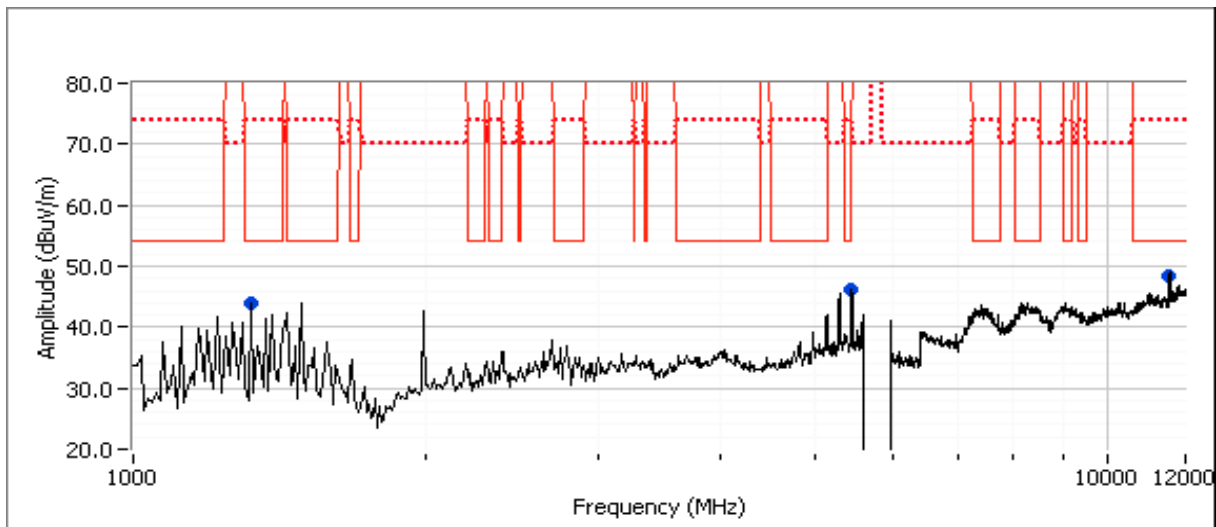



EMC Test Data

Client: Ozmo, Inc.	Job Number: J87040
Model: OZMO2000WM014A1 (RD014V4)	T-Log Number: T87366
	Account Manager: Sheareen Jacobs
Contact: Mike Schwartz	
Standard: FCC/IC 15.247, 15.407	Class: N/A

Run # 1d: EUT on Channel #157 5785MHz - 802.11a, Chain B

	Target (dBm)	Power Settings Measured (dBm)	Software Setting
Chain B			Gain_index 1

Spurious Radiated Emissions:

Frequency MHz	Level dBμV/m	Pol v/h	15.209/15.247		Detector PK/QP/Avg	Azimuth degrees	Height meters	Comments
			Limit	Margin				
11569.910	45.2	V	54.0	-8.8	AVG	74	1.0	RB 1 MHz;VB 10 Hz;Peak
11570.120	53.1	V	74.0	-20.9	PK	74	1.0	RB 1 MHz;VB 3 MHz;Peak
5457.260	41.3	V	54.0	-12.7	AVG	360	1.2	RB 1 MHz;VB 10 Hz;Peak
5458.960	52.5	V	74.0	-21.5	PK	360	1.2	RB 1 MHz;VB 3 MHz;Peak
1196.350	32.3	V	54.0	-21.7	AVG	21	1.0	RB 1 MHz;VB 10 Hz;Peak
1195.060	53.0	V	74.0	-21.0	PK	21	1.0	RB 1 MHz;VB 3 MHz;Peak

- Note 1: For emissions in restricted bands, the limit of 15.209 was used. For all other emissions, the limit is -30dBc for peak measurements in a measurement bandwidth of 100kHz.
- Note 2: Scans made between 18 - 40GHz with the measurement antenna moved around the card and its antennas 20-50cm from the device indicated there were no significant emissions in this frequency range

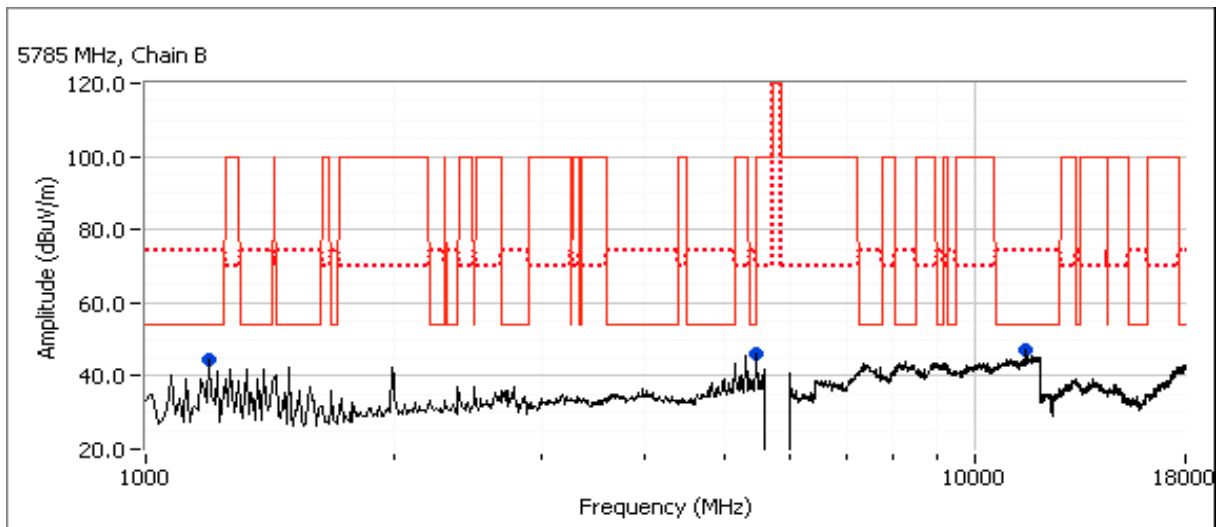



EMC Test Data

Client:	Ozmo, Inc.	Job Number:	J87040
Model:	OZMO2000WM014A1 (RD014V4)	T-Log Number:	T87366
Contact:	Mike Schwartz	Account Manager:	Sheareen Jacobs
Standard:	FCC/IC 15.247, 15.407	Class:	N/A

Run # 1e: EUT on Channel #165 5825MHz - 802.11a, Chain A

	Target (dBm)	Power Settings Measured (dBm)	Software Setting
Chain A			Gain_index 1

Spurious Radiated Emissions:

Frequency MHz	Level dB μ V/m	Pol v/h	15.209/15.247		Detector PK/QP/Avg	Azimuth degrees	Height meters	Comments
			Limit	Margin				
11650.130	48.5	V	54.0	-5.5	AVG	177	1.3	RB 1 MHz;VB 10 Hz;Peak
11649.860	55.3	V	74.0	-18.7	PK	177	1.3	RB 1 MHz;VB 3 MHz;Peak
1488.200	43.0	H	54.0	-11.0	AVG	39	1.1	RB 1 MHz;VB 10 Hz;Peak
1488.180	44.9	H	74.0	-29.1	PK	39	1.1	RB 1 MHz;VB 3 MHz;Peak

Note 1: For emissions in restricted bands, the limit of 15.209 was used. For all other emissions, the limit is -30dBc for peak measurements in a measurement bandwidth of 100kHz.

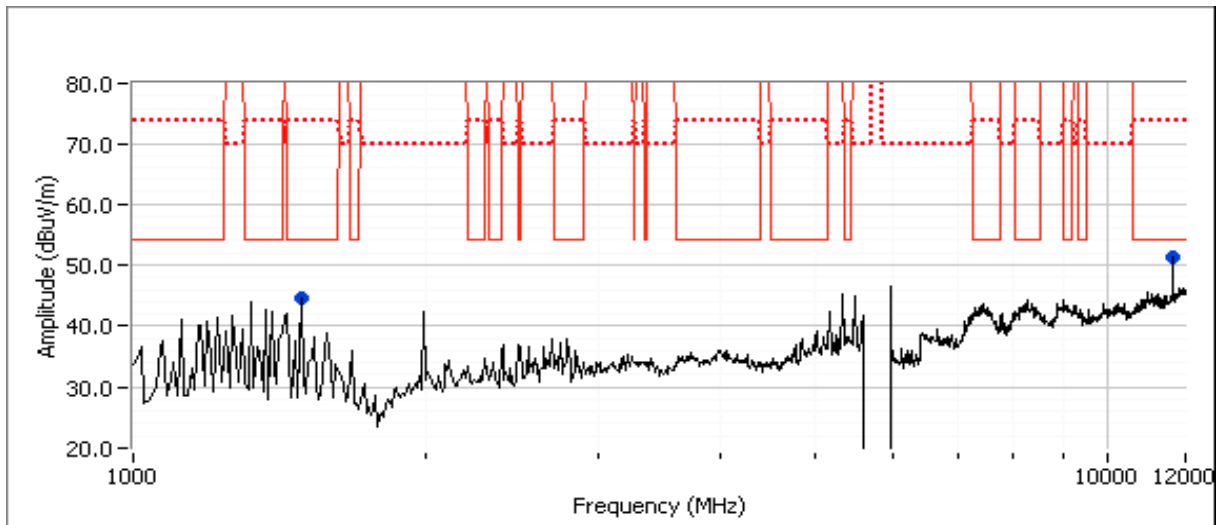



EMC Test Data

Client:	Ozmo, Inc.	Job Number:	J87040
Model:	OZMO2000WM014A1 (RD014V4)	T-Log Number:	T87366
		Account Manager:	Sheareen Jacobs
Contact:	Mike Schwartz		
Standard:	FCC/IC 15.247, 15.407	Class:	N/A

RSS 210 and FCC 15.247 (DTS) Antenna Port Measurements Power, PSD, Bandwidth and Spurious Emissions

Test Specific Details

Objective: The objective of this test session is to perform final qualification testing of the EUT with respect to the specification listed above.

Date of Test: 7/11/2012
 Test Engineer: Rafael Varelas
 Test Location: FT4

Config. Used: 1
 Config Change: None
 EUT Voltage: 3.3 Vdc

General Test Configuration

The EUT was connected to the spectrum analyzer or power meter via a suitable attenuator. All measurements were made on a single chain.

All measurements have been corrected to allow for the external attenuators used.

Ambient Conditions:

Temperature: 20.9 °C
 Rel. Humidity: 43 %

Summary of Results

Run #	Pwr setting	Test Performed	Limit	Pass / Fail	Result / Margin
1	gain_index 1	Output Power	15.247(b)	Pass	1 dBm
2		Power spectral Density (PSD)	15.247(d)	Pass	-31.9 dBm/3kHz
3		Minimum 6dB Bandwidth	15.247(a)	Pass	16.3 MHz
3		99% Bandwidth	RSS GEN	-	17.1 MHz
4		Spurious emissions	15.247(b)	Pass	All emissions below the -30dBc limit

Modifications Made During Testing

No modifications were made to the EUT during testing

Deviations From The Standard

No deviations were made from the requirements of the standard.



EMC Test Data

Client:	Ozmo, Inc.	Job Number:	J87040
Model:	OZMO2000WM014A1 (RD014V4)	T-Log Number:	T87366
		Account Manager:	Sheareen Jacobs
Contact:	Mike Schwartz		
Standard:	FCC/IC 15.247, 15.407	Class:	N/A

Notes:

Sample: 0126000595E3

EUT Software:



EMC Test Data

Client:	Ozmo, Inc.	Job Number:	J87040
Model:	OZMO2000WM014A1 (RD014V4)	T-Log Number:	T87366
Contact:	Mike Schwartz	Account Manager:	Sheareen Jacobs
Standard:	FCC/IC 15.247, 15.407	Class:	N/A

Run #1: Output Power

Power Setting ²	Frequency (MHz)	Output Power		Antenna Gain (dBi)	Result	EIRP ^{Note 2}		Output Power	
		(dBm) ¹	mW			dBm	W	(dBm) ³	mW
gain_index 1	5745	1.0	1.259	2.0	Pass	3.0	0.002	1.1	1.288
	5785	0.2	1.054	2.0	Pass	2.2	0.002	0.4	1.096
	5825	0.7	1.175	2.0	Pass	2.7	0.002	0.1	1.023

- Note 1: Output power measured using an ESIB analyzer (see plots below) with Gated Power, RBW=1MHz, VB=3 MHz, sample detector, power averaging on (transmitted signal was continuous) and power integration over 50 MHz (option #2, method 1 in KDB 558074, equivalent to method 1 of DA-02-2138A1 for U-NII devices). Spurious limit becomes -30dBc.
- Note 2: Power setting - the software power setting used during testing, included for reference only.
- Note 3: Power measured using average power meter and is included for reference only.

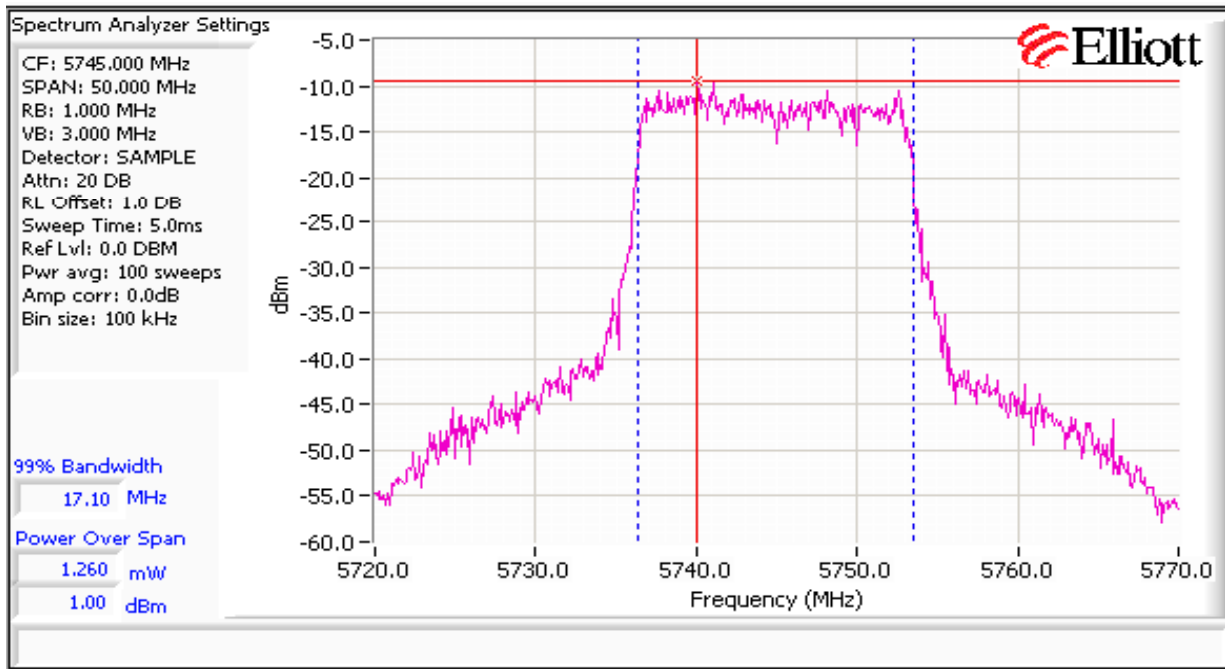

Client: Ozmo, Inc.	Job Number: J87040
Model: OZMO2000WM014A1 (RD014V4)	T-Log Number: T87366
	Account Manager: Sheareen Jacobs
Contact: Mike Schwartz	
Standard: FCC/IC 15.247, 15.407	Class: N/A

Run #2: Power spectral Density

Power Setting	Frequency (MHz)	PSD	Limit dBm/3kHz	Result
		(dBm/3kHz) ^{Note 1}		
gain_index 1	5745	-31.9	8.0	Pass
	5785	-33.4	8.0	Pass
	5825	-34.1	8.0	Pass

Note 1: Power spectral density measured using RB=3 kHz, VB=10kHz, analyzer with peak detector and with a sweep time set to ensure a dwell time of at least 1 second per 3kHz. The measurement is made at the frequency of PPSD determined from preliminary scans using RB=3kHz using multiple sweeps at a faster rate over the 6dB bandwidth of the signal.

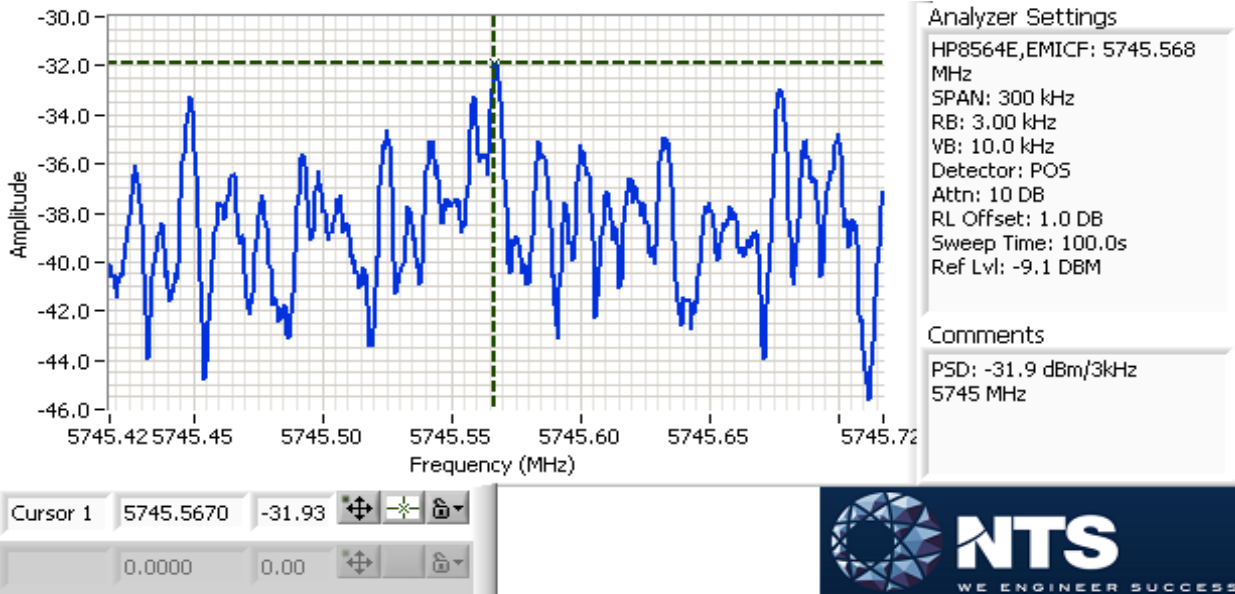

Client: Ozmo, Inc.	Job Number: J87040
Model: OZMO2000WM014A1 (RD014V4)	T-Log Number: T87366
	Account Manager: Sheareen Jacobs
Contact: Mike Schwartz	
Standard: FCC/IC 15.247, 15.407	Class: N/A

Run #3: Signal Bandwidth

Power Setting	Frequency (MHz)	Resolution Bandwidth	Bandwidth (MHz)	
			6dB	99%
gain_index 1	5745	100kHz	16.4	17.1
	5785	100kHz	16.4	17.0
	5825	100kHz	16.3	17.0

Note 1: 99% bandwidth measured in accordance with RSS GEN, with RB > 1% of the span and VB > 3xRB

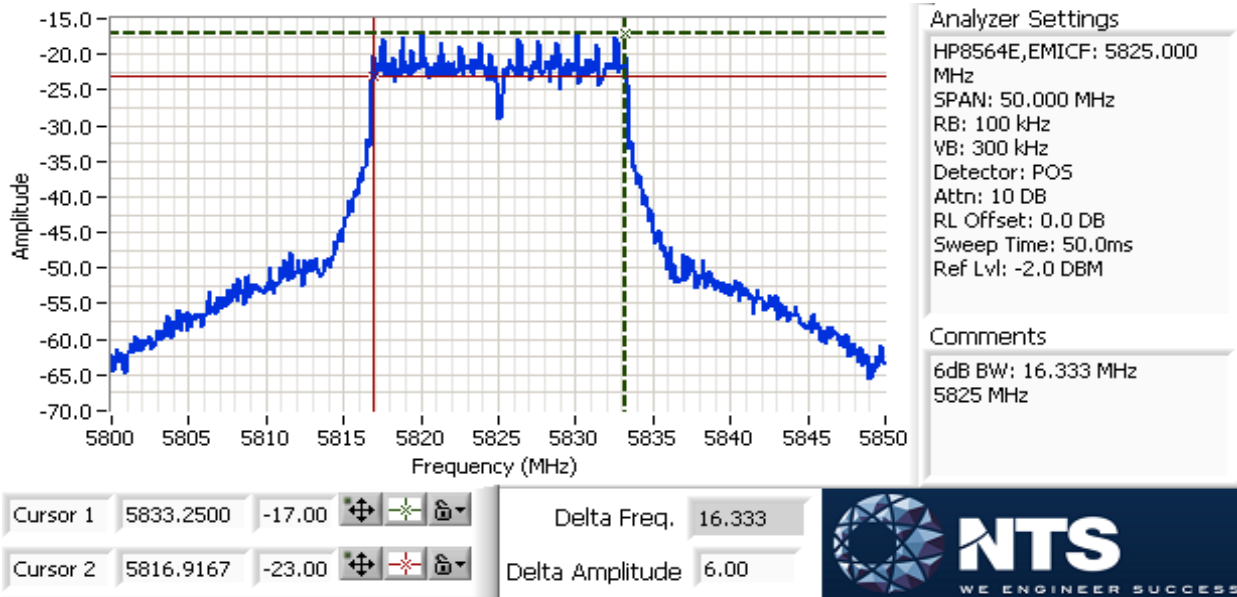

Client: Ozmo, Inc.	Job Number: J87040
Model: OZMO2000WM014A1 (RD014V4)	T-Log Number: T87366
	Account Manager: Sheareen Jacobs
Contact: Mike Schwartz	
Standard: FCC/IC 15.247, 15.407	Class: N/A

Run #4: Out of Band Spurious Emissions

Frequency (MHz)	Limit	Power Setting	Result
802.11a mode			
5745	-30dBc	gain_index 1	Pass
5785	-30dBc		Pass
5825	-30dBc		Pass

Plots for low channel

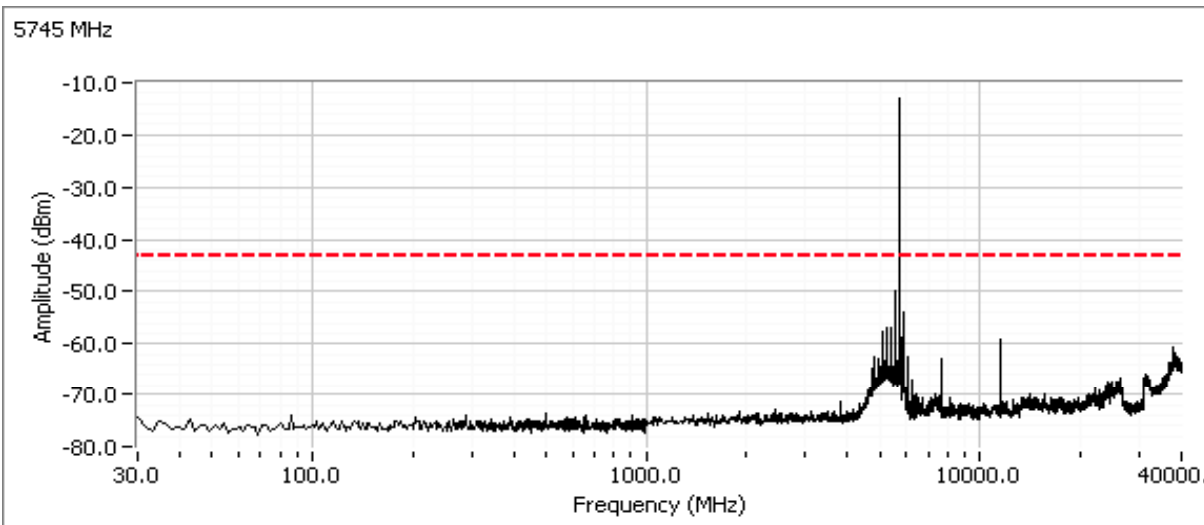

Additional plot from 5715 - 5755 MHz showing compliance with -30dBc at the band edge.

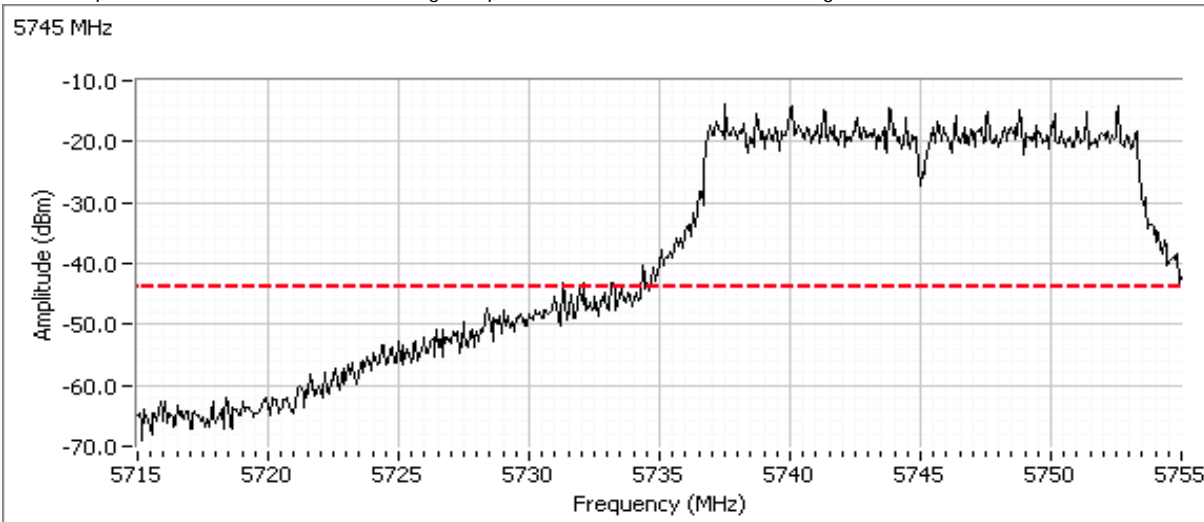

Client: Ozmo, Inc.	Job Number: J87040
Model: OZMO2000WM014A1 (RD014V4)	T-Log Number: T87366
	Account Manager: Sheareen Jacobs
Contact: Mike Schwartz	
Standard: FCC/IC 15.247, 15.407	Class: N/A

Plots for center channel

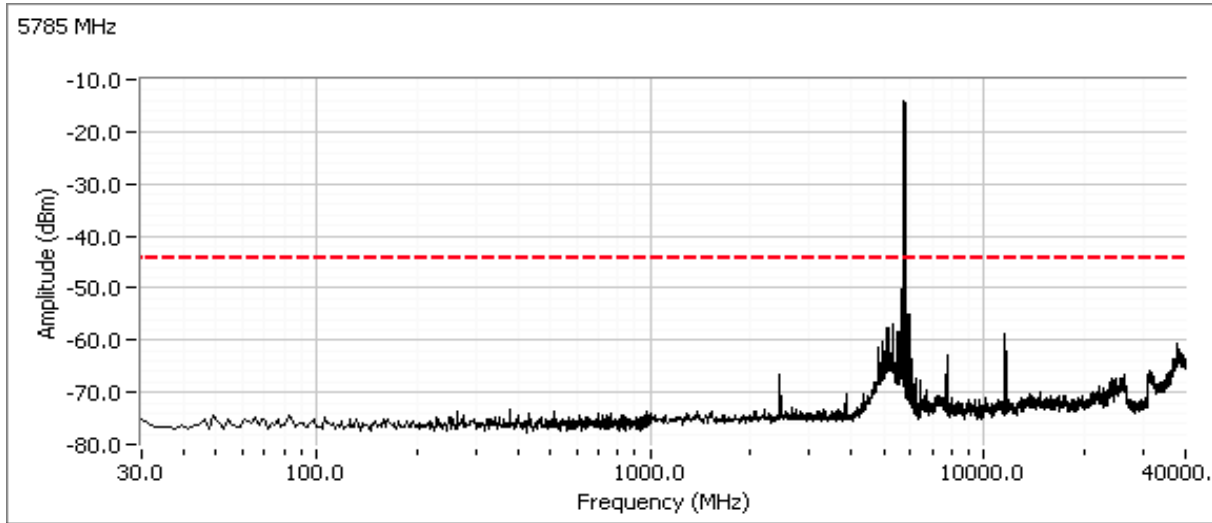

Client: Ozmo, Inc.	Job Number: J87040
Model: OZMO2000WM014A1 (RD014V4)	T-Log Number: T87366
	Account Manager: Sheareen Jacobs
Contact: Mike Schwartz	
Standard: FCC/IC 15.247, 15.407	Class: N/A

Plots for high channel

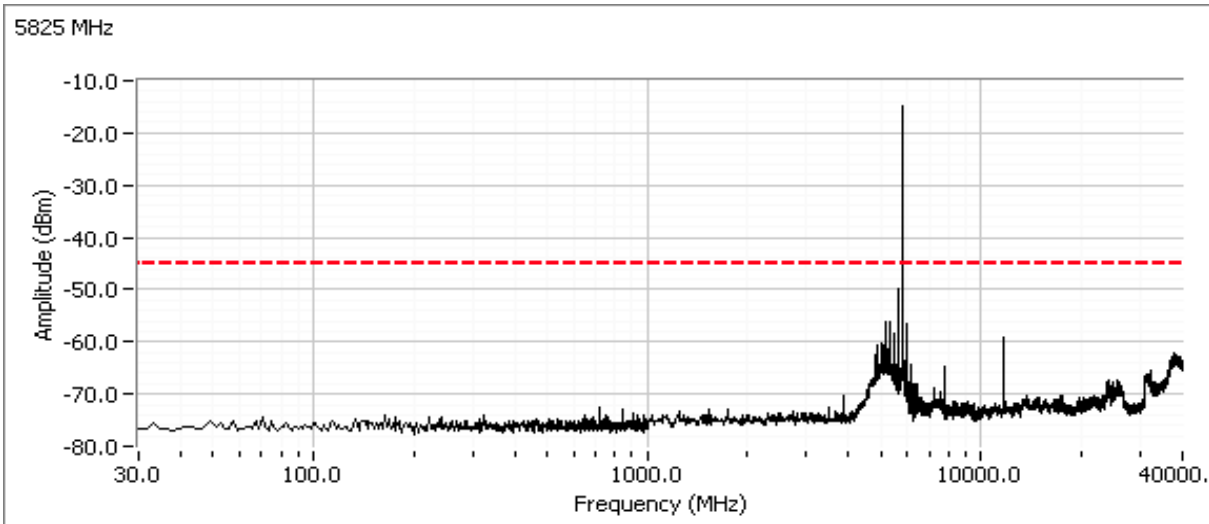

Additional plot from 5795 - 5860 MHz showing compliance with -30dBc at the band edge.

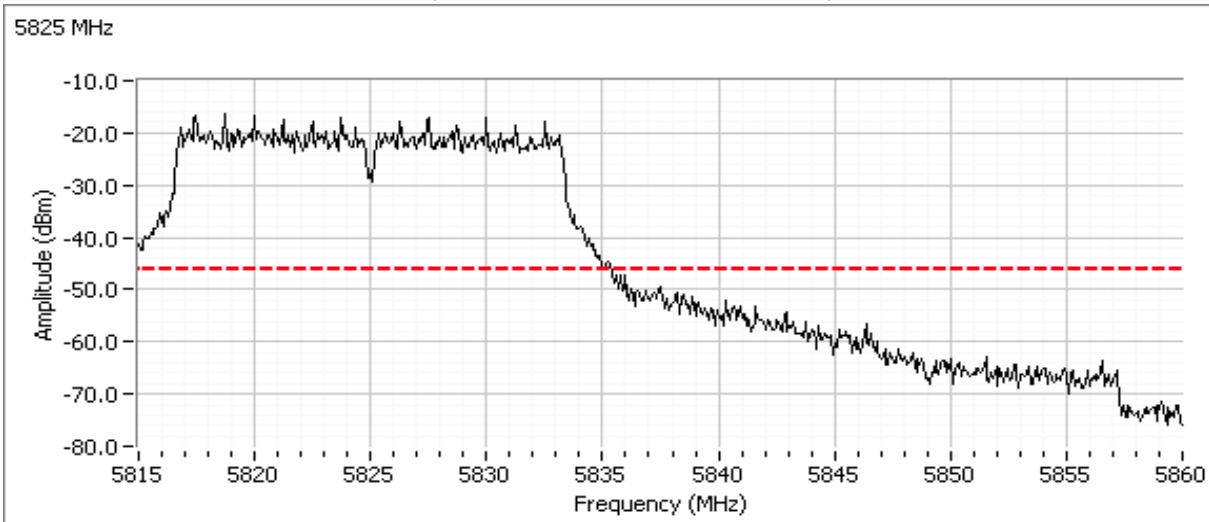



EMC Test Data

Client: Ozmo, Inc.	Job Number: J87040
Model: OZMO2000WM014A1 (RD014V4)	T-Log Number: T87366
	Account Manager: Sheareen Jacobs
Contact: Mike Schwartz	
Standard: FCC/IC 15.247, 15.407	Class: -

Conducted Emissions

(Elliott Laboratories Fremont Facility, Semi-Anechoic Chamber)

Test Specific Details

Objective: The objective of this test session is to perform final qualification testing of the EUT with respect to the specification listed above.

Date of Test: 4/12/2012	Config. Used: Tx Mode Full Power Low channel
Test Engineer: Michael Findley	Config Change: none
Test Location: Fremont Chamber #7	EUT Voltage: 120V/60Hz

General Test Configuration

For tabletop equipment, the EUT and host system was located on a wooden table inside the semi-anechoic chamber, 40 cm from a vertical coupling plane and 80cm from the LISN.

Ambient Conditions: Temperature: 19 °C
 Rel. Humidity: 39 %

Summary of Results

Run #	Test Performed	Limit	Result	Margin
1	CE, AC Power, 120V/60Hz	Class B	Pass	31.6 dBµV @ 0.335 MHz (-17.7 dB)

Modifications Made During Testing

No modifications were made to the EUT during testing

Deviations From The Standard

No deviations were made from the requirements of the standard.

Client: Ozmo, Inc.	Job Number: J87040
Model: OZMO2000WM014A1 (RD014V4)	T-Log Number: T87366
	Account Manager: Sheareen Jacobs
Contact: Mike Schwartz	
Standard: FCC/IC 15.247, 15.407	Class: -

Run #1: AC Power Port Conducted Emissions, 0.15 - 30MHz, 120V/60Hz

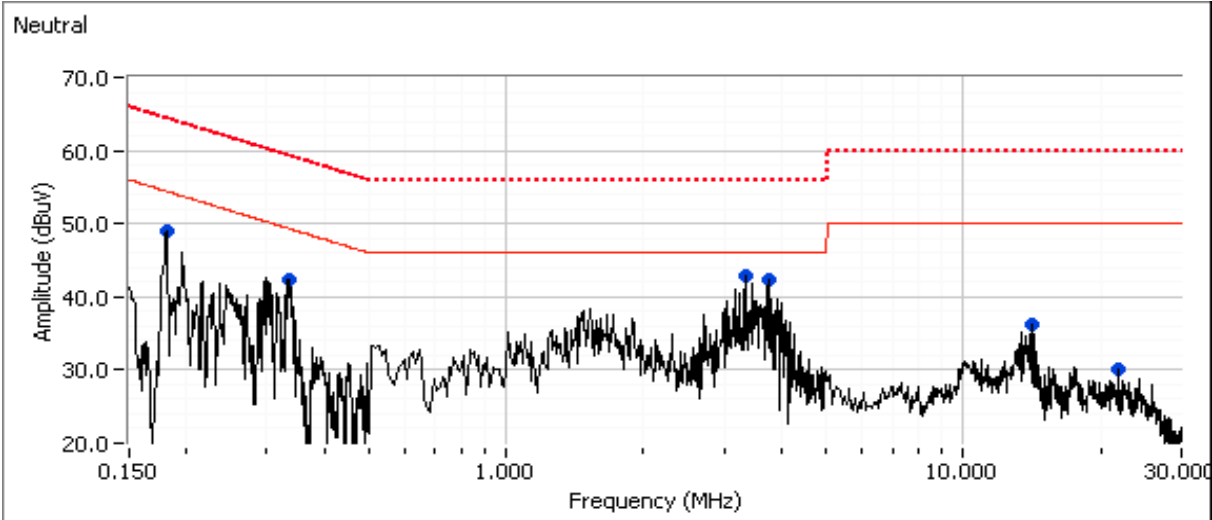
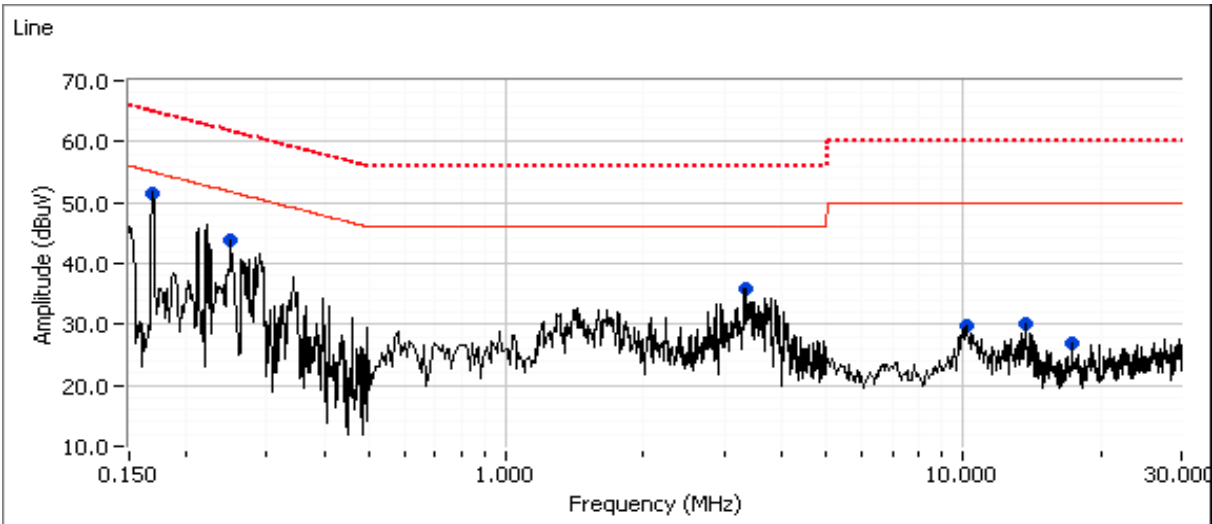



EMC Test Data

Client:	Ozmo, Inc.	Job Number:	J87040
Model:	OZMO2000WM014A1 (RD014V4)	T-Log Number:	T87366
Contact:	Mike Schwartz	Account Manager:	Sheareen Jacobs
Standard:	FCC/IC 15.247, 15.407	Class:	-

Preliminary peak readings captured during pre-scan (peak readings vs. average limit)

Frequency MHz	Level dB μ V	AC Line	Class B		Detector QP/Ave	Comments
			Limit	Margin		
0.168	51.6	Line 1	55.0	-3.4	Peak	
0.250	43.8	Line 1	51.8	-8.0	Peak	
3.347	36.0	Line 1	46.0	-10.0	Peak	
10.146	29.7	Line 1	50.0	-20.3	Peak	
13.674	30.2	Line 1	50.0	-19.8	Peak	
17.263	26.8	Line 1	50.0	-23.2	Peak	
0.180	49.1	Neutral	54.4	-5.3	Peak	
0.335	42.3	Neutral	49.3	-7.0	Peak	
3.340	43.0	Neutral	46.0	-3.0	Peak	
3.740	42.3	Neutral	46.0	-3.7	Peak	
14.185	36.1	Neutral	50.0	-13.9	Peak	
21.838	30.1	Neutral	50.0	-19.9	Peak	

Final quasi-peak and average readings

Frequency MHz	Level dB μ V	AC Line	Class B		Detector QP/Ave	Comments
			Limit	Margin		
0.335	31.6	Neutral	49.3	-17.7	AVG	AVG (0.10s)
0.335	41.3	Neutral	59.3	-18.0	QP	QP (1.00s)
14.185	30.9	Neutral	50.0	-19.1	AVG	AVG (0.10s)
0.250	42.0	Line 1	61.8	-19.8	QP	QP (1.00s)
0.168	45.2	Line 1	65.1	-19.9	QP	QP (1.00s)
0.250	31.2	Line 1	51.8	-20.6	AVG	AVG (0.10s)
0.180	43.8	Neutral	64.5	-20.7	QP	QP (1.00s)
3.340	35.3	Neutral	56.0	-20.7	QP	QP (1.00s)
3.740	35.2	Neutral	56.0	-20.8	QP	QP (1.00s)
3.740	23.7	Neutral	46.0	-22.3	AVG	AVG (0.10s)
3.340	23.6	Neutral	46.0	-22.4	AVG	AVG (0.10s)
13.674	24.6	Line 1	50.0	-25.4	AVG	AVG (0.10s)
3.347	29.6	Line 1	56.0	-26.4	QP	QP (1.00s)
14.185	33.1	Neutral	60.0	-26.9	QP	QP (1.00s)
3.347	18.2	Line 1	46.0	-27.8	AVG	AVG (0.10s)
0.180	25.5	Neutral	54.5	-29.0	AVG	AVG (0.10s)
10.146	18.1	Line 1	50.0	-31.9	AVG	AVG (0.10s)
13.674	27.9	Line 1	60.0	-32.1	QP	QP (1.00s)
0.168	22.1	Line 1	55.1	-33.0	AVG	AVG (0.10s)
21.838	16.9	Neutral	50.0	-33.1	AVG	AVG (0.10s)
10.146	24.5	Line 1	60.0	-35.5	QP	QP (1.00s)
17.263	13.0	Line 1	50.0	-37.0	AVG	AVG (0.10s)
21.838	22.6	Neutral	60.0	-37.4	QP	QP (1.00s)
17.263	18.8	Line 1	60.0	-41.2	QP	QP (1.00s)

End of Report

This page is intentionally blank and marks the last page of this test report.