

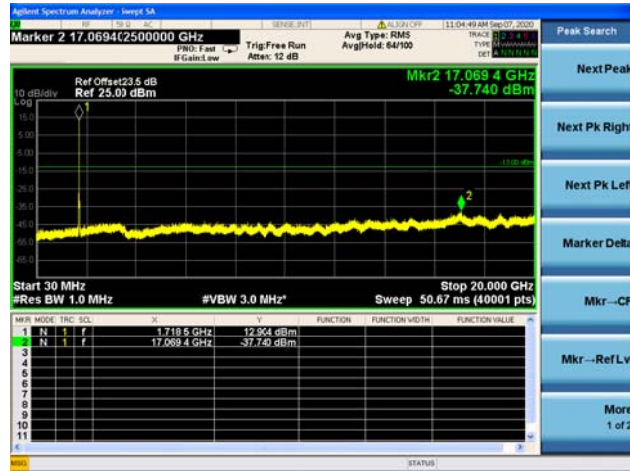

Band 4 / 10MHz / Low CH / QPSK

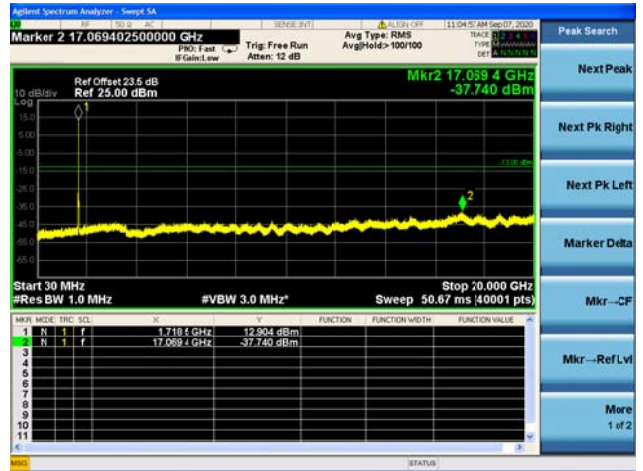

Band 4 / 10MHz / Low CH / 16QAM



Band 4 / 10MHz / Mid CH / QPSK

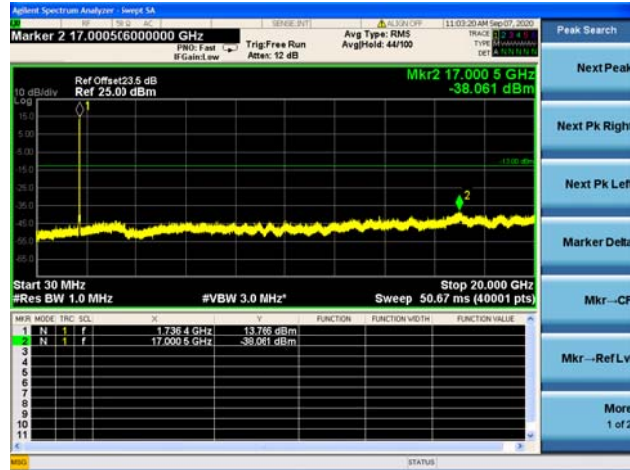

Band 4 / 10MHz / Mid CH / 16QAM

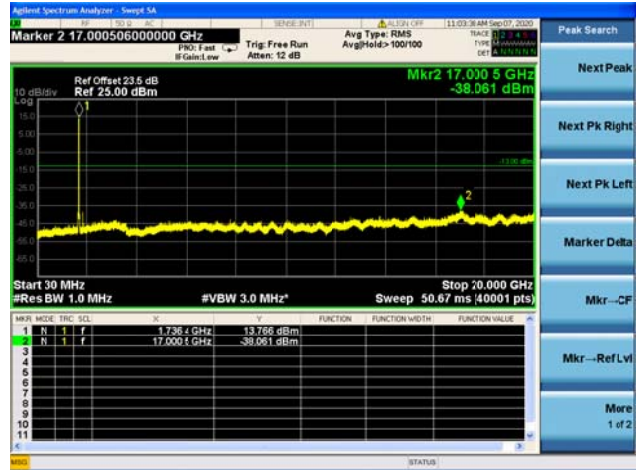

Band 4 / 10MHz / High CH / QPSK

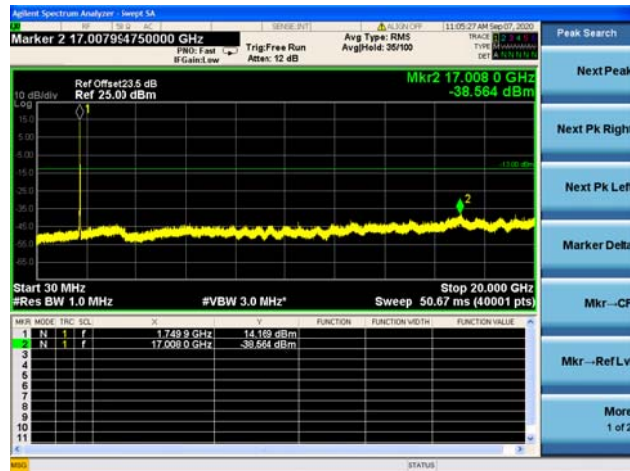

Band 4 / 10MHz / High CH / 16QAM

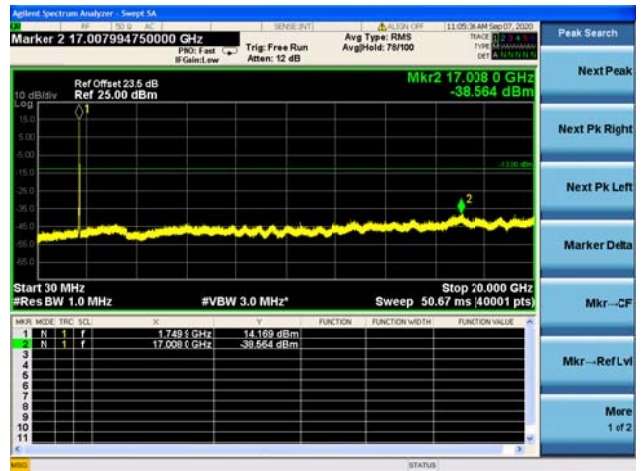

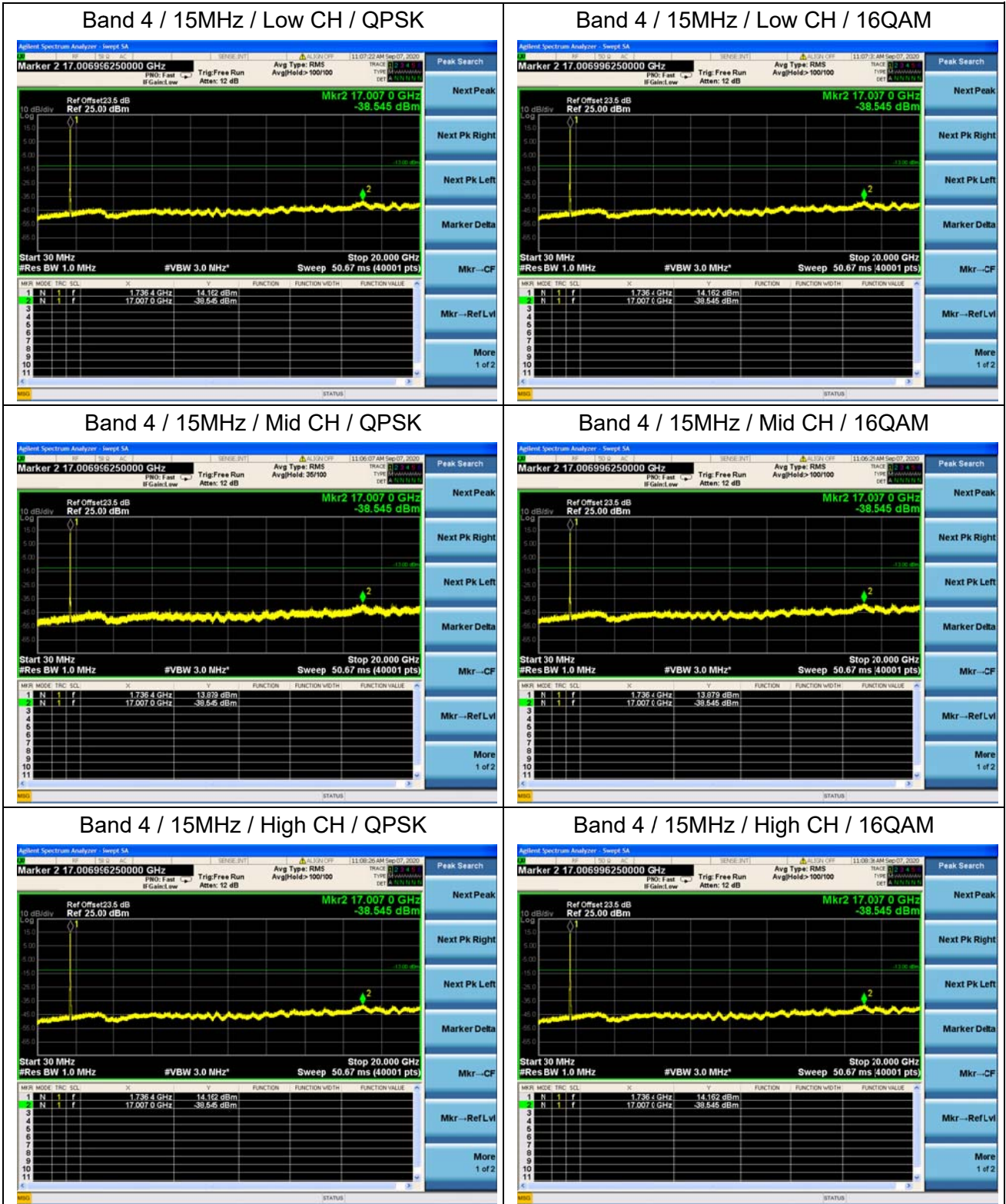

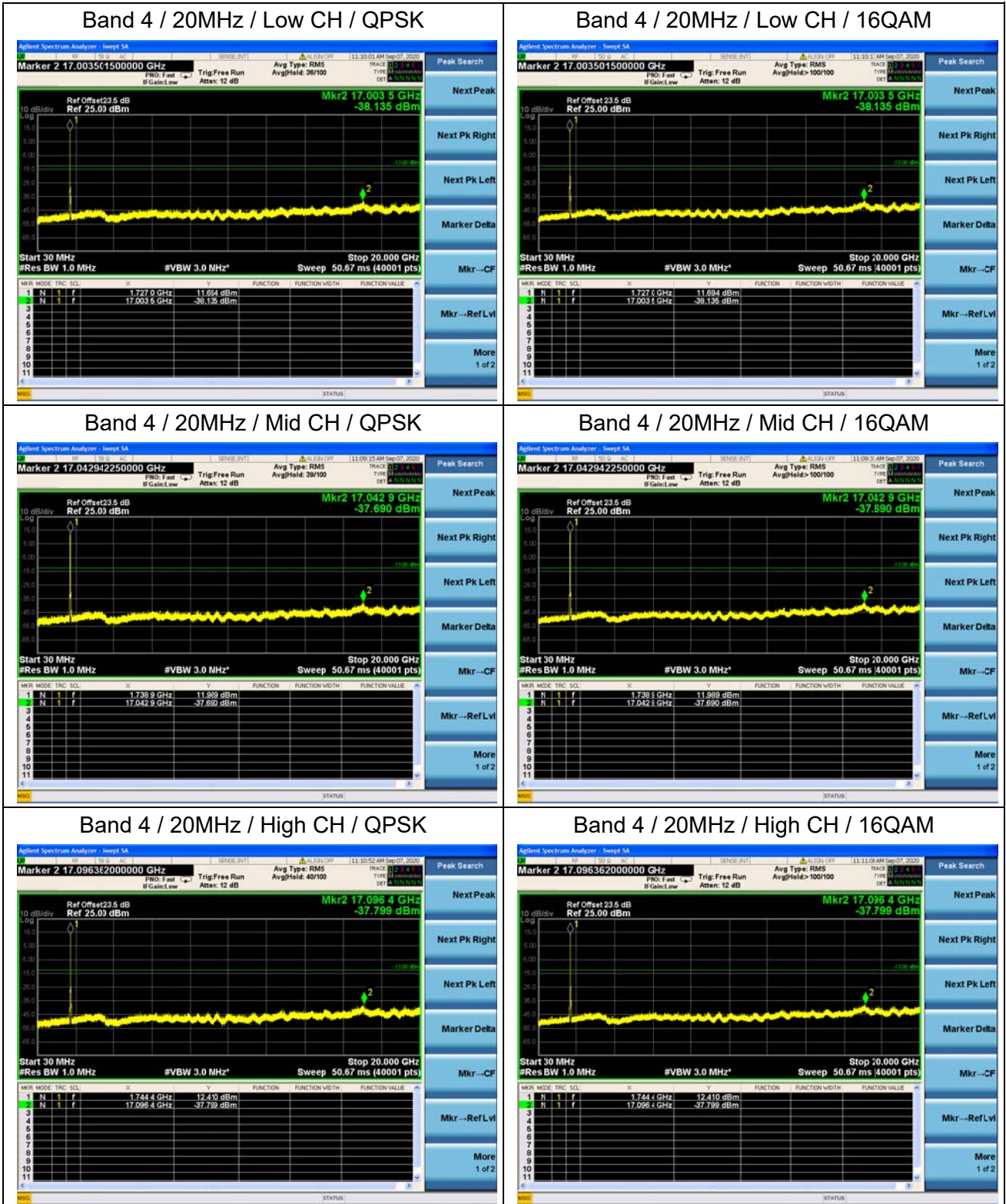



Band 13 / 5MHz / Low CH / QPSK

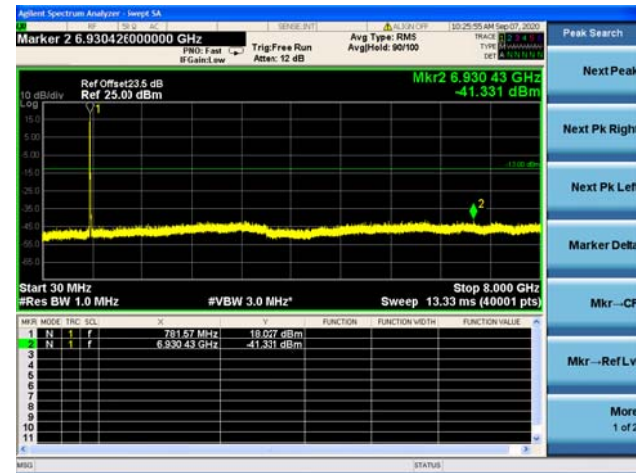

Band 13 / 5MHz / Low CH / 16QAM

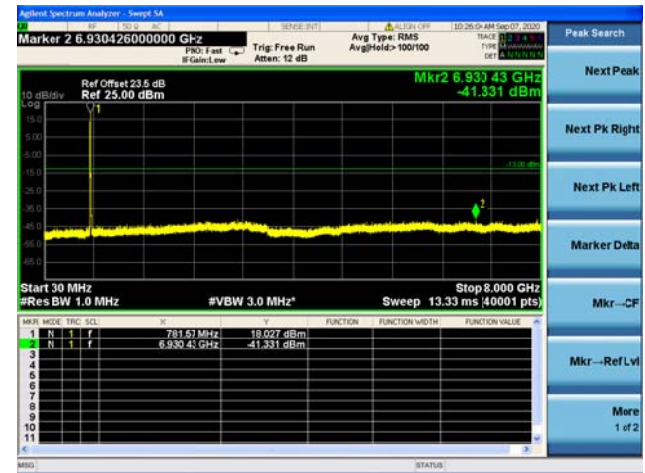

Band 13 / 5MHz / Mid CH / QPSK

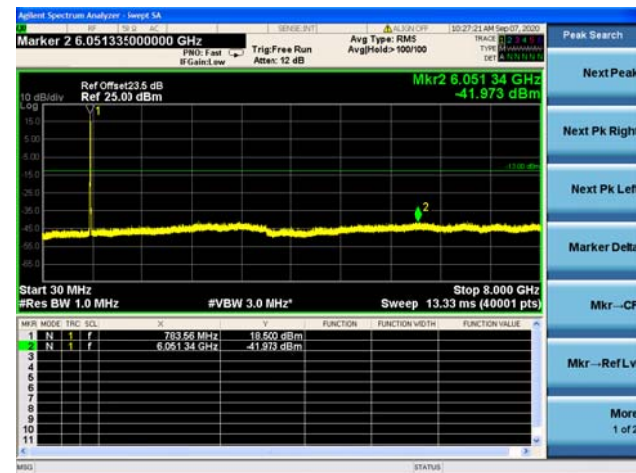

Band 13 / 5MHz / Mid CH / 16QAM

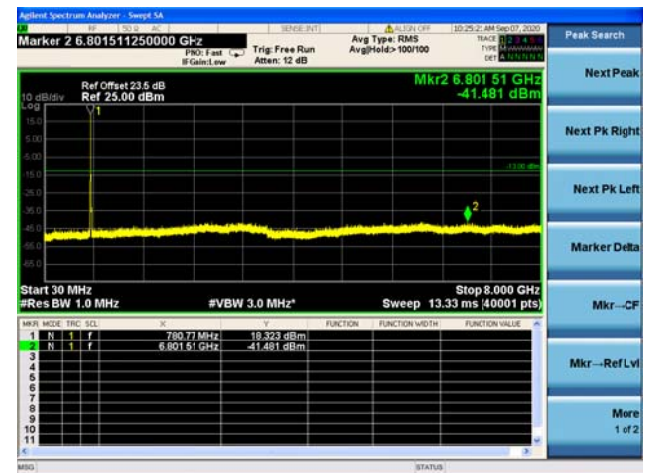

Band 13 / 5MHz / High CH / QPSK

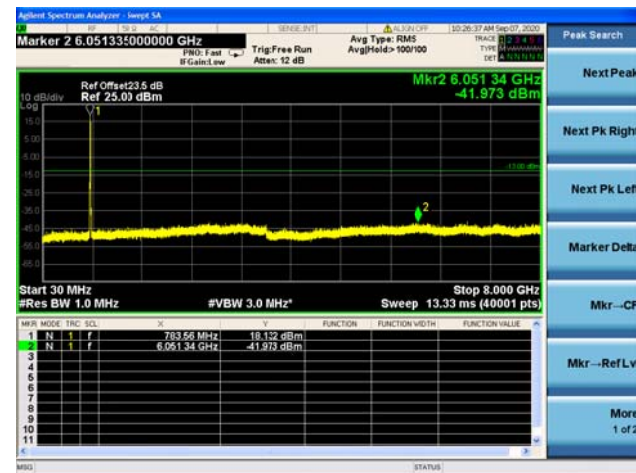

Band 13 / 5MHz / High CH / 16QAM

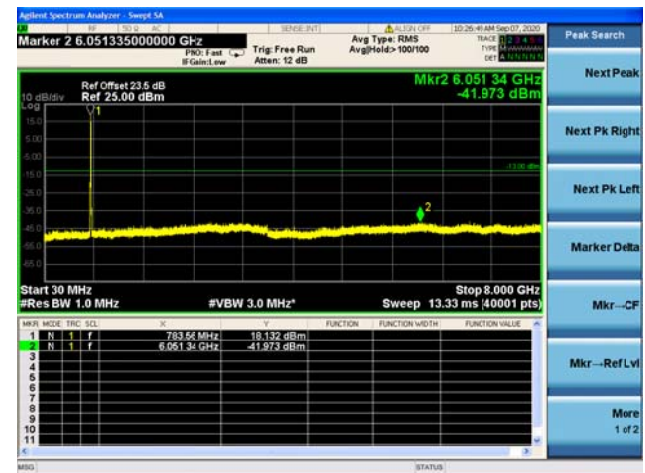

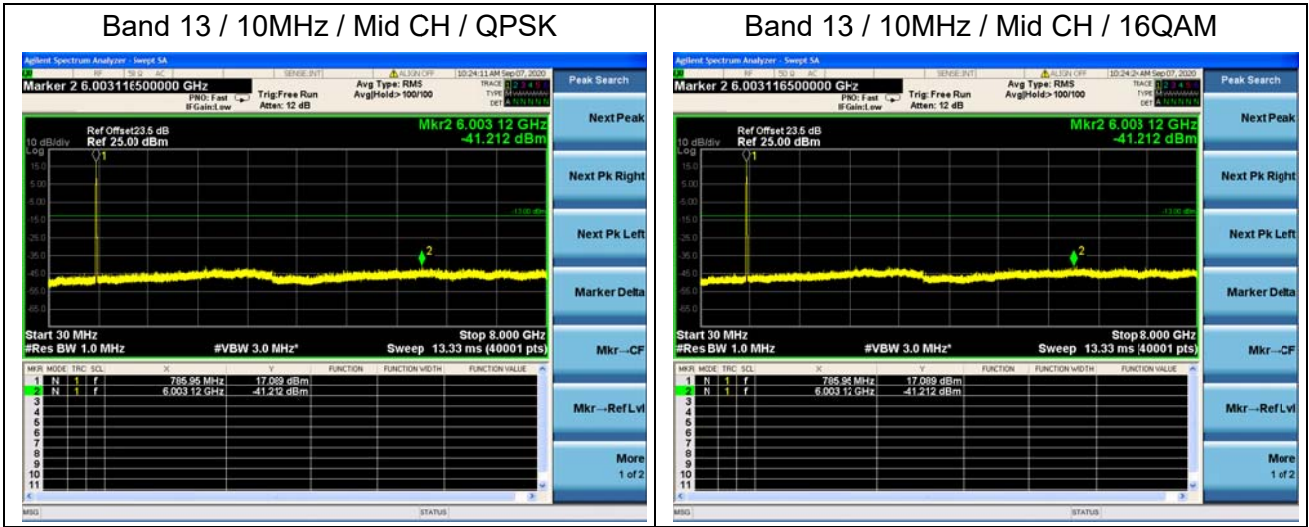

2.6. Band Edge

2.6.1. Requirement

According to FCC section 24.238(a), the power of any emission outside of the authorized operating frequency ranges must be attenuated below the transmitting power (P) by a factor of at least $43 + 10 \log(P)$ dB.

According to FCC section 27.53(h), For operations in the 1710–1755MHz bands, the power of any emission outside a licensee's frequency block shall be attenuated below the transmitter power (P) by at least $43 + 10 \log_{10}(P)$ dB.

2.6.2. Test Description

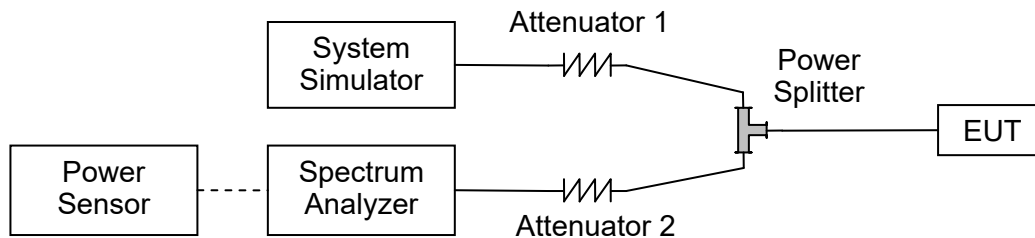

The EUT is coupled to the Spectrum Analyzer (SA) and the System Simulator (SS) with Attenuators through the Power Splitter; the RF load attached to the EUT antenna terminal is 50Ohm; the path loss as the factor is calibrated to correct the reading. The EUT is commanded by the SS to operate at the maximum output power. A call is established between the EUT and the SS.

2.6.3. Test procedure

KDB 971168 D01v03 Section 6.0 and ANSI/TIA-603-E-2016.

2.6.4. Test Result

The center frequency of spectrum is the band edge frequency and span is 2MHz, Record the max trace into the test report.



Band 4 / 1.4MHz / Low CH / QPSK / 1 RB



Band 4 / 1.4MHz / Low CH / QPSK / FULL RB



Band 4 / 1.4MHz / High CH / QPSK / 1 RB



Band 4 / 1.4MHz / High CH / QPSK / FULL RB





Band 4 / 3MHz / Low CH / QPSK / 1 RB

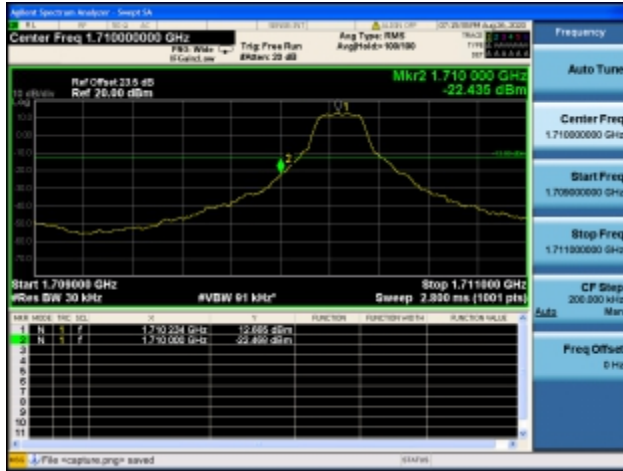

Band 4 / 3MHz / Low CH / QPSK / FULL RB



Band 4 / 3MHz / High CH / QPSK / 1 RB



Band 4 / 3MHz / High CH / QPSK / FULL RB





Band 4 / 5MHz / Low CH / QPSK / 1 RB



Band 4 / 5MHz / Low CH / QPSK / FULL RB



Band 4 / 5MHz / High CH / QPSK / 1 RB

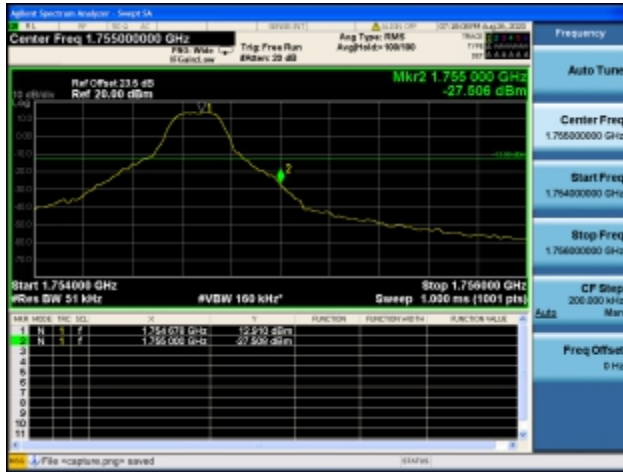

Band 4 / 5MHz / High CH / QPSK / FULL RB





Band 4 / 10MHz / Low CH / QPSK / 1 RB



Band 4 / 10MHz / Low CH / QPSK / FULL RB



Band 4 / 10MHz / High CH / QPSK / 1 RB



Band 4 / 10MHz / High CH / QPSK / FULL RB





Band 4 / 15MHz / Low CH / QPSK / 1 RB



Band 4 / 15MHz / Low CH / QPSK / FULL RB



Band 4 / 15MHz / High CH / QPSK / 1 RB



Band 4 / 15MHz / High CH / QPSK / FULL RB





Band 4 / 20MHz / Low CH / QPSK / 1 RB



Band 4 / 20MHz / Low CH / QPSK / FULL RB



Band 4 / 20MHz / High CH / QPSK / 1 RB



Band 4 / 20MHz / High CH / QPSK / FULL RB





Band 13 / 5MHz / Low CH / QPSK / 1 RB



Band 13 / 5MHz / Low CH / QPSK / FULL RB

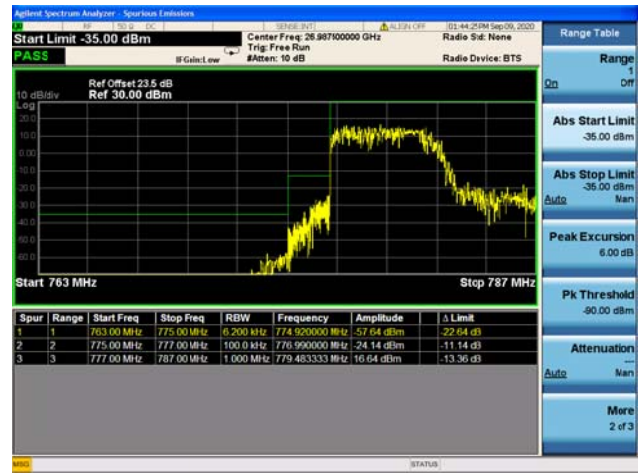

Band 13 / 5MHz / High CH / QPSK / 1 RB



Band 13 / 5MHz / High CH / QPSK / FULL RB

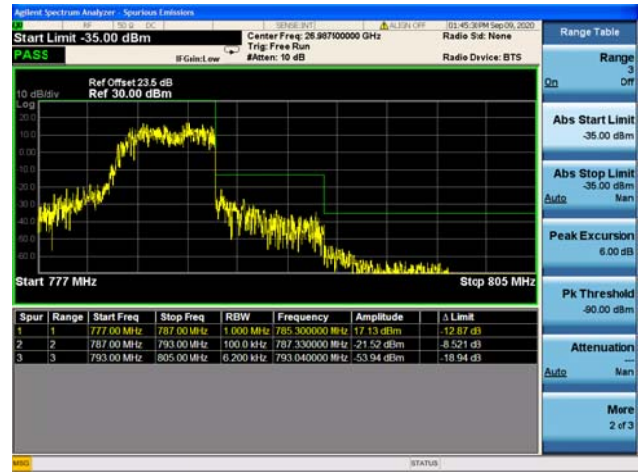

Band 13 / 10MHz / Low CH / QPSK / 1 RB



Band 13 / 10MHz / Low CH / QPSK / FULL RB

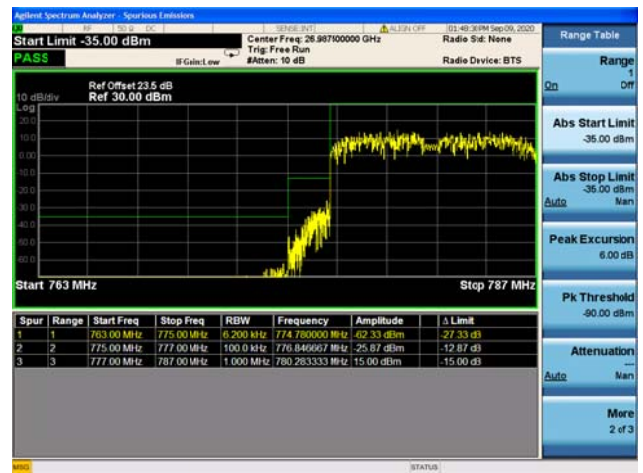



Band 13 / 10MHz / High CH / QPSK / 1 RB

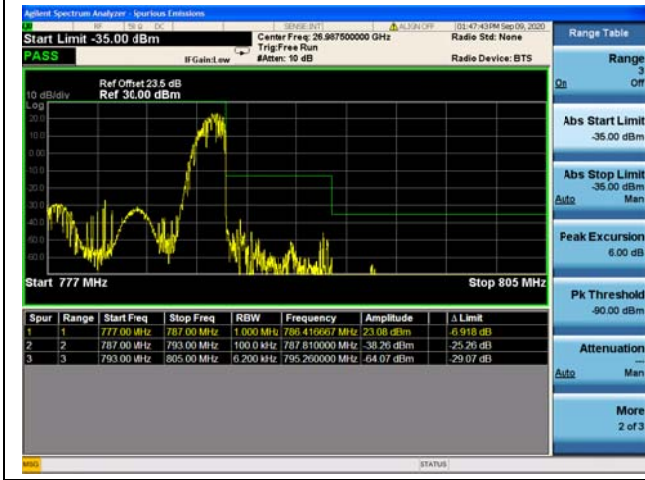

Band 13 / 10MHz / High CH / QPSK / FULL RB

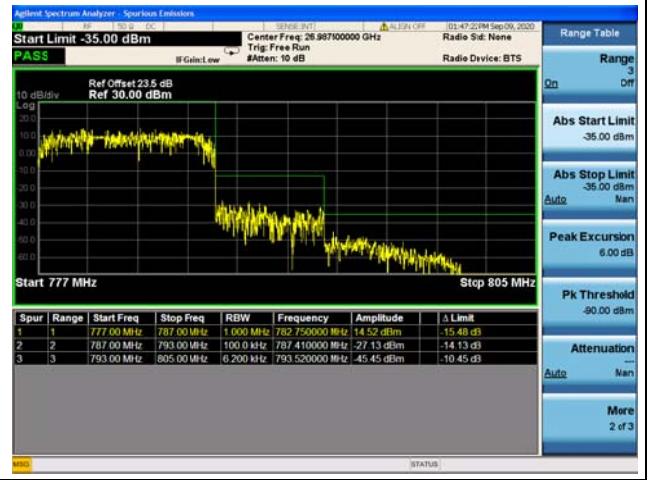

2.7. Radiated Spurious Emissions

2.7.1. Requirement

According to FCC section 2.1051, the power of any emission outside of the authorized operating frequency ranges must be attenuated below the transmitting power (P) by a factor of at least $43+10*\log(P)$ dB. This calculated to be -13dBm.

2.7.2. Test Description

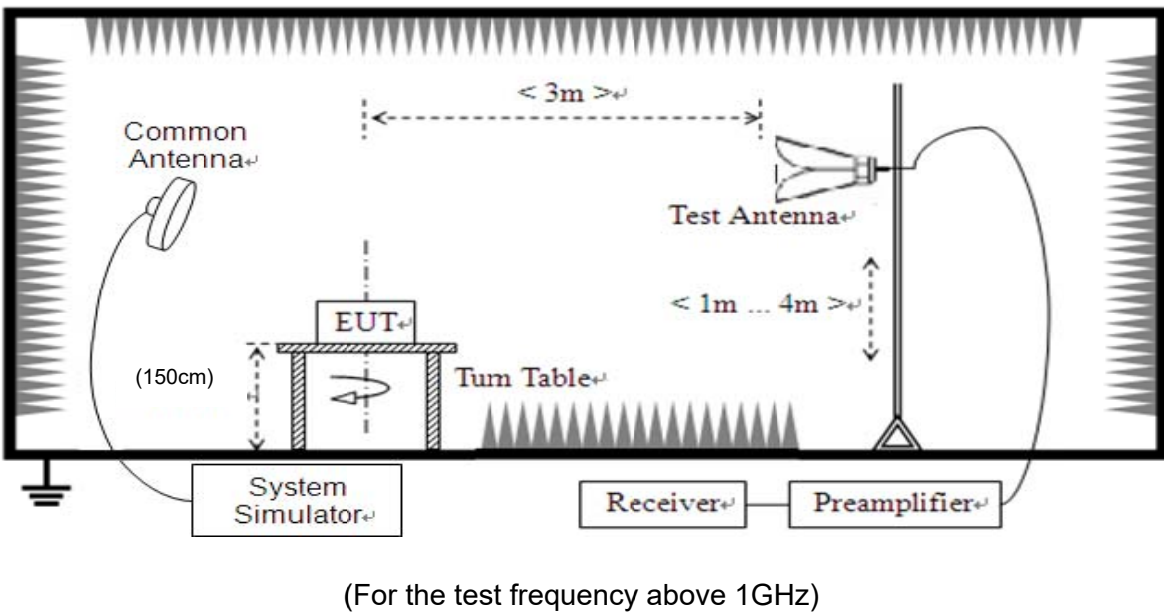
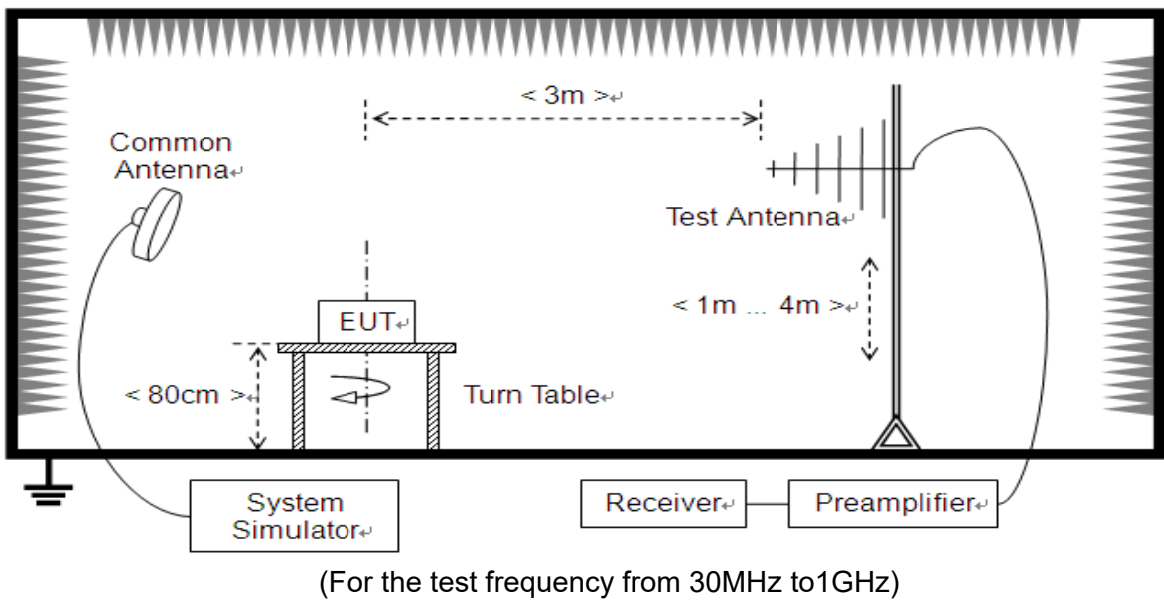



The EUT is located in a 3m Full-Anechoic Chamber, the cable loss, air loss and so on of the site as factors are pre-calibrated using the "Substitution" method, and calculated to correct the reading. A call is established between the EUT and the SS via a Common Antenna. The EUT is commanded by the SS to operate at the maximum and minimum output power, and only the test result of the maximum output power was recorded.

In the frequency range above 30MHz, Bi-Log Test Antenna (30MHz to 1GHz) and Horn Test Antenna (above 1GHz) are used. Test Antenna is 3m away from the EUT. Test Antenna height is varied from 1m to 4m above the ground and the Turn Table is actuated to turn from 0° to 360° to determine the maximum value of the radiated power. The emission levels at both horizontal and vertical polarizations should be tested. The Filters consists of Notch Filters and High Pass Filter.

Note: when doing measurements above 1GHz, the EUT has been within the 3dB cone width of the horn antenna during horizontal antenna.

2.7.3. Test procedure

KDB 971168 D01v03 Section 5.8 and ANSI/TIA-603-E-2016.

Spectrum setting:

(c) For operations in the 776-788 MHz band, the power of any emission outside the licensee's frequency band(s) of operation shall be attenuated below the transmitter power (P) within the licensed band(s) of operation, measured in watts, in accordance with the following:

(2) On any frequency outside the 776-788 MHz band, the power of any emission shall be attenuated outside the band below the transmitter power (P) by at least $43 + 10 \log (P)$ dB;

(4) On all frequencies between 763-775 MHz and 793-805 MHz, by a factor not less than $65 + 10 \log (P)$ dB in a 6.25 kHz band segment, for mobile and portable stations;

(5) Compliance with the provisions of paragraphs (c)(2) of this section is based on the use of measurement instrumentation employing a resolution bandwidth of 100 kHz or greater. However, in the 100 kHz bands immediately outside and adjacent to the frequency block, a resolution bandwidth of at least 30 kHz may be employed;

(6) Compliance with the provisions of paragraphs (c)(4) of this section is based on the use of measurement instrumentation such that the reading taken with any resolution bandwidth setting should be adjusted to indicate spectral energy in a 6.25 kHz segment.

(f) For operations in the 746-758 MHz, 775-788 MHz, and 805-806 MHz bands, emissions in the band 1559-1610 MHz shall be limited to -70 dBW/MHz equivalent isotropically radiated power (EIRP) for wideband signals, and -80 dBW EIRP for discrete emissions of less than 700 Hz bandwidth.

(h) Operations in the 1710-1755 MHz bands, the power of any emission outside a licensee's frequency block shall be attenuated below the transmitter power (P) in watts by at least $43 + 10 \log_{10} (P)$ dB.

(3) Compliance with this provision is based on the use of measurement instrumentation employing



a resolution bandwidth of 1 megahertz or greater. However, in the 1 megahertz bands immediately outside and adjacent to the licensee's frequency block, a resolution bandwidth of at least one percent of the emission bandwidth of the fundamental emission of the transmitter may be employed. The emission bandwidth is defined as the width of the signal between two points, one below the carrier center frequency and one above the carrier center frequency, outside of which all emissions are attenuated at least 26 dB below the transmitter power.

2.7.4. Test Result

LTE Band 4 20MHz BW, Low Channel, QPSK

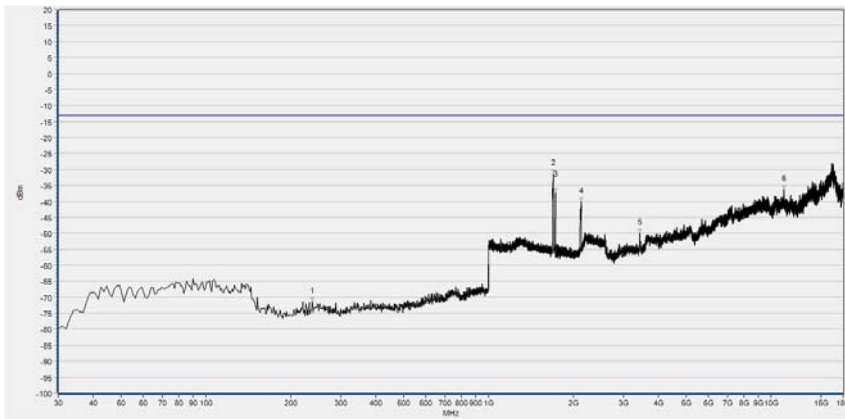

No.	Fre. (MHz)	Peak(dBm)	Limit PK(dBm)	Antenna	Verdict
1	237.580	-71.45	-13.00	Horizontal	PASS
2	1694.038	-31.39	-13.00	Horizontal	N/A
3	1727.971	-37.30	-13.00	Horizontal	N/A
4	2125.570	-40.15	-13.00	Horizontal	N/A
5	3434.552	-49.92	-13.00	Horizontal	PASS
6	11135.952	-36.27	-13.00	Horizontal	PASS

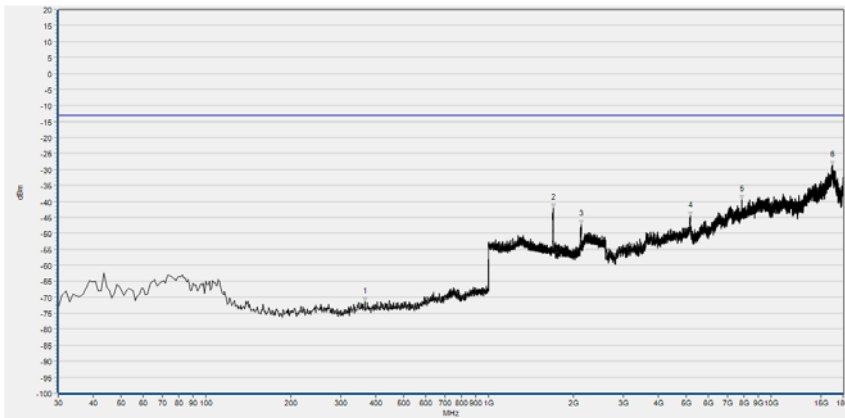

No.	Fre. (MHz)	Peak(dBm)	Limit PK(dBm)	Antenna	Verdict
1	365.620	-71.40	-13.00	Vertical	PASS
2	1693.397	-42.07	-13.00	Vertical	N/A
3	2126.210	-47.32	-13.00	Vertical	N/A
4	5176.468	-44.54	-13.00	Vertical	PASS
5	7881.760	-39.33	-13.00	Vertical	PASS
6	16454.119	-28.81	-13.00	Vertical	PASS



LTE Band 4 20MHz BW, Mid Channel, QPSK

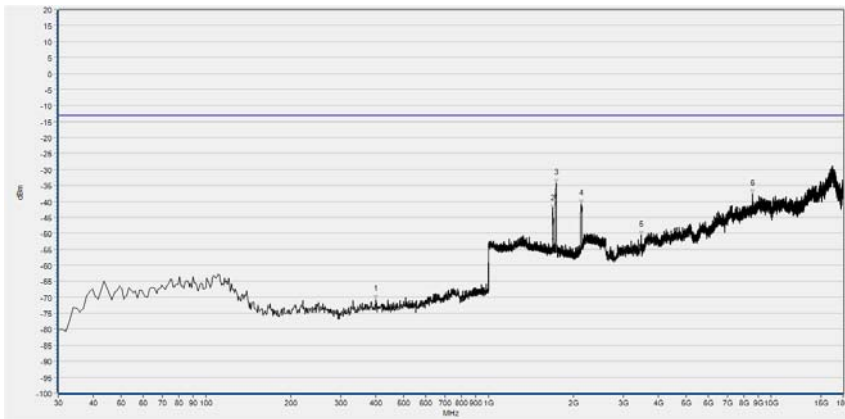

No.	Fre. (MHz)	Peak(dBm)	Limit PK(dBm)	Antenna	Verdict
1	399.570	-70.73	-13.00	Horizontal	PASS
2	1689.556	-42.24	-13.00	Horizontal	N/A
3	1733.733	-34.22	-13.00	Horizontal	N/A
4	2126.851	-40.75	-13.00	Horizontal	N/A
5	3468.158	-50.51	-13.00	Horizontal	PASS
6	8612.693	-37.68	-13.00	Horizontal	PASS

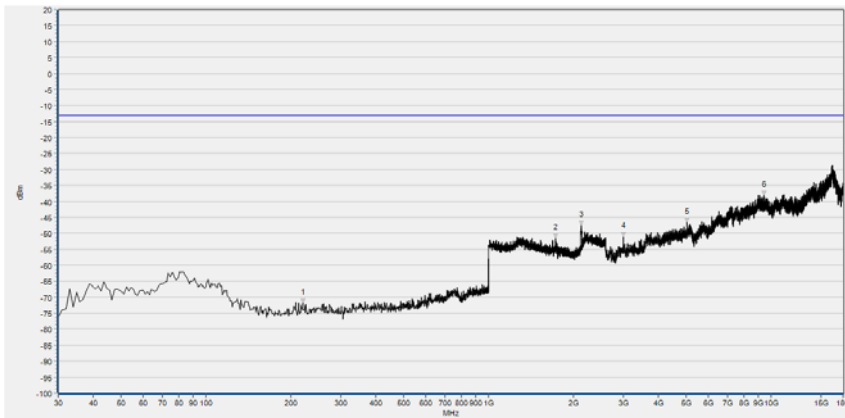

No.	Fre. (MHz)	Peak(dBm)	Limit PK(dBm)	Antenna	Verdict
1	220.120	-71.94	-13.00	Vertical	PASS
2	1726.050	-51.60	-13.00	Vertical	N/A
3	2126.851	-47.58	-13.00	Vertical	N/A
4	2997.672	-51.01	-13.00	Vertical	PASS
5	5050.446	-46.58	-13.00	Vertical	PASS
6	9433.242	-38.19	-13.00	Vertical	PASS

LTE Band 4 20MHz BW, High Channel, QPSK

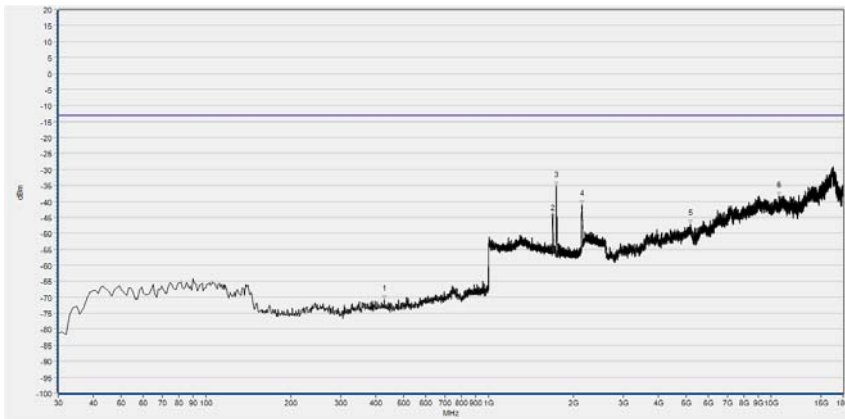

No.	Fre. (MHz)	Peak(dBm)	Limit PK(dBm)	Antenna	Verdict
1	427.700	-70.74	-13.00	Horizontal	PASS
2	1685.074	-45.46	-13.00	Horizontal	N/A
3	1736.935	-35.30	-13.00	Horizontal	N/A
4	2139.016	-41.00	-13.00	Horizontal	N/A
5	5198.873	-47.01	-13.00	Horizontal	PASS
6	10665.466	-38.24	-13.00	Horizontal	PASS

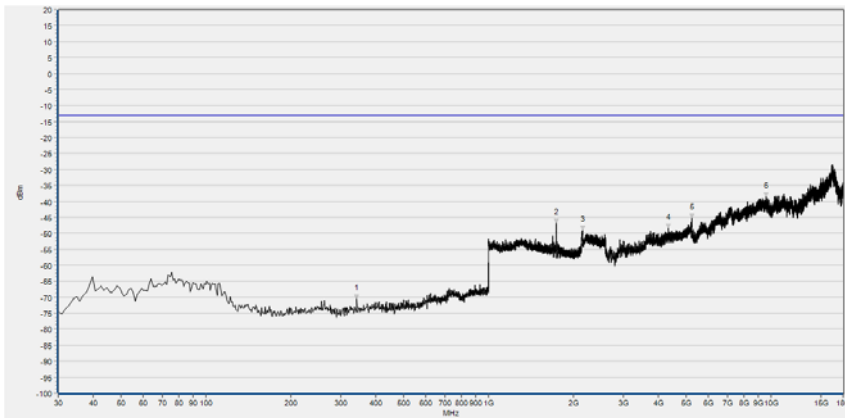

No.	Fre. (MHz)	Peak(dBm)	Limit PK(dBm)	Antenna	Verdict
1	341.370	-70.57	-13.00	Vertical	PASS
2	1736.295	-46.72	-13.00	Vertical	N/A
3	2149.260	-49.04	-13.00	Vertical	N/A
4	4339.116	-48.48	-13.00	Vertical	PASS
5	5235.279	-45.14	-13.00	Vertical	PASS
6	9632.079	-38.63	-13.00	Vertical	PASS



LTE Band 13 10MHz BW, Mid Channel, QPSK

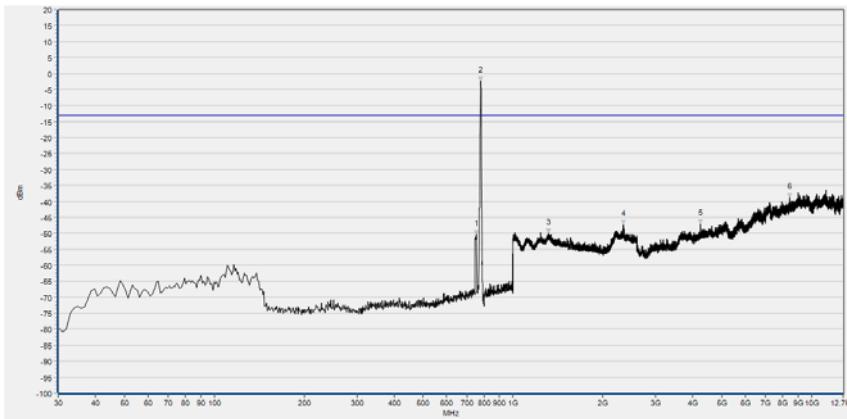

No.	Fre. (MHz)	Peak(dBm)	Limit PK(dBm)	Antenna	Verdict
1	754.590	-50.49	-13.00	Horizontal	N/A
2	778.840	-2.39	-13.00	Horizontal	N/A
3	1316.927	-49.93	-13.00	Horizontal	PASS
4	2342.617	-47.33	-13.00	Horizontal	PASS
5	4237.216	-46.99	-13.00	Horizontal	PASS
6	8451.155	-38.83	-13.00	Horizontal	PASS

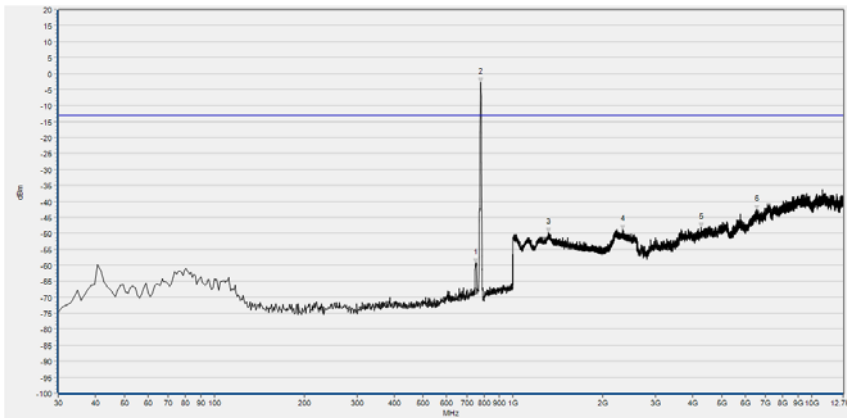

No.	Fre. (MHz)	Peak(dBm)	Limit PK(dBm)	Antenna	Verdict
1	751.680	-59.38	-13.00	Vertical	N/A
2	777.870	-2.78	-13.00	Vertical	N/A
3	1316.287	-49.62	-13.00	Vertical	PASS
4	2324.050	-48.91	-13.00	Vertical	PASS
5	4263.057	-48.25	-13.00	Vertical	PASS
6	6553.682	-42.53	-13.00	Vertical	PASS



LTE Band 13 10MHz 763M-775M RBW6.25KHZ, Mid Channel, QPSK

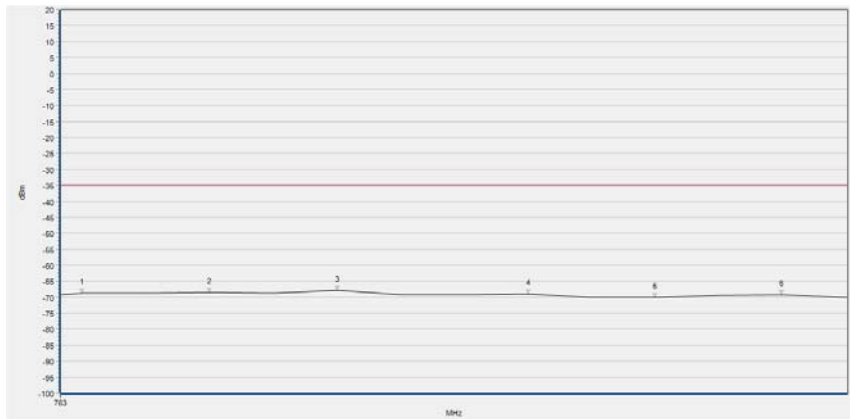

No.	Fre. (MHz)	Peak(dBm)	Limit PK(dBm)	Antenna	Verdict
1	763.320	-68.82	-35.00	Horizontal	PASS
2	765.260	-68.40	-35.00	Horizontal	PASS
3	767.200	-67.89	-35.00	Horizontal	PASS
4	770.110	-68.91	-35.00	Horizontal	PASS
5	772.050	-69.99	-35.00	Horizontal	PASS
6	773.990	-69.15	-35.00	Horizontal	PASS

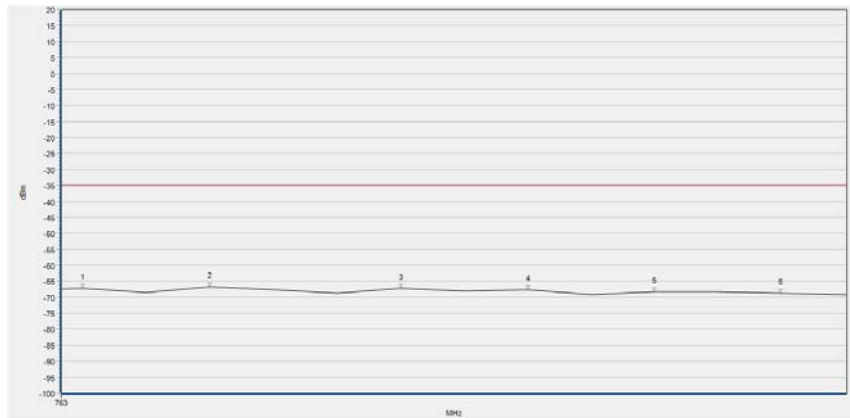

No.	Fre. (MHz)	Peak(dBm)	Limit PK(dBm)	Antenna	Verdict
1	763.320	-67.04	-35.00	Vertical	PASS
2	765.260	-66.61	-35.00	Vertical	PASS
3	768.170	-67.20	-35.00	Vertical	PASS
4	770.110	-67.58	-35.00	Vertical	PASS
5	772.050	-68.27	-35.00	Vertical	PASS
6	773.990	-68.60	-35.00	Vertical	PASS

LTE Band 13 10MHz 793M-806M RBW6.25KHZ, Mid Channel, QPSK

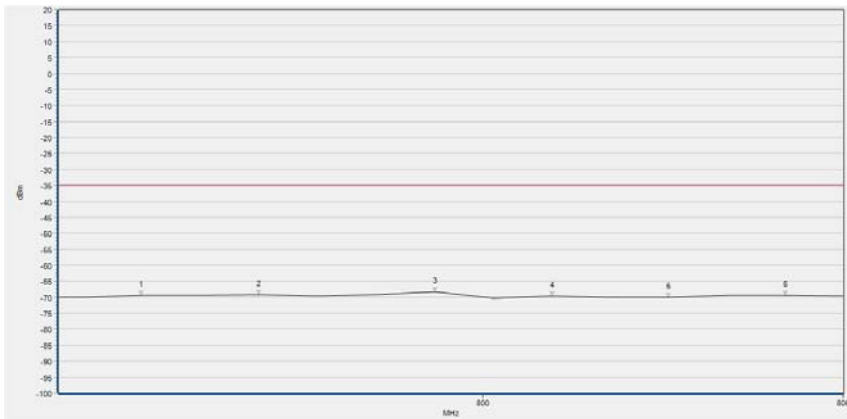

No.	Fre. (MHz)	Peak(dBm)	Limit PK(dBm)	Antenna	Verdict
1	794.360	-69.36	-35.00	Horizontal	PASS
2	796.300	-69.26	-35.00	Horizontal	PASS
3	799.210	-68.24	-35.00	Horizontal	PASS
4	801.150	-69.64	-35.00	Horizontal	PASS
5	803.090	-70.02	-35.00	Horizontal	PASS
6	805.030	-69.28	-35.00	Horizontal	PASS

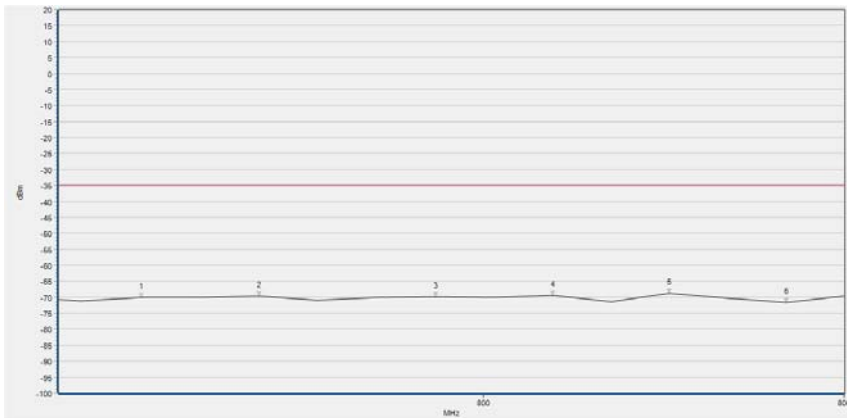

No.	Fre. (MHz)	Peak(dBm)	Limit PK(dBm)	Antenna	Verdict
1	794.360	-70.11	-35.00	Vertical	PASS
2	796.300	-69.62	-35.00	Vertical	PASS
3	799.210	-69.75	-35.00	Vertical	PASS
4	801.150	-69.34	-35.00	Vertical	PASS
5	803.090	-68.72	-35.00	Vertical	PASS
6	805.030	-71.55	-35.00	Vertical	PASS



LTE Band 13 10MHz 1559-1610 RBW1M, Mid Channel, QPSK

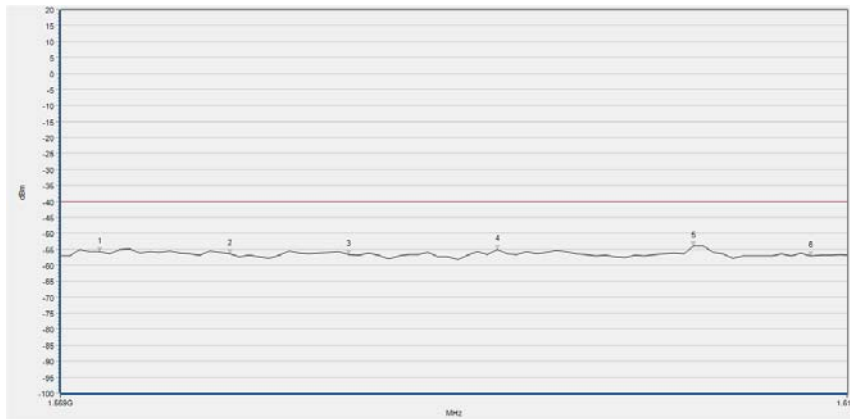

No.	Fre. (MHz)	Peak(dBm)	Limit PK(dBm)	Antenna	Verdict
1	1561.505	-55.86	-40.00	Horizontal	PASS
2	1569.828	-56.54	-40.00	Horizontal	PASS
3	1577.511	-56.69	-40.00	Horizontal	PASS
4	1587.115	-55.12	-40.00	Horizontal	PASS
5	1599.920	-54.02	-40.00	Horizontal	PASS
6	1607.603	-57.06	-40.00	Horizontal	PASS

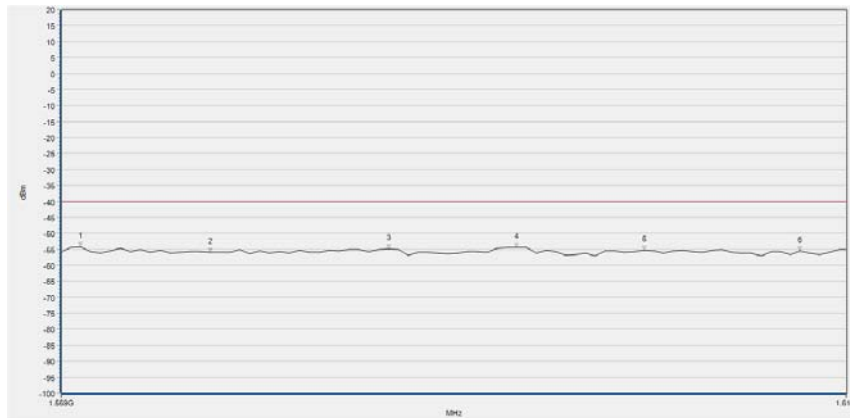

No.	Fre. (MHz)	Peak(dBm)	Limit PK(dBm)	Antenna	Verdict
1	1560.224	-54.15	-40.00	Vertical	PASS
2	1568.547	-56.02	-40.00	Vertical	PASS
3	1580.072	-54.93	-40.00	Vertical	PASS
4	1588.395	-54.49	-40.00	Vertical	PASS
5	1596.719	-55.32	-40.00	Vertical	PASS
6	1606.963	-55.53	-40.00	Vertical	PASS

LTE Band 13 10MHz 1559-1610 RBW700HZ, Mid Channel, QPSK

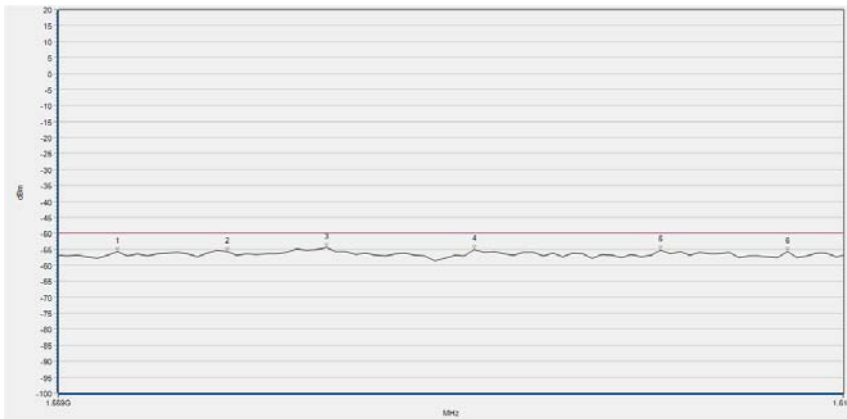

No.	Fre. (MHz)	Peak(dBm)	Limit PK(dBm)	Antenna	Verdict
1	1562.785	-55.84	-50.00	Horizontal	PASS
2	1569.828	-55.72	-50.00	Horizontal	PASS
3	1576.230	-54.46	-50.00	Horizontal	PASS
4	1585.834	-55.07	-50.00	Horizontal	PASS
5	1597.999	-55.40	-50.00	Horizontal	PASS
6	1606.323	-55.71	-50.00	Horizontal	PASS

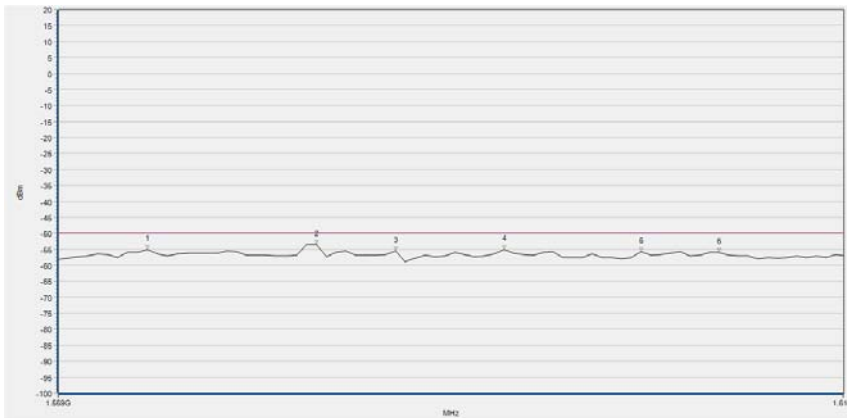

No.	Fre. (MHz)	Peak(dBm)	Limit PK(dBm)	Antenna	Verdict
1	1564.706	-55.03	-50.00	Vertical	PASS
2	1575.590	-53.60	-50.00	Vertical	PASS
3	1580.712	-55.61	-50.00	Vertical	PASS
4	1587.755	-55.01	-50.00	Vertical	PASS
5	1596.719	-55.78	-50.00	Vertical	PASS
6	1601.841	-55.91	-50.00	Vertical	PASS



Annex A Test Uncertainty

Where relevant, the following measurement uncertainty levels have been estimated for test performed on the EUT as specified in CISPR 16-1-2:

Test items	Uncertainty
Output Power	± 2.22 dB
Bandwidth	$\pm 5\%$
Conducted Spurious Emission	± 2.77 dB
Band Edge	± 2.77 dB
Equivalent Isotropic Radiated Power	± 2.22 dB
Radiated Spurious Emissions	± 6 dB

This uncertainty represent an expanded uncertainty expressed at approximately the 95% confidence level using a coverage factor of $k=2$



Annex B Testing Laboratory Information

1. Identification of the Responsible Testing Laboratory

Company Name:	Shenzhen Morlab Communications Technology Co., Ltd.
Address:	FL.3, Building A, FeiYang Science Park, No.8 LongChang Road, Block 67, BaoAn District, ShenZhen, GuangDong Province, P. R. China
Telephone:	+86 755 36698555
Facsimile:	+86 755 36698525

2. Identification of the Responsible Testing Location

Name:	Shenzhen Morlab Communications Technology Co., Ltd.
Address:	FL.3, Building A, FeiYang Science Park, No.8 LongChang Road, Block 67, BaoAn District, ShenZhen, GuangDong Province, P. R. China

3. Facilities and Accreditations

All measurement facilities used to collect the measurement data are located at FL.3, Building A, FeiYang Science Park, Block 67, BaoAn District, Shenzhen, 518101 P. R. China. The test site is constructed in conformance with the requirements of ANSI C63.10-2013 and CISPR Publication 22; the FCC designation number is CN1192, the test firm registration number is 226174.



4. Test Equipments Utilized

4.1 Conducted Test Equipments

Equipment Name	Serial No.	Type	Manufacturer	Cal. Date	Cal. Due
Power Splitter	NW521	1506A	Weinschel	2020.04.15	2021.04.14
Attenuator 1	(N/A.)	10dB	Resnet	2020.04.15	2021.04.14
Attenuator 2	(N/A.)	3dB	Resnet	2020.04.15	2021.04.14
EXA Signal Analyzer	MY51511149	N9020A	Agilent	2020.07.28	2021.07.27
USB Power Sensor	MY54210011	U2021XA	Agilent	2020.04.15	2021.04.14
System Simulator	6200995016	MT8820C	Anritsu	2020.01.13	2021.01.12
RF cable (30MHz-26GHz)	CB01	RF01	Morlab	N/A	N/A
Coaxial cable	CB02	RF02	Morlab	N/A	N/A
SMA connector	CN01	RF03	HUBER-SUHNER	N/A	N/A
Temperature Chamber	(N/A)	HUT705P	CHONGQING HANBA EXPERIMENTAL EQUIPMENT CO.,LTD	2020.03.25	2021.03.24
Computer	T430i	Think Pad	Lenovo	N/A	N/A

**4.2 Radiated Test Equipments**

Equipment Name	Serial No.	Type	Manufacturer	Cal. Date	Cal. Due
System Simulator	152038	CMW500	R&S	2020.01.13	2021.01.12
System Simulator	6200995016	MT8820C	Anritsu	2020.02.25	2021.02.24
Receiver	MY54130016	N9038A	Agilent	2020.07.28	2021.07.27
Test Antenna - Bi-Log	9163-519	VULB 9163	Schwarzbeck	2019.05.24	2022.05.23
Test Antenna - Horn	9170C-531	BBHA9170	Schwarzbeck	2019.07.26	2022.07.25
Test Antenna - Horn	01774	BBHA 9120D	Schwarzbeck	2019.05.24	2022.05.23
Coaxial cable (N male) (9KHz-30MHz)	CB04	EMC04	Morlab	N/A	N/A
Coaxial cable (N male) (30MHz-26GHz)	CB02	EMC02	Morlab	N/A	N/A
Coaxial cable(N male) (30MHz-26GHz)	CB03	EMC03	Morlab	N/A	N/A
1-18GHz pre-Amplifier	S020180L3203	N/A	Dongsheng	2020.07.28	2021.07.27
18-26.5GHz pre-Amplifier	S10M100L3802	N/A	Dongsheng	2020.07.28	2021.07.27
Notch Filter	N/A	WRCGV -LTE B2	Wainwright	2019.12.01	2020.11.30
Notch Filter	N/A	WRCGV -LTE B4	Wainwright	2019.12.01	2020.11.30
Notch Filter	N/A	WRCGV -LTE B5	Wainwright	2019.12.01	2020.11.30
Notch Filter	N/A	WRCGV -LTE B7	Wainwright	2019.12.01	2020.11.30
Notch Filter	N/A	WRCGV -LTE B12	Wainwright	2019.12.01	2020.11.30
Notch Filter	N/A	WRCGV -LTE B17	Wainwright	2019.12.01	2020.11.30



Equipment Name	Serial No.	Type	Manufacturer	Cal. Date	Cal.Due
Notch Filter	N/A	WRCGV -LTE B19	Wainwright	2019.12.01	2020.11.30
Notch Filter	N/A	WRCGV -LTE B25	Wainwright	2019.12.01	2020.11.30
Notch Filter	N/A	WRCGV -LTE B26	Wainwright	2019.12.01	2020.11.30
Notch Filter	N/A	WRCGV -LTE B30	Wainwright	2019.12.01	2020.11.30
Notch Filter	N/A	WRCGV -LTE 38	Wainwright	2019.12.01	2020.11.30
Notch Filter	N/A	WRCGV -LTE B40	Wainwright	2019.12.01	2020.11.30
Notch Filter	N/A	WRCGV -LTE B41	Wainwright	2019.12.01	2020.11.30
Anechoic Chamber	N/A	9m*6m*6m	CRT	2019.07.13	2022.07.12

————— END OF REPORT —————