

2.6. Band Edge

2.6.1. Requirement

According to FCC section 24.238(a), the power of any emission outside of the authorized operating frequency ranges must be attenuated below the transmitting power (P) by a factor of at least $43 + 10 \log(P)$ dB.

According to FCC section 27.53(h), For operations in the 1710–1755MHz bands, the power of any emission outside a licensee's frequency block shall be attenuated below the transmitter power (P) by at least $43 + 10 \log_{10}(P)$ dB.

2.6.2. Test Description

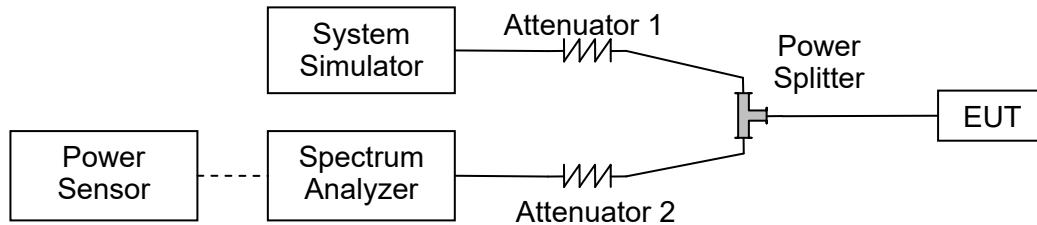

The EUT is coupled to the Spectrum Analyzer (SA) and the System Simulator (SS) with Attenuators through the Power Splitter; the RF load attached to the EUT antenna terminal is 50Ω; the path loss as the factor is calibrated to correct the reading. The EUT is commanded by the SS to operate at the maximum output power. A call is established between the EUT and the SS.

2.6.3. Test procedure

KDB 971168 D01v03 Section 6.0 and ANSI/TIA-603-E-2016.

2.6.4. Test Result

The center frequency of spectrum is the band edge frequency and span is 2MHz, Record the max trace into the test report.



Band2 / 1.4MHz / Low CH / QPSK / 1 RB

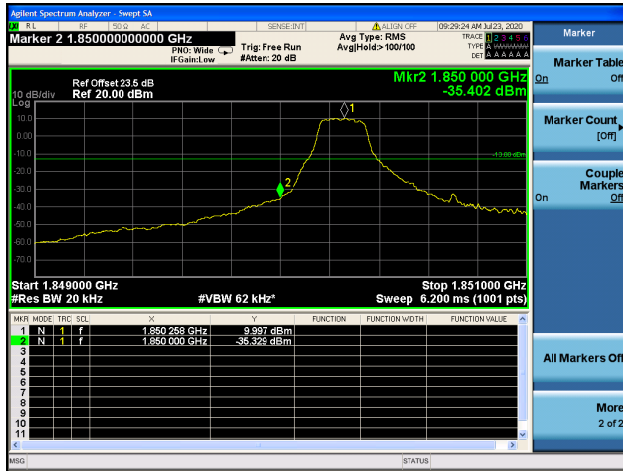

Band2 / 1.4MHz / Low CH / QPSK / FULL RB



Band2 / 1.4MHz / High CH / QPSK / 1 RB



Band2 / 1.4MHz / High CH / QPSK / FULL RB



Band2 / 3MHz / Low CH / QPSK / 1 RB

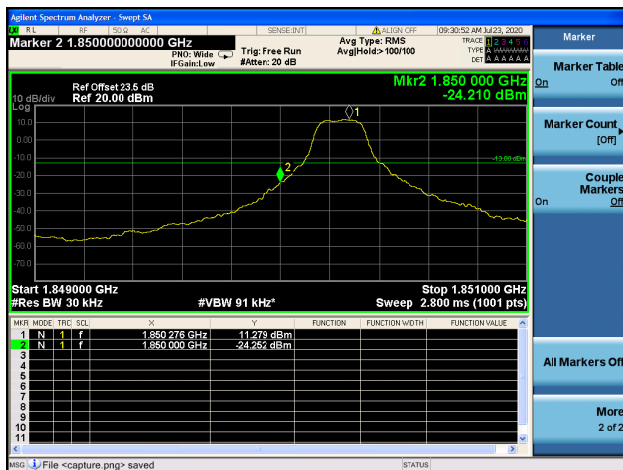

Band2 / 3MHz / Low CH / QPSK / FULL RB





Band2 / 3MHz / High CH / QPSK / 1 RB

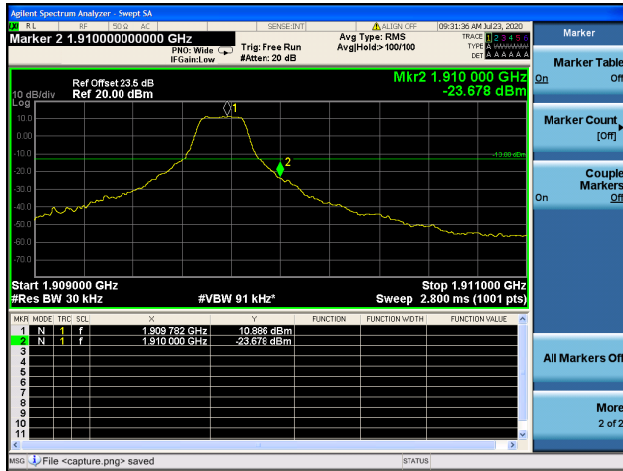

Band2 / 3MHz / High CH / QPSK / FULL RB



Band2 / 5MHz / Low CH / QPSK / 1 RB



Band2 / 5MHz / Low CH / QPSK / FULL RB

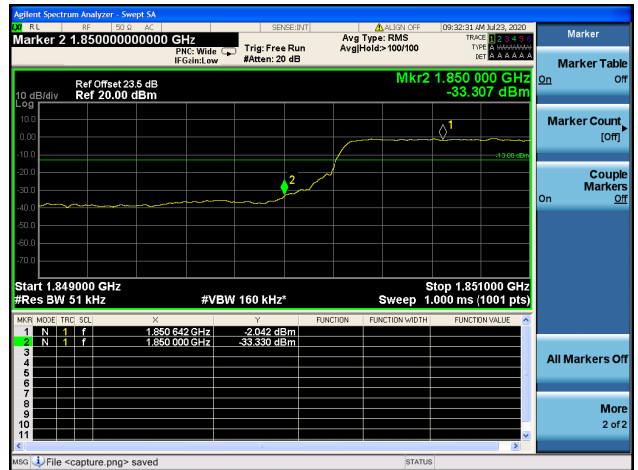

Band2 / 5MHz / High CH / QPSK / 1 RB

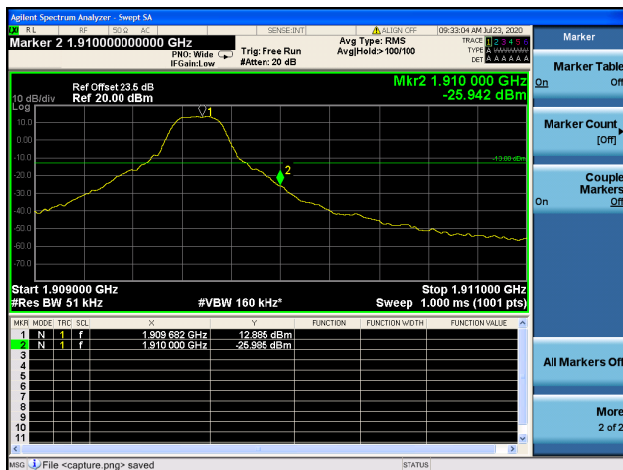

Band2 / 5MHz / High CH / QPSK / FULL RB





Band2 / 10MHz / Low CH / QPSK / 1 RB

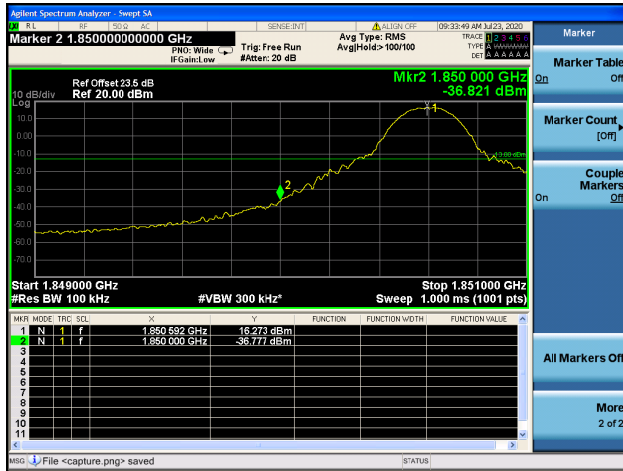

Band2 / 10MHz / Low CH / QPSK / FULL RB

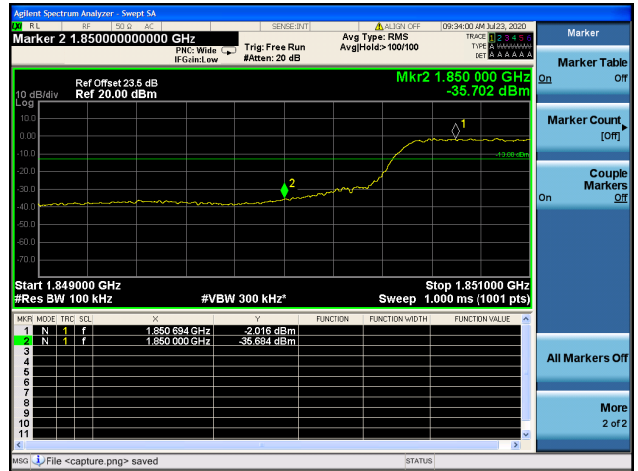

Band2 / 10MHz / High CH / QPSK / 1 RB



Band2 / 10MHz / High CH / QPSK / FULL RB

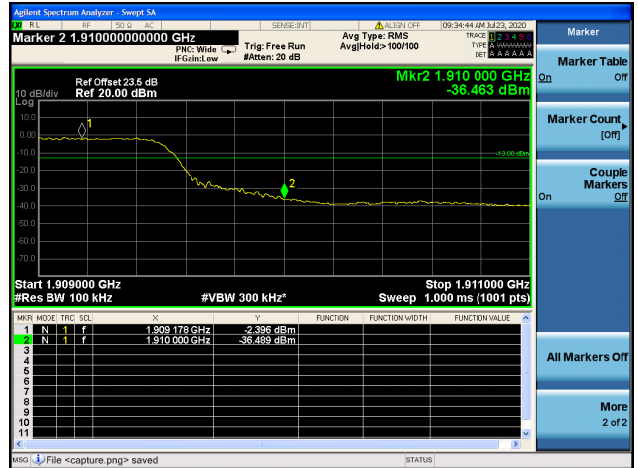

Band2 / 15MHz / Low CH / QPSK / 1 RB

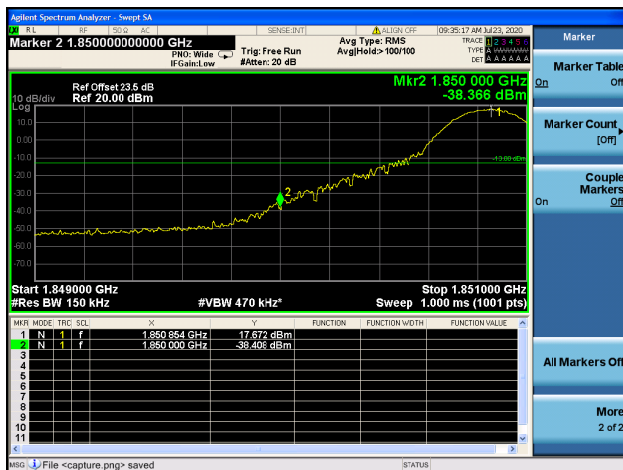

Band2 / 15MHz / Low CH / QPSK / FULL RB





Band2 / 15MHz / High CH / QPSK / 1 RB



Band2 / 15MHz / High CH / QPSK / FULL RB

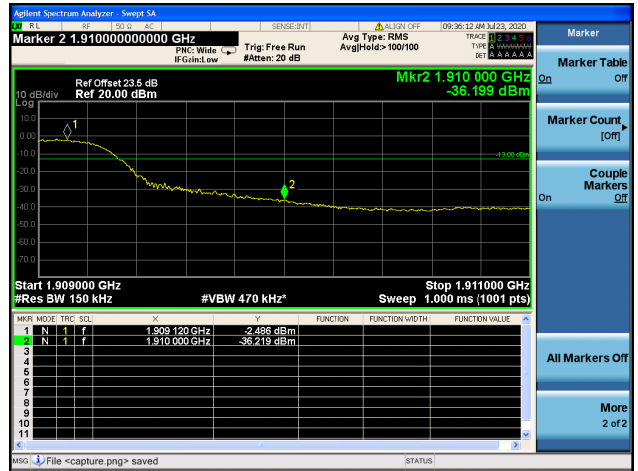

Band2 / 20MHz / Low CH / QPSK / 1 RB

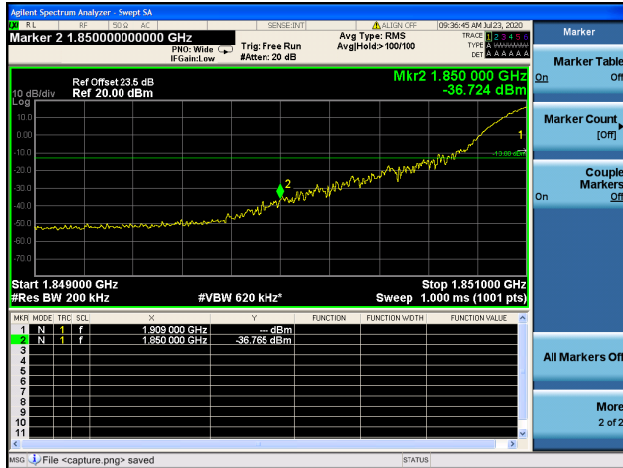

Band2 / 20MHz / Low CH / QPSK / FULL RB

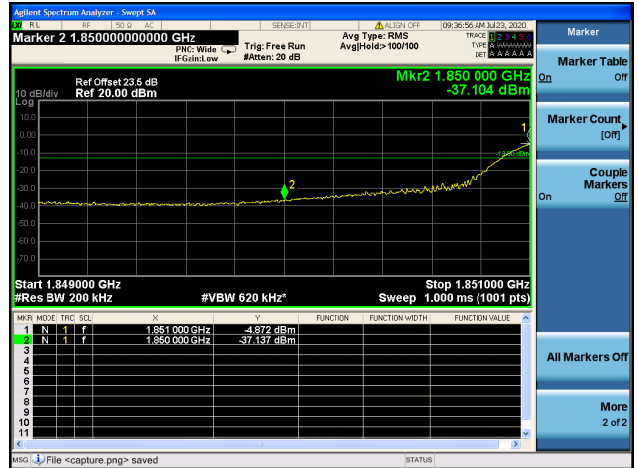

Band2 / 20MHz / High CH / QPSK / 1 RB



Band2 / 20MHz / High CH / QPSK / FULL RB





Band4 / 1.4MHz / Low CH / QPSK / 1 RB



Band4 / 1.4MHz / Low CH / QPSK / FULL RB

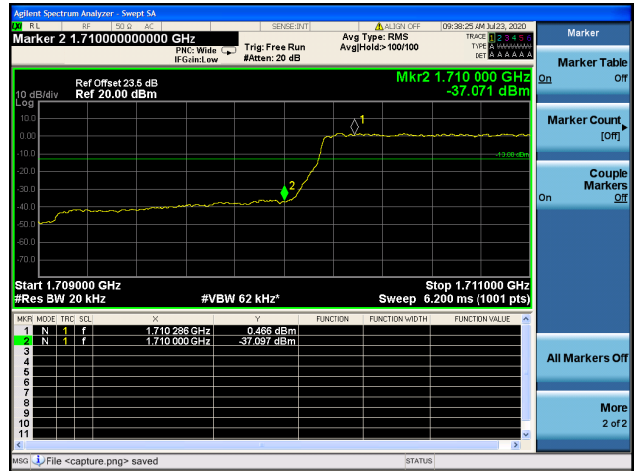

Band4 / 1.4MHz / High CH / QPSK / 1 RB



Band4 / 1.4MHz / High CH / QPSK / FULL RB



Band4 / 3MHz / Low CH / QPSK / 1 RB

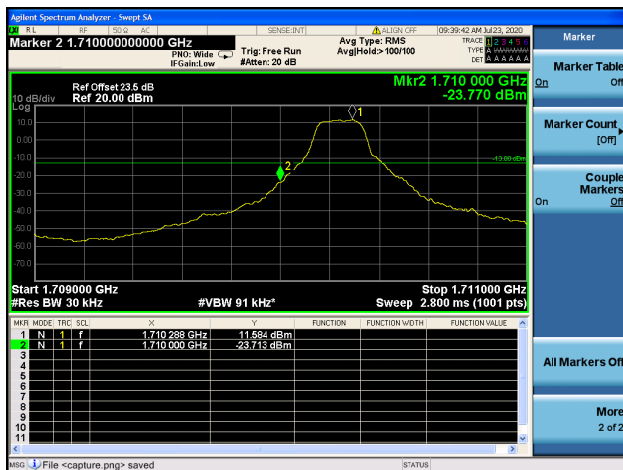

Band4 / 3MHz / Low CH / QPSK / FULL RB





Band4 / 3MHz / High CH / QPSK / 1 RB

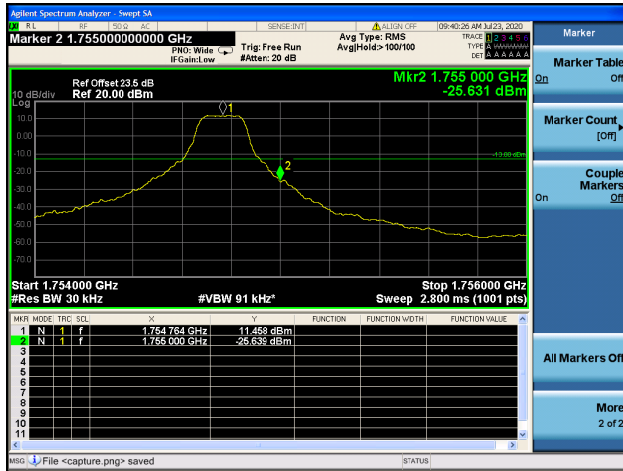

Band4 / 3MHz / High CH / QPSK / FULL RB



Band4 / 5MHz / Low CH / QPSK / 1 RB

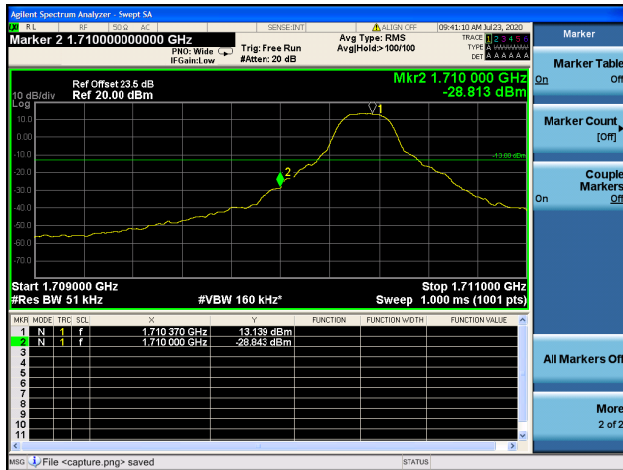

Band4 / 5MHz / Low CH / QPSK / FULL RB

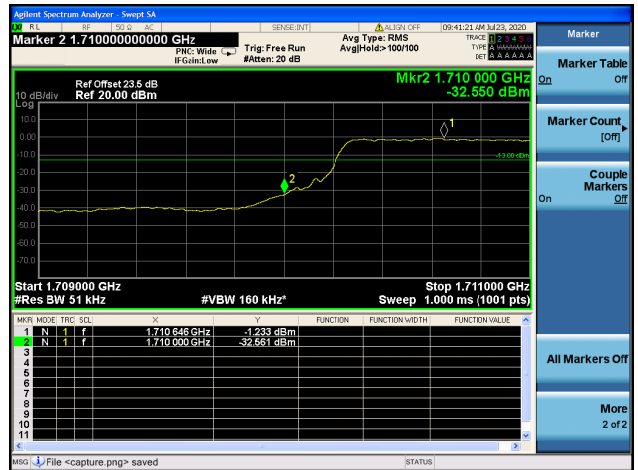

Band4 / 5MHz / High CH / QPSK / 1 RB

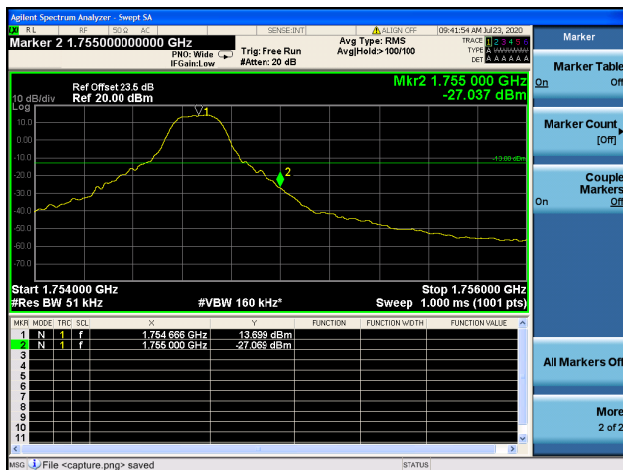

Band4 / 5MHz / High CH / QPSK / FULL RB





Band4 / 10MHz / Low CH / QPSK / 1 RB



Band4 / 10MHz / Low CH / QPSK / FULL RB

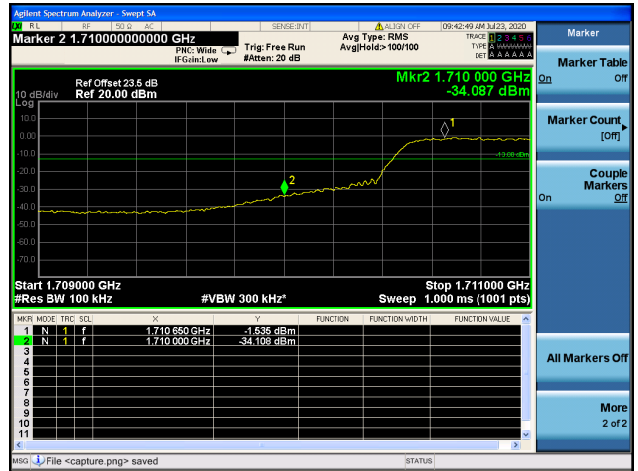

Band4 / 10MHz / High CH / QPSK / 1 RB

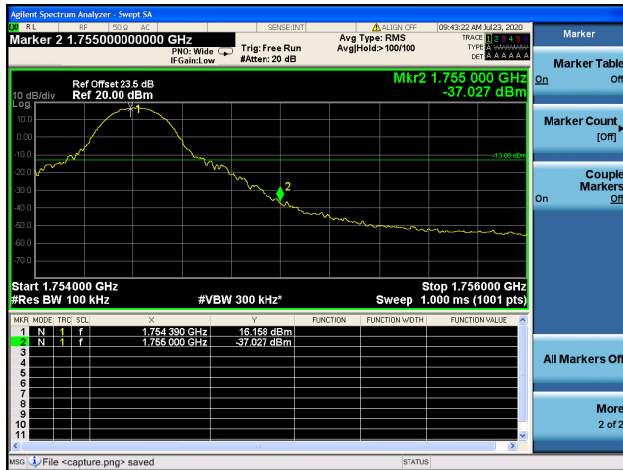

Band4 / 10MHz / High CH / QPSK / FULL RB



Band4 / 15MHz / Low CH / QPSK / 1 RB



Band4 / 15MHz / Low CH / QPSK / FULL RB





Band4 / 15MHz / High CH / QPSK / 1 RB



Band4 / 15MHz / High CH / QPSK / FULL RB

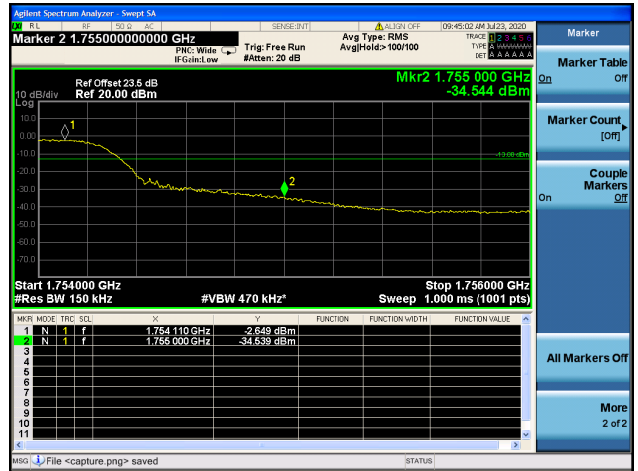

Band4 / 20MHz / Low CH / QPSK / 1 RB

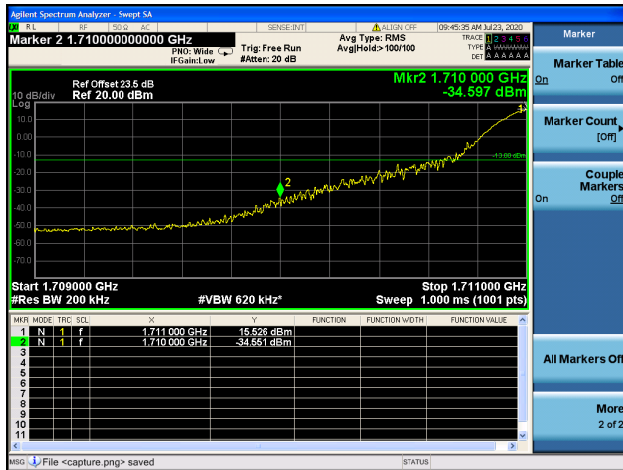

Band4 / 20MHz / Low CH / QPSK / FULL RB

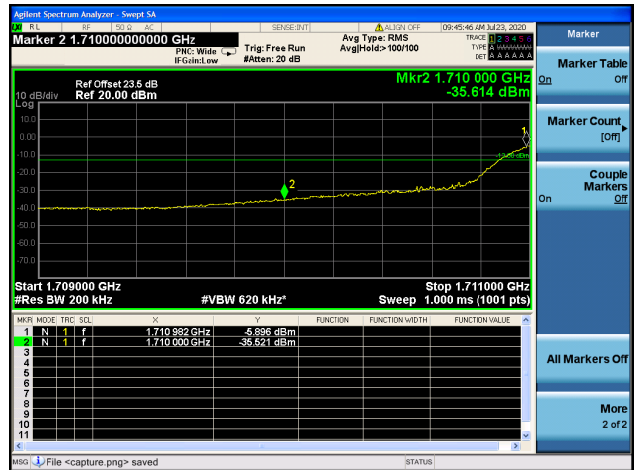

Band4 / 20MHz / High CH / QPSK / 1 RB



Band4 / 20MHz / High CH / QPSK / FULL RB





Band12 / 1.4MHz / Low CH / QPSK / 1 RB

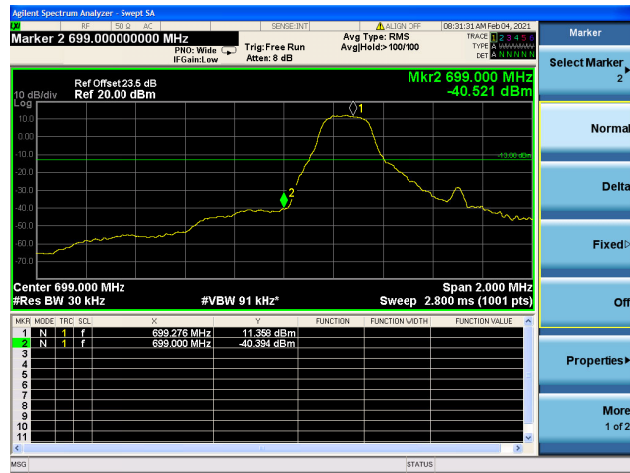

Band12 / 1.4MHz / Low CH / QPSK / FULL RB

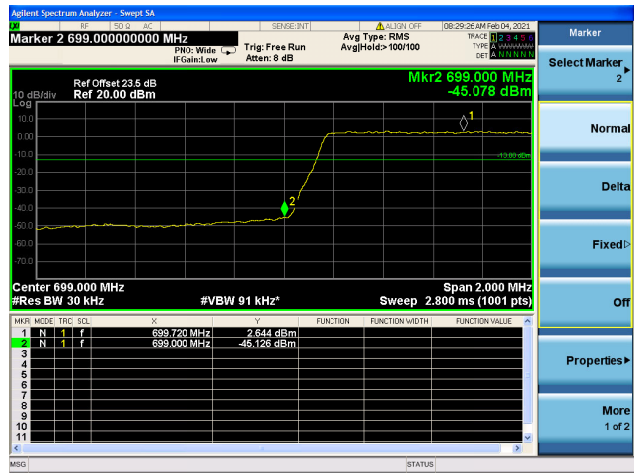

Band12 / 1.4MHz / High CH / QPSK / 1 RB

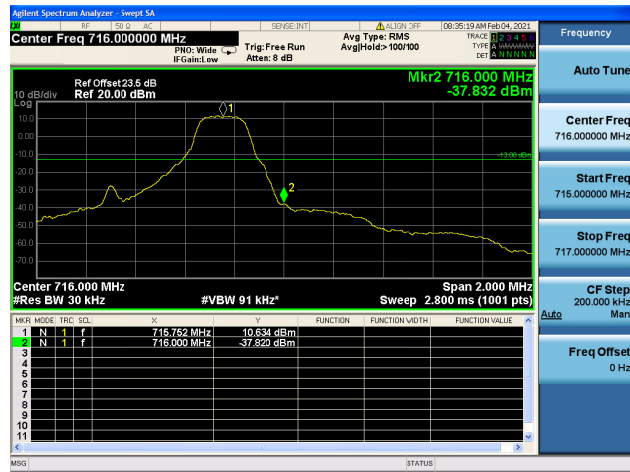

Band12 / 1.4MHz / High CH / QPSK / FULL RB

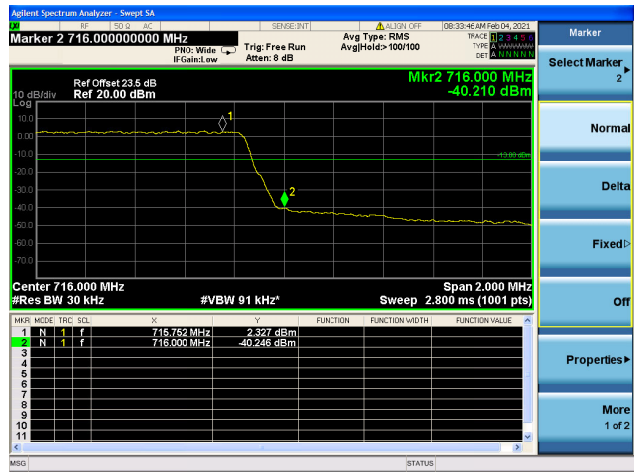

Band12 / 3MHz / Low CH / QPSK / 1 RB

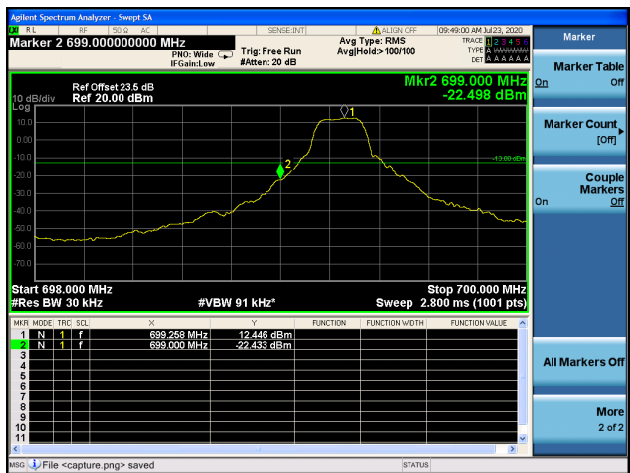

Band12 / 3MHz / Low CH / QPSK / FULL RB

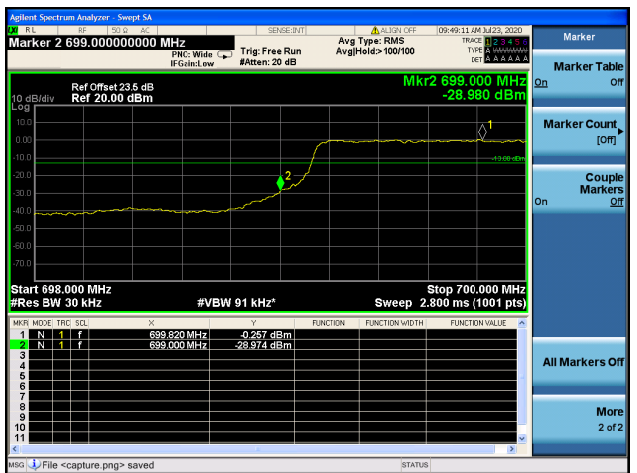



Band12 / 3MHz / High CH / QPSK / 1 RB

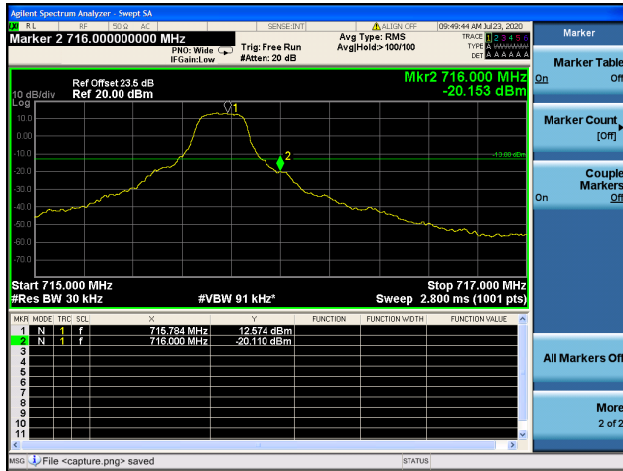

Band12 / 3MHz / Low CH / QPSK / FULL RB



Band12 / 3MHz / High CH / QPSK / 1 RB

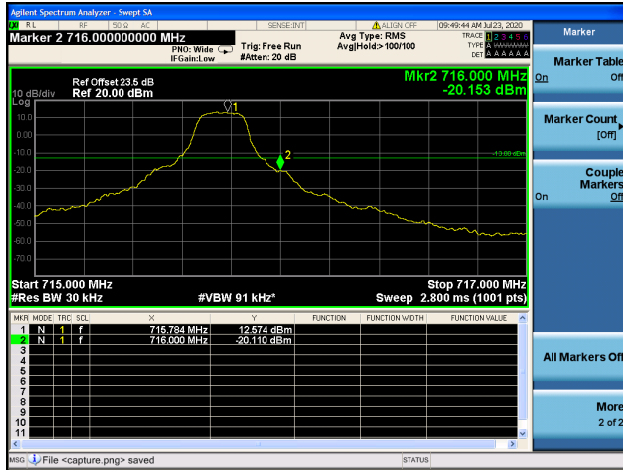

Band12 / 3MHz / High CH / QPSK / FULL RB

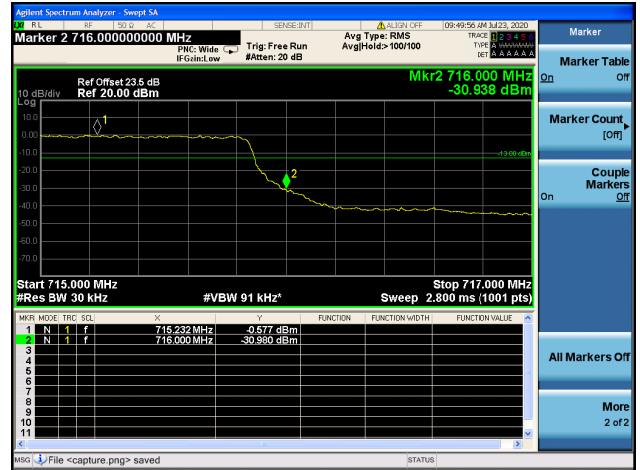

Band12 / 5MHz / Low CH / QPSK / 1 RB

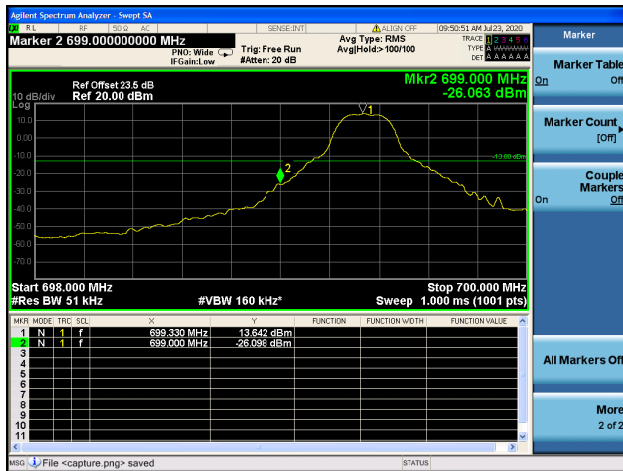

Band12 / 5MHz / Low CH / QPSK / FULL RB

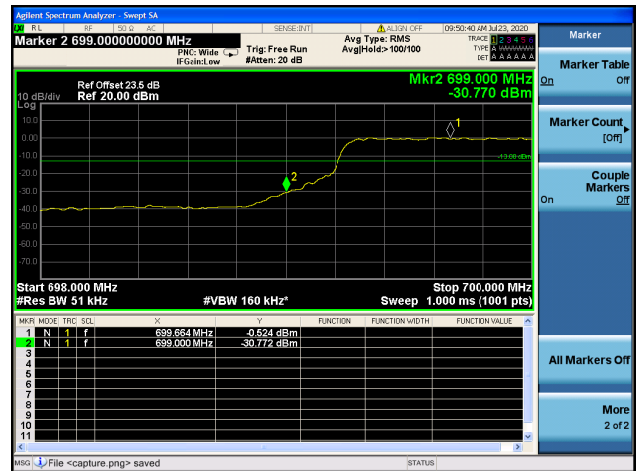



Band12 / 5MHz / High CH / QPSK / 1 RB



Band12 / 5MHz / High CH / QPSK / FULL RB



Band12 / 10MHz / Low CH / QPSK / 1 RB

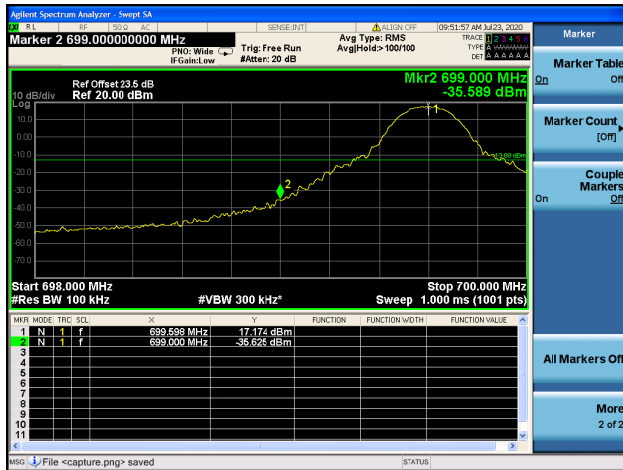

Band12 / 10MHz / Low CH / QPSK / FULL RB



Band12 / 10MHz / High CH / QPSK / 1 RB

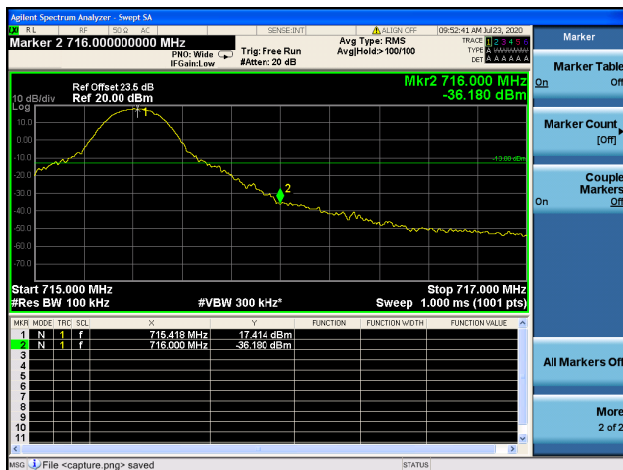

Band12 / 10MHz / High CH / QPSK / FULL RB



2.7. Radiated Spurious Emissions

2.7.1. Requirement

According to FCC section 2.1051, the power of any emission outside of the authorized operating frequency ranges must be attenuated below the transmitting power (P) by a factor of at least $43+10*\log(P)$ dB. This calculated to be -13dBm.

2.7.2. Test Description

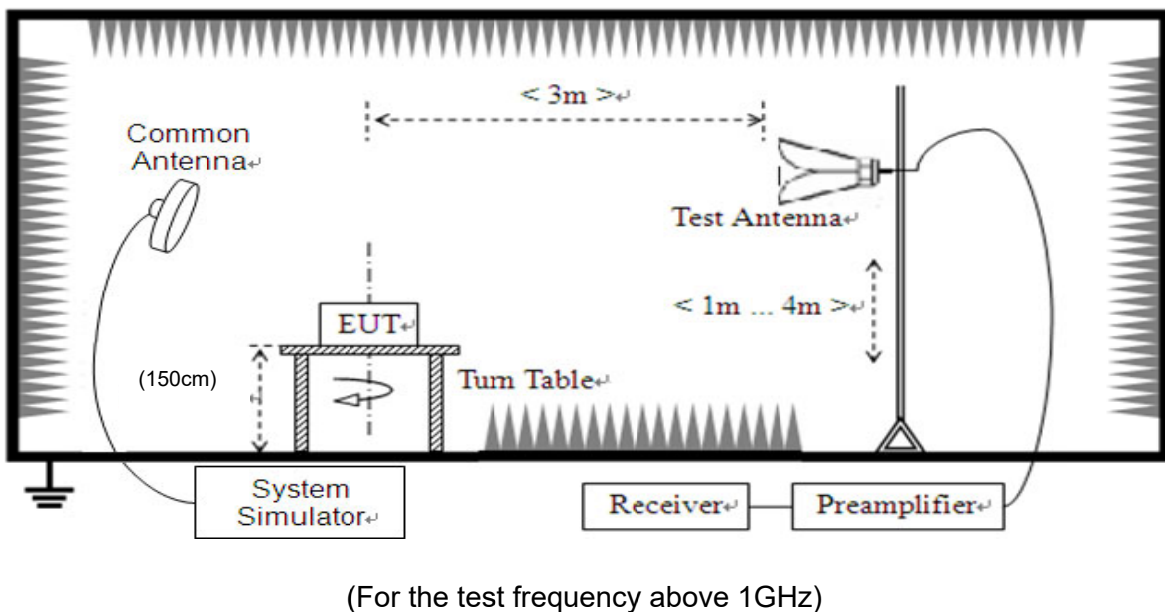
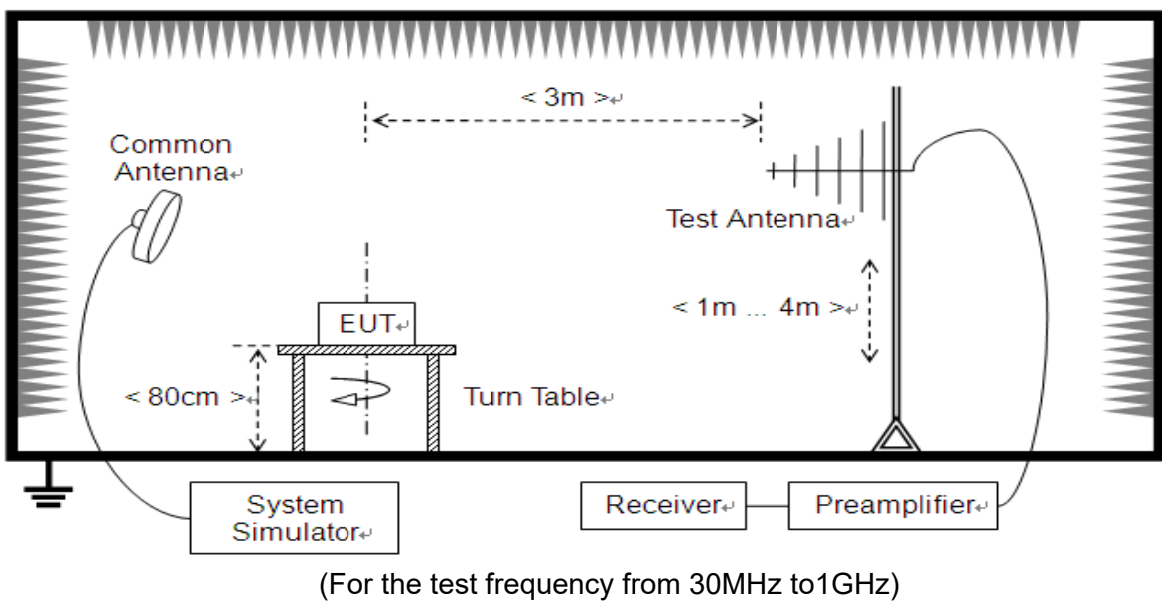



The EUT is located in a 3m Full-Anechoic Chamber, the cable loss, air loss and so on of the site as factors are pre-calibrated using the "Substitution" method, and calculated to correct the reading. A call is established between the EUT and the SS via a Common Antenna. The EUT is commanded by the SS to operate at the maximum and minimum output power, and only the test result of the maximum output power was recorded.

In the frequency range above 30MHz, Bi-Log Test Antenna (30MHz to 1GHz) and Horn Test Antenna (above 1GHz) are used. Test Antenna is 3m away from the EUT. Test Antenna height is varied from 1m to 4m above the ground and the Turn Table is actuated to turn from 0° to 360° to determine the maximum value of the radiated power. The emission levels at both horizontal and vertical polarizations should be tested. The Filters consists of Notch Filters and High Pass Filter.

Note: when doing measurements above 1GHz, the EUT has been within the 3dB cone width of the horn antenna during horizontal antenna.

2.7.3. Test procedure

KDB 971168 D01v03 Section 5.8 and ANSI/TIA-603-E-2016.

Spectrum setting:

(c) For operations in the 776-788 MHz band, the power of any emission outside the licensee's frequency band(s) of operation shall be attenuated below the transmitter power (P) within the licensed band(s) of operation, measured in watts, in accordance with the following:

(2) On any frequency outside the 776-788 MHz band, the power of any emission shall be attenuated outside the band below the transmitter power (P) by at least $43 + 10 \log (P)$ dB;

(4) On all frequencies between 763-775 MHz and 793-805 MHz, by a factor not less than $65 + 10 \log (P)$ dB in a 6.25 kHz band segment, for mobile and portable stations;

(5) Compliance with the provisions of paragraphs (c)(2) of this section is based on the use of measurement instrumentation employing a resolution bandwidth of 100 kHz or greater. However, in the 100 kHz bands immediately outside and adjacent to the frequency block, a resolution bandwidth of at least 30 kHz may be employed;

(6) Compliance with the provisions of paragraphs (c)(4) of this section is based on the use of measurement instrumentation such that the reading taken with any resolution bandwidth setting should be adjusted to indicate spectral energy in a 6.25 kHz segment.

(f) For operations in the 746-758 MHz, 775-788 MHz, and 805-806 MHz bands, emissions in the band 1559-1610 MHz shall be limited to -70 dBW/MHz equivalent isotropically radiated power (EIRP) for wideband signals, and -80 dBW EIRP for discrete emissions of less than 700 Hz bandwidth.

(h) Operations in the 1710-1755 MHz bands, the power of any emission outside a licensee's frequency block shall be attenuated below the transmitter power (P) in watts by at least $43 + 10 \log_{10} (P)$ dB.

(3) Compliance with this provision is based on the use of measurement instrumentation employing



a resolution bandwidth of 1 megahertz or greater. However, in the 1 megahertz bands immediately outside and adjacent to the licensee's frequency block, a resolution bandwidth of at least one percent of the emission bandwidth of the fundamental emission of the transmitter may be employed. The emission bandwidth is defined as the width of the signal between two points, one below the carrier center frequency and one above the carrier center frequency, outside of which all emissions are attenuated at least 26 dB below the transmitter power.

2.7.4. Test Result



LTE Band 2 20MHz BW, Low Channel, QPSK

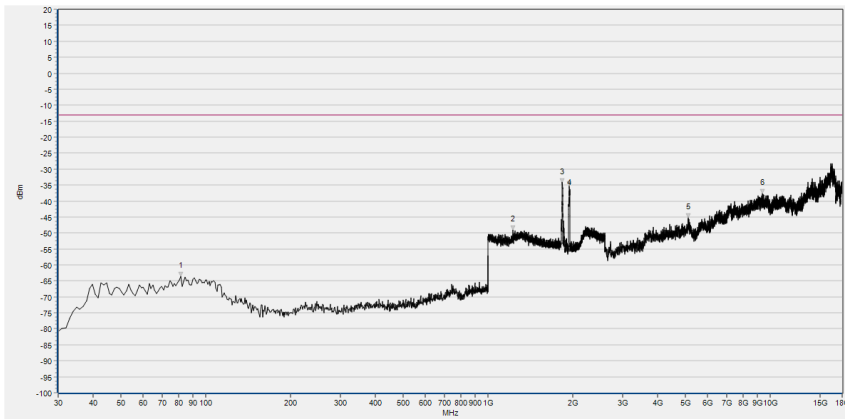

No.	Fre.(MHz)	Peak(dBm)	LimitPK(dBm)	Antenna	Verdict
1	81.410	-63.66	-13.00	Horizontal	PASS
2	1226.651	-48.99	-13.00	Horizontal	PASS
3	1835.534	-34.29	-13.00	Horizontal	NA
4	1945.658	-35.15	-13.00	Horizontal	NA
5	5128.860	-45.28	-13.00	Horizontal	PASS
6	9410.838	-37.62	-13.00	Horizontal	PASS

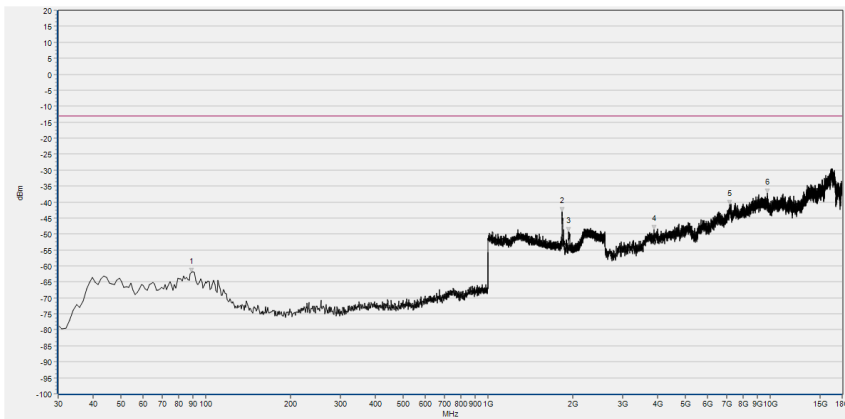

No.	Freq(MHz)	Peak(dBm)	limitPK(dBm)	Antenna	Verdict
1	89.170	-62.11	-13.00	Vertical	PASS
2	1835.534	-43.08	-13.00	Vertical	NA
3	1934.774	-49.22	-13.00	Vertical	NA
4	3871.431	-48.57	-13.00	Vertical	PASS
5	7201.237	-40.76	-13.00	Vertical	PASS
6	9800.109	-37.20	-13.00	Vertical	PASS



LTE Band 2 20MHz BW, Mid Channel, QPSK

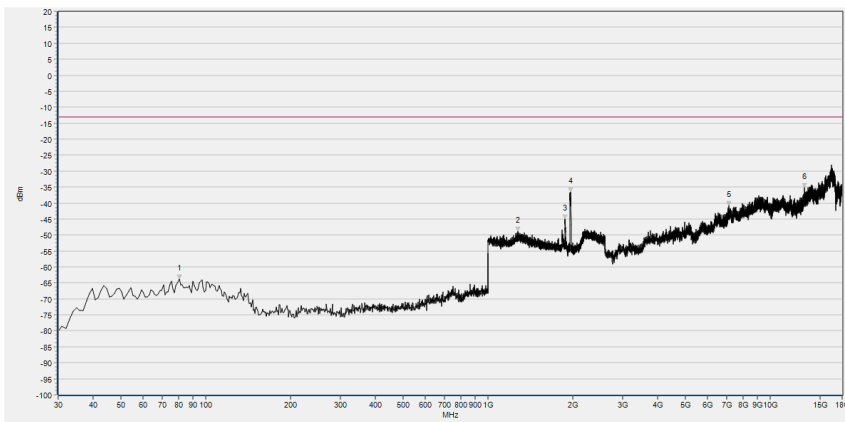

No.	Fre.(MHz)	Peak(dBm)	LimitPK(dBm)	Antenna	Verdict
1	80.440	-63.83	-13.00	Horizontal	PASS
2	1277.231	-48.73	-13.00	Horizontal	PASS
3	1877.791	-45.13	-13.00	Horizontal	NA
4	1962.305	-36.58	-13.00	Horizontal	NA
5	7156.428	-40.80	-13.00	Horizontal	PASS
6	13197.127	-35.14	-13.00	Horizontal	PASS

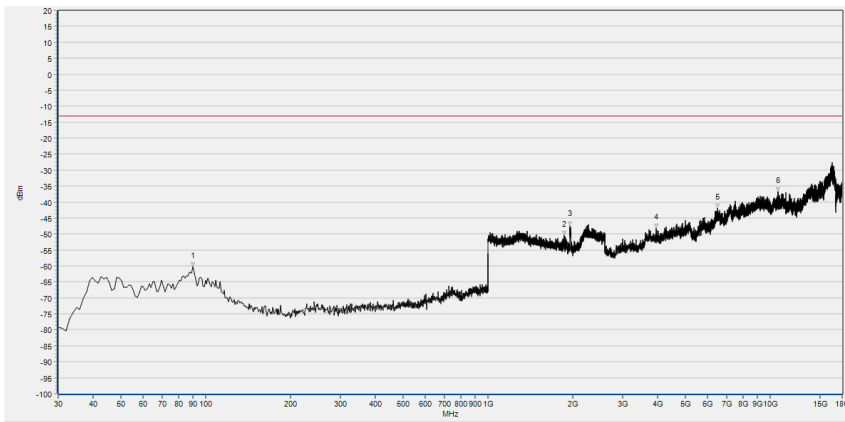

No.	Freq(MHz)	Peak(dBm)	limitPK(dBm)	Antenna	Verdict
1	90.140	-60.26	-13.00	Vertical	PASS
2	1857.943	-50.28	-13.00	Vertical	NA
3	1952.061	-47.55	-13.00	Vertical	NA
4	3941.444	-48.25	-13.00	Vertical	PASS
5	6523.513	-41.81	-13.00	Vertical	PASS
6	10654.264	-36.77	-13.00	Vertical	PASS

LTE Band 2 20MHz BW, High Channel, QPSK

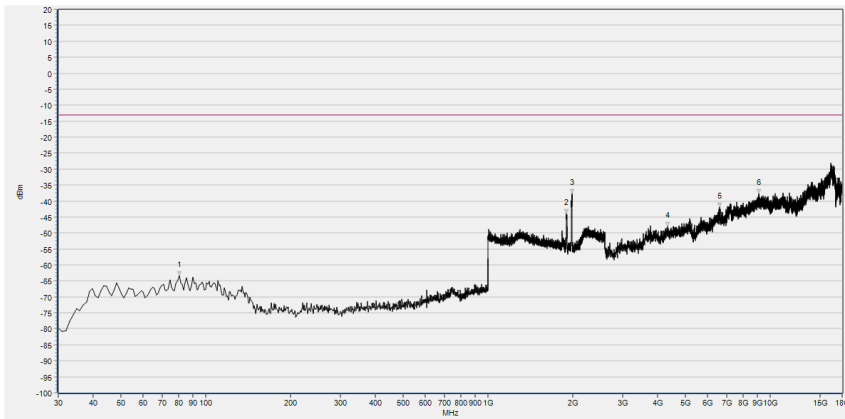

No.	Fre.(MHz)	Peak(dBm)	LimitPK(dBm)	Antenna	Verdict
1	80.440	-63.34	-13.00	Horizontal	PASS
2	1900.200	-43.91	-13.00	Horizontal	NA
3	1988.555	-37.74	-13.00	Horizontal	NA
4	4336.316	-47.87	-13.00	Horizontal	PASS
5	6610.329	-41.99	-13.00	Horizontal	PASS
6	9113.984	-37.61	-13.00	Horizontal	PASS

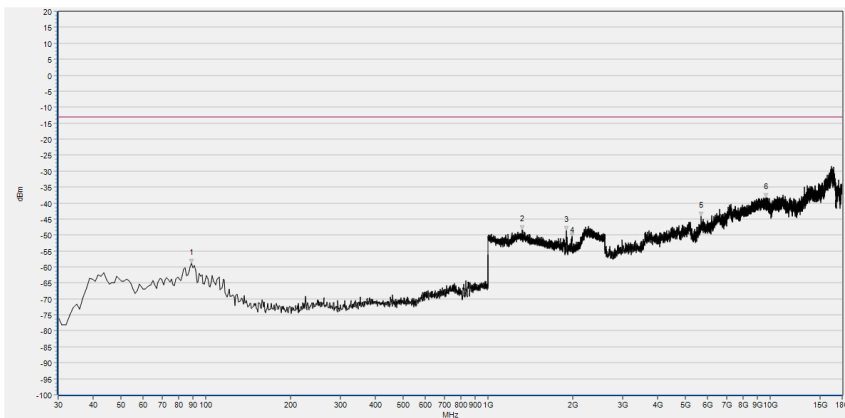

No.	Freq(MHz)	Peak(dBm)	limitPK(dBm)	Antenna	Verdict
1	89.170	-58.87	-13.00	Vertical	PASS
2	1325.250	-48.36	-13.00	Vertical	PASS
3	1900.200	-48.53	-13.00	Vertical	NA
4	1980.872	-50.71	-13.00	Vertical	NA
5	5700.164	-44.04	-13.00	Vertical	PASS
6	9640.480	-38.30	-13.00	Vertical	PASS

LTE Band 4 20MHz BW, Low Channel, QPSK

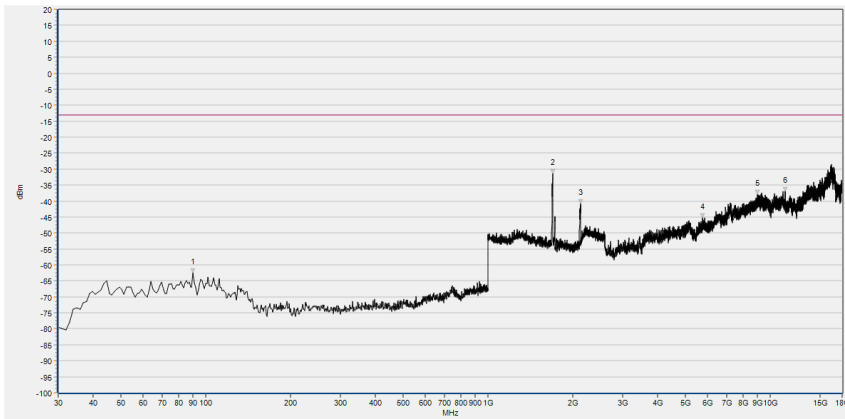

No.	Fre.(MHz)	Peak(dBm)	LimitPK(dBm)	Antenna	Verdict
1	90.200	-62.48	-13.00	Horizontal	PASS
2	1693.947	-31.33	-13.00	Horizontal	NA
3	2126.963	-40.76	-13.00	Horizontal	NA
4	5754.959	-45.28	-13.00	Horizontal	PASS
5	9007.468	-37.86	-13.00	Horizontal	PASS
6	11284.481	-37.02	-13.00	Horizontal	PASS

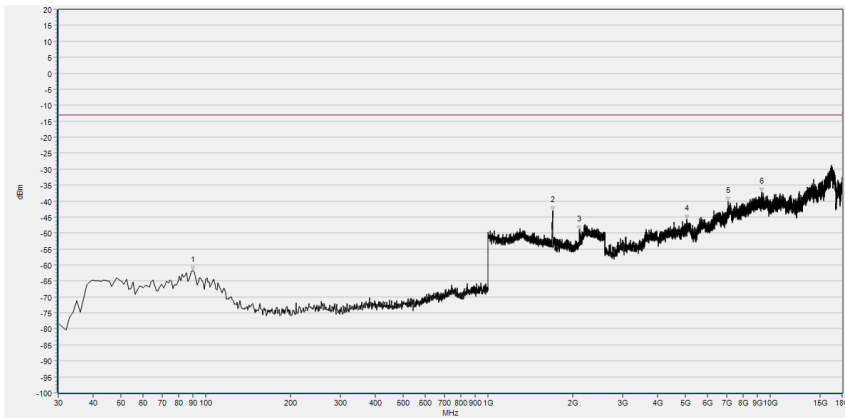

No.	Fre.(MHz)	Peak(dBm)	LimitPK(dBm)	Antenna	Verdict
1	90.200	-61.71	-13.00	Vertical	PASS
2	1693.947	-43.05	-13.00	Vertical	NA
3	2110.955	-49.09	-13.00	Vertical	NA
4	5059.277	-45.73	-13.00	Vertical	PASS
5	7105.251	-40.20	-13.00	Vertical	PASS
6	9320.653	-37.20	-13.00	Vertical	PASS