

# ELAN

---

## Quick Install Guide:

EL-SC-100

**16 pages**

Format: 4.125" wide x 5.75" high

**English Only**

**Final 02/28/2019**

Questions? [Juergen.Schroeder@nortekcontrol.com](mailto:Juergen.Schroeder@nortekcontrol.com)

**P/N: 10024269 Rev X1**

---

### PRINTER'S INSTRUCTIONS:

INK:	1-color - BW
NO. of PAGES	16
MATERIAL	80# text - gloss
BINDING	saddle stitched
SCALE	1:1

Must be RoHS Compliant



**ARTWORK ON PAGE 2-16 OF PDF**

**ELAN<sup>®</sup>**

Quick Install Guide

EL-SC-100

The EL-SC-100 Controller may be used as a standalone system controller or as an Extender to any gSC OR SC controller or running gl6.6 or greater. Please check the ELAN Training Guide for EL-SC-100 control capabilities.

The ELAN Training Guide contains valuable hardware and software reference documentation and is considered an important supplement to this document. Make sure you have the latest version by visiting the ELAN Dealer website at [www.elanhomesystems.com](http://www.elanhomesystems.com) and follow the Dealer Resources link.

### **Included in the box:**

- EL-SC-100 Controller
- 12vDC Power Supply

## **Important Safety Instructions:**

1. Read, understand and follow ALL safety and installation instructions included in this manual. Failure to follow the included documentation may damage the product and will void manufacturer's warranty.
2. Follow ALL installation guidelines included with the product. Installation of the product in high humidity environments, in close proximity to heat sources and /or non-recommended locations will impede, interfere and/or damage the intended operation of the product
3. Only use attachments and accessories which have been specified for use by the manufacturer.
4. The use of abrasive, liquid or solvent based cleaning fluids will damage the product. Please refer and follow all Product Care instructions included with the product.
5. Product Servicing may only be completed by authorized or certified service centers & personnel. For a complete list of product servicing options, please follow instructions included in the product documentation and /or contact original manufacturer for details.

**FCC and IC Information:**

This Class B digital apparatus complies with Part 15 of the FCC rules and with Canadian ICES-003 and RSS-247.

**Operation is subject to the following two conditions:**

1. This device may not cause interference and
2. This device must accept any interference, including interference that may cause undesired operation of the device.

*Cet appareil numérique de classe B est conforme aux normes canadiennes ICES-003 et RSS-247. Son fonctionnement est soumis aux deux conditions suivantes : (1) cet appareil ne doit pas causer d'interférence et (2) cet appareil doit accepter toute interférence, notamment les interférences qui peuvent affecter son fonctionnement.*

**Warning:**

Changes or modifications to this unit not expressly approved by the party responsible for compliance could void the user's authority to operate the equipment.

**FCC and IC Radiation Exposure Statement:**

This equipment complies with FCC radiation exposure limits set forth for an uncontrolled environment and meets the exemption from the routine evaluation limits in section 2.5 of RSS 102.

1. This Transmitter must not be co-located or operating in conjunction with any other antenna or transmitter.
2. This equipment complies with FCC RF radiation exposure limits set forth for an uncontrolled environment. This equipment should be installed and operated with a minimum distance of 20 centimeters from user and bystanders.

## **Warning:**

The device meets the exemption from the routine evaluation limits in section 2.5 of RSS 102, and users can obtain Canadian information on RF exposure and compliance from the Canadian Representative Product Solutions Group at Tel: (519) 763-4538.

## **FEDERAL COMMUNICATIONS COMMISSION INTERFERENCE STATEMENT:**

This equipment has been tested and found to comply with the limits for a Class B digital device, pursuant to part 15 of the FCC Rules.

These limits are designed to provide reasonable protection against harmful interference in a residential installation. This equipment generates, uses and can radiate radio frequency energy and, if not installed and used in accordance with the instructions, may cause harmful interference to radio communications.

However, there is no guarantee that interference will not occur in a particular installation. If this equipment does cause harmful interference to radio or television reception, which can be determined by turning the equipment off and on, the user is encouraged to try to correct the interference by one or more of the following measures:

- Reorient or relocate the receiving antenna.
- Increase the separation between the equipment and receiver.
- Connect the equipment into an outlet on a circuit different from that to which the receiver is connected.
- Consult the dealer or an experienced radio/ TV technician for help.

*La puissance de sortie émise par l'appareil de sans fil est inférieure à la limite d'exposition aux fréquences radio d'Industry Canada (IC). Utilisez l'appareil de sans fil de façon à minimiser les contacts humains lors du fonctionnement normal. Ce périphérique a également été évalué et démontré conforme aux limites d'exposition aux RF d'IC dans des conditions d'exposition à des appareils mobiles (antennes sont supérieures à 20 cm à partir du corps d'une personne).*

## **FCC and IC Registrations**

FCC ID: EF400186

IC: 1078A-00186

## EL-SC-100 Overview

Dimensions: TBD x TBD x TBD

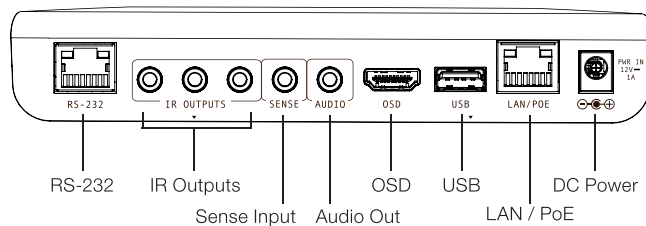
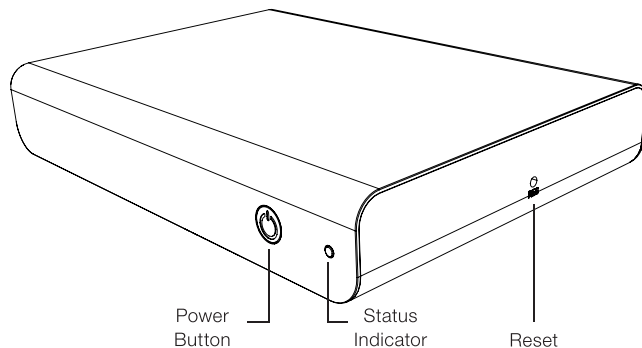

## Mounting

The EL-SC-100 is designed to mount on a shelf, hang in a cabinet or rack, or mount in a structured wiring enclosure with optional mounting bracket.

**Wall Mounting:** The EL-SC-100 chassis has been designed to allow convenient wall mounting in any orientation. Arrows on the rear panel may be used to mark the location for the screws. Mark the screw locations, mount the screws leaving approx.  $3/16"$  (5mm) of screw exposed and slide the chassis over the screws.

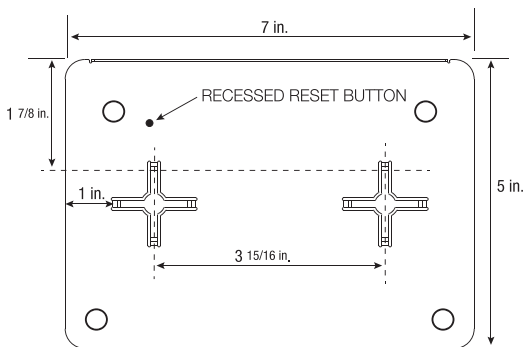
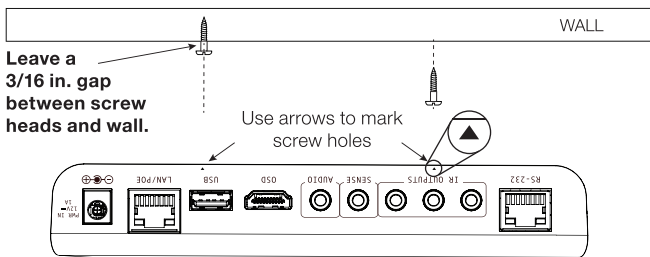



**Structured Wiring Cabinet Mounting:** Using the optional Structured Wiring Cabinet Mount, the EL-SC-100 can be mounted in a structured wiring cabinet.

1. Attach mounting bracket to wiring cabinet with snap rivets and washers
2. Snap the controller to the 2 hooks on the mounting bracket

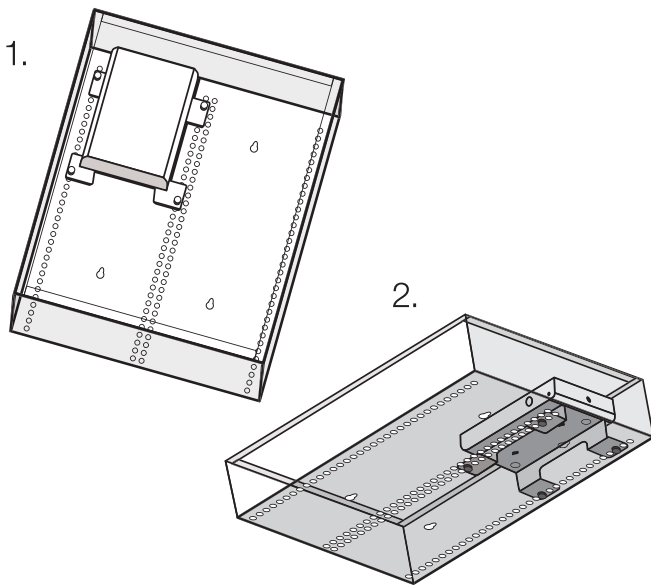

**Shelf Mounting:** The EL\_SC-100 has rubber feet to protect finished surfaces. Set the controller in a location that will allow you to properly manage connected wiring so that there is no tension on the connections.

## Serial Connection

Connect an RS-232 serial controlled device using an RJ45 connector (not included) to the RS232 port on the rear of the controller.

The EL-SC-100 serial connector is not compatible with RS-485 serial devices. If your project requires RS-485 connections you will need to use a gSC10 controller.

Below is the wiring pin-out for the RJ45 connector.

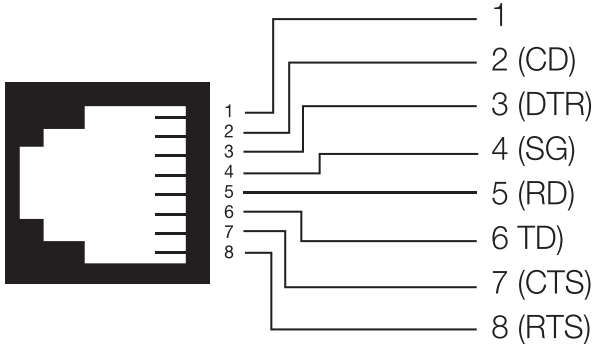

## Sense Input Connection

ELAN sensors can be used to trigger events from 3rd party devices. The status is binary, either ON or OFF. This can be used to trigger an event map or as a condition of an event map. CONNECT ONLY an ELAN sensor to this port.

Available ELAN sensors:

Audio Sensor .....	P/N: AUDSENSOR
Video Sensor.....	P/N: VIDSENSOR
Contact Closure Sensor .....	P/N: CTSENSOR
Current / Magnetic Field Sensor.....	P/N: CRSENSOR
Light / LED Sensor.....	P/N: LTSENSOR
Voltage Sensor.....	P/N: VTSENSOR

## IR Output Connection

Three discrete IR outputs are supplied to control third party devices. The outputs may be configured in programming to use a carrier or not. Each output is compatible with Xantech single and dual emitters

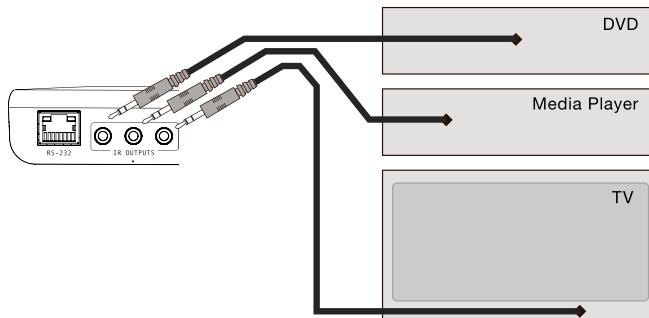

## Sense Input Connection

The EL-SC-100 includes an HDMI connector for an on screen display (OSD) interface. Connect the OSD output to an available HDMI input on a display or AVR.

## USB Connection

The USB connection is primarily designed **for firmware updates only**.

## LAN / PoE Connection

The EL-SC-100 has a Gigabit PoE compatible Ethernet port. Connect an Ethernet cable to an available port on the network.

**Note: The EL-SC-100 can be connected via WiFi, however a wired connection is preferred.**

The EL-SC-100 can be powered over Ethernet (PoE).The minimum PoE requirement is IEEE 802.3at. 42.5 - 57 VDC, 600 mA maximum.

## RESET Button

Located on the right side of the controller, is the recessed pinhole button that can be used in three ways:

1. 2 second press and release resets the controller to DHCP
2. 20 second press and release removes all configuration information. Software version will be maintained.
3. While applying power, a 10 second press and release will perform a full factory reset. Software will revert to factory default version.

**WARNING! THESE ACTIONS CANNOT BE UNDONE!**

## Power

Once all other connections have been completed, connect an Ethernet cable connected to a PoE switch or the 12 VDC, 1A power supply to the DC input and press the power button located on the front of the controller.

## Power Button

When the controller is off, a short press powers unit on

When the controller is on, a short press (less than three seconds) restarts controller.

When the controller is on, a long press (3 seconds or longer) powers down the controller

## LED Status Indicator

The LED communicates the status of the controller:

Blue = Connected OK / Power

Blue flashing = Boot up

Amber = No network found

Red = Boot failure

Red flashing = Self-check failure

## Network Connection

The EL-SC-100 is factory set to use DHCP. Connect to a wired network and use the ELAN Configurator to connect to the controller. Once connected, use configurator to set a static IP address or connect via WiFi. See the Integration Note for detailed instructions.

## Software Update

Prior to configuring the controller, upgrade the software to the latest available version found on the ELAN Dealer Resources portal. Download and open the executable file and follow the on screen instructions.

## Notes

## Notes



## Limited Warranty

Nortek Security & Control ('NSC') warrants the EL-SC-100 to be free from defects in materials and workmanship for the period of two years (2 years) from the date of purchase. If within the applicable warranty period above purchaser discovers that such item was not as warranted above and promptly notifies 'NSC' in writing, 'NSC' shall repair or replace the item at the company's option. This warranty shall not apply (a) to equipment not manufactured by 'NSC', (b) to equipment which shall have been installed by other than an 'NSC' authorized installer, (c) to installed equipment which is not installed to 'NSC's' specifications, (d) to equipment which shall have been repaired or altered by others than 'NSC', (e) to equipment which shall have been subjected to negligence, accident, or damage by circumstances beyond 'NSC's' control, including, but not limited to, lightning, flood, electrical surge, tornado, earthquake, or other catastrophic events beyond 'NSC's' control, or to improper operation, maintenance or storage, or to other than normal use of service. With respect to equipment sold by, but not manufactured by 'NSC', the warranty obligations of 'NSC' shall in all respects conform to the warranty actually extended to 'NSC' by its supplier. The foregoing warranties do not cover reimbursement for labor, transportation, removal, installation or other expenses which may be incurred in connection with repair or replacement. Except as may be expressly provided and authorized in writing by 'NSC', 'NSC' shall not be subject to any other obligations or liabilities whatsoever with respect to equipment manufactured by 'NSC' or services rendered by 'NSC'.

THE FOREGOING WARRANTIES ARE EXCLUSIVE AND IN LIEU OF ALL OTHER EXPRESSED AND IMPLIED WARRANTIES EXCEPT WARRANTIES OF TITLE, INCLUDING BUT NOT LIMITED TO IMPLIED WARRANTIES OF MERCHANTABILITY AND FITNESS FOR A PARTICULAR PURPOSE.

## ATTENTION: TO OUR VALUED CUSTOMERS

To ensure that customers obtain quality pre-sale and after-sale support and service, Nortek Security & Control products are sold exclusively through authorized dealers. Nortek Security & Control products are not sold online.

The warranties on Nortek Security & Control products are NOT VALID if the products have been purchased from an unauthorized dealer or an online E-tailer. To determine if your Nortek Security & Control reseller is authorized, please call Nortek Security & Control at (707) 283-5900.

