

S

T

S

L

A

B



RADIO TEST REPORT

Report No.: STS1811128W01

Issued for

Nortek Security & Control LLC

5919 Sea Otter Place, Suite 100, Carlsbad, CA 92010, USA

Product Name:	ELAN 8" Touch Panel User Interface
Brand Name:	ELAN
Model Name:	ITP-8
Series Model:	N/A
FCC ID:	EF400182
IC ID:	1078A-00182
HVIN:	ITP-8
Test Standard:	CFR47 FCC Part 15: Subpart C Section 15.247 CFR47 FCC Part 15: Subpart C Section 15.207 CFR47 FCC Part 15: Subpart C Section 15.209 CFR47 FCC Part 15: Subpart B Section 15.107 CFR47 FCC Part 15: Subpart B Section 15.109 RSS-247 Issue 2 February 2017 RSS-Gen Issue 5 April 2018 ICES-003 Issue 6 January 2016

Any reproduction of this document must be done in full. No single part of this document may be reproduced without permission from STS, All Test Data Presented in this report is only applicable to presented Test sample.

Shenzhen STS Test Services Co., Ltd.
1/F., Building B, Zhuoke Science Park, No.190, Chongqing Road,
Fuyong Street, Bao'an District, Shenzhen, Guangdong, China
TEL: +86-755 3688 6288 FAX: +86-755 3688 6277 E-mail: sts@stsapp.com

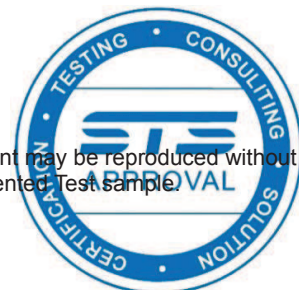



TEST RESULT CERTIFICATION

Applicant's name: **Nortek Security & Control LLC**
 Address: 5919 Sea Otter Place, Suite 100, Carlsbad, CA 92010, USA
Manufacturer's Name: **Linear Electronics(Shenzhen) Limited**
 Address: Hourui Second Industrila Zone, Hourui village, Hangcheng, Baoan, Shenzhen, P.R.C

Product description

Product Name: ELAN 8" Touch Panel User Interface
 Brand Name: ELAN
 Model Name: ITP-8
 SeriesModel: N/A

Test Standards: CFR47 FCC Part 15: Subpart C Section 15.247
 CFR47 FCC Part 15: Subpart C Section 15.207
 CFR47 FCC Part 15: Subpart C Section 15.209
 CFR47 FCC Part 15: Subpart B Section 15.107
 CFR47 FCC Part 15: Subpart B Section 15.109
 RSS-247 Issue 2 February 2017
 RSS-Gen Issue 5 April 2018
 ICES-003 Issue 6 January 2016

Test procedure: ANSI C63.10: 2013, ANSI C63.4: 2014

This device described above has been tested by STS, the test results show that the equipment under test (EUT) is in compliance with the FCC/IC requirements. And it is applicable only to the tested sample identified in the report.

This report shall not be reproduced except in full, without the written approval of STS, this document only be altered or revised by STS, personal only, and shall be noted in the revision of the document.

Date of Test

Date (s) of performance of tests: 09 Nov. 2018 -15 Nov. 2018

Date of Issue: 19 Nov. 2018

Test Result: **Pass**

Testing Engineer : *Chris Chen*

(Chris Chen)

Technical Manager : *Sunday Hu*

(Sunday Hu)

Authorized Signatory : *Vita Li*

(Vita Li)

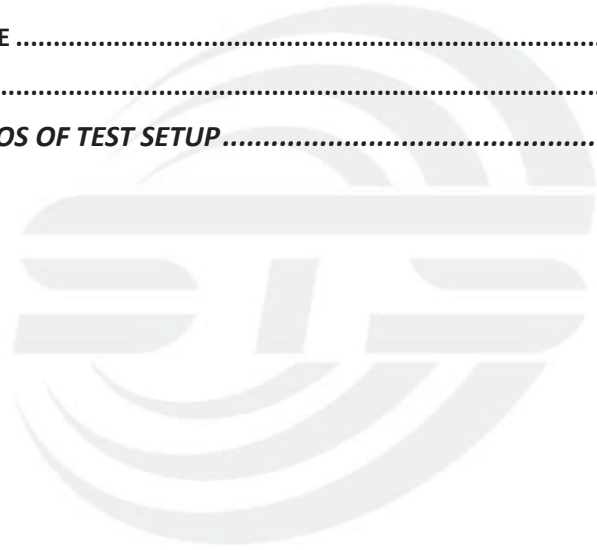



Table of Contents		Page
1	SUMMARY OF TEST RESULTS	6
1.1	TEST FACTORY	7
1.2	MEASUREMENT UNCERTAINTY	7
2	GENERAL INFORMATION	8
2.1	GENERAL DESCRIPTION OF EUT	8
2.2	DESCRIPTION OF TEST MODES	10
2.3	BLOCK DIGRAM SHOWING THE CONFIGURATION OF SYSTEM TESTED	11
2.4	DESCRIPTION OF SUPPORT UNITS	11
2.5	EQUIPMENTS LIST FOR ALL TEST ITEMS	12
3	EMC EMISSION TEST	14
3.1	CONDUCTED EMISSION MEASUREMENT	14
3.2	RADIATED EMISSION MEASUREMENT	22
3.3	RADIATED SPURIOUS EMISSION MEASUREMENT	30
4	CONDUCTED SPURIOUS & BAND EDGE EMISSION	48
4.1	APPLIED PROCEDURES / LIMIT	48
4.2	TEST PROCEDURE	48
4.3	DEVIATION FROM STANDARD	48
4.4	TEST SETUP	48
4.5	EUT OPERATION CONDITIONS	48
4.6	TEST RESULTS	49
5	POWER SPECTRAL DENSITY TEST	58
5.1	APPLIED PROCEDURES / LIMIT	58
5.2	TEST PROCEDURE	58
5.3	DEVIATION FROM STANDARD	58
5.4	TEST SETUP	58
5.5	EUT OPERATION CONDITIONS	58
5.6	TEST RESULTS	59
6	BANDWIDTH TEST	65
6.1	APPLIED PROCEDURES / LIMIT	65
6.2	TEST PROCEDURE	65
6.3	DEVIATION FROM STANDARD	65
6.4	TEST SETUP	65
6.5	EUT OPERATION CONDITIONS	65
6.6	TEST RESULTS	66



- 7 **PEAK OUTPUT POWER TEST** 78
 - 7.1 APPLIED PROCEDURES / LIMIT 78
 - 7.2 TEST PROCEDURE 78
 - 7.3 DEVIATION FROM STANDARD 78
 - 7.4 TEST SETUP 78
 - 7.5 EUT OPERATION CONDITIONS 78
 - 7.6 TEST RESULTS 79
- 8 **ANTENNA REQUIREMENT** 80
 - 8.1 STANDARD REQUIREMENT 80
 - 8.2 EUT ANTENNA 80
- 9 **FREQUENCY STABILITY** 81
 - 9.1 LIMITS OF FREQUENCY STABILITY MEASUREMENT 81
 - 9.2 TEST PROCEDURE 81
 - 9.3 TEST RESULT 81
- 10 **APPENDIX- PHOTOS OF TEST SETUP** 82





Revision History

Rev.	Issue Date	Report NO.	Effect Page	Contents
00	19 Nov. 2018	STS1811128W01	ALL	Initial Issue





1 SUMMARY OF TEST RESULTS

Test procedures according to the technical standards:

KDB 558074 D01 DTS Meas Guidance v05

FCC Part 15, Subpart C RSS-247 Issue 2			
StandardSection	Test Item	Judgment	Remark
FCC Part 15.207(a) RSS-Gen Clause 8.8	Conducted Emission	PASS	
FCC Part 15.247(a)(2) RSS-247 Clause 5.2(a)	6dB Bandwidth	PASS	
RSS-Gen Clause 6.6	99% Bandwidth	PASS	
FCC Part 15.247(b)(3) RSS-247 Clause 5.4(d)	Output Power	PASS	
FCC Part 15.247(d) RSS-247 Clause 3.3	Radiated Spurious Emission	PASS	
FCC Part 15.247(d) RSS-247 Clause 5.5	Conducted Spurious & Band Edge Emission	PASS	
FCC Part 15.247(e) RSS-247 Clause 5.2(b)	Power Spectral Density	PASS	
FCC Part 15.205	Restricted Band Edge Emission	PASS	
FCC Part 15.247(d)&15.209(a) RSS-247 Clause 5.5	Band Edge Emission	PASS	
FCC Part 15.247(b)(4) &15.203	Antenna Requirement	PASS	
RSS-Gen Issue 5 April 2018	Frequency Stability	PASS	

FCC Part 15, Subpart B ICES-003 Issue 6			
StandardSection	Test Item	Judgment	Remark
FCC Part 15.107(a) ICES-003	Conducted Emission	PASS	Class B limit
FCC Part 15.109(a) ICES-003	Radiated Emission	PASS	Class B limit

NOTE:

- 1) 'N/A' denotes test is not applicable in this test report
- 2) All tests were performed according to the procedures in ANSI C63.10: 2013 and ANSI C63.4: 2014.



1.1 TEST FACTORY

Shenzhen STS Test Services Co., Ltd.
Add.: 1/F., Building B, Zhuoke Science Park, No.190,Chongqing Road, Fuyong Street, Bao'an District, Shenzhen, Guangdong,China

FCC Registration No.: 625569

IC Registration No.: 12108A

A2LA Certificate No.: 4338.01

1.2 MEASUREMENT UNCERTAINTY

The reported uncertainty of measurement $y \pm U$, where expanded uncertainty U is based on a standard uncertainty multiplied by a coverage factor of $k=2$, providing a level of confidence of approximately 95 %.

No.	Item	Uncertainty
1	Conducted Emission (9KHz-150KHz)	$\pm 3.18\text{dB}$
2	Conducted Emission (150KHz-30MHz)	$\pm 2.70\text{dB}$
3	RF power,conducted	$\pm 0.71\text{dB}$
4	Spurious emissions,conducted	$\pm 0.63\text{dB}$
5	All emissions,radiated (9KHz-30MHz)	$\pm 2.50\text{dB}$
6	All emissions,radiated(30MHz-200MHz)	$\pm 3.43\text{dB}$
7	All emissions,radiated(200MHz-1000MHz)	$\pm 3.57\text{dB}$
8	All emissions,radiated(>1G)	$\pm 4.13\text{dB}$



2 GENERAL INFORMATION

2.1 GENERAL DESCRIPTION OF EUT

Product Name	ELAN 8" Touch Panel User Interface	
Trade Name	ELAN	
Model Name	ITP-8	
Series Model	N/A	
Model Difference	N/A	
Product Description	The EUT is a ELAN 8" Touch Panel User Interface which supports Wi-Fi 802.11 b/g/n wireless technology.	
	Operation Frequency:	2412 - 2462 MHz for 802.11b/g/n(HT20)
	Modulation Type:	DSSS(DBPSK/DQPSK/CCK) OFDM(BPSK/QPSK/16QAM/64QAM)
	Bit Rate of Transmitter:	1/2/5.5/11 Mbps for 802.11b 6/9/12/18/24/36/48/54 Mbps for 802.11g MCS0 ~ MCS7 for 802.11n
	Number OfChannel:	11 channels for 802.11b/g/n(HT20)
	Antenna Designation:	Please see Note 4
	AntennaGain(dBi):	3.5dBi
	Duty Cycle:	>98%
Channel List	Please refer to the Note 2.	
Power Rating	Input:DC 12~14V; POE Interface	
Hardware version	N/A	
Software version	N/A	
Radio Hardware version	N/A	
Radio Software version	N/A	
Test Software	N/A	
RF Power Setting TEST Software (power class)	N/A	
Connecting I/O Port(s)	Please refer to the User's Manual	



Note:

- 1 For a more detailed features description, please refer to the manufacturer's specifications or the User's Manual.

2

RF Channel and Frequency of Wi-Fi 802.11 b/g/n	
802.11b/g/n (HT20)	
RF Channel	Freq.(MHz)
01	2412
02	2417
03	2422
04	2427
05	2432
06	2437
07	2442
08	2447
09	2452
10	2457
11	2462

3 Note:

- 1) In section 15.31(m), regards to the operating frequency range over 10 MHz, the Lowest frequency, the middle frequency, and the highest frequency of channel were selected to perform the test;
- 2) Test frequencies are lowest channel: 2412 MHz, middle channel: 2437 MHz and highest channel: 2462 MHz for 802.11b/g/n(HT20)

4

Ant	Brand	Model Name	Antenna Type	Connector	Gain (dBi)	NOTE
1	N/A	ITP-8	Eternal FPC Antenna	N/A	3.5	WLAN Antenna



2.2 DESCRIPTION OF TEST MODES

Each of these EUT operation mode(s) or test configuration mode(s) mentioned above was evaluated respectively.

Worst Mode	Description	Data Rate
Mode 1	TX IEEE 802.11b CH1	1 Mbps
Mode 2	TX IEEE 802.11b CH6	1 Mbps
Mode 3	TX IEEE 802.11b CH11	1 Mbps
Mode 4	TX IEEE 802.11g CH1	6 Mbps
Mode 5	TX IEEE 802.11g CH6	6 Mbps
Mode 6	TX IEEE 802.11g CH11	6 Mbps
Mode 7	TX IEEE 802.11n HT20 CH1	MCS 0
Mode 8	TX IEEE 802.11n HT20 CH6	MCS 0
Mode 9	TX IEEE 802.11n HT20 CH11	MCS 0
Mode10	Wi-Fi transmitting mode	/
Mode 11	Data transfer of RJ45 port (DC 12V)	/
Mode 12	Data transfer of RJ45 port (POE Interface)	/

Note:

- 1) The measurements are performed at all Bit Rate of Transmitter, the worst data was reported
- 2) We have be tested for all available U.S. voltage and frequencies(For 120V,50/60Hz and 240V, 50/60Hz) for which the device is capable of operation, and the worst case of 120V/60Hz is shown in the report.
- 3) Controlled using a bespoke application on the laptop PC supplied by the customer. The application was used to enable a continuous transmission mode and to select the test channels, data rates and modulation schemes as required.

2.3 BLOCK DIGRAM SHOWING THE CONFIGURATION OF SYSTEM TESTED

Radiation Test Set

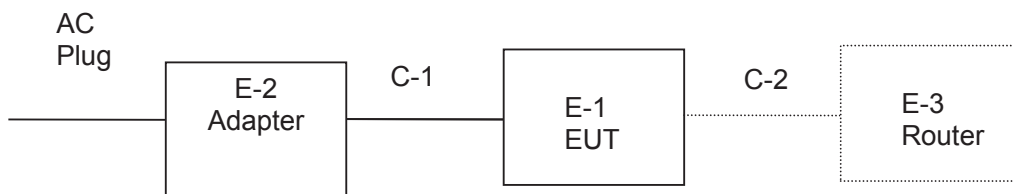

Conduction Test Set

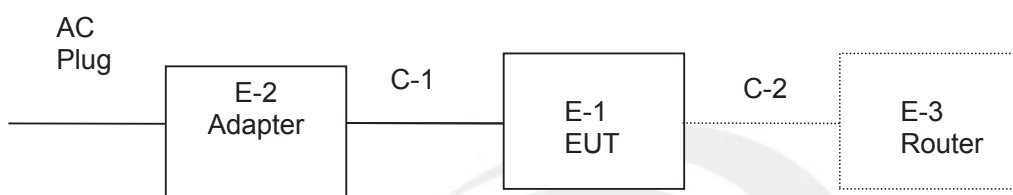

2.4 DESCRIPTION OF SUPPORT UNITS

The EUT has been tested as an independent unit together with other necessary accessories or support units. The following support units or accessories were used to form a representative test configuration during the tests.

Item	Equipment	Mfr/Brand	Model/Type No.	Serial No.	Note
E-2	Adapter	LITEON	PA-1650-86	N/A	N/A
E-3	Router	TP-LINK	TL-WR710N	N/A	N/A
E-4	PoE Injector	TP-LINK	TL-POE150S	N/A	N/A
E-5	Adapter	TP-LINK	T480050-2A1	N/A	N/A
E-6	Personal computer	HP	500-320cx	4CV428DQYN	N/A

Item	Shielded Type	Ferrite Core	Length	Note
C-1	DC Cable	YES	20cm	N/A
C-2	Ethernet cable	NO	60cm	N/A
C-3	Ethernet cable	NO	100cm	N/A

Note:

- 1) The support equipment was authorized by Declaration of Confirmation.
- 2) For detachable type I/O cable should be specified the length in cm in 『Length』 column.
- 3) “YES” is means “shielded” “with core”; “NO” is means “unshielded” “without core”.



2.5 EQUIPMENTS LIST FOR ALL TEST ITEMS

Radiation Test Equipment

Kind of Equipment	Manufacturer	Type No.	Serial No.	Last Calibration	Calibrated Until
Test Receiver	R&S	ESCI	101427	2018.10.13	2019.10.12
Bilog Antenna	TESEQ	CBL6111D	34678	2017.11.02	2020.11.01
Horn Antenna	Schwarzbeck	BBHA 9120D(1201)	9120D-1343	2017.10.27	2020.10.26
SHF-EHF Horn Antenna (18G-40GHz)	A-INFO	LB-180400-KF	N/A	2018.03.11	2021.03.10
Temperature & Humidity	HH660	Mieo	N/A	2018.10.13	2019.10.12
Pre-mpifier (0.1M-3GHz)	EM	EM330	N/A	2018.03.09	2019.03.08
PreAmplifier (1G-18GHz)	SKET	LNPA-01018G-45	SK201808090 1	2018.10.13	2019.10.12
Passive Loop (9K--30MHz)	ZHINAN	ZN30900C	16035	2017.03.11	2020.03.10
Low frequency cable	EM	R01	N/A	2018.03.11	2019.03.10
Low frequency cable	EM	R06	N/A	2018.03.11	2019.03.10
High frequency cable	SCHWARZBECK	R04	N/A	2018.03.11	2019.03.10
High frequency cable	SCHWARZBECK	R02	N/A	2018.03.11	2019.03.10
Semi-anechoic chamber	Changling	966	N/A	2018.10.24	2020.10.23
turn table	EM	SC100_1	60531	N/A	N/A
Antenna mast	EM	SC100	N/A	N/A	N/A
Max-full Antenna Corp	MF	MFA-440H	N/A	N/A	N/A

Conduction Test Equipment

Kind of Equipment	Manufacturer	Type No.	Serial No.	Last Calibration	Calibrated Until
Test Receiver	R&S	ESCI	101427	2018.10.13	2019.10.12
LISN	R&S	ENV216	101242	2018.10.13	2019.10.12
conduction Cable	EM	C01	N/A	2018.03.11	2019.03.10
Temperature & Humidity	Mieo	HH660	N/A	2018.10.13	2019.10.12



RF Connected Test

Kind of Equipment	Manufacturer	Type No.	Serial No.	Last Calibration	Calibrated Until
USB RF power sensor	DARE	RPR3006W	15I00041SNO03	2018.10.13	2019.10.12
MXA Signal analyzer	Agilent	N9020A	MY51110105	2018.03.08	2019.03.07
MXA Signal analyzer	Agilent	N9020A	MY49100060	2018.10.13	2019.10.12

Note:

The temporary antenna connector is soldered on the PCB board in order to perform conducted tests and this temporary antenna connector is listed in the equipment list.





3 EMC EMISSION TEST

3.1 CONDUCTED EMISSION MEASUREMENT

3.1.1 POWER LINE CONDUCTED EMISSION LIMITS

operating frequency band. In case the emission fall within the restricted band specified on Part 15. 207(a), 107(a), RSS-Gen Table3 and ICES-003 Table2 limit in the table below has to be followed. This item was performed according to the procedures in ANSI C63.10: 2013 and ANSI C63.4: 2014.

FREQUENCY (MHz)	Conducted Emissionlimit (dBuV)	
	Quasi-peak	Average
0.15 -0.5	66 - 56 *	56 - 46 *
0.50 -5.0	56.00	46.00
5.0 -30.0	60.00	50.00

Note:

- 1) The tighter limit applies at the band edges.
- 2) The limit of " * " marked band means the limitation decreases linearly with the logarithm of the frequency in the range.

The following table is the setting of the receiver

Receiver Parameters	Setting
Attenuation	10 dB
Start Frequency	0.15 MHz
Stop Frequency	30 MHz
IF Bandwidth	9 kHz

3.1.2 TEST PROCEDURE

- a. The EUT was 0.8 meters from the horizontal ground plane and 0.4 meters from the vertical ground plane with EUT being connected to the power mains through a line impedance stabilization network (LISN). All other support equipments powered from additional LISN(s). The LISN provide 50 Ohm/ 50uH of coupling impedance for the measuring instrument.
- b. Interconnecting cables that hang closer than 40 cm to the ground plane shall be folded back and forth in the center forming a bundle 30 to 40 cm long.
- c. I/O cables that are not connected to a peripheral shall be bundled in the center. The end of the cable may be terminated, if required, using the correct terminating impedance. The overall length shall not exceed 1 m.
- d. LISN at least 80 cm from nearest part of EUT chassis.
- e. For the actual test configuration, please refer to the related Item –EUT Test Photos.

3.1.3 TEST SETUP

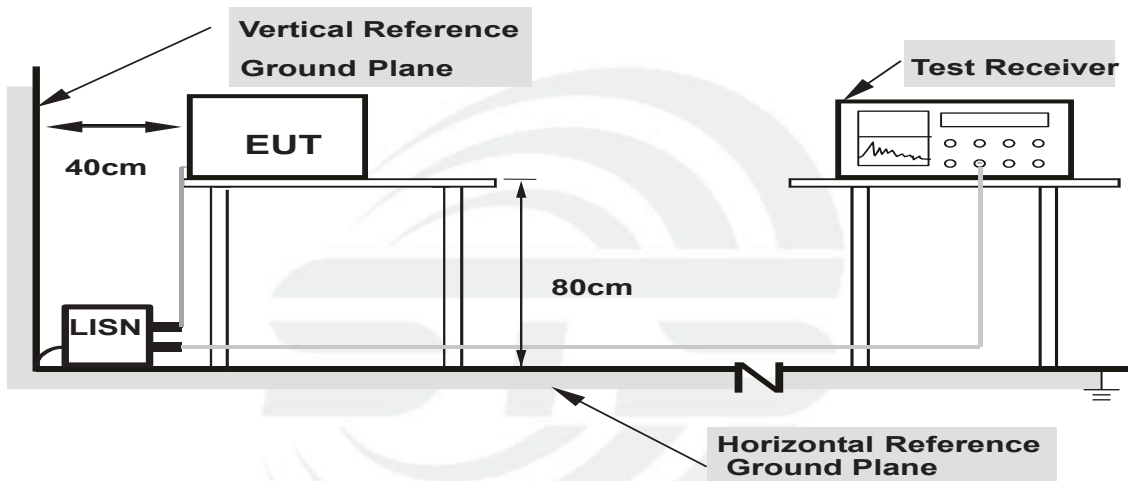

- Note:**
- 1. Support units were connected to second LISN.
 - 2. Both of LISNs (AMN) are 80 cm from EUT and at least 80 from other units and other metal planes

3.1.4 EUT OPERATING CONDITIONS

The EUT was configured for testing in a typical fashion (as a customer would normally use it). The EUT has been programmed to continuously transmit during test. This operating condition was tested and used to collect the included data.



3.1.5 TEST RESULT

Temperature:	23.5°C	Relative Humidity:	59%
Test Voltage:	DC 12V	Phase:	L
Test Mode:	Mode 10		

Frequency (MHz)	Reading (dBuV)	Correct Factor(dB)	Result (dBuV)	Limit (dBuV)	Margin (dB)	Remark
0.1700	24.05	20.23	44.28	64.96	-20.68	QP
0.1700	0.32	20.23	20.55	54.96	-34.41	AVG
0.3220	22.23	20.67	42.90	59.66	-16.76	QP
0.3220	8.25	20.67	28.92	49.66	-20.74	AVG
0.4100	26.49	20.49	46.98	57.65	-10.67	QP
0.4100	12.44	20.49	32.93	47.65	-14.72	AVG
0.8340	19.55	20.22	39.77	56.00	-16.23	QP
0.8340	5.07	20.22	25.29	46.00	-20.71	AVG
1.1940	18.71	20.14	38.85	56.00	-17.15	QP
1.1940	3.86	20.14	24.00	46.00	-22.00	AVG
11.8260	24.65	20.08	44.73	60.00	-15.27	QP
11.8260	10.28	20.08	30.36	50.00	-19.64	AVG

Remark:

1. All readings are Quasi-Peak and Average values.
2. Margin = Result (Result =Reading + Factor) –Limit

100.0 dBuV

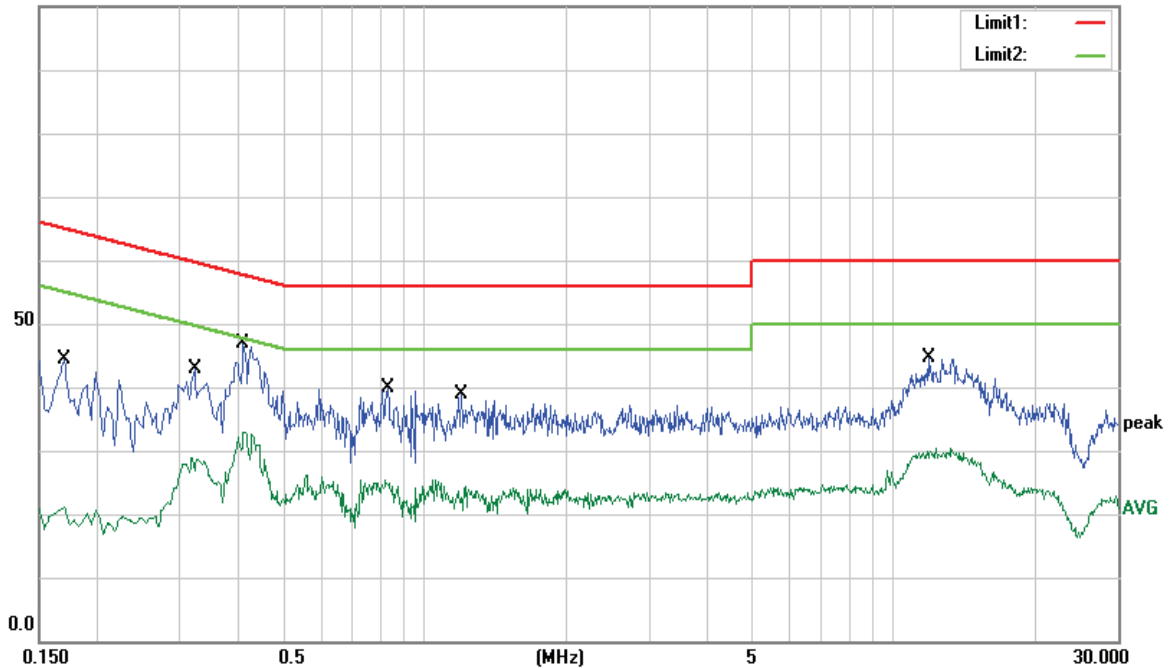



Temperature:	23.5°C	Relative Humidity:	59%
Test Voltage:	DC 12V	Phase:	N
Test Mode:	Mode 10		

Frequency (MHz)	Reading (dBuV)	Correct Factor(dB)	Result (dBuV)	Limit (dBuV)	Margin (dB)	Remark
0.3302	23.58	20.69	44.27	59.45	-15.18	QP
0.3302	9.61	20.69	30.30	49.45	-19.15	AVG
0.4220	28.79	20.50	49.29	57.41	-8.12	QP
0.4220	13.50	20.50	34.00	47.41	-13.41	AVG
0.8660	23.64	20.21	43.85	56.00	-12.15	QP
0.8660	6.76	20.21	26.97	46.00	-19.03	AVG
1.2260	21.91	20.16	42.07	56.00	-13.93	QP
1.2260	6.29	20.16	26.45	46.00	-19.55	AVG
1.8420	21.23	20.15	41.38	56.00	-14.62	QP
1.8420	4.78	20.15	24.93	46.00	-21.07	AVG
11.0580	23.88	19.84	43.72	60.00	-16.28	QP
11.0580	10.99	19.84	30.83	50.00	-19.17	AVG

Remark:

1. All readings are Quasi-Peak and Average values.
2. Margin = Result (Result = Reading + Factor) – Limit

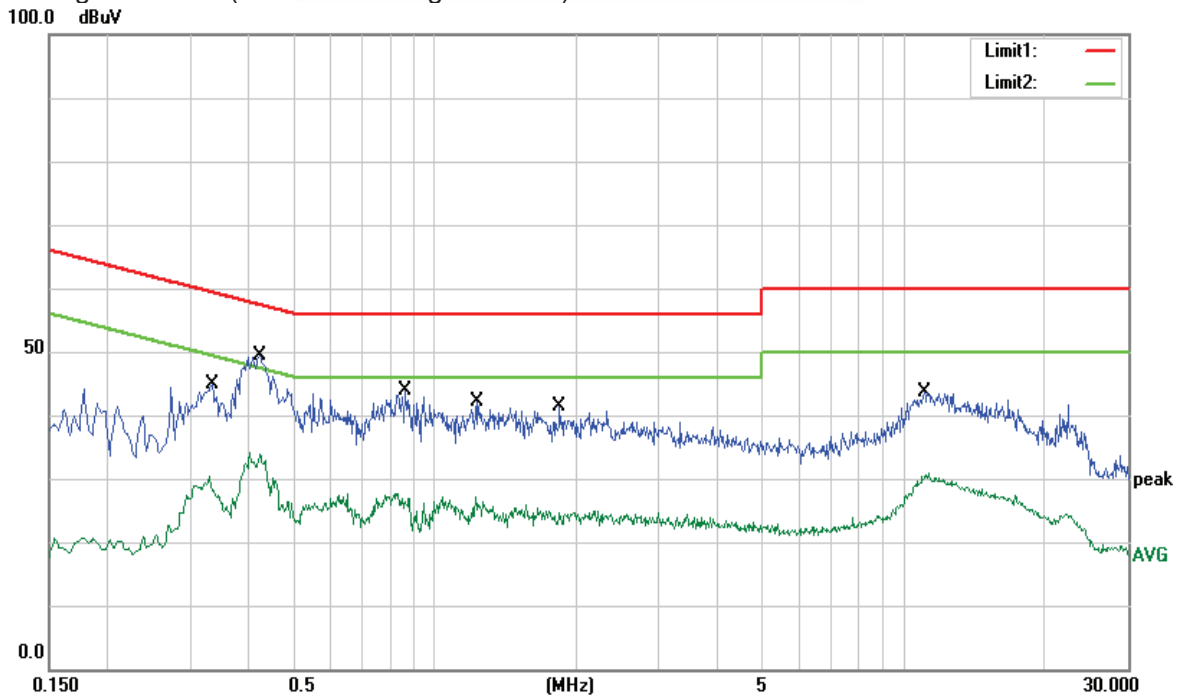



Temperature:	23.5°C	Relative Humidity:	59%
Test Voltage:	DC 12V	Phase:	N
Test Mode:	Mode 11 (Part 15B & ICES-003)		

Frequency (MHz)	Reading (dBuV)	Correct Factor(dB)	Result (dBuV)	Limit (dBuV)	Margin (dB)	Remark
0.4140	28.32	20.49	48.81	57.57	-8.76	QP
0.4140	17.98	20.49	38.47	47.57	-9.10	AVG
0.5340	24.65	20.44	45.09	56.00	-10.91	QP
0.5340	9.73	20.44	30.17	46.00	-15.83	AVG
0.7820	23.12	20.23	43.35	56.00	-12.65	QP
0.7820	9.46	20.23	29.69	46.00	-16.31	AVG
2.1580	22.25	20.04	42.29	56.00	-13.71	QP
2.1580	7.93	20.04	27.97	46.00	-18.03	AVG
6.5420	22.71	19.91	42.62	60.00	-17.38	QP
6.5420	9.23	19.91	29.14	50.00	-20.86	AVG
10.6860	23.67	20.11	43.78	60.00	-16.22	QP
10.6860	11.68	20.11	31.79	50.00	-18.21	AVG

Remark:

1. All readings are Quasi-Peak and Average values.
2. Margin = Result (Result = Reading + Factor) – Limit

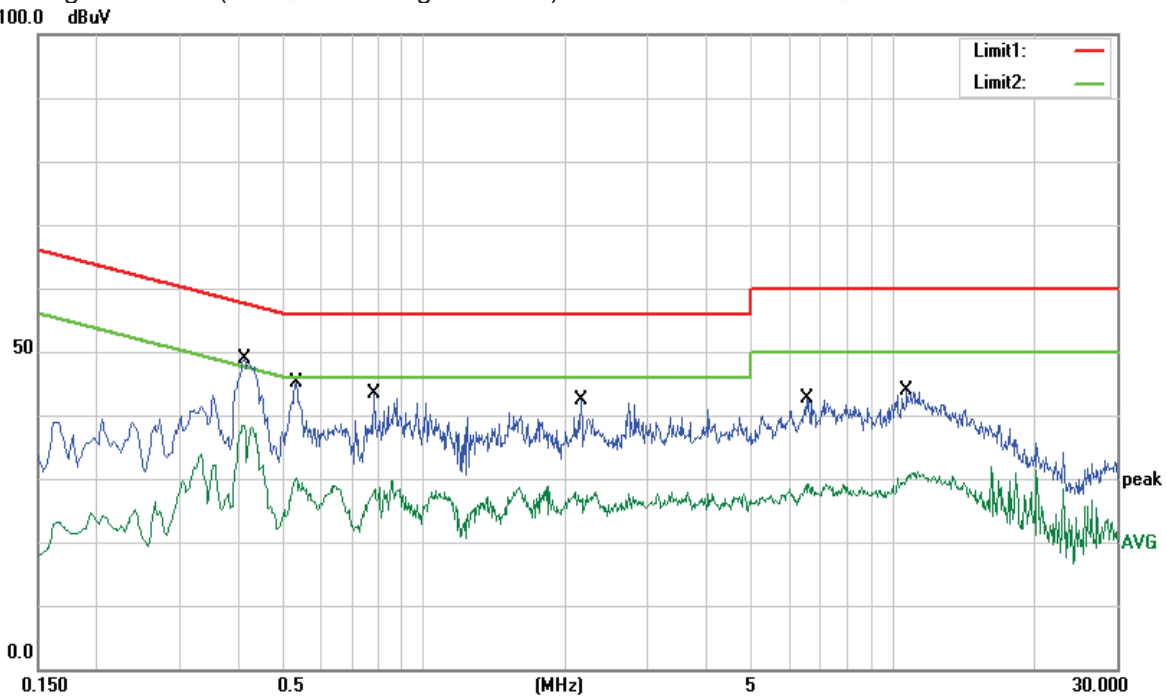



Temperature:	23.5°C	Relative Humidity:	59%
Test Voltage:	DC 12V	Phase:	L
Test Mode:	Mode 11 (Part 15B& ICES-003)		

Frequency (MHz)	Reading (dBuV)	Correct Factor(dB)	Result (dBuV)	Limit (dBuV)	Margin (dB)	Remark
0.2660	23.83	20.61	44.44	61.24	-16.80	QP
0.2660	9.73	20.61	30.34	51.24	-20.90	AVG
0.4100	31.36	20.51	51.87	57.65	-5.78	QP
0.4100	17.92	20.51	38.43	47.65	-9.22	AVG
0.5300	25.41	20.40	45.81	56.00	-10.19	QP
0.5300	12.12	20.40	32.52	46.00	-13.48	AVG
0.8540	25.95	20.21	46.16	56.00	-9.84	QP
0.8540	10.29	20.21	30.50	46.00	-15.50	AVG
2.1540	23.54	20.13	43.67	56.00	-12.33	QP
2.1540	7.75	20.13	27.88	46.00	-18.12	AVG
11.8100	26.82	19.84	46.66	60.00	-13.34	QP
11.8100	13.18	19.84	33.02	50.00	-16.98	AVG

Remark:

1. All readings are Quasi-Peak and Average values.
2. Margin = Result (Result = Reading + Factor) – Limit

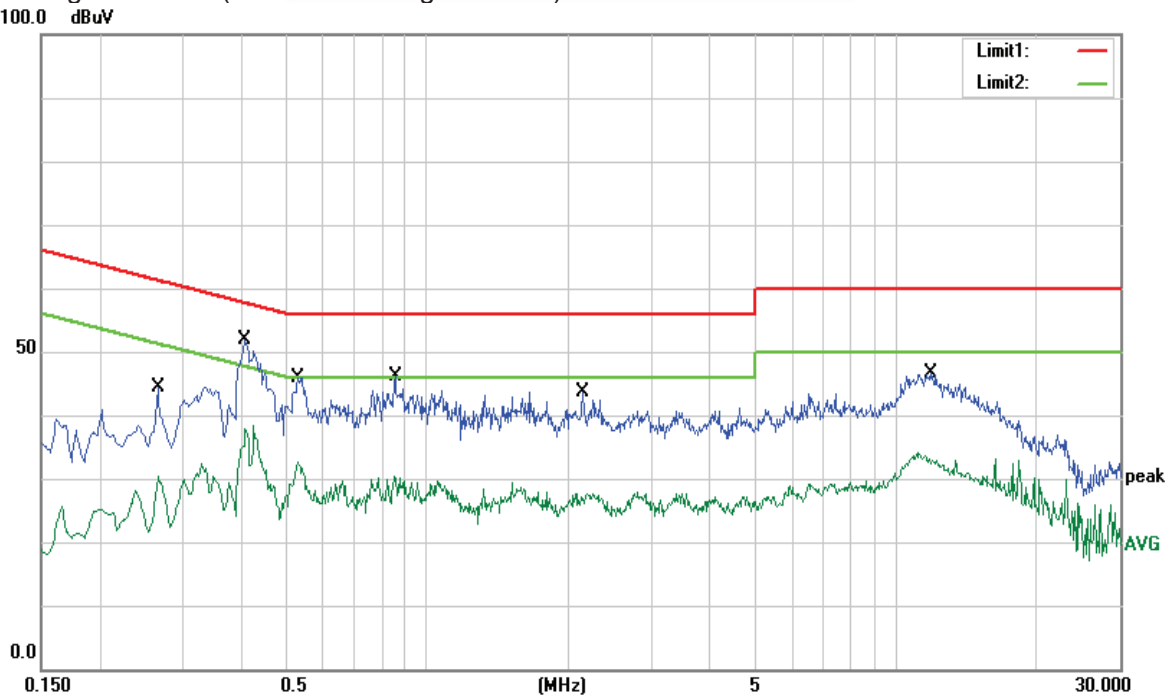



Temperature:	23.5°C	Relative Humidity:	59%
Test Voltage:	DC 12V	Phase:	N
Test Mode:	Mode 12 (Part 15B & ICES-003)		

Frequency (MHz)	Reading (dBuV)	Correct Factor(dB)	Result (dBuV)	Limit (dBuV)	Margin (dB)	Remark
0.1740	21.66	20.26	41.92	64.77	-22.85	QP
0.1740	6.69	20.26	26.95	54.77	-27.82	AVG
0.2700	18.70	20.63	39.33	61.12	-21.79	QP
0.2700	5.04	20.63	25.67	51.12	-25.45	AVG
0.5140	23.81	20.42	44.23	56.00	-11.77	QP
0.5140	15.35	20.42	35.77	46.00	-10.23	AVG
1.4940	12.08	20.15	32.23	56.00	-23.77	QP
1.4940	3.13	20.15	23.28	46.00	-22.72	AVG
3.4740	12.36	20.07	32.43	56.00	-23.57	QP
3.4740	2.62	20.07	22.69	46.00	-23.31	AVG
9.0420	11.53	19.88	31.41	60.00	-28.59	QP
9.0420	0.28	19.88	20.16	50.00	-29.84	AVG

Remark:

1. All readings are Quasi-Peak and Average values.
2. Margin = Result (Result = Reading + Factor) – Limit

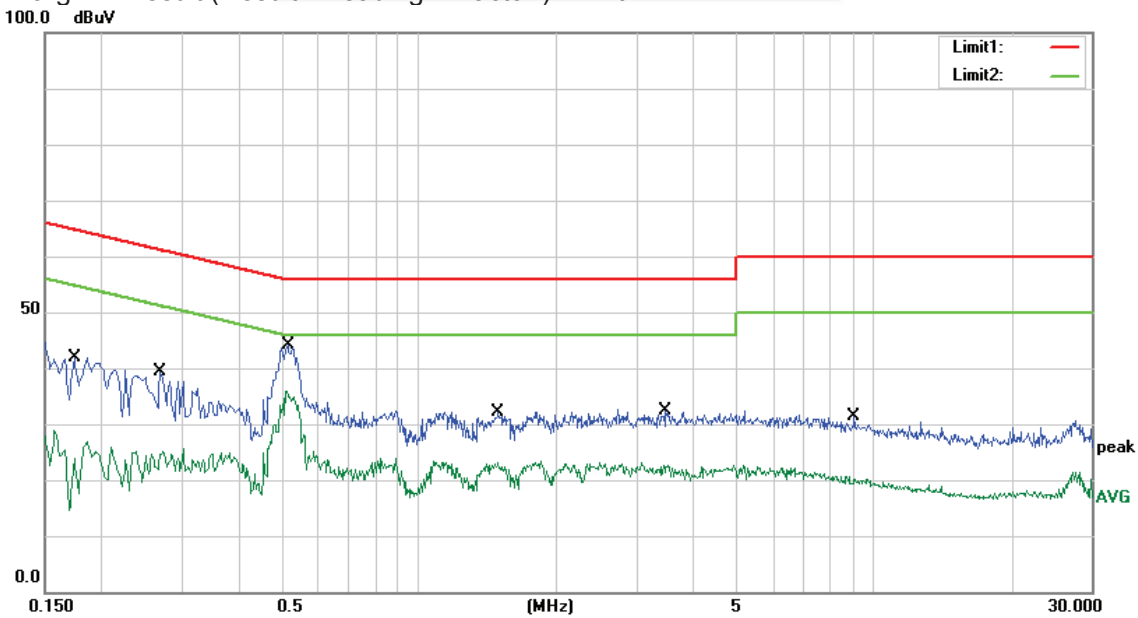



Temperature:	23.5°C	Relative Humidity:	59%
Test Voltage:	DC 12V	Phase:	L
Test Mode:	Mode 12 (Part 15B& ICES-003)		

Frequency (MHz)	Reading (dBuV)	Correct Factor(dB)	Result (dBuV)	Limit (dBuV)	Margin (dB)	Remark
0.1500	23.75	20.23	43.98	66.00	-22.02	QP
0.1500	5.85	20.23	26.08	56.00	-29.92	AVG
0.1740	21.99	20.24	42.23	64.77	-22.54	QP
0.1740	5.46	20.24	25.70	54.77	-29.07	AVG
0.5140	22.01	20.47	42.48	56.00	-13.52	QP
0.5140	14.23	20.47	34.70	46.00	-11.30	AVG
1.1620	11.56	20.15	31.71	56.00	-24.29	QP
1.1620	2.79	20.15	22.94	46.00	-23.06	AVG
5.3700	13.87	19.92	33.79	60.00	-26.21	QP
5.3700	4.10	19.92	24.02	50.00	-25.98	AVG
28.1780	10.38	19.39	29.77	60.00	-30.23	QP
28.1780	1.40	19.39	20.79	50.00	-29.21	AVG

Remark:

1. All readings are Quasi-Peak and Average values.
2. Margin = Result (Result = Reading + Factor) – Limit

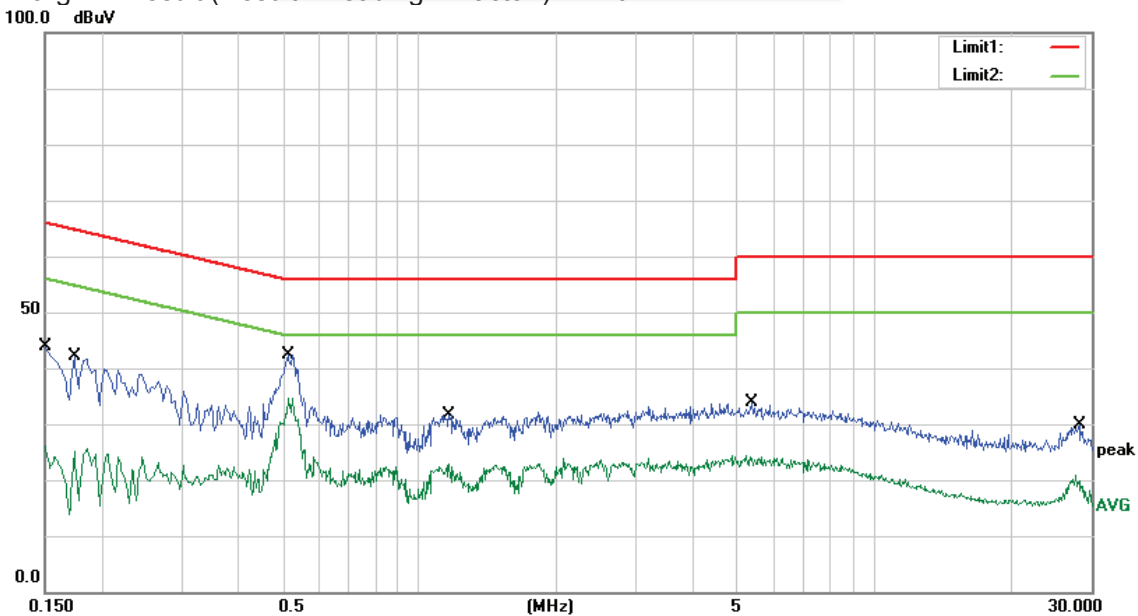



3.2 RADIATED EMISSION MEASUREMENT

3.2.1 RADIATED EMISSION LIMITS

Frequencies (MHz)	Class A (at 10m) dBuV/m	Class B (at 3m) dBuV/m
30~88	39.0	40.0
88~216	43.5	43.5
216~960	46.5	46.0
Above 960	49.5	54.0

LIMITS OF RADIATED EMISSION MEASUREMENT (Above 1000MHz)

FREQUENCY (MHz)	Class A (dBuV/m) (at 3M)		Class B (dBuV/m) (at 3M)	
	PEAK	AVERAGE	PEAK	AVERAGE
Above 1000	80	60	74	54

Note:

- 1) The tighter limit applies at the band edges.
- 2) Emission level (dBuV/m)=20log Emission level (uV/m).

3.2.2 TEST PROCEDURE

- a) The measuring distance of at 3 m shall be used for measurements at frequency up to 1GHz. For frequencies above 1GHz, any suitable measuring distance may be used.
- b) The EUT was placed on the top of a rotating table 0.8 meters above the ground at a 3 meter open area test site. The table was rotated 360 degrees to determine the position of the highest radiation.
- c) The height of the equipment or of the substitution antenna shall be 0.8 m; the height of the test antenna shall vary between 0.8 m to 4 m. Both horizontal and vertical polarizations of the antenna are set to make the measurement.
- d) The initial step in collecting conducted emission data is a spectrum analyzer peak detector mode pre-scanning the measurement frequency range. Significant peaks are then marked and then Quasi Peak detector mode re-measured.
- e) If the Peak Mode measured value compliance with and lower than Quasi Peak Mode Limit, the EUT shall be deemed to meet QP Limits and then no additional QP Mode measurement performed.
- f) For the actual test configuration, please refer to the related Item –EUT Test Photos.

Note: Both horizontal and vertical antenna polarities were tested and performed pretest to three orthogonal axis. The worst case emissions were reported

3.2.3 TEST SETUP

a) Radiated Emission Test-Up Frequency 30MHz~1GHz

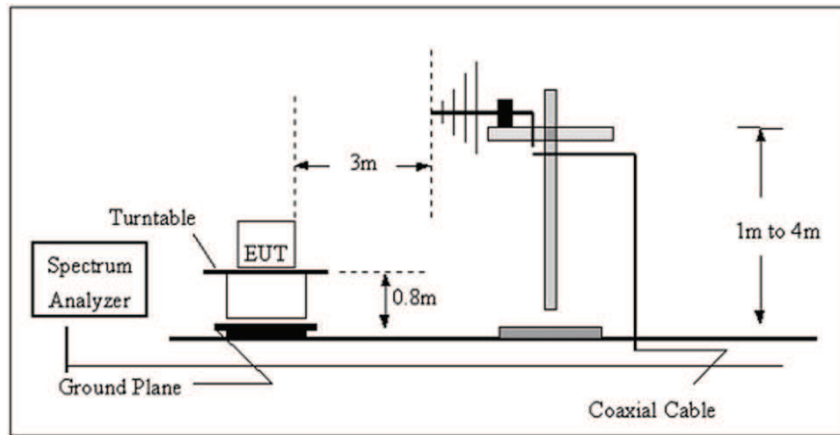

b) Radiated Emission Test-Up Frequency Above 1GHz

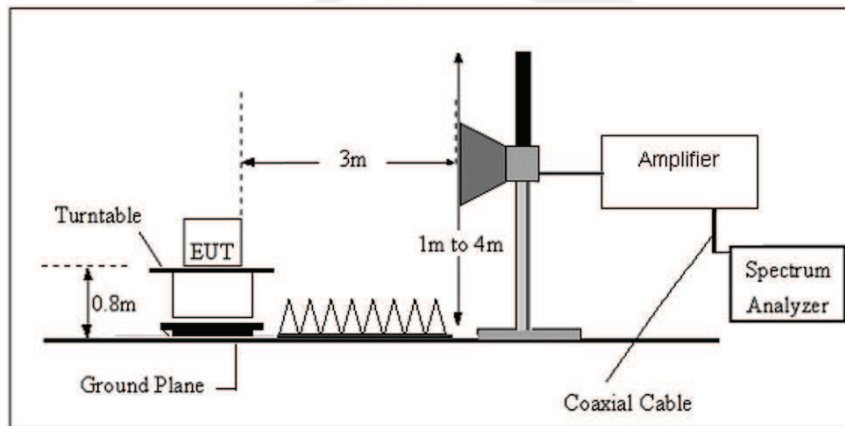

3.2.4 EUT OPERATING CONDITIONS

The EUT tested system was configured as the statements of 2.4 Unless otherwise a special operating condition is specified in the follows during the testing.



3.2.5 TEST RESULTS

Between 30-1000MHz:

Temperature:	23.3°C	Relative Humidity:	49%
Pressure:	1010hPa	Phase:	Horizontal
Test Voltage:	DC 12V	Test Mode:	Mode 11 (Part 15B & ICES-003)

No.	Frequency (MHz)	Reading (dBuV)	Factor (dB)	Results (dBuV/m)	Limit (dBuV/m)	Margin (dB)	Detector
1	77.0504	51.41	-23.10	28.31	40.00	-11.69	QP
2	176.8877	56.65	-19.41	37.24	43.50	-6.26	QP
3	267.5455	56.33	-15.38	40.95	46.00	-5.05	QP
4	550.9480	46.67	-6.76	39.91	46.00	-6.09	QP
5	750.1082	44.76	-3.56	41.20	46.00	-4.80	QP
6	1000.0000	42.40	-0.07	42.33	54.00	-11.67	QP

Remark:

1. All readings are Quasi-Peak .
2. Margin = Result (Result =Reading + Factor)-Limit

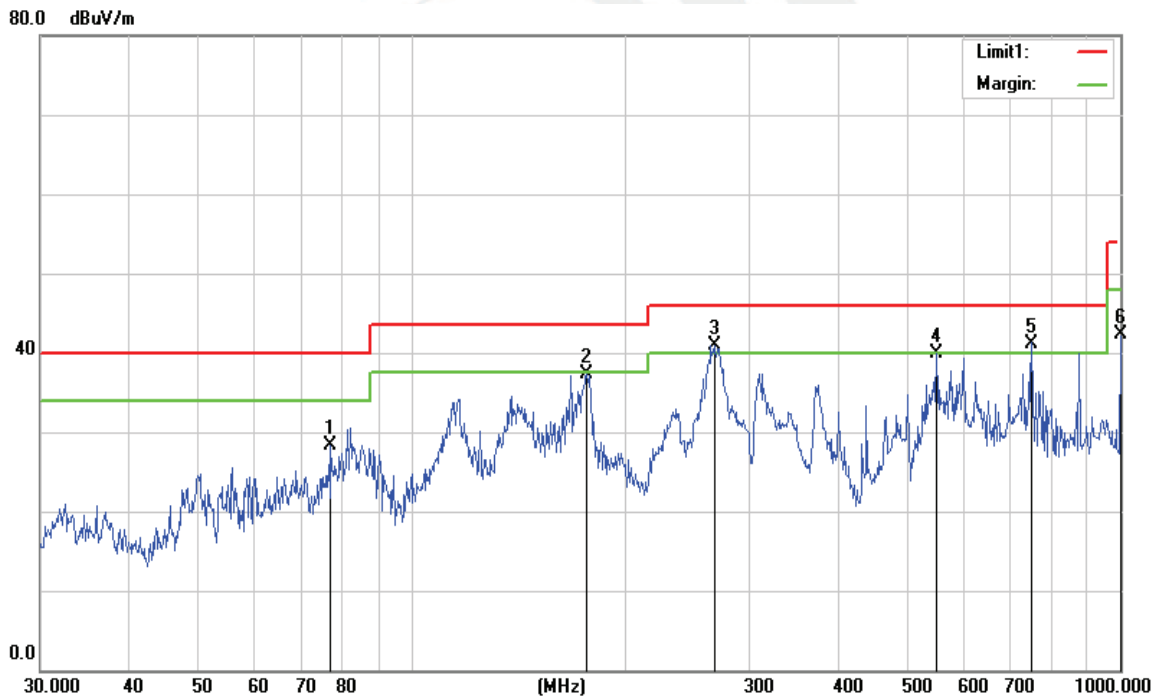



Temperature:	23.3°C	Relative Humidity:	49%
Pressure:	1010hPa	Phase:	Vertical
Test Voltage:	DC 12V	Test Mode:	Mode 11 (Part 15B & ICES-003)

No.	Frequency (MHz)	Reading (dBuV)	Factor (dB)	Results (dBuV/m)	Limit (dBuV/m)	Margin (dB)	Detector
1	37.2854	47.38	-14.93	32.45	40.00	-7.55	QP
2	76.5121	57.76	-23.18	34.58	40.00	-5.42	QP
3	167.8241	56.42	-19.15	37.27	43.50	-6.23	QP
4	264.7456	55.77	-15.26	40.51	46.00	-5.49	QP
5	550.9480	48.25	-6.76	41.49	46.00	-4.51	QP
6	1000.0000	48.37	-0.07	48.30	54.00	-5.70	QP

- Remark:
1. All readings are Quasi-Peak .
 2. Margin = Result (Result =Reading + Factor)-Limit

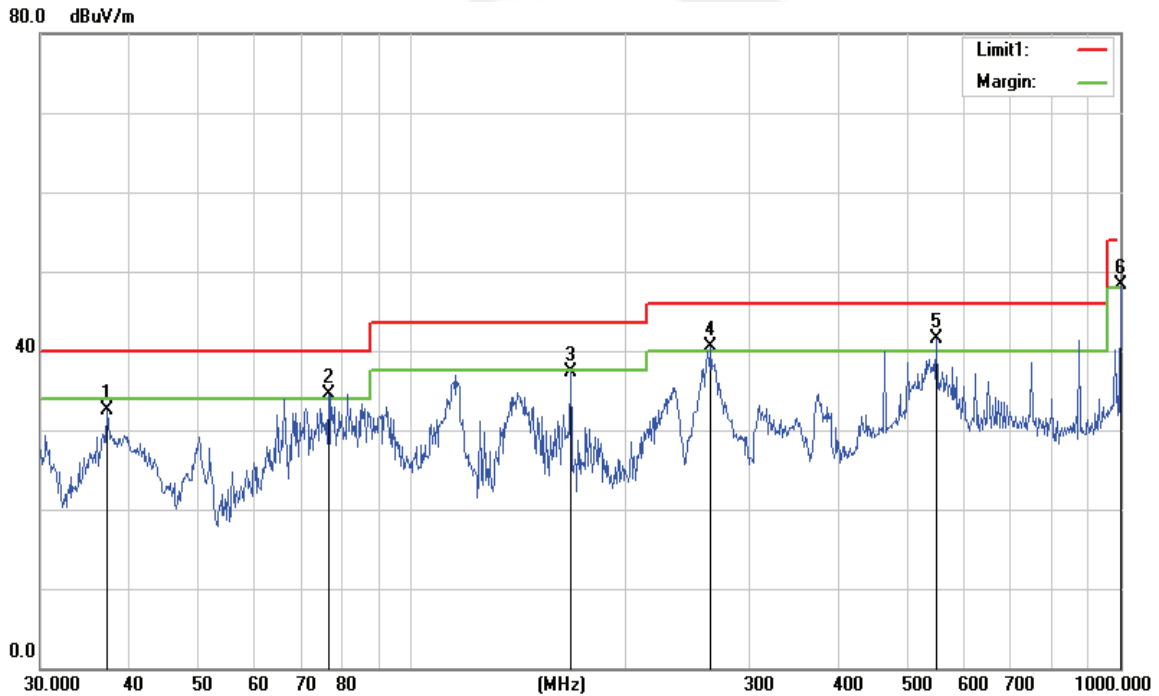



Temperature:	23.3°C	Relative Humidity:	49%
Pressure:	1010hPa	Phase:	Horizontal
Test Voltage:	DC 12V	Test Mode:	Mode 12 (Part 15B & ICES-003)

No.	Frequency (MHz)	Reading (dBuV)	Factor (dB)	Results (dBuV/m)	Limit (dBuV/m)	Margin (dB)	Detector
1	47.9940	43.65	-20.45	23.20	40.00	-16.80	QP
2	119.4361	57.09	-17.72	39.37	43.50	-4.13	QP
3	167.8243	59.31	-19.15	40.16	43.50	-3.34	QP
4	438.6554	49.65	-10.89	38.76	46.00	-7.24	QP
5	550.9480	47.17	-6.76	40.41	46.00	-5.59	QP
6	900.1474	41.58	-2.26	39.32	46.00	-6.68	QP

Remark:

1. All readings are Quasi-Peak .
2. Margin = Result (Result =Reading + Factor)–Limit





Temperature:	23.3°C	Relative Humidity:	49%
Pressure:	1010hPa	Phase:	Vertical
Test Voltage:	DC 12V	Test Mode:	Mode 12 (Part 15B & ICES-003)

No.	Frequency (MHz)	Reading (dBuV)	Factor (dB)	Results (dBuV/m)	Limit (dBuV/m)	Margin (dB)	Detector
1	30.1053	43.40	-11.24	32.16	40.00	-7.84	QP
2	42.7496	48.21	-17.75	30.46	40.00	-9.54	QP
3	128.1130	55.86	-17.58	38.28	43.50	-5.22	QP
4	167.8242	57.80	-19.15	38.65	43.50	-4.85	QP
5	580.7025	49.67	-6.73	42.94	46.00	-3.06	QP
6	651.9416	48.36	-6.29	42.07	46.00	-3.93	QP

- Remark:
1. All readings are Quasi-Peak .
 2. Margin = Result (Result =Reading + Factor)-Limit

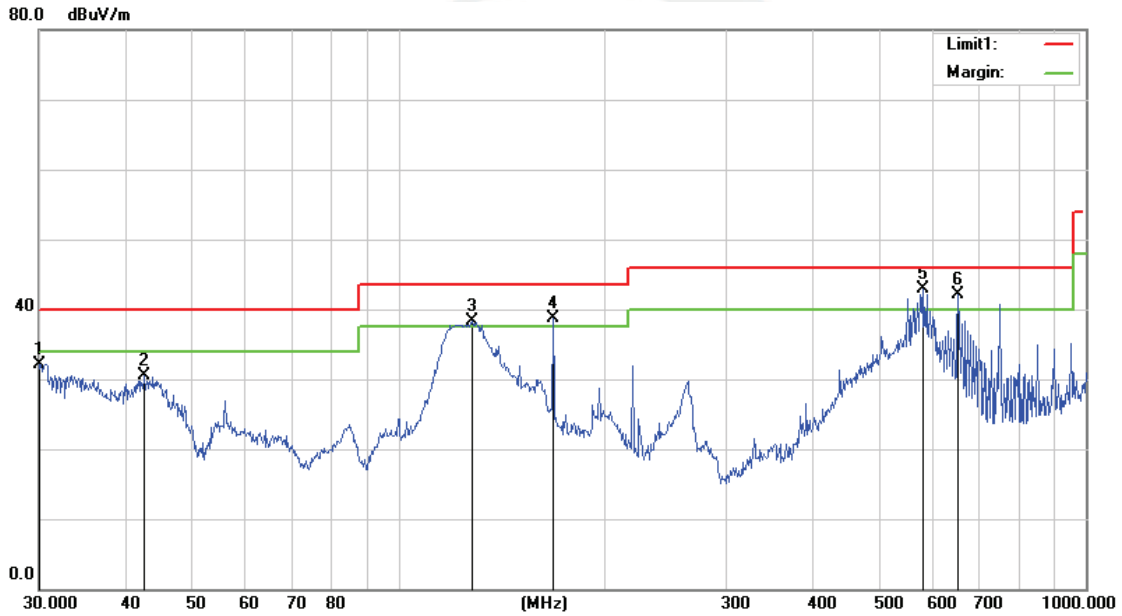



Above 1GHz:

Temperature:	25°C	Relative Humidity:	65%
Pressure:	1010hPa	Phase:	Horizontal
Test Voltage:	DC 12V	Test Mode:	Mode 12 (Part 15B & ICES-003)

RE_FCC Test Case_FCC 15B 1GHz-25GHz

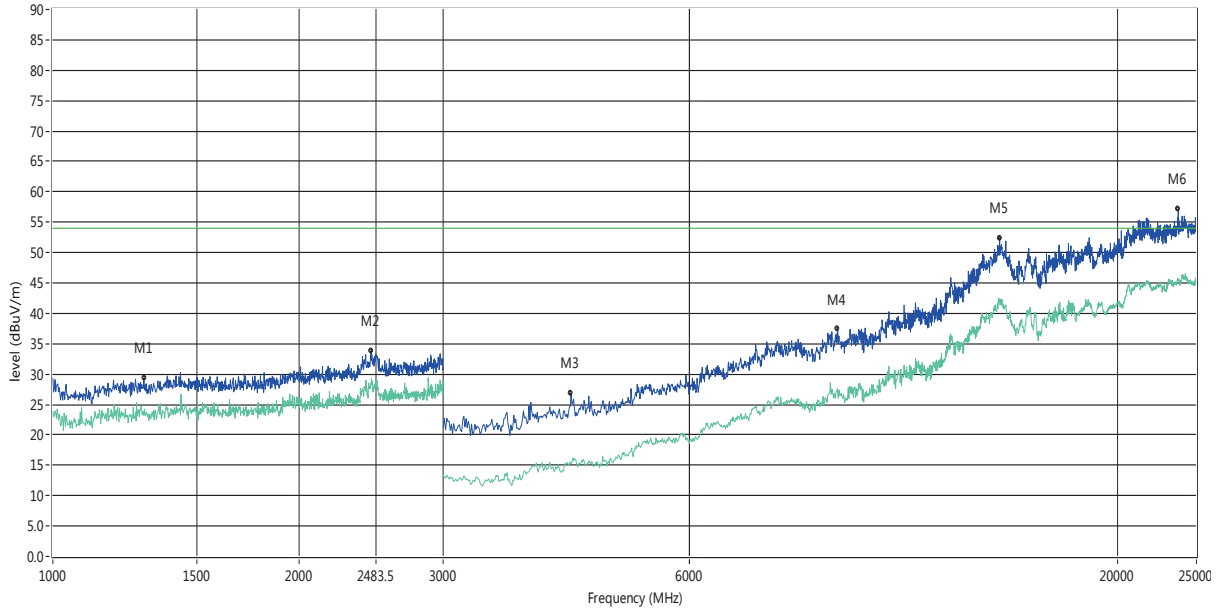

No.	Frequency (MHz)	Results (dBuV/m)	Factor (dB)	Limit (dBuV/m)	Over Limit (dB)	Detector	ANT	Verdict
1**	1292.000	23.19	-19.44	54.0	-30.81	AV	H	Pass
1	1292.000	29.28	-19.44	74.0	-44.72	Peak	H	Pass
2**	2450.000	28.51	-13.79	54.0	-25.49	AV	H	Pass
2	2450.000	33.81	-13.79	74.0	-40.19	Peak	H	Pass
3**	4300.000	15.27	1.29	54.0	-38.73	AV	H	Pass
3	4300.000	26.84	1.29	74.0	-47.16	Peak	H	Pass
4**	9110.000	26.70	12.36	54.0	-27.30	AV	H	Pass
4	9110.000	37.44	12.36	74.0	-36.56	Peak	H	Pass
5**	14368.000	41.92	24.92	54.0	-12.08	AV	H	Pass
5	14368.000	52.42	24.92	74.0	-21.58	Peak	H	Pass
6**	23751.999	45.34	23.39	54.0	-8.66	AV	H	Pass
6	23751.999	57.19	23.39	74.0	-16.81	Peak	H	Pass



Temperature:	25°C	Relative Humidity:	65%
Pressure:	1010hPa	Phase:	Vertical
Test Voltage:	DC 12V	Test Mode:	Mode 12 (Part 15B & ICES-003)

RE_FCC Test Case_FCC 15B 1GHz-25GHz

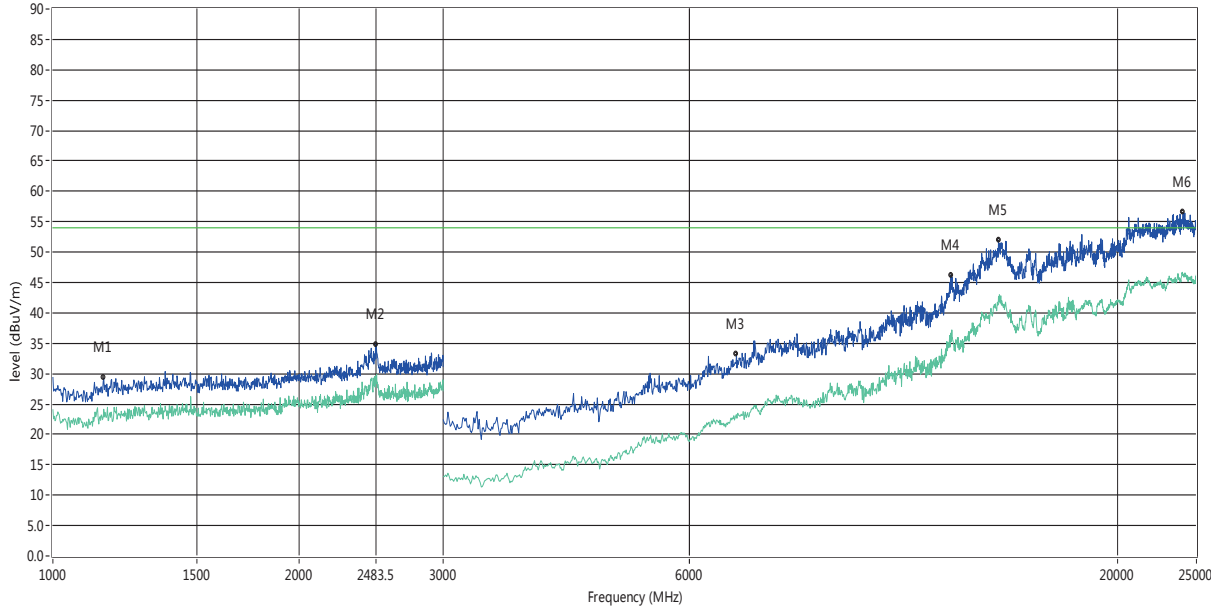

No.	Frequency (MHz)	Results (dBuV/m)	Factor (dB)	Limit (dBuV/m)	Over Limit (dB)	Detector	ANT	Verdict
1**	1154.000	24.13	-19.84	54.0	-29.87	AV	V	Pass
1	1154.000	29.26	-19.84	74.0	-44.74	Peak	V	Pass
2**	2480.000	29.47	-13.63	54.0	-24.53	AV	V	Pass
2	2480.000	34.80	-13.63	74.0	-39.20	Peak	V	Pass
3**	6850.000	23.23	7.39	54.0	-30.77	AV	V	Pass
3	6850.000	33.21	7.39	74.0	-40.79	Peak	V	Pass
4**	12519.999	36.68	19.89	54.0	-17.32	AV	V	Pass
4	12519.999	46.19	19.89	74.0	-27.81	Peak	V	Pass
5**	14320.000	42.66	24.92	54.0	-11.34	AV	V	Pass
5	14320.000	51.95	24.92	74.0	-22.05	Peak	V	Pass
6**	24075.999	46.42	23.28	54.0	-7.58	AV	V	Pass
6	24075.999	56.50	23.28	74.0	-17.50	Peak	V	Pass

3.3 RADIATED SPURIOUS EMISSION MEASUREMENT

3.3.1 RADIATED EMISSION LIMITS

in any 100 kHz bandwidth outside the operating frequency band. In case the emission fall within the Restricted band specified on Part15.205(a)&209(a) and RSS-247 Issue 2 limit in the table and according to ANSI C63.10-2013 below has to be followed.

LIMITS OF RADIATED EMISSION MEASUREMENT (0.009MHz - 1000MHz)

Frequencies (MHz)	Field Strength (micorvolts/meter)	Measurement Distance (meters)
0.009~0.490	2400/F(KHz)	300
0.490~1.705	24000/F(KHz)	30
1.705~30.0	30	30
30~88	100	3
88~216	150	3
216~960	200	3
Above 960	500	3

LIMITS OF RADIATED EMISSION MEASUREMENT (1000MHz-25GHz)

FREQUENCY (MHz)	(dBuV/m) (at 3M)	
	PEAK	AVERAGE
Above 1000	74	54

Notes:

- (1) The limit for radiated test was performed according to FCC PART 15C.
- (2) The tighter limit applies at the band edges.
- (3) Emission level (dBuV/m)=20log Emission level (uV/m).

For Radiated Emission

Spectrum Parameter	Setting
Attenuation	Auto
Detector	Peak/AV
Start Frequency	1000MHz(Peak/AV)
Stop Frequency	10th carrier hamonic(Peak/AV)
RB / VB (emission in restricted	1 MHz /3MHz

For Band edge

Spectrum Parameter	Setting
Detector	Peak/AV
Start/Stop Frequency	Lower Band Edge: 2300 to 2422 MHz Upper Band Edge: 2452to 2500 MHz
RB / VB (emission in restricted band)	1 MHz /3MHz



Receiver Parameter	Setting
Start ~ Stop Frequency	9kHz~90kHz / RB 200Hz for PK & AV
Start ~ Stop Frequency	90kHz~110kHz / RB 200Hz for QP
Start ~ Stop Frequency	110kHz~490kHz / RB 200Hz for PK & AV
Start ~ Stop Frequency	490kHz~30MHz / RB 9kHz for QP
Start ~ Stop Frequency	30MHz~1000MHz / RB 120kHz for QP

3.3.2 TEST PROCEDURE

- The measuring distance of at 3 m shall be used for measurements at frequency 0.009MHz up to 1GHz. For frequencies above 1GHz, any suitable measuring distance may be used.
- The EUT was placed on the top of a rotating table 0.8 meters(above 1GHz is 1.5 m) above the ground at a 3 meter anechoic chamber. The table was rotated 360 degrees to determine the position of the highest radiation.
- The height of the equipment shall be 0.8 m(above 1GHz is 1.5 m); the height of the test antenna shall vary between 1 m to 4 m. Horizontal and vertical polarizations of the antenna are set to make the measurement
- The initial step in collecting conducted emission data is a spectrum analyzer peak detector mode pre-scanning the measurement frequency range. Significant peaks are then marked and then Quasi Peak detector mode re-measured.
- If the Peak Mode measured value compliance with and lower than Quasi Peak Mode Limit, the EUT shall be deemed to meet QP Limits and then no additional QP Mode measurement performed.
- For the actual test configuration, please refer to the related Item –EUT Test Photos.

Note:

Both horizontal and vertical antenna polarities were tested and performed test to three orthogonal axis. The worst case emissions were reported

3.3.3 TEST SETUP

a) Radiated Emission Test-Up Frequency Below 30MHz

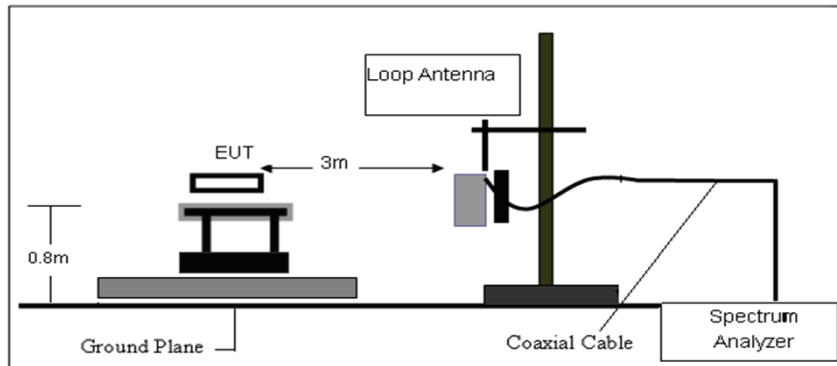

b) Radiated Emission Test-Up Frequency 30MHz~1GHz

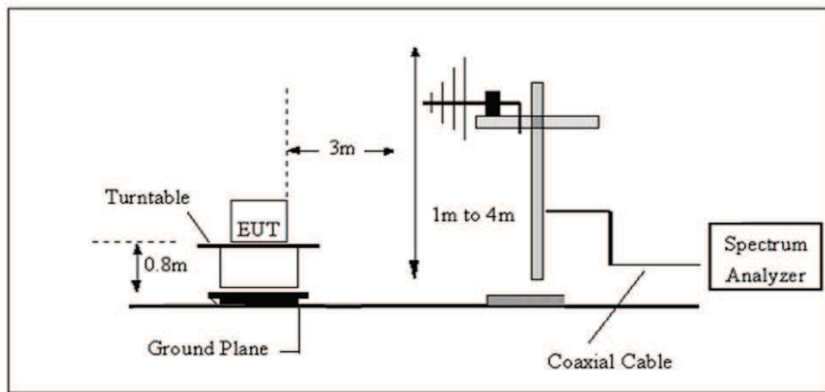

c) Radiated Emission Test-Up Frequency Above 1GHz

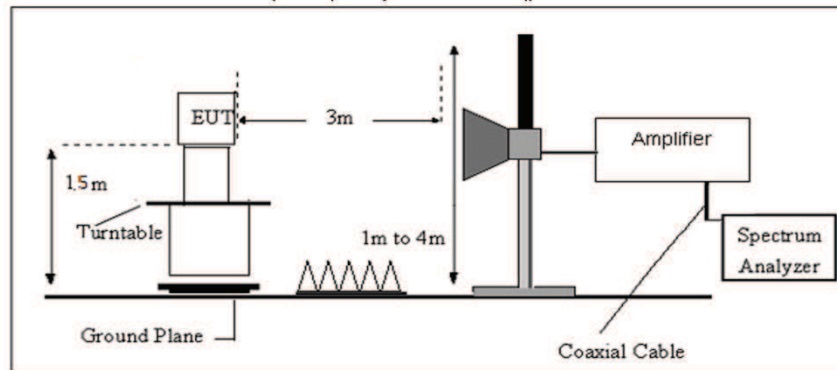

3.3.4 EUT OPERATING CONDITIONS

The EUT tested system was configured as the statements of 2.3 Unless otherwise a special operating condition is specified in the follows during the testing.



3.3.5 FIELD STRENGTH CALCULATION

The field strength is calculated by adding the Antenna Factor and Cable Factor and subtracting the Amplifier Gain and Duty Cycle Correction Factor (if any) from the measured reading. The basic equation with a sample calculation is as follows:

$$FS = RA + AF + CL - AG$$

Where

FS = Field Strength

CL = Cable Attenuation Factor (Cable Loss)

RA = Reading Amplitude

AG = Amplifier Gain

AF = Antenna Factor

For example

Frequency (MHz)	FS (dB μ V/m)	RA (dB μ V/m)	AF (dB)	CL (dB)	AG (dB)	Factor (dB)
300	40	58.1	12.2	1.6	31.9	-18.1

$$\text{Factor} = \text{AF} + \text{CL} - \text{AG}$$

3.3.6 TEST RESULT

9KHz-30MHz

Temperature:	23.3°C	Relative Humidity:	49%
Test Voltage:	DC 12V	Polarization :	--
Test Mode :	TX Mode		

Freq. (MHz)	Reading (dBuV/m)	Limit (dBuV/m)	Margin (dB)	State P/F	Test Result
--	--	--	--	--	PASS
--	--	--	--	--	PASS

Note:

The amplitude of spurious emissions which are attenuated by more than 20dB below the permissible value has no need to be reported.

Distance extrapolation factor = $40 \log(\text{specific distance}/\text{test distance})$ (dB);

Limit line = specific limits(dBuv) + distance extrapolation factor.



(30MHz - 1000MHz)

Temperature:	23.3°C	Relative Humidity:	49%
Test Voltage:	DC 12V	Polarization :	Horizontal
Test Mode :	Mode 1/2/3/4/5/6/7/8/9 (Mode 2-1Mbps worst mode)		

Frequency (MHz)	Reading (dBuV)	Correct Factor(dB/m)	Result (dBuV/m)	Limit (dBuV/m)	Margin (dB)	Remark
41.5670	47.65	-17.13	30.52	40.00	-9.48	QP
98.1420	52.64	-19.38	33.26	43.50	-10.24	QP
145.3505	56.06	-17.75	38.31	43.50	-5.19	QP
263.8190	54.52	-15.22	39.30	46.00	-6.70	QP
438.6553	47.06	-10.89	36.17	46.00	-9.83	QP
750.1082	43.29	-3.56	39.73	46.00	-6.27	QP

Remark:

1. Margin = Result (Result =Reading + Factor)-Limit

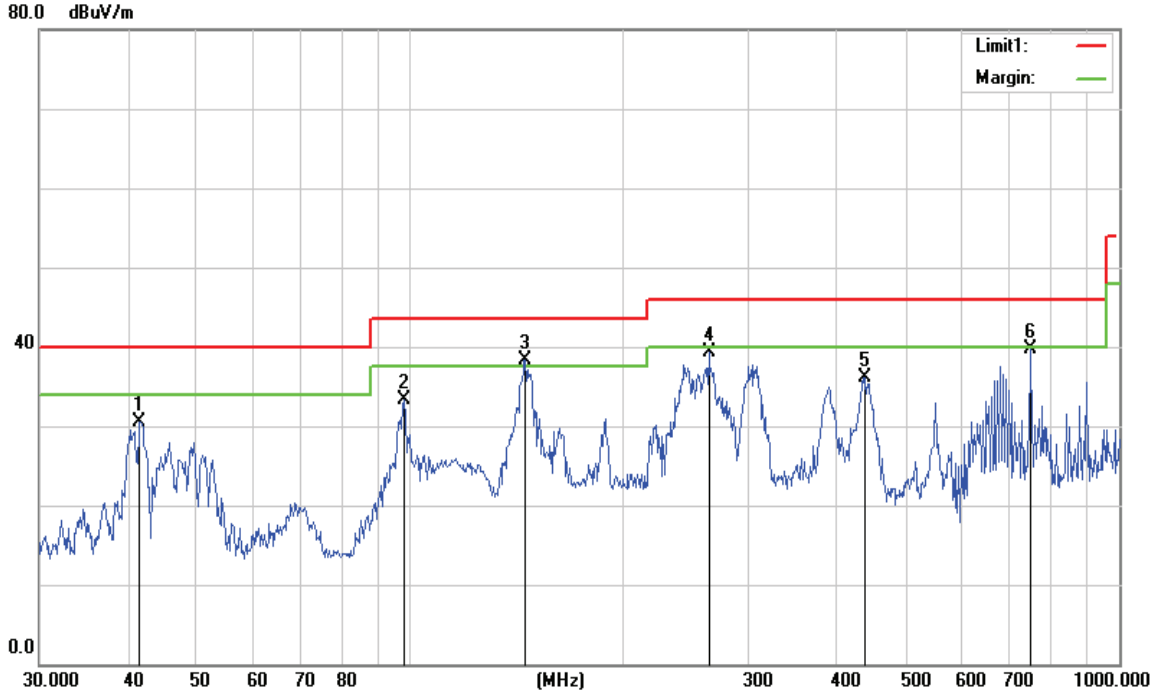



Temperature:	23.3°C	Relative Humidity:	49%
Test Voltage:	DC 12V	Polarization :	Vertical
Test Mode :	Mode 1/2/3/4/5/6/7/8/9 (Mode 2-1Mbps worst mode)		

Frequency (MHz)	Reading (dBUV)	Correct Factor(dB/m)	Result (dBUV/m)	Limit (dBUV/m)	Margin (dB)	Remark
40.7014	49.72	-16.69	33.03	40.00	-6.97	QP
97.4560	52.01	-19.44	32.57	43.50	-10.93	QP
187.7530	56.83	-20.07	36.76	43.50	-6.74	QP
251.1803	53.27	-16.18	37.09	46.00	-8.91	QP
502.9395	46.46	-8.89	37.57	46.00	-8.43	QP
1000.0000	34.52	-0.07	34.45	54.00	-19.55	QP

Remark:.

1. Margin = Result (Result =Reading + Factor)–Limit

80.0 dBUV/m

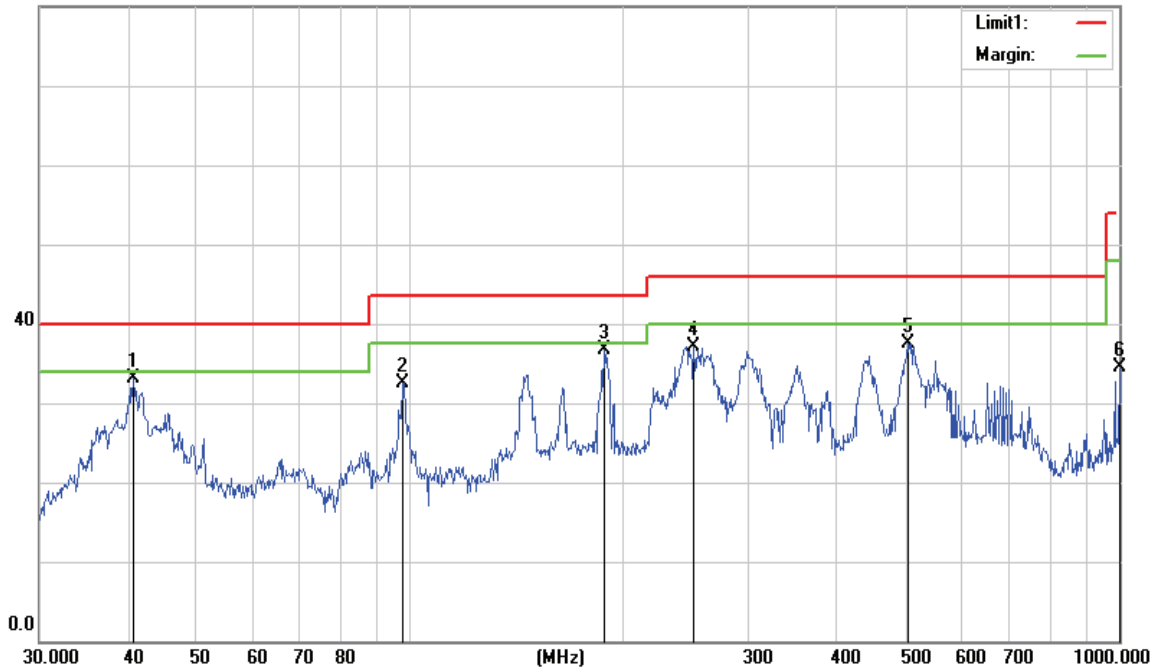



Restricted band and Spurious emission Requirements

(Above 1GHz)

802.11g Low Channel

Temperature:	25°C	Relative Humidity:	65%
Pressure:	1010hPa	Phase:	Horizontal

RSE_FCC Test Case_FCC 15C 1GHz-25GHz

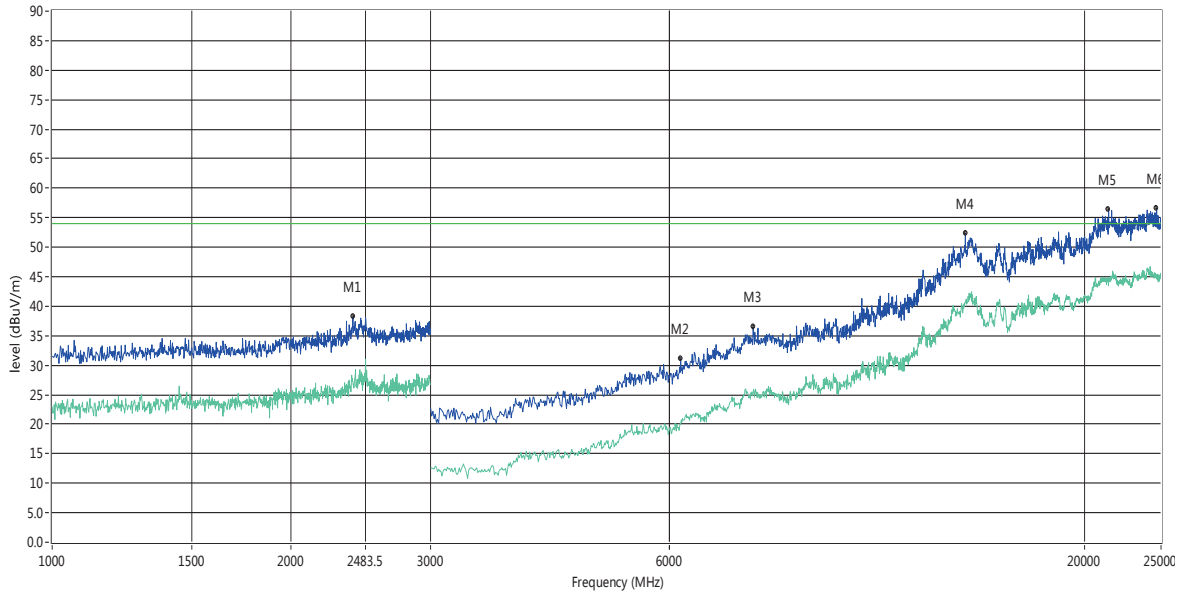

No.	Frequency (MHz)	Results (dBuV/m)	Factor (dB)	Limit (dBuV/m)	Over Limit (dB)	Detector	ANT	Verdict
1**	2394.000	27.14	0.75	54.0	-26.86	AV	H	Pass
1	2394.000	38.20	0.75	74.0	-35.80	Peak	H	Pass
2**	6200.000	20.02	4.81	54.0	-33.98	AV	H	Pass
2	6200.000	31.12	4.81	74.0	-42.88	Peak	H	Pass
3**	7650.000	25.42	10.36	54.0	-28.58	AV	H	Pass
3	7650.000	36.46	10.36	74.0	-37.54	Peak	H	Pass
4**	14164.000	40.70	23.82	54.0	-13.30	AV	H	Pass
4	14164.000	52.31	23.82	74.0	-21.69	Peak	H	Pass
5**	21472.000	44.07	24.02	54.0	-9.93	AV	H	Pass
5	21472.000	56.35	24.02	74.0	-17.65	Peak	H	Pass
6**	24688.001	45.20	23.08	54.0	-8.80	AV	H	Pass
6	24688.001	56.58	23.08	74.0	-17.42	Peak	H	Pass



Temperature:	25°C	Relative Humidity:	65%
Pressure:	1010hPa	Phase:	Vertical

RSE_FCC Test Case_FCC 15C 1GHz-25GHz

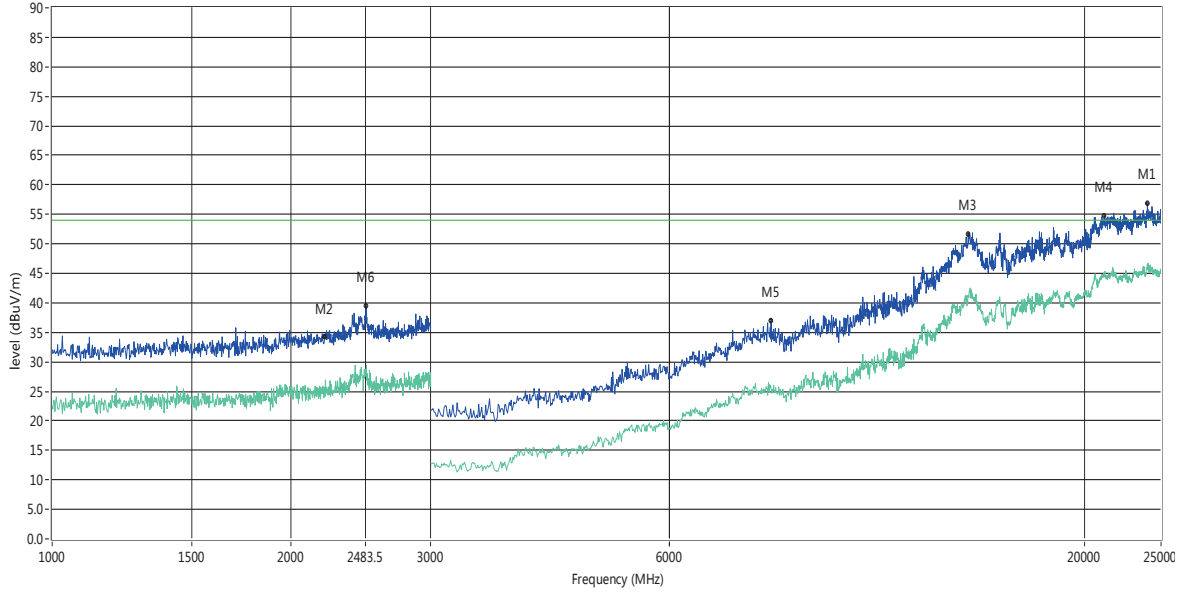

No.	Frequency (MHz)	Results (dBuV/m)	Factor (dB)	Limit (dBuV/m)	Over Limit (dB)	Detector	ANT	Verdict
1**	24028.000	46.53	23.30	54.0	-7.47	AV	V	Pass
1	24028.000	56.80	23.30	74.0	-17.20	Peak	V	Pass
2**	9030.000	26.28	11.51	54.0	-27.72	AV	V	Pass
2	9030.000	37.77	11.51	74.0	-36.23	Peak	V	Pass
3**	14320.000	41.96	24.92	54.0	-12.04	AV	V	Pass
3	14320.000	51.90	24.92	74.0	-22.10	Peak	V	Pass
4**	21220.000	44.75	24.08	54.0	-9.25	AV	V	Pass
4	21220.000	54.73	24.08	74.0	-19.27	Peak	V	Pass
5**	8060.000	25.51	10.20	54.0	-28.49	AV	V	Pass
5	8060.000	36.97	10.20	74.0	-37.03	Peak	V	Pass
6**	2488.000	27.66	1.54	54.0	-26.34	AV	V	Pass
6	2488.000	39.34	1.54	74.0	-34.66	Peak	V	Pass



802.11g Middle Channel

Temperature:	25°C	Relative Humidity:	65%
Pressure:	1010hPa	Phase:	Horizontal

RE_FCC Test Case_FCC 15B 1GHz-25GHz

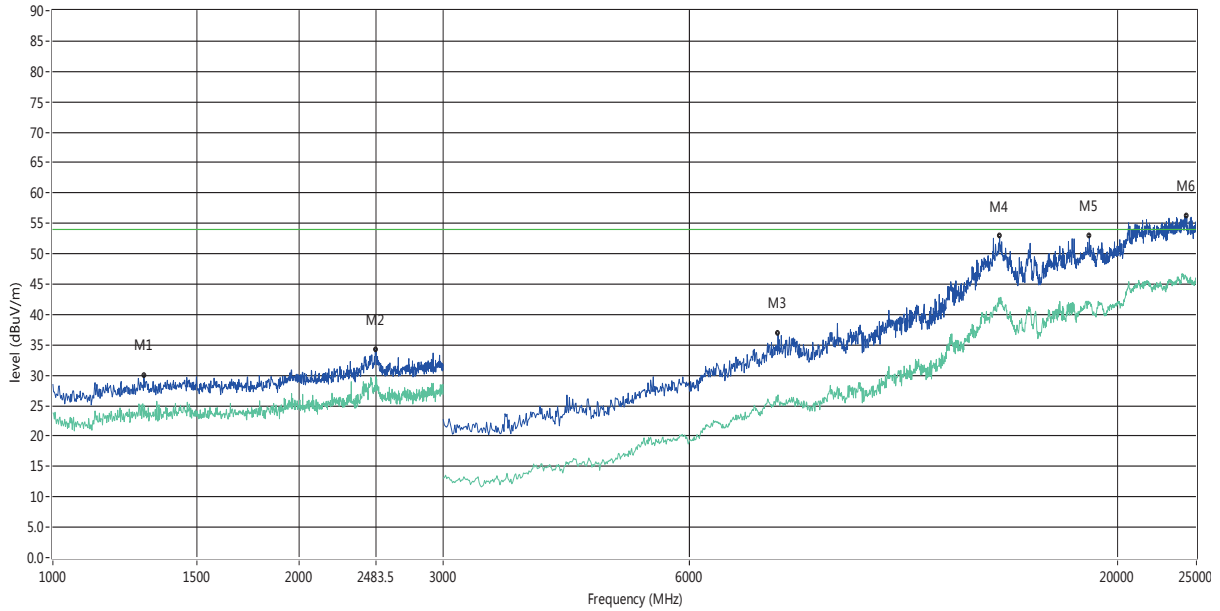

No.	Frequency (MHz)	Results (dBuV/m)	Factor (dB)	Limit (dBuV/m)	Over Limit (dB)	Detector	ANT	Verdict
1**	1292.000	23.09	-19.44	54.0	-30.91	AV	H	Pass
1	1292.000	29.90	-19.44	74.0	-44.10	Peak	H	Pass
2**	2484.000	29.67	-13.55	54.0	-24.33	AV	H	Pass
2	2484.000	34.21	-13.55	74.0	-39.79	Peak	H	Pass
3**	7700.000	26.79	10.88	54.0	-27.21	AV	H	Pass
3	7700.000	36.82	10.88	74.0	-37.18	Peak	H	Pass
4**	14368.000	42.70	24.92	54.0	-11.30	AV	H	Pass
4	14368.000	52.84	24.92	74.0	-21.16	Peak	H	Pass
5**	18496.000	41.96	22.62	54.0	-12.04	AV	H	Pass
5	18496.000	52.93	22.62	74.0	-21.07	Peak	H	Pass
6**	24327.999	46.18	23.20	54.0	-7.82	AV	H	Pass
6	24327.999	56.20	23.20	74.0	-17.80	Peak	H	Pass



Temperature:	25°C	Relative Humidity:	65%
Pressure:	1010hPa	Phase:	Vertical

RE_FCC Test Case_FCC 15B 1GHz-25GHz

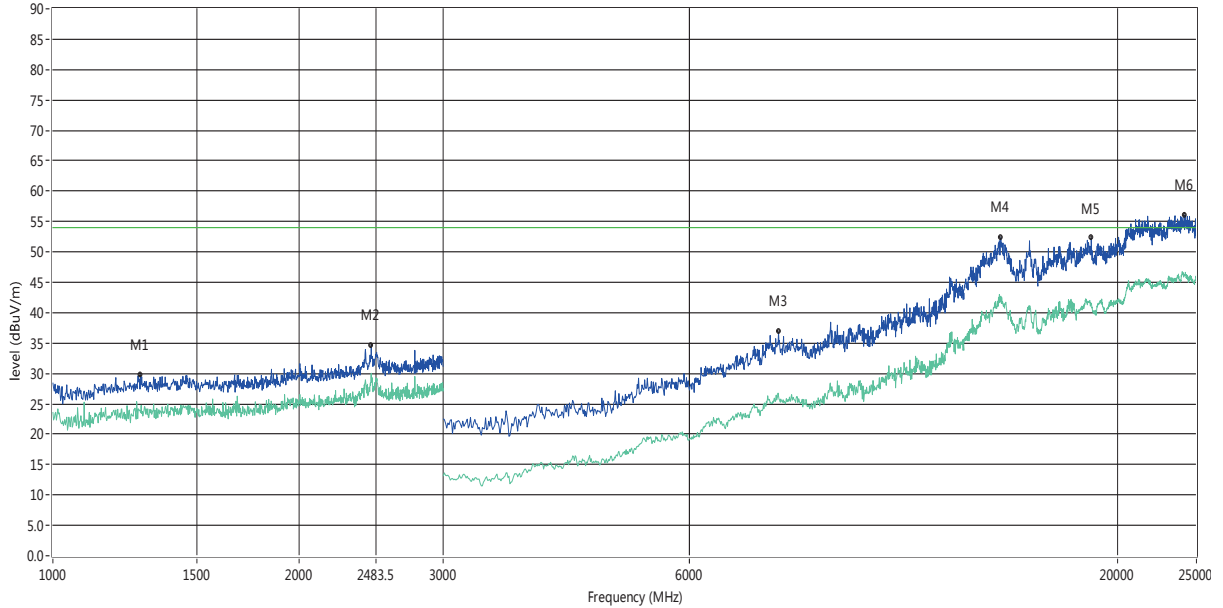

No.	Frequency (MHz)	Results (dBuV/m)	Factor (dB)	Limit (dBuV/m)	Over Limit (dB)	Detector	ANT	Verdict
1**	1280.000	23.53	-19.45	54.0	-30.47	AV	V	Pass
1	1280.000	29.79	-19.45	74.0	-44.21	Peak	V	Pass
2**	2450.000	30.04	-13.79	54.0	-23.96	AV	V	Pass
2	2450.000	34.66	-13.79	74.0	-39.34	Peak	V	Pass
3**	7710.000	26.31	10.52	54.0	-27.69	AV	V	Pass
3	7710.000	36.83	10.52	74.0	-37.17	Peak	V	Pass
4**	14416.000	42.72	25.52	54.0	-11.28	AV	V	Pass
4	14416.000	52.33	25.52	74.0	-21.67	Peak	V	Pass
5**	18592.000	41.51	22.14	54.0	-12.49	AV	V	Pass
5	18592.000	52.26	22.14	74.0	-21.74	Peak	V	Pass
6**	24207.999	46.19	23.24	54.0	-7.81	AV	V	Pass
6	24207.999	56.08	23.24	74.0	-17.92	Peak	V	Pass



802.11g High Channel

Temperature:	25°C	Relative Humidity:	65%
Pressure:	1010hPa	Phase:	Horizontal

RSE_FCC Test Case_FCC 15C 1GHz-25GHz

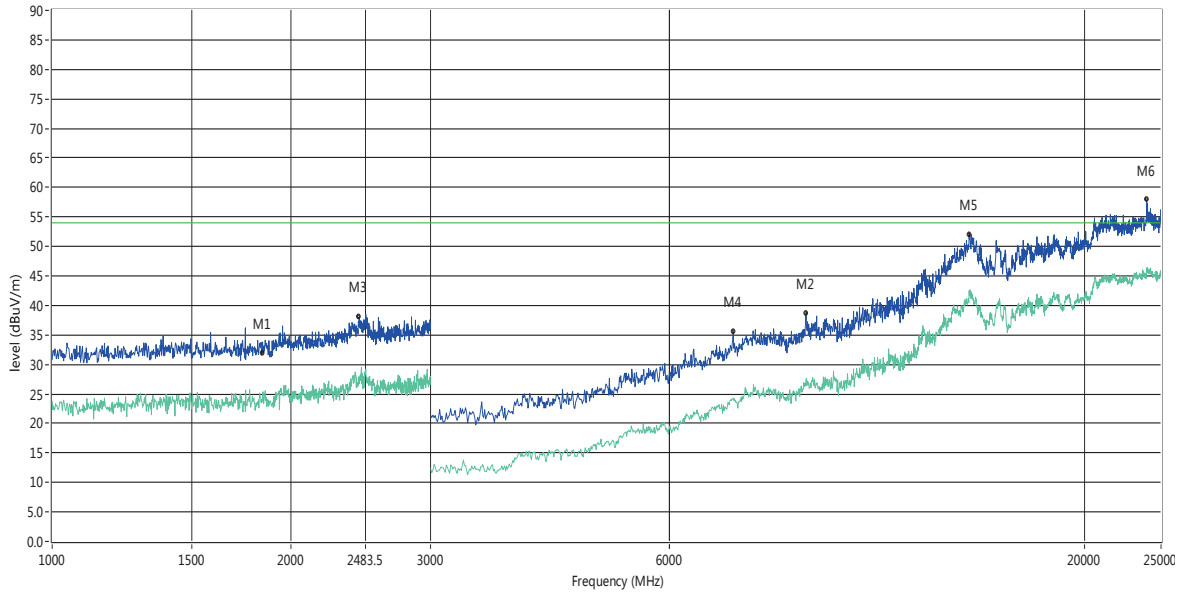

No.	Frequency (MHz)	Results (dBuV/m)	Factor (dB)	Limit (dBuV/m)	Over Limit (dB)	Detector	ANT	Verdict
1**	7220.000	24.30	8.82	54.0	-29.70	AV	H	Pass
1	7220.000	35.49	8.82	74.0	-38.51	Peak	H	Pass
2**	8920.001	27.47	12.66	54.0	-26.53	AV	H	Pass
2	8920.001	38.60	12.66	74.0	-35.40	Peak	H	Pass
3**	2438.000	27.64	1.13	54.0	-26.36	AV	H	Pass
3	2438.000	38.06	1.13	74.0	-35.94	Peak	H	Pass
4**	7220.000	24.30	8.82	54.0	-29.70	AV	H	Pass
4	7220.000	35.49	8.82	74.0	-38.51	Peak	H	Pass
5**	14320.000	42.50	24.92	54.0	-11.50	AV	H	Pass
5	14320.000	51.96	24.92	74.0	-22.04	Peak	H	Pass
6**	23979.999	45.75	23.31	54.0	-8.25	AV	H	Pass
6	23979.999	57.86	23.31	74.0	-16.14	Peak	H	Pass



Temperature:	25°C	Relative Humidity:	65%
Pressure:	1010hPa	Phase:	Vertical

RSE_FCC Test Case_FCC 15C 1GHz-25GHz

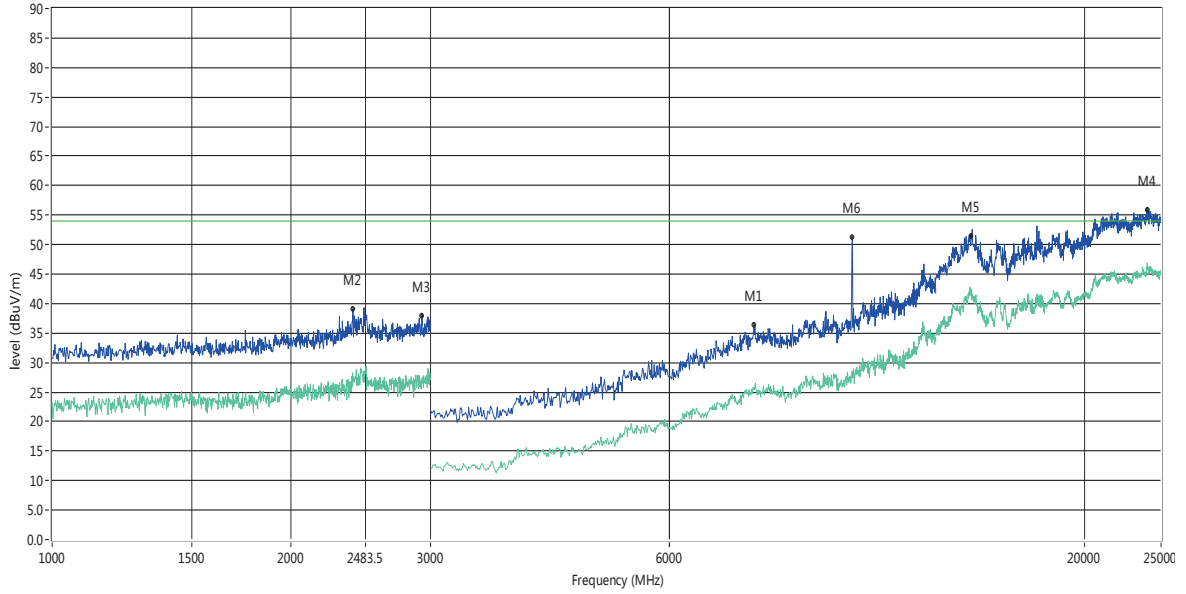

No.	Frequency (MHz)	Results (dBuV/m)	Factor (dB)	Limit (dBuV/m)	Over Limit (dB)	Detector	ANT	Verdict
1**	7670.000	25.61	10.29	54.0	-28.39	AV	V	Pass
1	7670.000	36.22	10.29	74.0	-37.78	Peak	V	Pass
2**	2394.000	26.76	0.75	54.0	-27.24	AV	V	Pass
2	2394.000	39.04	0.75	74.0	-34.96	Peak	V	Pass
3**	2926.000	26.48	1.67	54.0	-27.52	AV	V	Pass
3	2926.000	37.95	1.67	74.0	-36.05	Peak	V	Pass
4**	24039.999	46.36	23.29	54.0	-7.64	AV	V	Pass
4	24039.999	55.90	23.29	74.0	-18.10	Peak	V	Pass
5**	14452.000	41.75	24.56	54.0	-12.25	AV	V	Pass
5	14452.000	52.57	24.56	74.0	-21.43	Peak	V	Pass
6**	10200.001	28.24	12.33	54.0	-25.76	AV	V	Pass
6	10200.001	51.17	12.33	74.0	-22.83	Peak	V	Pass

Note: 802.11b, 802.11g, 802.11n (HT-20) mode all have been tested, the worst case is 802.11g, only show the worst case.



3.3.7 TEST RESULTS (RESTRICTED BAND)

802.11b-Low

Horizontal

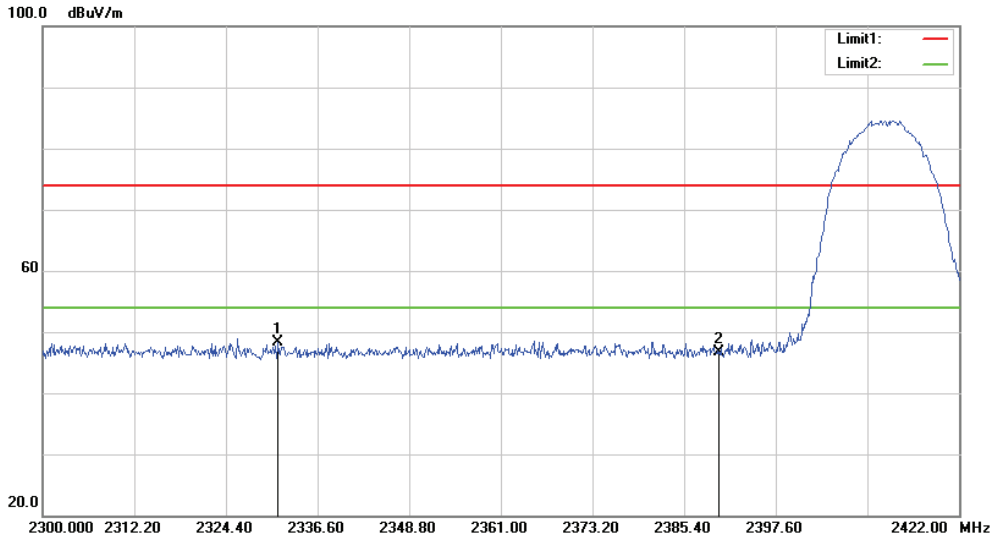

No.	Frequency (MHz)	Reading (dBuV)	Correct Factor(dB/m)	Result (dBuV/m)	Limit (dBuV/m)	Margin (dB)	Remark
1	2331.354	56.08	-7.79	48.29	74.00	-25.71	peak
2	2390.000	54.31	-7.54	46.77	74.00	-27.23	peak

Vertical

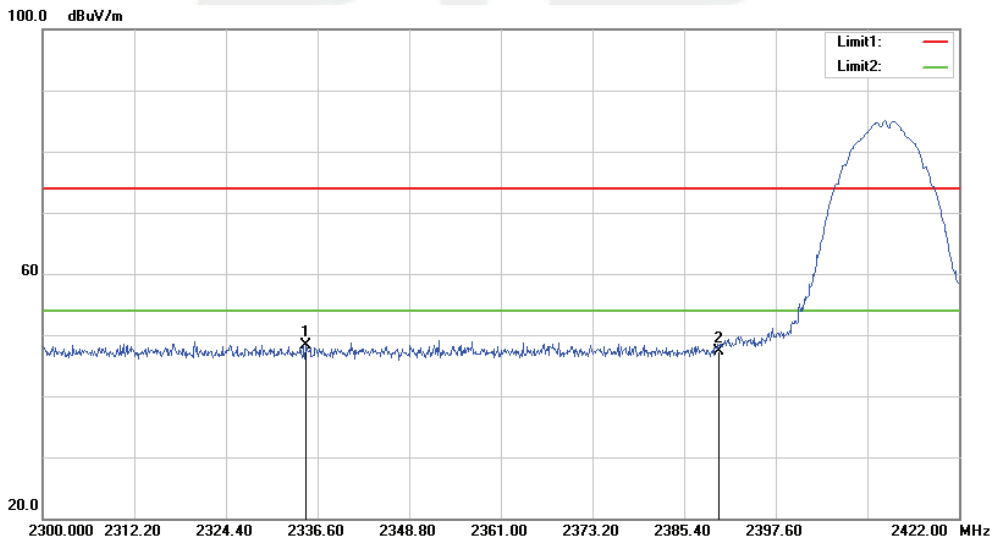

No.	Frequency (MHz)	Reading (dBuV)	Correct Factor(dB/m)	Result (dBuV/m)	Limit (dBuV/m)	Margin (dB)	Remark
1	2335.014	56.44	-8.04	48.40	74.00	-25.60	peak
2	2390.000	55.19	-7.81	47.38	74.00	-26.62	peak



802.11b-High Horizontal

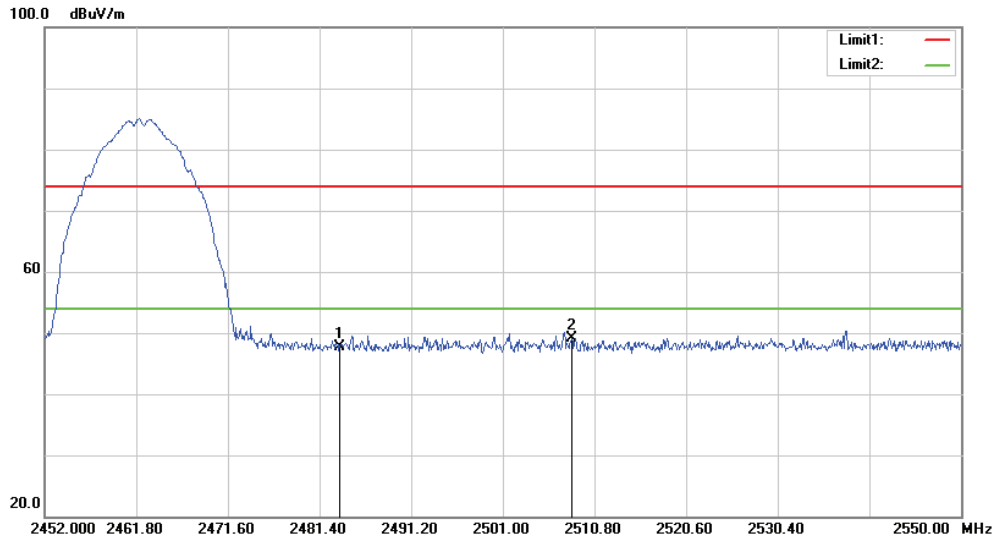

No.	Frequency (MHz)	Reading (dBuV)	Correct Factor(dB/m)	Result (dBuV/m)	Limit (dBuV/m)	Margin (dB)	Remark
1	2483.500	54.93	-7.13	47.80	74.00	-26.20	peak
2	2508.350	56.10	-7.04	49.06	74.00	-24.94	peak

Vertical

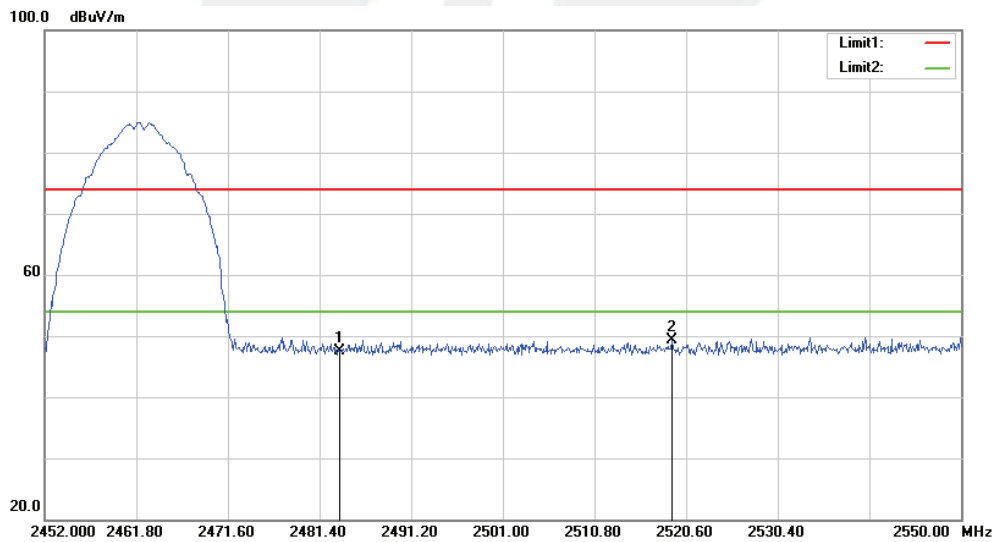

No.	Frequency (MHz)	Reading (dBuV)	Correct Factor(dB/m)	Result (dBuV/m)	Limit (dBuV/m)	Margin (dB)	Remark
1	2483.500	54.91	-7.43	47.48	74.00	-26.52	peak
2	2519.032	56.71	-7.32	49.39	74.00	-24.61	peak



802.11g-Low
Horizontal

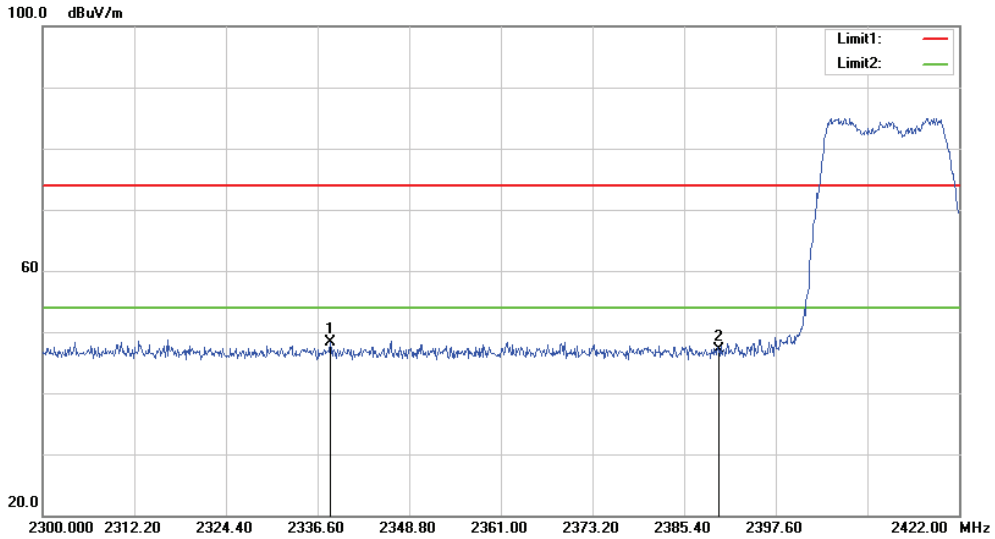

No.	Frequency (MHz)	Reading (dBuV)	Correct Factor(dB/m)	Result (dBuV/m)	Limit (dBuV/m)	Margin (dB)	Remark
1	2338.308	56.12	-7.76	48.36	74.00	-25.64	peak
2	2390.000	54.72	-7.54	47.18	74.00	-26.82	peak

Vertical

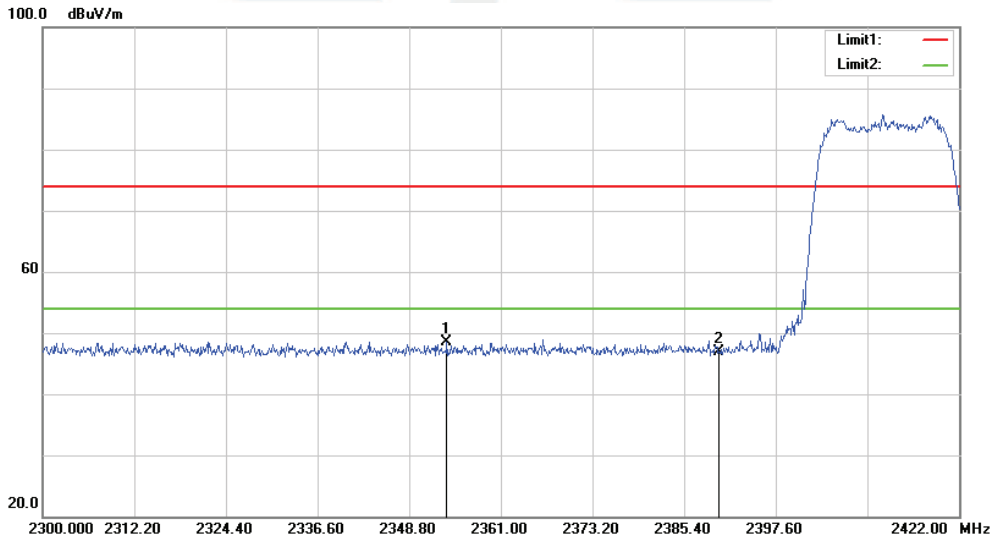

No.	Frequency (MHz)	Reading (dBuV)	Correct Factor(dB/m)	Result (dBuV/m)	Limit (dBuV/m)	Margin (dB)	Remark
1	2353.802	56.43	-7.97	48.46	74.00	-25.54	peak
2	2390.000	54.79	-7.81	46.98	74.00	-27.02	peak



802.11g-High

Horizontal

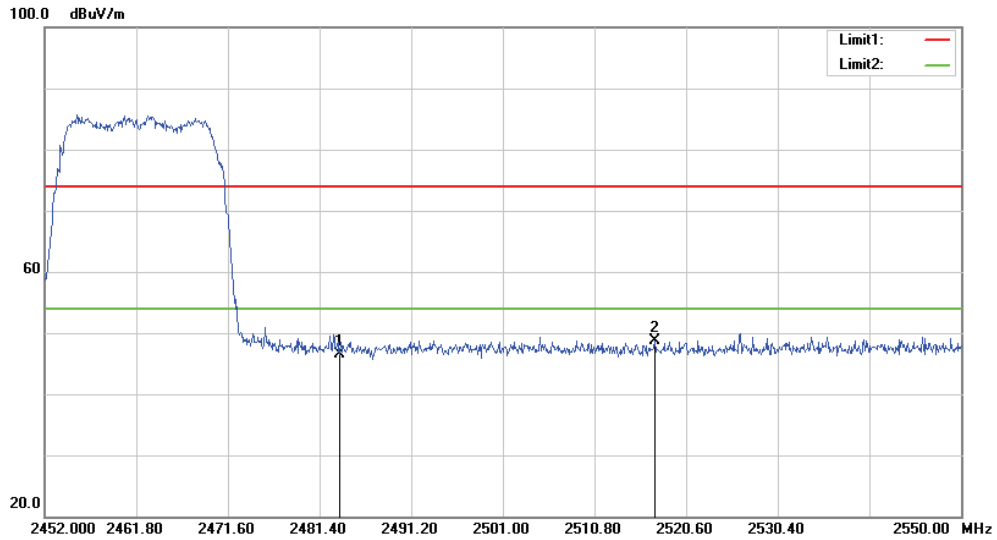

No.	Frequency (MHz)	Reading (dBuV)	Correct Factor(dB/m)	Result (dBuV/m)	Limit (dBuV/m)	Margin (dB)	Remark
1	2483.500	53.62	-7.13	46.49	74.00	-27.51	peak
2	2517.268	55.78	-7.02	48.76	74.00	-25.24	peak

Vertical

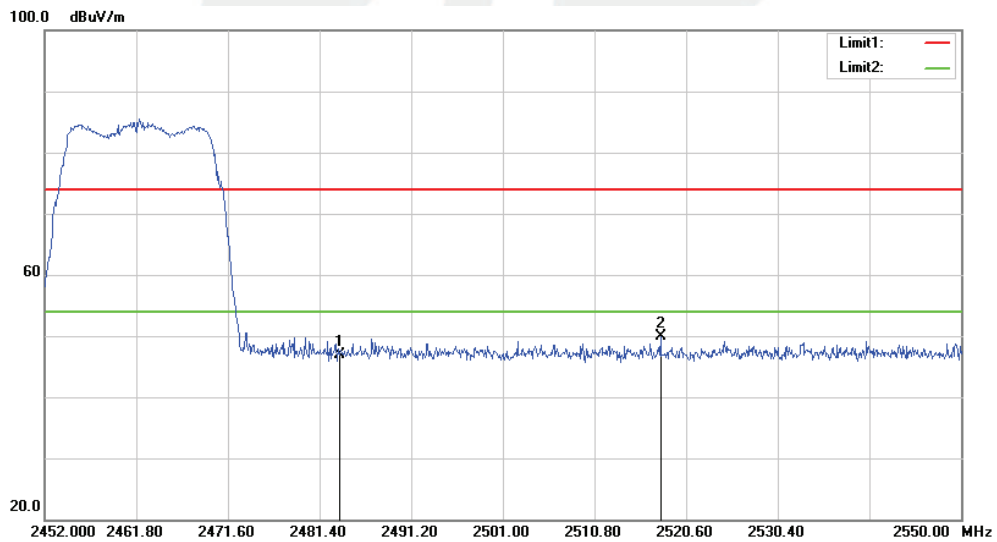

No.	Frequency (MHz)	Reading (dBuV)	Correct Factor(dB/m)	Result (dBuV/m)	Limit (dBuV/m)	Margin (dB)	Remark
1	2483.500	54.29	-7.43	46.86	74.00	-27.14	peak
2	2517.856	57.27	-7.32	49.95	74.00	-24.05	peak



802.11HT(20)-Low
Horizontal

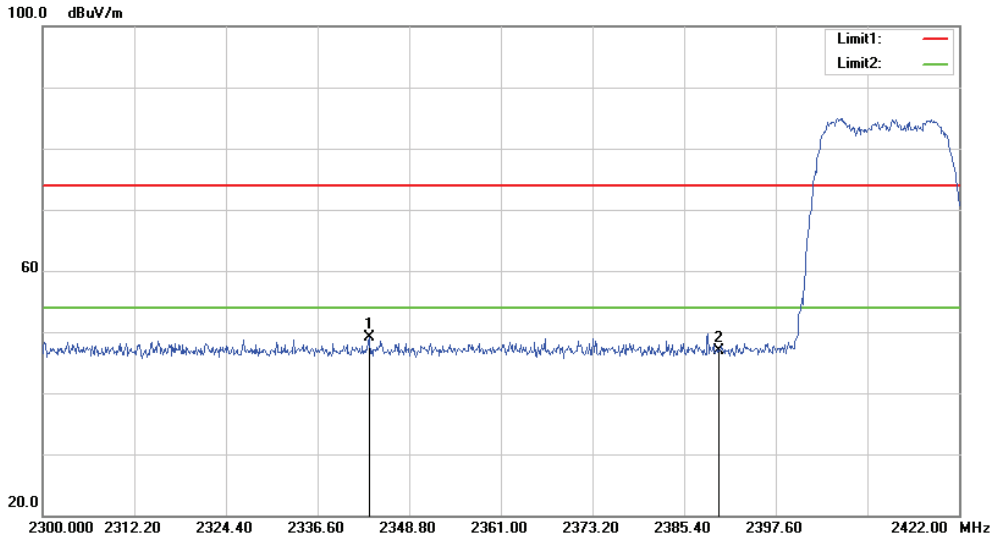

No.	Frequency (MHz)	Reading (dBuV)	Correct Factor(dB/m)	Result (dBuV/m)	Limit (dBuV/m)	Margin (dB)	Remark
1	2343.432	56.83	-7.73	49.10	74.00	-24.90	peak
2	2390.000	54.43	-7.54	46.89	74.00	-27.11	peak

Vertical

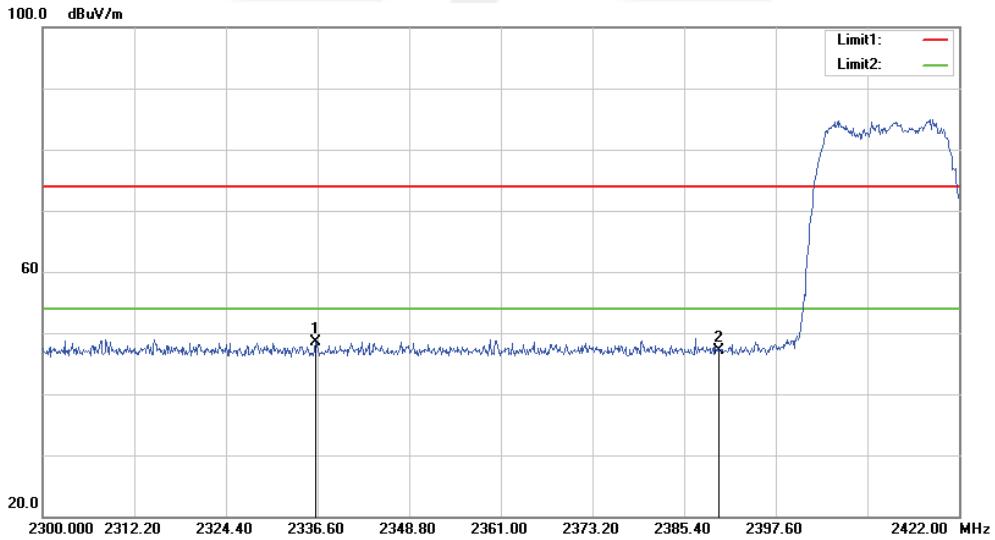

No.	Frequency (MHz)	Reading (dBuV)	Correct Factor(dB/m)	Result (dBuV/m)	Limit (dBuV/m)	Margin (dB)	Remark
1	2336.356	56.49	-8.04	48.45	74.00	-25.55	peak
2	2390.000	54.99	-7.81	47.18	74.00	-26.82	peak



802.11HT(20)-High

Horizontal

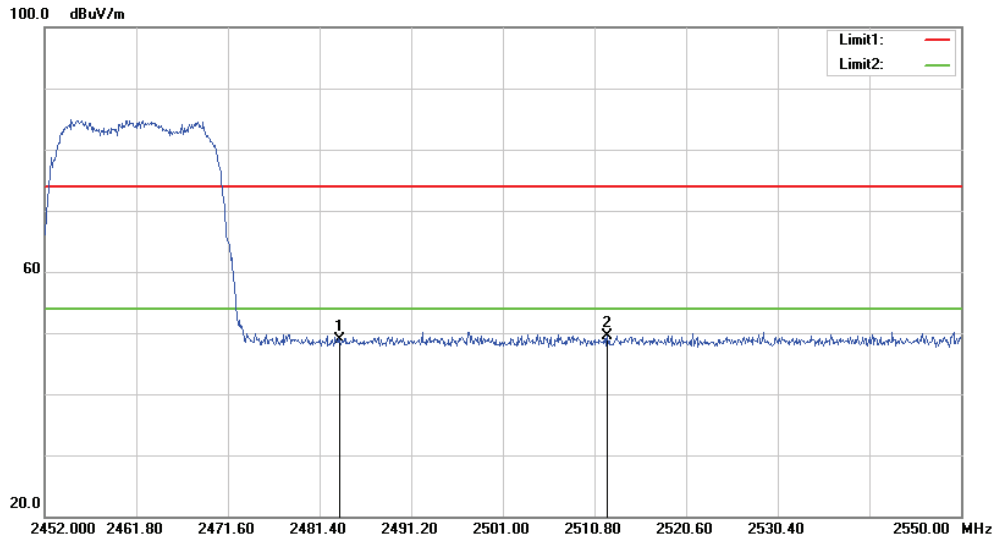

No.	Frequency (MHz)	Reading (dBuV)	Correct Factor(dB/m)	Result (dBuV/m)	Limit (dBuV/m)	Margin (dB)	Remark
1	2483.500	56.00	-7.13	48.87	74.00	-25.13	peak
2	2512.172	56.58	-7.03	49.55	74.00	-24.45	peak

Vertical

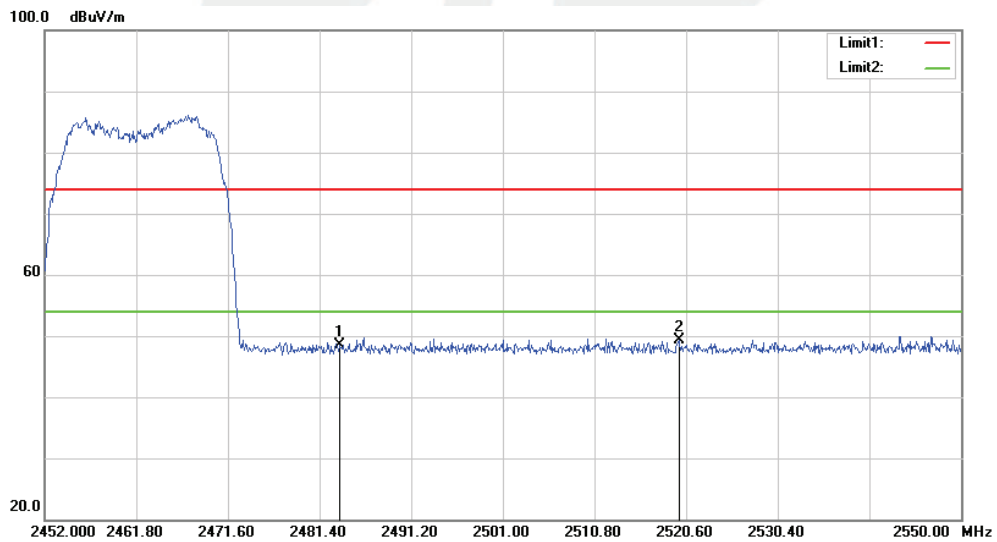

No.	Frequency (MHz)	Reading (dBuV)	Correct Factor(dB/m)	Result (dBuV/m)	Limit (dBuV/m)	Margin (dB)	Remark
1	2483.500	55.84	-7.43	48.41	74.00	-25.59	peak
2	2519.816	56.56	-7.32	49.24	74.00	-24.76	peak

4 CONDUCTED SPURIOUS & BAND EDGE EMISSION

4.1 APPLIED PROCEDURES / LIMIT

According to FCC Part 15.247(d) and RSS-247 Clause 5.5, in any 100kHz bandwidth outside the frequency band in which the spread spectrum or digitally modulated intentional radiator is operating, the radio frequency power that is produced by the intentional radiator shall be at least 20dB below that in the 100kHz bandwidth within the band that contains the highest level of the desired power, based on either an RF conducted or a radiated measurement.

4.2 TEST PROCEDURE

Spectrum Parameter	Setting
Detector	Peak
Start/Stop Frequency	30 MHz to 10th carrier harmonic
RB / VB (emission in restricted band)	100 KHz/300 KHz
Trace-Mode:	Max hold

For Band edge

Spectrum Parameter	Setting
Detector	Peak
Start/Stop Frequency	Lower Band Edge: 2300 to 2422 MHz Upper Band Edge: 2452 to 2500 MHz
RB / VB (emission in restricted band)	100 KHz/300 KHz
Trace-Mode:	Max hold

4.3 DEVIATION FROM STANDARD

No deviation.

4.4 TEST SETUP

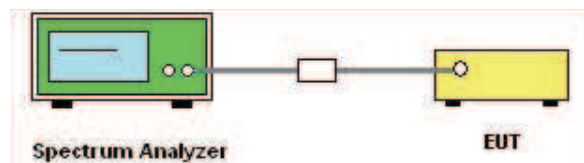

The EUT which is powered by the Battery, is coupled to the Spectrum Analyzer; the RF load attached to the EUT antenna terminal is 50 Ohm; the path loss as the factor is calibrated to correct the reading.

Make the measurement with the spectrum analyzer's resolution bandwidth (RBW) = 100 kHz. In order to make an accurate measurement, set the span greater than RBW.

4.5 EUT OPERATION CONDITIONS

The EUT tested system was configured as the statements of 2.3 Unless otherwise a special operating condition is specified in the follows during the testing.



4.6 TEST RESULTS

Temperature :	25°C	Relative Humidity :	60%
Test Voltage :	DC 12V	Test Mode :	TX b Mode /CH01, CH06, CH11

CH 01

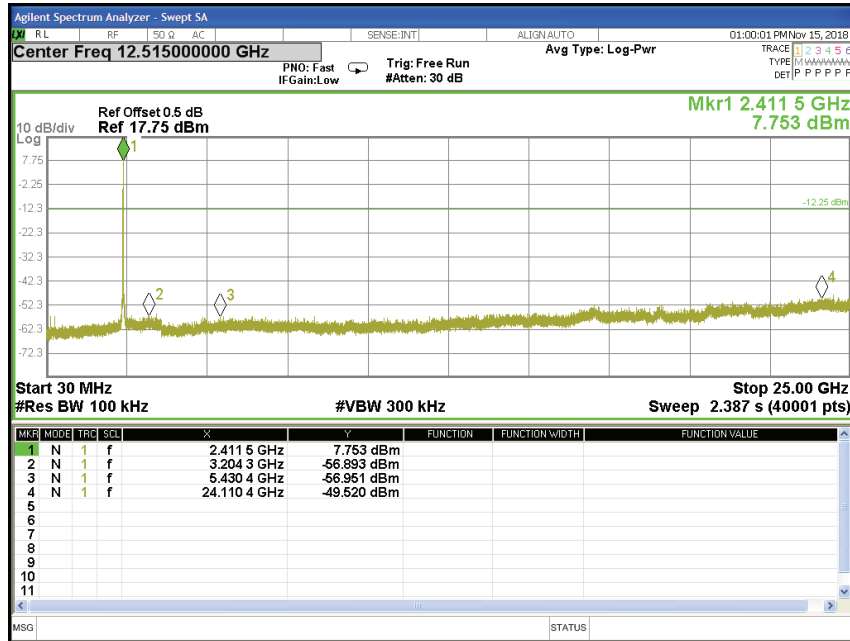

CH 06

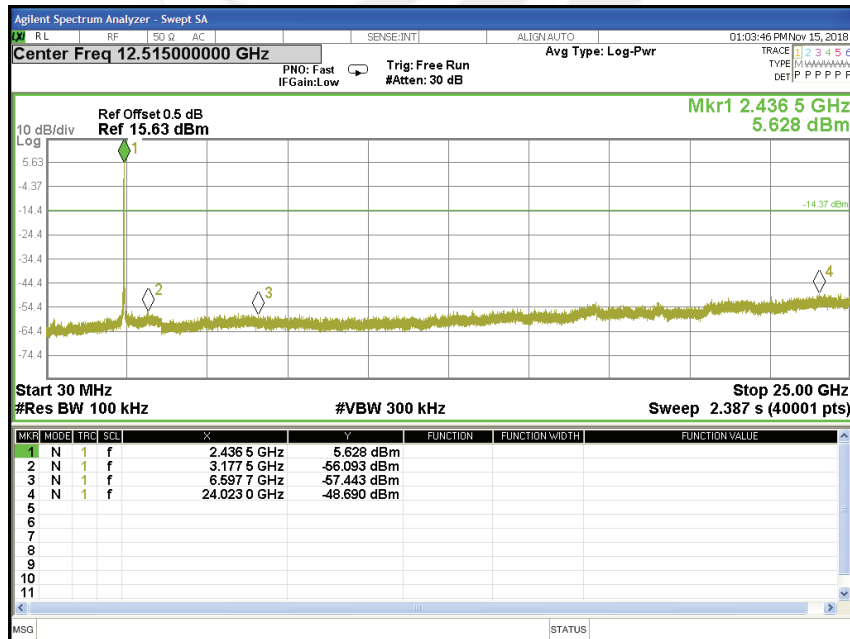



CH 11

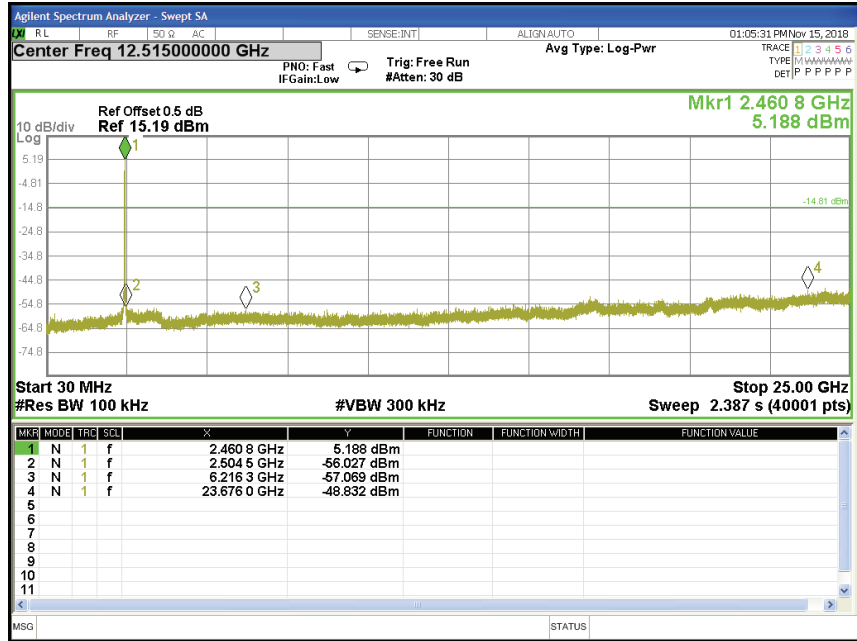



Band edge

CH 01

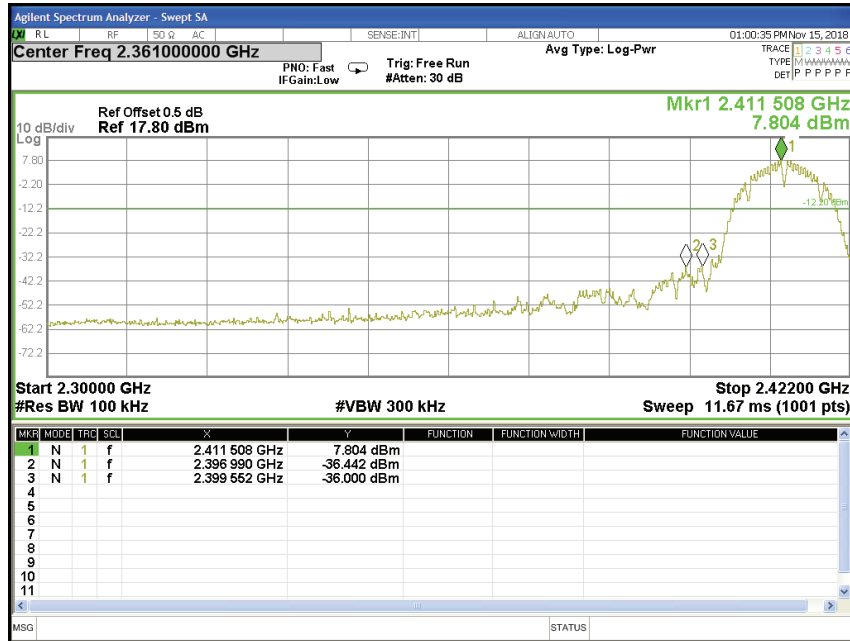

CH 11

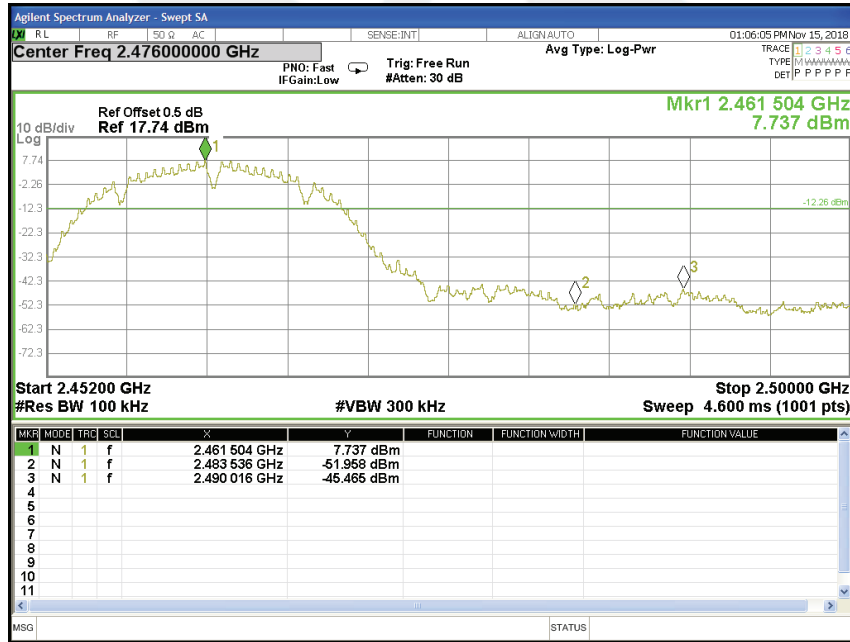



Temperature :	25°C	Relative Humidity :	60%
Test Voltage :	DC 12V	Test Mode :	TX g Mode /CH01, CH06, CH11

CH 01

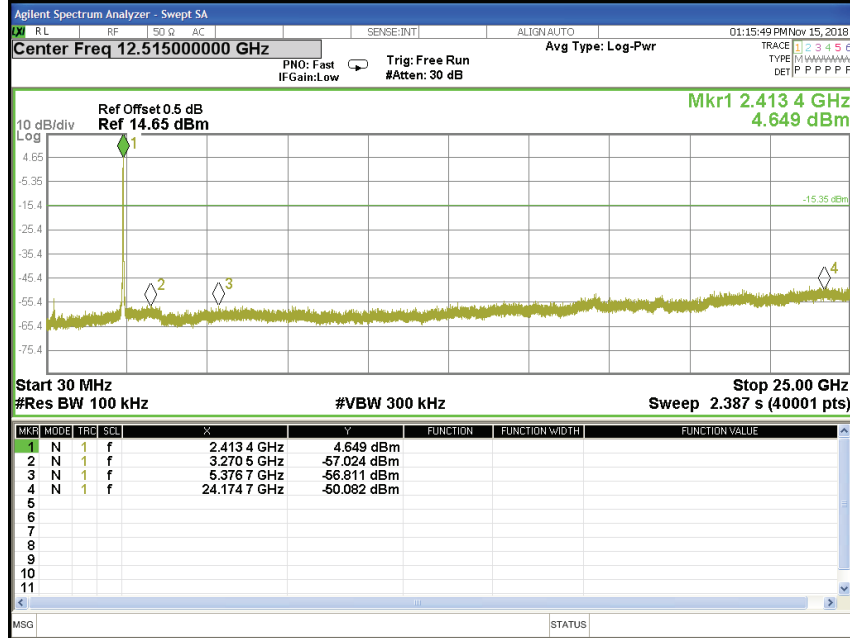

CH06

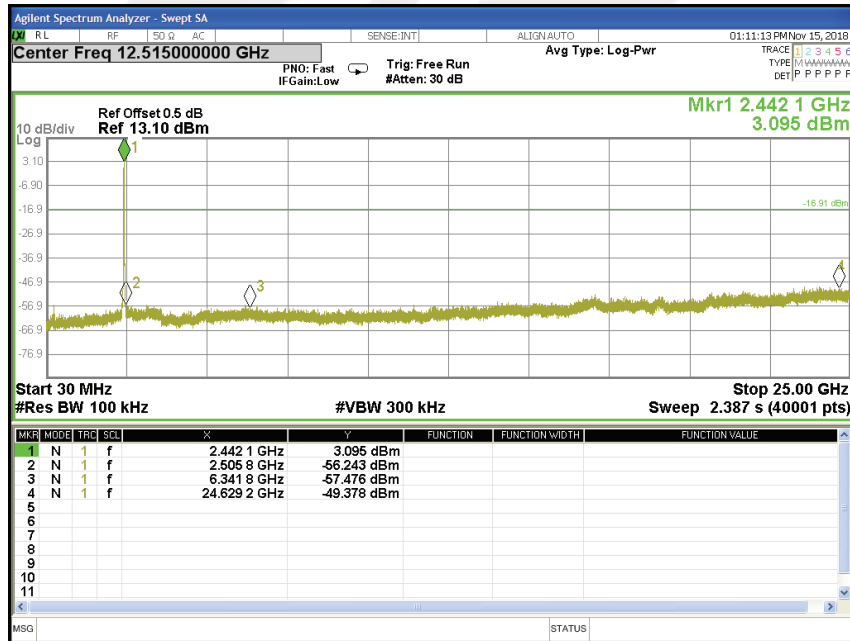



CH 11

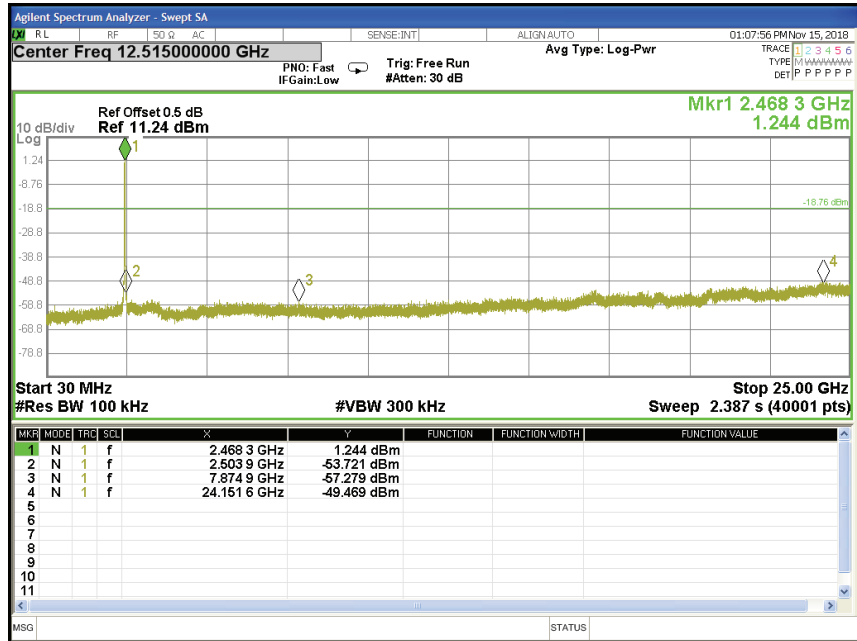



Band edge

CH 01

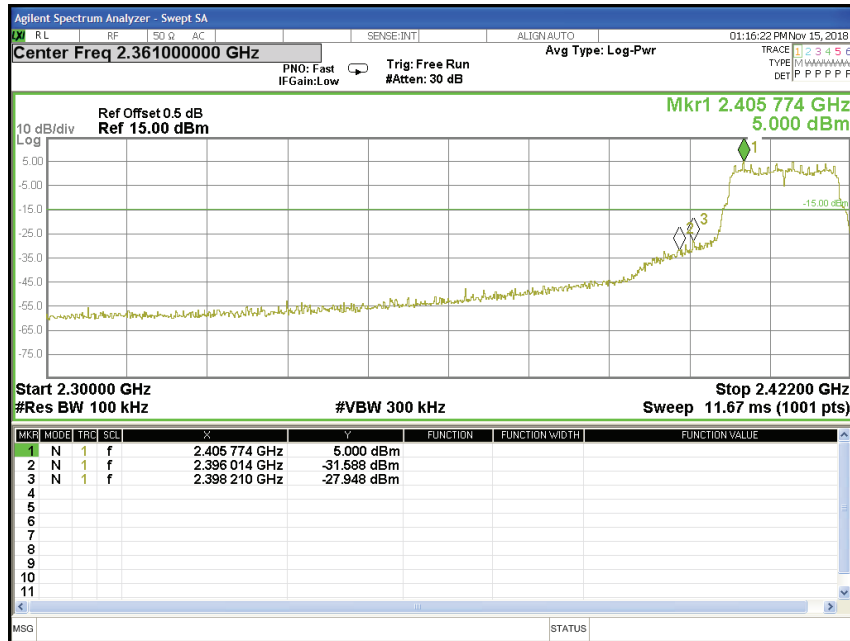

CH11

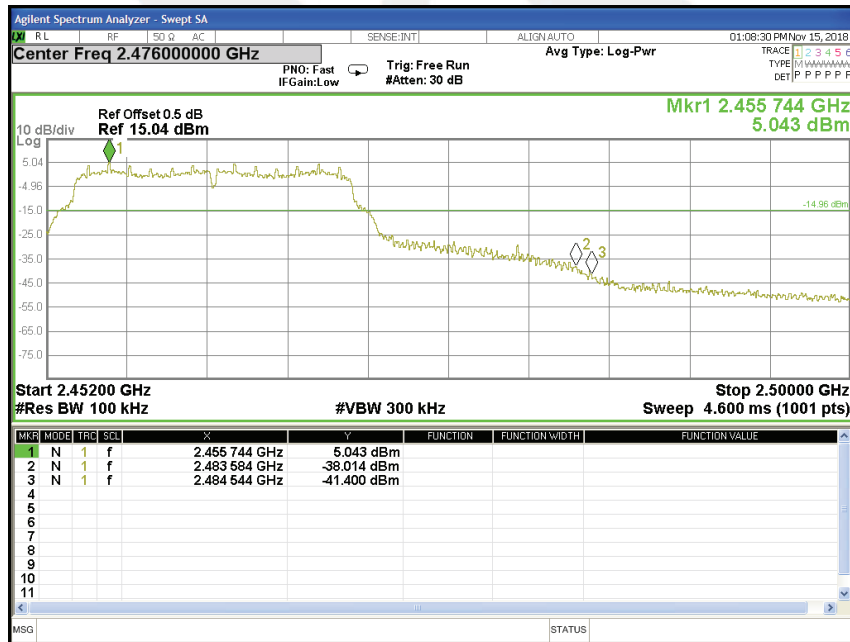



Temperature :	25°C	Relative Humidity :	60%
Test Voltage :	DC 12V	Test Mode :	TX n Mode(20M) /CH01, CH06, CH11

CH 01

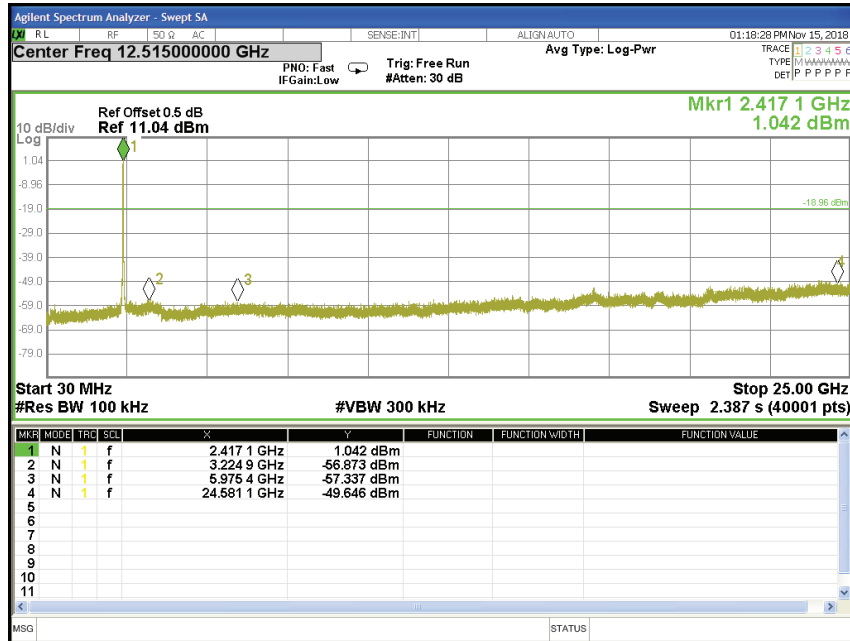

CH 06

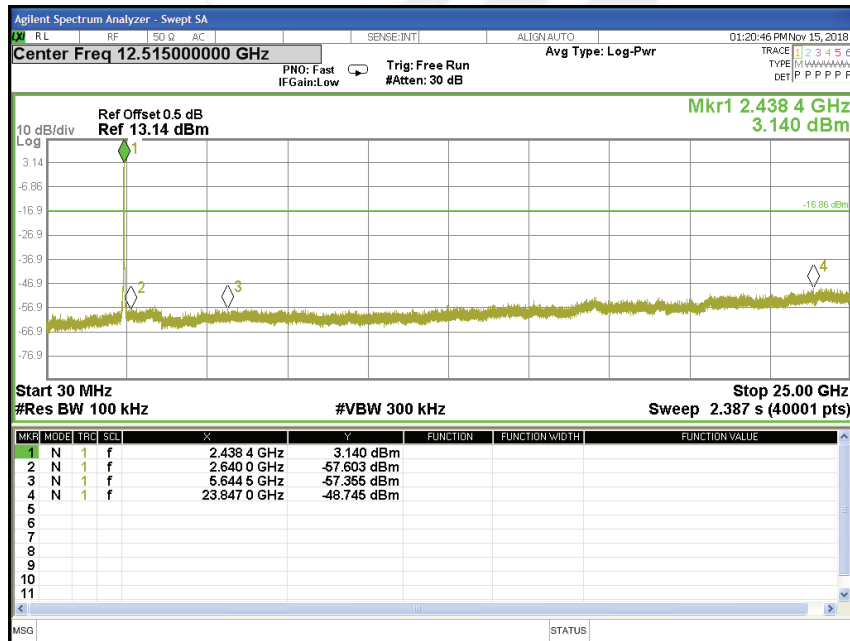



CH 11

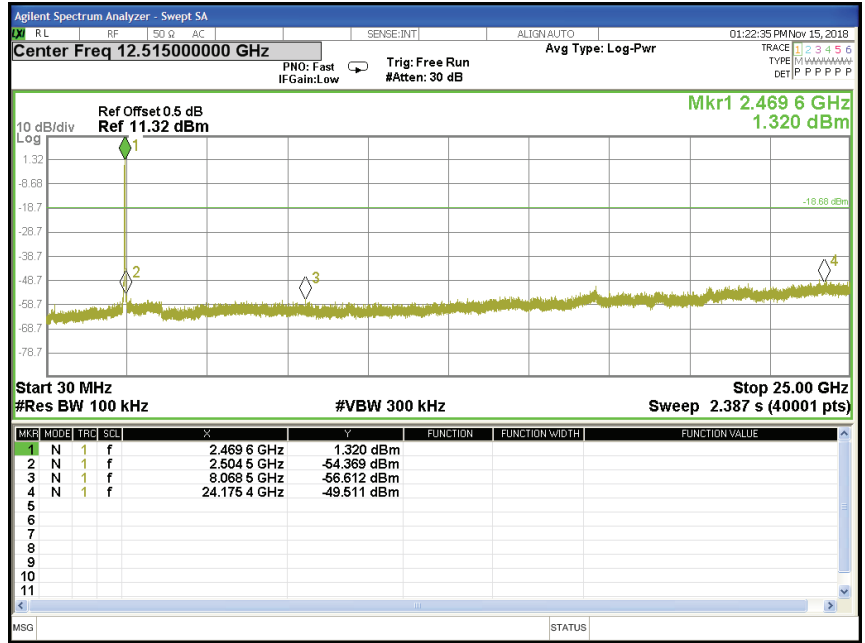



Band edge

CH 01

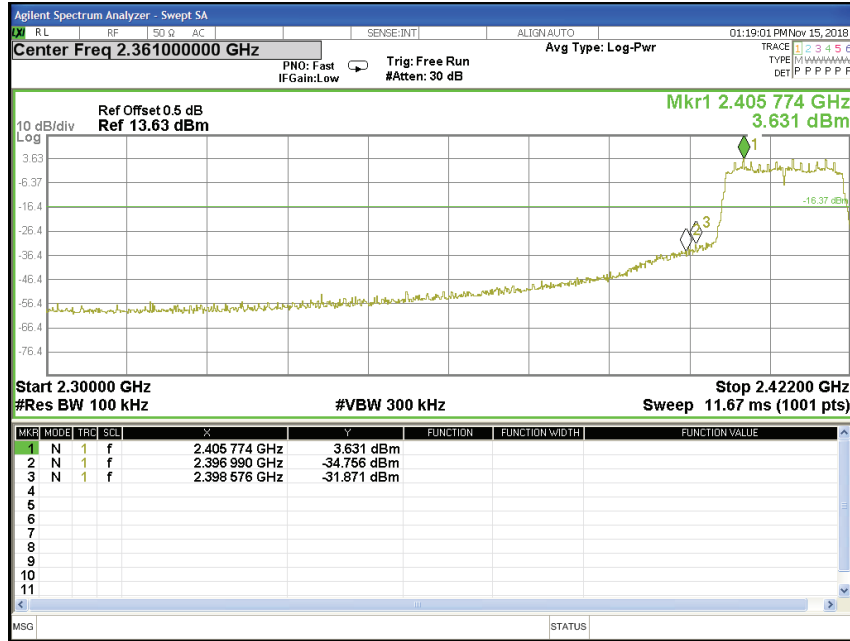

CH 11

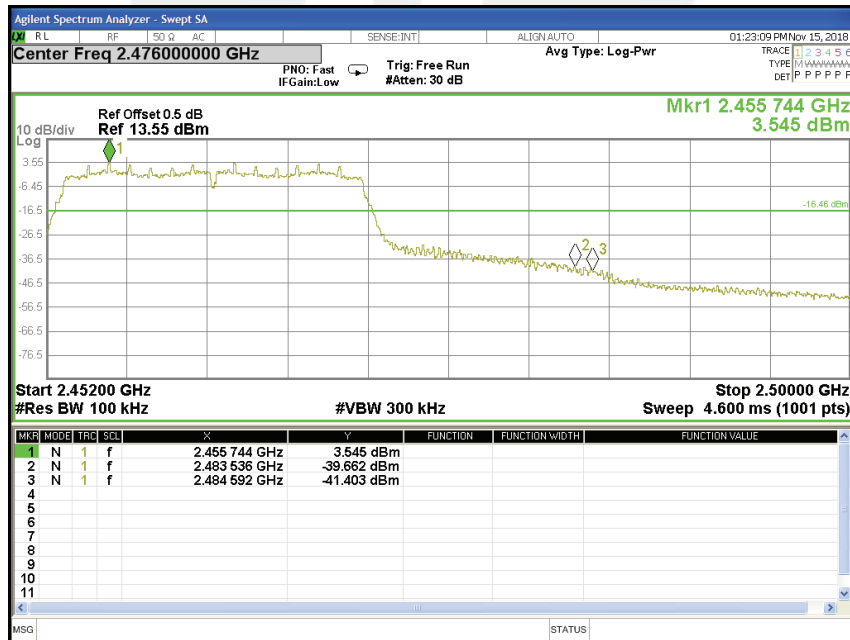



5 POWER SPECTRAL DENSITY TEST

5.1 APPLIED PROCEDURES / LIMIT

FCC Part15.247,Subpart C RSS-247 Issue 2				
Section	Test Item	Limit	Frequency Range (MHz)	Result
15.247(e) RSS-247 Clause 5.2(b)	Power Spectral Density	≤8 dBm (RBW ≥3KHz)	2400-2483.5	PASS

5.2 TEST PROCEDURE

- 1) Set analyzer center frequency to DTS channel center frequency.
- 2) Set the span to 1.5 times the DTS channel bandwidth.
- 3) Set the 100 kHz ≥ RBW ≥ 3 kHz.
- 4) Set the VBW ≥ 3 x RBW.
- 5) Detector = peak.
- 6) Sweep time = auto couple.
- 7) Trace mode = max hold.
- 8) Allow trace to fully stabilize.
- 9) Use the peak marker function to determine the maximum amplitude level.
- 10) If measured value exceeds limit, reduce RBW (no less than 3 kHz) and repeat.

5.3 DEVIATION FROM STANDARD

No deviation.

5.4 TEST SETUP



5.5 EUT OPERATION CONDITIONS

The EUT tested system was configured as the statements of 2.3 Unless otherwise a special operating condition is specified in the follows during the testing.



5.6 TEST RESULTS

Temperature:	25°C	Relative Humidity:	60%
Test Voltage:	DC 12V	Test Mode:	TX b Mode /CH01, CH06, CH11

Test Mode	Frequency (MHz)	Power Density (dBm/3kHz)	Limit (dBm/3KHz)	Result
b mode (1 Mbps)	2412.00	-5.832	≤ 8.00	PASS
	2437.00	-6.905	≤ 8.00	PASS
	2462.00	-4.113	≤ 8.00	PASS

TX CH01

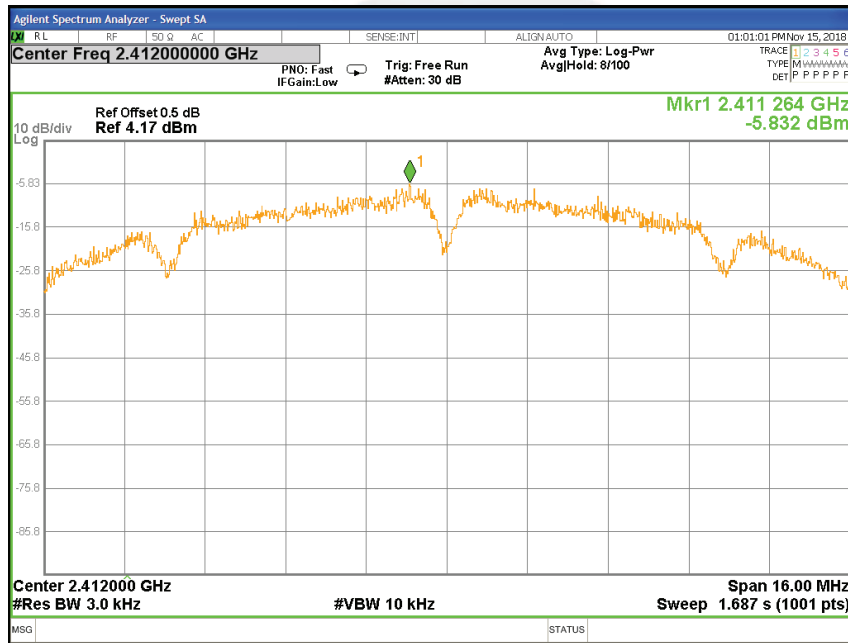



TX CH06

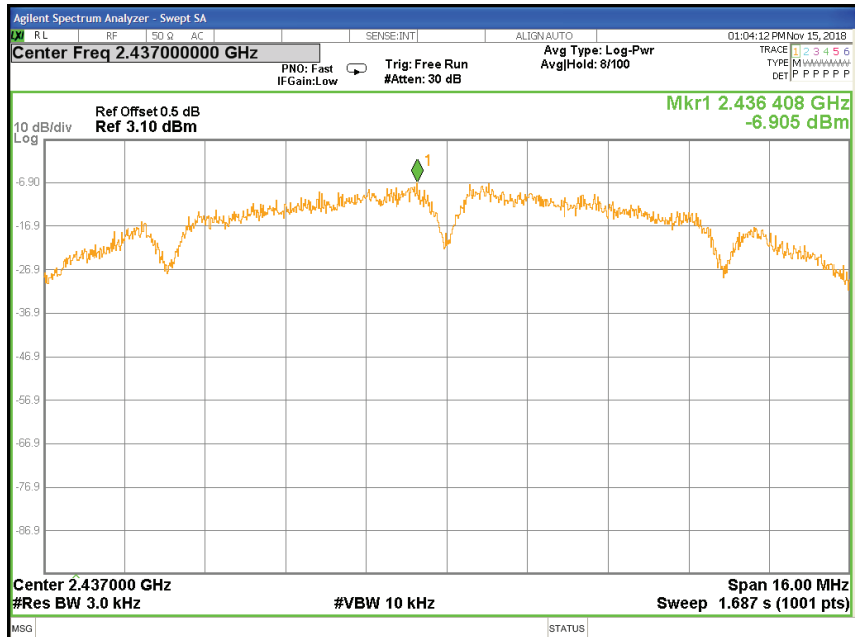

TX CH11

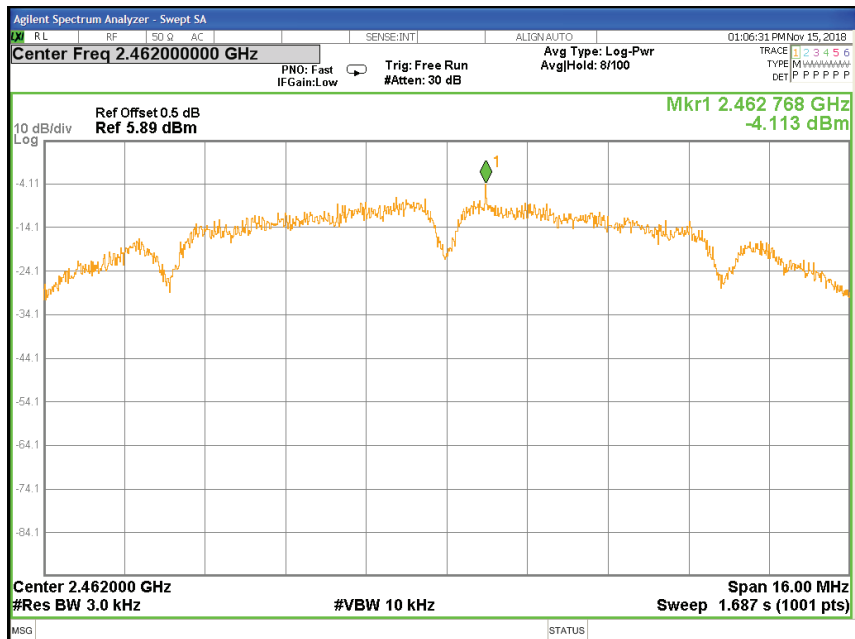



Temperature:	25°C	Relative Humidity:	60%
Test Voltage:	DC 12V	Test Mode:	TX g Mode /CH01, CH06, CH11

Test Mode	Frequency (MHz)	Power Density (dBm/3kHz)	Limit (dBm/3KHz)	Result
g mode (6 Mbps)	2412.00	-10.051	≤ 8.00	PASS
	2437.00	-9.732	≤ 8.00	PASS
	2462.00	-9.890	≤ 8.00	PASS

TX CH01

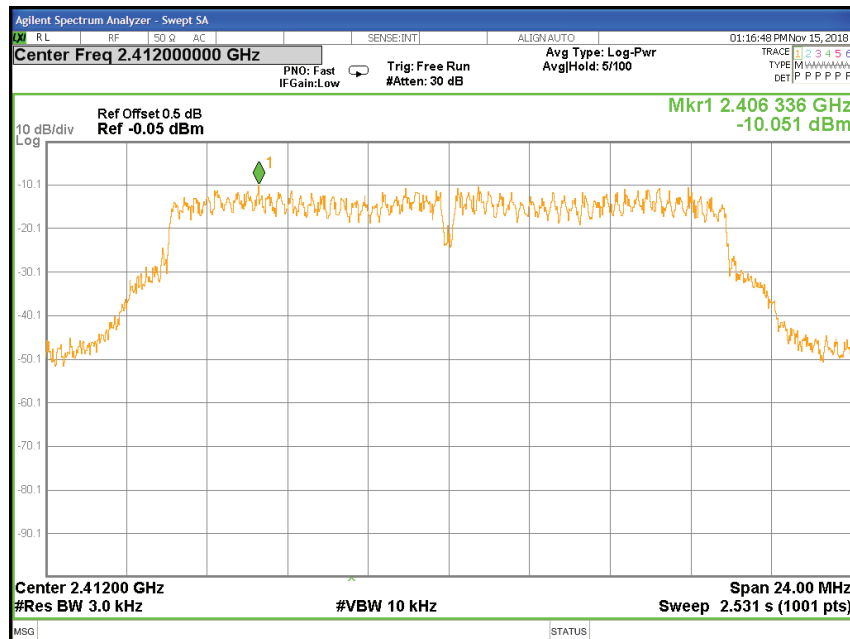



TX CH06

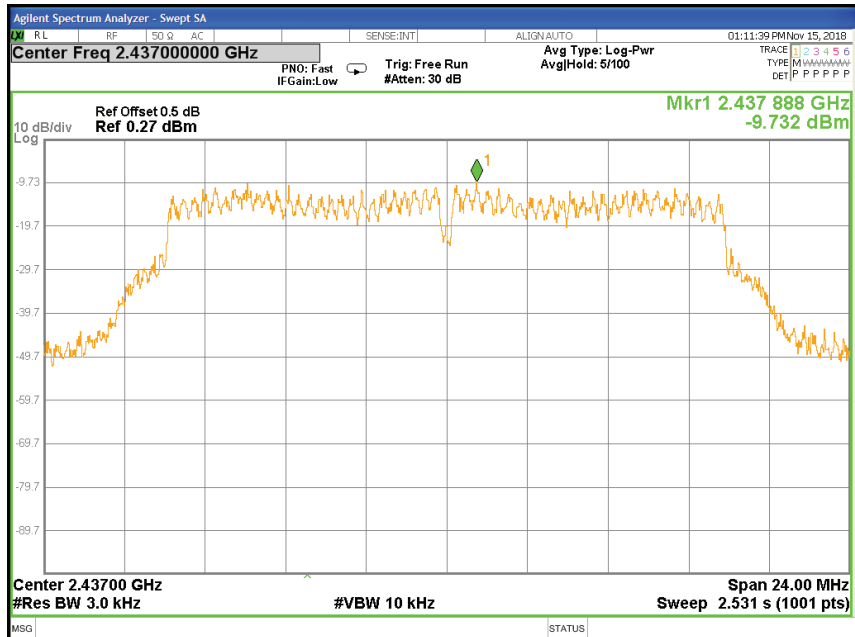

TX CH11

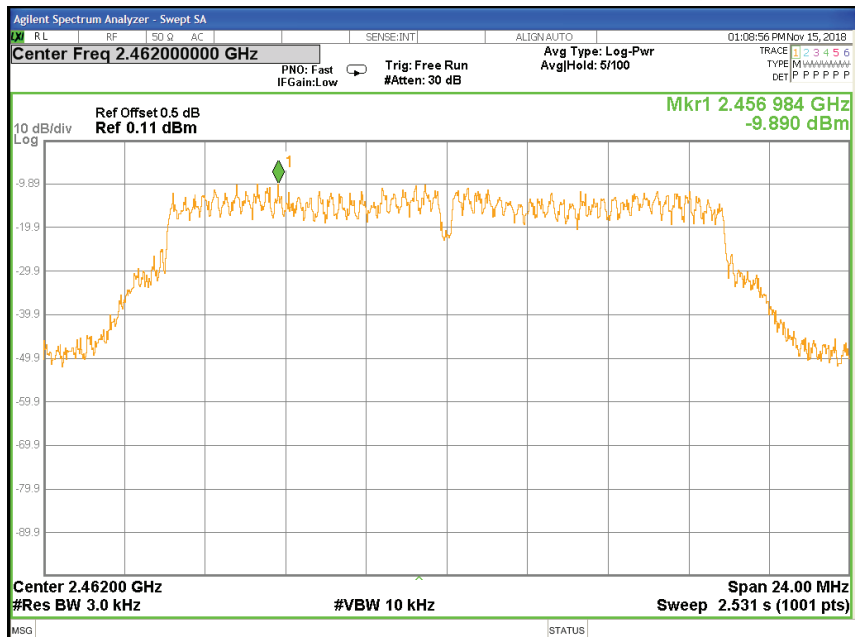



Temperature:	25°C	Relative Humidity:	60%
Test Voltage:	DC 12V	Test Mode:	TX n Mode(20M) /CH01, CH06, CH11

Test Mode	Frequency (MHz)	Power Density (dBm/3kHz)	Limit (dBm/3KHz)	Result
n(HT20) mode (MCS0)	2412.00	-11.667	≤ 8.00	PASS
	2437.00	-12.082	≤ 8.00	PASS
	2462.00	-11.345	≤ 8.00	PASS

TX CH01

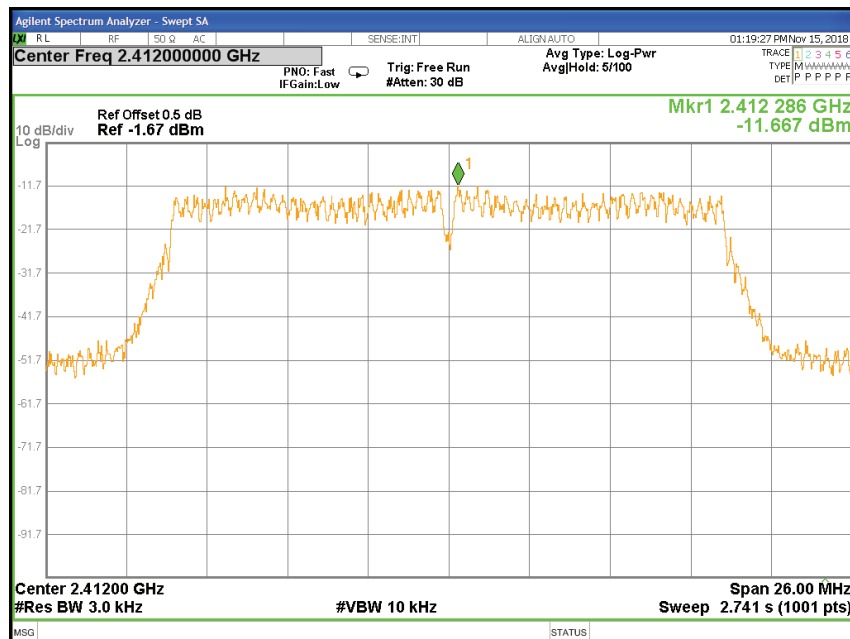



TX CH06

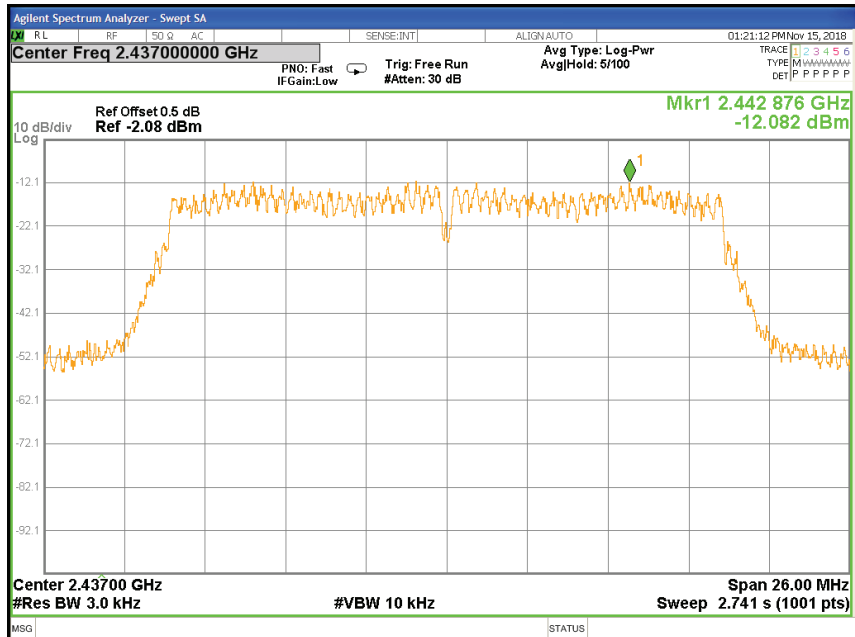

TX CH11

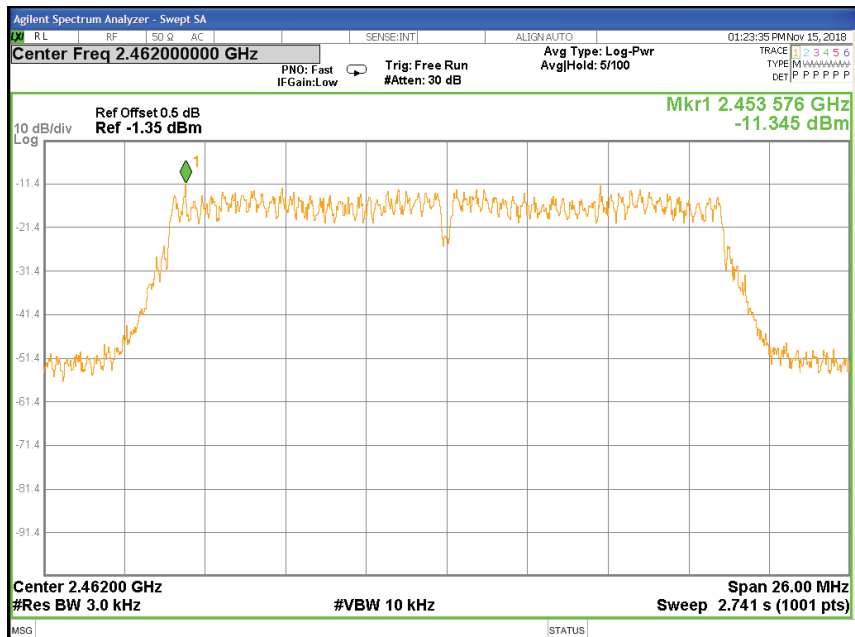



6 BANDWIDTH TEST

6.1 APPLIED PROCEDURES / LIMIT

FCC Part15.247,Subpart C RSS-247 Issue 2&RSS-Gen Issue 5				
Section	Test Item	Limit	Frequency Range (MHz)	Result
15.247(a)(2) RSS-247 Clause 5.2(b)	6dB Bandwidth	$\geq 500\text{KHz}$	2400-2483.5	PASS
RSS-Gen Clause 6.6	99%Bandwidth	-	2400-2483.5	PASS

6.2 TEST PROCEDURE

The automatic bandwidth measurement capability of an instrument may be employed using the X dB bandwidth mode with X set to 6 dB, if the functionality described above (i.e., RBW = 100 kHz, VBW \geq 3RBW, peak detector with maximum hold) is implemented by the instrumentation function. When using this capability, care shall be taken so that the bandwidth measurement is not influenced by any intermediate power nulls in the fundamental emission that might be ≥ 6 dB.

6.3 DEVIATION FROM STANDARD

No deviation.

6.4 TEST SETUP



6.5 EUT OPERATION CONDITIONS

The EUT tested system was configured as the statements of 2.3 Unless otherwise a special operating condition is specified in the follows during the testing.



6.6 TEST RESULTS

Temperature:	25°C	Relative Humidity:	60%
Test Voltage:	DC 12V	Test Mode:	TX b Mode /CH01, CH06, CH11

Remark: PEAK DETECTOR IS USED

Test Mode	Frequency (MHz)	6dB Bandwidth (MHz)	99% Bandwidth (MHz)	Limit of 6dB Bandwidth (MHz)	Result
b mode (1 Mbps)	2412.00	8.546	14.019	≥ 0.50	PASS
	2437.00	9.043	14.022	≥ 0.50	PASS
	2462.00	8.546	14.015	≥ 0.50	PASS

6dB Bandwidth TX CH 01

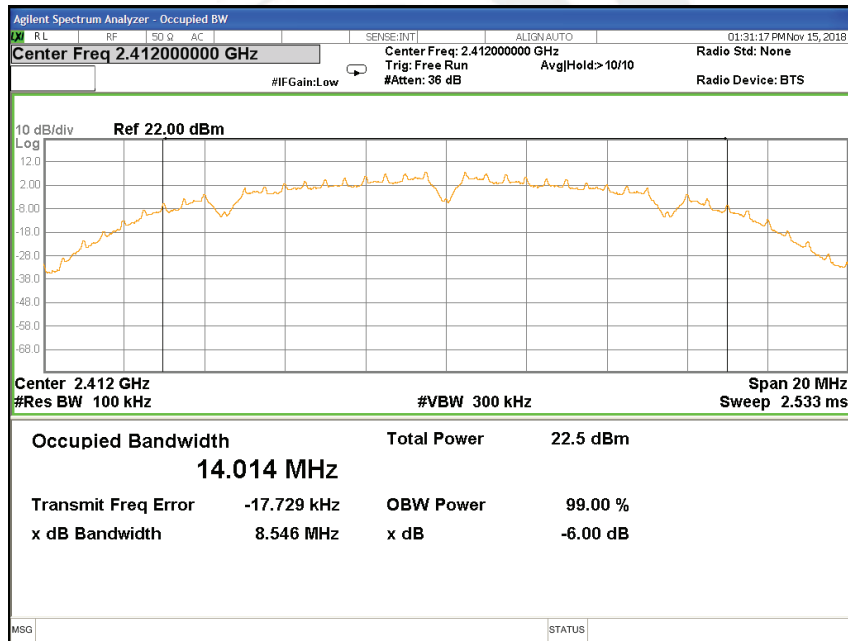



6dB BandwidthTX CH 06

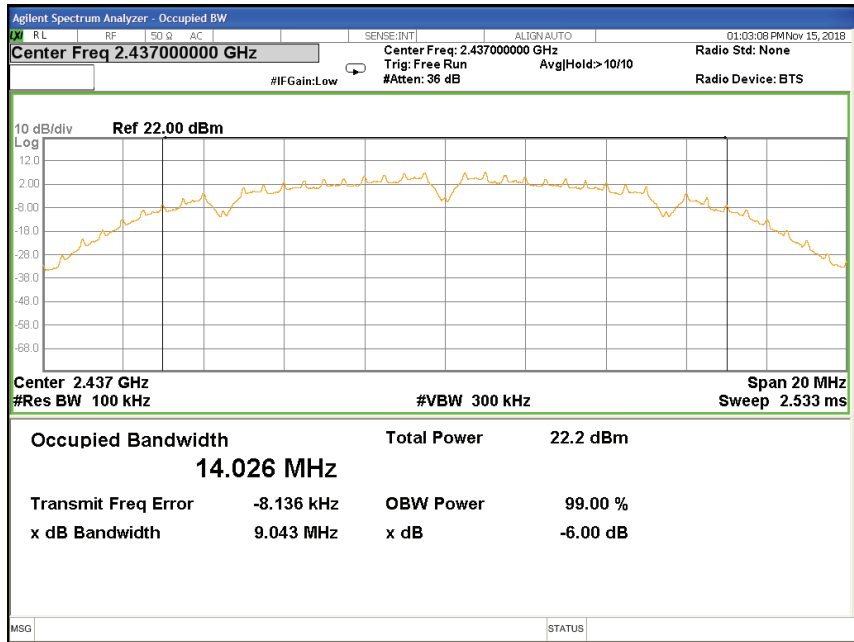

6dB BandwidthTX CH 11

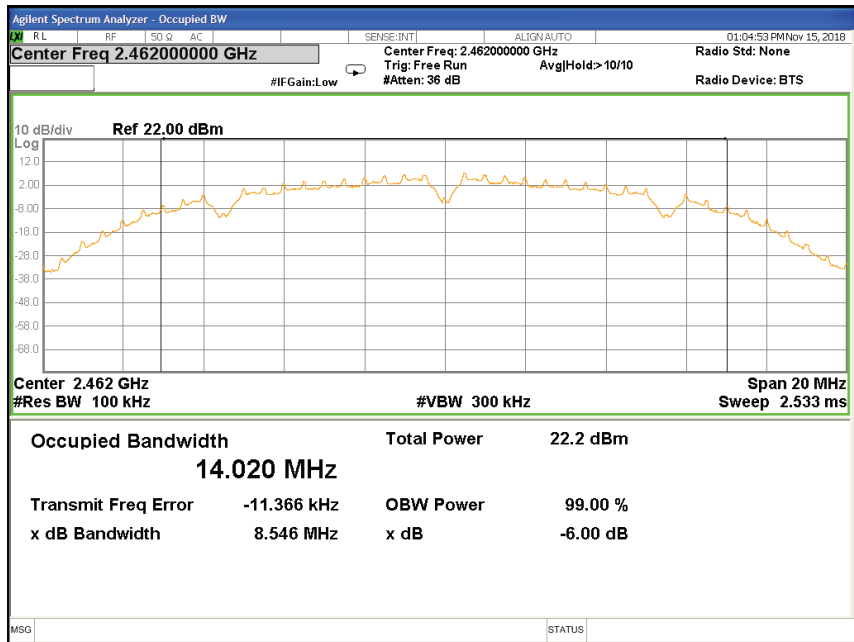



99%BandwidthTX CH 01

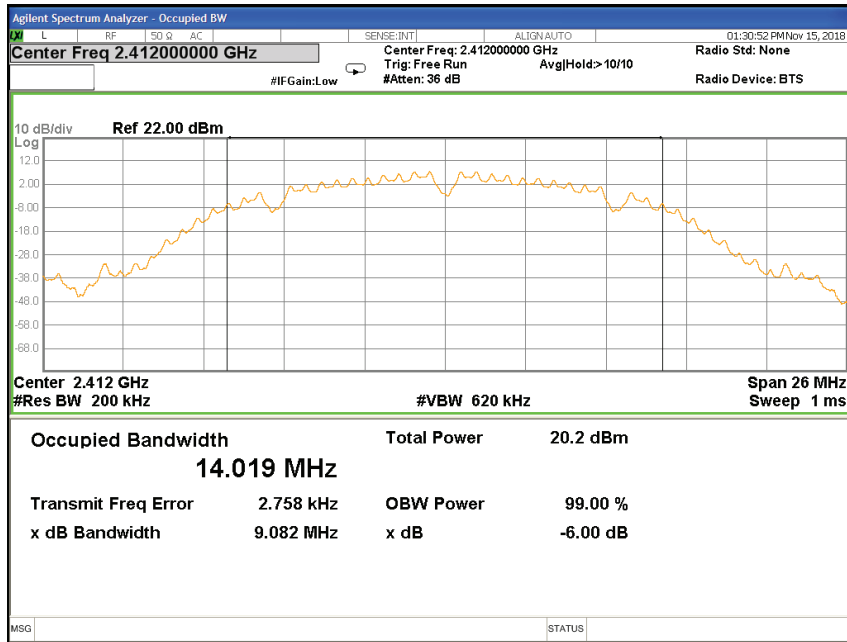

99%Bandwidth TX CH 06

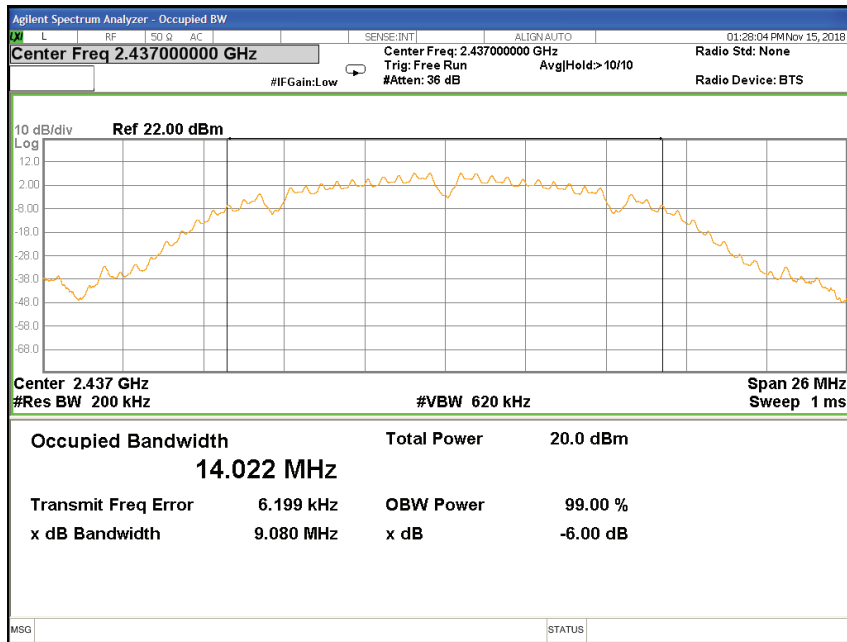



99%Bandwidth TX CH 11

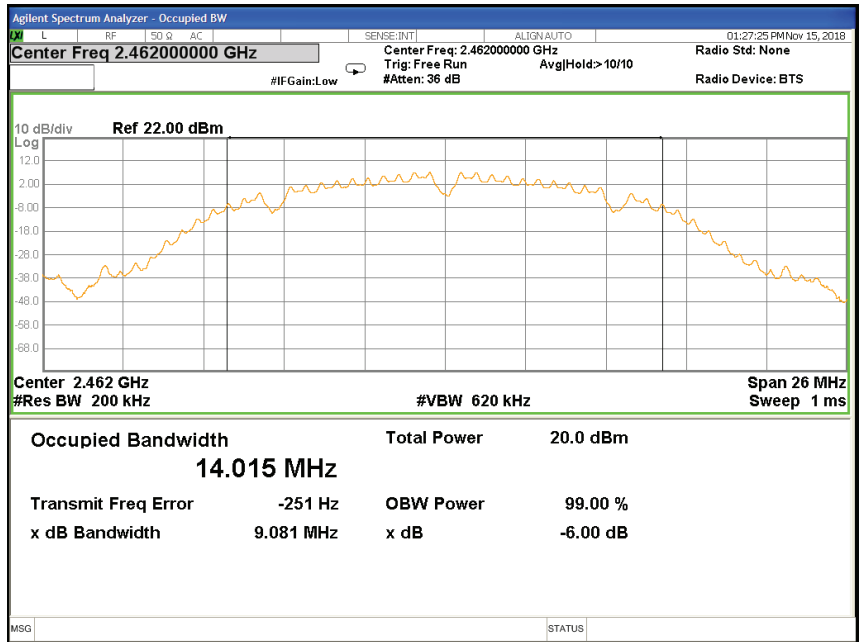



Temperature:	25°C	Relative Humidity:	60%
Test Voltage:	DC 12V	Test Mode:	TX g Mode /CH01, CH06, CH11

Test Mode	Frequency (MHz)	6dB Bandwidth (MHz)	99% Bandwidth (MHz)	Limit of 6dB Bandwidth (MHz)	Result
g mode (6 Mbps)	2412.00	15.67	16.620	≥ 0.50	PASS
	2437.00	16.24	16.625	≥ 0.50	PASS
	2462.00	16.05	16.635	≥ 0.50	PASS

6dB BandwidthTX CH 01

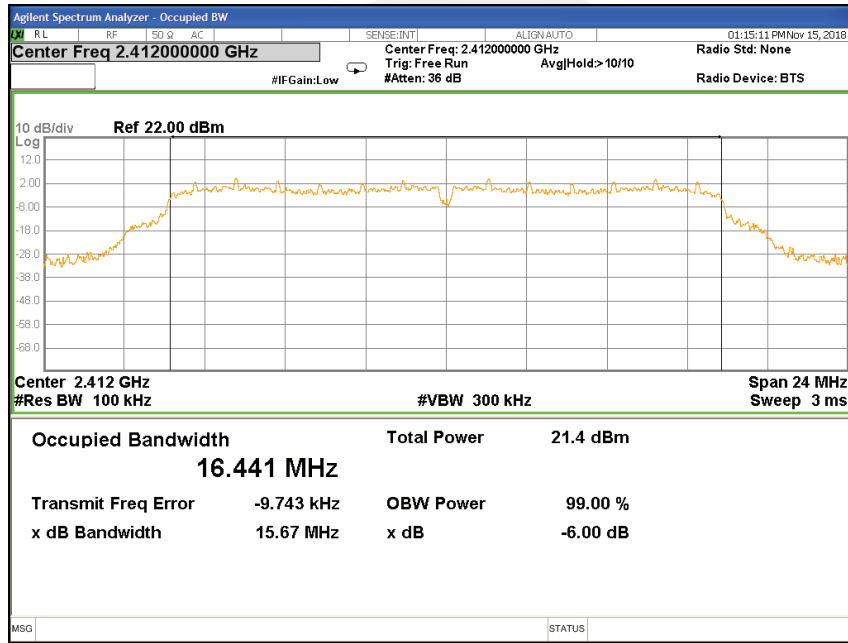



6dB BandwidthTX CH 06

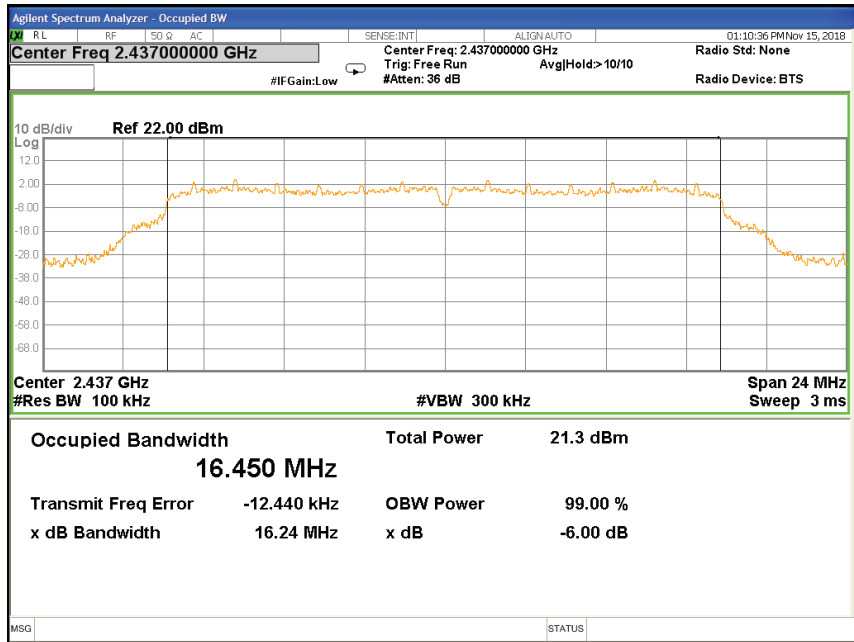

6dB BandwidthTX CH 11

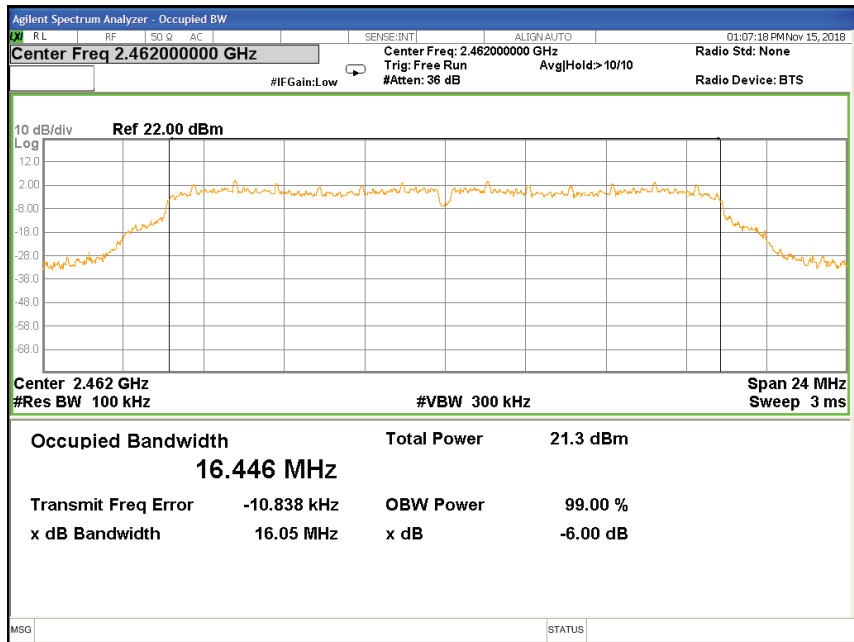



99%BandwidthTX CH 01

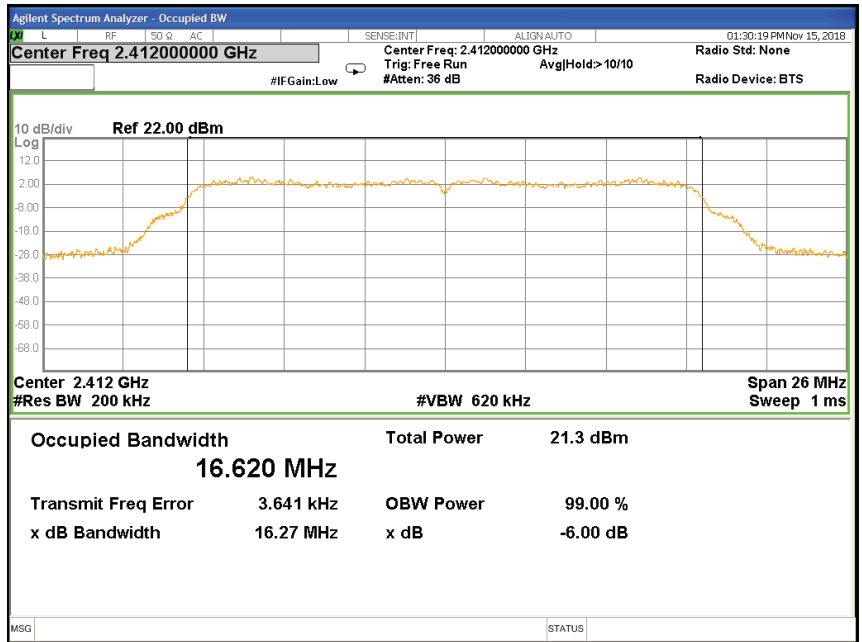

99%Bandwidth TX CH 06

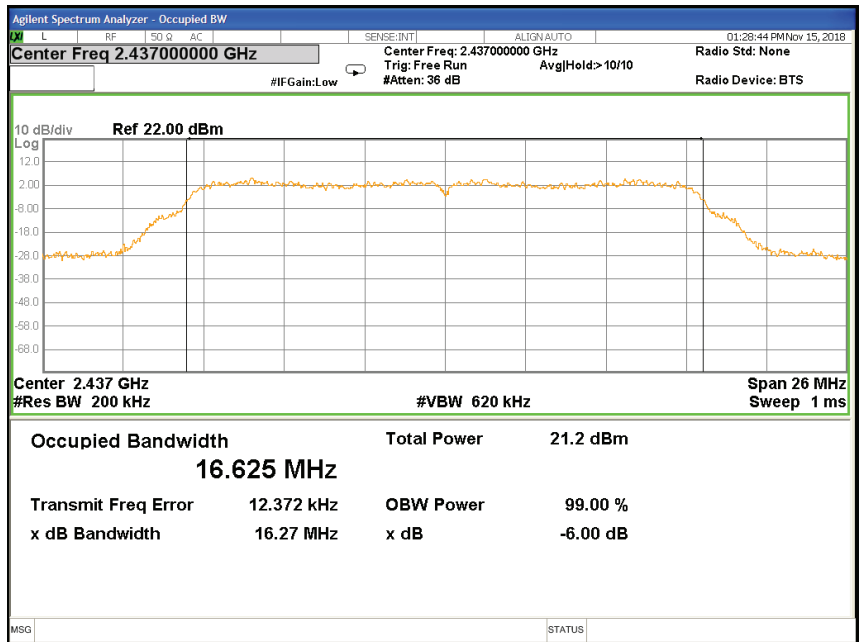



99%Bandwidth TX CH 11

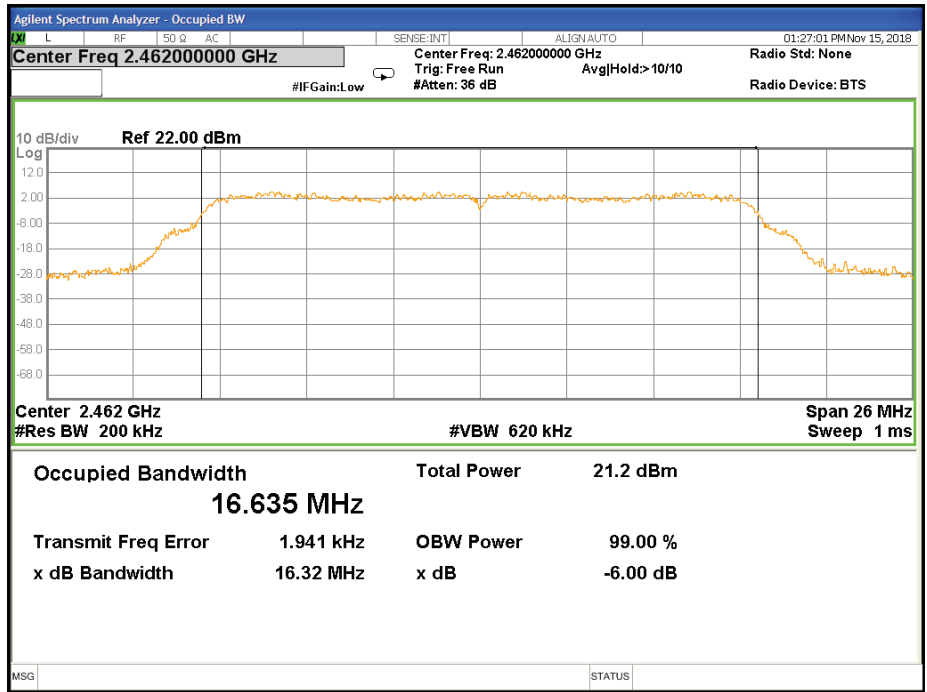



Temperature:	25°C	Relative Humidity:	60%
Test Voltage:	DC 12V	Test Mode:	TX n Mode(20M) /CH01, CH06, CH11

Test Mode	Frequency (MHz)	6dB Bandwidth (MHz)	99% Bandwidth (MHz)	Limit of 6dB Bandwidth (MHz)	Result
n(HT20) mode (MCS0)	2412.00	17.55	17.821	≥ 0.50	PASS
	2437.00	17.55	17.819	≥ 0.50	PASS
	2462.00	17.51	17.845	≥ 0.50	PASS

6dB BandwidthTX CH 01

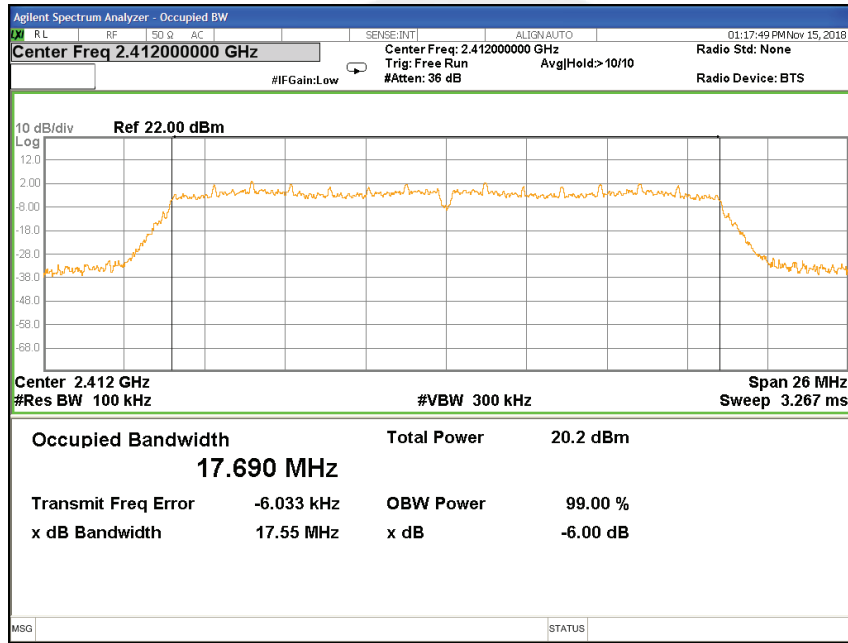



6dB BandwidthTX CH 06

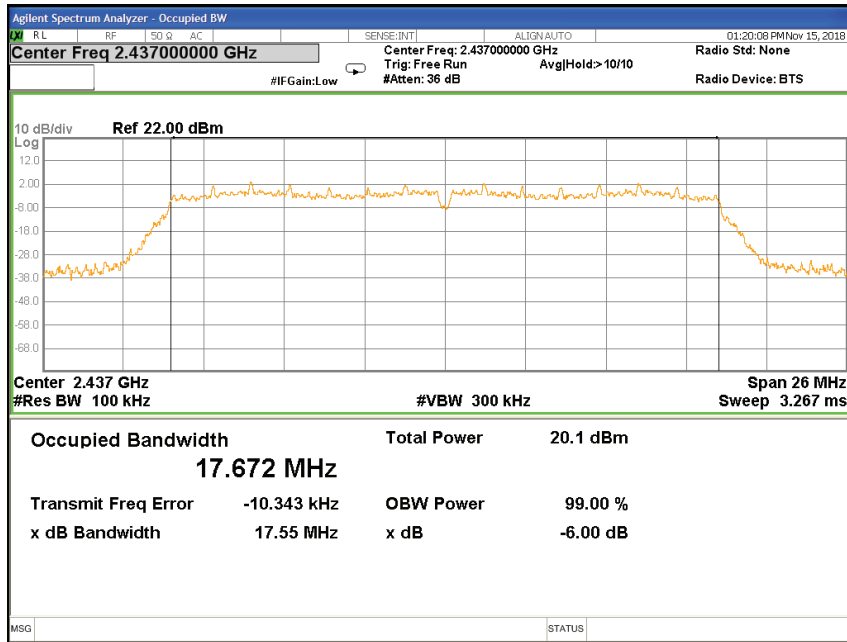

6dB BandwidthTX CH 11

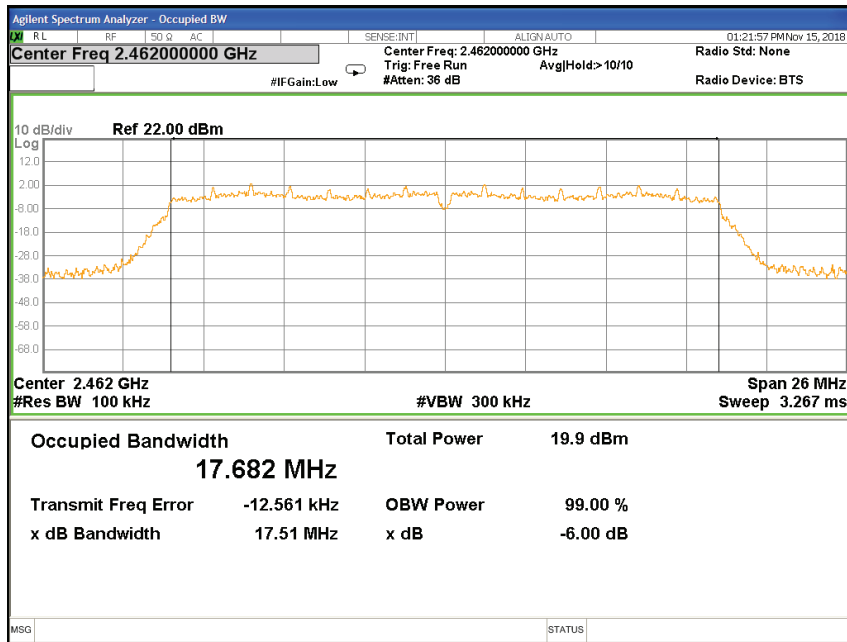



99%BandwidthTX CH 01

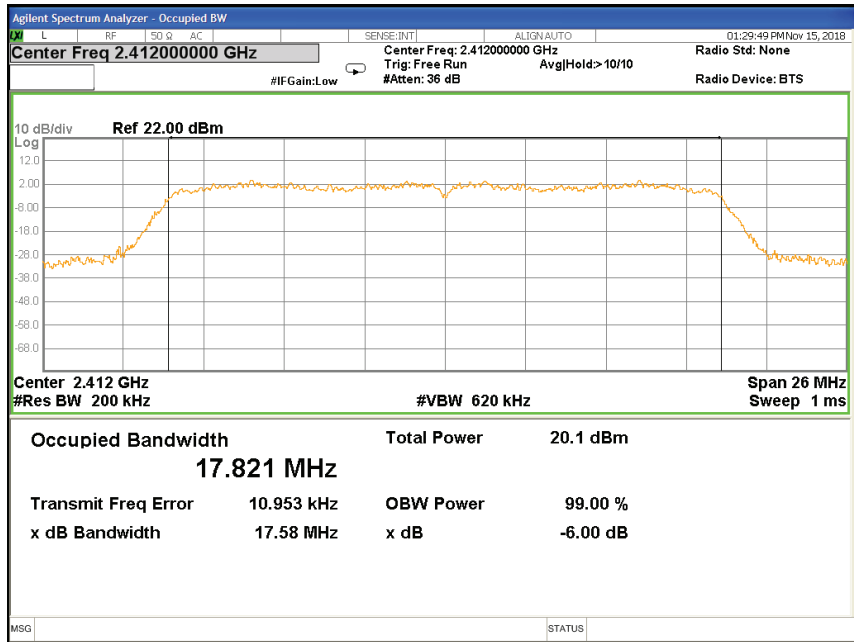

99%Bandwidth TX CH 06

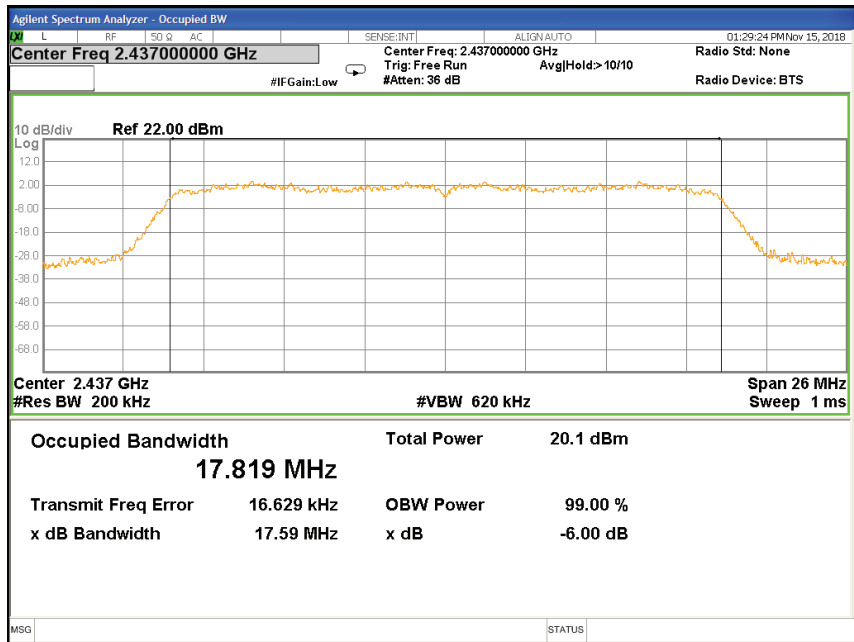



99%Bandwidth TX CH 11

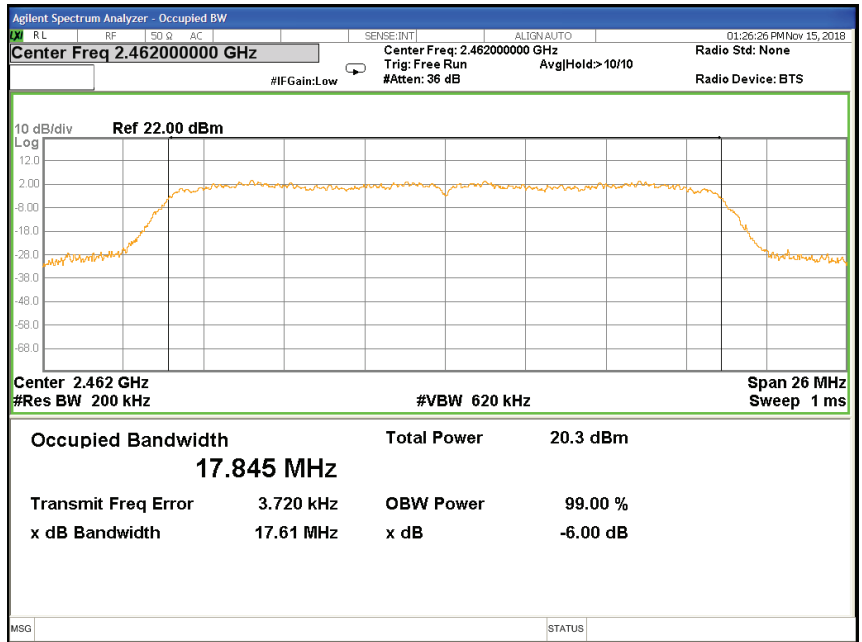

7 PEAK OUTPUT POWER TEST

7.1 APPLIED PROCEDURES / LIMIT

FCC Part15.247,Subpart C RSS-247 Issue 2				
Section	Test Item	Limit	Frequency Range (MHz)	Result
15.247(b)(3) RSS-247 Clause 5.4(d)	Output Power	1 watt or 30dBm	2400-2483.5	PASS
RSS-247 Clause 5.4(d)	e.i.r.p.	4 watt or 36.02dBm	2400-2483.5	PASS

7.2 TEST PROCEDURE

- a. The EUT was directly connected to the Power Meter

7.3 DEVIATION FROM STANDARD

No deviation.

7.4 TEST SETUP



7.5 EUT OPERATION CONDITIONS

The EUT tested system was configured as the statements of 2.3 Unless otherwise a special operating condition is specified in the follows during the testing.



7.6 TEST RESULTS

Temperature :	25°C	Relative Humidity :	60%
Test Voltage :	DC 12V		

TX 802.11 b mode (1 Mbps)						
Test Channel	Frequency (MHz)	Conducted Output Power		Limit (dBm)	e.i.r.p. (dBm)	e.i.r.p. Limit (dBm)
		Peak(dBm)	AVG(dBm)			
CH01	2412.00	19.42	18.31	30.00	22.92	36.02
CH06	2437.00	19.23	18.14	30.00	22.73	36.02
CH11	2462.00	19.07	17.96	30.00	22.57	36.02

TX 802.11 g mode (6 Mbps)						
Test Channel	Frequency (MHz)	Conducted Output Power		Limit (dBm)	e.i.r.p. (dBm)	e.i.r.p. Limit (dBm)
		Peak(dBm)	AVG(dBm)			
CH01	2412.00	22.64	21.52	30.00	26.14	36.02
CH06	2437.00	22.34	21.26	30.00	25.84	36.02
CH11	2462.00	21.19	20.17	30.00	24.69	36.02

TX 802.11 n(HT20) mode (MCS0)						
Test Channel	Frequency (MHz)	Conducted Output Power		Limit (dBm)	e.i.r.p. (dBm)	e.i.r.p. Limit (dBm)
		Peak(dBm)	AVG(dBm)			
CH01	2412.00	21.54	19.41	30.00	25.04	36.02
CH06	2437.00	21.30	19.26	30.00	24.80	36.02
CH11	2462.00	21.04	19.02	30.00	24.54	36.02



8 ANTENNA REQUIREMENT

8.1 STANDARD REQUIREMENT

15.203 and RSS-Gen Issue 5 requirement: For intentional device, according to 15.203 and RSS-Gen Issue 5: an intentional radiator shall be designed to ensure that no antenna other than that furnished by the responsible party shall be used with the device.

8.2 EUT ANTENNA

The EUT antenna is Eternal FPC Antenna. It complies with the standard requirement.





9 FREQUENCY STABILITY

9.1 LIMITS OF FREQUENCY STABILITY MEASUREMENT

The frequency tolerance of the carrier signal shall be maintained within $\pm 0.02\%$ of the operating frequency over a temperature variation of -30 degrees to 50 degrees C at normal supply voltage, and for a variation in primary supply voltage from 85% to 115% of the rated supply voltage at a temperature of 20 degrees.

9.2 TEST PROCEDURE

1. The EUT was placed inside the environmental test chamber and powered by nominal DC voltage.
2. Turn the EUT on and couple its output to spectrum analyzer.
3. Turn the EUT off and set the chamber to the highest temperature specified.
4. Allow sufficient time (approximately 30 min) for the temperature of the chamber to stabilize, turn the EUT on and measure the operating frequency after 2, 5, and 10 minutes.
5. Repeat step 2 and 3 with the temperature chamber set to the lowest temperature.
6. The test chamber was allowed to stabilize at $+20$ degree C for a minimum of 30 minutes. The supply voltage was then adjusted on the EUT from 85% to 115% and the frequency record.

9.3 TEST RESULT

Channel 06 (2437MHz)

Voltage vs. Frequency Stability

Voltage vs. Frequency Stability Voltage(V)	Measurement Frequency(MHz)
12.77	2437.0025
11.1	2437.0016
9.44	2437.0021
Max.Deviation(MHz)	0.0025
Max.Deviation(ppm)	1.03

Rated working voltage:DC 11.1V

Temperature vs. Frequency Stability

Temperature($^{\circ}$ C)	Measurement Frequency(MHz)
-30	2437.0036
-20	2437.0031
-10	2437.0035
0	2437.0033
10	2437.0036
20	2437.0035
30	2437.0032
40	2437.0027
50	2437.0035
Max.Deviation(MHz)	0.0036
Max.Deviation(ppm)	1.48