

End of life

The entire Detector must be replaced if the unit is installed for over 10 years (check the "replace by" date marked on the side of the unit).

Before the Detector is safely discarded, remove from the mounting plate and disconnect the batteries.

Do not put the Detector into a fire.

The Detector should be disposed in a safe and environmentally sound manner at your local recycling center.

FAMILY ESCAPE PLAN

According to National Fire Protection Association (NFPA), there often is very little time between the detection of a fire and the time it becomes deadly. This interval can be as little as 2 minutes. Planning and practicing for fire conditions with a focus on rapid exit from the residence are important. Drills should be held so that all family members know the action to be taken.

SAFETY TIPS

- Make a home escape plan. Draw a map of your home showing all doors and windows. Discuss the plan with everyone in your home.
- Know at least two ways out of every room, if possible. Make sure all doors and windows leading outside open easily.
- Have an outside meeting place (like a tree, light pole or mailbox) a safe distance from the home where everyone should meet.
- Practice your home fire drill at night and during the day with everyone in your home, twice a year.
- Practice using different ways out.
- Teach children how to escape on their own in case you can't help them.
- Close doors behind you as you leave.

IF THE DETECTOR SOUNDS

- If the smoke detector sounds, get out and stay out. Never go back inside for people or pets.
- If you have to escape through smoke, get low and go under the smoke to your way out.
- Call the fire department from outside your home.

FOR MORE SAFETY INFORMATION SEE THE WEBSITE:

SPECIFICATIONS	
Unique ID Codes	Over one (1) billion different code combinations
Supervisory Interval	70 minutes
Dimensions	4.7" x 1.8" high (120mm x 46mm high)
Weight (including battery):	7.41 oz (210 g)
Color	White
Spacing Rating	70ft
Audible Signal (ANSI Temporal 3)	85dBA min. in alarm
Sensitivity	2.5 - 4.0%/foot
High Temperature Level	At or above 134°F +/- 4°F.
High Rate of Temperature Rise	Above 104°F and increase of 15 degrees or more in one minute.
Low Temperature Warning	At or below 40°F for up to 1 min. Restore at 45°F for up to 1 min.
Operating Temperature	40°-100°F (4.4°-37.8°C)
Relative Humidity	15-95% Non-Condensing
Battery (included)	2 CR123A Panasonic Batteries
Regulatory Listing	UL 268
Warranty	Two (2) years
Equipment Code	1058

www.nfpa.org/education

REGULATORY INFORMATION

NOTICE: Unauthorized changes or modifications could void the user's authority to operate the equipment.

This device complies with Part 15 of the FCC Rules and Industry Canada licence-exempt RSS standard(s). Operation is subject to the following two conditions: (1) This device may not cause harmful interference, and (2) this device must accept any interference received, including interference that may cause undesired operation of the device.

This equipment has been tested and found to comply with the limits for a Class B digital device, pursuant to Part 15 of FCC Rules. These limits are designed to provide reasonable protection against harmful interference in a residential installation. This equipment generates, uses and can radiate radio frequency energy and if not installed and used in accordance with the instructions, may cause harmful interference to radio communications. However, there is no guarantee that interference will not occur in a particular installation. If this equipment does cause harmful interference to radio or television reception, which can be determined by turning the equipment off and on, the user is encouraged to try to correct the interference by one or more of the following measures:

- Reorient or relocate the receiving antenna.
- Increase the separation between the equipment and the receiver
- Connect the equipment into an outlet on a circuit different from that to which the receiver is connected.
- Consult the dealer or an experienced radio/television technician for help

LIMITED WARRANTY

This Nortek Security & Control product is warranted against defects in material and workmanship for two (2) years. This warranty extends only to wholesale customers who buy direct from Nortek Security & Control or through Nortek Security & Control's normal distribution channels. Nortek Security & Control does not warrant this product to consumers. Consumers should inquire from their selling dealer as to the nature of the dealer's warranty, if any.

There are no obligations or liabilities on the part of Nortek Security & Control for consequential damages arising out of or in connection with use or performance of this product or other indirect damages with respect to loss of property, revenue, or profit, or cost of removal, installation, or reinstallation. All implied warranties, including implied warranties for merchantability and implied warranties for fitness, are valid only until warranty expires. This Nortek Security & Control Warranty is in lieu of all other warranties express or implied.

All products returned for warranty service require a Return Product Authorization Number (RPA#). Contact Returns at 1-855-546-3351 for an RPA# and other important details.

SUPPORT SERVICES

Should you require support services for this system, contact 2GIG Technical Support at Nortek Security & Control.

COMPATIBLE 2GIG PANEL MODELS

2GIG-GC3e-345 2GIG GC3e eSeries Panel 345 MHz

Nortek Security & Control LLC | 2GIG
5919 Sea Otter Place, Suite 100, Carlsbad, CA. 92010



For technical support in the USA and Canada:
855-2GIG-TECH (855-244-4832)
Email: 2gigtechsupport@nortekcontrol.com
Visit www.nortekcontrol.com for technical support hours of operation.

For technical support outside of the USA and Canada:
Contact your regional distributor.
Visit www.2gig.com/dealers/ for a list of distributors in your region.



10023353 A

2GIG eSeries™
WIRELESS SMOKE HEAT FREEZE DETECTOR
INSTALLATION GUIDE

ATTENTION: This manual should be read prior to use and retained for further information.

GENERAL INFORMATION

The 2GIG-SMKT8E-345 Smoke Heat Freeze Detector is a battery powered wireless device for detecting the presence of smoke or extreme temperatures. It is one of the e-Series devices from Nortek Security and Control providing enhanced security with encrypted communications to the control panel and the intended use is with compatible 2GIG 345 MHz wireless alarm systems (see Compatible 2GIG Panel Models, back page, for a list of compatible panels).

Complying to the new UL 268 standards, this device utilizes advanced sensing technology designed to reduce nuisance alarms during cooking and respond to the different smoke characteristics between fast moving and smoldering polyurethane foam fires.

To know the maximum number of transmitters that can be supported, see the appropriate 2GIG Security System Installation Guide.

CONTENTS OF BOX

- Wireless Smoke Heat Freeze with base
- Installation guide
- Pack of screws and fixings
- Stickers as appropriate
- 2 CR123A Lithium Batteries

2GIG-SMKT8E-345 Series Indicator Summary				
Normal Operation	Action	Red LED	Yellow LED	Sounder
Power Up	Pull Battery tab or insert Battery	1 Flash	1 Flash	Off
Standby	—	Off	Off	Off
Sensing Fire	—	Rapid Flashing	Off	Full Sound
Fault Mode	Action	Red LED	Yellow LED	Sounder
Low Battery	—	Off	1 Flash every 48 sec	1 Beep with 1 Flash
Faulty Smoke Sensor	—	Off	2 Flashes every 48 sec	2 Beeps with 2 Flashes
Faulty Heat Sensor	—	Off	2 Flashes every 48 sec	2 Beeps with 2 Flashes
End of Life	—	Off	3 Flashes every 48 sec	3 Beeps with 3 Flashes
Silence Sounding Alarm	Press & Release Button	1 Flash every 8 sec	Off	Off for 10 mins
Silence End of Life indication (up to 30 days)	Press & Release Button	Off	Off for 72 hours	Off for 72 hours
Dusty Chamber	Press Test Button to activate beeps	Off	4 flashes every 48 seconds	Beep 4 times on test button press only
Test Mode	Action	Red LED	Yellow LED	Sounder
Test Smoke Alarm	Press Button	Rapid Flashing	Off	Full Sound
Alarm Memory	Action	Red LED	Yellow LED	Sounder
24 Hour Memory	—	2 Flashes every 48 sec for 24 hours	Off	Off
Long Term Memory	Press & Hold Button	Rapid Flashing	Off	Rapid Chirping

Table 1. Detector status and indication

The Wireless Smoke Heat Detector contains a sounder which generates the ANSI S3.41 temporal 3 pattern in an alarm condition.

In alarm, a message is also sent to the control panel and the Detector's ID is displayed at the console. During an alarm condition, pressing the Detector's hush button will silence the sounder (see Table 1). The mounting base installation is simplified by the incorporation of features compatible for both drywall fasteners (not supplied) and other methods.

Red and Green LEDs and a sounder on the Detector provide local visual and audible indication of the Detector's status as listed in Table 1.

During initial power-up the red LED will flash once followed by one flash of the yellow LED to indicate that the Detector has been powered successfully and is now in standby mode.

After power-up has completed and the Detector is functioning normally, there will be no LED indications.

Sensing Fire: As soon as the Detector senses smoke, it will go into Alarm. The red LED begins to flash rapidly to indicate that this is the Detector sensing smoke / fire.

Silence False / Nuisance Alarm: Occasionally Smoke Detectors can be activated by phenomena other than fire, such as dust, insects, cooking smoke and shower steam. When the Detector sounds and there is no sign of smoke or noise to indicate that there is a fire, it should be assumed that it is due to an actual fire. The dwelling should be evacuated immediately, and the local Fire Department should be contacted.

It is possible that cooking smoke, steam, etc., may be the source of nuisance alarms.

If there are frequent nuisance/false alarms, it may be necessary to re-locate the Smoke Detector away from the source (cooking smoke, shower steam, etc.).

Once you are sure it is a nuisance alarm, press the large test button to silence the Detector for 10 minutes – the red LED will then flash every 8 seconds for 10 minutes.

Pressing the test button will make the unit less sensitive, but if a large amount of smoke / steam / dust is observed the unit will remain in alarm.

Low Battery Detection: The Wireless Smoke Heat Freeze Detector is powered by two CR123A batteries (included).

The Detector regularly checks for a low battery. If a low battery is detected, the transmitter sends a low battery message to the control panel, which displays the Detector's ID at low battery. In addition, the yellow LED and the Detector's sounder will chirp every 48 seconds until the batteries are replaced. The batteries should be replaced when the chirps begin. Be sure to replace the batteries with fresh ones.

BATTERY INSTALLATION AND REPLACEMENT

To replace the batteries:

1. Remove the Detector from its mounting base by twisting the Detector counterclockwise. Remove and dispose of the batteries according to your local regulations.
2. To ensure proper power-down sequence, wait a minimum of 20 seconds before installing new batteries.
3. Install two new CR123A batteries (available from your local Panasonic dealer) in the battery compartment. Follow the polarity diagram inside the compartment. If the batteries are incorrectly inserted, please remove gently with a non-conductive tool and correctly reinsert.

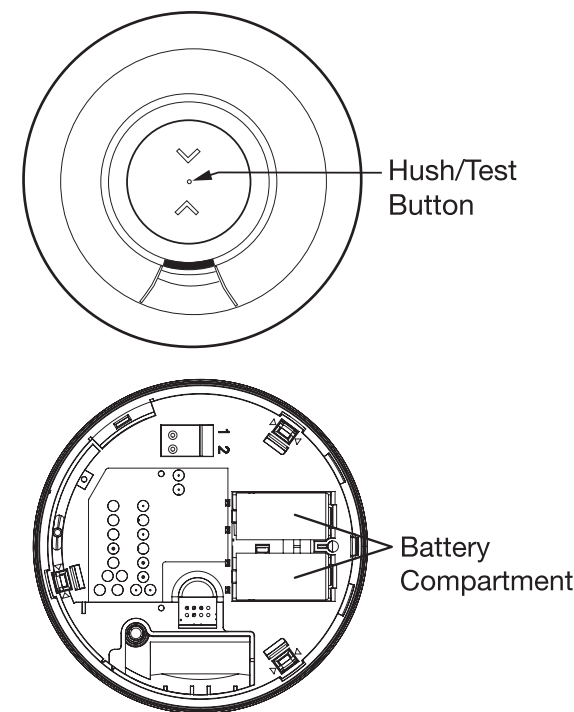

Fig 1. Wireless Smoke Heat Detector

P/N B19580 Rev0

- Reinstall the Detector onto the mounting base by turning the Detector clockwise until the mating marks align.
- After the power-up sequence, the red LED will flash once followed by one flash of the yellow LED to indicate that the Detector has been powered successfully and is now in standby mode. If the batteries are not installed correctly, the Detector will not operate and the batteries may be damaged. If the Detector does not power-up, check for correct batteries installation and for a fully charged batteries.
- Test the Detector (as described later).

CONSTANT EXPOSURES TO HIGH OR LOW TEMPERATURES OR HIGH HUMIDITY MAY REDUCE BATTERY LIFE.

PROGRAMMING

The internal wireless transmitter must be programmed into the control panel.

Refer to the control panel's instructions to program the receiver with the Detector's serial number (TX ID from the label).

Each of the Detector's functions must be programmed into the panel.

- Loop 1: Smoke
- Loop 2: Heat
- Loop 3: Freeze

RECOMMENDED LOCATIONS FOR SMOKE HEAT DETECTOR

According to National Fire Protection Association (NFPA) the major threat from fire in a dwelling unit occurs at night when everyone is asleep. The principal threat to persons in sleeping areas comes from fires in the remainder of the unit; therefore, a smoke Detector(s) is best located between the bedroom areas and the rest of the unit. In units with only one bedroom area on one floor, the smoke Detector(s) should be located as shown in **Figure 2**. In dwelling units with more than one bedroom area or with bedrooms on more than one floor, more than one smoke Detector is required, as shown in **Figure 3**.

In addition to smoke Detectors outside of the sleeping areas, the device should be installed on each additional story of the dwelling unit, including the basement. These installations are shown in **Figure 4**. The living area smoke Detector should be installed in the living room or near the stairway to the upper level, or in both locations. The basement smoke Detector should be installed in close proximity to the stairway leading to the floor above. Where installed on an open-joisted ceiling, the Detector should be placed on the bottom of the joists. The Detector should be positioned relative to the stairway so as to intercept smoke coming from a fire in the basement before the smoke enters the stairway.

Smoke Detectors are optional where a door is not provided between living room and recreation room (**Figure 5**).

The smoke from a fire generally rises to the ceiling, spreads out across the ceiling surface, and begins to bank down from the ceiling. The corner where the ceiling and wall meet is an air space into which the smoke could have difficulty penetrating. In most fires, this dead air space measures about 0.1m (4in.) along the ceiling from the corner and about 0.1m (4in.) down the wall. Detectors should not be placed in this dead air space, see **Figure 6, 7** and **8**.

Where NOT to install the Detector:

- Directly above a sink, cooker, stove or oven
- Do not locate Detector within 10 feet (3m) of any cooking appliance. However, to reduce the likelihood of incidental alarms due to cooking, the distance can be increased to a minimum of 20 feet (6m) where possible.
- Next to a door or window that would be affected by drafts i.e. extractor fan or air vent outside
- Do not install in any environment that does not comply with the Detector's environmental specifications.
- In or below a cupboard
- Where air flow would be obstructed by curtains or furniture
- Where dirt or dust could collect and block the sensor
- Where it could be knocked, damaged, or inadvertently removed

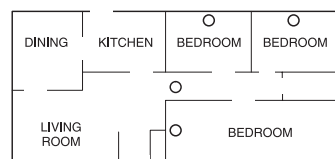

Fig 2. Location of the Detectors in units with only one bedroom area on one floor.

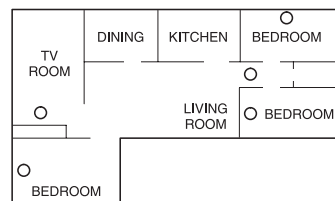

Fig 3. Location of the Detectors in dwelling units with more than one bedroom area or with bedrooms on more than one floor.

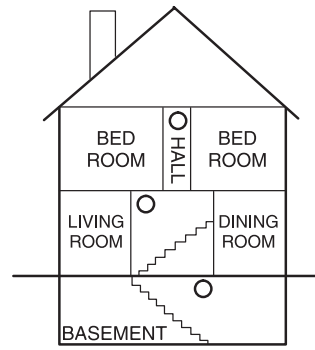

Fig 4. Detector located on each story

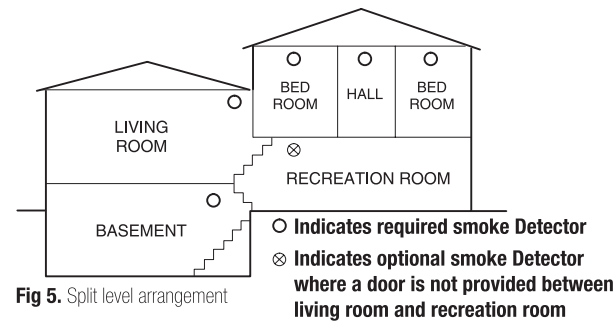

Fig 5. Split level arrangement

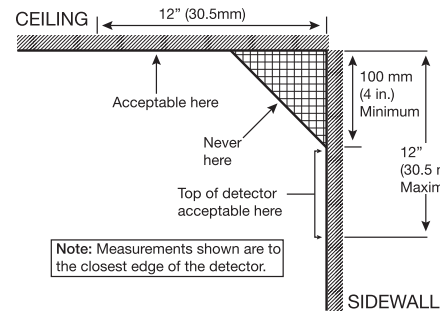

Fig 6. Example of proper mounting for Detectors

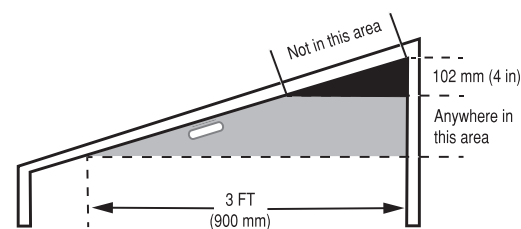

Fig 7. Example of proper mounting for Detectors with sloped ceilings

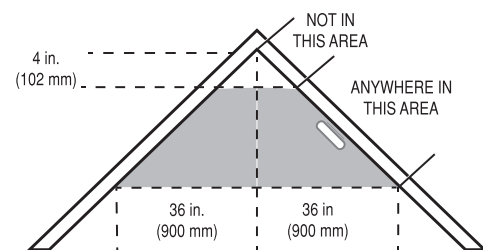

Fig 8. Example of proper mounting for Detectors with peaked ceilings

This Detector shall not be installed in locations where the normal ambient temperature is below 40°F (4.4°C) or where it exceeds 100°F (37.8°C).

THIS EQUIPMENT SHOULD BE INSTALLED IN ACCORDANCE WITH THE NATIONAL FIRE PROTECTION ASSOCIATION'S STANDARD 72.

LIMITATION OF WIRELESS EQUIPMENT

When placing the wireless smoke Detectors, it is important to remember that they communicate with the 2GIG panel over radio frequency (RF). This subjects the system to radio interference, which can be caused by a variety of sources, such as other RF devices, construction materials, meta objects, or even when placing sensors in close proximity to other appliances, electronic devices or electrical wiring.

The maximum separation range is over 700 ft line-of-sight between the panel and the smoke Detector, which may be reduced by the factors stated above. To ensure the Detectors are installed in areas that provide the best possible signal strength, please note the following illustration:

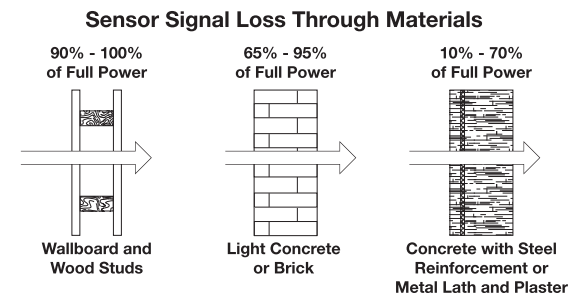

MOUNTING THE DETECTOR

Note: These detector devices should only be installed by a competent engineer.

This device should not be used with a guard.

Once a suitable location is found, mount the Detector as follows:

- Refer to the diagram below, and install the mounting base on the ceiling or on the wall (if local ordinances permit) using screw locations as required. Use the two screws and anchors provided. Maneuver the base so the screws are at the elbow of the screw slots and secure.
- Fit the Detector inside the base by aligning it over the base as shown (Detector's alignment notch should be aligned with the mounting base tamper release tab and mark), then turn the Detector in a clockwise direction until it clicks into place.
- Test the Detector after completing the installation (as described in the TESTING THE DETECTOR section of this manual) and refer to the control system's instructions for additional information concerning the use of wireless devices.

DO NOT attach the Detector to removable ceiling panels.

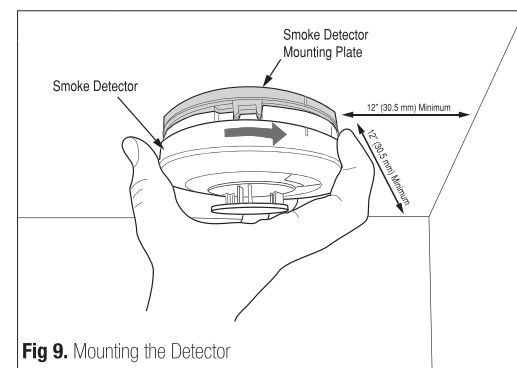

Fig 9. Mounting the Detector

TESTING THE DETECTOR

NOTE: Before testing, notify the central station that the Detector system is undergoing maintenance in order to prevent unwanted alarms. Testing the Detector will activate an alarm and send a signal to the panel. Also, the test function cannot be used if the Detector has a trouble condition.

Detectors must be tested after installation and following periodic maintenance.

Testing Detector Operation

This test checks the Detector's sounder, LEDs, and transmitter.

- The test button is located on the Detector housing.
- Push and hold the test button until the Detector sounds and the red LED flashes (see **Figure 1**). The Detector will stop sounding shortly after the button is released. The alarm panel will trigger and into alarm. The sounder begins the temporal 3 pattern and the red LED blinks. The alarm panel's console should display the Detector's name in alarm.

WARNING: Do not test with flame.

This can set fire to the Detector and damage the house. We do not recommend testing with smoke as the results can be misleading unless special apparatus is used.

When you press the **Test button**, it simulates the effect of smoke in a Smoke Detector which it could experience in a real fire.

A DETECTOR THAT FAILS TO ACTIVATE WITH ANY OF THESE TESTS SHOULD FIRST BE CLEANED AS OUTLINED IN THIS MANUAL'S MAINTENANCE SECTION. IF THE DETECTOR STILL FAILS TO ACTIVATE, RETURN FOR REPAIR.

MAINTENANCE

TEST ONCE A WEEK.

WARNING! USE ONLY BATTERIES SPECIFIED. USE OF DIFFERENT BATTERIES MAY HAVE A DETRIMENTAL EFFECT ON THE SMOKE DETECTOR.

The smoke chamber in the Smoke Detectors automatically tests itself every 16 seconds. If the chamber is degraded, it will beep twice every 48 seconds with 2 yellow LED flashes at the same time. If this happens clean the unit. If the beeping persists and the beep does not coincide with a yellow light flash, contact your dealer for service.

Dust and Insect Contamination

All Smoke Detectors and particularly the optical (photoelectric) type are prone to dust and insect ingress which can cause false alarms.

The latest design, materials and manufacturing techniques have been used to minimize the effects of contamination. However, it is impossible to completely eliminate the effect of dust and insect contamination, and therefore, to prolong the life of the Detector you must ensure that it is kept clean so that excess dust does not build up. Any insects or cobwebs in the vicinity of the Smoke Detector should be promptly removed.

Excessive dust may cause the unit to fault with 4 amber flashes every 48 seconds and 4 chirps with 4 flashes on test button.

In certain circumstances even with regular cleaning, contamination can build up in the smoke sensing chamber causing the Detector to sound. If this happens contact your dealer for servicing or replacement.

Contamination is beyond our control, it is totally unpredictable and is considered normal wear and tear. For this reason, contamination is not covered by the warranty.

YOUR DETECTOR SHOULD BE CLEANED AT LEAST ONCE A YEAR.

To clean your Detector, remove it from the mounting base. You can clean the interior of your detector by using compressed air or vacuum cleaner hose and blowing or vacuuming through the openings around the perimeter of the detector. The outside of the detector can be wiped with a damp cloth.

After cleaning, reinstall and test your detector by using the test button. If cleaning does not restore the detector to normal operation the detector should be replaced.

WARNING: Do not paint your Detector.

Other than the maintenance and cleaning described in this manual, no other customer servicing of this product is required. Repairs, when needed, must be performed by authorized service personnel.

WARNING: PLEASE READ CAREFULLY AND THOROUGHLY

- NFPA 72 states:** Fire-warning equipment for residential occupancies are capable of protecting about half of the occupants in potentially fatal fires. Victims are often intimate with the fire, too old or too young, or physically or mentally impaired such that they cannot escape even when warned early enough that escape should be possible. For these people, other strategies such as protection-in-place or assisted escape or rescue would be necessary.
- A battery powered detector must have a battery of the specified type, in good condition and installed properly.
- Smoke detectors must be tested regularly to make sure the batteries and the alarm circuits are in good operating condition.
- Smoke detectors cannot provide an alarm if smoke does not reach the Detector. Therefore, smoke detectors may not sense fires starting in chimneys, walls, on roofs, on the other side of a closed door or on a different floor
- If the detector is located outside the sleeping room or on a different floor, it may not wake up a sound sleeper.
- Studies have shown that smoke and heat alarms may not awaken all sleeping individuals, and that it is the responsibility of individuals in the household that are capable of assisting others to provide assistance to those who may not be awakened by the alarm sound or those who may be incapable of safely evacuating the area unassisted.
- The use of alcohol or drugs may also impair one's ability to hear the smoke alarm. For maximum protection, a smoke detector should be installed in each sleeping area on every level of a home.
- Although smoke detectors can help save lives by providing an early warning of a fire, they are not a substitute for an insurance policy. Home owners and renters should have adequate insurance to protect their properties.