



2GIG® Security & Automation System

Edge Quick Start Guide

For Home Owners

10025595 Rev-X4

FCC ID:EF400169

IC:1078A-00169



Contents

Welcome to the 2GIG® Edge Security Panel	3
About this Guide	3
Support Services	3
Panel LED Behavior	4
Home Screen	5
System Settings	6
Emergency Button/Indicator	6
Smart Home Options	7
Home Button/Indicator	7
System Icons	8
Burglary Protection	9
Arm the System (Armed Stay Mode)	9
Arm the System (Away Mode)	10
Arm the System (Using the Alarm.com mobile app)	11
Bypass Sensors	12
Disarm the System (Armed Stay Mode)	13
Disarm the System (Armed Away Mode)	14
Disarm the System (Face Recognition Mode)	15
Disarm the System (Using the Alarm.com mobile app)	16
Using the Duress Code	17
In the Event of a Burglary Alarm	18
Cancel/Silence a False Burglary Alarm	18
Fire and Emergency Protection	19
In the Event of a Fire Alarm	19
Emergency Alarms	20
Deactivating an Emergency Alarm	21
Security Codes	22
Change the Master User or Duress Code	23
Edit a User Code	24
Face Recognition Setup	25
Bluetooth Setup	27
Smart Areas Settings	29
View Smart Areas	31
Wireless Network Settings	32
Set Sensor Chimes	33
System Tests	34
Limited Warranty	35
Waste Electrical and Electronic Equipment (WEEE) Statement	35
WARNINGS	36
Limitations of Alarm Products	36
Risk of Noise Induced Hearing Loss	36
Alarm Dealer Information	36

Welcome to the 2GIG® Edge Security Panel

This Quick Reference guide shows system owners how to use the basic features of the 2GIG Edge Security Panel. For more in-depth information, download the *Edge User Guide* from 2gig.com/dealers or visit <http://www.2gig.com>.

About this Guide

This guide is designed for use by home and business owners of the 2GIG Edge Security Panel from Nortek Security & Control LLC. It is recommended that the Edge Panel and all associated sensors and peripherals be professionally installed by an authorized 2GIG alarm dealer. For regulatory compliance, professional installation is required. For a list of dealers in your area, visit <http://www.nortekcontrol.com>.

Support Services

If you require technical assistance with the system, contact your 2GIG alarm dealer or visit your alarm dealer's website.

Copyright ©2020 Nortek Security & Control LLC. All Rights Reserved. U.S. Patent D727,857. Australian Patent No. 357098. Additional Patents Pending.

The 2GIG, Edge, GoControl, and Linear logos are registered trademarks of Nortek Security & Control LLC in the United States and/or other countries. Other Nortek Security & Control trademarks may also appear in these materials. Other names or brands may be claimed as the property of others. For more information, contact your 2GIG alarm dealer for pricing or visit www.nortek.com, www.nortekcontrol.com, or www.2gig.com.

Information in this document is subject to change without notice. The availability of particular products, services, and features may vary by region. Please check with your local dealer for further details and availability of language options.

No part of this publication may be reproduced, stored in a retrieval system, or transmitted in any form or any means electronic or mechanical, including photocopying and recording for any purpose other than the purchaser's personal use without the written permission of Nortek Security & Control.

Nortek Security & Control
5919 Sea Otter Place, Suite 100
Carlsbad, CA 92010
USA
800-421-1587

Panel LED Behavior

The Edge panel has a single LED light on top right corner. It's a multi-color LED that will flash Blue, White and Red, depending on the panel's status.



Alarm Status	AC Power LED Status	Default Battery Power LED Status
System Ready to Arm (all sensors closed)	Solid Blue	Blinking Blue
System Not Ready to Arm (one or more sensors open)	Solid White	Blinking White
Exit Delay Countdown / Armed	Blinking Red	Blinking Red
Entry Delay Countdown / In Alarm / Armed After Alarm	Flashing Red	Flashing Red

Home Screen

To wake the touchscreen, tap any area of the screen display. The touchscreen goes into sleep mode after two (2) minutes of inactivity. To change this setting to between *30 seconds* and *10 minutes*, access the **Screen** option in the Settings menu (⚙️) and then change the **Screen Timeout** setting. See **System Settings**, next page.

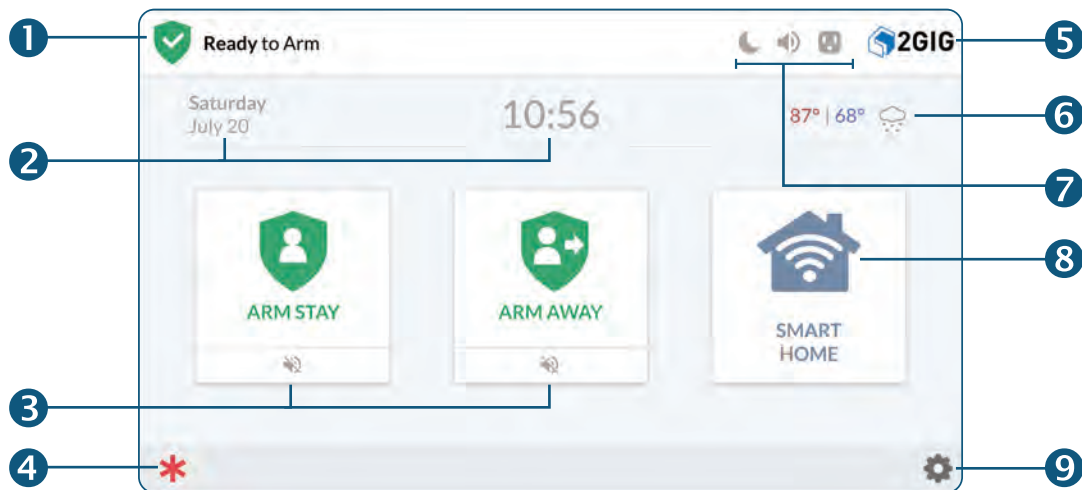

- | | |
|---|--|
| 1 System Status: Reveals the system state: <i>Ready to Arm</i> , <i>Not Ready to Arm</i> , etc. | 6 Current Weather: Displays daily forecast. Tap to view 5-day detailed forecast. |
| 2 Date/Time: Shows the system date/time. | 7 System Icons: Indicates system information. See page 7 . |
| 3 Arming Features: Tap <i>Arm Stay</i> or <i>Arm Away</i> to arm the system. See Burglary Protection on page 9 . | 8 Smart Home: Tap for Smart Home options. See page 6 . |
| 4 Emergency Icon: Tap for access to <i>Panic</i> , <i>Fire</i> and <i>Emergency</i> buttons. | 9 Settings Icon: Tap for access to the Settings menu (next page). |
| 5 System Logo: Tap and enter the Duress Code to transmit a user duress report to the Central Station. See page 17 . | |

System Settings

The **Settings Icon** is located at the bottom/right of the display.

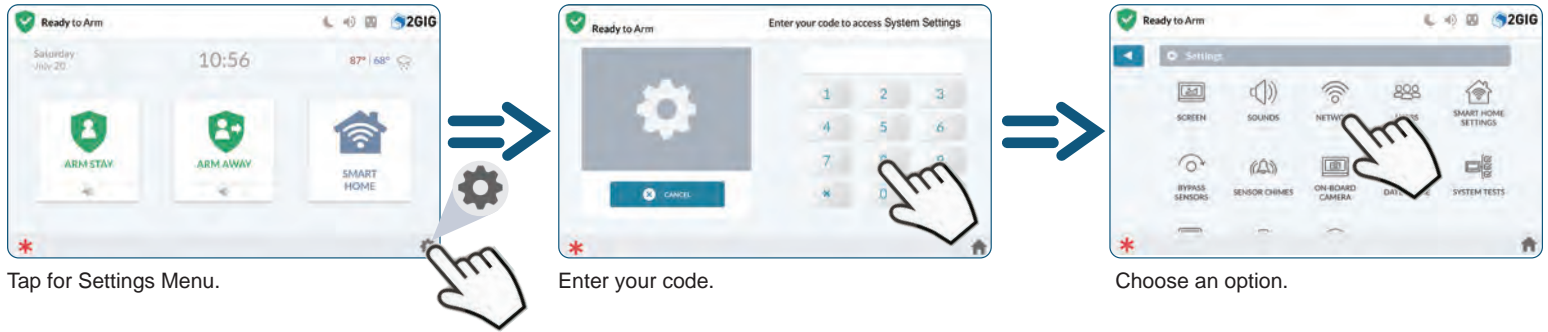

Emergency Button/Indicator

Announce an emergency event by manually activating the alarm at the control Panel.

This button is available on most displays (other than some system setup menus) for access to **Panic**, **Fire** or **Emergency** alarms.

See **Emergency Alarms**, [page 20](#).



Smart Home Options

The **Smart Home button** is located on the main display. When selected, the Smart Home options menu is displayed.

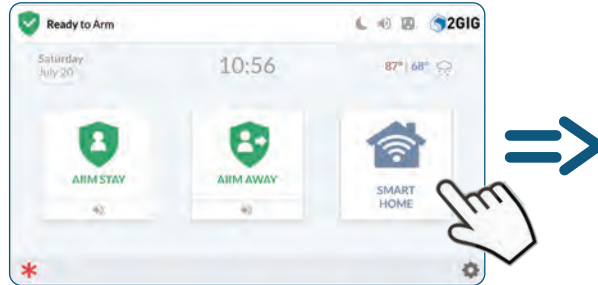

Tap the Smart Home option.

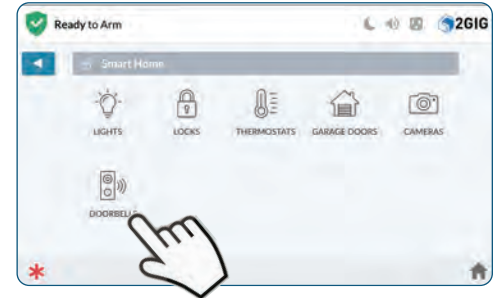

Choose a Smart Home option.

Home Button/Indicator

The **Home button** is located at the bottom/right of most displays. When selected, you'll return to the Home screen.

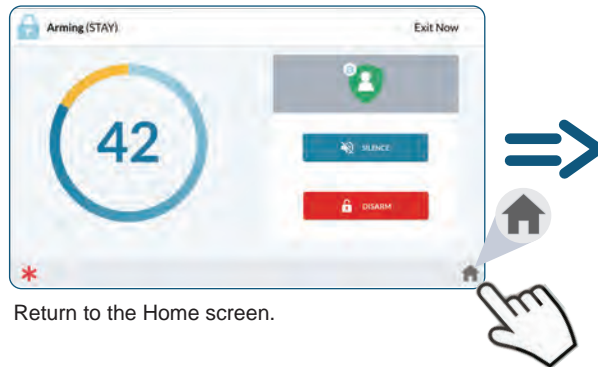

Return to the Home screen.

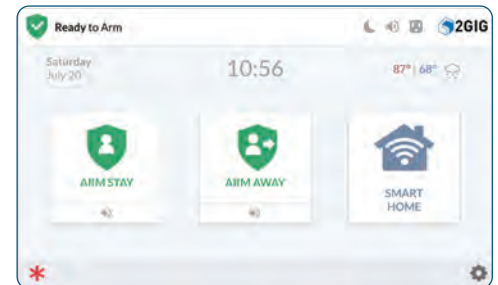











System Icons

The status bar that appears on the top of the Home screen and on most system menus reveals a variety of icons providing system information and access to different functions.



System Icons

 Battery Power Status	 Power Disconnected
 Battery Charging	 Screen
 Camera	 Sound On
 Notifications	 Sound Off
 Power	 Update

Burglary Protection

Arm the System (Armed Stay Mode)

Apply this mode when people and/or pets will be staying inside. Perimeter zones (doors and windows) are armed, leaving the interior zones (motion detectors) disarmed.

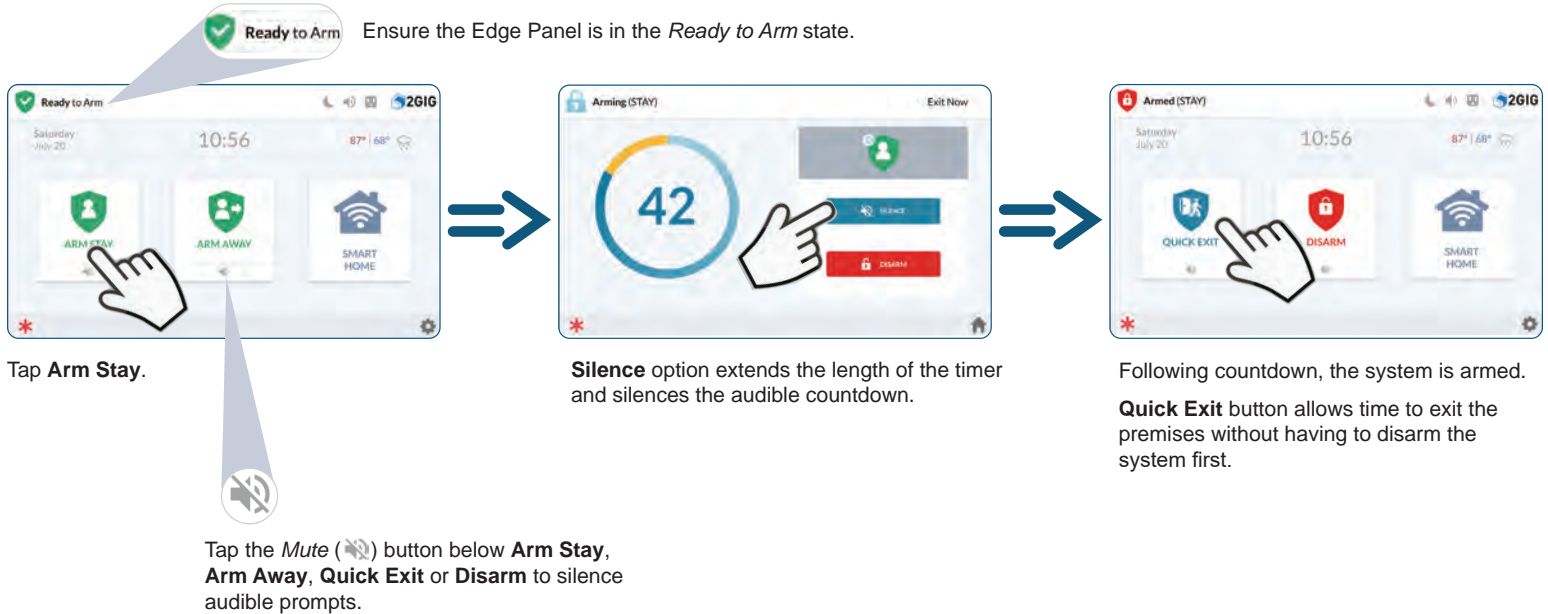

Arm the System (Away Mode)

Apply this mode when all people and pets will be leaving the premises. Both the perimeter zones (doors and windows) and the interior zones (motion detectors) are armed.

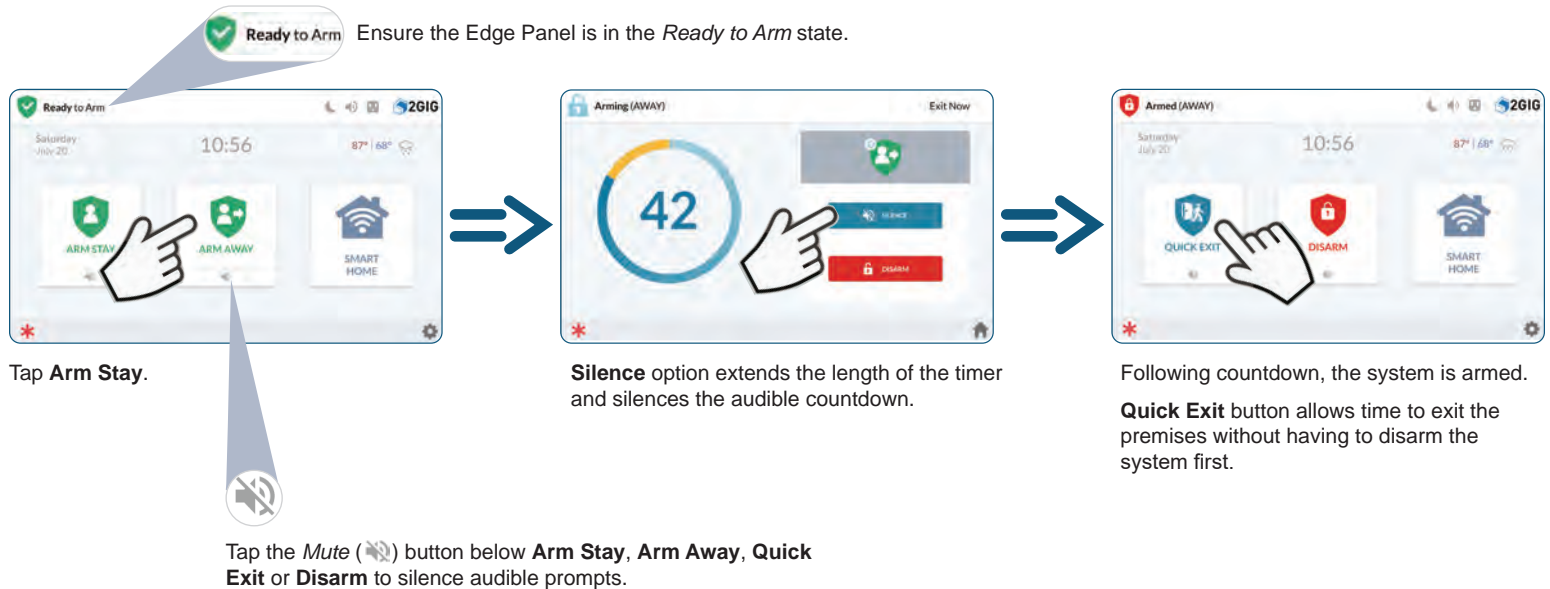

Arm the System (Using the Alarm.com mobile app)

When the system is disarmed, the Disarmed screen (🛡️) is displayed.

To disarm the system with the Alarm.com mobile app:

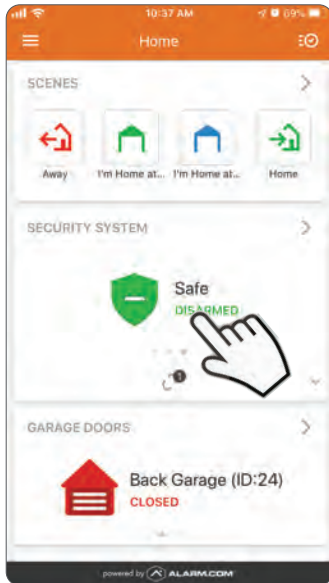

At the Disarmed screen, tap **Disarmed**.

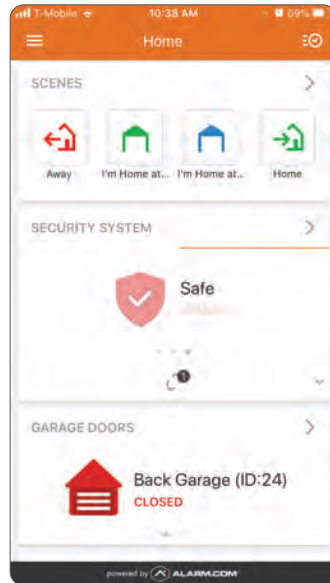

The app initiates the Arming process.

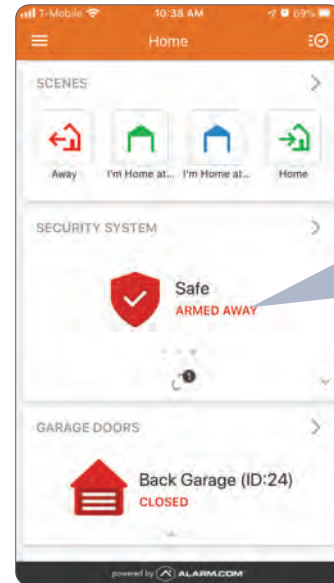

ARMED (STAY/AWAY) is displayed with a red icon (🛡️).

Bypass Sensors

When you open a protected door or window, the *Not Ready to Arm* message appears and reveals the zone in YELLOW on the **Sensors Not Ready** list. Before you can arm the system, place the system into the *Ready to Arm* state by (1) walking to the sensor and closing it, or (2) bypassing the sensor(s).

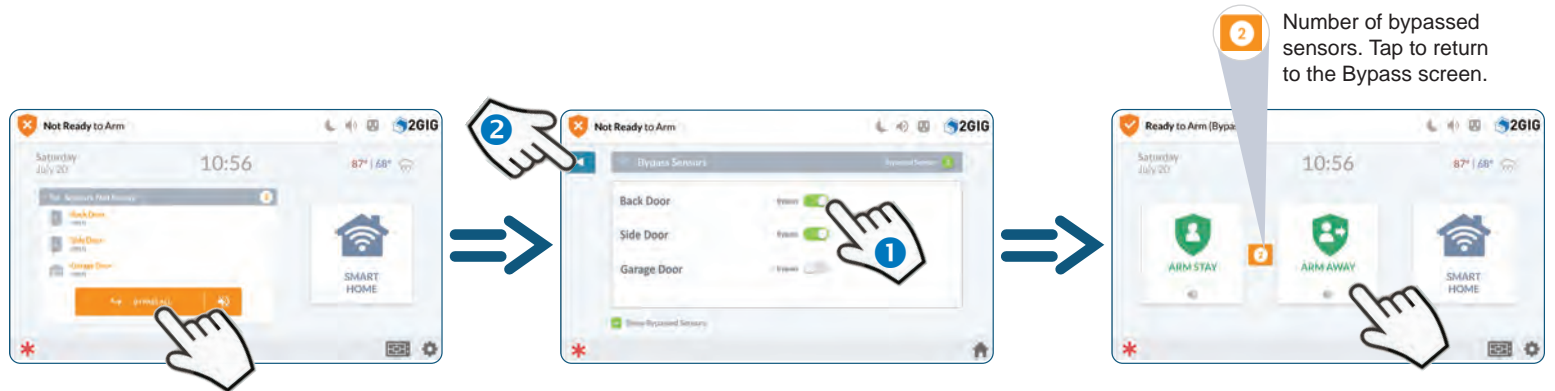

Tap the **Bypass All** button.

1. Enable the **Bypass** option(s) to bypass selected sensors.
2. Press the back button ().

The system is now ready to arm with selected sensors bypassed.

Disarm the System (Armed Stay Mode)

When the system is armed in *Armed (Stay) Mode*, the Armed (Stay) screen is displayed.

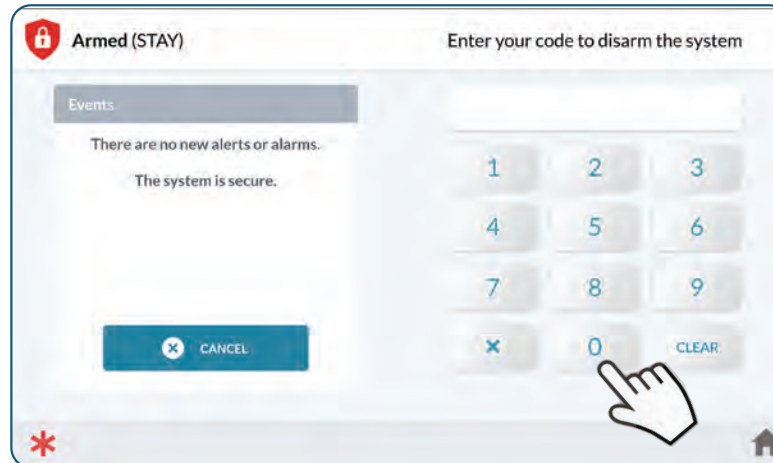

Enter your code to disarm the system.

Disarm the System (Armed Away Mode)

When the system is armed in Armed (Away) Mode, the Armed (Away) screen is displayed.

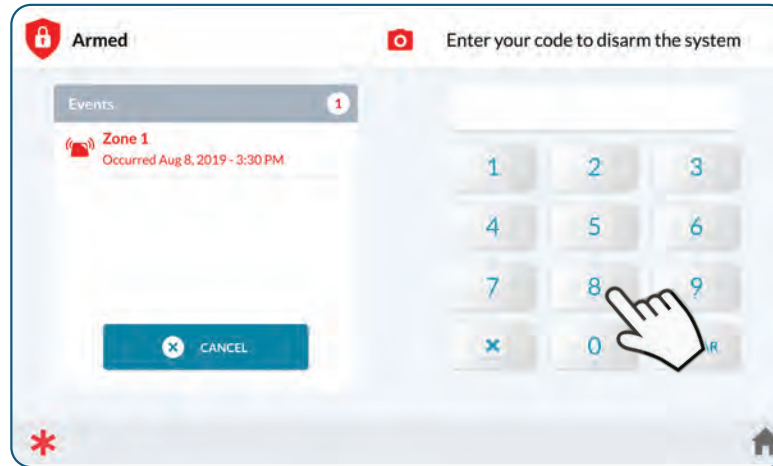

Enter your code to disarm the system.

TIP: If a false burglary alarm is activated while the system is armed (for example, someone inadvertently opens a protected door/window) and you want to cancel or silence the alarm, see "If You Want to Cancel/Silence a False Burglary Alarm " on [page 17](#).

Disarm the System (Face Recognition Mode)

When the system is armed is Armed, the Armed (Stay or Away) screen is displayed.

To disarm the system with Face Recognition:

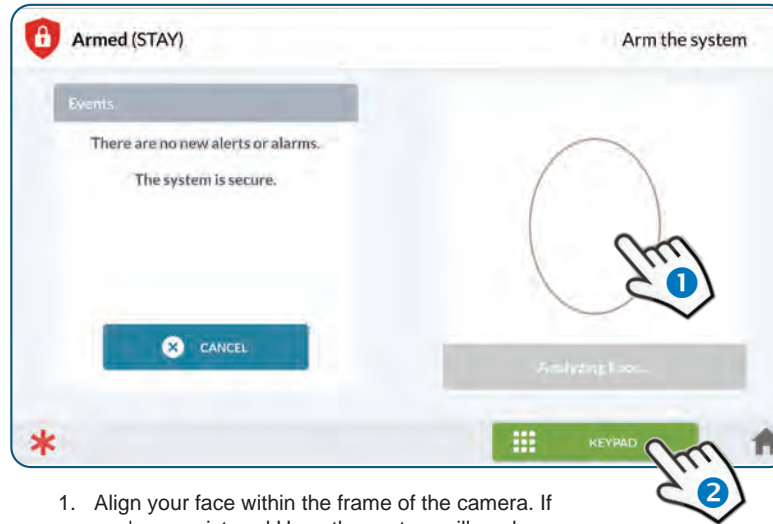

1. Align your face within the frame of the camera. If you're a registered User, the system will analyze your face and disarm.

OR

2. Press the **Keypad** button to access the keypad and disarm using your code.

Disarm the System (Using the Alarm.com mobile app)

When the system is armed, the Armed (Stay or Away) (🛡️) screen is displayed.

To disarm the system with the Alarm.com mobile app:

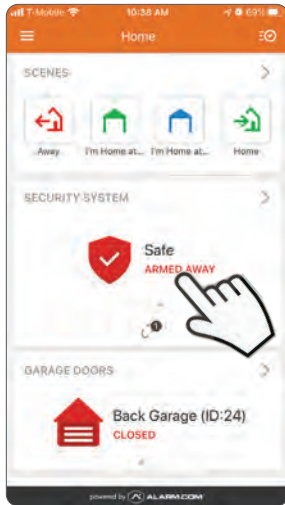

Tap the Armed button.

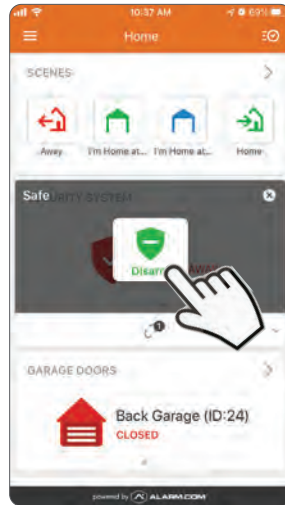

Tap **Disarm**.

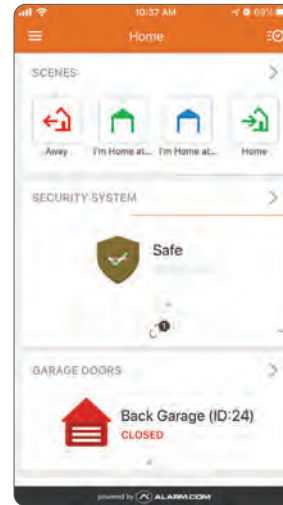

The app initiates the Disarming process.

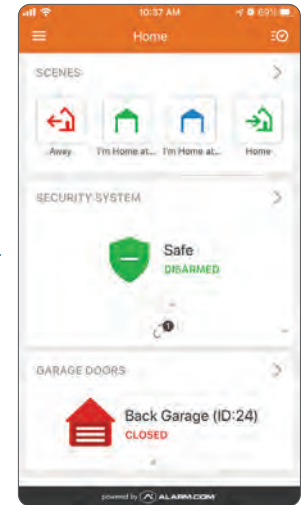

DISARMED displayed with a green icon (🛡️).

Using the Duress Code

To transmit a user duress report to the Central Station (for example, being held by an unwanted intruder against your will), use the steps below to input your system's unique Duress Code. The Central Station is notified that you are in a duress situation. The intruder will be unaware that you have contacted your provider for assistance.

For added security, disable *Bluetooth Disarming* and *Face Recognition* options in **Bluetooth Settings** (see [page 27](#)).

To learn how to create a unique Duress Code for your system, see “**Change the Master User or Duress Code**” on [page 21](#).

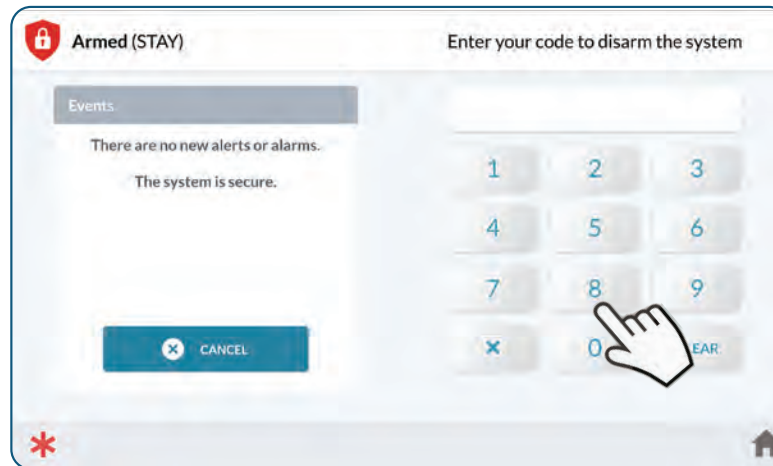

Enter the **Duress Code** (different from your disarm code).

In the Event of a Burglary Alarm

Sensor Type	Action	Default Time Setting
Instant Sensor	Alarm siren immediately sounds and continues to sound until a User Code is entered or for the amount of time specified by the <i>Burglary Bell Cutoff Time</i> setting	Four (4) minutes. Consult your installer to determine the cutoff time for your system.
Delayed Sensor	Countdown allows time to disarm the system before the siren sounds. Siren continues to sound until a User Code is entered or until the amount of time specified by the <i>Burglary Bell Cutoff Time</i> setting.	30 second countdown Consult your installer to determine the length of the countdown.

After the report is received by the Central Station, an operator will respond per the terms defined in your individual Service Agreement with your alarm dealer. For more in-depth information about specific alarm protocols, contact your alarm dealer.

Cancel/Silence a False Burglary Alarm

In the event of a false alarm (for example, if you enter the home while it is armed and do not disarm the system before the countdown expires), you can silence the alarm and cancel the alarm report using one of these options:

When Disarmed...	Result	Default Time Setting
Disarming the system BEFORE the countdown expires	The system silences the alarm and does not transmit an alarm report to the Central Station.	N/A
If you disarm the system AFTER the Abort Window Dialer Delay countdown expires	The system silences the alarm siren and transmits an alarm cancellation report to the Central Station. For a cancellation report to be transmitted, you must disarm the system before the <i>Alarm Cancel Time</i> expires.	Five (5) minutes Consult your installer to determine the setting for your system.

Fire and Emergency Protection

Smoke and Carbon Monoxide (CO) detectors may be installed to protect the occupants of the dwelling from harmful, and possibly deadly effects of smoke, heat, and fire-related dangers. The system's fire and emergency protection features are always protecting the premises. See **Warnings**, [page 34](#).

NOTE: A professional installer must ensure that all Smoke/Heat alarms and CO detectors are installed in compliance with all national, regional, and local laws, statutes, and guidelines.

In the Event of a Fire Alarm

In the event an installed fire protection zone detects an issue, the following will occur:

1. The alarm siren immediately sounds and continues to sound until a User Code is entered or for the amount of time specified by the *Fire Bell Cutoff Time* setting. The factory default setting is four (4) minutes. Consult your installer to determine the cutoff time that has been configured for your system.
2. After the report is received by the Central Station, an operator will respond per the terms defined in your individual Service Agreement with your 2GIG alarm dealer. For more in-depth information about specific alarm protocols, contact your alarm dealer.

If a fire alarm is activated, the system emits a warning siren and immediately reports a fire to the Central Station. To protect yourself and occupants do the following:

1. If flames or smoke are present, yell "Fire!" to alert all occupants of a fire.
2. Immediately evacuate all occupants from the premises and remain at a safe distance away from the premises.

DANGER: To protect yourself and others from serious injury and/or death, do NOT reenter the premises until it has been deemed safe by emergency officials.

3. Dial 9-1-1 (or your region's emergency services number) to report the situation to authorities. Always wait to call from a safe location.

NOTE: It is important to establish and practice an Escape Plan with all members of your household in the event of a fire. For more in-depth information, see the *Edge User Guide*.

Emergency Alarms

You can notify the Central Station of an emergency event by manually activating the alarm at the control Panel. The Alarm button is designed with a double-action trigger. This reduces the risk of inadvertently transmitting a false alarm to the Central Station.

To activate a manual alarm:

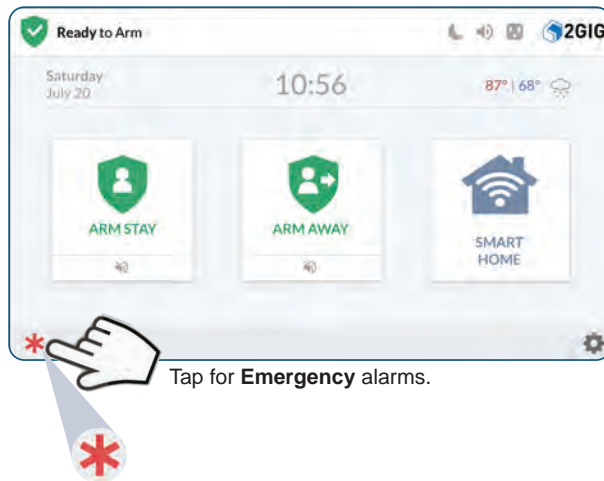

Tap for **Emergency** alarms.

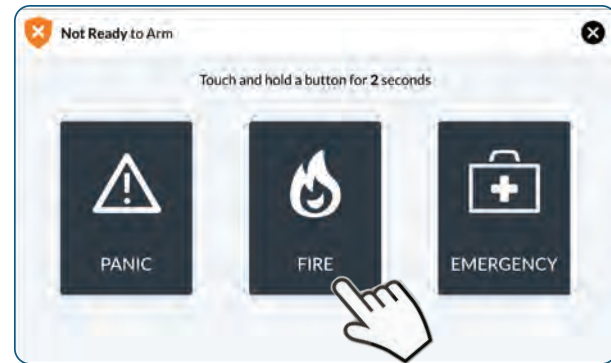

Press and hold
for 2 seconds.

Deactivating an Emergency Alarm

The panel appears red at the top of screen during an Emergency Alarm.

To deactivate a manual alarm:

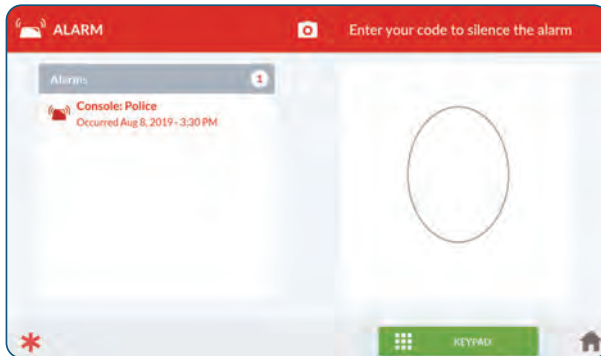

Align your face within the frame of the camera. If you're a registered User, the system will analyze your face and set the Alarm.

You can also press the **Keypad** button to access the keypad and deactivate the alarm using your code.



The active alarm will be displayed. Tap **Clear Alarm History** to deactivate the alarm.

Security Codes

The system supports a total of 101 unique security codes, which includes the types of security codes detailed below and one (1) Installer Code which is reserved for use by 2GIG alarm dealers and their professional installers. See **Change the Master User or Duress Code**, next page.

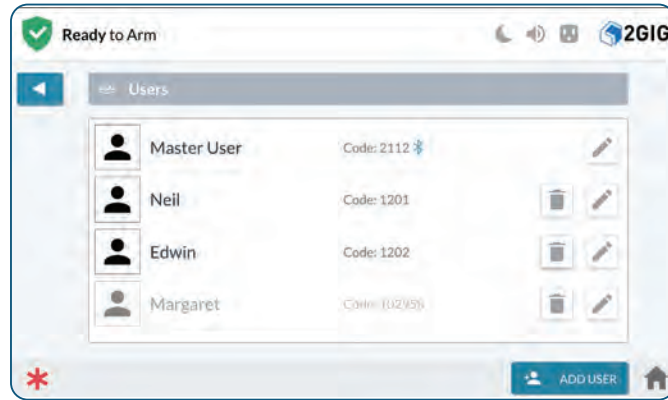

Types of Security Codes	Description	Default Code
Master User	One (1) Master User Code is available for accessing the System Settings and other PIN-protected features. Be certain to change the default code to a unique four (or six) digit number.	4 digit (1111), 6 Digit (111111) Consult with your dealer regarding a four or six pin code length.
Duress	One (1) Duress Code is available. To protect your system, the Master User should always change the default code to a unique code known only by trusted system users. See "Change the Master User or Duress Code" in the next section. See If You Need to Use the Duress Code , page 16 .	User defined
User	Create up to 98 unique user access codes used by occupants to arm and disarm the system. See Security Codes , page 20 .	User Defined
Smart Areas	If Smart Areas are enabled, a user can be assigned to one or more areas.	User Defined

Change the Master User or Duress Code

The *Master User Code* provides users with the ability to access the **System Settings** menu and, depending on your system configuration, provide access to other pin-protected features. The *Duress* code lets users send a silent duress report to the Central Station. See **If You Need to Use the Duress Code** on [page 16](#).

IMPORTANT: When customizing codes for your system, it's best not use the dwelling's physical address, telephone digits, birth dates or birth years. Codes should only be given to trusted individuals.

Tap **System Settings** (⚙️) from the Main screen, enter the system's Master User Code, and then tap the **Users** (👤) icon. Next, continue with these steps:

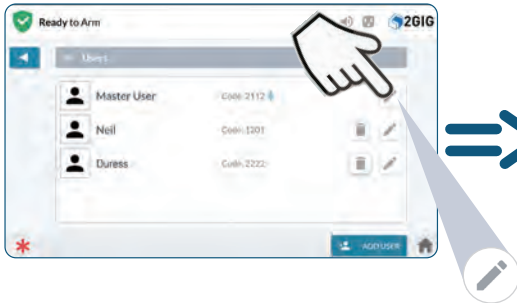
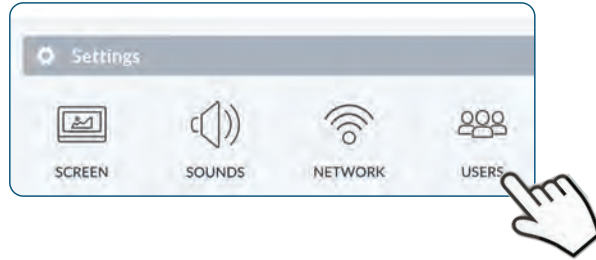

At the Users screen, tap the pencil icon (✎) next to **Master User** or **Duress**.

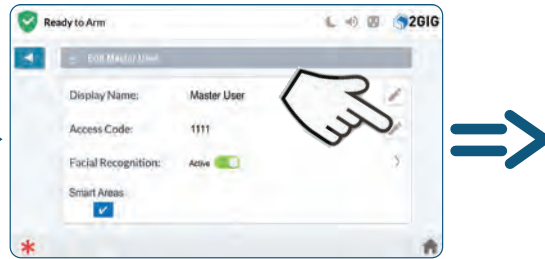

At the **Edit Master User** or **Edit Duress User** screen, tap the pencil icon (✎) in the Access Code section.



At the Enter a Code for the User screen, input a unique code and tap **Next**. Then, confirm the code and tap **Done**.

Edit a User Code

Once a user has been created, you can adjust that users access to the system or individual areas.

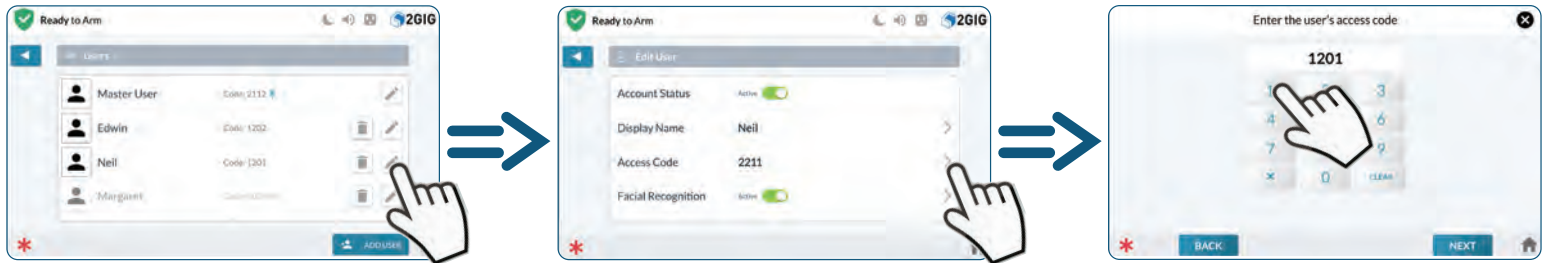

At the Users screen, tap the pencil icon ().

Tap the arrow () adjacent to the Access Code.

At the *Enter the user's access code* screen, input a unique code and tap **Next**. Then, confirm the code and tap **Done**.

Face Recognition Setup

At the User's screen, you can edit Users to include the panel's Face Recognition feature.

Tap **System Settings** (⚙️), enter the system's Master User Code and then tap the **Users** (👤) icon.

Next, continue with these steps:

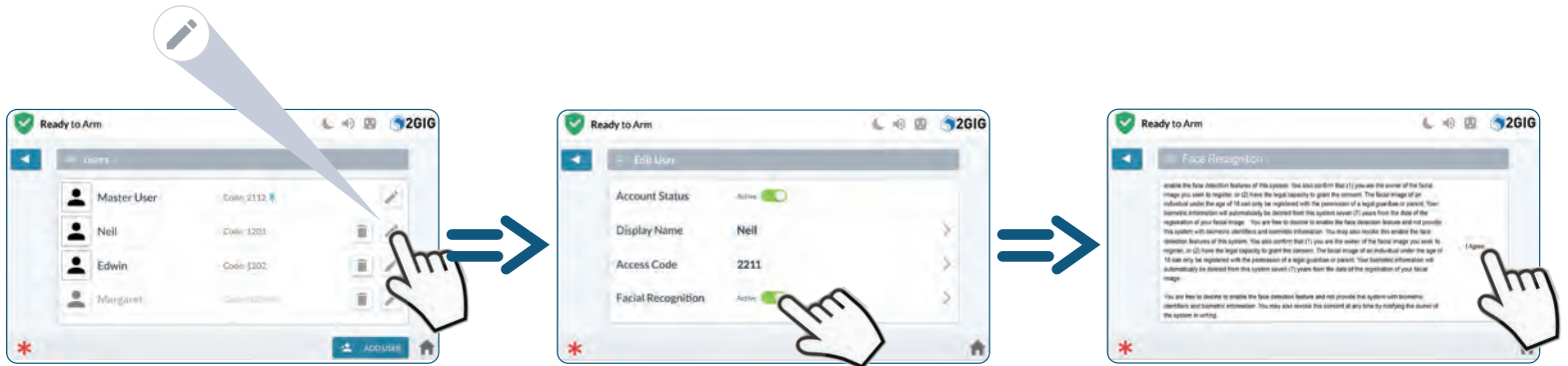
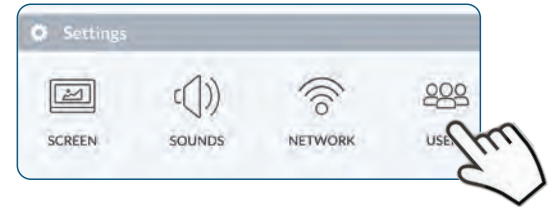

1. At the Users screen, tap the pencil icon (✎) next to a User.

2. Tap the switch adjacent to the Facial Recognition option to set it to **Active**.

3. Read the *Biometric Information Privacy Policy and Consent* form, use your finger to scroll down then tap **I Agree**.

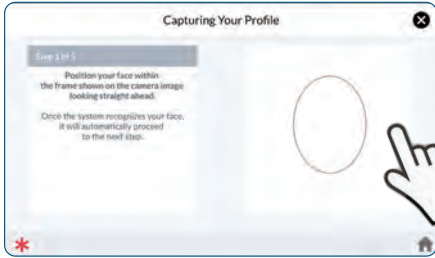

4. On-screen instructions guide you through the process of capturing your profile.



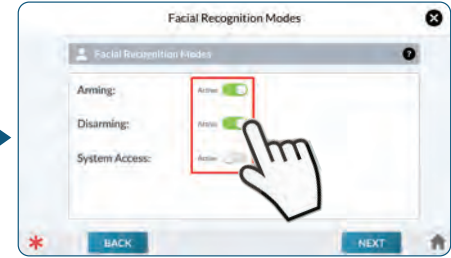

5. Steps 2 through 5 will instruct you to slightly move your head in four specific directions to complete the face recognition process.

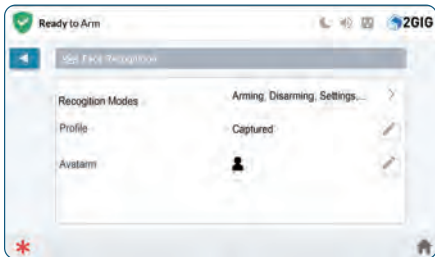

6. Tap the activation switch adjacent to the Recognition Modes you'd like to use with Face Recognition, then tap **NEXT**.



7. Your selections and profile status are summarized. Tap the pencil icon () if you'd like to edit. Press the back button () to return to the previous menu.

TIP: The holder of the Master User Code can also create user code access schedules for users who only need access to a dwelling during certain hours. For example: au pairs, housekeepers, and personal assistants. For more in-depth information, refer to the 2GIG Edge User Guide.

Bluetooth Setup

You can setup the control panel to connect with your smart phone for Bluetooth Disarming.

Tap **System Settings** (⚙️), enter the system's Master User Code, and then tap the **Users** (👤) icon. Next, continue with these steps:

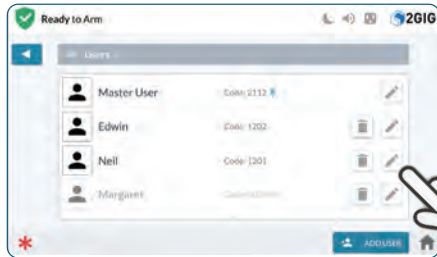
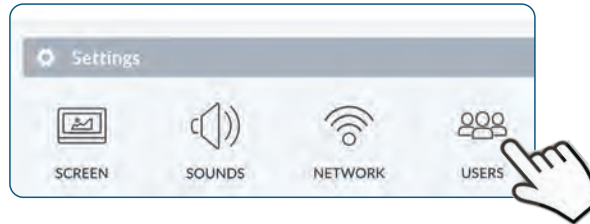

1. At the Users screen, tap the pencil icon (✎).

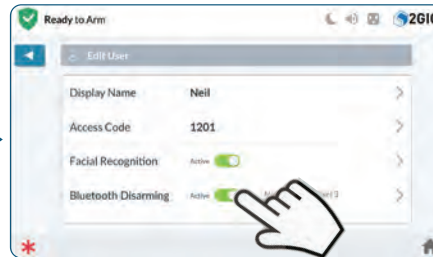

2. Scroll down to the *Bluetooth Disarming* option, then tap the adjacent switch to the "Active" setting.



3. At the *Enter the user's access code* screen, input a unique code and tap **Next**. Confirm the code, and tap **Done**.

Bluetooth Setup (continued)

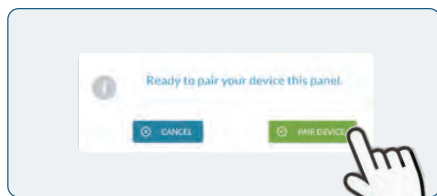

4. Tap **PAIR DEVICE**.

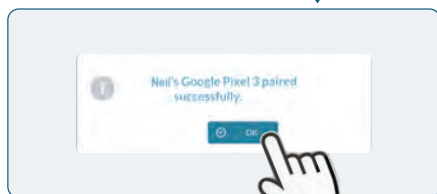
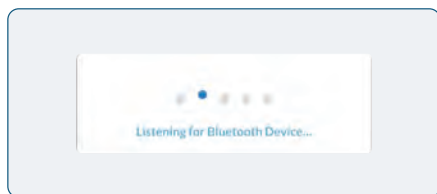

5. Once paired, tap **OK**.



6. Enter your pairing code from your smart phone.

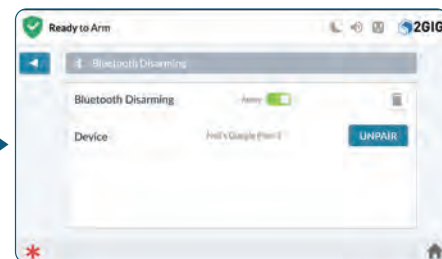

7. Your device is paired. Press the back button () to return to the previous menus.

Smart Areas Settings

Smart Areas allow homeowners to create up to four independently controllable and manageable areas (For example: Main House, Garage, Room Rental, etc). Flexible user interface limits control of the Smart Areas at the user code level.

Note: Smart Areas must be enabled to view the Smart Areas tile on the home screen. For more details, refer to the Edge Users Guide and consult your alarm dealer.

To set Smart Areas settings:

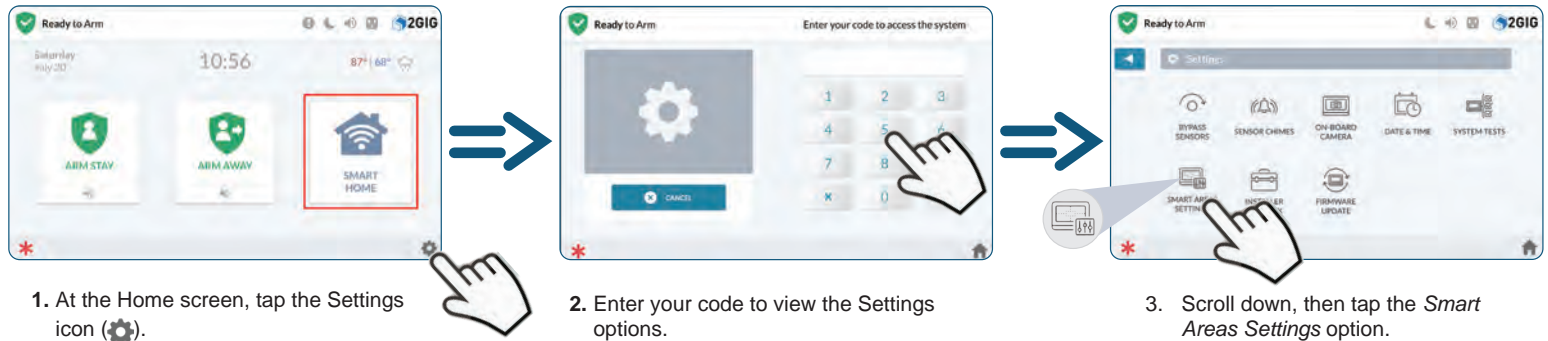

Smart Areas Settings (continued)



4. Tap the arrow (>) adjacent to a Smart Areas option.



5. Enter a name for the new Smart Area, then select **SAVE**.

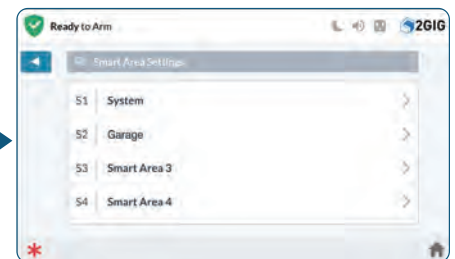

6. Repeat the naming process for all new Smart Areas.

View Smart Areas

View and change state of Smart Areas.

Note: Smart Areas must be enabled to view the Smart Areas tile on the home screen. For more details, refer to the Edge Users Guide, or consult your alarm dealer to enable Smart Area.

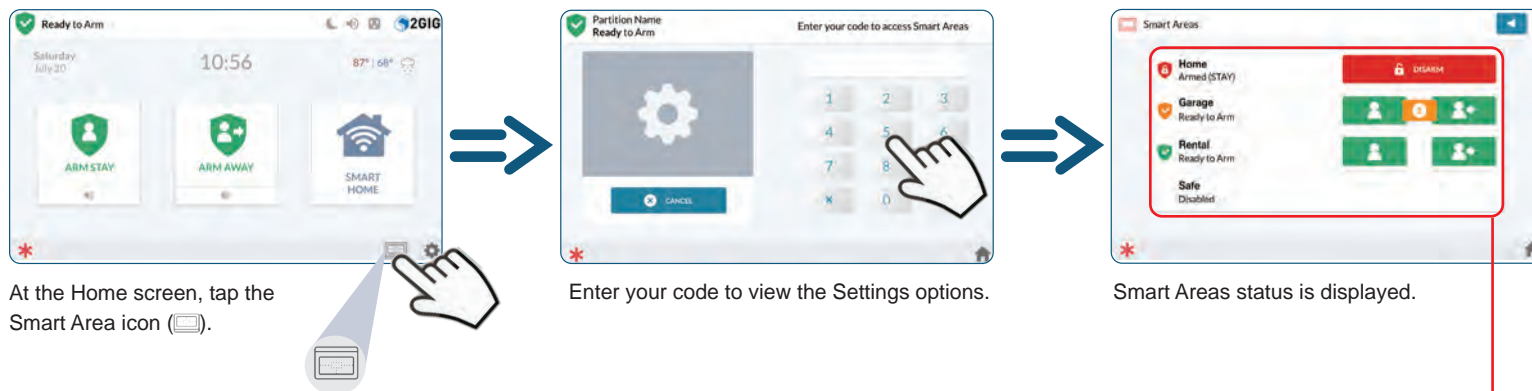

Smart Areas Status

- Home :** Armed (STAY).
- Garage:** Disarmed with Bypassed Zones.
- Rental :** Disarmed.
- Safe :** Disabled.

Wireless Network Settings

To set wireless network settings:

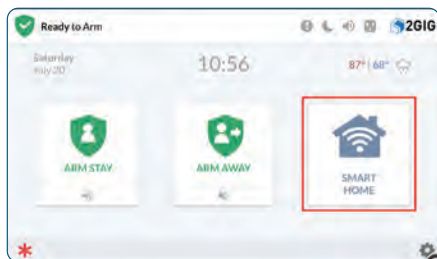

1. At the Home screen, tap the Settings icon (⚙️).

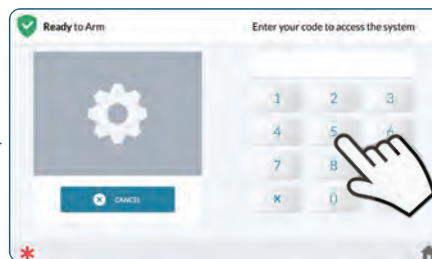

2. Enter your code to view the Settings options.



3. Tap the *Network* option.



4. Tap the Wireless Option.



5. Choose your Wireless Network name.



6. Type in your Network Password. Once you're successfully connected, press the back button (⬅️) to return to the previous menus.

Set Sensor Chimes

To set individual chimes for each zone use the sensor chime menu:

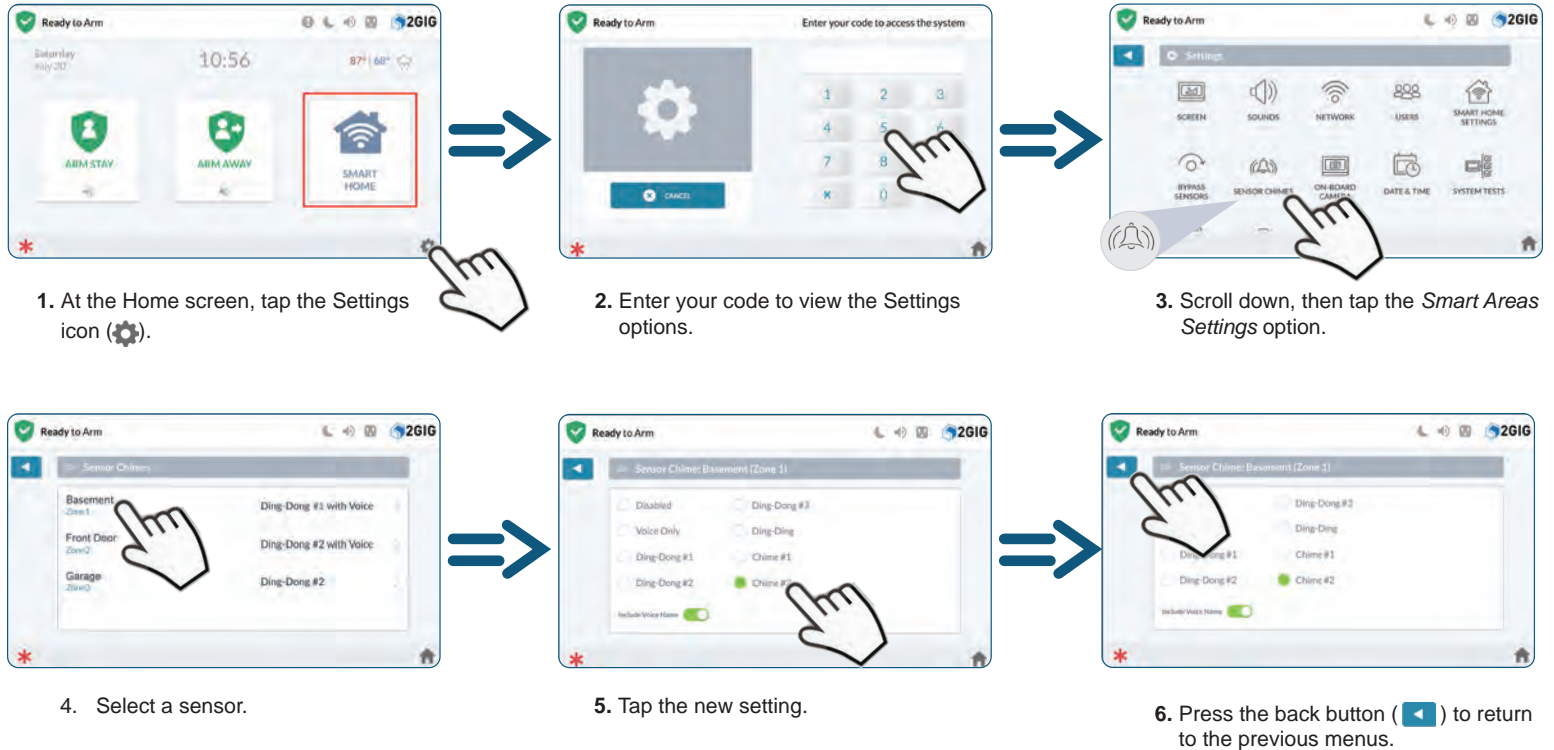

System Tests

To ensure continued protection and proper system operations, it is important to perform a sensor and console test on a weekly basis.



Sensor Test: Tests signals between the Control Panel and installed sensors.

Panel Test: Tests the function of the Edge Panel's audio and buttons.

Limited Warranty

This product is warranted against defects in material and workmanship for two (2) years. The battery is limited to One (1) year. This warranty extends only to wholesale customers who buy directly from Nortek Security & Control LLC or through Nortek Security & Control's normal distribution channels. Nortek Security & Control LLC does not warrant this product to consumers. Consumers should inquire from their selling dealer as to the nature of the dealer's warranty, if any.

Refer to Nortek Warranty policy on www.2gig.com or www.nortekcontrol.com.

There are no obligations or liabilities on the part of Nortek Security & Control LLC for consequential damages arising out of or in connection with use or performance of this product or other indirect damages with respect to loss of property, revenue, or profit, or cost of removal, installation, or re-installation. All implied warranties for functionality are valid only until the warranty expires. This Nortek Security & Control LLC Warranty is in lieu of all other warranties, expressed or implied.

All products returned for warranty service require a Return Authorization Number (RA#). Contact Returns at 1-855-546-3351 for an RA# and other important details.

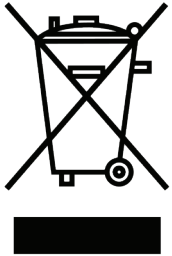

Waste Electrical and Electronic Equipment (WEEE) Statement

This symbol on a product or on its packaging indicates that this product is not to be thrown away with everyday waste.

Instead, it is your responsibility to dispose of electrical and electronics equipment by handing it over to a designated collection point for the recycling of waste electrical and electronic equipment (W.E.E.E.). The separate collection and recycling of your waste electrical and electronic equipment at the time of disposal will help to conserve natural resources and ensure that it is recycled in a manner that protects human health and the environment. For more information about where you can drop off your waste equipment for recycling, please contact your local city office, or your household waste disposal service, or the shop where you purchased the product.

WARNINGS

Limitations of Alarm Products

This product should be tested periodically to make sure it is working properly. The product, if used properly, may reduce the risk of burglary, robbery, and other adverse events that have the potential to result in injury or loss of life; however, Nortek Security & Control is not an insurer. This product is neither insurance nor a guarantee that such an event will be prevented, and users should protect themselves with proper insurance. Nortek Security & Control makes no representation that this product cannot be compromised or circumvented, that it will provide an adequate warning, or that it will prevent any personal injuries, property damage, or other losses. Like any alarm product, it may be bypassed, it is subject to compromise, and it may fail to warn for a variety of reasons, including, but not limited to: improper installation or positioning; improper maintenance; tampering; dead or improperly installed batteries; sensing limitations; component failures; receivers; intrusions may be outside of a product's designated range and certain environmental conditions may impact performance, and audible alarm signals may be outside of hearing range, muted by doors, walls, and floors, unheard by deep sleepers or the hearing-impaired, or overwhelmed by other sounds.

Risk of Noise Induced Hearing Loss

The Alarm is equipped with a warning siren. Exposure to high sound levels or prolonged exposure to the warning siren can result in Noise Induced Hearing Loss (NIHL)

Alarm Dealer Information

Company Name:

Your Account Number:

Installation Date:

10025595 Rev-X4

2GIG® Security & Smart Home System 2GIG EDGE Installer Quick Start Guide

10029907 Rev-X2 | 2GIG-EDG-NA | Edge Panel



INTRODUCTION

This quick start guide introduces 2GIG alarm dealers and professional installers to 2GIG EDGE panel hardware installation and the Installer Toolbox. It describes the process of program zones, keyfobs, and keypads for the EDGE Panel and how to add and remove Z-Wave® devices from the network. To get started, navigate to the Installer Toolbox menu.

EDGE PANEL INSTALLATION

Choose the Location for the 2GIG EDGE Panel's Backplate

Before mounting the backplate, choose a location. Work with the end user to determine the best location. Always choose an indoor location protected from temperature extremes.

Recommended Tools and Equipment

To install the system, these tools and equipment are recommended:

- > 2-Conductor Power Wire (if connecting power supply to the panel's terminal block)
- > Drywall Saw (or equivalent)
- > Ladder
- > Magnetic Phillips Head Screwdriver
- > Screwdrivers
- > Staple Gun
- > Wire Stripper

Choose the Wall Location

To choose a wall location:

- > Always choose a location that is above ground and centrally located. Do NOT install the Panel below ground level, because wireless range may be impaired.
- > Do NOT connect the Panel to a light switch-controlled outlet.
- > Avoid choosing a location that can be easily viewed from doors or windows.
- > Avoid choosing a location that is within reach of small children.
- > Avoid choosing a location in direct sunlight.

NOTE: If necessary, the Panel can be mounted on a stand that can be placed on a flat surface, such as desk or counter using the 2GIG Desktop Kit. However, this option may affect compliance with state or regional codes. For 2GIG Desktop Kit installation instructions, refer to the 2GIG EDGE Installation Manual.

External Attic Mount Antenna Installation (Optional)

If you will be installing the optional External Attic Mount Antenna, refer to the 2GIG EDGE Installation Guide.

1. Align Backplate to Mark Hole Locations

Create mounting holes, and cut a slot in the dry wall for the AC power cord and other electrical wiring (if needed).

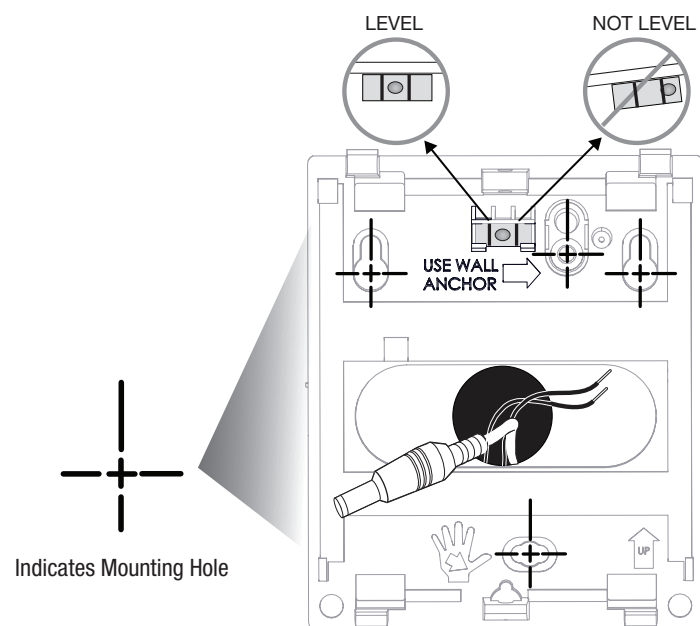

2. Mount the Backplate to a Wall

Use the four (4) wall anchors and screws (supplied).

NOTE: The Wall Anchor is the wall tamper and **MUST** be anchored to work.

Illustration displays both types of power connection:
Install the 2 - conductor power wires or Barrel Connector

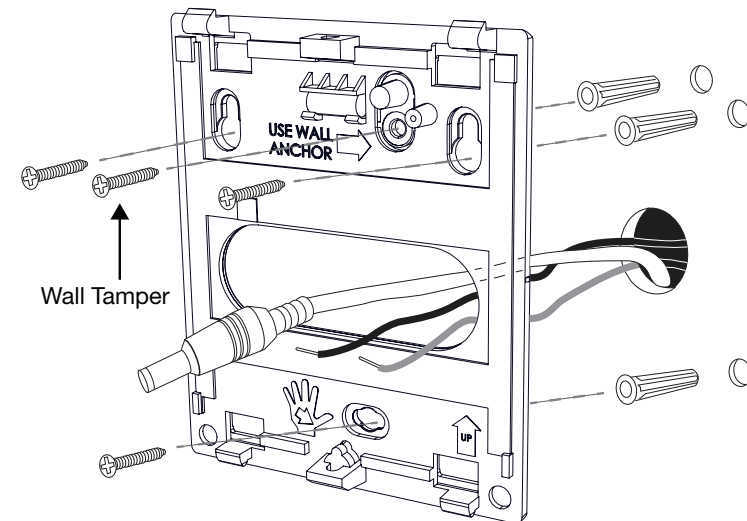

3. Hang the Panel for Wiring (optional)

Attach the panel's third-hand hanging strap to the hook at the bottom of the backplate for easy access during wiring.

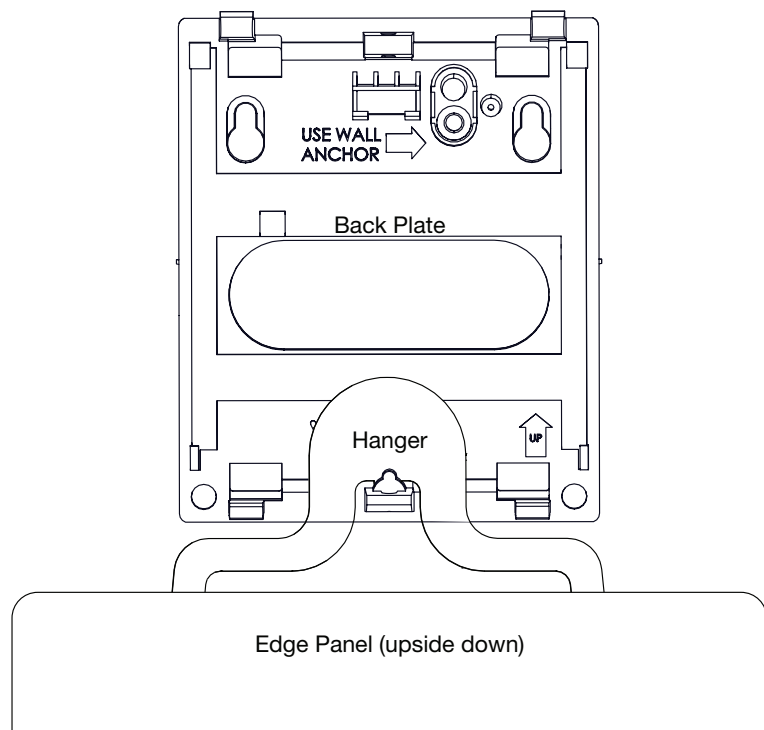

4. Connect the Power Wires (Terminal Block)

Locate a wall outlet for the plug-in power supply, but do NOT connect the power supply to the outlet at this time.

IMPORTANT: Never connect the plug-in power supply to a switch-controlled outlet. Do not over-tighten the terminal block's contact screws.

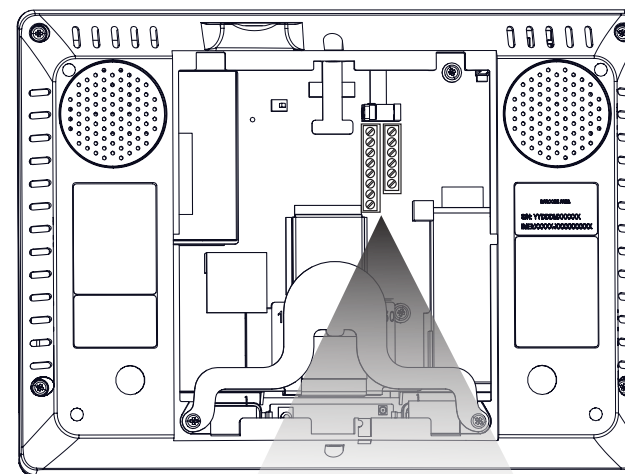

8	DC Out +	DC IN	
7	DC Out -	DC IN +	9
6	GRD	DC IN -	10
5	Bell +	OCL 1	11
4	Bell -	OCL 2	12
3	Zone 1	TX	13
2	Zone 2	RX	14
1	GRD		

5. Connect Power (Barrel Connector)

The Barrel connector is an alternate method for connecting the AC power supply for the EDGE Panel.

WARNING!! Do NOT plug the power supply into the outlet at this time.

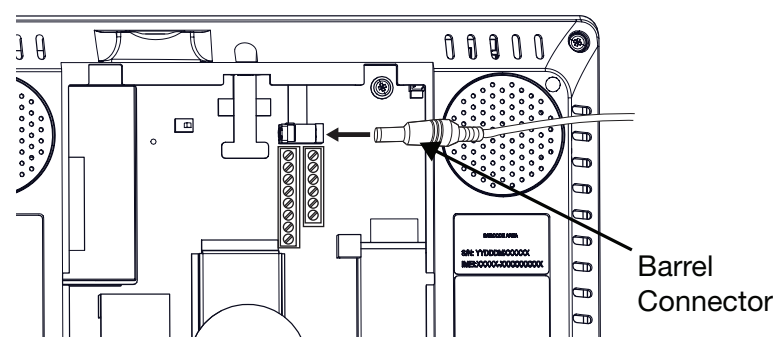

6. Connect the Backup Battery

Align pins, then carefully insert the battery cable.

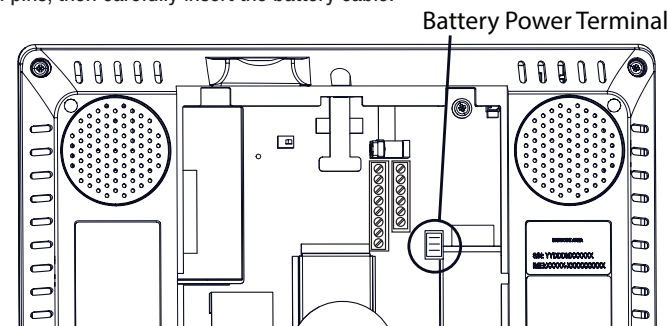

7. Hang the EDGE Panel

Place the backplate over the lower lip on the back of the chassis, and flip the EDGE panel upward and push until it clicks into place.

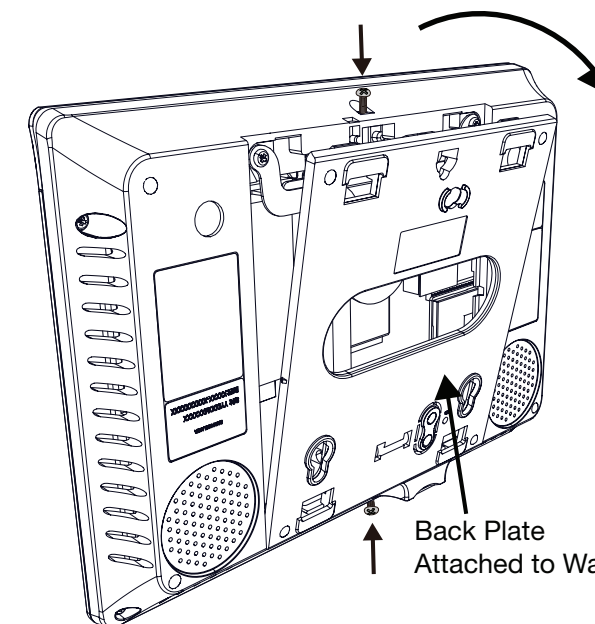

8. Install Retaining Wall Bracket and Connect the AC Power Supply

For compliance with ANSI/NFPA 70: National Electric Code in the United States, you must install the power supply retaining bracket (not required in Canada).

Standard Style – Center Fastener

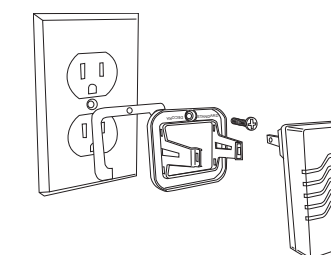

Decora Style – Center Fastener

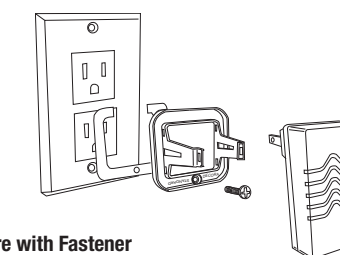

Secure with Fastener

Standard-Style Duplex Receptacle

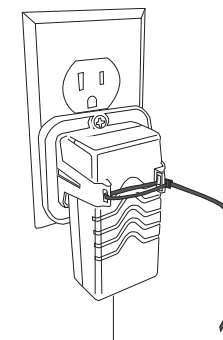

Decora-Style Duplex Receptacle

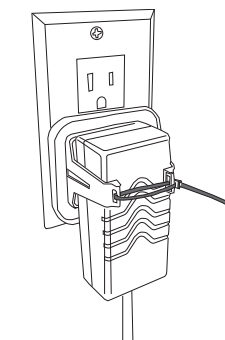

INSTALLER TOOLBOX

The Installer Toolbox is password-protected. To use this feature, you must enter an Installer Code. The factory default code is 1561. To access the Installer Toolbox:

1. Tap the Settings icon .
2. Tap KEYPAD.

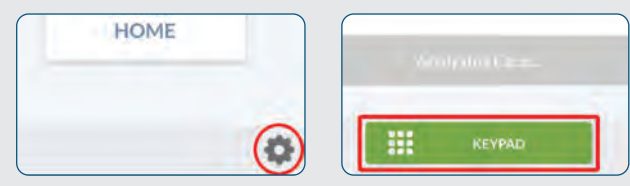

3. Enter 1561 to gain access to the panel settings, then tap Installer Toolbox.
4. Scroll down then tap the Installer Toolbox icon.



5. Tap Panel Programming to view programming options (see below).



PANEL PROGRAMMING – NETWORK SETTINGS

Setup Wireless

1. Tap a available *Network Name*.
2. Correctly enter the assigned network password to connect.
3. Tap  to go back to the Network Settings menu.

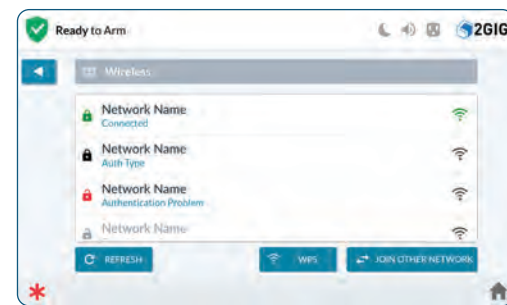

Setup the Access Point

1. Tap Network Settings.
2. Tap Access Point.
3. Enable Access Point:
 - > Optional: Tap to enter a new SSID name
 - > Optional: Tap to enter a new password
 - > Optional: Tap IP address. The last two octets of the Access Point can be changed to customize the setup.
4. If edits have been made, tap Save Settings to save.

Note: Make a note of SSID and Password for use in WiFi setup of SP1 and SP2 keypads.
5. Tap  to go back to the Network Settings menu.

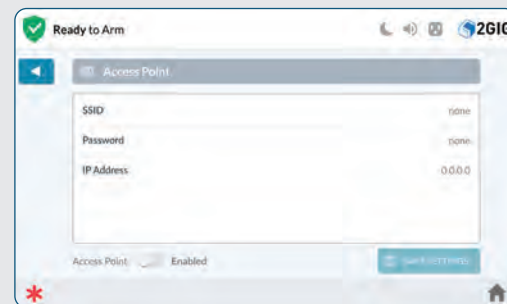

PANEL PROGRAMMING – WIRELESS ZONES

Program up to 100 wireless zones per system. Tap *Wireless Zones* to view the Wireless Zones screen.

Setup a Wireless Zone

- Left side of screen: Select a Wireless Zone [#].
- Right side of screen: Tap and highlight each of the available zones, then tap **EDIT ZONE** to view settings for the selected zone.

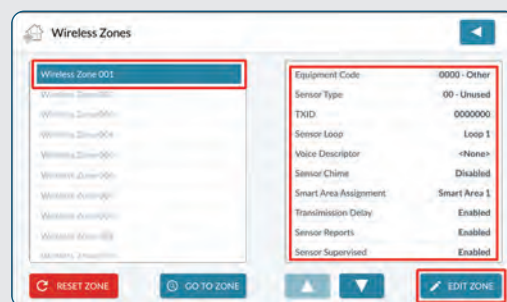

PANEL PROGRAMMING – BUILT-IN ZONES

You can program up to three (3) Built-In Zones per system. To get started, navigate to the *Installer Toolbox*. Tap *Panel Programming*, then tap the *Built-In Zones* option.

Selecting a Built-In Zone

Left side of screen: Select a Wired Zone [#].

Right side of screen: Tap and highlight each of the available zones, then tap **EDIT ZONE** to view settings for the selected zone.

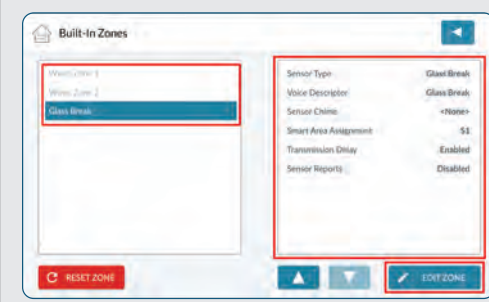

PANEL PROGRAMMING – KEYFOBS

Program up to 32 keyfobs per system. To begin, navigate to the *Installer Toolbox*, then tap *Panel Programming* then *Keyfobs*.

Select a Keyfob

Left side of screen: Select a Keyfob [#].

Right side of screen: Tap and highlight each of the available zones, then tap **EDIT ZONE** to view settings for the selected zone.

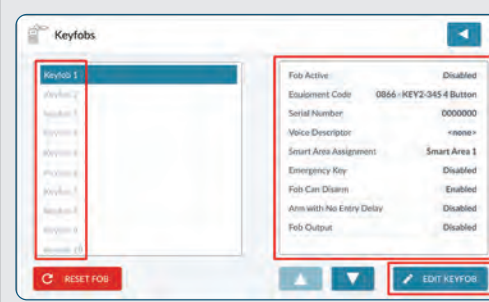

PANEL PROGRAMMING – KEYPADS

You can program up to eight (8) wireless keypads per system. To get started, navigate to the *Installer Toolbox*. Then, tap *Keypads*. This reveals the *Keypads* screen.



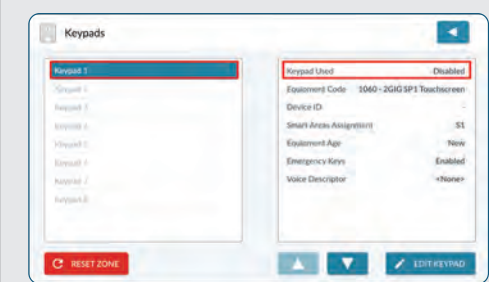

Setup Keypad (#)



1. Swipe up to move through the list of keypads.
2. Tap to select one of the available keypads.
3. Tap **Edit Keypad**.
4. Make sure the *Keypad Used* setting is highlighted.
5. Under *Keypad Used*, choose *Enabled* or *Disabled*.
6. Tap  to move to the next option.



PANEL PROGRAMMING – ADVANCED PROGRAMMING

Tap *Installer Toolbox*, then tap *Panel Programming* > *Advanced Programming* > *System Configuration*.

-  System Configuration
-  Timers, Delays & Counts
-  Panel Configuration
-  Troubles
-  Reporting

1. Highlight a question [Q### - (settings differ based on the question)].
2. Tap available options to adjust settings.
3. Tap  to move to the next question, or tap  to return to the previous menu.

Note: Ensure that the settings you program are in compliance with all national, state, and local regulations.

Note: For more in-depth information about the list of questions available in the Panel Programming menu, refer to the *EDGE Installation & Programming Guide*.



SMART HOME SETTINGS

Add up to 232 Z-Wave devices to the network. After adding or removing a device you should always rediscover the network. Tap *Settings*, then *Smart Home Settings* to view the Smart Home Settings menu.

View All Devices

Displays all Z-Wave Smart Home Devices connected to the panel.

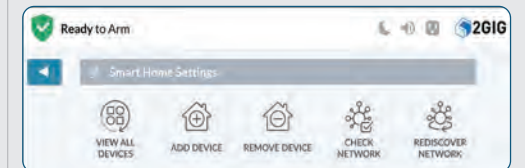

SYSTEM TEST

After installing the system, sensors, and peripherals, perform a walk test to ensure proper console operations and to test wireless reception and signal strength.



RESTORE DEFAULTS

If at any time you want to restore the system's settings to the factory defaults.

1. Navigate to the *Installer Toolbox*.
2. Tap the *Restore Defaults* icon.
3. Tap to enable the *Restore* switch for the specific option(s).
4. Tap **RESTORE**.

2GIG® Edge Security & Smart Home System Regulatory Statements



The EDGE Security & Smart Home System (2GIG-EDGE) is marked to indicate its compliance with:

- » United States—Federal Communications Commission (FCC)
- » Canada—Industry Canada (IC)



Please read the appropriate section that corresponds to the marking on the product before attempting to install the product.

UNITED STATES, FCC STATEMENTS

Wireless Product Notice

Radio controls provide a reliable communication link and fill an important need in portable wireless signaling; however, there are some limitations which must be observed.

- » **For United States installations only:** The radios are required to comply with FCC Rules and Regulations as Part 15 devices. As such, they have limited transmitter power and therefore limited range [approximately 400 feet (121.92 meters)].
- » A receiver cannot respond to more than one transmitted signal at a time and may be blocked by radio signals that occur on or near their operating frequencies, regardless of code settings.
- » Changes or modifications to the device may void FCC compliance. Infrequently used radio links should be tested regularly to protect against undetected interference or fault.
- » A general knowledge of radio and its vagaries should be gained prior to acting as a wholesale distributor or dealer, and these facts should be communicated to the end users.

NOTE: Changes or modification not expressly approved by the party responsible for compliance could void the user's authority to operate the equipment.

US FIRE PROTECTION REGULATORY INFORMATION

Install according to NFPA 72. (National Fire Protection Association, Batterymarch Park, Quincy, MA 02269). Printed information describing proper installation, operation, testing, maintenance, evacuation, planning, and repair service is to be provided with this equipment.

NORTH AMERICAN SAFETY STANDARDS

The EDGE Security & Smart Home System is ETL Listed in North America and when installed and configured as described in the EDGE Security & Smart Home System Installation Guide, meets the standards for:

- » UL STD 985: Household Fire Warning System Units and
- » UL STD 1023: Household Burglar Alarm Units
- » UL STD 1610: Central-Station Burglar-Alarm Units
- » CAN/ULC S545: Residential Fire Warning System Control Units
- » ULC SUBJECT C1023: Household Burglar Alarm System Units
- » ANSI/SIA CP-01-2010: Control Panel Standard - Features for False Alarm Reduction

FCC AND INDUSTRY CANADA STATEMENTS

We, Nortek Security & Control, LLC of 5919 Sea Otter Place, Carlsbad, CA 92010, declare under our sole responsibility that the device complies with Part 15 of the FCC rules.

This device complies with Part 15 of the FCC Rules and Industry Canada license exempt standard(s). Operation is subject to the following two conditions:

1. This device may not cause harmful interference, and
2. This device must accept any interference received, including interference received that may cause undesired operation.

Le présent appareil est conforme aux CNR d'Industrie Canada applicables aux appareils radio exempts de licence. L'exploitation est autorisée aux deux conditions suivantes:

1. l'appareil ne doit pas produire de brouillage, et
2. l'utilisateur de l'appareil doit accepter tout brouillage radioélectrique subi, même si le brouillage est susceptible d'en compromettre le fonctionnement.

Federal Communication Commission (FCC) Radiation Exposure Statement: When using the product, maintain a distance of 20cm from the body to ensure compliance with RF exposure requirements.

CAN RSS-GEN/CNR-GEN
Déclaration d'exposition aux radiations: Cet équipement est conforme aux limites d'exposition aux rayonnements IC établies pour un environnement non contrôlé. Cet équipement doit être installé et utilisé avec un minimum de 20 cm de distance entre la source de rayonnement et votre corps.

Cet appareil numérique de la classe B est conforme à la norme NMB-003 du Canada.

NOTE: This equipment has been tested and found to comply with the limits for a Class B digital device, pursuant to part 15 of the FCC Rules. These limits are designed to provide reasonable protection against harmful interference in a residential installation. This equipment generates uses and can radiate radio frequency energy and, if not installed and used in accordance with the instructions, may cause harmful interference to radio communications. However, there is no guarantee that interference will not occur in a particular installation. If this equipment does cause harmful interference to radio or television reception, which can be determined by turning the equipment off and on, the user is encouraged to try to correct the interference by one or more of the following measures:

- » Reorient or relocate the receiving antenna.
- » Increase the separation between the equipment and receiver.
- » Connect the equipment into an outlet on a circuit different from that to which the receiver is connected.
- » Consult the dealer or an experienced radio/TV technician for help.

INQUIRIES

Direct all inquiries regarding this regulatory compliance statement to:

Nortek Security & Control LLC
5919 Sea Otter Place, Suite 100, Carlsbad, CA 92010 - USA, 800-421-1587

INSTRUCTIONS

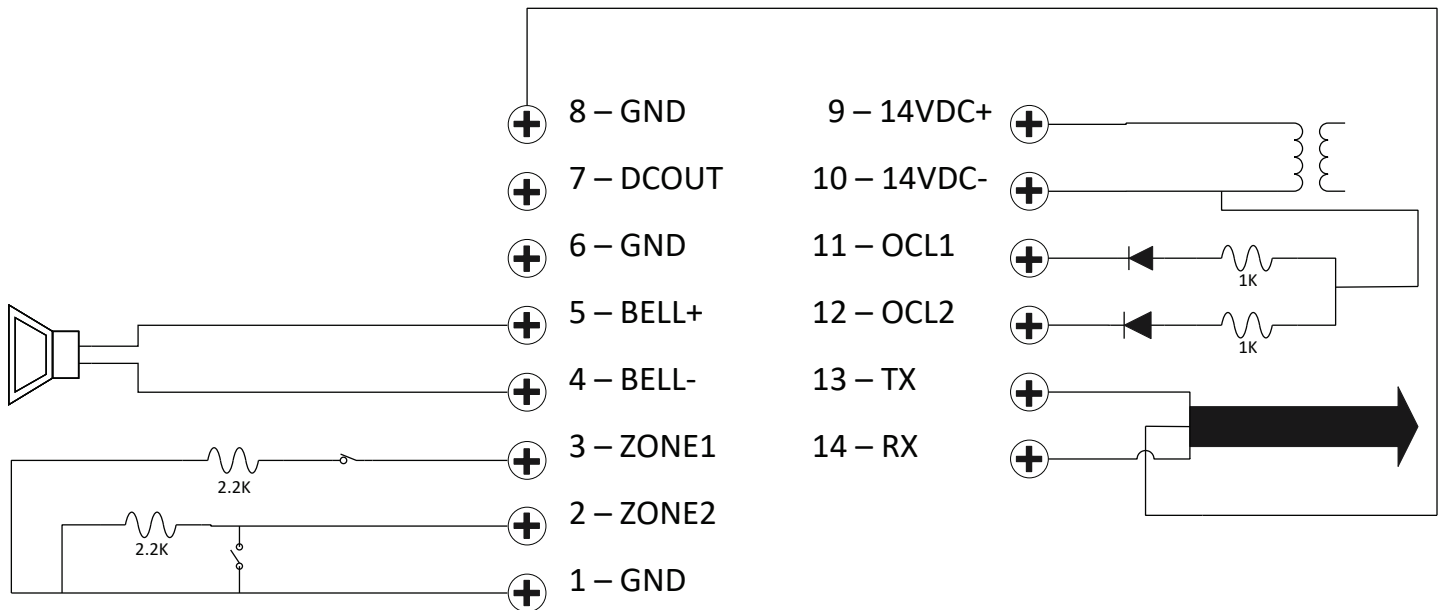

1. Please test the system at least once per week.
2. Replacement rechargeable battery is 2GIG-EDG-BATT. Replacement batteries are available and are expected to last a minimum of three years under normal conditions.
3. This unit is to be checked by a qualified technician at least once every 3 years.
4. For installation instructions and full users guide, see <https://www.2gig.com/resources/>