

RADIO TEST REPORT

FCC ID: EF400166

Product : USB Z-WAVE RADIO / ANTENNA

Trade Mark : ELAN

Model Name : EL-SC-ZW

Family Model : N/A

Report No. : S19042905102001

Prepared for

Nortek Security & Control LLC

5919 Sea Otter Place, Suite 100, Carlsbad, California, 92010 United States

Prepared by

Shenzhen NTEK Testing Technology Co., Ltd.

1/F, Building E, Fenda Science Park, Sanwei Community, Xixiang Street
Bao'an District, Shenzhen 518126 P.R. China

Tel.: +86-755-6115 6588 Fax.: +86-755-6115 6599

Website: <http://www.ntek.org.cn>

TEST RESULT CERTIFICATION

Applicant's name..... : Nortek Security & Control LLC
 Address..... : 5919 Sea Otter Place,Suite 100, Carlsbad, California, 92010
 United States
Manufacturer's Name..... : Nortek Security & Control LLC
 Address..... : 5919 Sea Otter Place,Suite 100, Carlsbad, California, 92010
 United States
Factory's Name1..... : Flextronics Electronics Technology (Shenzhen) Co., Ltd
 Address..... : 89 Yong Fu Road, Tong Fu Yu Industrial Park, Fu Yong Town,
 Bao An District, Shenzhen 518103
Factory's Name2..... : Linear Electronics(Shenzhen) Limited
 Address..... : Building 5-8, Hourui Second Industrial Zone, Hourui Village,
 Hangcheng, Baoan District, Shenzhen, 518128, China

Product description

Product name..... : USB Z-WAVE RADIO / ANTENNA
 Model and/or type reference : EL-SC-ZW
 Family Model : N/A
 Rating(s)..... : DC 5V from USB port

Standards..... : FCC Part15.249: 2018

Test procedure ANSI C63.10-2013

This device described above has been tested by NTEK, and the test results show that the equipment under test (EUT) is in compliance with the FCC requirements. And it is applicable only to the tested sample identified in the report.

This report shall not be reproduced except in full, without the written approval of NTEK, this document may be altered or revised by NTEK, personnel only, and shall be noted in the revision of the document.

Date of Test :
 Date (s) of performance of tests..... : Jul. 03, 2019 ~ Jul. 23, 2019
 Date of Issue : Jul. 29, 2019
 Test Result : **Pass**

Testing Engineer : Allen Liu
 (Allen Liu)
 Technical Manager : Jason Chen
 (Jason Chen)
 Authorized Signatory : Sam Chen
 (Sam Chen)

Table of Contents	Page
1 . SUMMARY OF TEST RESULTS	4
1.1 TEST FACILITY	5
1.2 MEASUREMENT UNCERTAINTY	5
2 . GENERAL INFORMATION	6
2.1 GENERAL DESCRIPTION OF EUT	6
2.2 DESCRIPTION OF TEST MODES	8
2.3 BLOCK DIGRAM SHOWING THE CONFIGURATION OF SYSTEM TESTED	9
2.4 DESCRIPTION OF SUPPORT UNITS(CONDUCTED MODE)	10
2.5 EQUIPMENTS LIST FOR ALL TEST ITEMS	11
3 . ANTENNA REQUIREMENT	13
3.1 STANDARD REQUIREMENT	13
3.2 EUT ANTENNA	13
3.3 CONDUCTED EMISSION MEASUREMENT	14
3.3.1 POWER LINE CONDUCTED EMISSION LIMITS	14
3.3.2 TEST PROCEDURE	14
3.3.3 DEVIATION FROM TEST STANDARD	14
3.3.4 TEST SETUP	15
3.2.5 TEST RESULT	16
3.4 RADIATED EMISSION MEASUREMENT	20
3.4.1 RADIATED EMISSION LIMITS	20
3.4.2 TEST PROCEDURE	21
3.4.3 DEVIATION FROM TEST STANDARD	21
3.4.4 TEST RESULTS (BELOW 30MHZ)	24
3.4.5 TEST RESULTS (BELOW 1000 MHZ)	25
3.4.6 TEST RESULTS (ABOVE 1000 MHZ)	31
3.4.7 TEST RESULTS (RESTRICTED BANDS REQUIREMENTS)	37
4 . FREQUENCY TOLERANCE	43
4.1 FREQUENCY TOLERANCE LIMITS	43
4.2TEST PROCEDURE	43
4.3 TEST SETUP	43
4.4 TEST RESULTS	43
5. BANDWIDTH TEST	45
5.1 TEST PROCEDURE	45
5.1 DEVIATION FROM STANDARD	45
5.1 TEST SETUP	45
6. TEST RESULTS	46

1. SUMMARY OF TEST RESULTS

Test procedures according to the technical standards:

FCC Part15, Subpart C (15.249)			
Standard Section	Test Item	Judgment	Remark
15.207	Conducted Emission	Pass	
15.203	Antenna Requirement	Pass	
15.249 15.209	Radiated Spurious Emission	Pass	
15.249(2)	Frequency Tolerance	Pass	
15.249(a)	Fundamental Measurement	Pass	
15.205	Band Edge Emission	Pass	
15.249	Occupied Bandwidth	Pass	

1.1 TEST FACILITY

Shenzhen NTEK Testing Technology Co., Ltd
 Add. : 1/F, Building E, Fenda Science Park, Sanwei Community, Xixiang Street, Bao'an District, Shenzhen 518126 P.R. China.
 FCC FRN Registration No.:463705; IC Registration No.:9270A-1
 CNAS Registration No.:L5516

1.2 MEASUREMENT UNCERTAINTY

The reported uncertainty of measurement $y \pm U$, where expanded uncertainty U is based on a standard uncertainty multiplied by a coverage factor of $k=2$, providing a level of confidence of approximately 95 %.

No.	Item	Uncertainty
1	Conducted Emission Test	$\pm 1.38\text{dB}$
2	RF power,conducted	$\pm 0.16\text{dB}$
3	Spurious emissions,conducted	$\pm 0.21\text{dB}$
4	All emissions,radiated(<1G)	$\pm 4.68\text{dB}$
5	All emissions,radiated(>1G)	$\pm 4.89\text{dB}$
6	Temperature	$\pm 0.5^\circ\text{C}$
7	Humidity	$\pm 2\%$

2. GENERAL INFORMATION

2.1 GENERAL DESCRIPTION OF EUT

Equipment	USB Z-WAVE RADIO / ANTENNA
Trade Mark	ELAN
Model Name	EL-SC-ZW
Family Model	N/A
Model Difference	N/A
Product Description	The EUT is a USB Z-WAVE RADIO / ANTENNA
	Operation Frequency: 902-928MHz
	Modulation Type: GFSK,FSK
	Antenna Designation: Metal Antenna
	Antenna Gain(Peak) 0.84dBi
Based on the application, features, or specification exhibited in User's Manual. More details of EUT technical specification, please refer to the User's Manual.	
Channel List	Please refer to the Note 2.
Adapter	N/A
Battery	N/A
Power supply	DC 5V from USB port.
Hardware version	X2
Firmware version	N/A
Software version	v7.11.0

Note:

1. For a more detailed features description, please refer to the manufacturer's specifications or the User's Manual.

2.

Channel	Frequency (MHz)
01	908.4
02	908.42
03	916

3.

Table for Filed Antenna

Ant.	Brand	Model Name	Antenna Type	Connector	Gain (dBi)	NOTE
1	N/A	N/A	Metal Antenna	N/A	0.84	Antenna

2.2 DESCRIPTION OF TEST MODES

To investigate the maximum EMI emission characteristics generates from EUT, the test system was pre-scanning tested base on the consideration of following EUT operation mode or test configuration mode which possible have effect on EMI emission level. Each of these EUT operation mode(s) or test configuration mode(s) mentioned above was evaluated respectively.

Pretest Mode	Description
Mode 1	CH01
Mode 2	CH02
Mode 3	CH03
Mode 4	Normal link

For Radiated Spurious Emission	
Pretest Mode	Description
Mode 1	CH01
Mode 2	CH02
Mode 3	CH03
Mode 4	Normal link

For Conducted Emission	
Final Test Mode	Description
Mode 1	CH01
Mode 2	CH02
Mode 3	CH03
Mode 4	Normal link

Note:

(1) The measurements are performed at the highest, middle, lowest available channels.

2.3 BLOCK DIGRAM SHOWING THE CONFIGURATION OF SYSTEM TESTED

For AC Conducted Emission Mode

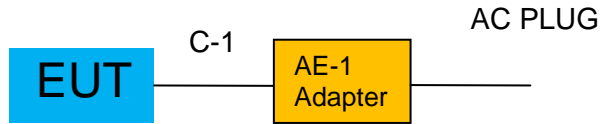

Radiated Spurious Emission Test

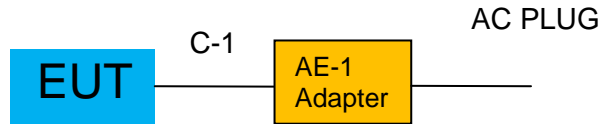

2.4 DESCRIPTION OF SUPPORT UNITS (CONDUCTED MODE)

The EUT has been tested as an independent unit together with other necessary accessories or support units. The following support units or accessories were used to form a representative test configuration during the tests.

Item	Equipment	Mfr/Brand	Model/Type No.	Series No.	Note
AE-1	Adapter	SIMP	KSAPK0110500200D5	N/A	Peripherals

Item	Cable Type	Shielded Type	Ferrite Core	Length	Note
C-1	Power Cable	NO	NO	1.2m	

Note:

- (1) The support equipment was authorized by Declaration of Confirmation.
- (2) For detachable type I/O cable should be specified the length in cm in 『Length』 column.

2.5 EQUIPMENTS LIST FOR ALL TEST ITEMS

Radiation Test equipment

Item	Kind of Equipment	Manufacturer	Type No.	Serial No.	Last calibration	Calibrated until	Calibration period
1	Spectrum Analyzer	Agilent	E4407B	MY45108040	2019.05.13	2020.05.12	1 year
2	Spectrum Analyzer	Agilent	N9020A	MY49100060	2018.10.08	2019.10.07	1 year
3	EMI Test Receiver	Agilent	N9038A	MY53227146	2019.05.13	2020.05.12	1 year
4	Test Receiver	R&S	ESPI	101318	2019.05.13	2020.05.12	1 year
5	Bilog Antenna	TESEQ	CBL6111D	31216	2019.04.15	2020.04.14	1 year
6	50Ω Coaxial Switch	Anritsu	MP59B	6200983705	2018.05.19	2020.05.18	2 year
7	Horn Antenna	EM	EM-AH-10180	2011071402	2019.04.15	2020.04.14	1 year
8	Horn Ant	Schwarzbeck	BBHA 9170	9170-181	2019.05.13	2020.05.12	1 year
9	Amplifier	EMC	EMC051835SE	980246	2018.08.05	2019.08.04	1 year
10	Amplifier	MITEQ	TTA1840-35-HG	177156	2019.05.13	2020.05.12	1 year
11	Loop Antenna	ARA	PLA-1030/B	1029	2019.05.13	2020.05.12	1 year
12	Power Meter	DARE	RPR3006W	15I00041S NO84	2018.08.05	2019.08.04	1 year
13	Test Cable (9KHz-30MHz)	N/A	R-01	N/A	2017.04.21	2020.04.20	3 year
14	Test Cable (30MHz-1GHz)	N/A	R-02	N/A	2017.04.21	2020.04.20	3 year
15	High Test Cable(1G-40GHz)	N/A	R-03	N/A	2017.04.21	2020.04.20	3 year
16	High Test Cable(1G-40GHz)	N/A	R-04	N/A	2017.04.21	2020.04.20	3 year
17	temporary antenna connector (Note)	NTS	R001	N/A	N/A	N/A	N/A

Note:

We will use the temporary antenna connector (soldered on the PCB board) When conducted test
And this temporary antenna connector is listed within the instrument list

Conduction Test equipment

Item	Kind of Equipment	Manufacturer	Type No.	Serial No.	Last calibration	Calibrated until	Calibration period
1	Test Receiver	R&S	ESCI	101160	2019.05.13	2020.05.12	1 year
2	LISN	R&S	ENV216	101313	2019.04.15	2020.04.14	1 year
3	LISN	SCHWARZB ECK	NNLK 8129	8129245	2019.05.13	2020.05.12	1 year
4	50Ω Coaxial Switch	ANRITSU CORP	MP59B	620098370 4	2019.05.13	2020.05.12	1 year
5	Test Cable (9KHz-30M Hz)	N/A	C01	N/A	2017.04.21	2020.04.20	3 year
6	Test Cable (9KHz-30M Hz)	N/A	C02	N/A	2017.04.21	2020.04.20	3 year
7	Test Cable (9KHz-30M Hz)	N/A	C03	N/A	2017.04.21	2020.04.20	3 year

Note: Each piece of equipment is scheduled for calibration once a year except the Test Cable which is scheduled for calibration every 3 years.

3. ANTENNA REQUIREMENT

3.1 STANDARD REQUIREMENT

15.203 requirement: For intentional device, according to 15.203: an intentional radiator shall be designed to ensure that no antenna other than that furnished by the responsible party shall be used with the device.

3.2 EUT ANTENNA

The EUT antenna is permanent attached Metal antenna (Gain: 0.84dBi). It comply with the standard requirement.

3.3 CONDUCTED EMISSION MEASUREMENT

3.3.1 POWER LINE CONDUCTED EMISSION Limits (Frequency Range 150KHz-30MHz)

Frequency(MHz)	Conducted Emission Limit	
	Quasi-peak	Average
0.15-0.5	66-56*	56-46*
0.5-5.0	56	46
5.0-30.0	60	50

Note: 1. *Decreases with the logarithm of the frequency
 2. The lower limit shall apply at the transition frequencies
 3. The limit decreases in line with the logarithm of the frequency in the range of 0.15 to 0.50MHz.

The following table is the setting of the receiver

Receiver Parameters	Setting
Attenuation	10 dB
Start Frequency	0.15 MHz
Stop Frequency	30 MHz
IF Bandwidth	9 kHz

3.3.2 TEST PROCEDURE

- a. The EUT was placed 0.4 meters from the horizontal ground plane with EUT being connected to the power mains through a line impedance stabilization network (LISN). All other support equipments powered from additional LISN(s). The LISN provide 50 Ohm/ 50uH of coupling impedance for the measuring instrument.
- b. Interconnecting cables that hang closer than 40 cm to the ground plane shall be folded back and forth in the center forming a bundle 30 to 40 cm long.
- c. I/O cables that are not connected to a peripheral shall be bundled in the center. The end of the cable may be terminated, if required, using the correct terminating impedance. The overall length shall not exceed 1 m.
- d. LISN at least 80 cm from nearest part of EUT chassis.
- e. For the actual test configuration, please refer to the related Item –EUT Test Photos.

3.3.3 DEVIATION FROM TEST STANDARD

No deviation

3.3.4 TEST SETUP

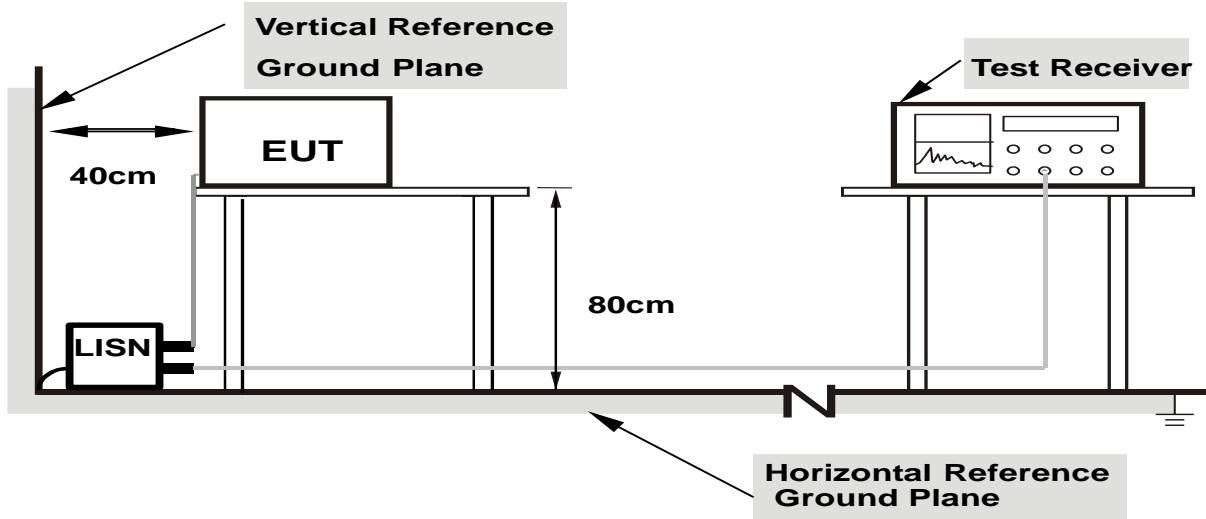

- Note:**
1. Support units were connected to second LISN.
 2. Both of LISNs (AMN) are 80 cm from EUT and at least 80 from other units and other metal planes

3.2.5 TEST RESULT

EUT :	USB Z-WAVE RADIO / ANTENNA	Model Name. :	EL-SC-ZW
Temperature :	25 °C	Relative Humidity :	55%
Pressure :	1010hPa	Phase :	L
Test Voltage :	DC 5V from Adapter AC 120V/60Hz	Test Mode :	Normal link

Frequency (MHz)	Reading Level (dBμV)	Correct Factor (dB)	Measure-ment (dBμV)	Limits (dBμV)	Margin (dB)	Remark
0.1700	21.61	9.76	31.37	64.96	-33.59	QP
0.1700	13.56	9.76	23.32	54.96	-31.64	AVG
0.4220	15.22	9.74	24.96	57.41	-32.45	QP
0.4220	2.02	9.74	11.76	47.41	-35.65	AVG
0.5420	14.57	9.74	24.31	56.00	-31.69	QP
0.5420	3.51	9.74	13.25	46.00	-32.75	AVG
0.8980	10.89	9.74	20.63	56.00	-35.37	QP
0.8980	2.38	9.74	12.12	46.00	-33.88	AVG
4.8739	10.66	9.87	20.53	56.00	-35.47	QP
4.8739	0.46	9.87	10.33	46.00	-35.67	AVG
7.8340	11.98	9.93	21.91	60.00	-38.09	QP
7.8340	2.68	9.93	12.61	50.00	-37.39	AVG

Remark:

1. All readings are Quasi-Peak and Average values.
2. Factor = Insertion Loss + Cable Loss.

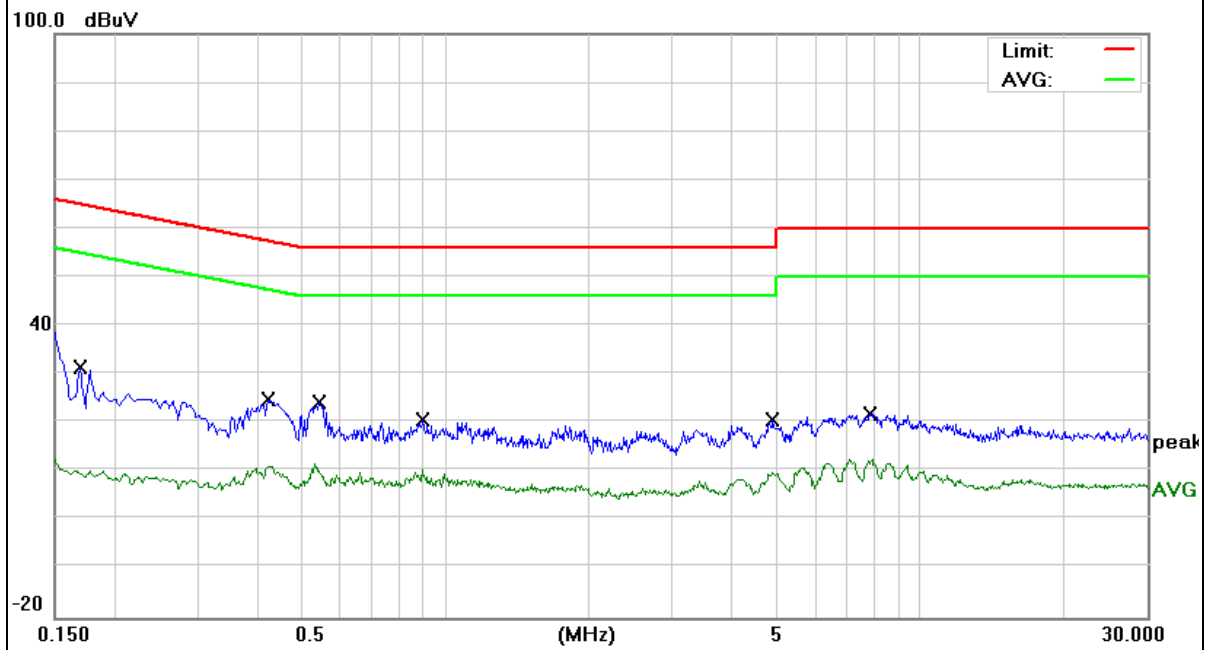

EUT :	USB Z-WAVE RADIO / ANTENNA	Model Name. :	EL-SC-ZW
Temperature :	25 °C	Relative Humidity :	55%
Pressure :	1010hPa	Phase :	N
Test Voltage :	DC 5V from Adapter AC 120V/60Hz	Test Mode :	Normal link

Frequency (MHz)	Reading Level (dBμV)	Correct Factor (dB)	Measure-ment (dBμV)	Limits (dBμV)	Margin (dB)	Remark
0.1700	23.19	9.73	32.92	64.96	-32.04	QP
0.1700	18.63	9.73	28.36	54.96	-26.60	AVG
0.1940	22.76	9.73	32.49	63.86	-31.37	QP
0.1940	5.52	9.73	15.25	53.86	-38.61	AVG
0.4220	21.47	9.75	31.22	57.41	-26.19	QP
0.4220	4.10	9.75	13.85	47.41	-33.56	AVG
0.5460	22.79	9.75	32.54	56.00	-23.46	QP
0.5460	8.80	9.75	18.55	46.00	-27.45	AVG
0.8860	17.18	9.75	26.93	56.00	-29.07	QP
0.8860	3.91	9.75	13.66	46.00	-32.34	AVG
5.0420	13.17	9.94	23.11	60.00	-36.89	QP
5.0420	7.62	9.94	17.56	50.00	-32.44	AVG

Remark:

1. All readings are Quasi-Peak and Average values.
2. Factor = Insertion Loss + Cable Loss.

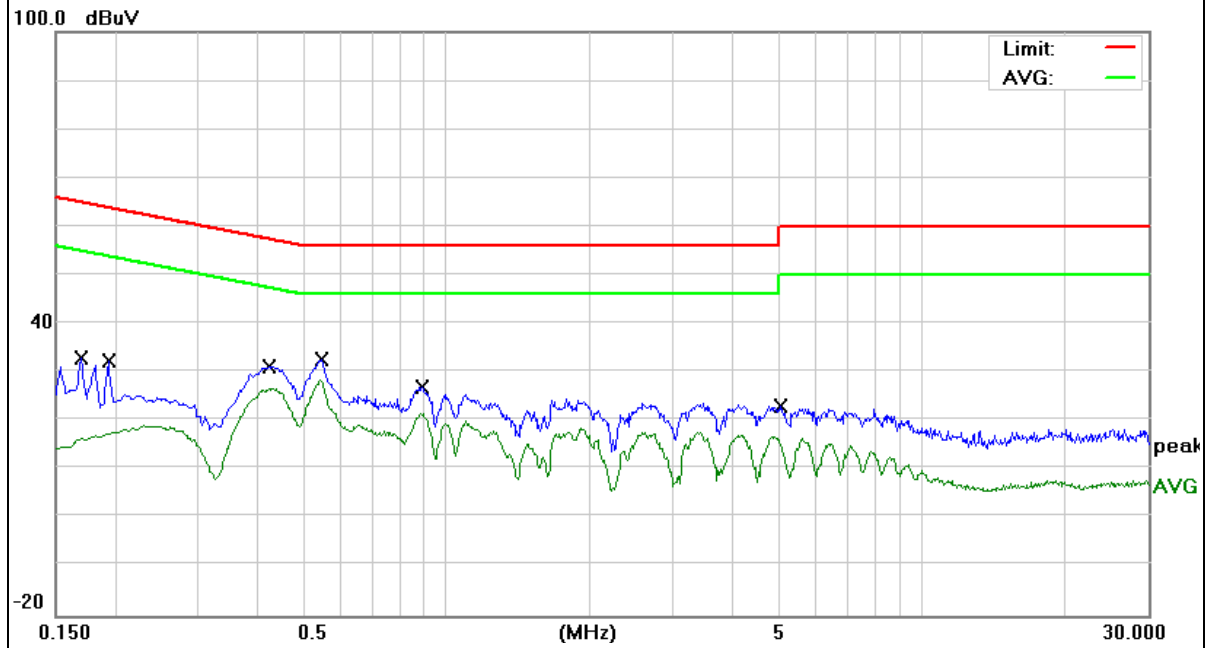

EUT :	USB Z-WAVE RADIO / ANTENNA	Model Name. :	EL-SC-ZW
Temperature :	25 °C	Relative Humidity :	55%
Pressure :	1010hPa	Phase :	L
Test Voltage :	DC 5V from Adapter AC 240V/60Hz	Test Mode :	Normal link

Frequency (MHz)	Reading Level (dBμV)	Correct Factor (dB)	Measure-ment (dBμV)	Limits (dBμV)	Margin (dB)	Remark
0.4620	16.47	9.74	26.21	56.66	-30.45	QP
0.4620	3.62	9.74	13.36	46.66	-33.30	AVG
0.5580	16.71	9.74	26.45	56.00	-29.55	QP
0.5580	3.52	9.74	13.26	46.00	-32.74	AVG
0.8460	14.57	9.74	24.31	56.00	-31.69	QP
0.8460	2.43	9.74	12.17	46.00	-33.83	AVG
1.1340	12.51	9.74	22.25	56.00	-33.75	QP
1.1340	2.41	9.74	12.15	46.00	-33.85	AVG
1.9860	11.93	9.78	21.71	56.00	-34.29	QP
1.9860	0.88	9.78	10.66	46.00	-35.34	AVG
3.4660	11.69	9.84	21.53	56.00	-34.47	QP
3.4660	0.06	9.84	9.90	46.00	-36.10	AVG

Remark:

1. All readings are Quasi-Peak and Average values.
2. Factor = Insertion Loss + Cable Loss.

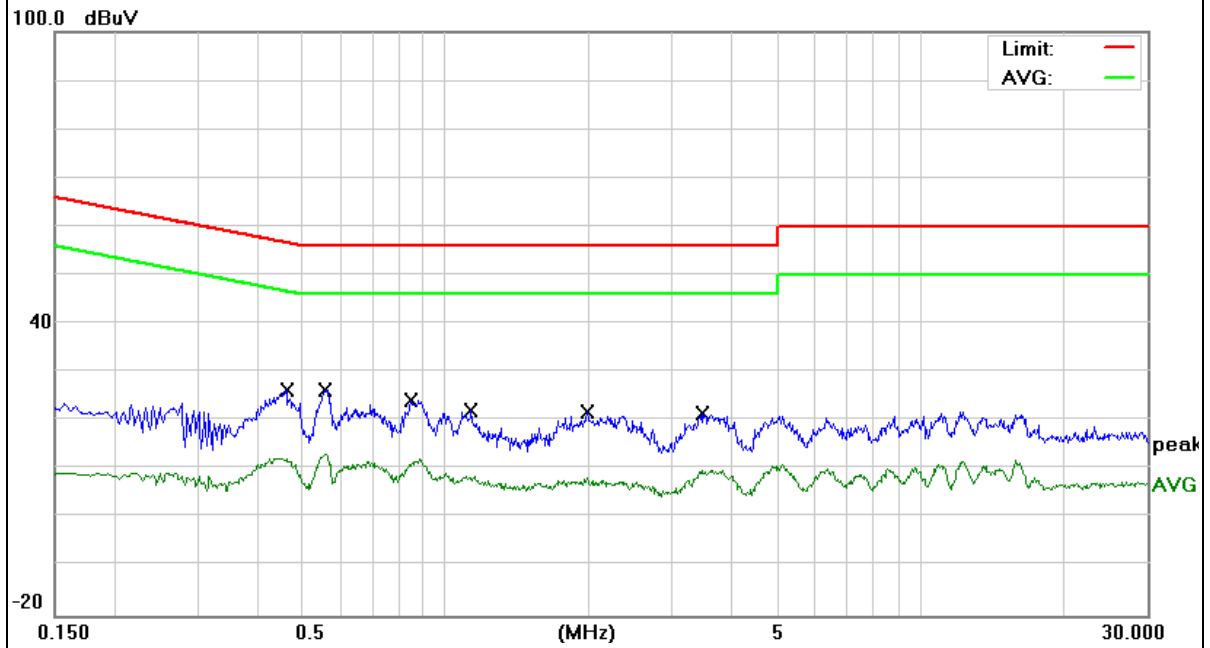

EUT :	USB Z-WAVE RADIO / ANTENNA	Model Name. :	EL-SC-ZW
Temperature :	25 °C	Relative Humidity :	55%
Pressure :	1010hPa	Phase :	N
Test Voltage :	DC 5V from Adapter AC 240V/60Hz	Test Mode :	Normal link

Frequency (MHz)	Reading Level (dBμV)	Correct Factor (dB)	Measure-ment (dBμV)	Limits (dBμV)	Margin (dB)	Remark
0.4460	23.12	9.75	32.87	56.95	-24.08	QP
0.4460	12.61	9.75	22.36	46.95	-24.59	AVG
0.5580	24.54	9.75	34.29	56.00	-21.71	QP
0.5580	20.11	9.75	29.86	46.00	-16.14	AVG
0.8900	21.82	9.75	31.57	56.00	-24.43	QP
0.8900	10.79	9.75	20.54	46.00	-25.46	AVG
1.9980	17.75	9.79	27.54	56.00	-28.46	QP
1.9980	12.94	9.79	22.73	46.00	-23.27	AVG
3.6220	15.81	9.90	25.71	56.00	-30.29	QP
3.6220	11.10	9.90	21.00	46.00	-25.00	AVG
4.8659	14.07	9.94	24.01	56.00	-31.99	QP
4.8659	3.39	9.94	13.33	46.00	-32.67	AVG

Remark:

1. All readings are Quasi-Peak and Average values.
2. Factor = Insertion Loss + Cable Loss.

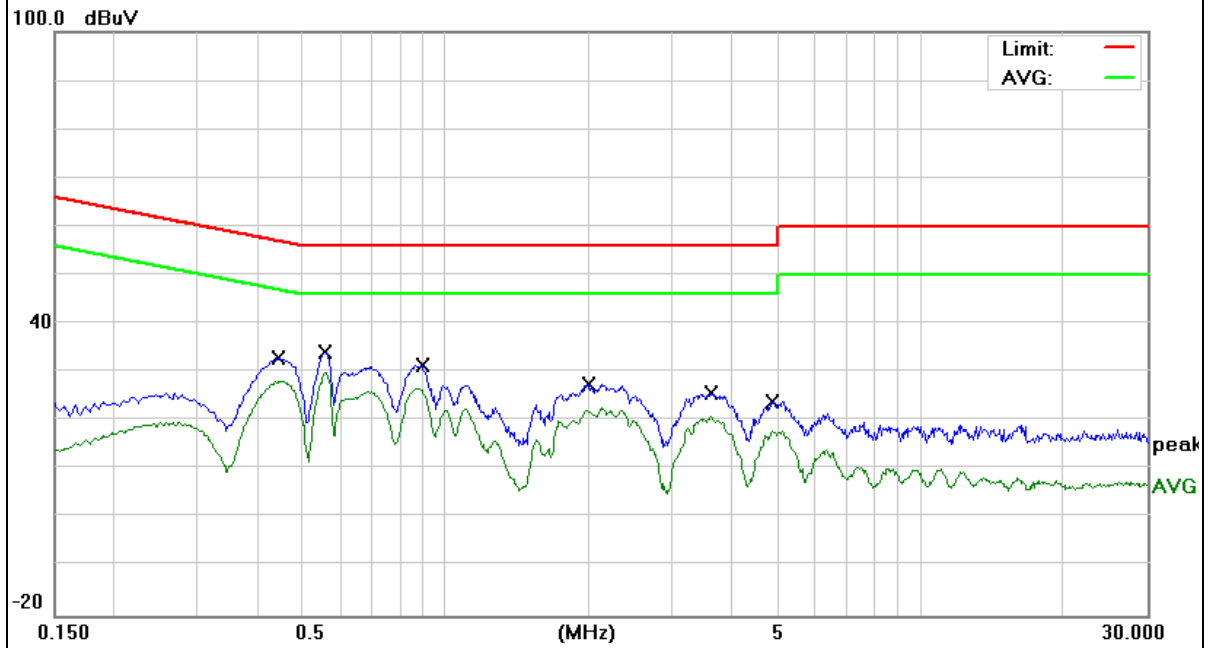

3.4 RADIATED EMISSION MEASUREMENT

3.4.1 Radiated Emission Limits (FCC 15.209)

Frequencies (MHz)	Field Strength (micorvolts/meter)	Measurement Distance (meters)
0.009~0.490	2400/F(KHz)	300
0.490~1.705	24000/F(KHz)	30
1.705~30.0	30	30
Frequency (MHz)	Limit (dBuV)	
30~88	40	3
88~216	43.5	3
216~960	46	3
960 -10000	54.00	3
*902 - 928	94.00	3

Note:

- (1) The tighter limit applies at the band edges.
- (2) Emission level (dBuV/m)=20log Emission level (uV/m).
- (3) *Note: This is the limit for the fundamental frequency.

LIMITS OF RADIATED EMISSION MEASUREMENT (FCC 15.249)

Frequency of Emission (MHz)	Field Strength of fundamental ((millivolts /meter)	Field Strength of Harmonics (microvolts/meter)
2400-2483.5	50	500

Notes:

- (1) Emissions radiated outside of the specified frequency bands, except for harmonics, shall be attenuated by at least 50 dB below the level of the fundamental or to the general radiated emission limits in Section 15.209, whichever is the lesser attenuation.

Spectrum Parameter	Setting
Attenuation	Auto
Start Frequency	1000 MHz
Stop Frequency	10th carrier harmonic
RB / VB (emission in restricted band)	1MHz / 1MHz for Peak

Receiver Parameter	Setting
Attenuation	Auto
Start ~ Stop Frequency	9kHz~150kHz / RB 200Hz for QP
Start ~ Stop Frequency	150kHz~30MHz / RB 9kHz for QP
Start ~ Stop Frequency	30MHz~1000MHz / RB 120kHz for QP

3.4.2 TEST PROCEDURE

- a. The measuring distance of at 3 m shall be used for measurements at frequency up to 1GHz. For frequencies above 1GHz, any suitable measuring distance may be used.
- b. The EUT was placed on the top of a rotating table 0.8 m for below 1GHz and 1.5m for above 1GHz the ground at a 3 meter. The table was rotated 360 degrees to determine the position of the highest radiation.
- c. The height of the equipment or of the substitution antenna shall be 0.8 m for below 1GHz and 1.5m for above 1GHz; the height of the test antenna shall vary between 1 m to 4 m. Both horizontal and vertical polarizations of the antenna are set to make the measurement.
- d. The initial step in collecting conducted emission data is a spectrum analyzer peak detector mode pre-scanning the measurement frequency range. Significant peaks are then marked and then Quasi Peak detector mode re-measured.
- e. If the Peak Mode measured value compliance with and lower than Quasi Peak Mode Limit, the EUT shall be deemed to meet QP Limits and then no additional QP Mode measurement performed.
- f. For the actual test configuration, please refer to the related Item –EUT Test Photos.

Note:

Both horizontal and vertical antenna polarities were tested and performed pretest to three orthogonal axis. The worst case emissions were reported

3.4.3 DEVIATION FROM TEST STANDARD

No deviation

(A) Radiated Emission Test-Up Frequency Below 30MHz

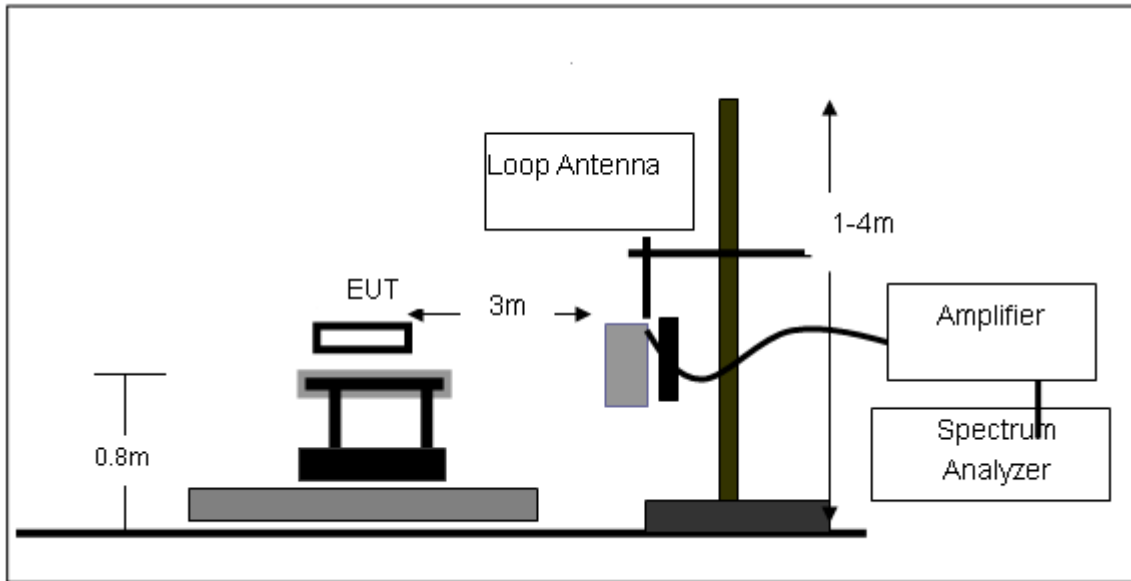

(B) Radiated Emission Test-Up Frequency 30MHz~1GHz

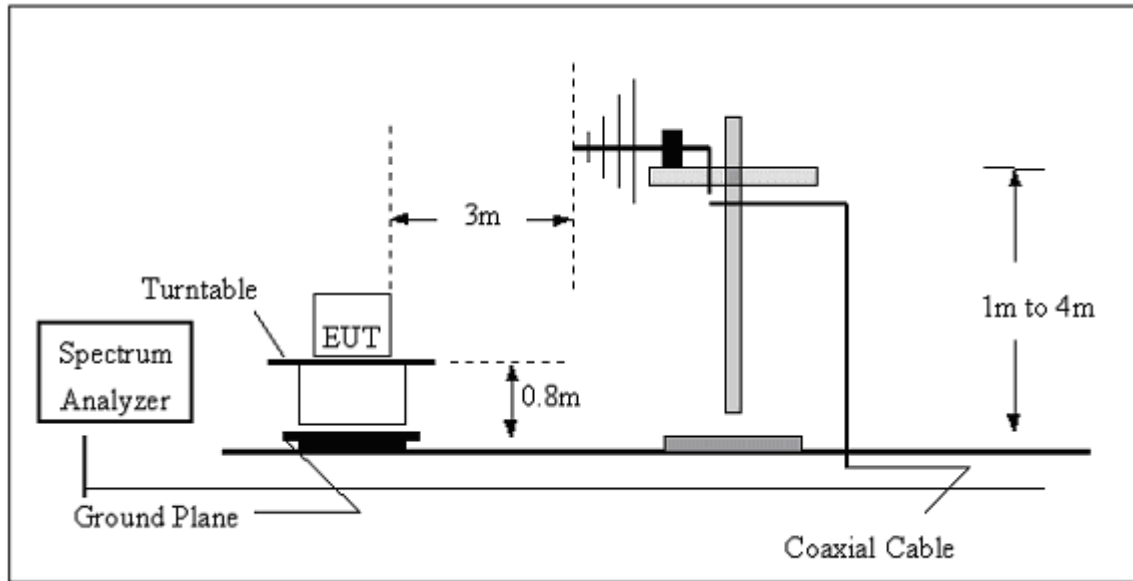

(C) Radiated Emission Test-Up Frequency Above 1GHz

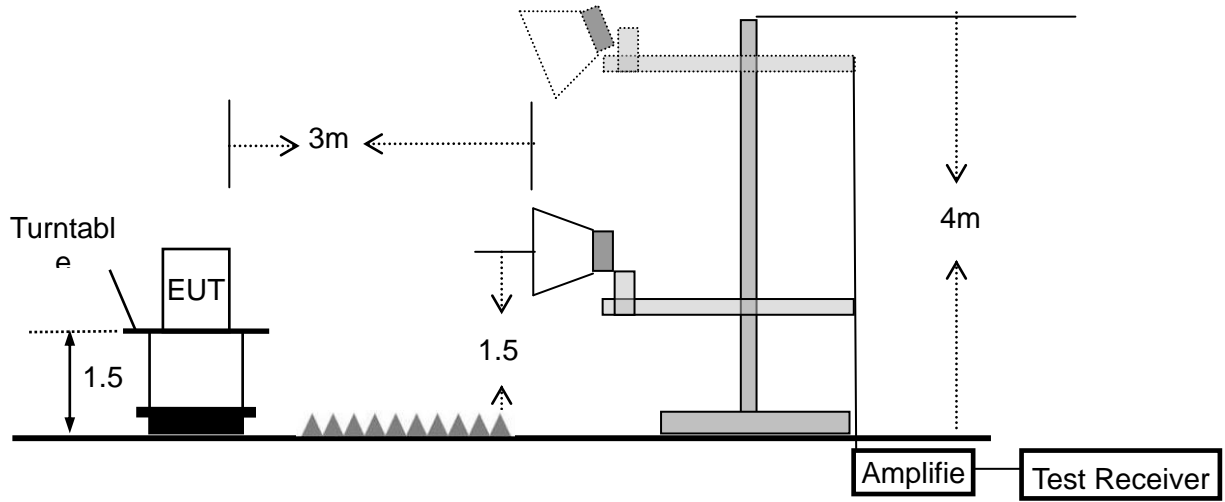

3.4.4 TEST RESULTS (BELOW 30MHz)

EUT :	USB Z-WAVE RADIO / ANTENNA	Model Name. :	EL-SC-ZW
Temperature :	20 °C	Relative Humidity :	48%
Pressure :	1010 hPa	Test Voltage :	DC 5V
Test Mode :	TX	Polarization :	--

Freq.	Reading	Limit	Margin	State
(MHz)	(dBuV/m)	(dBuV/m)	(dB)	P/F
--	--	--	--	PASS
--	--	--	--	PASS

NOTE:

The amplitude of spurious emissions which are attenuated by more than 20dB below the permissible value has no need to be reported.

Remark:1. Emission level in dBuV/m=20 log (uV/m)

2. Measurement was performed at an antenna to the closed point of EUT distance of meters.

3. For Frequency 9kHz~30MHz:

Distance extrapolation factor =40log(Specific distance/ test distance)(dB);

Limit line=Specific limits(dBuV) + distance extrapolation factor.

For Frequency above 30MHz:

Distance extrapolation factor =20log(Specific distance/ test distance)(dB);

Limit line=Specific limits(dBuV) + distance extrapolation factor.

3.4.5 TEST RESULTS (BELOW 1000 MHz)

EUT :	USB Z-WAVE RADIO / ANTENNA	Model Name :	EL-SC-ZW
Temperature :	25 °C	Relative Humidity :	51%
Pressure :	1010 hPa	Test Voltage :	DC 5V
Test Mode :	Model 1	Polarization :	Vertical

Frequency (MHz)	Meter Reading (dBμV)	Factor (dB)	Emission Level (dBμV/m)	Limits (dBμV/m)	Margin (dB)	Detector Type
38.8878	15.76	14.88	30.64	40.00	-9.36	QP
42.8997	20.82	12.61	33.43	40.00	-6.57	QP
170.1947	14.64	11.34	25.98	43.50	-17.52	QP
400.4318	17.57	19.64	37.21	46.00	-8.79	QP
497.6764	11.87	22.04	33.91	46.00	-12.09	QP
908.4000	72.15	29.45	101.60	114.00	-12.40	QP

Remark:

1. Factor = Antenna Factor + Cable Loss – Pre-amplifier.

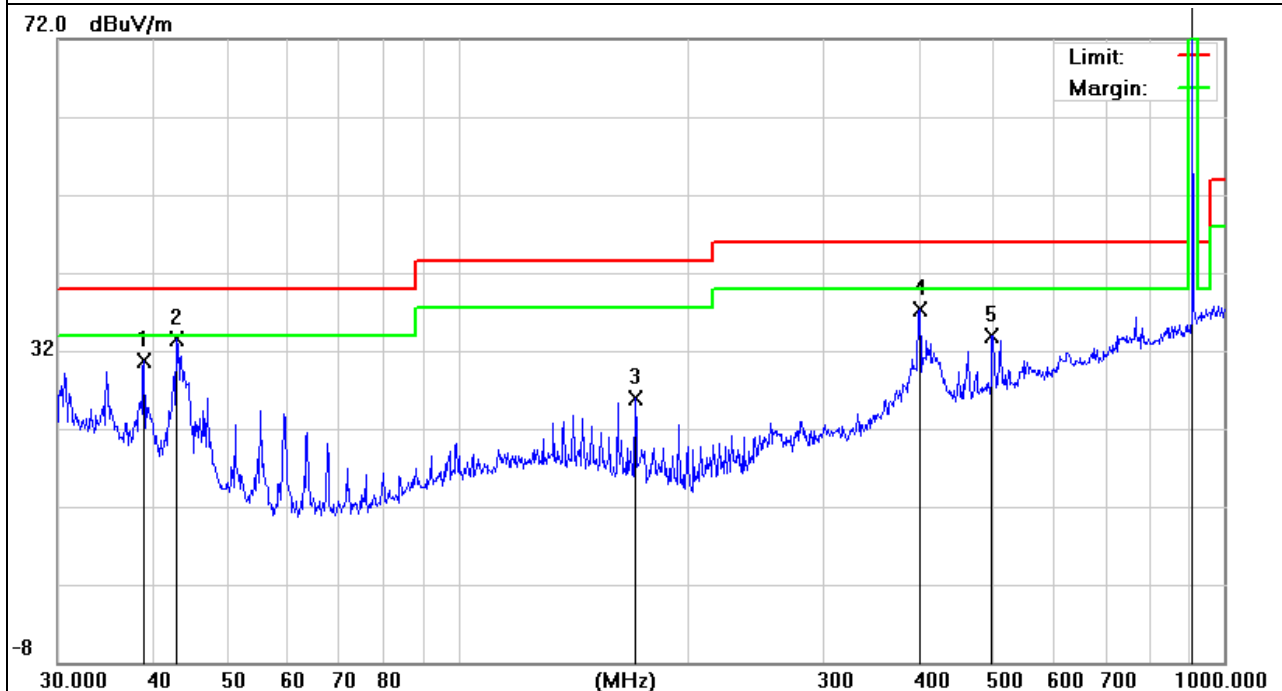

EUT :	USB Z-WAVE RADIO / ANTENNA	Model Name :	EL-SC-ZW
Temperature :	25 °C	Relative Humidity :	51%
Pressure :	1010 hPa	Test Voltage :	DC 5V
Test Mode :	Model 1	Polarization :	Horizontal

Frequency (MHz)	Meter Reading (dBμV)	Factor (dB)	Emission Level (dBμV/m)	Limits (dBμV/m)	Margin (dB)	Detector Type
46.9947	14.12	11.28	25.40	40.00	-14.60	QP
51.1208	14.10	8.51	22.61	40.00	-17.39	QP
170.1947	15.45	11.34	26.79	43.50	-16.71	QP
255.6230	14.48	15.40	29.88	46.00	-16.12	QP
399.0300	18.86	19.57	38.43	46.00	-7.57	QP
908.4000	66.26	29.45	95.71	114.00	-18.29	QP

Remark:

1. Factor = Antenna Factor + Cable Loss – Pre-amplifier.

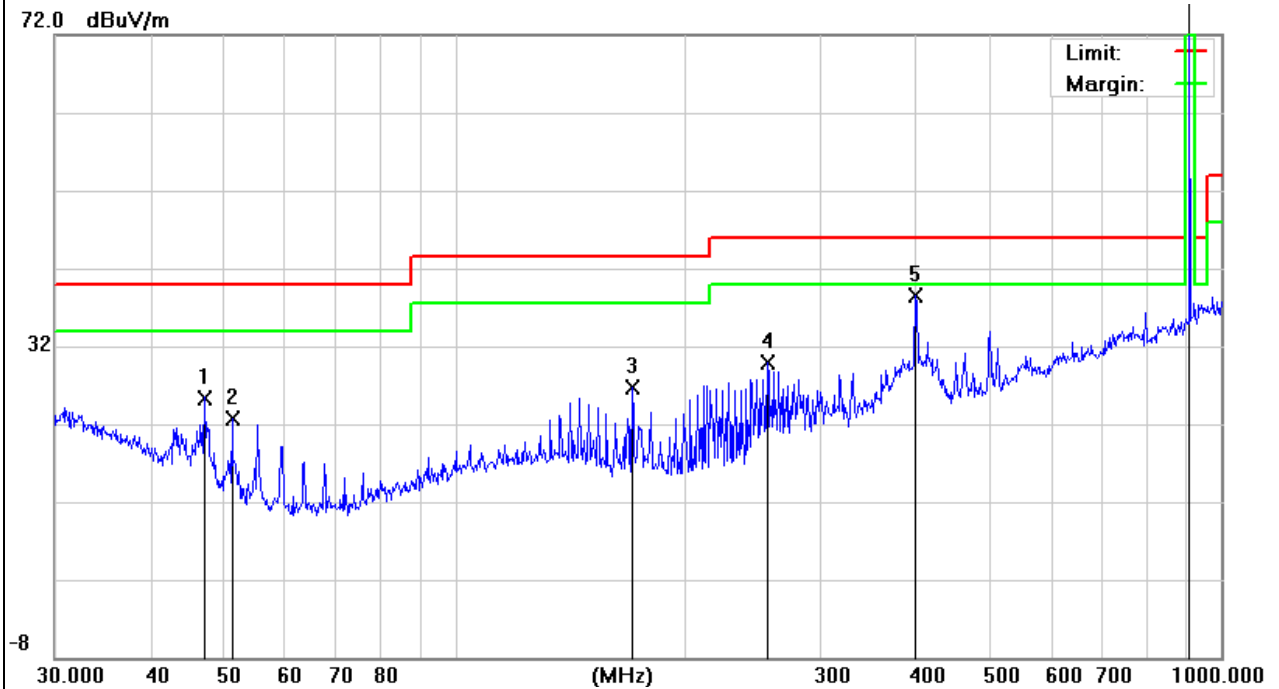

EUT :	USB Z-WAVE RADIO / ANTENNA	Model Name :	EL-SC-ZW
Temperature :	25 °C	Relative Humidity :	51%
Pressure :	1010 hPa	Test Voltage :	DC 5V
Test Mode :	Model 2	Polarization :	Vertical

Frequency (MHz)	Meter Reading (dBμV)	Factor (dB)	Emission Level (dBμV/m)	Limits (dBμV/m)	Margin (dB)	Detector Type
34.7601	12.41	16.82	29.23	40.00	-10.77	QP
38.8878	15.42	14.88	30.30	40.00	-9.70	QP
42.8997	20.40	12.61	33.01	40.00	-6.99	QP
400.4318	18.28	19.64	37.92	46.00	-8.08	QP
499.4246	11.68	22.14	33.82	46.00	-12.18	QP
908.4200	70.96	29.46	100.42	114.00	-13.58	QP

Remark:

1. Factor = Antenna Factor + Cable Loss – Pre-amplifier.

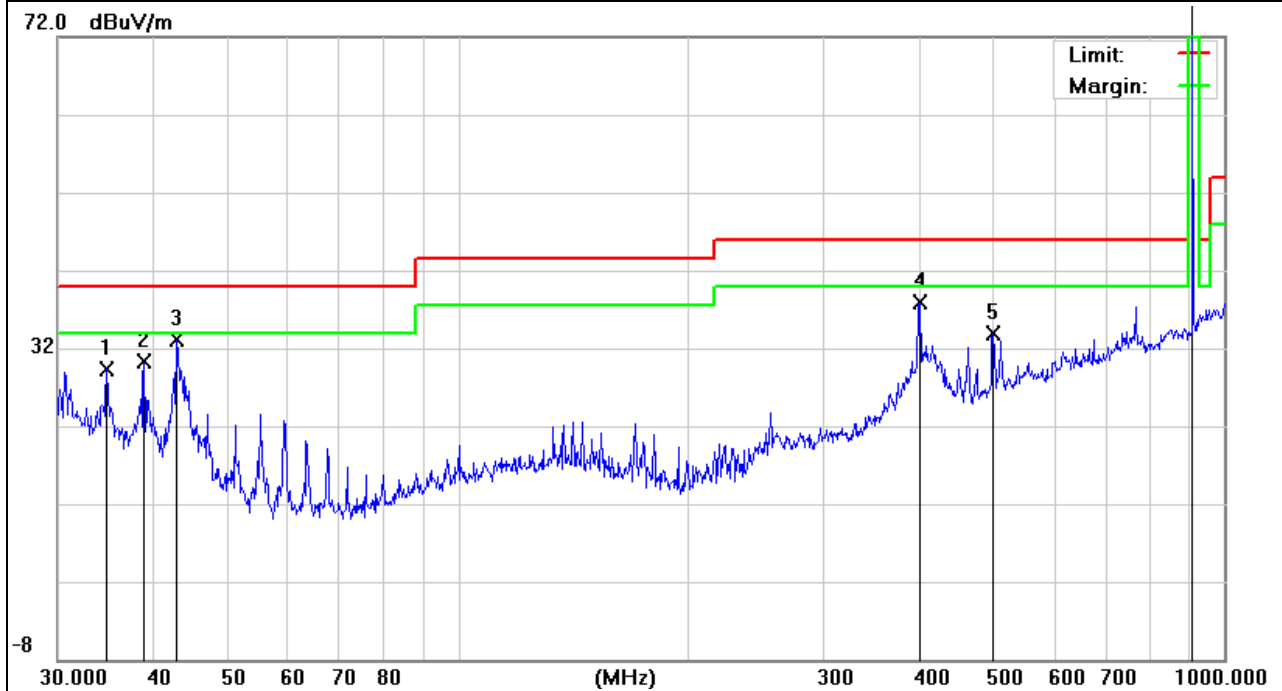

EUT :	USB Z-WAVE RADIO / ANTENNA	Model Name :	EL-SC-ZW
Temperature :	25 °C	Relative Humidity :	51%
Pressure :	1010 hPa	Test Voltage :	DC 5V
Test Mode :	Model 2	Polarization :	Horizontal

Frequency (MHz)	Meter Reading (dBμV)	Factor (dB)	Emission Level (dBμV/m)	Limits (dBμV/m)	Margin (dB)	Detector Type
42.8997	10.39	12.61	23.00	40.00	-17.00	QP
145.3505	10.31	13.11	23.42	43.50	-20.08	QP
170.1947	14.55	11.34	25.89	43.50	-17.61	QP
317.7010	11.33	16.48	27.81	46.00	-18.19	QP
399.0300	18.61	19.57	38.18	46.00	-7.82	QP
908.4200	74.02	29.45	103.47	114.00	-10.53	QP

Remark:

1. Factor = Antenna Factor + Cable Loss – Pre-amplifier.

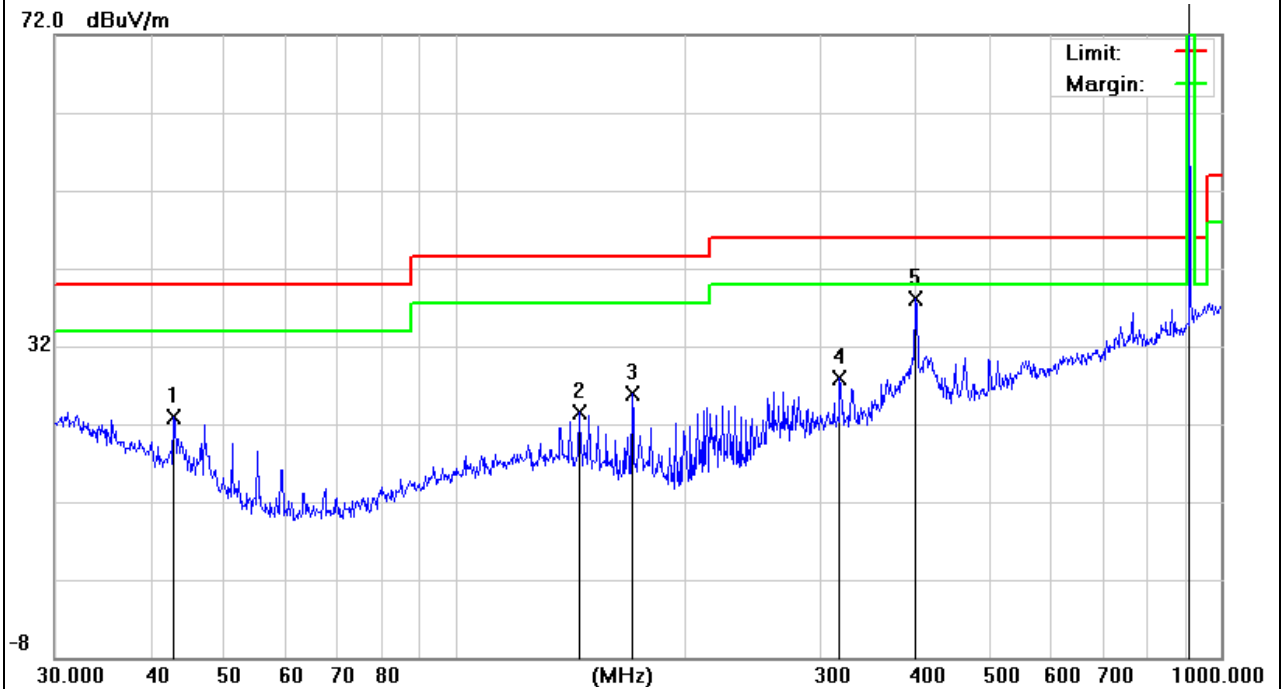

EUT :	USB Z-WAVE RADIO / ANTENNA	Model Name :	EL-SC-ZW
Temperature :	25 °C	Relative Humidity :	51%
Pressure :	1010 hPa	Test Voltage :	DC 5V
Test Mode :	Model 3	Polarization :	Vertical

Frequency (MHz)	Meter Reading (dBμV)	Factor (dB)	Emission Level (dBμV/m)	Limits (dBμV/m)	Margin (dB)	Detector Type
38.8878	15.71	14.88	30.59	40.00	-9.41	QP
42.8998	19.16	12.60	31.76	40.00	-8.24	QP
59.2325	18.96	6.58	25.54	40.00	-14.46	QP
141.3298	12.95	13.26	26.21	43.50	-17.29	QP
399.0302	18.00	19.57	37.57	46.00	-8.43	QP
916.0000	69.31	29.82	99.13	114.00	-14.87	QP

Remark:

1. Factor = Antenna Factor + Cable Loss – Pre-amplifier.

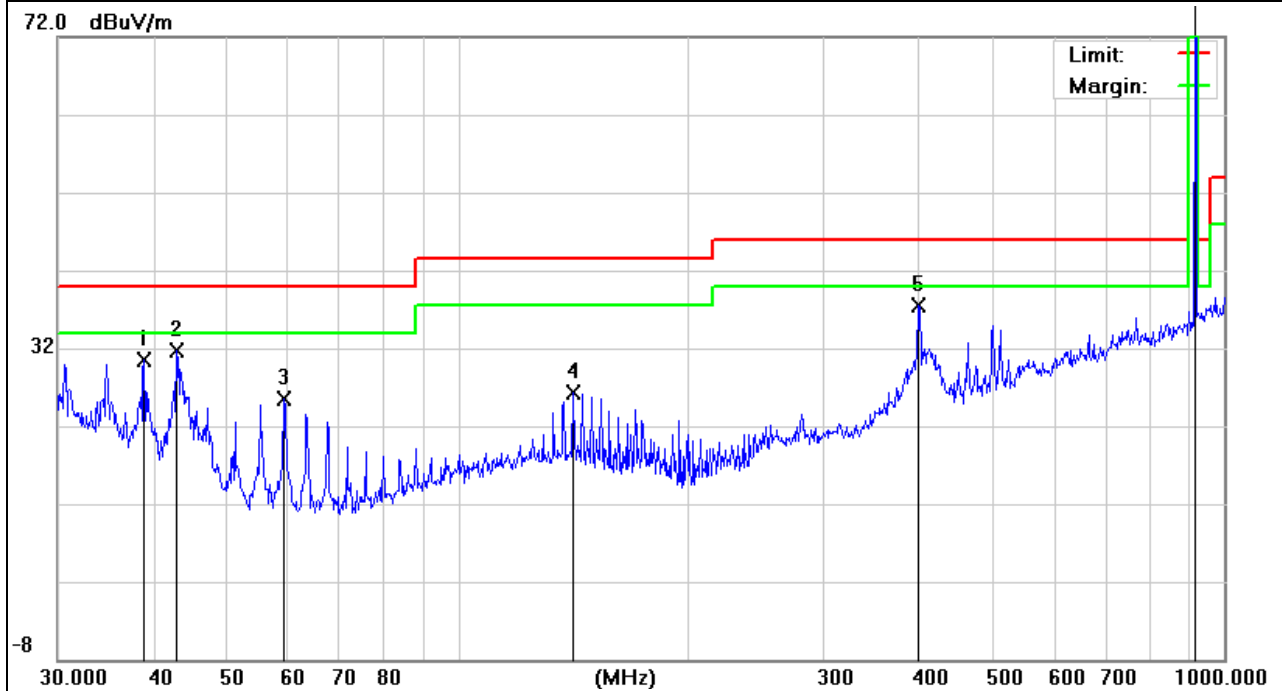

EUT :	USB Z-WAVE RADIO / ANTENNA	Model Name :	EL-SC-ZW
Temperature :	25 °C	Relative Humidity :	51%
Pressure :	1010 hPa	Test Voltage :	DC 5V
Test Mode :	Model 3	Polarization :	Horizontal

Frequency (MHz)	Meter Reading (dBμV)	Factor (dB)	Emission Level (dBμV/m)	Limits (dBμV/m)	Margin (dB)	Detector Type
46.9948	14.09	11.28	25.37	40.00	-14.63	QP
55.2207	15.88	7.16	23.04	40.00	-16.96	QP
145.3506	16.68	13.11	29.79	43.50	-13.71	QP
255.6231	15.24	15.40	30.64	46.00	-15.36	QP
400.4319	19.17	19.64	38.81	46.00	-7.19	QP
916.0000	66.81	29.82	96.63	114.00	-17.37	QP

Remark:

1. Factor = Antenna Factor + Cable Loss – Pre-amplifier.

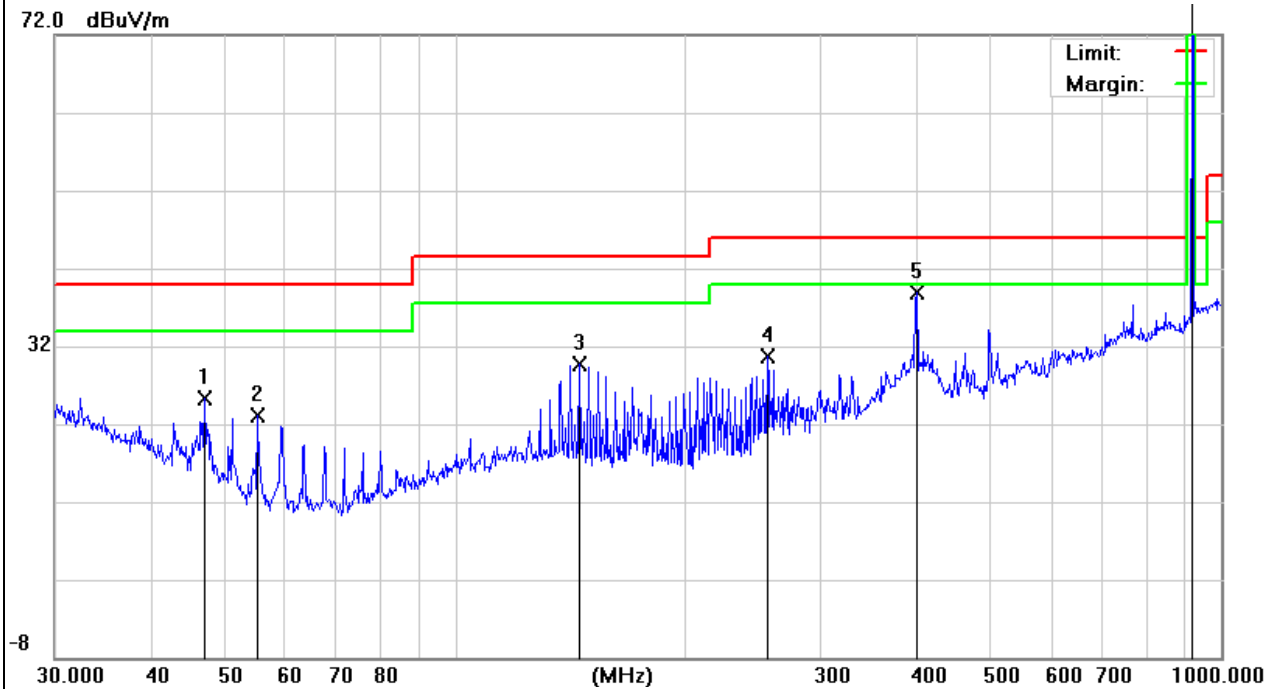

3.4.6 TEST RESULTS (ABOVE 1000 MHZ)

EUT :	USB Z-WAVE RADIO / ANTENNA	Model Name :	EL-SC-ZW
Temperature :	25 °C	Relative Humidity :	51%
Pressure :	1010 hPa	Test Voltage :	DC 5V
Test Mode :	Model 1	Polarization :	Horizontal

Frequency (MHz)	Meter Reading (dBμV)	Factor (dB)	Emission Level (dBμV/m)	Limits (dBμV/m)	Margin (dB)	Detector Type
2955.000	41.31	-2.45	38.86	74.00	-35.14	peak
2955.000	30.93	-2.45	28.48	54.00	-25.52	AVG
5377.500	34.28	7.03	41.31	74.00	-32.69	peak
5377.500	22.99	7.03	30.02	54.00	-23.98	AVG
13750.000	-9.73	61.20	51.47	74.00	-22.53	peak
13750.000	-21.10	61.20	40.10	54.00	-13.90	AVG

Remark:
Factor = Antenna Factor + Cable Loss – Pre-amplifier.
No emission above 18GHz.

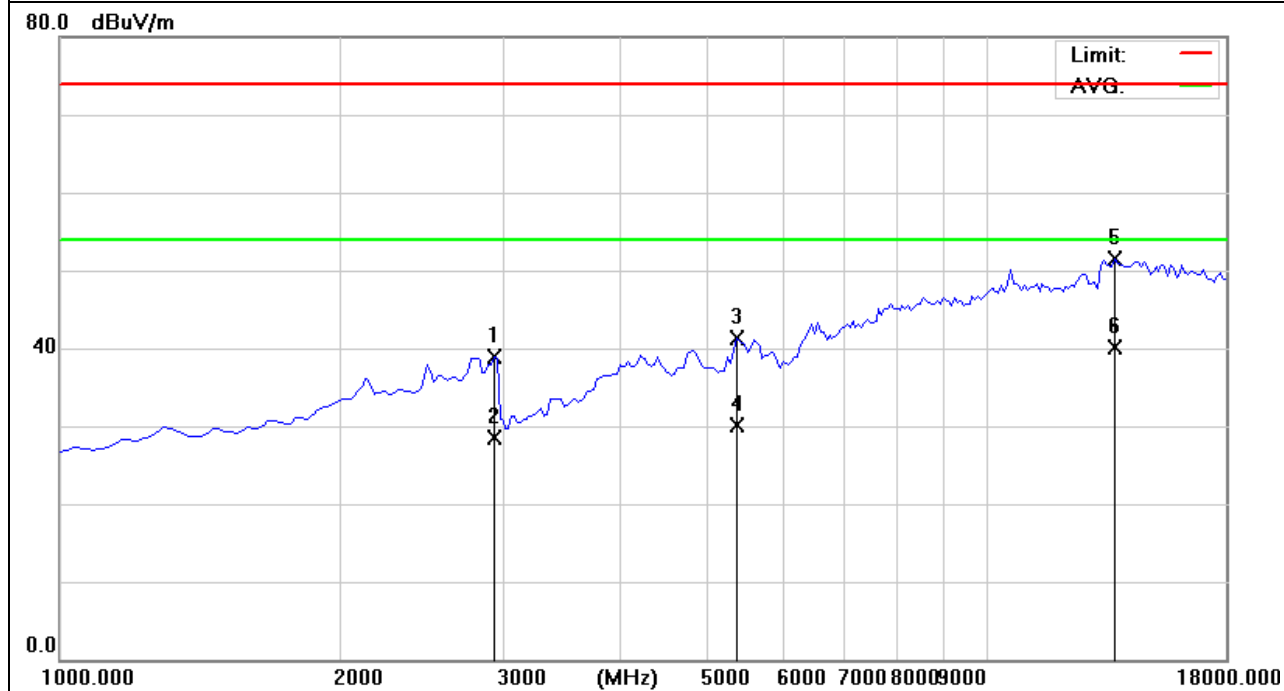

EUT :	USB Z-WAVE RADIO / ANTENNA	Model Name :	EL-SC-ZW
Temperature :	25 °C	Relative Humidity :	51%
Pressure :	1010 hPa	Test Voltage :	DC 5V
Test Mode :	Model 1	Polarization :	Vertical

Frequency (MHz)	Meter Reading (dBμV)	Factor (dB)	Emission Level (dBμV/m)	Limits (dBμV/m)	Margin (dB)	Detector Type
4230.000	35.58	3.60	39.18	74.00	-34.82	peak
4230.000	25.42	3.60	29.02	54.00	-24.98	AVG
10477.500	-6.49	55.74	49.25	74.00	-24.75	peak
10477.500	-20.19	55.74	35.55	54.00	-18.45	AVG
13410.000	-8.71	60.91	52.20	74.00	-21.80	peak
13410.000	-20.80	60.91	40.11	54.00	-13.89	AVG

Remark:
Factor = Antenna Factor + Cable Loss – Pre-amplifier.
No emission above 18GHz.

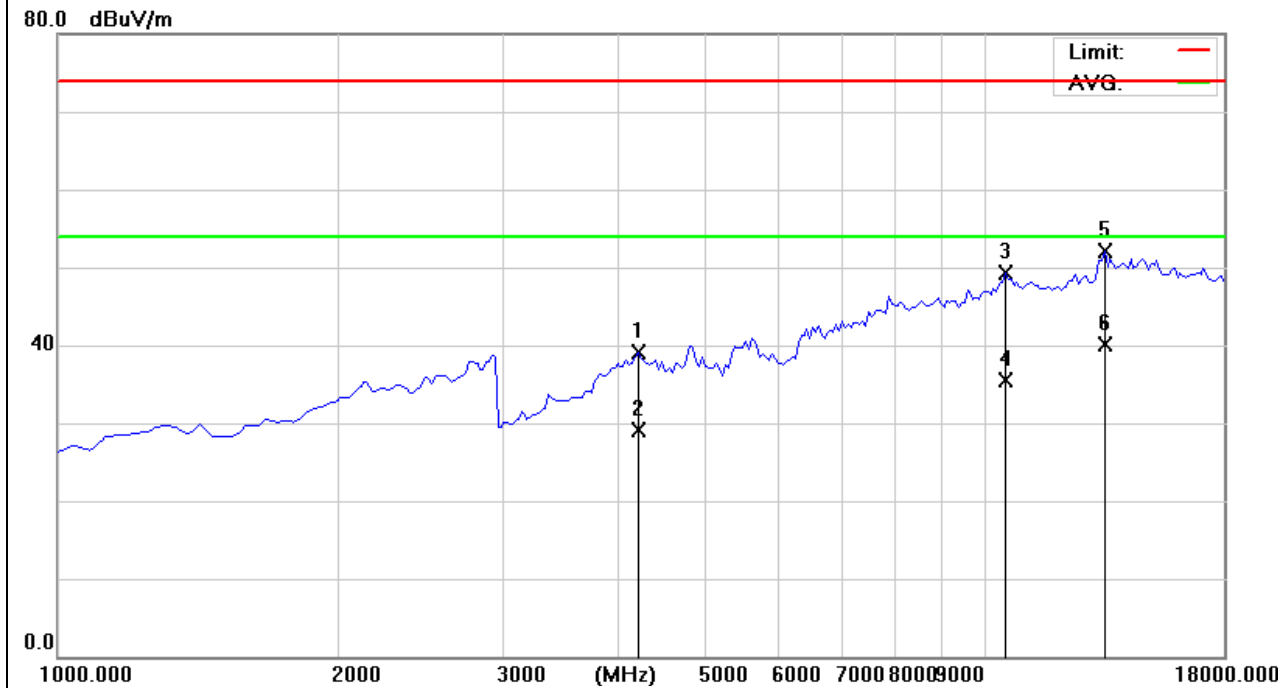

EUT :	USB Z-WAVE RADIO / ANTENNA	Model Name :	EL-SC-ZW
Temperature :	25 °C	Relative Humidity :	51%
Pressure :	1010 hPa	Test Voltage :	DC 5V
Test Mode :	Model 2	Polarization :	Horizontal

Frequency (MHz)	Meter Reading (dBμV)	Factor (dB)	Emission Level (dBμV/m)	Limits (dBμV/m)	Margin (dB)	Detector Type
2955.000	40.99	-2.45	38.54	74.00	-35.46	peak
2955.000	30.47	-2.45	28.02	54.00	-25.98	AVG
6440.000	-6.48	49.16	42.68	74.00	-31.32	peak
6440.000	-18.91	49.16	30.25	54.00	-23.75	AVG
13622.500	-9.27	60.69	51.42	74.00	-22.58	peak
13622.500	-29.03	60.69	31.66	54.00	-22.34	AVG

Remark:
Factor = Antenna Factor + Cable Loss – Pre-amplifier.
No emission above 18GHz.

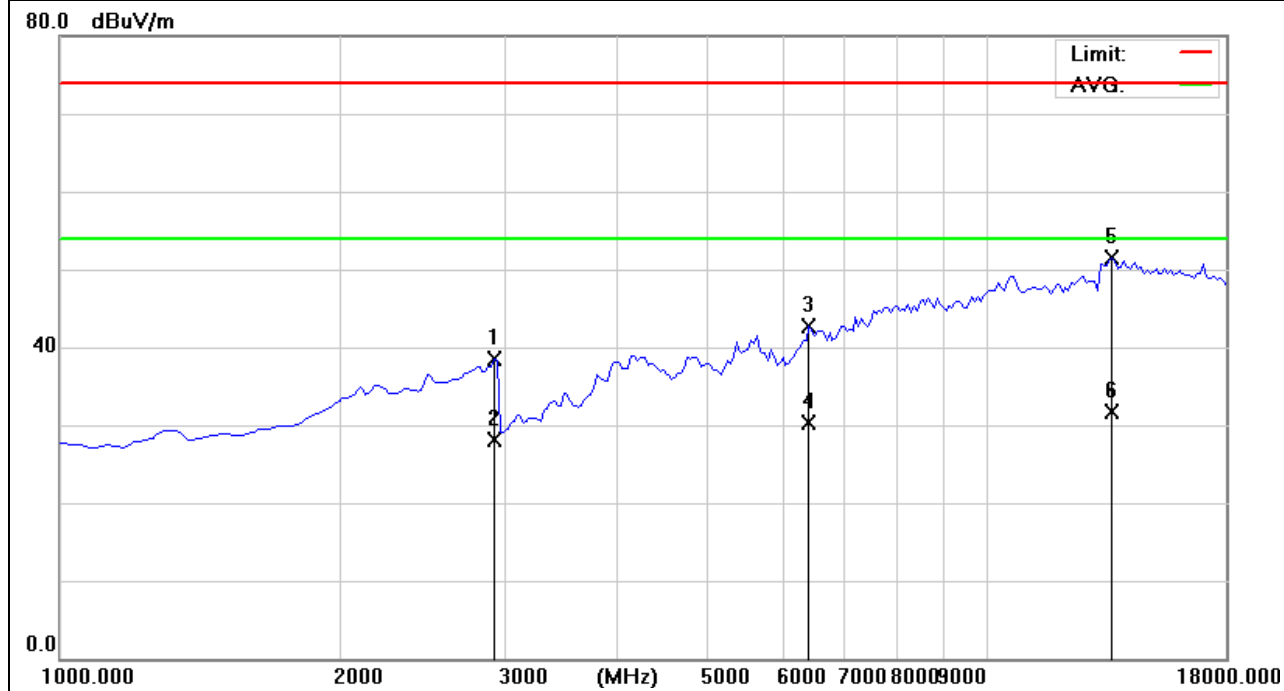

EUT :	USB Z-WAVE RADIO / ANTENNA	Model Name :	EL-SC-ZW
Temperature :	25 °C	Relative Humidity :	51%
Pressure :	1010 hPa	Test Voltage :	DC 5V
Test Mode :	Model 2	Polarization :	Vertical

Frequency (MHz)	Meter Reading (dBμV)	Factor (dB)	Emission Level (dBμV/m)	Limits (dBμV/m)	Margin (dB)	Detector Type
2147.500	39.72	-3.80	35.92	74.00	-38.08	peak
2147.500	29.46	-3.80	25.66	54.00	-28.34	AVG
5590.000	34.62	7.45	42.07	74.00	-31.93	peak
5590.000	21.20	7.45	28.65	54.00	-25.35	AVG
13920.000	-10.19	61.17	50.98	74.00	-23.02	peak
13920.000	-25.51	61.17	35.66	54.00	-18.34	AVG

Remark:
Factor = Antenna Factor + Cable Loss – Pre-amplifier.
No emission above 18GHz.

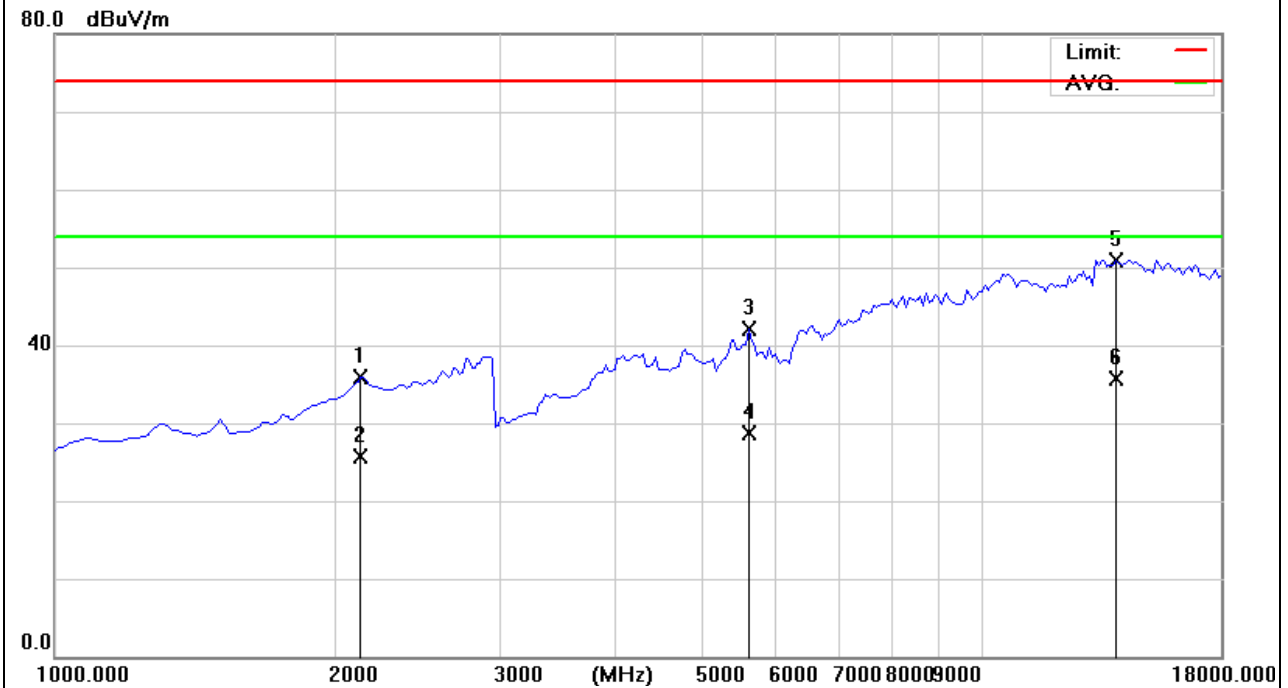

EUT :	USB Z-WAVE RADIO / ANTENNA	Model Name :	EL-SC-ZW
Temperature :	25 °C	Relative Humidity :	51%
Pressure :	1010 hPa	Test Voltage :	DC 5V
Test Mode :	Model 3	Polarization :	Horizontal

Frequency (MHz)	Meter Reading (dBμV)	Factor (dB)	Emission Level (dBμV/m)	Limits (dBμV/m)	Margin (dB)	Detector Type
2955.000	41.08	-2.45	38.63	74.00	-35.37	peak
2955.000	31.22	-2.45	28.77	54.00	-25.23	AVG
6440.000	-6.35	49.16	42.81	74.00	-31.19	peak
6440.000	-17.14	49.16	32.02	54.00	-21.98	AVG
13282.500	-9.13	60.85	51.72	74.00	-22.28	peak
13282.500	-30.40	60.85	30.45	54.00	-23.55	AVG

Remark:
Factor = Antenna Factor + Cable Loss – Pre-amplifier.
No emission above 18GHz.

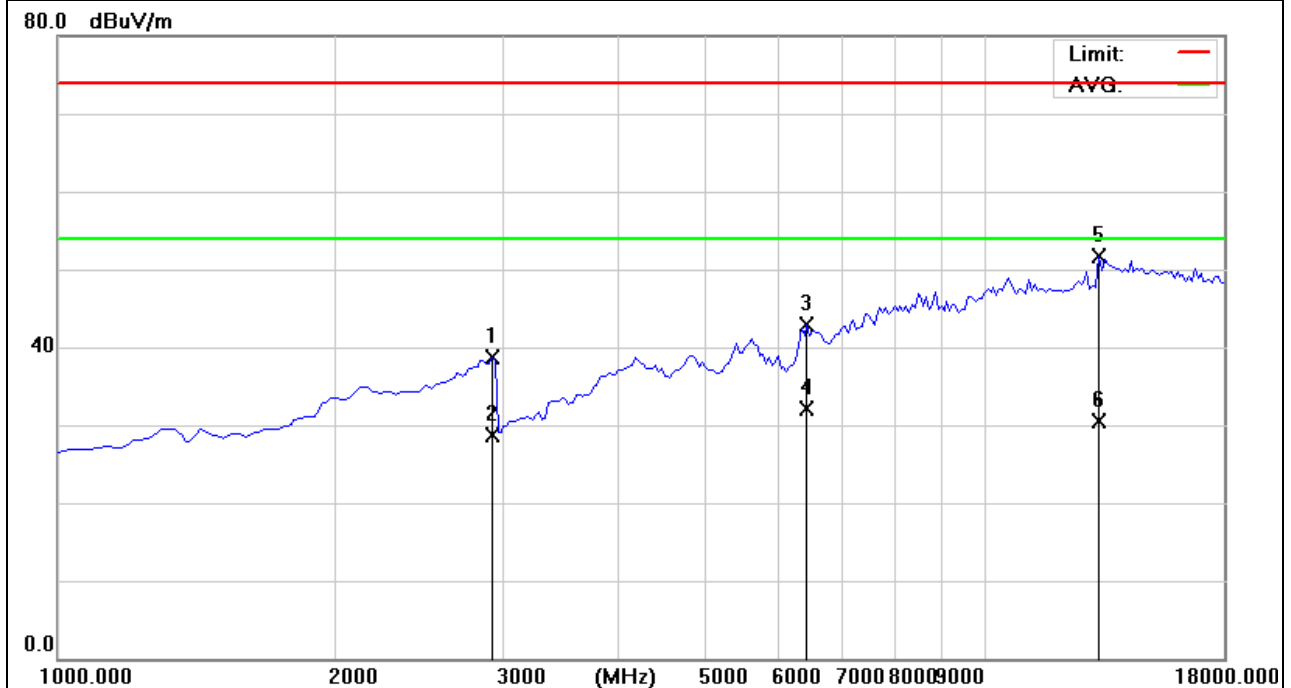

EUT :	USB Z-WAVE RADIO / ANTENNA	Model Name :	EL-SC-ZW
Temperature :	25 °C	Relative Humidity :	51%
Pressure :	1010 hPa	Test Voltage :	DC 5V
Test Mode :	Model 3	Polarization :	Vertical

Frequency (MHz)	Meter Reading (dBμV)	Factor (dB)	Emission Level (dBμV/m)	Limits (dBμV/m)	Margin (dB)	Detector Type
4782.500	34.00	6.15	40.15	74.00	-33.85	peak
4782.500	24.10	6.15	30.25	54.00	-23.75	AVG
10562.500	-6.91	56.38	49.47	74.00	-24.53	peak
10562.500	-20.73	56.38	35.65	54.00	-18.35	AVG
13537.500	-9.27	60.71	51.44	74.00	-22.56	peak
13537.500	-22.27	60.71	38.44	54.00	-15.56	AVG

Remark:
Factor = Antenna Factor + Cable Loss – Pre-amplifier.
No emission above 18GHz.

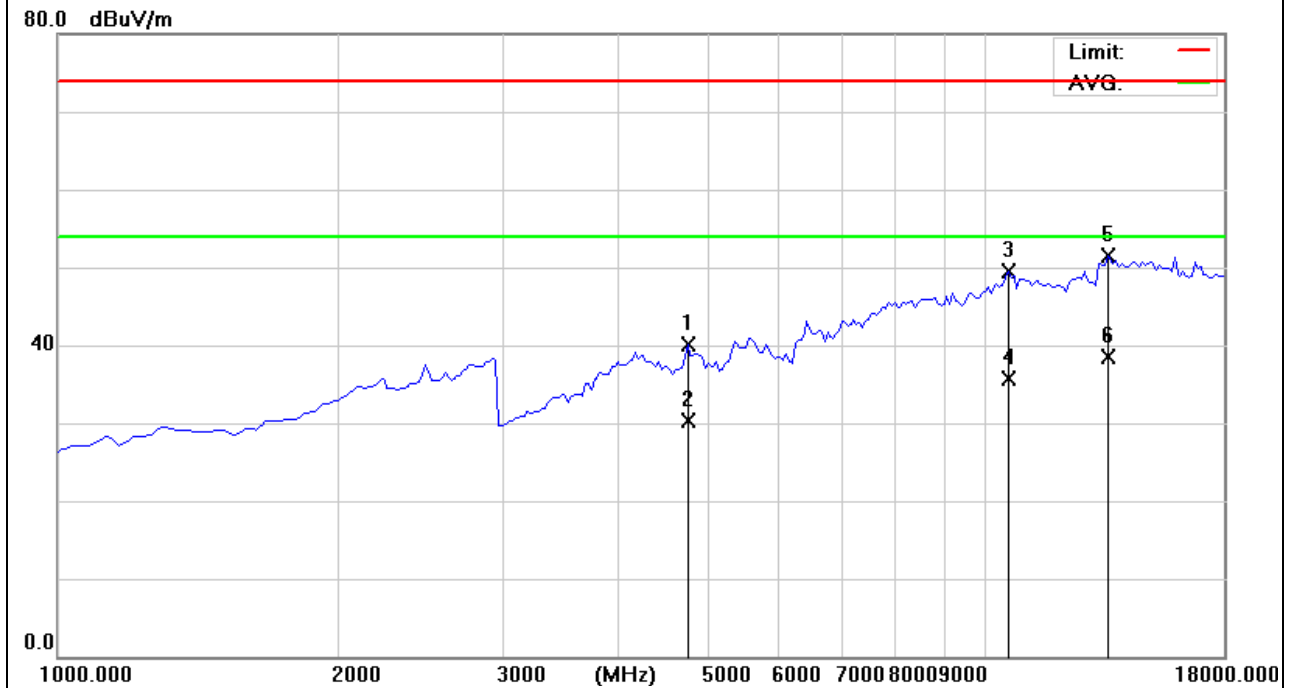

Note: EUT Pre-scan X/Y/Z orientation, only worst case is presented in the report(X orientation).

3.4.7 TEST RESULTS (RESTRICTED BANDS REQUIREMENTS)

EUT :	USB Z-WAVE RADIO / ANTENNA	Model Name :	EL-SC-ZW
Temperature :	25 °C	Relative Humidity :	51%
Pressure :	1010 hPa	Test Voltage :	DC 5V
Test Mode :	Mode 1	Polarization :	Horizontal

Frequency (MHz)	Meter Reading (dBμV)	Factor (dB)	Emission Level (dBμV/m)	Limits (dBμV/m)	Margin (dB)	Detector Type
890.1594	6.90	28.49	35.39	46.00	-10.61	QP
902.0000	6.21	29.04	35.25	46.00	-10.75	QP
928.0000	6.16	30.51	36.67	46.00	-9.33	QP
936.2708	6.42	30.79	37.21	46.00	-8.79	QP

Remark:
Factor = Antenna Factor + Cable Loss – Pre-amplifier.

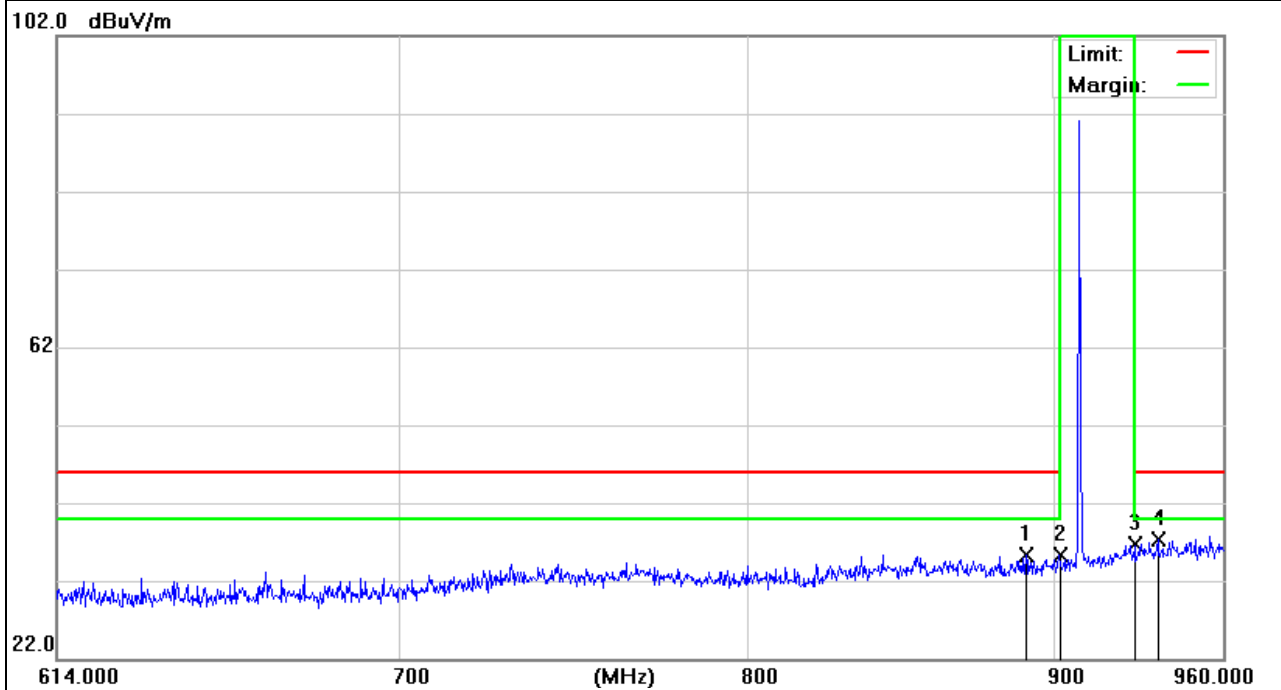

EUT :	USB Z-WAVE RADIO / ANTENNA	Model Name :	EL-SC-ZW
Temperature :	25 °C	Relative Humidity :	51%
Pressure :	1010 hPa	Test Voltage :	DC 5V
Test Mode :	Mode 1	Polarization :	Vertical

Frequency (MHz)	Meter Reading (dBμV)	Factor (dB)	Emission Level (dBμV/m)	Limits (dBμV/m)	Margin (dB)	Detector Type
890.9556	7.02	28.52	35.54	46.00	-10.46	QP
902.0000	6.27	29.04	35.31	46.00	-10.69	QP
928.0000	6.61	30.51	37.12	46.00	-8.88	QP
935.8523	7.38	30.78	38.16	46.00	-7.84	QP

Remark:
Factor = Antenna Factor + Cable Loss – Pre-amplifier.

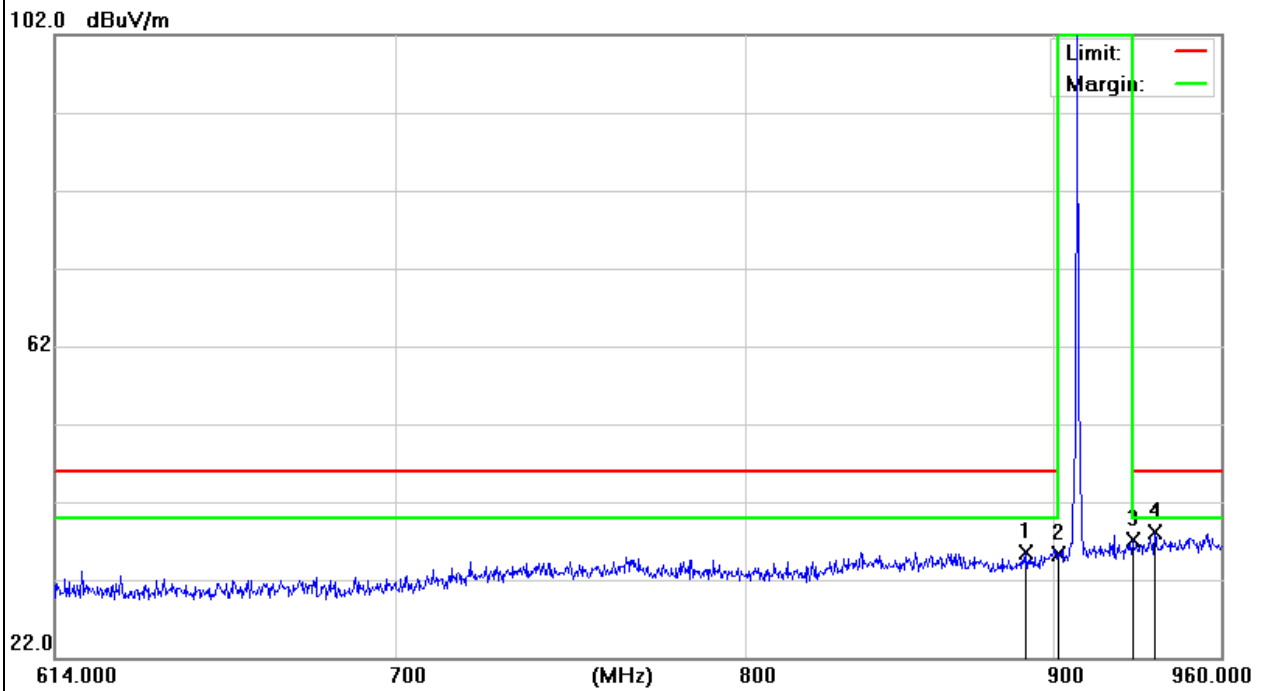

EUT :	USB Z-WAVE RADIO / ANTENNA	Model Name :	EL-SC-ZW
Temperature :	25 °C	Relative Humidity :	51%
Pressure :	1010 hPa	Test Voltage :	DC 5V
Test Mode :	Mode 2	Polarization :	Horizontal

Frequency (MHz)	Meter Reading (dBμV)	Factor (dB)	Emission Level (dBμV/m)	Limits (dBμV/m)	Margin (dB)	Detector Type
897.7508	8.05	28.81	36.86	46.00	-9.14	QP
902.0000	5.73	29.04	34.77	46.00	-11.23	QP
928.0000	6.27	30.51	36.78	46.00	-9.22	QP
944.6774	6.94	30.99	37.93	46.00	-8.07	QP

Remark:
Factor = Antenna Factor + Cable Loss – Pre-amplifier.

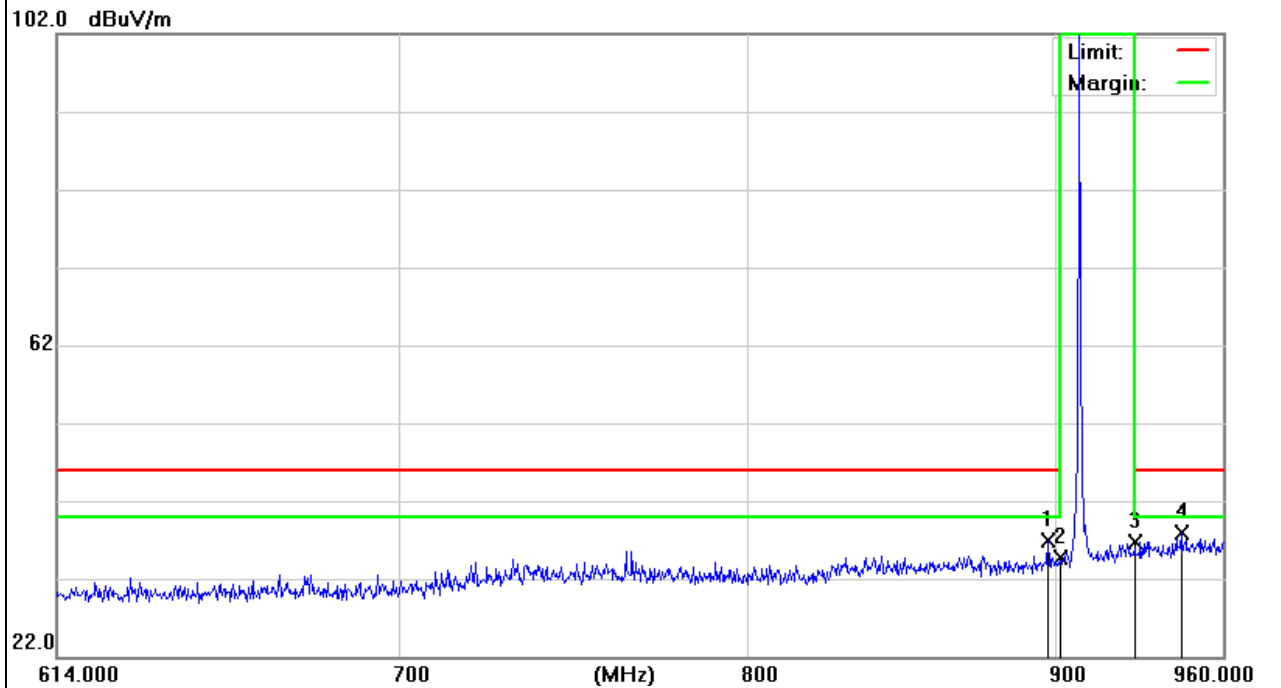

EUT :	USB Z-WAVE RADIO / ANTENNA	Model Name :	EL-SC-ZW
Temperature :	25 °C	Relative Humidity :	51%
Pressure :	1010 hPa	Test Voltage :	DC 5V
Test Mode :	Mode 2	Polarization :	Vertical

Frequency (MHz)	Meter Reading (dBμV)	Factor (dB)	Emission Level (dBμV/m)	Limits (dBμV/m)	Margin (dB)	Detector Type
880.6622	6.96	28.36	35.32	46.00	-10.68	QP
902.0000	6.03	29.04	35.07	46.00	-10.93	QP
928.0000	5.50	30.51	36.01	46.00	-9.99	QP
942.1475	6.66	30.93	37.59	46.00	-8.41	QP

Remark:
Factor = Antenna Factor + Cable Loss – Pre-amplifier.

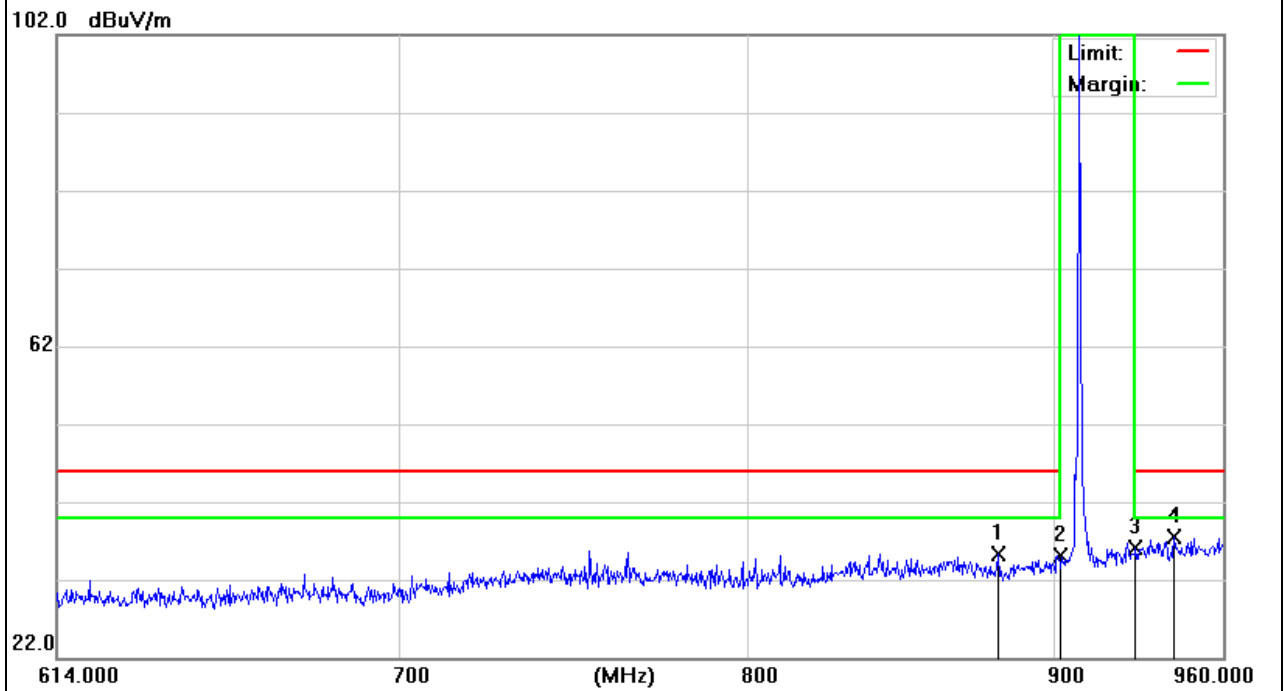

EUT :	USB Z-WAVE RADIO / ANTENNA	Model Name :	EL-SC-ZW
Temperature :	25 °C	Relative Humidity :	51%
Pressure :	1010 hPa	Test Voltage :	DC 5V
Test Mode :	Mode 3	Polarization :	Horizontal

Frequency (MHz)	Meter Reading (dBμV)	Factor (dB)	Emission Level (dBμV/m)	Limits (dBμV/m)	Margin (dB)	Detector Type
883.0270	6.37	28.39	34.76	46.00	-11.24	QP
902.0000	5.95	29.04	34.99	46.00	-11.01	QP
928.0000	6.58	30.51	37.09	46.00	-8.91	QP
947.2141	6.68	31.05	37.73	46.00	-8.27	QP

Remark:
Factor = Antenna Factor + Cable Loss – Pre-amplifier.

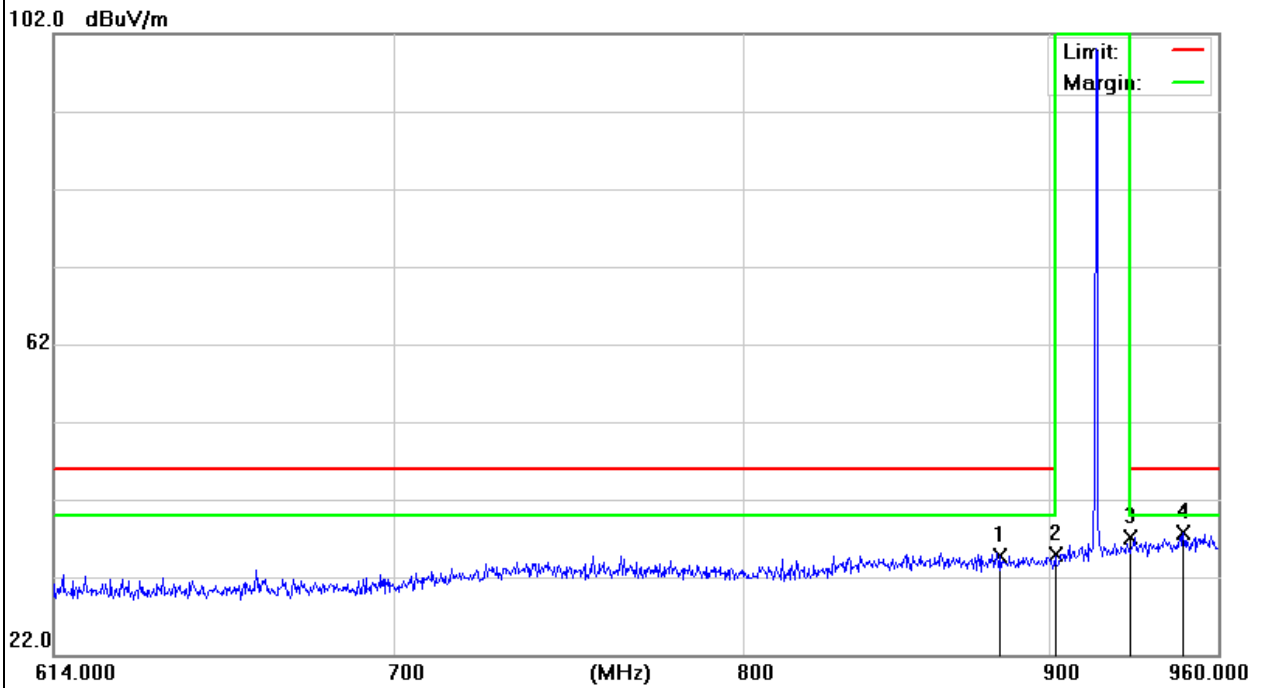

EUT :	USB Z-WAVE RADIO / ANTENNA	Model Name :	EL-SC-ZW
Temperature :	25 °C	Relative Humidity :	51%
Pressure :	1010 hPa	Test Voltage :	DC 5V
Test Mode :	Mode 3	Polarization :	Vertical

Frequency (MHz)	Meter Reading (dBμV)	Factor (dB)	Emission Level (dBμV/m)	Limits (dBμV/m)	Margin (dB)	Detector Type
884.6070	6.68	28.41	35.09	46.00	-10.91	QP
902.0000	6.79	29.04	35.83	46.00	-10.17	QP
928.0000	6.44	30.51	36.95	46.00	-9.05	QP
941.7264	6.78	30.92	37.70	46.00	-8.30	QP

Remark:
Factor = Antenna Factor + Cable Loss – Pre-amplifier.

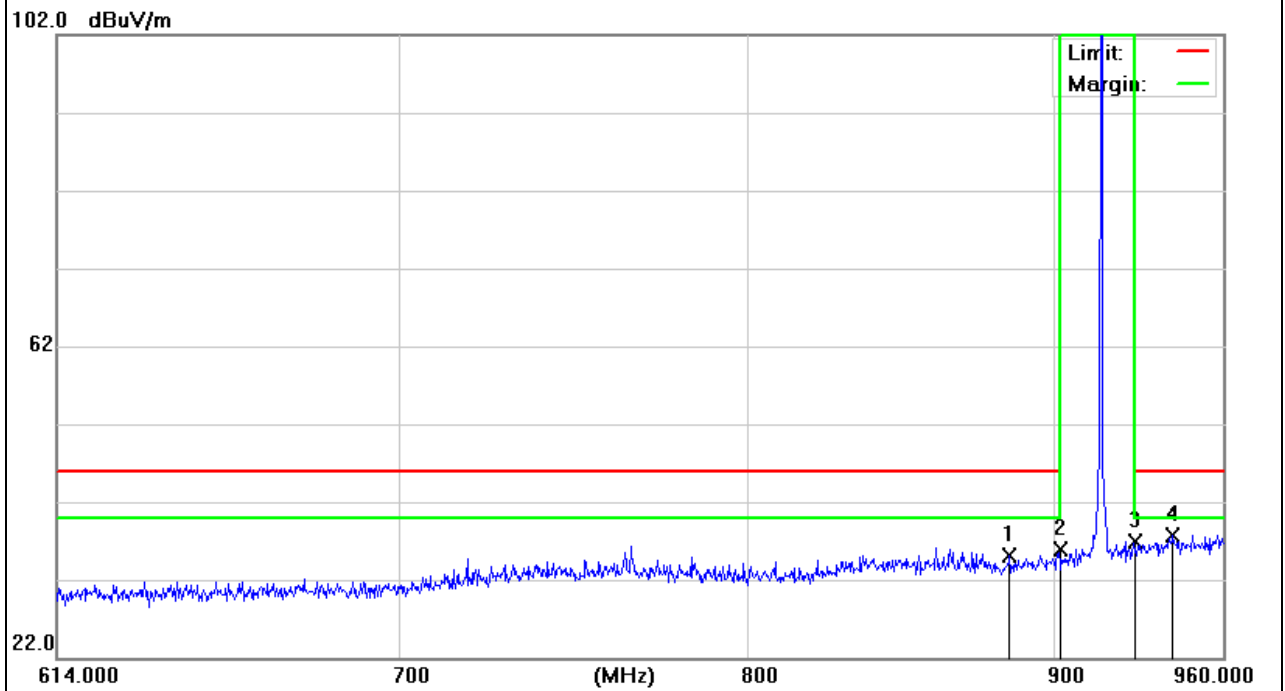

4. FREQUENCY TOLERANCE

4.1 FREQUENCY TOLERANCE LIMITS

The frequency tolerance of the carrier signal shall be maintained within $\pm 0.001\%$ of the operating frequency over a temperature variation of -20 degrees to $+50$ degrees C at normal supply voltage, and for a variation in the primary supply voltage from 85% to 115% of the rated supply voltage at a temperature of 20 degrees C.

4.2 TEST PROCEDURE

- a. The EUT was directly connected to the spectrum analyzer and antenna output port as show in the block diagram below,
- b. Spectrum Setting : RBW= 10KHz, VBW \geq RBW, Sweep time = Auto.

4.3 TEST SETUP



4.4 TEST RESULTS

EUT :	USB Z-WAVE RADIO / ANTENNA	Model Name :	EL-SC-ZW
Temperature :	26 °C	Relative Humidity :	53%
Pressure :	1020 hPa	Test Power :	DC 5V
Test Mode :	Model 1		

Voltage (V)	Frequency(MHz)	Reading(MHz)	Frequency Tolerance(ppm)	LIMIT(ppm)
4.5	908.4	908.393	-0.000771%	$\pm 0.001\%$
5	908.4	908.393	-0.000771%	$\pm 0.001\%$
5.5	908.4	908.392	-0.000881%	$\pm 0.001\%$

Temperature (°C)	Frequency(MHz)	Reading(MHz)	Frequency Tolerance(ppm)	LIMIT(ppm)
-20	908.4	908.393	-0.000771%	$\pm 0.001\%$
-10	908.4	908.391	-0.000991%	$\pm 0.001\%$
0	908.4	908.392	-0.000881%	$\pm 0.001\%$
10	908.4	908.393	-0.000771%	$\pm 0.001\%$
20	908.4	908.393	-0.000771%	$\pm 0.001\%$
30	908.4	908.392	-0.000881%	$\pm 0.001\%$
40	908.4	908.391	-0.000991%	$\pm 0.001\%$
50	908.4	908.393	-0.000771%	$\pm 0.001\%$

EUT :	USB Z-WAVE RADIO / ANTENNA	Model Name :	EL-SC-ZW
Temperature :	26 °C	Relative Humidity :	53%
Pressure :	1020 hPa	Test Power :	DC 5V
Test Mode :	Model 2		

Voltage (V)	Frequency(MHz)	Reading(MHz)	Frequency Tolerance(ppm)	LIMIT(ppm)
4.5	908.42	908.411	-0.000991%	±0.001%
5	908.42	908.413	-0.000771%	±0.001%
5.5	908.42	908.415	-0.000550%	±0.001%

Temperature (°C)	Frequency(MHz)	Reading(MHz)	Frequency Tolerance(ppm)	LIMIT(ppm)
-20	908.42	908.415	-0.000550%	±0.001%
-10	908.42	908.411	-0.000991%	±0.001%
0	908.42	908.413	-0.000771%	±0.001%
10	908.42	908.412	-0.000881%	±0.001%
20	908.42	908.415	-0.000550%	±0.001%
30	908.42	908.417	-0.000330%	±0.001%
40	908.42	908.413	-0.000771%	±0.001%
50	908.42	908.415	-0.000550%	±0.001%

EUT :	USB Z-WAVE RADIO / ANTENNA	Model Name :	EL-SC-ZW
Temperature :	26 °C	Relative Humidity :	53%
Pressure :	1020 hPa	Test Power :	DC 5V
Test Mode :	Model 3		

Voltage (V)	Frequency(MHz)	Reading(MHz)	Frequency Tolerance(ppm)	LIMIT(ppm)
4.5	916	915.996	-0.000437%	916
5	916	915.993	-0.000764%	916
5.5	916	915.992	-0.000873%	916

Temperature (°C)	Frequency(MHz)	Reading(MHz)	Frequency Tolerance(ppm)	LIMIT(ppm)
-20	916	915.996	-0.000437%	±0.001%
-10	916	915.994	-0.000655%	±0.001%
0	916	915.994	-0.000655%	±0.001%
10	916	915.992	-0.000873%	±0.001%
20	916	915.995	-0.000546%	±0.001%
30	916	915.994	-0.000655%	±0.001%
40	916	915.995	-0.000546%	±0.001%
50	916	915.994	-0.000655%	±0.001%

5. BANDWIDTH TEST

5.1 TEST PROCEDURE

- a. The EUT was directly connected to the spectrum analyzer and antenna output port as show in the block diagram below,
- b. Spectrum Setting : RBW= 100KHz, VBW \geq RBW, Sweep time = Auto.

5.1 DEVIATION FROM STANDARD

No deviation.

5.1 TEST SETUP

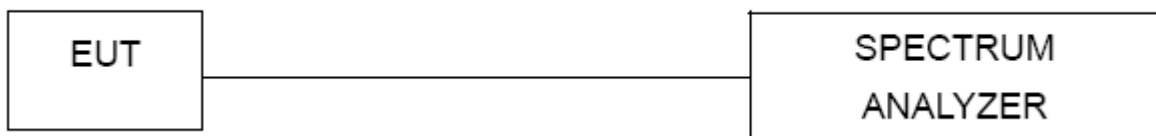

6. TEST RESULTS

EUT :	USB Z-WAVE RADIO / ANTENNA	Model Name :	EL-SC-ZW
Temperature :	26 °C	Relative Humidity :	53%
Pressure :	1020 hPa	Test Power :	DC 5V
Test Mode :	Model 1/2/3		

Test Channel	Frequency (MHz)	20 dBc Bandwidth (MHz)
CH01	908.4	0.318
CH02	908.42	0.319
CH03	916	0.325

908.4 MHz

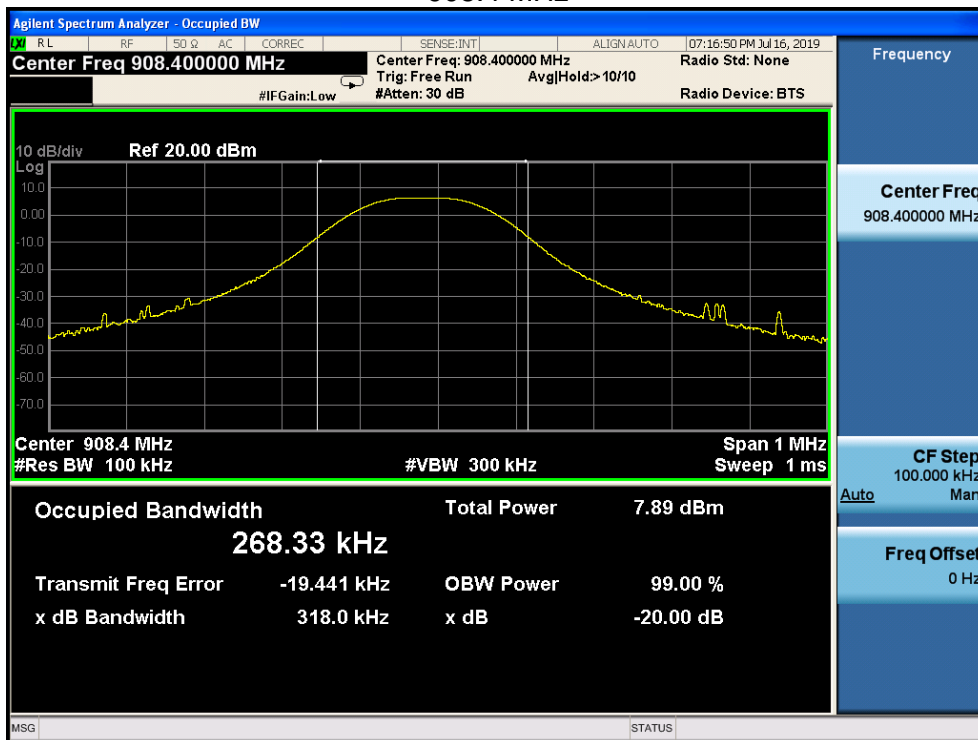

908.42 MHz

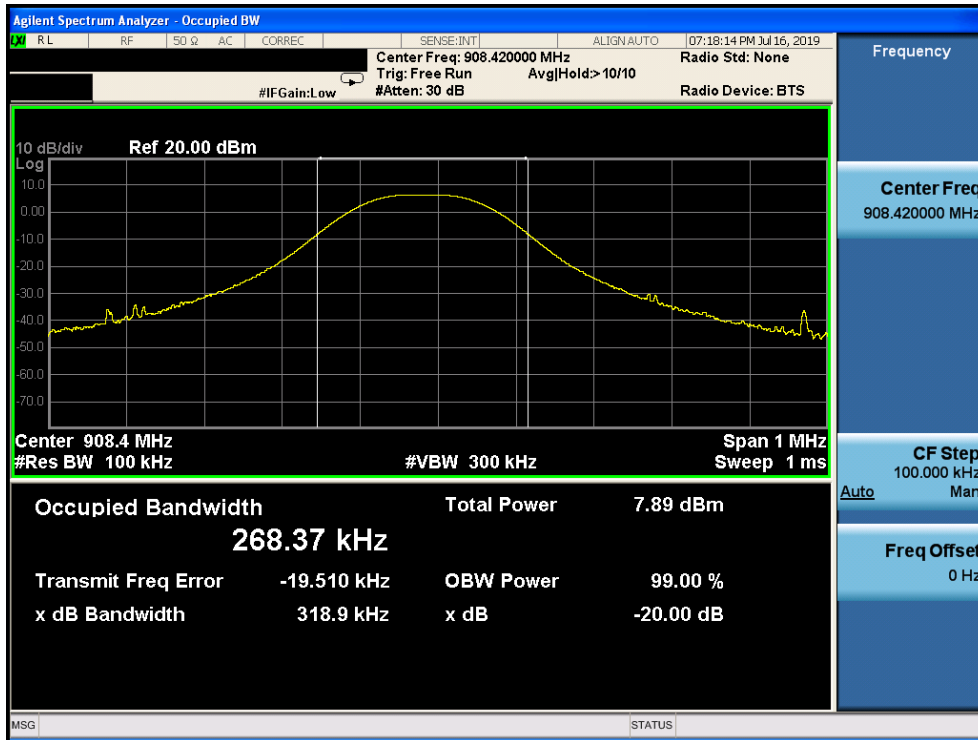

916 MHz

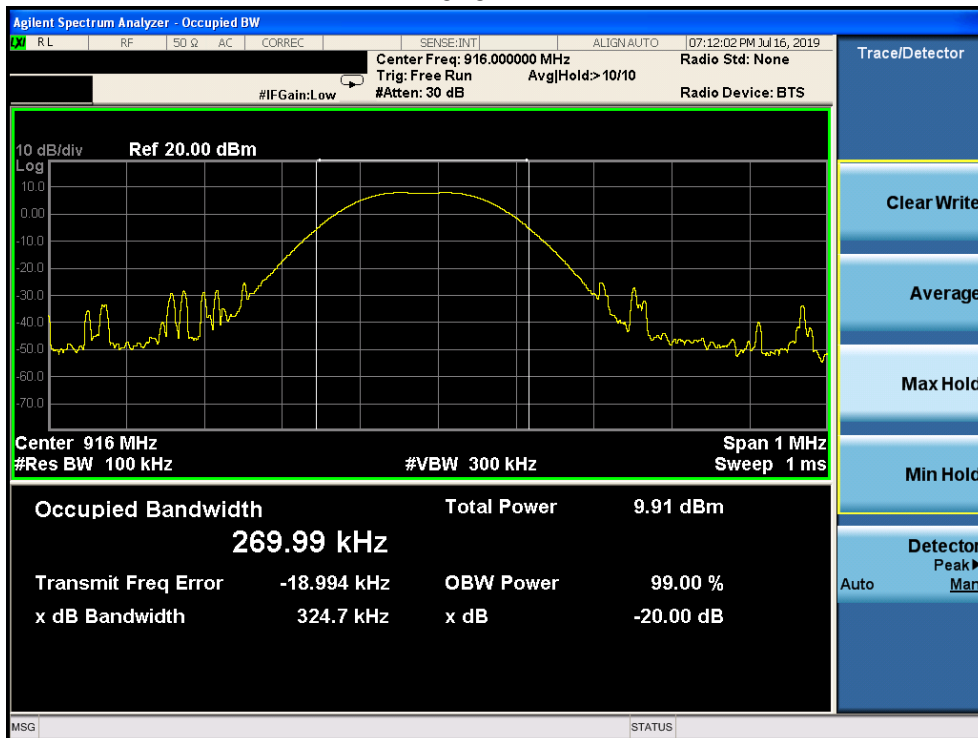

END OF REPORT