



# FCC TEST REPORT

**REPORT NO.:** RF120313D01-2

**MODEL NO.:** RG-1179

**FCC ID:** E8HRG-1179

**RECEIVED:** Mar. 13, 2012

**TESTED:** Mar. 13 ~ 14, 2012

**ISSUED:** Mar. 16, 2012

**APPLICANT:** Chicony Electronics Co., Ltd.

**ADDRESS:** No. 25, Wu-Gong 6th Rd., Wu Ku Industrial Park,  
Taipei Hsien, Taiwan, R.O.C.

**ISSUED BY:** Bureau Veritas Consumer Products Services (H.K.)  
Ltd., Taoyuan Branch

**LAB LOCATION:** No. 47, 14th Ling, Chia Pau Vil., Lin Kou Dist., New  
Taipei City, Taiwan ( R.O.C. )

This test report consists of 30 pages in total. It may be duplicated completely for legal use with the approval of the applicant. It should not be reproduced except in full, without the written approval of our laboratory. The client should not use it to claim product endorsement by TAF or any government agencies. The test results in the report only apply to the tested sample.



# Table of Contents

RELEASE CONTROL RECORD.....	3
1. CERTIFICATION .....	4
2. SUMMARY OF TEST RESULTS .....	5
2.1 MEASUREMENT UNCERTAINTY .....	5
3. GENERAL INFORMATION.....	6
3.1 GENERAL DESCRIPTION OF EUT .....	6
3.2 DESCRIPTION OF TEST MODES .....	7
3.2.1 CONFIGURATION OF SYSTEM UNDER TEST .....	7
3.2.2 TEST MODE APPLICABILITY AND TESTED CHANNEL DETAIL: .....	8
3.3 GENERAL DESCRIPTION OF APPLIED STANDARDS .....	10
3.4 DESCRIPTION OF SUPPORT UNITS .....	10
4. TEST TYPES AND RESULTS .....	11
4.1 CONDUCTED EMISSION MEASUREMENT .....	11
4.1.1 LIMITS OF CONDUCTED EMISSION MEASUREMENT .....	11
4.1.2 TEST INSTRUMENTS .....	11
4.1.3 TEST PROCEDURES .....	12
4.1.4 DEVIATION FROM TEST STANDARD .....	12
4.1.5 TEST SETUP .....	12
4.1.6 EUT OPERATING CONDITIONS .....	13
4.1.7 TEST RESULTS .....	14
4.2 RADIATED EMISSION MEASUREMENT .....	16
4.2.1 LIMITS OF RADIATED EMISSION MEASUREMENT .....	16
4.2.2 TEST INSTRUMENTS .....	17
4.2.3 TEST PROCEDURES .....	18
4.2.4 DEVIATION FROM TEST STANDARD .....	18
4.2.5 TEST SETUP .....	19
4.2.6 EUT OPERATING CONDITIONS .....	19
4.2.7 TEST RESULTS .....	20
4.3 BAND EDGES MEASUREMENT .....	25
4.3.1 LIMITS OF BAND EDGES MEASUREMENT .....	25
4.3.2 TEST INSTRUMENTS .....	25
4.3.3 TEST PROCEDURE .....	25
4.3.4 DEVIATION FROM TEST STANDARD .....	25
4.3.5 EUT OPERATING CONDITION .....	25
4.3.6 TEST RESULTS .....	25
5. PHOTOGRAPHS OF THE TEST CONFIGURATION .....	28
6. INFORMATION ON THE TESTING LABORATORIES .....	29
7. APPENDIX A – MODIFICATIONS RECORDERS FOR ENGINEERING CHANGES TO THE EUT BY THE LAB .....	30



A D T

## RELEASE CONTROL RECORD

ISSUE NO.	REASON FOR CHANGE	DATE ISSUED
RF120313D01-2	Original release	Mar. 16, 2012



## 1. CERTIFICATION

**PRODUCT:** Dongle  
**BRAND NAME:** TOSHIBA  
**MODEL NO.:** RG-1179  
**APPLICANT:** Chicony Electronics Co., Ltd.  
**TESTED:** Mar. 13 ~ 14, 2012  
**TEST ITEM:** ENGINEERING SAMPLE  
**STANDARDS:** FCC Part 15, Subpart C (Section 15.249)  
ANSI C63.10-2009

The above equipment has been tested by **Bureau Veritas Consumer Products Services (H.K.) Ltd., Taoyuan Branch**, and found compliance with the requirement of the above standards. The test record, data evaluation & Equipment Under Test (EUT) configurations represented herein are true and accurate accounts of the measurements of the sample's EMC characteristics under the conditions specified in this report.

**PREPARED BY :** Annie Chang , **DATE:** Mar. 16, 2012  
( Annie Chang / Senior Specialist )

**APPROVED BY :** Gary Chang , **DATE:** Mar. 16, 2012  
Gary Chang / Technical Manager

## 2. SUMMARY OF TEST RESULTS

The EUT has been tested according to the following specifications:

APPLIED STANDARD: FCC Part 15, Subpart C (Section 15.249)			
STANDARD SECTION	TEST TYPE AND LIMIT	RESULT	REMARK
15.207	Conducted Emission Test	PASS	Minimum passing margin is -12.25dB at 0.56017MHz
15.209 15.249 15.249 (d)	Radiated Emission Test Band Edge Measurement Limit: 50dB less than the peak value of fundamental frequency or meet radiated emission limit in section 12.209	PASS	Minimum passing margin is -9.5dB at 134.91MHz

### 2.1 MEASUREMENT UNCERTAINTY

Where relevant, the following measurement uncertainty levels have been estimated for tests performed on the EUT as specified in CISPR 16-4-2:

This uncertainty represents an expanded uncertainty expressed at approximately the 95% confidence level using a coverage factor of k=2.

Measurement	Frequency	Uncertainty
Conducted emissions	150kHz ~ 30MHz	2.41 dB
Radiated emissions	30MHz ~ 1GHz	3.78 dB
	Above 1GHz	3.36 dB

### 3. GENERAL INFORMATION

#### 3.1 GENERAL DESCRIPTION OF EUT

<b>EUT</b>	Dongle
<b>MODEL NO.</b>	RG-1179
<b>FCC ID</b>	E8HRG-1179
<b>POWER SUPPLY</b>	5Vdc from host equipment
<b>MODULATION TYPE</b>	GFSK
<b>OPERATING FREQUENCY</b>	2403MHz ~ 2480MHz
<b>NUMBER OF CHANNEL</b>	78
<b>ANTENNA TYPE</b>	Strip antenna with -4.40dBi gain
<b>ANTENNA CONNECTOR</b>	N/A
<b>DATA CABLE</b>	N/A
<b>I/O PORTS</b>	USB port
<b>ASSOCIATED DEVICES</b>	N/A

#### NOTE:

1. The EUT is a transceiver.
2. The above EUT information was declared by the manufacturer and for more detailed features description, please refer to the manufacturer's specifications or User's Manual.

### 3.2 DESCRIPTION OF TEST MODES

78 channels are provided to this EUT:

CHANNEL	FREQ. (MHZ)	CHANNEL	FREQ. (MHZ)	CHANNEL	FREQ. (MHZ)	CHANNEL	FREQ. (MHZ)
1	2403	21	2423	41	2443	61	2463
2	2404	22	2424	42	2444	62	2464
3	2405	23	2425	43	2445	63	2465
4	2406	24	2426	44	2446	64	2466
5	2407	25	2427	45	2447	65	2467
6	2408	26	2428	46	2448	66	2468
7	2409	27	2429	47	2449	67	2469
8	2410	28	2430	48	2450	68	2470
9	2411	29	2431	49	2451	69	2471
10	2412	30	2432	50	2452	70	2472
11	2413	31	2433	51	2453	71	2473
12	2414	32	2434	52	2454	72	2474
13	2415	33	2435	53	2455	73	2475
14	2416	34	2436	54	2456	74	2476
15	2417	35	2437	55	2457	75	2477
16	2418	36	2438	56	2458	76	2478
17	2419	37	2439	57	2459	77	2479
18	2420	38	2440	58	2460	78	2480
19	2421	39	2441	59	2461		
20	2422	40	2442	60	2462		

#### 3.2.1 CONFIGURATION OF SYSTEM UNDER TEST

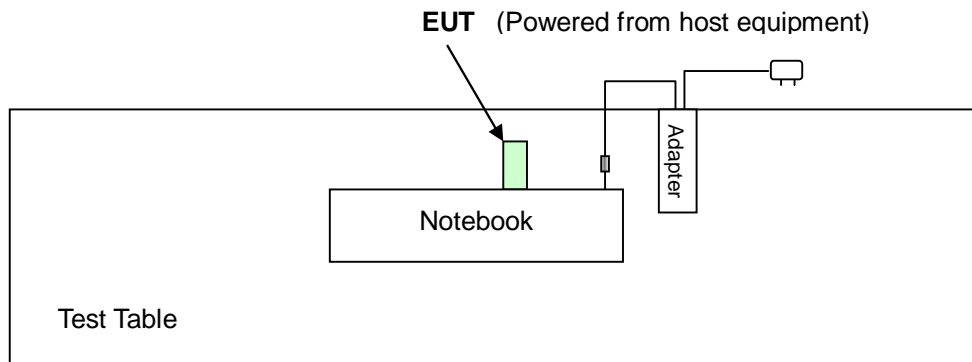

### 3.2.2 TEST MODE APPLICABILITY AND TESTED CHANNEL DETAIL:

EUT configure mode	Applicable to				Description
	PLC	RE<1G	RE <sup>≥</sup> 1G	BM	
-	√	√	√	√	-

Where PLC: Power Line Conducted Emission RE<1G RE: Radiated Emission below 1GHz  
 RE≥1G: Radiated Emission above 1GHz BM: Bandedge Measurement

#### **POWER LINE CONDUCTED EMISSION TEST:**

- Following channel(s) was (were) selected for the final test as listed below.

AVAILABLE CHANNEL	TESTED CHANNEL	MODULATION TYPE
1 to 78	1	GFSK

#### **RADIATED EMISSION TEST (BELOW 1 GHz):**

- Pre-Scan has been conducted to determine the worst-case mode from all possible combinations between available modulations and antenna ports (if EUT with antenna diversity architecture).
- Following channel(s) was (were) selected for the final test as listed below.

AVAILABLE CHANNEL	TESTED CHANNEL	MODULATION TYPE
1 to 78	1	GFSK

#### **RADIATED EMISSION TEST (ABOVE 1 GHz):**

- Pre-Scan has been conducted to determine the worst-case mode from all possible combinations between available modulations and antenna ports (if EUT with antenna diversity architecture).
- Following channel(s) was (were) selected for the final test as listed below.

AVAILABLE CHANNEL	TESTED CHANNEL	MODULATION TYPE
1 to 78	1, 39, 78	GFSK

#### **BANDEDGE MEASUREMENT:**

- Pre-Scan has been conducted to determine the worst-case mode from all possible combinations between available modulations and antenna ports (if EUT with antenna diversity architecture).
- Following channel(s) was (were) selected for the final test as listed below.

AVAILABLE CHANNEL	TESTED CHANNEL	MODULATION TYPE
1 to 78	1, 78	GFSK





A D T

**TEST CONDITION:**

APPLICABLE TO	ENVIRONMENTAL CONDITIONS	INPUT POWER (SYSTEM)	TESTED BY
PLC	17deg. C, 82% RH	120Vac, 60Hz	Nick Chen
RE <sup>3</sup> 1G	17deg. C, 78% RH	120Vac, 60Hz	Jun Wu
RE<1G	17deg. C, 78% RH	120Vac, 60Hz	Jun Wu
BM	16deg. C, 72% RH	120Vac, 60Hz	Jamison Chan



### 3.3 GENERAL DESCRIPTION OF APPLIED STANDARDS

The EUT is a RF product. According to the specifications of the manufacturer, it must comply with the requirements of the following standards:

**FCC Part 15, Subpart C (Section 15.249)**  
**ANSI C63.10-2009**

**NOTE:** The product has been verified to comply with the requirements of FCC Part 15, Subpart B, Class B (DoC). The test report has been issued separately.

All test items have been performed and recorded as per the above standards.

### 3.4 DESCRIPTION OF SUPPORT UNITS

The EUT has been tested as an independent unit together with other necessary accessories or support units. The following support units or accessories were used to form a representative test configuration during the tests.

NO.	PRODUCT	BRAND	MODEL NO.	SERIAL NO.	FCC ID
1	NOTEBOOK COMPUTER	DELL	PP27L	8SNZ12S	FCC DoC Approved

NO.	SIGNAL CABLE DESCRIPTION OF THE ABOVE SUPPORT UNITS
1	N/A

**NOTE:** All power cords of the above support units are non shielded (1.8m).

## 4. TEST TYPES AND RESULTS

### 4.1 CONDUCTED EMISSION MEASUREMENT

#### 4.1.1 LIMITS OF CONDUCTED EMISSION MEASUREMENT

FREQUENCY OF EMISSION (MHz)	CONDUCTED LIMIT (dB $\mu$ V)	
	Quasi-peak	Average
0.15-0.5	66 to 56	56 to 46
0.5-5	56	46
5-30	60	50

**NOTE:**

1. The lower limit shall apply at the transition frequencies.
2. All emanations from a class A/B digital device or system, including any network of conductors and apparatus connected thereto, shall not exceed the level of field strengths specified above.

#### 4.1.2 TEST INSTRUMENTS

DESCRIPTION & MANUFACTURER	MODEL NO.	SERIAL NO.	CALIBRATED DATE	CALIBRATED UNTIL
ROHDE & SCHWARZ Test Receiver	ESCS 30	100276	Jan. 04, 2012	Jan. 03, 2013
ROHDE & SCHWARZ Artificial Mains Network (for EUT)	ESH3-Z5	100219	Nov. 24, 2011	Nov. 23, 2012
LISN With Adapter (for EUT)	AD10	C10Ada-001	Nov. 24, 2011	Nov. 23, 2012
ROHDE & SCHWARZ Artificial Mains Network (for peripherals)	ESH3-Z5	100218	Dec. 08, 2011	Dec. 07, 2012
Software	ADT_Cond_V7.3.7	NA	NA	NA
Software	ADT_ISN_V7.3.7	NA	NA	NA
RF cable (JYEBAO)	5D-FB	Cable-C10.01	Feb. 20, 2012	Feb. 19, 2013
SUHNER Terminator (For ROHDE & SCHWARZ LISN)	65BNC-5001	E1-010773	Feb. 22, 2012	Feb. 21, 2013

- NOTE:**
1. The calibration interval of the above test instruments is 12 months and the calibrations are traceable to NML/ROC and NIST/USA.
  2. The test was performed in Shielded Room No. 10.
  3. The VCCI Site Registration No. C-1852.

### 4.1.3 TEST PROCEDURES

- a. The EUT was placed 0.4 meters from the conducting wall of the shielded room with EUT being connected to the power mains through a line impedance stabilization network (LISN). Other support units were connected to the power mains through another LISN. The two LISNs provide 50 ohm/ 50uH of coupling impedance for the measuring instrument.
- b. Both lines of the power mains connected to the EUT were checked for maximum conducted interference.
- c. The frequency range from 150kHz to 30MHz was searched. Emission levels under limit - 20dB was not recorded.

### 4.1.4 DEVIATION FROM TEST STANDARD

No deviation.

### 4.1.5 TEST SETUP

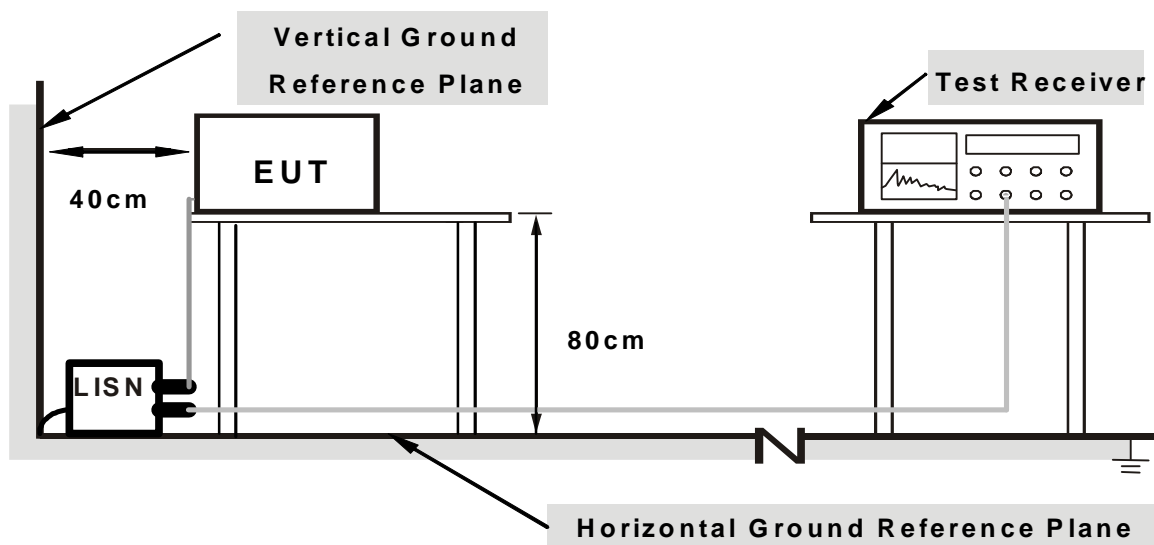

- Note:**
1. Support units were connected to second LISN.
  2. Both of LISNs (AMN) are 80 cm from EUT and at least 80 from other units and other metal planes

For the actual test configuration, please refer to the related item – Photographs of the Test Configuration.

#### **4.1.6 EUT OPERATING CONDITIONS**

- a. Connected the EUT to a notebook placed on a testing table.
- b. The notebook ran a test program (provided by manufacturer) to enable EUT under transmission/receiving condition continuously at specific channel frequency.



A D T

## 4.1.7 TEST RESULTS

### CONDUCTED WORST CASE DATA

PHASE	Line 1	6dB BANDWIDTH	9 kHz
CHANNEL	Channel 1		

No	Freq. [MHz]	Corr. Factor (dB)	Reading Value		Emission Level		Limit		Margin	
			[dB (uV)]		[dB (uV)]		[dB (uV)]		(dB)	
			Q.P.	AV.	Q.P.	AV.	Q.P.	AV.	Q.P.	AV.
1	0.24375	0.16	42.34	-	42.50	-	61.97	51.97	-19.47	-
2	0.45206	0.19	35.63	-	35.82	-	56.84	46.84	-21.01	-
3	1.02293	0.23	36.94	-	37.17	-	56.00	46.00	-18.83	-
4	2.49092	0.32	31.22	-	31.54	-	56.00	46.00	-24.46	-
5	6.15497	0.53	27.13	-	27.66	-	60.00	50.00	-32.34	-
6	17.14009	1.13	28.31	-	29.44	-	60.00	50.00	-30.56	-

- REMARKS:**
1. Q.P. and AV. are abbreviations of quasi-peak and average individually.
  2. "-": The Quasi-peak reading value also meets average limit and measurement with the average detector is unnecessary.
  3. The emission levels of other frequencies were very low against the limit.
  4. Margin value = Emission level - Limit value
  5. Correction factor = Insertion loss + Cable loss
  6. Emission Level = Correction Factor + Reading Value.

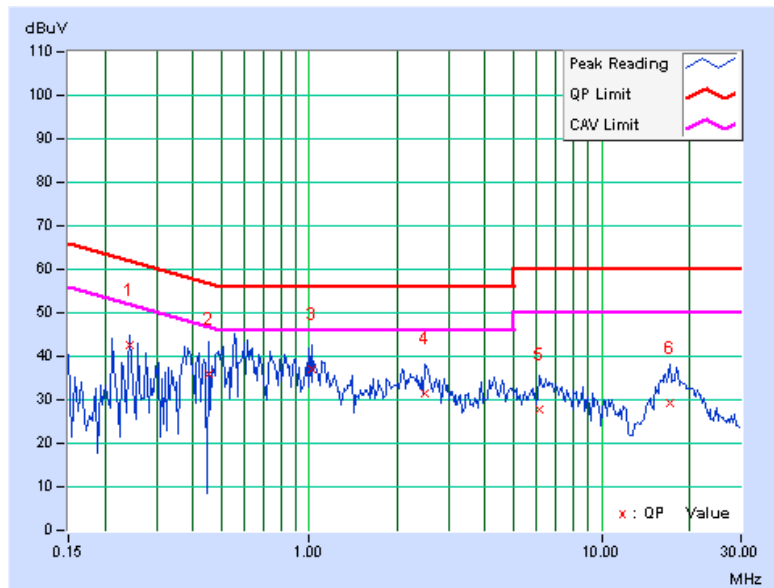

<b>PHASE</b>	Line 2	<b>6dB BANDWIDTH</b>	9 kHz
<b>CHANNEL</b>	Channel 1		

No	Freq. [MHz]	Corr. Factor (dB)	Reading Value		Emission Level		Limit		Margin	
			[dB (uV)]		[dB (uV)]		[dB (uV)]		(dB)	
			Q.P.	AV.	Q.P.	AV.	Q.P.	AV.	Q.P.	AV.
1	0.22812	0.16	34.72	-	34.88	-	62.52	52.52	-27.64	-
2	0.50000	0.20	40.17	-	40.37	-	56.00	46.00	-15.63	-
<b>3</b>	<b>0.56017</b>	<b>0.20</b>	<b>43.55</b>	-	<b>43.75</b>	-	<b>56.00</b>	<b>46.00</b>	<b>-12.25</b>	-
4	0.83750	0.22	37.23	-	37.45	-	56.00	46.00	-18.55	-
5	2.33331	0.30	31.87	-	32.17	-	56.00	46.00	-23.83	-
6	18.71926	0.90	29.25	-	30.15	-	60.00	50.00	-29.85	-

- REMARKS:**
1. Q.P. and AV. are abbreviations of quasi-peak and average individually.
  2. "-": The Quasi-peak reading value also meets average limit and measurement with the average detector is unnecessary.
  3. The emission levels of other frequencies were very low against the limit.
  4. Margin value = Emission level - Limit value
  5. Correction factor = Insertion loss + Cable loss
  6. Emission Level = Correction Factor + Reading Value.

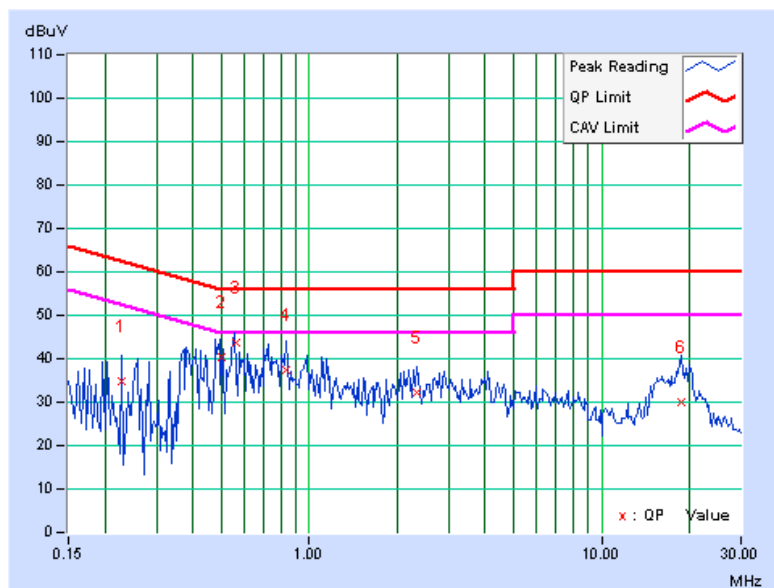

## 4.2 RADIATED EMISSION MEASUREMENT

### 4.2.1 LIMITS OF RADIATED EMISSION MEASUREMENT

Emissions radiated outside of the specified bands, shall be according to the general radiated limits in 15.209, 15.249 as following:

15.209 Limit		
Frequencies (MHz)	Field strength (microvolts/meter)	Measurement distance (meters)
0.009 ~ 0.490	2400/F(kHz)	300
0.490 ~ 1.705	24000/F(kHz)	30
1.705 ~ 30.0	30	30
30 ~ 88	100	3
88 ~ 216	150	3
216 ~ 960	200	3
Above 960	500	3
15.249 Limit		
Fundamental Frequency	Field Strength of Fundamental (millivolts/meter)	Field Strength of Harmonics (microvolts/meter)
902 ~ 928 MHz	50	500
2400 ~ 2483.5 MHz	50	500
5725 ~ 5875 MHz	50	500
24 ~ 24.25 GHz	250	2500

**NOTE:**

1. The lower limit shall apply at the transition frequencies.
2. Emission level (dBuV/m) = 20 log Emission level (uV/m).
3. As shown in 15.35(b), for frequencies above 1000MHz, the field strength limits are based on average detector, however, the peak field strength of any emission shall not exceed the maximum permitted average limits, specified above by more than 20dB under any condition of modulation.





## 4.2.2 TEST INSTRUMENTS

DESCRIPTION & MANUFACTURER	MODEL NO.	SERIAL NO.	CALIBRATED DATE	CALIBRATED UNTIL
HP Preamplifier	8447D	2432A03504	Feb. 29, 2012	Feb. 28, 2013
HP Preamplifier	8449B	3008A01201	Feb. 29, 2012	Feb. 28, 2013
Agilent Spectrum Analyzer	E4446A	MY46180403	Jun. 22, 2011	Jun. 21, 2012
ROHDE & SCHWARZ Test Receiver	ESCS 30	838251/021	Oct. 14, 2011	Oct. 13, 2012
Schwarzbeck Antenna	VULB 9168	137	Apr. 12, 2011	Apr. 11, 2012
Schwarzbeck Antenna	VHBA 9123	480	May 06, 2011	May 05, 2012
ADT. Turn Table	TT100	0306	NA	NA
ADT. Tower	AT100	0306	NA	NA
Software	ADT_Radiated_V 7.6.15.9.2	NA	NA	NA
SUHNER RF cable	SF102	CABLE-CH6	Aug. 19, 2011	Aug. 18, 2012
Schwarzbeck Horn Antenna	BBHA 9120-D1	D130	May 16, 2011	May 15, 2012
Highpass filter Wainwright Instruments	WHK 3.1/18G-10SS	SN 8	NA	NA

- NOTE:** 1. The calibration interval of the above test instruments is 12/24 months. And the calibrations are traceable to NML/ROC and NIST/USA.  
 2. The horn antenna and HP preamplifier (model: 8449B) are used only for the measurement of emission frequency above 1GHz if tested.  
 3. The test was performed in Chamber No. 6.  
 4. The Industry Canada Reference No. IC 7450E-6.  
 5. The FCC Site Registration No. is 447212.

## 4.2.3 TEST PROCEDURES

- a. The EUT was placed on the top of a rotating table 0.8 meters above the ground at a 3 meter semi- anechoic chamber room. The table was rotated 360 degrees to determine the position of the highest radiation.
- b. The EUT was set 3 meters away from the interference-receiving antenna, which was mounted on the top of a variable-height antenna tower.
- c. The height of antenna is varied from one meter to four meters above the ground to determine the maximum value of the field strength. Both horizontal and vertical polarizations of the antenna are set to make the measurement.
- d. For each suspected emission, the EUT was arranged to its worst case and then the antenna was tuned to heights from 1 meter to 4 meters and the rotatable table was turned from 0 degrees to 360 degrees to find the maximum reading.
- e. The test-receiver system was set to quasi-peak detect function and specified bandwidth with maximum hold mode when the test frequency is below 1 GHz.
- f. If the emission level of the EUT in peak mode was lower than the limit specified, then testing could be stopped and the peak values of the EUT would be reported. Otherwise the emissions would be re-tested one by one using peak, quasi-peak method or average method as specified and then reported in data sheet.

### NOTE:

1. The resolution bandwidth and video bandwidth of test receiver/spectrum analyzer is 120kHz for Peak detection (PK) and Quasi-peak detection (QP) at frequency below 1GHz.
2. The resolution bandwidth of test receiver/spectrum analyzer is 1 MHz and video bandwidth is 3MHz for Peak detection at frequency above 1GHz.
3. The resolution bandwidth of test receiver/spectrum analyzer is 1MHz and the video bandwidth is 10Hz for Average detection (AV) at frequency above 1GHz.
4. All modes of operation were investigated and the worst-case emissions are reported.

## 4.2.4 DEVIATION FROM TEST STANDARD

No deviation

## 4.2.5 TEST SETUP

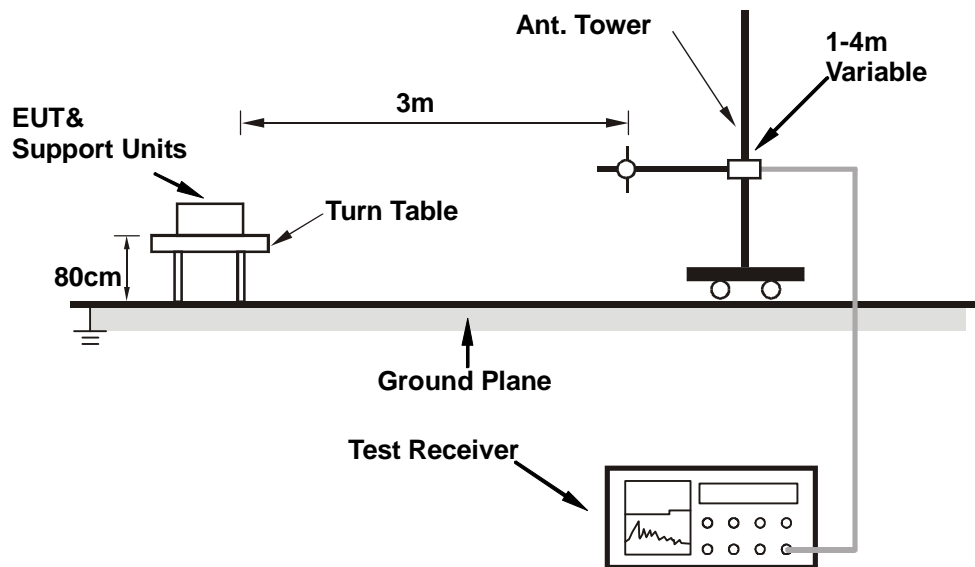

For the actual test configuration, please refer to the related item – Photographs of the Test Configuration.

## 4.2.6 EUT OPERATING CONDITIONS

Set the EUT under transmission condition continuously at specific channel frequency.

## 4.2.7 TEST RESULTS

### ABOVE 1GHz DATA

EUT TEST CONDITION		MEASUREMENT DETAIL	
CHANNEL	Channel 1	FREQUENCY RANGE	1 ~ 25GHz
INPUT POWER (SYSTEM)	120Vac, 60Hz	DETECTOR FUNCTION	Peak (PK) Average (AV)
ENVIRONMENTAL CONDITIONS	17deg. C, 78% RH	TESTED BY	Jun Wu

ANTENNA POLARITY & TEST DISTANCE: HORIZONTAL AT 3 M								
NO.	FREQ. (MHz)	EMISSION LEVEL (dBuV/m)	LIMIT (dBuV/m)	MARGIN (dB)	ANTENNA HEIGHT (m)	TABLE ANGLE (Degree)	RAW VALUE (dBuV)	CORRECTION FACTOR (dB/m)
1	2390.00	50.2 PK	74.0	-23.8	1.00 H	240	19.97	30.24
2	2390.00	37.3 AV	54.0	-16.7	1.00 H	240	7.07	30.24
3	2400.00	44.7 PK	74.0	-29.4	1.00 H	240	14.36	30.29
4	2400.00	1.4 AV	54.0	-52.7	1.00 H	240	-28.94	30.29
5	*2403.00	87.0 PK	114.0	-27.0	1.00 H	240	56.74	30.30
6	*2403.00	43.7 AV	94.0	-50.3	1.00 H	240	13.44	30.30
7	4806.00	45.9 PK	74.0	-28.1	1.00 H	5	9.31	36.60
8	4806.00	2.6 AV	54.0	-51.4	1.00 H	5	-33.99	36.60
ANTENNA POLARITY & TEST DISTANCE: VERTICAL AT 3 M								
NO.	FREQ. (MHz)	EMISSION LEVEL (dBuV/m)	LIMIT (dBuV/m)	MARGIN (dB)	ANTENNA HEIGHT (m)	TABLE ANGLE (Degree)	RAW VALUE (dBuV)	CORRECTION FACTOR (dB/m)
1	2390.00	50.8 PK	74.0	-23.2	1.00 V	85	20.54	30.24
2	2390.00	37.5 AV	54.0	-16.5	1.00 V	85	7.25	30.24
3	2400.00	45.4 PK	74.0	-28.7	1.00 V	85	15.06	30.29
4	2400.00	2.1 AV	54.0	-52.0	1.00 V	85	-28.24	30.29
5	*2403.00	87.7 PK	114.0	-26.3	1.00 V	85	57.44	30.30
6	*2403.00	44.4 AV	94.0	-49.6	1.00 V	85	14.14	30.30
7	4806.00	47.2 PK	74.0	-26.8	1.04 V	63	10.60	36.60
8	4806.00	3.9 AV	54.0	-50.1	1.04 V	63	-32.70	36.60

- REMARKS:**
1. Emission level (dBuV/m) = Raw Value (dBuV) + Correction Factor (dB/m).
  2. Correction Factor (dB/m) = Antenna Factor (dB/m) + Cable Factor (dB).
  3. The other emission levels were very low against the limit.
  4. Margin value = Emission level – Limit value.
  5. “ \* ” : Fundamental frequency
  6. The average value of fundamental frequency is: Average = Peak value + 20log(Duty cycle) Where the duty factor is calculated from following formula:  
 $20 \log (\text{Duty cycle}) = 20 \log (0.11 \text{ ms} / 16.04 \text{ ms}) = -43.3 \text{ dB}$   
 Please see page 23 for plotted duty.



A D T

EUT TEST CONDITION		MEASUREMENT DETAIL	
CHANNEL	Channel 39	FREQUENCY RANGE	1 ~ 25GHz
INPUT POWER (SYSTEM)	120Vac, 60Hz	DETECTOR FUNCTION	Peak (PK) Average (AV)
ENVIRONMENTAL CONDITIONS	17deg. C, 78% RH	TESTED BY	Jun Wu

ANTENNA POLARITY & TEST DISTANCE: HORIZONTAL AT 3 M								
NO.	FREQ. (MHz)	EMISSION LEVEL (dBuV/m)	LIMIT (dBuV/m)	MARGIN (dB)	ANTENNA HEIGHT (m)	TABLE ANGLE (Degree)	RAW VALUE (dBuV)	CORRECTION FACTOR (dB/m)
1	*2441.00	85.1 PK	114.0	-28.9	1.00 H	241	54.65	30.43
2	*2441.00	41.8 AV	94.0	-52.2	1.00 H	241	11.35	30.43
3	4882.00	46.7 PK	74.0	-27.3	1.14 H	3	9.88	36.79
4	4882.00	3.4 AV	54.0	-50.6	1.14 H	3	-33.42	36.79
ANTENNA POLARITY & TEST DISTANCE: VERTICAL AT 3 M								
NO.	FREQ. (MHz)	EMISSION LEVEL (dBuV/m)	LIMIT (dBuV/m)	MARGIN (dB)	ANTENNA HEIGHT (m)	TABLE ANGLE (Degree)	RAW VALUE (dBuV)	CORRECTION FACTOR (dB/m)
1	*2441.00	86.1 PK	114.0	-27.9	1.00 V	86	55.70	30.43
2	*2441.00	42.8 AV	94.0	-51.2	1.00 V	86	12.40	30.43
3	4882.00	48.0 PK	74.0	-26.0	1.08 V	68	11.18	36.79
4	4882.00	4.7 AV	54.0	-49.3	1.08 V	68	-32.12	36.79

- REMARKS:**
1. Emission level (dBuV/m) = Raw Value (dBuV) + Correction Factor (dB/m).
  2. Correction Factor (dB/m) = Antenna Factor (dB/m) + Cable Factor (dB).
  3. The other emission levels were very low against the limit.
  4. Margin value = Emission level – Limit value.
  5. “ \* “ : Fundamental frequency
  6. The average value of fundamental frequency is: Average = Peak value + 20log(Duty cycle) Where the duty factor is calculated from following formula:  
 $20 \log (\text{Duty cycle}) = 20 \log (0.11 \text{ ms} / 16.04 \text{ ms}) = -43.3 \text{ dB}$   
 Please see page 23 for plotted duty.



A D T

EUT TEST CONDITION		MEASUREMENT DETAIL	
CHANNEL	Channel 78	FREQUENCY RANGE	1 ~ 25GHz
INPUT POWER (SYSTEM)	120Vac, 60Hz	DETECTOR FUNCTION	Peak (PK) Average (AV)
ENVIRONMENTAL CONDITIONS	17deg. C, 78% RH	TESTED BY	Jun Wu

ANTENNA POLARITY & TEST DISTANCE: HORIZONTAL AT 3 M								
NO.	FREQ. (MHz)	EMISSION LEVEL (dBuV/m)	LIMIT (dBuV/m)	MARGIN (dB)	ANTENNA HEIGHT (m)	TABLE ANGLE (Degree)	RAW VALUE (dBuV)	CORRECTION FACTOR (dB/m)
1	*2480.00	85.8 PK	114.0	-28.2	1.00 H	243	55.26	30.56
2	*2480.00	42.5 AV	94.0	-51.5	1.00 H	243	11.96	30.56
3	2483.50	45.1 PK	74.0	-28.9	1.00 H	243	14.57	30.57
4	2483.50	1.8 AV	54.0	-52.2	1.00 H	243	-28.73	30.57
5	4960.00	46.6 PK	74.0	-27.4	1.00 H	4	9.60	36.99
6	4960.00	3.3 AV	54.0	-50.7	1.00 H	4	-33.70	36.99
ANTENNA POLARITY & TEST DISTANCE: VERTICAL AT 3 M								
NO.	FREQ. (MHz)	EMISSION LEVEL (dBuV/m)	LIMIT (dBuV/m)	MARGIN (dB)	ANTENNA HEIGHT (m)	TABLE ANGLE (Degree)	RAW VALUE (dBuV)	CORRECTION FACTOR (dB/m)
1	*2480.00	86.1 PK	114.0	-27.9	1.00 V	87	55.56	30.56
2	*2480.00	42.8 AV	94.0	-51.2	1.00 V	87	12.26	30.56
3	2483.50	45.4 PK	74.0	-28.6	1.00 V	87	14.87	30.57
4	2483.50	2.1 AV	54.0	-51.9	1.00 V	87	-28.43	30.57
5	4960.00	48.9 PK	74.0	-25.1	1.04 V	344	11.87	36.99
6	4960.00	5.6 AV	54.0	-48.4	1.04 V	344	-31.43	36.99

- REMARKS:**
1. Emission level (dBuV/m) = Raw Value (dBuV) + Correction Factor (dB/m).
  2. Correction Factor (dB/m) = Antenna Factor (dB/m) + Cable Factor (dB).
  3. The other emission levels were very low against the limit.
  4. Margin value = Emission level – Limit value.
  5. “ \* “ : Fundamental frequency
  6. The average value of fundamental frequency is: Average = Peak value + 20log(Duty cycle) Where the duty factor is calculated from following formula:  
 $20 \log (\text{Duty cycle}) = 20 \log (0.11 \text{ ms} / 16.04 \text{ ms}) = -43.3 \text{ dB}$   
 Please see page 23 for plotted duty.



A D T

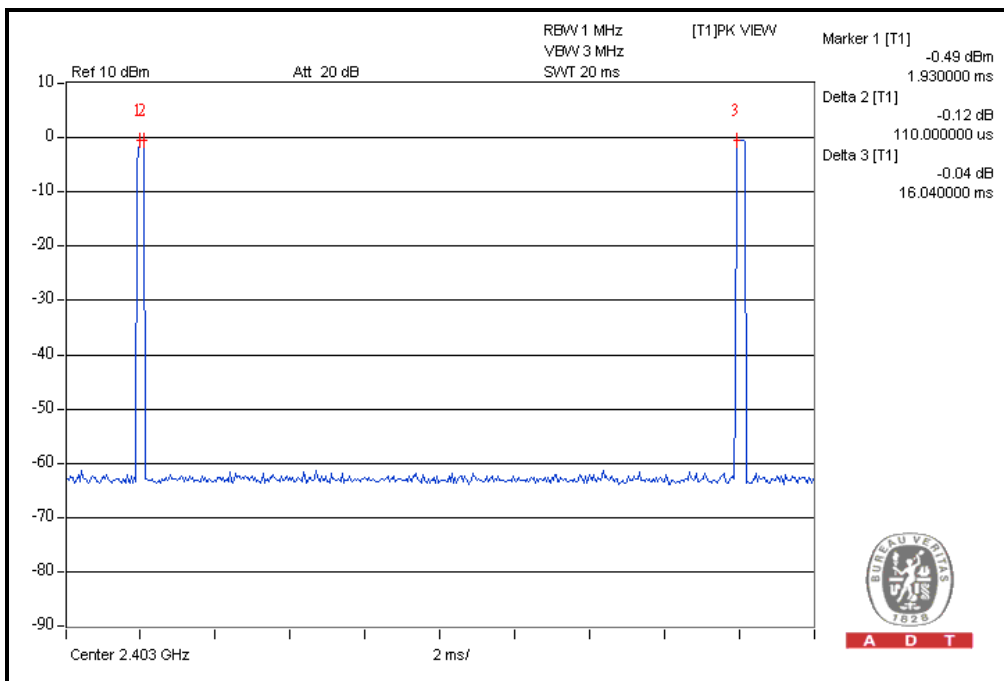

A D T

$$20 \log (\text{Duty cycle}) = 20 \log (0.11 \text{ ms} / 16.04 \text{ ms}) = -43.3 \text{ dB}$$



**BELOW 1GHz WORST-CASE DATA**

EUT TEST CONDITION		MEASUREMENT DETAIL	
CHANNEL	Channel 1	FREQUENCY RANGE	Below 1000MHz
INPUT POWER (SYSTEM)	120Vac, 60Hz	DETECTOR FUNCTION	Quasi-Peak
ENVIRONMENTAL CONDITIONS	17deg. C, 78% RH	TESTED BY	Jun Wu

ANTENNA POLARITY & TEST DISTANCE: HORIZONTAL AT 3 M								
NO.	FREQ. (MHz)	EMISSION LEVEL (dBuV/m)	LIMIT (dBuV/m)	MARGIN (dB)	ANTENNA HEIGHT (m)	TABLE ANGLE (Degree)	RAW VALUE (dBuV)	CORRECTION FACTOR (dB/m)
1	75.19	26.9 QP	40.0	-13.1	1.25 H	181	15.55	11.39
2	134.91	34.0 QP	43.5	-9.5	1.16 H	79	20.68	13.31
3	225.29	33.2 QP	46.0	-12.8	1.04 H	241	20.74	12.46
4	310.83	28.1 QP	46.0	-17.9	1.00 H	259	12.17	15.94
5	397.99	27.4 QP	46.0	-18.6	1.02 H	313	8.86	18.58
6	417.35	26.4 QP	46.0	-19.6	1.06 H	76	7.36	19.08
ANTENNA POLARITY & TEST DISTANCE: VERTICAL AT 3 M								
NO.	FREQ. (MHz)	EMISSION LEVEL (dBuV/m)	LIMIT (dBuV/m)	MARGIN (dB)	ANTENNA HEIGHT (m)	TABLE ANGLE (Degree)	RAW VALUE (dBuV)	CORRECTION FACTOR (dB/m)
1	110.70	30.6 QP	43.5	-13.0	1.00 V	304	19.57	10.98
2	178.49	26.7 QP	43.5	-16.8	1.00 V	10	13.41	13.32
3	231.75	28.9 QP	46.0	-17.1	1.00 V	325	16.18	12.74
4	310.83	27.1 QP	46.0	-18.9	1.00 V	10	11.18	15.94
5	417.35	30.8 QP	46.0	-15.2	1.06 V	187	11.70	19.08
6	622.33	28.7 QP	46.0	-17.3	1.07 V	55	5.14	23.60

- REMARKS:**
1. Emission level (dBuV/m) = Raw Value (dBuV) + Correction Factor (dB/m).
  2. Correction Factor (dB/m) = Antenna Factor (dB/m) + Cable Factor (dB).
  3. The other emission levels were very low against the limit.
  4. Margin value = Emission level – Limit value.





### 4.3 BAND EDGES MEASUREMENT

#### 4.3.1 LIMITS OF BAND EDGES MEASUREMENT

Below –50dB of the highest emission level of operating band (in 100kHz Resolution Bandwidth).

#### 4.3.2 TEST INSTRUMENTS

DESCRIPTION & MANUFACTURER	MODEL NO.	SERIAL NO.	CALIBRATED DATE	CALIBRATED UNTIL
ROHDE & SCHWARZ Spectrum Analyzer	FSP 40	100036	Apr. 29, 2011	Apr. 28, 2012

**NOTE:** The calibration interval of the above test instruments is 12 months and the calibrations are traceable to NML/ROC and NIST/USA.

#### 4.3.3 TEST PROCEDURE

The transmitter output was connected to the spectrum analyzer via a low lose cable. Set both RBW and VBW of spectrum analyzer to 100 kHz and 300 kHz with suitable frequency span including 100 MHz bandwidth from band edge. The band edges was measured and recorded.

The spectrum plots are attached on the following pages.

#### 4.3.4 DEVIATION FROM TEST STANDARD

No deviation

#### 4.3.5 EUT OPERATING CONDITION

Same as Item 4.2.6

#### 4.3.6 TEST RESULTS

The spectrum plots are attached on the following 4 images. D1 line indicates the highest level, and D2 line indicates the 50dB offset below D1. It shows compliance with the requirement in part 15.249(d).



A D T

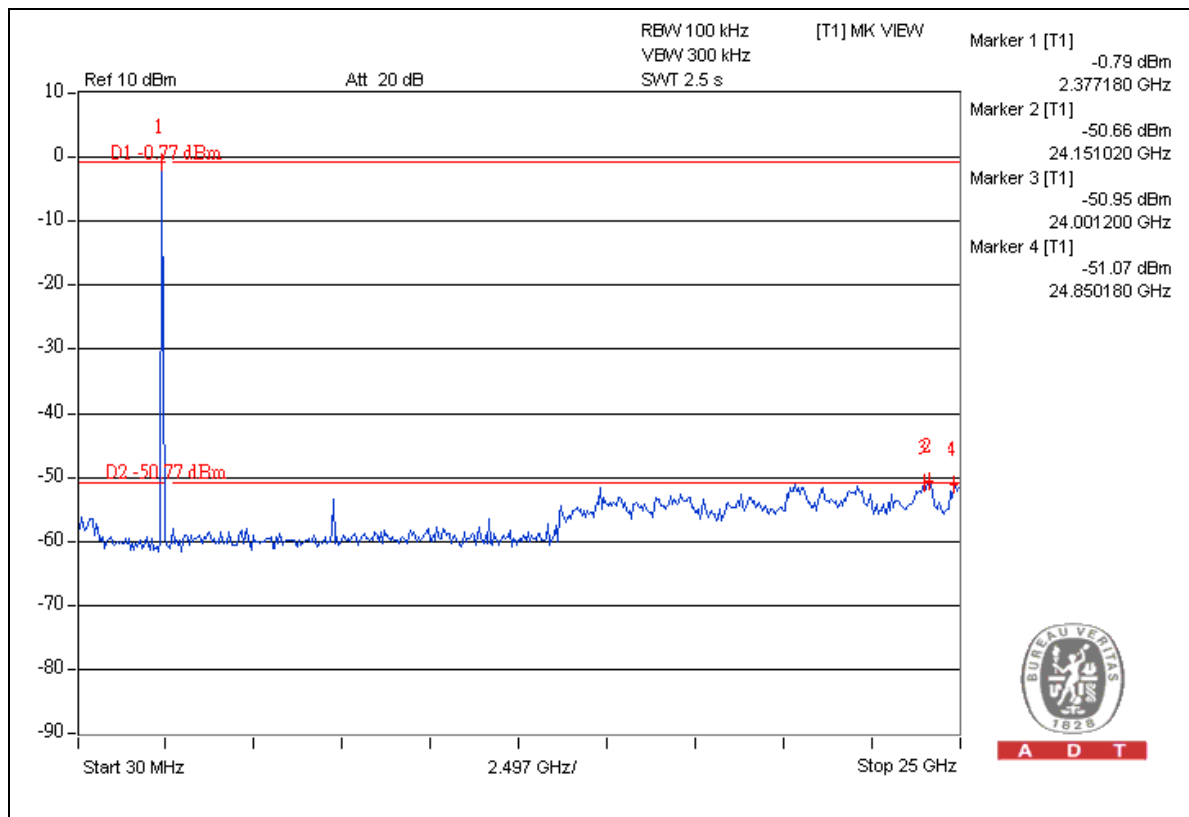
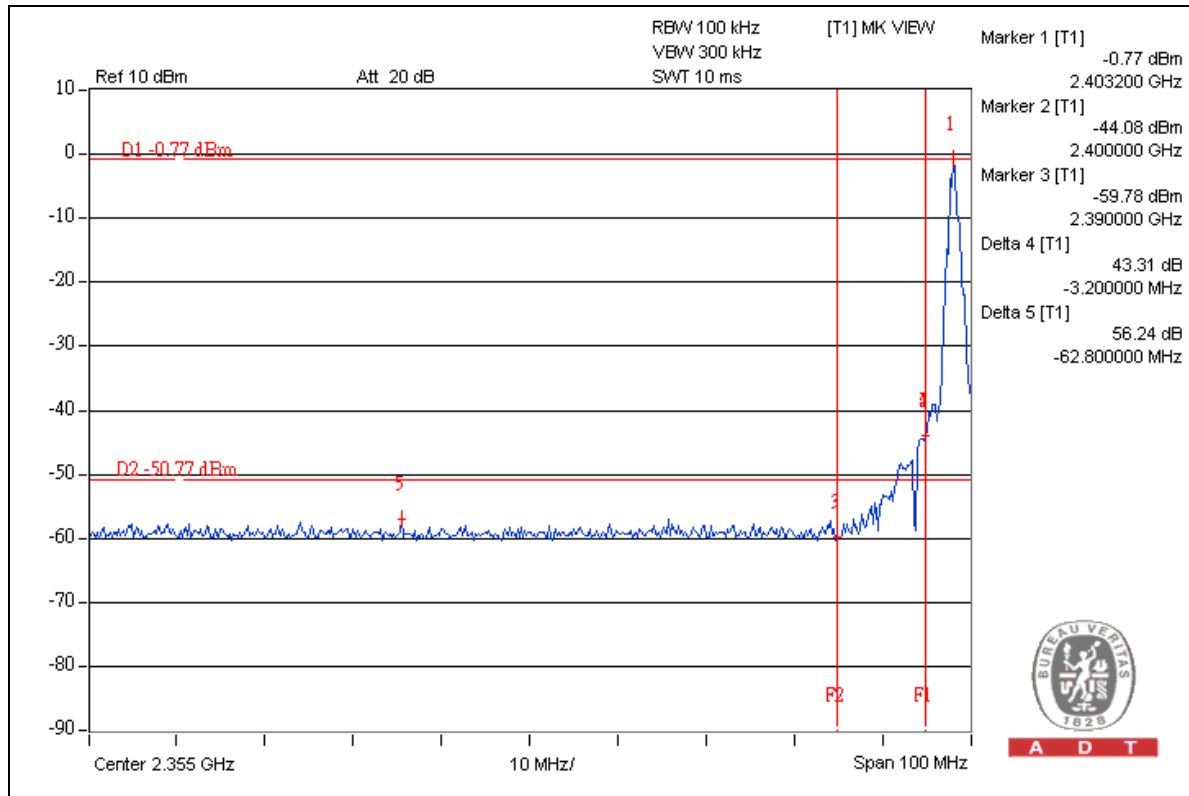



A D T

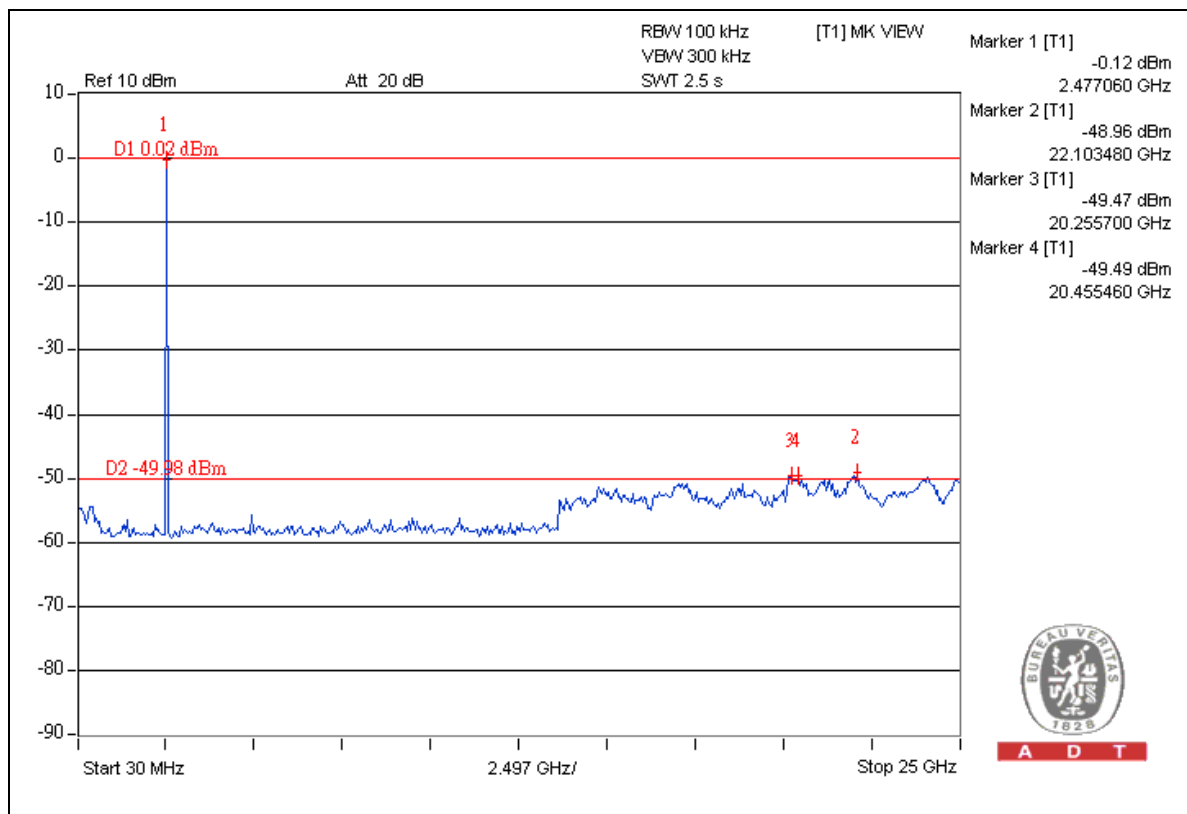
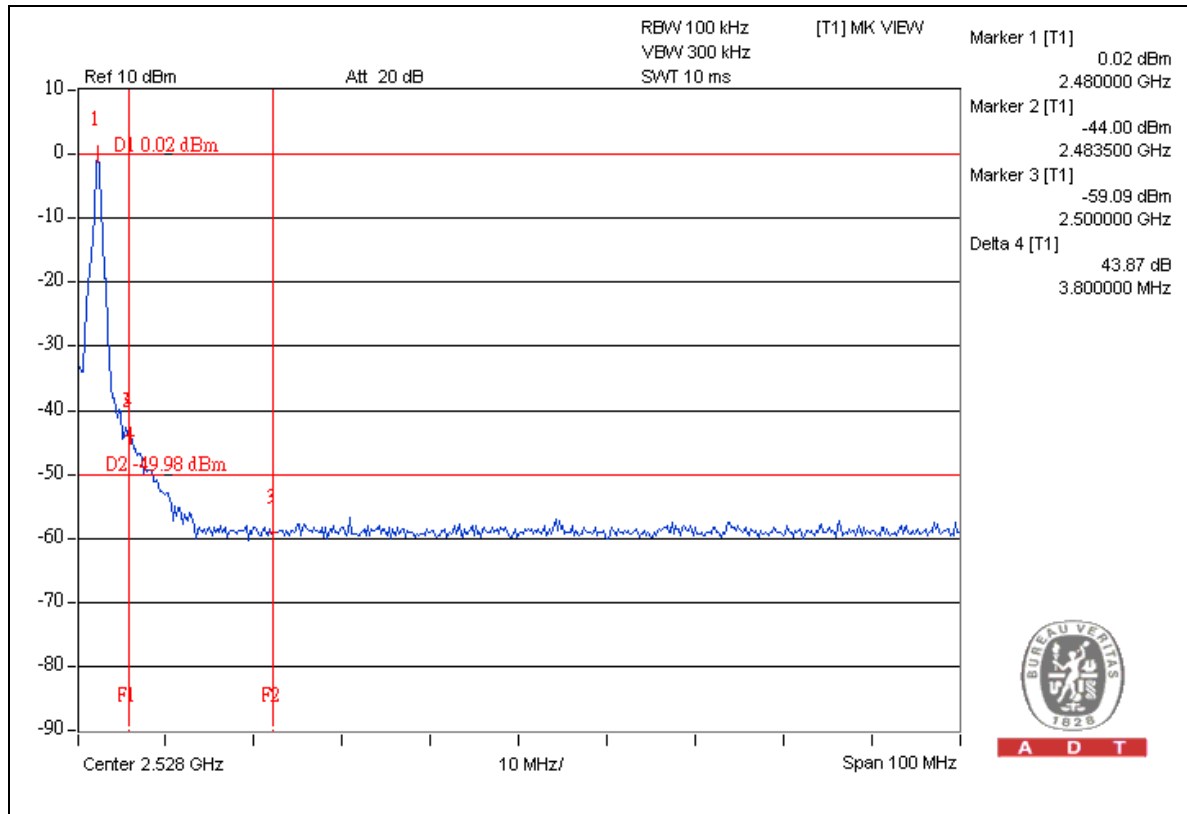



A D T

## 5. PHOTOGRAPHS OF THE TEST CONFIGURATION

Please refer to the attached file (Test Setup Photo).



## 6. INFORMATION ON THE TESTING LABORATORIES

We, Bureau Veritas Consumer Products Services (H.K.) Ltd., Taoyuan Branch, were founded in 1988 to provide our best service in EMC, Radio, Telecom and Safety consultation. Our laboratories are accredited and approved according to ISO/IEC 17025.

Copies of accreditation and authorization certificates of our laboratories obtained from approval agencies can be downloaded from our web site: [www.adt.com.tw/index.5.phtml](http://www.adt.com.tw/index.5.phtml).

If you have any comments, please feel free to contact us at the following:

**Linko EMC/RF Lab:**

Tel: 886-2-26052180

Fax: 886-2-26051924

**Hsin Chu EMC/RF Lab:**

Tel: 886-3-5935343

Fax: 886-3-5935342

**Hwa Ya EMC/RF/Safety Telecom Lab:**

Tel: 886-3-3183232

Fax: 886-3-3185050

**Email:** [service.adt@tw.bureauveritas.com](mailto:service.adt@tw.bureauveritas.com)

**Web Site:** [www.adt.com.tw](http://www.adt.com.tw)

The address and road map of all our labs can be found in our web site also.



A D T

## **7. APPENDIX A – MODIFICATIONS RECORDERS FOR ENGINEERING CHANGES TO THE EUT BY THE LAB**

No modifications were made to the EUT by the lab during the test.

**---END---**