

# FCC TEST REPORT

**REPORT NO.:** RF950510A09A

**MODEL NO.:** MG-0570T

**RECEIVED:** May 10, 2006

**TESTED:** May 11 ~ 24, 2006

**ISSUED:** June 15, 2006

**APPLICANT:** Chicony Electronics Co., Ltd.

**ADDRESS:** No. 25, Wu-Gong 6th Rd., Wu Ku Industrial Park,  
Taipei Hsien, Taiwan, R.O.C.

**ISSUED BY:** Advance Data Technology Corporation

**LAB LOCATION:** No. 47, 14th Ling, Chia Pau Tsuen, Lin Kou Hsiang  
244, Taipei Hsien, Taiwan, R.O.C.

This test report consists of 45 pages in total. It may be duplicated completely for legal use with the approval of the applicant. It should not be reproduced except in full, without the written approval of our laboratory. The client should not use it to claim product endorsement by CNLA, A2LA or any government agencies. The test results in the report only apply to the tested sample.



## Table of Contents

1.	CERTIFICATION.....	4
2.	SUMMARY OF TEST RESULTS.....	5
2.1	MEASUREMENT UNCERTAINTY.....	6
3.	GENERAL INFORMATION.....	7
3.1	GENERAL DESCRIPTION OF EUT.....	7
3.2	DESCRIPTION OF TEST MODES.....	8
3.2.1	CONFIGURATION OF SYSTEM UNDER TEST.....	9
3.2.2	TEST MODE APPLICABILITY AND TESTED CHANNEL DETAIL:.....	10
3.3	GENERAL DESCRIPTION OF APPLIED STANDARDS.....	12
3.4	DESCRIPTION OF SUPPORT UNITS.....	12
4.	TEST TYPES AND RESULTS.....	13
4.1	CONDUCTED EMISSION MEASUREMENT.....	13
4.2	RADIATED EMISSION MEASUREMENT.....	13
4.2.1	LIMITS OF RADIATED EMISSION MEASUREMENT.....	13
4.2.2	TEST INSTRUMENTS.....	15
4.2.3	TEST PROCEDURES.....	17
4.2.4	DEVIATION FROM TEST STANDARD.....	17
4.2.5	TEST SETUP.....	18
4.2.6	EUT OPERATING CONDITIONS.....	19
4.2.7	TEST RESULTS.....	20
4.3	6dB BANDWIDTH MEASUREMENT.....	28
4.3.1	LIMITS OF 6dB BANDWIDTH MEASUREMENT.....	28
4.3.2	TEST INSTRUMENTS.....	28
4.3.3	TEST PROCEDURE.....	28
4.3.4	DEVIATION FROM TEST STANDARD.....	28
4.3.5	TEST SETUP.....	28
4.3.6	EUT OPERATING CONDITIONS.....	28
4.3.7	TEST RESULTS.....	29
4.4	MAXIMUM PEAK OUTPUT POWER.....	31
4.4.1	LIMITS OF MAXIMUM PEAK OUTPUT POWER MEASUREMENT.....	31
4.4.2	INSTRUMENTS.....	31
4.4.3	TEST PROCEDURES.....	31
4.4.4	DEVIATION FROM TEST STANDARD.....	31
4.4.5	TEST SETUP.....	32
4.4.6	EUT OPERATING CONDITIONS.....	32
4.4.7	TEST RESULTS.....	32
4.5	POWER SPECTRAL DENSITY MEASUREMENT.....	33
4.5.1	LIMITS OF POWER SPECTRAL DENSITY MEASUREMENT.....	33
4.5.2	TEST INSTRUMENTS.....	33
4.5.3	TEST PROCEDURE.....	33
4.5.4	DEVIATION FROM TEST STANDARD.....	33
4.5.5	TEST SETUP.....	33
4.5.6	EUT OPERATING CONDITION.....	33



4.5.7	TEST RESULTS .....	34
4.6	BAND EDGES MEASUREMENT .....	36
4.6.1	LIMITS OF BAND EDGES MEASUREMENT .....	36
4.6.2	TEST INSTRUMENTS.....	36
4.6.3	TEST PROCEDURE.....	36
4.6.4	DEVIATION FROM TEST STANDARD.....	36
4.6.5	EUT OPERATING CONDITION .....	36
4.6.6	TEST RESULTS .....	37
4.7	ANTENNA REQUIREMENT .....	41
4.7.1	STANDARD APPLICABLE .....	41
4.7.2	ANTENNA CONNECTED CONSTRUCTION .....	41
5.	PHOTOGRAPHS OF THE TEST CONFIGURATION.....	42
6.	INFORMATION ON THE TESTING LABORATORIES .....	44
	APPENDIX-A .....	A-1



## 1. CERTIFICATION

**PRODUCT:** Wireless Mouse  
**BRAND NAME:** Chicony  
**MODEL NO.:** MG-0570T  
**APPLICANT:** Chicony Electronics Co., Ltd.  
**TESTED:** May 11 ~ 24, 2006  
**TEST SAMPLE:** ENGINEERING SAMPLE  
**STANDARDS:** FCC Part 15, Subpart C (Section 15.247),  
FCC Part 15, Subpart B, Class B  
ANSI C63.4-2003

The above equipment has been tested by **Advance Data Technology Corporation**, and found compliance with the requirement of the above standards. The test record, data evaluation & Equipment Under Test (EUT) configurations represented herein are true and accurate accounts of the measurements of the sample's EMC characteristics under the conditions specified in this report.

**PREPARED BY** : Annie Chang , **DATE:** June 15, 2006  
( Annie Chang )

**TECHNICAL**  
**ACCEPTANCE** : Ken Liu , **DATE:** June 15, 2006  
Responsible for RF ( Ken Liu )

**APPROVED BY** : Gary Chang , **DATE:** June 15, 2006  
( Gary Chang / Supervisor )

## 2. SUMMARY OF TEST RESULTS

The EUT has been tested according to the following specifications:

<b>APPLIED STANDARD: FCC Part 15, Subpart C (Section 15.247)</b>			
<b>Standard Section</b>	<b>Test Type and Limit</b>	<b>Result</b>	<b>Remark</b>
15.207	AC Power Conducted Emission	N/A	The EUT power from batteries.
15.247(a)(2)	Spectrum Bandwidth of a Direct Sequence Spread Spectrum System Limit: min. 500kHz	PASS	Meet the requirement of limit.
15.247(b)	Maximum Peak Output Power Limit: max. 30dBm	PASS	Meet the requirement of limit.
15.247(d)	Radiated Emissions Limit: Table 15.209	PASS	Meet the requirement of limit. Minimum passing margin is -3.65dB at 4804.00MHz
15.247(e)	Power Spectral Density Limit: max. 8dBm	PASS	Meet the requirement of limit.
15.247(d)	Band Edge Measurement Limit: 20dB less than the peak value of fundamental frequency	PASS	Meet the requirement of limit.

<b>APPLIED STANDARD: FCC Part 15, Subpart B</b>			
<b>STANDARD SECTION</b>	<b>TEST TYPE</b>	<b>RESULT</b>	<b>REMARK</b>
FCC Part 15, Subpart B, Class B	Conducted Emission	N/A	The EUT power from batteries.
	Radiated Emissions	PASS	Meet the requirement of limit. Minimum passing margin is -6.35dB at 208.91MHz

## 2.1 MEASUREMENT UNCERTAINTY

Where relevant, the following measurement uncertainty levels have been estimated for tests performed on the EUT as specified in CISPR 16-4:

This uncertainty represents an expanded uncertainty expressed at approximately the 95% confidence level using a coverage factor of  $k=2$ .

Measurement	Uncertainty
Radiated emissions (Chamber 4)	3.61 dB
Radiated emissions (Open Site 8)	3.89 dB

### 3. GENERAL INFORMATION

#### 3.1 GENERAL DESCRIPTION OF EUT

<b>EUT</b>	Wireless Mouse
<b>MODEL NO.</b>	MG-0570T
<b>FCC ID</b>	E8HMG-0570T
<b>POWER SUPPLY</b>	3.0Vdc from batteries
<b>MODULATION TYPE</b>	GFSK
<b>OUTPUT POWER</b>	1.161mW
<b>FREQUENCY RANGE</b>	2402 MHz ~ 2479 MHz
<b>NUMBER OF CHANNEL</b>	78
<b>ANTENNA TYPE</b>	Strip antenna with -3.92dBi gain
<b>DATA CABLE</b>	N/A
<b>I/O PORTS</b>	N/A
<b>ASSOCIATED DEVICES</b>	N/A

**NOTE:**

1. The EUT is a Wireless Mouse, which is a transceiver.
2. The above EUT information was declared by the manufacturer and for more detailed features description, please refer to the manufacturer's specifications or User's Manual.

### 3.2 DESCRIPTION OF TEST MODES

78 channels are provided to this EUT:

Channel	Freq. (MHz)	Channel	Freq. (MHz)	Channel	Freq. (MHz)	Channel	Freq. (MHz)
0	2402	20	2422	40	2442	60	2462
1	2403	21	2423	41	2443	61	2463
2	2404	22	2424	42	2444	62	2464
3	2405	23	2425	43	2445	63	2465
4	2406	24	2426	44	2446	64	2466
5	2407	25	2427	45	2447	65	2467
6	2408	26	2428	46	2448	66	2468
7	2409	27	2429	47	2449	67	2469
8	2410	28	2430	48	2450	68	2470
9	2411	29	2431	49	2451	69	2471
10	2412	30	2431	50	2452	70	2472
11	2413	31	2433	51	2453	71	2473
12	2414	32	2434	52	2454	72	2474
13	2415	33	2435	53	2455	73	2475
14	2416	34	2436	54	2456	74	2476
15	2417	35	2437	55	2457	75	2477
16	2418	36	2438	56	2458	76	2478
17	2419	37	2439	57	2459	77	2479
18	2420	38	2440	58	2460		
19	2421	39	2441	59	2461		



### 3.2.1 CONFIGURATION OF SYSTEM UNDER TEST

For Mode A:

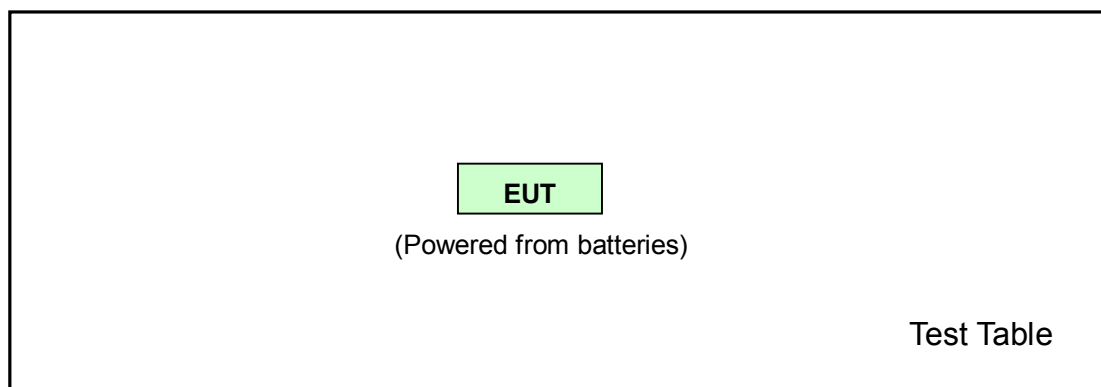

For Mode B:

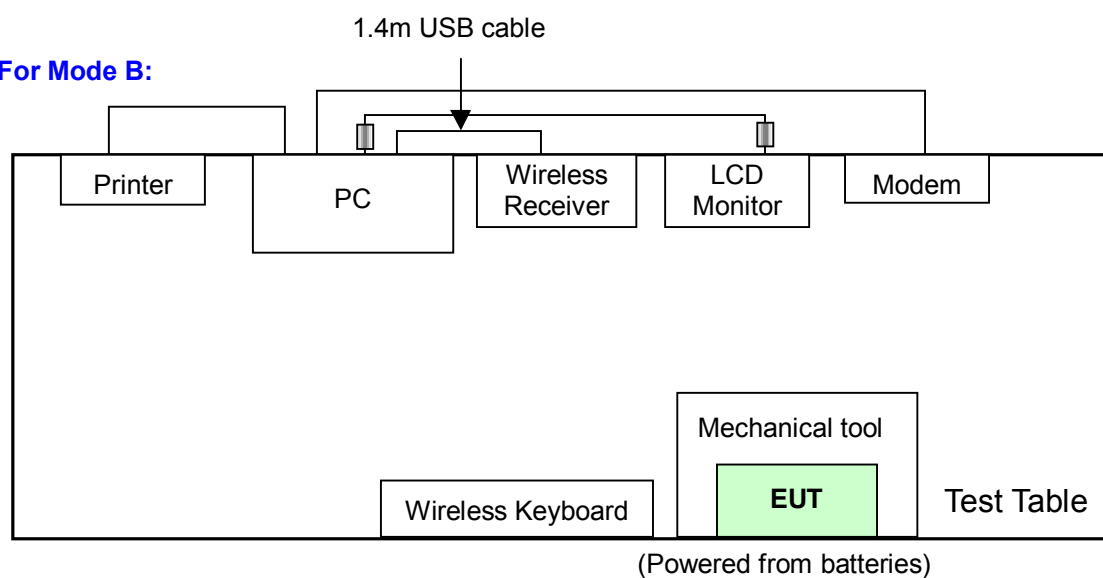

### 3.2.2 TEST MODE APPLICABILITY AND TESTED CHANNEL DETAIL:

EUT configure mode	Applicable to				Description
	PLC	RE<1G	RE≥1G	APCM	
A	Note	√	√	√	Transmission mode (FCC Part 15, Subpart C)
B	Note	√	-	-	Transmission mode (FCC Part 15, Subpart B)

Where PLC: Power Line Conducted Emission RE<1G RE: Radiated Emission below 1GHz  
 RE≥1G: Radiated Emission above 1GHz APCM: Antenna Port Conducted Measurement

Note: No need to concern of Conducted Emission due to the EUT is powered by battery.

#### **RADIATED EMISSION TEST (BELOW 1 GHz):**

- Pre-Scan has been conducted to determine the worst-case mode from all possible combinations between available modulations, data rates and antenna ports (if EUT with antenna diversity architecture).
- Following channel(s) was (were) selected for the final test as listed below.

EUT configure mode	Available Channel	Tested Channel	Modulation Type
A	0 to 77	77	GFSK
B	0 to 77	77	GFSK

#### **RADIATED EMISSION TEST (ABOVE 1 GHz):**

- Pre-Scan has been conducted to determine the worst-case mode from all possible combinations between available modulations, data rates and antenna ports (if EUT with antenna diversity architecture).
- Following channel(s) was (were) selected for the final test as listed below.

EUT configure mode	Available Channel	Tested Channel	Modulation Type
A	0 to 77	0, 38, 77	GFSK
B	0 to 77	0, 38, 77	GFSK



**BANDEDGE MEASUREMENT:**

- Pre-Scan has been conducted to determine the worst-case mode from all possible combinations between available modulations, data rates and antenna ports (if EUT with antenna diversity architecture).
- Following channel(s) was (were) selected for the final test as listed below.

EUT configure mode	Available Channel	Tested Channel	Modulation Type
A	0 to 77	0, 77	GFSK

**ANTENNA PORT CONDUCTED MEASUREMENT:**

- Pre-Scan has been conducted to determine the worst-case mode from all possible combinations between available modulations, data rates and antenna ports (if EUT with antenna diversity architecture).
- Following channel(s) was (were) selected for the final test as listed below.

EUT configure mode	Available Channel	Tested Channel	Modulation Type
A	0 to 77	0, 38, 77	GFSK



### 3.3 GENERAL DESCRIPTION OF APPLIED STANDARDS

The EUT is a RF product. According to the specifications of the manufacturer, it must comply with the requirements of the following standards:

**FCC Part 15, Subpart C. (15.247)**

**FCC Part 15, Subpart B, Class B**

**ANSI C63.4-2003**

All test items have been performed and recorded as per the above standards.

### 3.4 DESCRIPTION OF SUPPORT UNITS

The EUT has been tested as an independent unit together with other necessary accessories or support units. The following support units or accessories were used to form a representative test configuration during the tests.

**For Mode A:**

The EUT has been tested as an independent unit

**For Mode B:**

NO.	PRODUCT	BRAND	MODEL NO.	SERIAL NO.	FCC ID
1	PERSONAL COMPUTER	LEO	Persica 8620G	1A36I98A000210	FCC DoC Approved
2	LCD MONITOR	ACER	AL1721	ET.L0408.010341 0046DPK00	FCC DoC Approved
3	PRINTER	EPSON	LQ-300+	DCGY038846	FCC DoC Approved
4	MODEM	ACEEX	1414	980020526	IFAXDM1414
5	WIRELESS KEYBOARD	Chicony	KG-0570	N/A	E8HKG-0570
6	WIRELESS RECEIVER	Chicony	RG-0570U	N/A	E8HRG-0570U

NO.	SIGNAL CABLE DESCRIPTION OF THE ABOVE SUPPORT UNITS
1	N/A
2	1.8 m braid shielded wire, terminated with D-Sub connector via metallic frame, w. 2 cores
3	1.8m braid shielded wire, terminated with DB25 and Centronics connector via metallic frame, w/o core
4	1.2 m braid shielded wire, terminated with DB25 and DB9 connector via metallic frame, w/o core.
5	N/A
6	1.4m USB Shielded cable

**NOTE:** 1. All power cords of the above support units are non-shielded (1.8m).  
2. The support units 5~6 were provided by client.

## 4. TEST TYPES AND RESULTS

### 4.1 CONDUCTED EMISSION MEASUREMENT

N/A

### 4.2 RADIATED EMISSION MEASUREMENT

#### 4.2.1 LIMITS OF RADIATED EMISSION MEASUREMENT

(For Mode A)

Emissions radiated outside of the specified bands, shall be according to the general radiated limits in 15.209 as following:

Frequencies (MHz)	Field strength (microvolts/meter)	Measurement distance (meters)
0.009-0.490	2400/F(kHz)	300
0.490-1.705	24000/F(kHz)	30
1.705-30.0	30	30
30-88	100	3
88-216	150	3
216-960	200	3
Above 960	500	3

**NOTE:**

1. The lower limit shall apply at the transition frequencies.
2. Emission level (dBuV/m) = 20 log Emission level (uV/m).
3. As shown in 15.35(b), for frequencies above 1000MHz, the field strength limits are based on average detector, however, the peak field strength of any emission shall not exceed the maximum permitted average limits, specified above by more than 20dB under any condition of modulation.



(For Mode B)

**FOR FREQUENCY BELOW 1000 MHz**

FREQUENCY (MHz)	Class A (at 10m)	Class B (at 10m)
	dBuV/m	dBuV/m
30 – 230	40	30
230 - 1000	47	37

Note: The limit for radiated test was performed according to CISPR 22: 1997, which was specified in FCC PART 15B 15.109(g). Also the limits of ICES-003: 2004 and CISPR 22: 1997 are same.

**LIMIT OF RADIATED EMISSION OF FCC PART 15, SUBPART B FOR FREQUENCY ABOVE 1000 MHz**

FREQUENCY (MHz)	Class A (dBuV/m) (at 3m)		Class B (dBuV/m) (at 3m)	
	PEAK	AVERAGE	PEAK	AVERAGE
Above 1000	80.0	60.0	74.0	54.0

- Note: (1) The lower limit shall apply at the transition frequencies.  
 (2) Emission level (dBuV/m) = 20 log Emission level (uV/m).  
 (3) All emanation from a class A/B digital device or system, including any network of conductors and apparatus connected thereto, shall not exceed the level of field strengths specified above.

**FREQUENCY RANGE OF RADIATED MEASUREMENT (For unintentional radiators)**

Highest frequency generated or Upper frequency of measurement used in the device or on which the device operates or tunes (MHz)	Range (MHz)
Below 1.705	30
1.705 – 108	1000
108 – 500	2000
500 – 1000	5000
Above 1000	5 <sup>th</sup> harmonic of the highest frequency or 40 GHz, whichever is lower

## 4.2.2 TEST INSTRUMENTS

(For Mode A)

DESCRIPTION & MANUFACTURER	MODEL NO.	SERIAL NO.	CALIBRATED UNTIL
Test Receiver ROHDE & SCHWARZ	ESMI	839013/007 839379/002	Jan. 24, 2007
Spectrum Analyzer ROHDE & SCHWARZ	FSEK30	100049	Aug. 14, 2006
BILOG Antenna SCHWARZBECK	VULB9163	121	Jun. 01, 2006
HORN Antenna SCHWARZBECK	BBHA 9120 D	9120D-407	Jan. 22, 2007
HORN Antenna SCHWARZBECK	BBHA 9170	BBHA9170242	Jan. 19, 2007
Preamplifier Agilent	8449B	3008A01911	Sep. 22, 2006
RF signal cable HUBER+SUHNNER	SUCOFLEX 104	218188/218189	Dec. 13, 2006
RF signal cable Worken	8D-FB	Cable-HYCH9-01	Mar. 08, 2007
Software ADT.	ADT_Radiated_ V7.6.01	NA	NA
Antenna Tower EMCO	2070/2080	512.835.4684	NA
Antenna Tower Controller EMCO	2090	NA	NA
Turn Table EMCO	2087-2.03	NA	NA
Turn Table Controller EMCO	2090	NA	NA

- NOTE:**
1. The calibration interval of the above test instruments is 12 months and the calibrations are traceable to NML/ROC and NIST/USA.
  2. The test was performed in HwaYa Chamber 4.
  3. The horn antenna and HP preamplifier (model: 8449B) are used only for the measurement of emission frequency above 1GHz if tested.
  4. The IC Site Registration No. is IC4924-4.



(For Mode B)

DESCRIPTION & MANUFACTURER	MODEL NO.	SERIAL NO.	CALIBRATED UNTIL
HP Preamplifier	8449B	3008A01924	Sep. 06, 2006
HP Preamplifier	8449B	3008A01638	Sep. 21, 2006
ROHDE & SCHWARZ TEST RECEIVER	ESVS10	846285/012	Jul. 26, 2006
CHASE BILOG Antenna	CBL6112A	2331	Oct. 12, 2006
EMCO Horn Antenna	3115	6714	Oct. 26, 2006
EMCO Horn Antenna	3115	9312-4192	Mar. 14, 2007
ADT. Turn Table	TT100	0201	NA
ADT. Tower	AT100	0201	NA
Software	ADT_Radiated_V7.5.14	NA	NA
ANRITSU RF Switches	MP59B	M32159	Sep. 13, 2006
TIMES RF cable	LMR-600	CABLE-ST8-01	Sep. 13, 2006

- NOTE:**
1. The calibration interval of the above test instruments is 12 months. And the calibrations are traceable to NML/ROC and NIST/USA.
  2. The horn antenna and HP preamplifier (model: 8449B) are used only for the measurement of emission frequency above 1GHz if tested.
  3. The test was performed in ADT Open Site No. 8.
  4. The VCCI Site Registration No. R-877.



### 4.2.3 TEST PROCEDURES

- a. The EUT was placed on the top of a rotating table 0.8 meters above the ground at a 3 meter semi- anechoic / 10-meter open area test site. The table was rotated 360 degrees to determine the position of the highest radiation.
- b. The EUT was set 3 / 10 meters away from the interference-receiving antenna, which was mounted on the top of a variable-height antenna tower.
- c. The antenna is a broadband antenna, and its height is varied from one meter to four meters above the ground to determine the maximum value of the field strength. Both horizontal and vertical polarizations of the antenna are set to make the measurement.
- d. For each suspected emission, the EUT was arranged to its worst case and then the antenna was tuned to heights from 1 meter to 4 meters and the rotatable table was turned from 0 degrees to 360 degrees to find the maximum reading.
- e. The test-receiver system was set to Peak Detect Function and Specified Bandwidth with Maximum Hold Mode.
- f. If the emission level of the EUT in peak mode was lower than the limit specified, then testing could be stopped and the peak values of the EUT would be reported. Otherwise the emissions would be re-tested one by one using peak, quasi-peak method or average method as specified and then reported in data sheet.

#### NOTE:

1. The resolution bandwidth and video bandwidth of test receiver/spectrum analyzer is 120kHz for Quasi-peak detection at frequency below 1GHz.
2. The resolution bandwidth and video bandwidth of test receiver/spectrum analyzer is 1 MHz for Peak detection (PK) at frequency above 1GHz.
3. The resolution bandwidth of test receiver/spectrum analyzer is 1 MHz and the video bandwidth is 10 Hz for Average detection (AV) at frequency above 1GHz.

### 4.2.4 DEVIATION FROM TEST STANDARD

No deviation

## 4.2.5 TEST SETUP

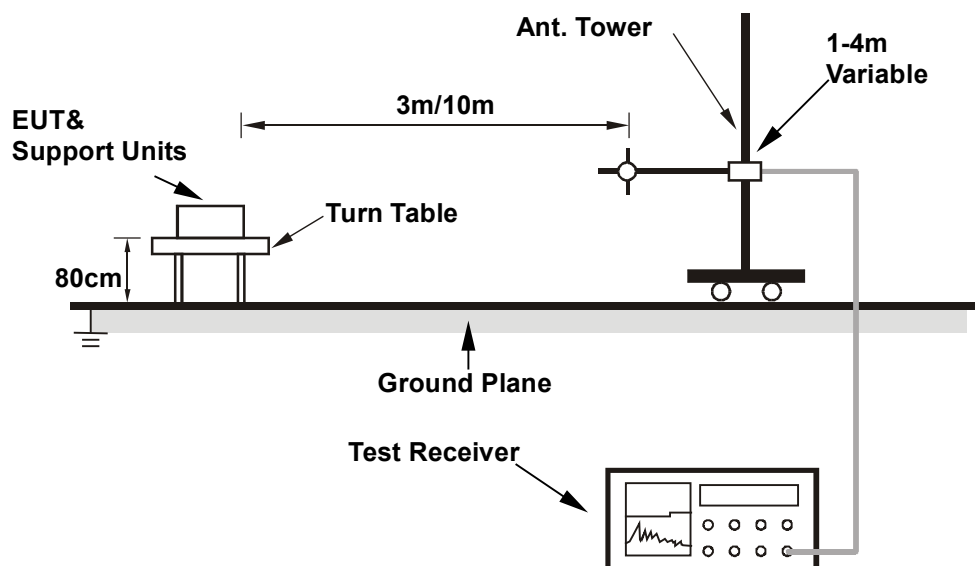

For the actual test configuration, please refer to the related item – Photographs of the Test Configuration.

## 4.2.6 EUT OPERATING CONDITIONS

### For Mode A:

Set the EUT under transmission condition continuously at specific channel frequency.

### For Mode B:

- a. Connected the receiver to a PC placed on a testing table.
- b. Checked if the receiver and the wireless keyboard & EUT were set at the same channel.
- c. The PC ran a test program (provided by manufacturer) to enable EUT under transmission/receiving condition continuously at specific channel frequency.
- d. A mechanical tool designed for help the EUT, was turned on the working mode function. (for EUT)
- e. The PC sent "H" messages to LCD monitor and displayed "H" patterns on its screen.
- f. The PC sent "H" messages to printer and the printer prints them out
- g. The PC sent "H" messages to modem.
- h. Repeated d ~ g.

## 4.2.7 TEST RESULTS

### RADIATED WORST CASE DATA: BELOW 1GHz

### MODE A FOR TRANSMISSION MODE (FCC PART 15, SUBPART C)

<b>MODULATION TYPE</b>	GFSK	<b>CHANNEL</b>	77
<b>INPUT POWER</b>	3Vdc	<b>FREQUENCY RANGE</b>	Below 1000MHz
<b>ENVIRONMENTAL CONDITIONS</b>	25deg. C, 70%RH, 1002hPa	<b>DETECTOR FUNCTION</b>	Quasi-Peak
<b>TEST MODE</b>	A	<b>TESTED BY</b>	Jamison Chan

### ANTENNA POLARITY & TEST DISTANCE: HORIZONTAL AT 3 M

No.	Freq. (MHz)	Emission Level (dBuV/m)	Limit (dBuV/m)	Margin (dB)	Antenna Height (m)	Table Angle (Degree)	Raw Value (dBuV)	Correction Factor (dB/m)
1	573.20	25.10 QP	46.00	-20.90	1.00 H	136	5.32	19.78
2	620.62	24.86 QP	46.00	-21.14	1.00 H	184	3.98	20.87
3	747.80	25.28 QP	46.00	-20.72	1.21 H	94	2.07	23.21
4	786.60	25.16 QP	46.00	-20.84	1.63 H	220	1.94	23.21
5	826.48	26.42 QP	46.00	-19.58	2.22 H	94	2.46	23.96
6	877.13	27.05 QP	46.00	-18.95	1.64 H	262	2.41	24.64

### ANTENNA POLARITY & TEST DISTANCE: VERTICAL AT 3 M

No.	Freq. (MHz)	Emission Level (dBuV/m)	Limit (dBuV/m)	Margin (dB)	Antenna Height (m)	Table Angle (Degree)	Raw Value (dBuV)	Correction Factor (dB/m)
1	216.46	25.42 QP	46.00	-20.58	1.24 V	232	14.16	11.26
2	631.40	26.38 QP	46.00	-19.62	1.37 V	208	5.33	21.05
3	754.27	25.37 QP	46.00	-20.63	1.66 V	352	2.09	23.28
4	812.47	25.89 QP	46.00	-20.11	2.37 V	352	2.34	23.55
5	848.03	26.61 QP	46.00	-19.39	1.28 V	220	2.01	24.60
6	906.23	27.07 QP	46.00	-18.93	1.63 V	130	2.32	24.75

- REMARKS:**
1. Emission level(dBuV/m)=Raw Value(dBuV) + Correction Factor(dB/m)
  2. Correction Factor(dB/m) = Antenna Factor (dB/m) + Cable Factor (dB)
  - 3The other emission levels were very low against the limit.
  4. Margin value = Emission level – Limit value.



**MODE B FOR TRANSMISSION MODE (FCC PART 15, SUBPART B)**

<b>MODULATION TYPE</b>	GFSK	<b>CHANNEL</b>	77
<b>INPUT POWER</b>	3Vdc	<b>FREQUENCY RANGE</b>	Below 1000MHz
<b>ENVIRONMENTAL CONDITIONS</b>	26deg. C, 62%RH, 1000hPa	<b>DETECTOR FUNCTION</b>	Quasi-Peak
<b>TEST MODE</b>	B	<b>TESTED BY</b>	Griffin Chiu

**ANTENNA POLARITY & TEST DISTANCE: HORIZONTAL AT 10 M**

No.	Freq. (MHz)	Emission Level (dBuV/m)	Limit (dBuV/m)	Margin (dB)	Antenna Height (m)	Table Angle (Degree)	Raw Value (dBuV)	Correction Factor (dB/m)
1	48.01	19.56 QP	30.00	-10.44	4.00 H	284	8.76	10.80
2	120.89	16.44 QP	30.00	-13.56	4.00 H	216	4.11	12.33
3	144.80	16.53 QP	30.00	-13.47	4.00 H	102	4.77	11.76
4	192.05	13.49 QP	30.00	-16.51	4.00 H	203	2.29	11.20
<b>5</b>	<b>208.91</b>	<b>23.65 QP</b>	<b>30.00</b>	<b>-6.35</b>	<b>4.00 H</b>	<b>328</b>	<b>11.50</b>	<b>12.15</b>
6	216.33	18.55 QP	30.00	-11.45	4.00 H	145	5.92	12.63
7	480.22	23.97 QP	37.00	-13.03	1.85 H	19	4.19	19.78
8	624.87	26.57 QP	37.00	-10.43	3.02 H	0	3.68	22.89

**ANTENNA POLARITY & TEST DISTANCE: VERTICAL AT 10 M**

No.	Freq. (MHz)	Emission Level (dBuV/m)	Limit (dBuV/m)	Margin (dB)	Antenna Height (m)	Table Angle (Degree)	Raw Value (dBuV)	Correction Factor (dB/m)
1	36.22	20.36 QP	30.00	-9.64	1.25 V	358	3.24	17.12
2	120.03	17.63 QP	30.00	-12.37	1.00 V	247	5.29	12.34
3	132.05	18.42 QP	30.00	-11.58	1.00 V	137	6.24	12.18
4	144.10	22.70 QP	30.00	-7.30	1.00 V	241	10.90	11.80
5	168.20	21.82 QP	30.00	-8.18	1.00 V	300	11.13	10.69
6	192.07	15.81 QP	30.00	-14.19	1.00 V	281	4.61	11.20
7	209.03	23.59 QP	30.00	-6.41	1.00 V	0	11.43	12.16
8	480.09	26.91 QP	37.00	-10.09	2.99 V	159	7.13	19.78
9	624.12	27.35 QP	37.00	-9.65	3.23 V	4	4.46	22.89

- REMARKS:**
1. Emission level(dBuV/m)=Raw Value(dBuV) + Correction Factor(dB/m)
  2. Correction Factor(dB/m) = Antenna Factor (dB/m) + Cable Factor (dB)
  - 3The other emission levels were very low against the limit.
  4. Margin value = Emission level – Limit value.



**RADIATED WORST CASE DATA: ABOVE 1GHz**

**MODE A FOR TRANSMISSION MODE (FCC PART 15, SUBPART C)**

<b>MODULATION TYPE</b>	GFSK	<b>CHANNEL</b>	0
<b>INPUT POWER</b>	3Vdc	<b>FREQUENCY RANGE</b>	1 ~ 25GHz
<b>ENVIRONMENTAL CONDITIONS</b>	25deg. C, 70%RH, 1002hPa	<b>DETECTOR FUNCTION</b>	Peak(PK) Average (AV)
<b>TEST MODE</b>	A	<b>TESTED BY</b>	Jamison Chan

**ANTENNA POLARITY & TEST DISTANCE: HORIZONTAL AT 3 M**

No.	Freq. (MHz)	Emission Level (dBuV/m)	Limit (dBuV/m)	Margin (dB)	Antenna Height (m)	Table Angle (Degree)	Raw Value (dBuV)	Correction Factor (dB/m)
1	1201.00	42.00 PK	74.00	-32.00	1.00 H	250	14.23	27.77
1	1201.00	36.95 AV	54.00	-17.05	1.00 H	250	9.18	27.77
2	2390.00	55.03 PK	74.00	-18.97	1.36 H	265	23.52	31.51
2	2390.00	44.20 AV	54.00	-9.80	1.36 H	265	12.69	31.51
3	*2402.00	98.16 PK			1.36 H	265	66.61	31.55
3	*2402.00	86.43 AV			1.36 H	265	54.88	31.55
4	3603.00	45.37 PK	74.00	-28.63	1.00 H	234	11.59	33.78
4	3603.00	38.38 AV	54.00	-15.62	1.00 H	234	4.60	33.78
5	4804.00	62.08 PK	74.00	-11.92	1.00 H	244	25.19	36.89
<b>5</b>	<b>4804.00</b>	<b>50.35 AV</b>	<b>54.00</b>	<b>-3.65</b>	<b>1.00 H</b>	<b>244</b>	<b>13.46</b>	<b>36.89</b>
6	7206.00	54.45 PK	74.00	-19.55	1.25 H	187	11.48	42.97
6	7206.00	42.72 AV	54.00	-11.28	1.25 H	187	-0.25	42.97
7	9608.00	55.15 PK	74.00	-18.85	1.56 H	188	9.08	46.07
7	9608.00	43.42 AV	54.00	-10.58	1.56 H	188	-2.65	46.07

**ANTENNA POLARITY & TEST DISTANCE: VERTICAL AT 3 M**

No.	Freq. (MHz)	Emission Level (dBuV/m)	Limit (dBuV/m)	Margin (dB)	Antenna Height (m)	Table Angle (Degree)	Raw Value (dBuV)	Correction Factor (dB/m)
1	1201.00	39.76 PK	74.00	-34.24	1.36 V	187	11.99	27.77
1	1201.00	31.35 AV	54.00	-22.65	1.36 V	187	3.58	27.77
2	2390.00	55.03 PK	74.00	-18.97	1.66 V	113	23.52	31.51
2	2390.00	43.90 AV	54.00	-10.10	1.66 V	113	12.39	31.51
3	*2402.00	89.31 PK			1.66 V	113	57.76	31.55
3	*2402.00	77.58 AV			1.66 V	113	46.03	31.55
4	3603.00	43.93 PK	74.00	-30.07	1.12 V	6	10.15	33.78
4	3603.00	34.06 AV	54.00	-19.94	1.12 V	6	0.28	33.78
5	4804.00	61.52 PK	74.00	-12.48	1.08 V	359	24.63	36.89
5	4804.00	49.79 AV	54.00	-4.21	1.08 V	359	12.90	36.89
6	7206.00	55.14 PK	74.00	-18.86	1.59 V	88	12.17	42.97
6	7206.00	43.41 AV	54.00	-10.59	1.59 V	88	0.44	42.97
7	9608.00	54.74 PK	74.00	-19.26	1.62 V	289	8.67	46.07
7	9608.00	43.01 AV	54.00	-10.99	1.62 V	289	-3.06	46.07

- REMARKS:**
1. Emission level(dBuV/m)=Raw Value(dBuV) + Correction Factor(dB/m)
  2. Correction Factor(dB/m) = Antenna Factor (dB/m) + Cable Factor (dB)
  3. The other emission levels were very low against the limit.
  4. Margin value = Emission level – Limit value.
  5. “ \* “ : Fundamental frequency

<b>MODULATION TYPE</b>	GFSK	<b>CHANNEL</b>	38
<b>INPUT POWER</b>	3Vdc	<b>FREQUENCY RANGE</b>	1 ~ 25GHz
<b>ENVIRONMENTAL CONDITIONS</b>	25deg. C, 70%RH, 1002hPa	<b>DETECTOR FUNCTION</b>	Peak(PK) Average (AV)
<b>TEST MODE</b>	A	<b>TESTED BY</b>	Jamison Chan

#### ANTENNA POLARITY & TEST DISTANCE: HORIZONTAL AT 3 M

No.	Freq. (MHz)	Emission Level (dBuV/m)	Limit (dBuV/m)	Margin (dB)	Antenna Height (m)	Table Angle (Degree)	Raw Value (dBuV)	Correction Factor (dB/m)
1	1220.00	43.15 PK	74.00	-30.85	1.12 H	234	15.34	27.81
1	1220.00	39.26 AV	54.00	-14.74	1.12 H	234	11.45	27.81
2	*2440.00	97.28 PK			2.05 H	81	65.61	31.67
2	*2440.00	85.55 AV			2.05 H	81	53.88	31.67
3	3660.00	46.19 PK	74.00	-27.81	1.00 H	294	12.18	34.01
3	3660.00	38.55 AV	54.00	-15.45	1.00 H	294	4.54	34.01
4	4880.00	59.87 PK	74.00	-14.13	1.15 H	313	22.70	37.17
4	4880.00	48.14 AV	54.00	-5.86	1.15 H	313	10.97	37.17
5	7320.00	54.85 PK	74.00	-19.15	1.32 H	189	11.73	43.13
5	7320.00	43.12 AV	54.00	-10.88	1.32 H	189	-0.01	43.13
6	9760.00	54.44 PK	74.00	-19.56	1.30 H	360	8.39	46.04
6	9760.00	42.71 AV	54.00	-11.29	1.30 H	360	-3.33	46.04

#### ANTENNA POLARITY & TEST DISTANCE: VERTICAL AT 3 M

No.	Freq. (MHz)	Emission Level (dBuV/m)	Limit (dBuV/m)	Margin (dB)	Antenna Height (m)	Table Angle (Degree)	Raw Value (dBuV)	Correction Factor (dB/m)
1	1220.00	37.36 PK	74.00	-36.64	1.74 V	57	9.55	27.81
1	1220.00	27.49 AV	54.00	-26.51	1.74 V	57	-0.32	27.81
2	*2440.00	89.94 PK			1.67 V	4	58.27	31.67
2	*2440.00	78.21 AV			1.67 V	4	46.54	31.67
3	3660.00	44.95 PK	74.00	-29.05	1.69 V	20	10.94	34.01
3	3660.00	35.16 AV	54.00	-18.84	1.69 V	20	1.15	34.01
4	4880.00	58.00 PK	74.00	-16.00	1.16 V	17	20.83	37.17
4	4880.00	46.27 AV	54.00	-7.73	1.16 V	17	9.10	37.17
5	7320.00	54.96 PK	74.00	-19.04	1.47 V	277	11.84	43.13
5	7320.00	43.23 AV	54.00	-10.77	1.47 V	277	0.10	43.13
6	9760.00	54.72 PK	74.00	-19.28	1.64 V	297	8.67	46.04
6	9760.00	42.99 AV	54.00	-11.01	1.64 V	297	-3.05	46.04

- REMARKS:**
1. Emission level(dBuV/m)=Raw Value(dBuV) + Correction Factor(dB/m)
  2. Correction Factor(dB/m) = Antenna Factor (dB/m) + Cable Factor (dB)
  3. The other emission levels were very low against the limit.
  4. Margin value = Emission level – Limit value.
  5. “ \* “ : Fundamental frequency

<b>MODULATION TYPE</b>	GFSK	<b>CHANNEL</b>	77
<b>INPUT POWER</b>	3Vdc	<b>FREQUENCY RANGE</b>	1 ~ 25GHz
<b>ENVIRONMENTAL CONDITIONS</b>	25deg. C, 70%RH, 1002hPa	<b>DETECTOR FUNCTION</b>	Peak(PK) Average (AV)
<b>TEST MODE</b>	A	<b>TESTED BY</b>	Jamison Chan

#### ANTENNA POLARITY & TEST DISTANCE: HORIZONTAL AT 3 M

No.	Freq. (MHz)	Emission Level (dBuV/m)	Limit (dBuV/m)	Margin (dB)	Antenna Height (m)	Table Angle (Degree)	Raw Value (dBuV)	Correction Factor (dB/m)
1	1239.50	42.94 PK	74.00	-31.06	1.16 H	262	15.08	27.86
1	1239.50	38.34 AV	54.00	-15.66	1.16 H	262	10.48	27.86
2	*2479.00	96.93 PK			1.37 H	263	65.14	31.79
2	*2479.00	85.20 AV			1.37 H	263	53.41	31.79
3	2483.50	55.97 PK	74.00	-18.03	1.37 H	263	24.16	31.81
3	2483.50	46.90 AV	54.00	-7.10	1.37 H	263	15.09	31.81
4	3718.50	46.69 PK	74.00	-27.31	1.00 H	228	12.45	34.24
4	3718.50	39.41 AV	54.00	-14.59	1.00 H	228	5.17	34.24
5	4958.00	58.57 PK	74.00	-15.43	1.00 H	326	21.23	37.34
5	4958.00	46.84 AV	54.00	-7.16	1.00 H	326	9.50	37.34
6	7437.00	55.29 PK	74.00	-18.71	1.00 H	180	11.76	43.53
6	7437.00	43.56 AV	54.00	-10.44	1.00 H	180	0.03	43.53
7	9916.00	54.25 PK	74.00	-19.75	1.37 H	184	7.89	46.36
7	9916.00	42.52 AV	54.00	-11.48	1.37 H	184	-3.84	46.36

#### ANTENNA POLARITY & TEST DISTANCE: VERTICAL AT 3 M

No.	Freq. (MHz)	Emission Level (dBuV/m)	Limit (dBuV/m)	Margin (dB)	Antenna Height (m)	Table Angle (Degree)	Raw Value (dBuV)	Correction Factor (dB/m)
1	1239.50	39.10 PK	74.00	-34.90	1.14 V	8	11.24	27.86
1	1239.50	31.36 AV	54.00	-22.64	1.14 V	8	3.50	27.86
2	*2479.00	86.53 PK			1.64 V	124	54.74	31.79
2	*2479.00	74.80 AV			1.64 V	124	43.01	31.79
3	2483.50	54.98 PK	74.00	-19.02	1.64 V	124	23.17	31.81
3	2483.50	44.59 AV	54.00	-9.41	1.64 V	124	12.78	31.81
4	3718.50	44.81 PK	74.00	-29.19	1.61 V	20	10.57	34.24
4	3718.50	34.74 AV	54.00	-19.26	1.61 V	20	0.50	34.24
5	4958.00	56.38 PK	74.00	-17.62	1.30 V	260	19.04	37.34
5	4958.00	44.65 AV	54.00	-9.35	1.30 V	260	7.31	37.34
6	7437.00	55.89 PK	74.00	-18.11	1.36 V	90	12.36	43.53
6	7437.00	44.16 AV	54.00	-9.84	1.36 V	90	0.63	43.53
7	9916.00	53.59 PK	74.00	-20.41	1.41 V	298	7.23	46.36
7	9916.00	41.86 AV	54.00	-12.14	1.41 V	298	-4.50	46.36

- REMARKS:**
1. Emission level(dBuV/m)=Raw Value(dBuV) + Correction Factor(dB/m)
  2. Correction Factor(dB/m) = Antenna Factor (dB/m) + Cable Factor (dB)
  3. The other emission levels were very low against the limit.
  4. Margin value = Emission level – Limit value.
  5. " \* " : Fundamental frequency



**MODE B FOR TRANSMISSION MODE (FCC PART 15, SUBPART B)**

<b>MODULATION TYPE</b>	GFSK	<b>CHANNEL</b>	0
<b>INPUT POWER</b>	3Vdc	<b>FREQUENCY RANGE</b>	1 ~ 25GHz
<b>ENVIRONMENTAL CONDITIONS</b>	25deg. C, 70%RH, 1002hPa	<b>DETECTOR FUNCTION</b>	Peak(PK) Average (AV)
<b>TEST MODE</b>	B	<b>TESTED BY</b>	Jamison Chan

**ANTENNA POLARITY & TEST DISTANCE: HORIZONTAL AT 3 M**

No.	Freq. (MHz)	Emission Level (dBuV/m)	Limit (dBuV/m)	Margin (dB)	Antenna Height (m)	Table Angle (Degree)	Raw Value (dBuV)	Correction Factor (dB/m)
1	2474.00	44.09 PK	74.00	-29.91	1.18 H	20	12.32	31.78
1	2474.00	37.94 AV	54.00	-16.06	1.18 H	20	6.17	31.78

**ANTENNA POLARITY & TEST DISTANCE: VERTICAL AT 3 M**

No.	Freq. (MHz)	Emission Level (dBuV/m)	Limit (dBuV/m)	Margin (dB)	Antenna Height (m)	Table Angle (Degree)	Raw Value (dBuV)	Correction Factor (dB/m)
1	2474.00	42.28 PK	74.00	-31.72	1.21 V	299	10.51	31.78
1	2474.00	32.57 AV	54.00	-21.43	1.21 V	299	0.80	31.78

- REMARKS:**
1. Emission level(dBuV/m)=Raw Value(dBuV) + Correction Factor(dB/m)
  2. Correction Factor(dB/m) = Antenna Factor (dB/m) + Cable Factor (dB)
  3. The other emission levels were very low against the limit.
  4. Margin value = Emission level – Limit value.

<b>MODULATION TYPE</b>	GFSK	<b>CHANNEL</b>	38
<b>INPUT POWER</b>	3Vdc	<b>FREQUENCY RANGE</b>	1 ~ 25GHz
<b>ENVIRONMENTAL CONDITIONS</b>	25deg. C, 70%RH, 1002hPa	<b>DETECTOR FUNCTION</b>	Peak(PK) Average (AV)
<b>TEST MODE</b>	B	<b>TESTED BY</b>	Jamison Chan

#### ANTENNA POLARITY & TEST DISTANCE: HORIZONTAL AT 3 M

No.	Freq. (MHz)	Emission Level (dBuV/m)	Limit (dBuV/m)	Margin (dB)	Antenna Height (m)	Table Angle (Degree)	Raw Value (dBuV)	Correction Factor (dB/m)
1	2490.50	44.93 PK	74.00	-29.07	1.17 H	143	13.10	31.83
1	2490.50	39.43 AV	54.00	-14.57	1.17 H	143	7.60	31.83

#### ANTENNA POLARITY & TEST DISTANCE: VERTICAL AT 3 M

No.	Freq. (MHz)	Emission Level (dBuV/m)	Limit (dBuV/m)	Margin (dB)	Antenna Height (m)	Table Angle (Degree)	Raw Value (dBuV)	Correction Factor (dB/m)
1	2490.50	40.79 PK	74.00	-33.21	1.18 V	292	8.96	31.83
1	2490.50	31.92 AV	54.00	-22.08	1.18 V	292	0.09	31.83

- REMARKS:**
1. Emission level(dBuV/m)=Raw Value(dBuV) + Correction Factor(dB/m)
  2. Correction Factor(dB/m) = Antenna Factor (dB/m) + Cable Factor (dB)
  3. The other emission levels were very low against the limit.
  4. Margin value = Emission level – Limit value.

<b>MODULATION TYPE</b>	GFSK	<b>CHANNEL</b>	77
<b>INPUT POWER</b>	3Vdc	<b>FREQUENCY RANGE</b>	1 ~ 25GHz
<b>ENVIRONMENTAL CONDITIONS</b>	25deg. C, 70%RH, 1002hPa	<b>DETECTOR FUNCTION</b>	Peak(PK) Average (AV)
<b>TEST MODE</b>	B	<b>TESTED BY</b>	Jamison Chan

**ANTENNA POLARITY & TEST DISTANCE: HORIZONTAL AT 3 M**

No.	Freq. (MHz)	Emission Level (dBuV/m)	Limit (dBuV/m)	Margin (dB)	Antenna Height (m)	Table Angle (Degree)	Raw Value (dBuV)	Correction Factor (dB/m)
1	2835.00	45.29 PK	74.00	-28.71	1.15 H	145	12.70	32.59
1	2835.00	40.00 AV	54.00	-14.00	1.15 H	145	7.41	32.59

**ANTENNA POLARITY & TEST DISTANCE: VERTICAL AT 3 M**

No.	Freq. (MHz)	Emission Level (dBuV/m)	Limit (dBuV/m)	Margin (dB)	Antenna Height (m)	Table Angle (Degree)	Raw Value (dBuV)	Correction Factor (dB/m)
1	2835.00	42.39 PK	74.00	-31.61	1.03 V	4	9.80	32.59
1	2835.00	33.94 AV	54.00	-20.06	1.03 V	4	1.35	32.59

- REMARKS:**
1. Emission level(dBuV/m)=Raw Value(dBuV) + Correction Factor(dB/m)
  2. Correction Factor(dB/m) = Antenna Factor (dB/m) + Cable Factor (dB)
  3. The other emission levels were very low against the limit.
  4. Margin value = Emission level – Limit value.

## 4.3 6dB BANDWIDTH MEASUREMENT

### 4.3.1 LIMITS OF 6dB BANDWIDTH MEASUREMENT

The minimum of 6dB Bandwidth Measurement is 0.5 MHz.

### 4.3.2 TEST INSTRUMENTS

Description & Manufacturer	Model No.	Serial No.	Calibrated Until
SPECTRUM ANALYZER	FSP 40	100036	Mar. 16. 2007

**NOTE:** The calibration interval of the above test instruments is 12 months and the calibrations are traceable to NML/ROC and NIST/USA.

### 4.3.3 TEST PROCEDURE

The transmitter output was connected to the spectrum analyzer through an attenuator. The bandwidth of the fundamental frequency was measured by spectrum analyzer with 100kHz RBW and 100kHz VBW. The 6dB bandwidth is defined as the total spectrum the power of which is higher than peak power minus 6dB.

### 4.3.4 DEVIATION FROM TEST STANDARD

No deviation

### 4.3.5 TEST SETUP

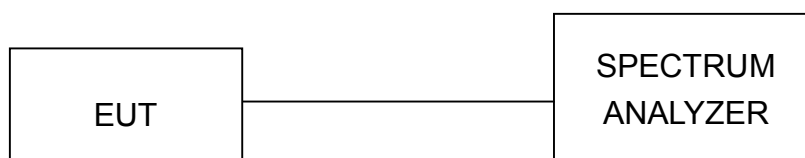

### 4.3.6 EUT OPERATING CONDITIONS

The software provided by client enabled the EUT to transmit and receive data at lowest, middle and highest channel frequencies individually.

### 4.3.7 TEST RESULTS

<b>MODULATION TYPE</b>	GFSK	<b>CHANNEL</b>	0, 38, 77
<b>INPUT POWER</b>	3Vdc	<b>ENVIRONMENTAL CONDITIONS</b>	23deg. C, 75%RH, 1005hPa
<b>TEST MODE</b>	A	<b>TESTED BY</b>	Jamison Chan

CHANNEL	CHANNEL FREQUENCY (MHz)	6dB BANDWIDTH (MHz)	MINIMUM LIMIT (MHz)	PASS/FAIL
0	2402	0.684	0.5	PASS
38	2440	0.676	0.5	PASS
77	2479	0.672	0.5	PASS

#### CH 0

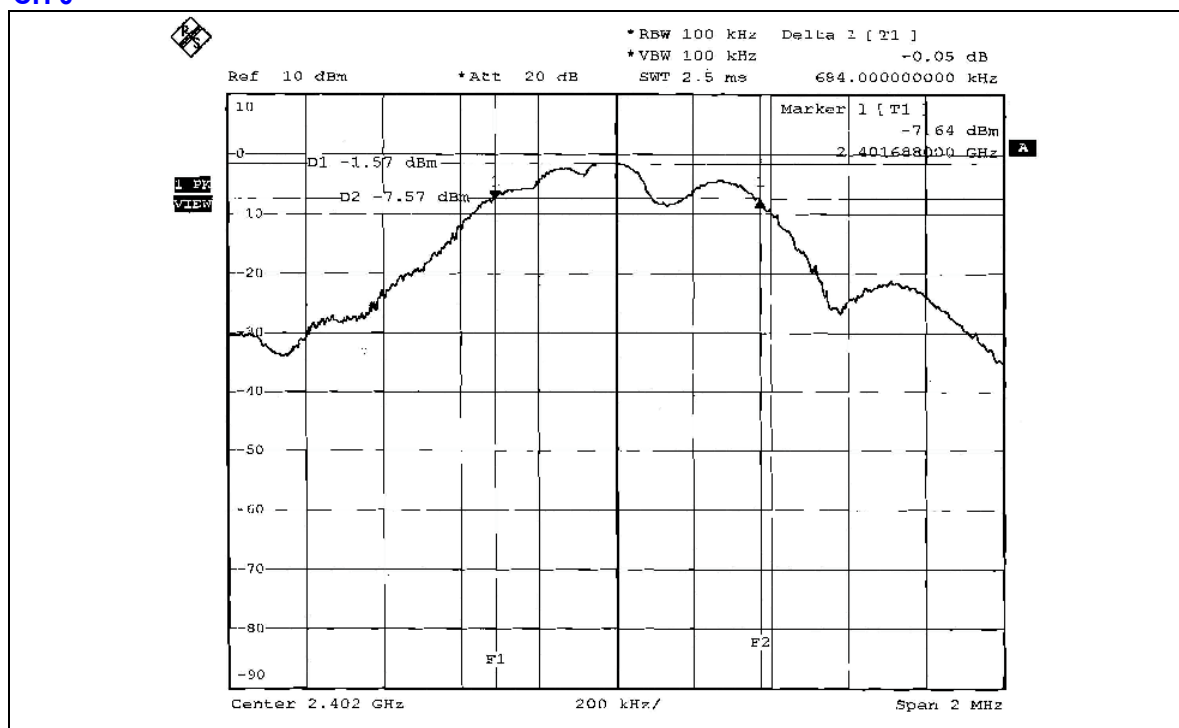

CH 38

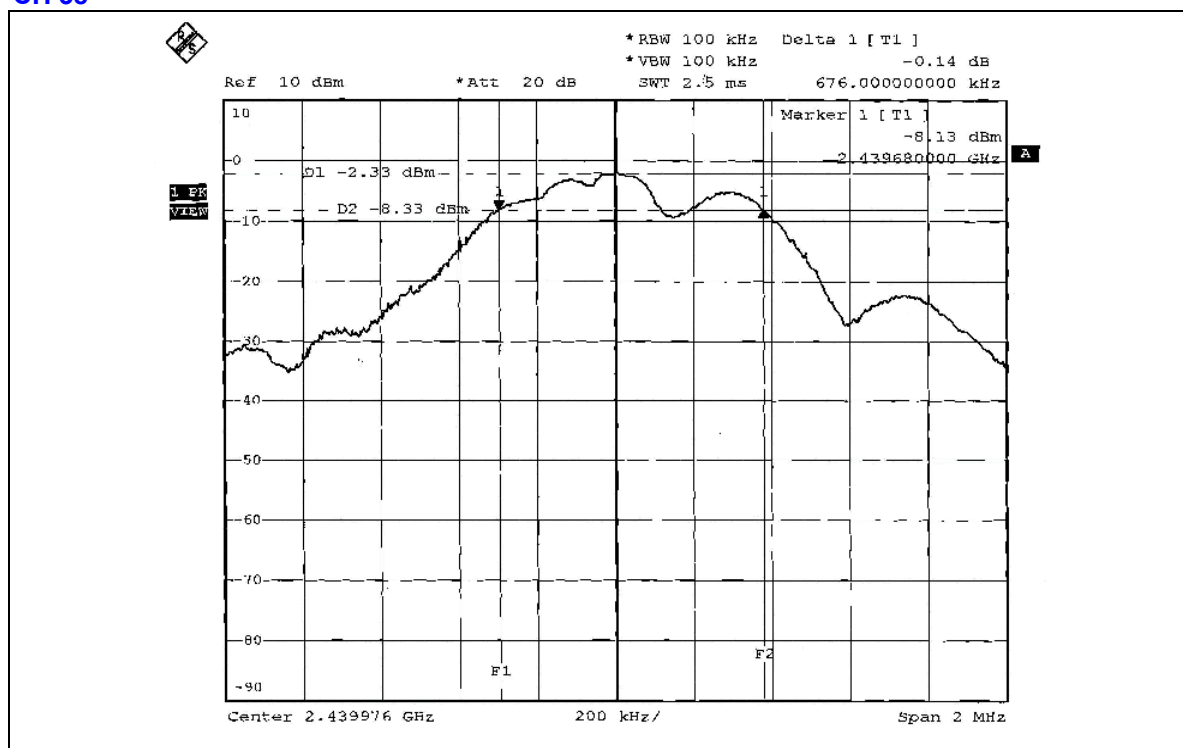

CH 77

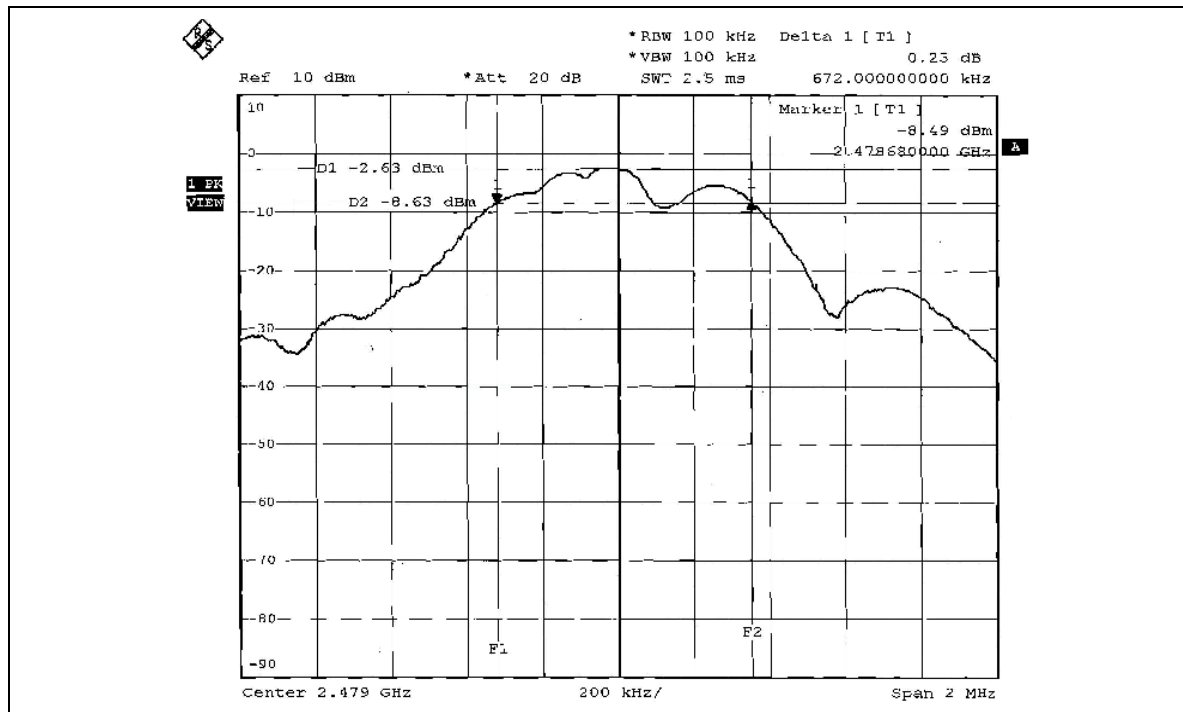



## 4.4 MAXIMUM PEAK OUTPUT POWER

### 4.4.1 LIMITS OF MAXIMUM PEAK OUTPUT POWER MEASUREMENT

The Maximum Peak Output Power Measurement is 30dBm.

### 4.4.2 INSTRUMENTS

Description & Manufacturer	Model No.	Serial No.	Calibrated Until
SPECTRUM ANALYZER	FSP 40	100036	Mar. 16. 2007

**NOTE:** The calibration interval of the above test instruments is 12 months and the calibrations are traceable to NML/ROC and NIST/USA.

### 4.4.3 TEST PROCEDURES

1. Check the calibration of the measuring instrument using either an internal calibrator or a known signal from an external generator.
2. Turn on the EUT and connect it to measurement instrument. Then set it to any one convenient frequency within its operating range. Set a reference level on the measuring instrument equal to the highest peak value.
3. The center frequency of the spectrum analyzer is set to the fundamental frequency and using 1 MHz RBW and 1 MHz VBW, the peak value was measured and recorded.
4. Repeat above procedures until all frequencies measured were complete.

Note: The spectrum plots are attached on following pages.

### 4.4.4 DEVIATION FROM TEST STANDARD

No deviation

#### 4.4.5 TEST SETUP

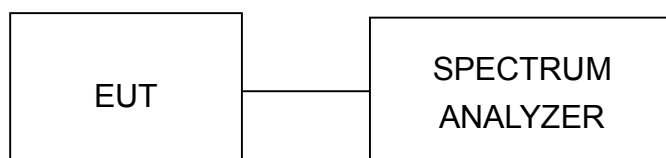

#### 4.4.6 EUT OPERATING CONDITIONS

Same as Item 4.3.6

#### 4.4.7 TEST RESULTS

<b>MODULATION TYPE</b>	GFSK	<b>CHANNEL</b>	0, 38, 77
<b>INPUT POWER</b>	3Vdc	<b>ENVIRONMENTAL CONDITIONS</b>	23deg. C, 75%RH, 1005hPa
<b>TEST MODE</b>	A	<b>TESTED BY</b>	Jamison Chan

CHANNEL	CHANNEL FREQUENCY (MHz)	PEAK POWER OUTPUT (dBm)	PEAK POWER OUTPUT (mW)	PEAK POWER LIMIT (dBm)	PASS/FAIL
0	2402	0.65	1.161	30	PASS
38	2440	-0.13	0.971	30	PASS
77	2479	-0.54	0.883	30	PASS



## 4.5 POWER SPECTRAL DENSITY MEASUREMENT

### 4.5.1 LIMITS OF POWER SPECTRAL DENSITY MEASUREMENT

The Maximum of Power Spectral Density Measurement is 8dBm.

### 4.5.2 TEST INSTRUMENTS

Description & Manufacturer	Model No.	Serial No.	Calibrated Until
SPECTRUM ANALYZER	FSP 40	100036	Mar. 16. 2007

**NOTE:** The calibration interval of the above test instruments is 12 months and the calibrations are traceable to NML/ROC and NIST/USA.

### 4.5.3 TEST PROCEDURE

The transmitter output was connected to the spectrum analyzer through an attenuator, the bandwidth of the fundamental frequency was measured with the spectrum analyzer using 3kHz RBW and 30kHz VBW, set sweep time = span/3kHz.

The power spectral density was measured and recorded.

The sweep time is allowed to be longer than span/3kHz for a full response of the mixer in the spectrum analyzer.

### 4.5.4 DEVIATION FROM TEST STANDARD

No deviation

### 4.5.5 TEST SETUP

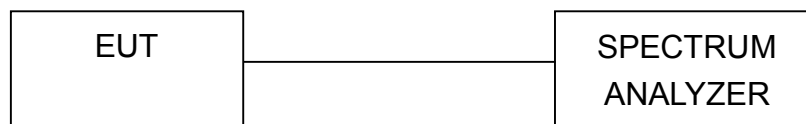

### 4.5.6 EUT OPERATING CONDITION

Same as Item 4.3.6

## 4.5.7 TEST RESULTS

<b>MODULATION TYPE</b>	GFSK	<b>CHANNEL</b>	0, 38, 77
<b>INPUT POWER</b>	3Vdc	<b>ENVIRONMENTAL CONDITIONS</b>	23deg. C, 75%RH, 1005hPa
<b>TEST MODE</b>	A	<b>TESTED BY</b>	Jamison Chan

CHANNEL	CHANNEL FREQUENCY (MHz)	RF POWER LEVEL IN 3kHz BW (dBm)	MAXIMUM LIMIT (dBm)	PASS/FAIL
0	2402	-3.07	8	PASS
38	2440	-3.73	8	PASS
77	2479	-4.04	8	PASS

### CH 0

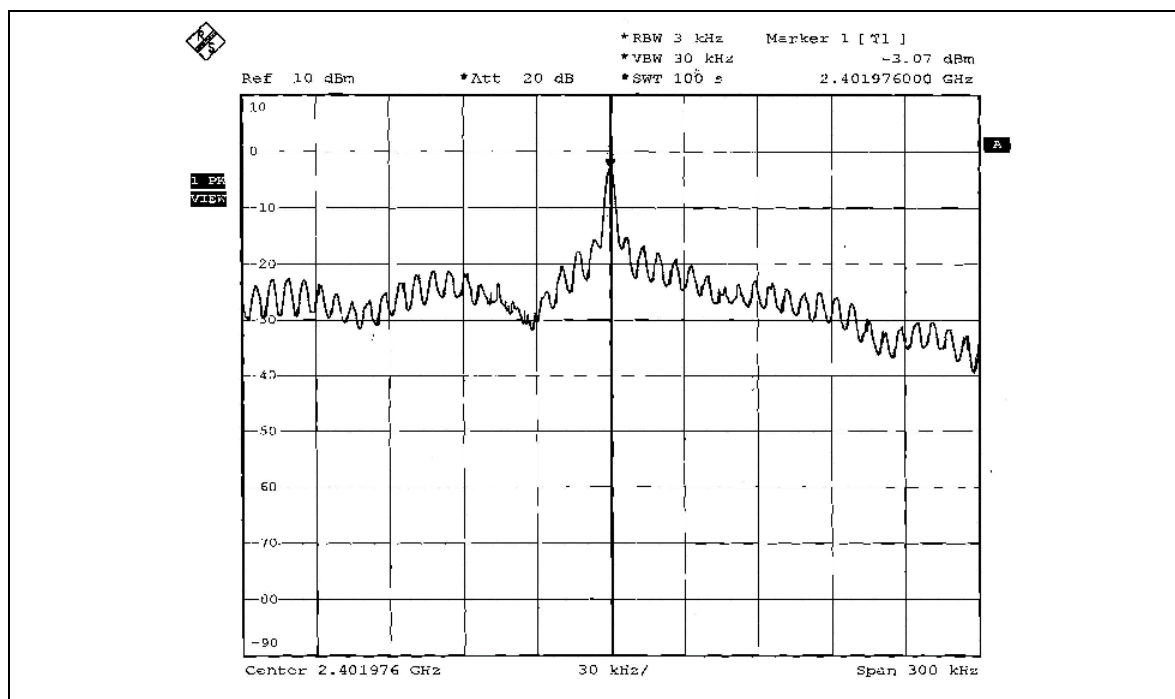

### CH 38

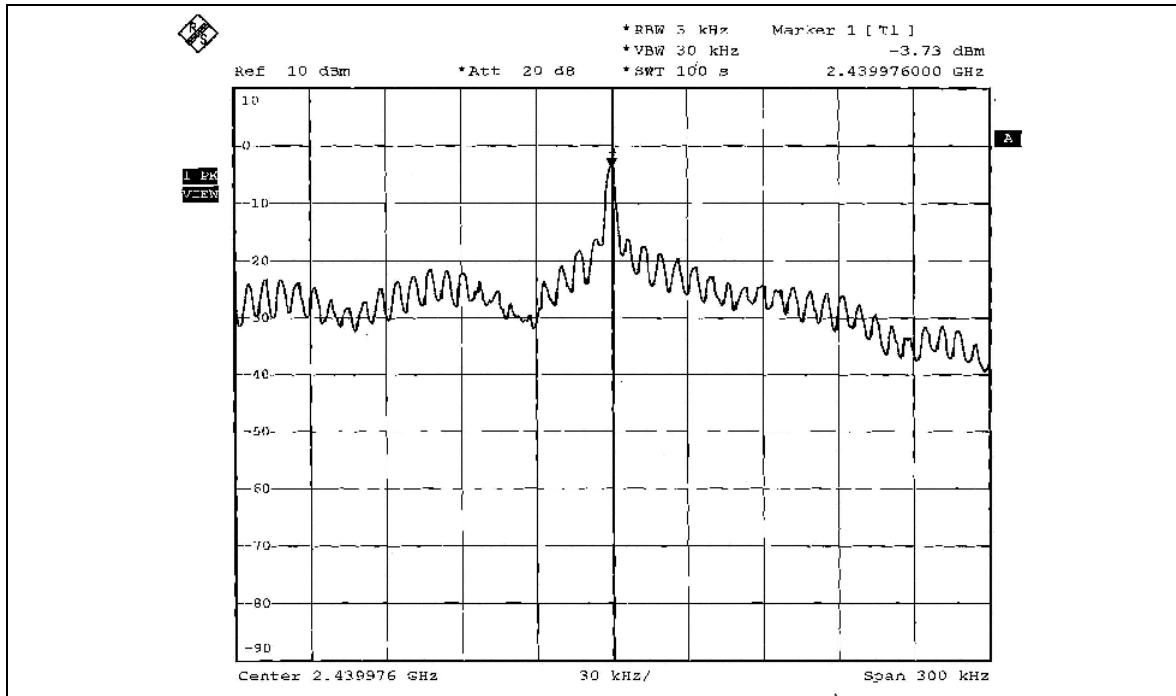

### CH 77

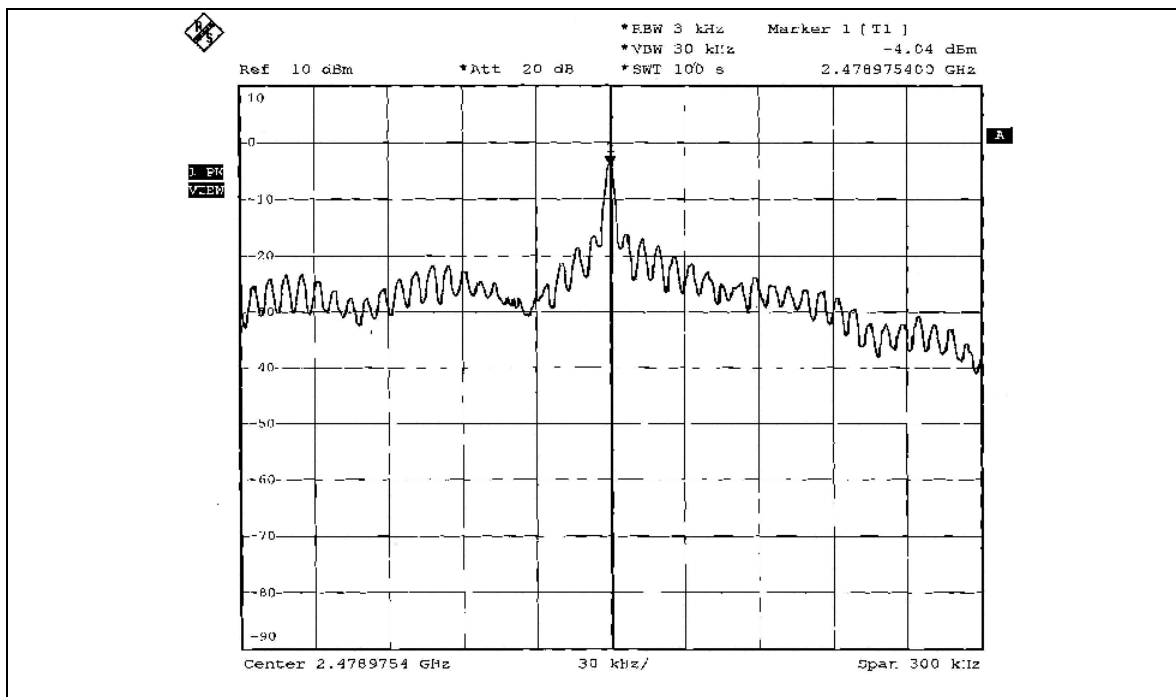



## 4.6 BAND EDGES MEASUREMENT

### 4.6.1 LIMITS OF BAND EDGES MEASUREMENT

Below  $-20\text{dB}$  of the highest emission level of operating band (in 100kHz Resolution Bandwidth).

### 4.6.2 TEST INSTRUMENTS

Description & Manufacturer	Model No.	Serial No.	Calibrated Until
SPECTRUM ANALYZER	FSP 40	100036	Mar. 16. 2007

**NOTE:** The calibration interval of the above test instruments is 12 months and the calibrations are traceable to NML/ROC and NIST/USA.

### 4.6.3 TEST PROCEDURE

The transmitter output was connected to the spectrum analyzer via a low lose cable. Set both RBW and VBW of spectrum analyzer to 100 kHz and 100 kHz suitable frequency span including 100 MHz bandwidth from band edge. The band edges was measured and recorded.

The spectrum plots (Peak RBW=VBW=100kHz) are attached on the following pages.

### 4.6.4 DEVIATION FROM TEST STANDARD

No deviation

### 4.6.5 EUT OPERATING CONDITION

Same as Item 4.3.6

## 4.6.6 TEST RESULTS

The spectrum plots are attached on the following 2 images. D1 line indicates the highest level, and D2 line indicates the 20dB offset below D1. It shows compliance with the requirement in part 15.247(d).

### Note 1:

The band edge emission plot on page 34 shows 57.35dBc between carrier maximum power and local maximum emission in restrict band (2.3862GHz). The emission of carrier strength list in the test result of channel 0 at the item 4.2.7 is 98.16dBuV/m (Peak), so the maximum field strength in restrict band is  $98.16 - 57.35 = 40.81$ dBuV/m which is under 74dBuV/m limit.

The band edge emission plot of on page 34 shows 65.23dBc between carrier maximum power and local maximum emission in restrict band (2.3862GHz). The emission of carrier strength list in the test result of channel 1 at the item 4.2.7 is 86.43dBuV/m (Average), so the maximum field strength in restrict band is  $86.43 - 65.23 = 21.20$ BuV/m which is under 54dBuV/m limit.

### Note 2:

The band edge emission plot on page 35 shows 54.79dBc between carrier maximum power and local maximum emission in restrict band (2.4949GHz). The emission of carrier strength list in the test result of channel 77 at the item 4.2.7 is 96.93dBuV/m (Peak), so the maximum field strength in restrict band is  $96.93 - 54.79 = 42.14$ dBuV/m which is under 74dBuV/m limit.

The band edge emission plot of on page 36 shows 52.63dBc between carrier maximum power and local maximum emission in restrict band (2.4835GHz). The emission of carrier strength list in the test result of channel 77 at the item 4.2.7 is 85.20dBuV/m (Average), so the maximum field strength in restrict band is  $85.20 - 52.63 = 32.57$ BuV/m which is under 54dBuV/m limit.

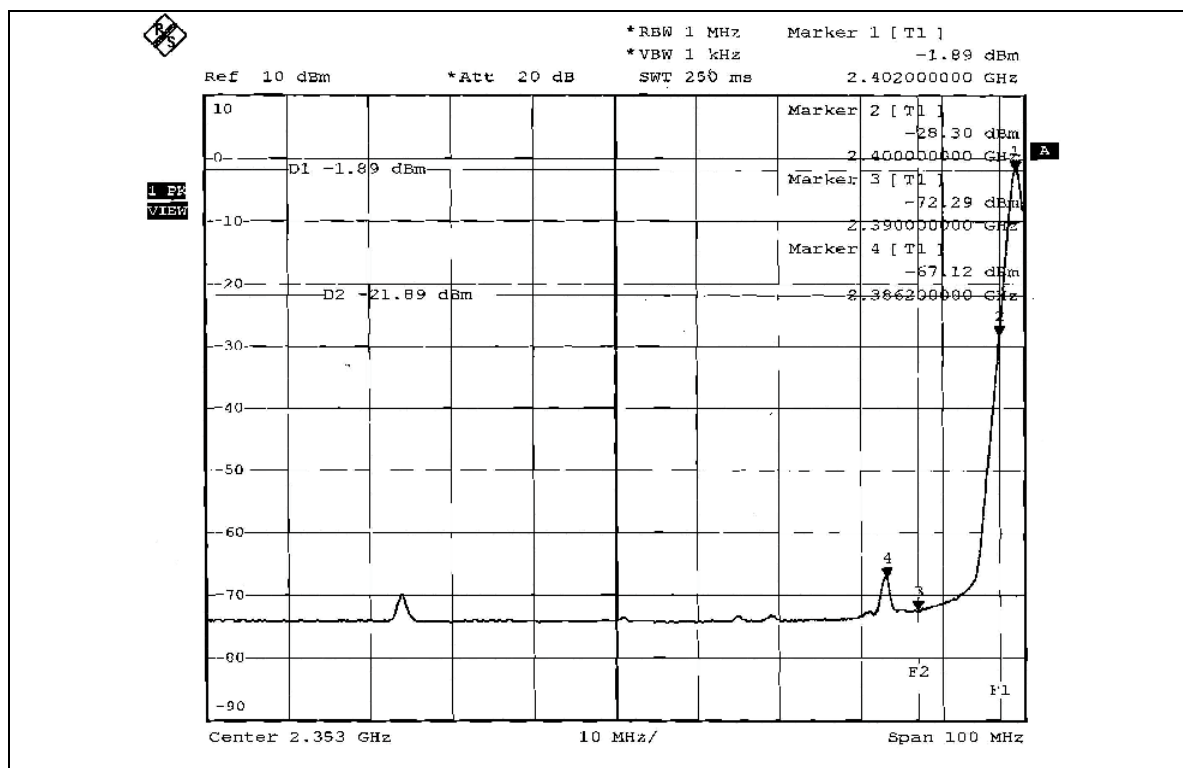
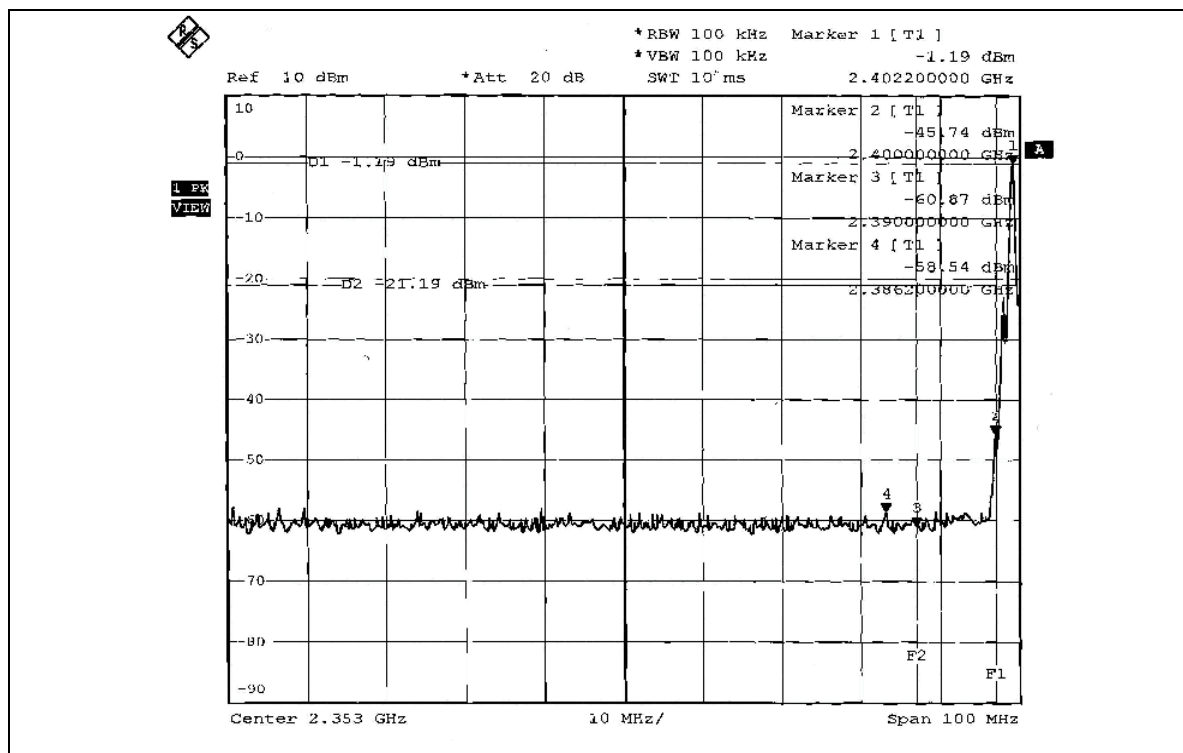

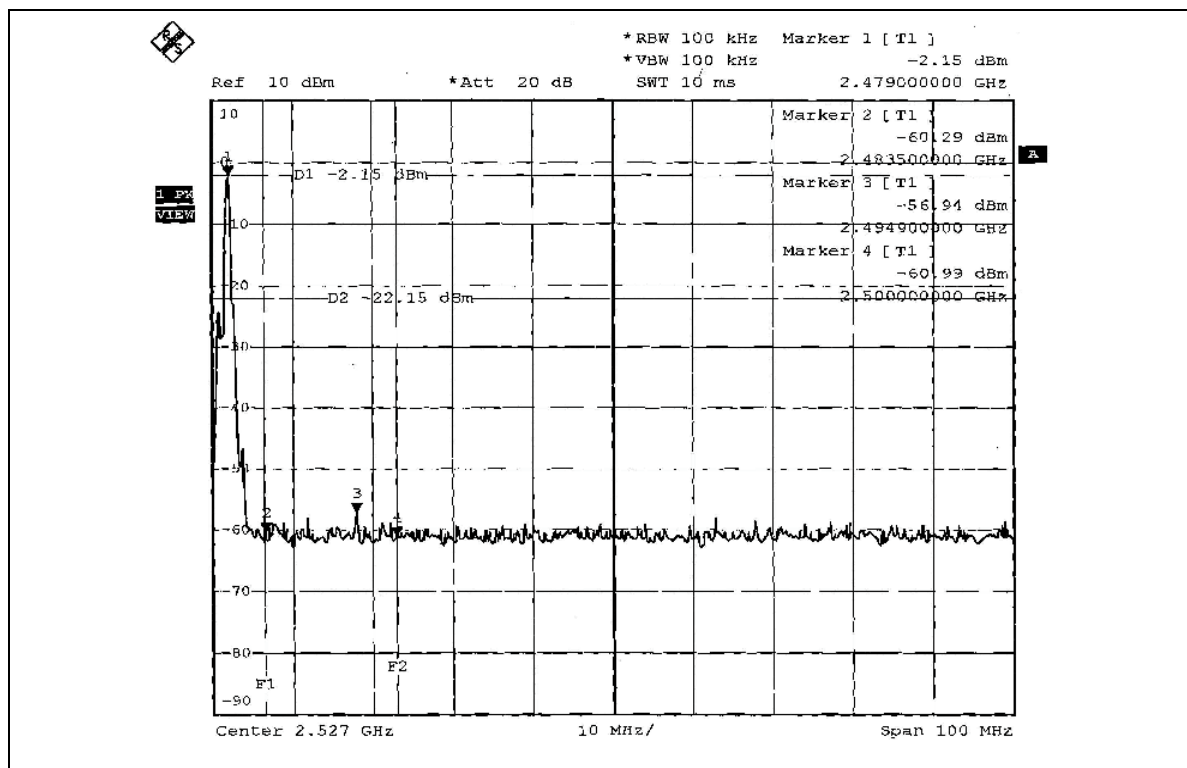
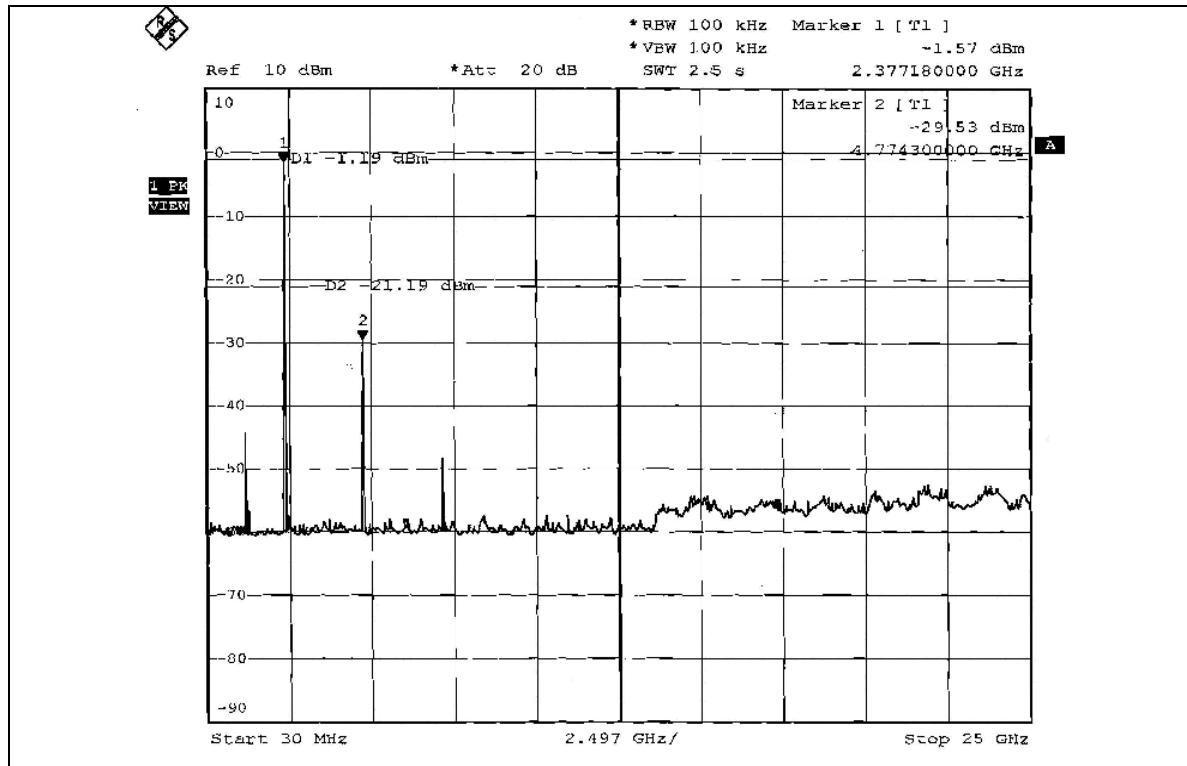

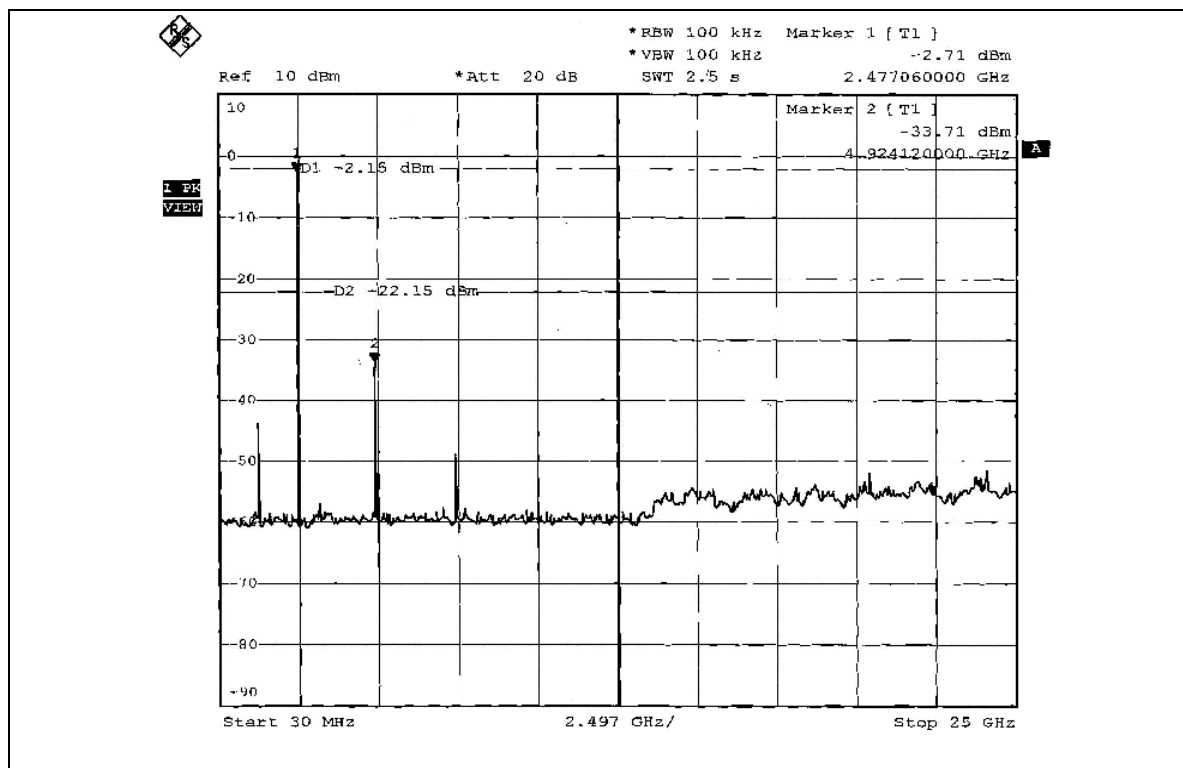
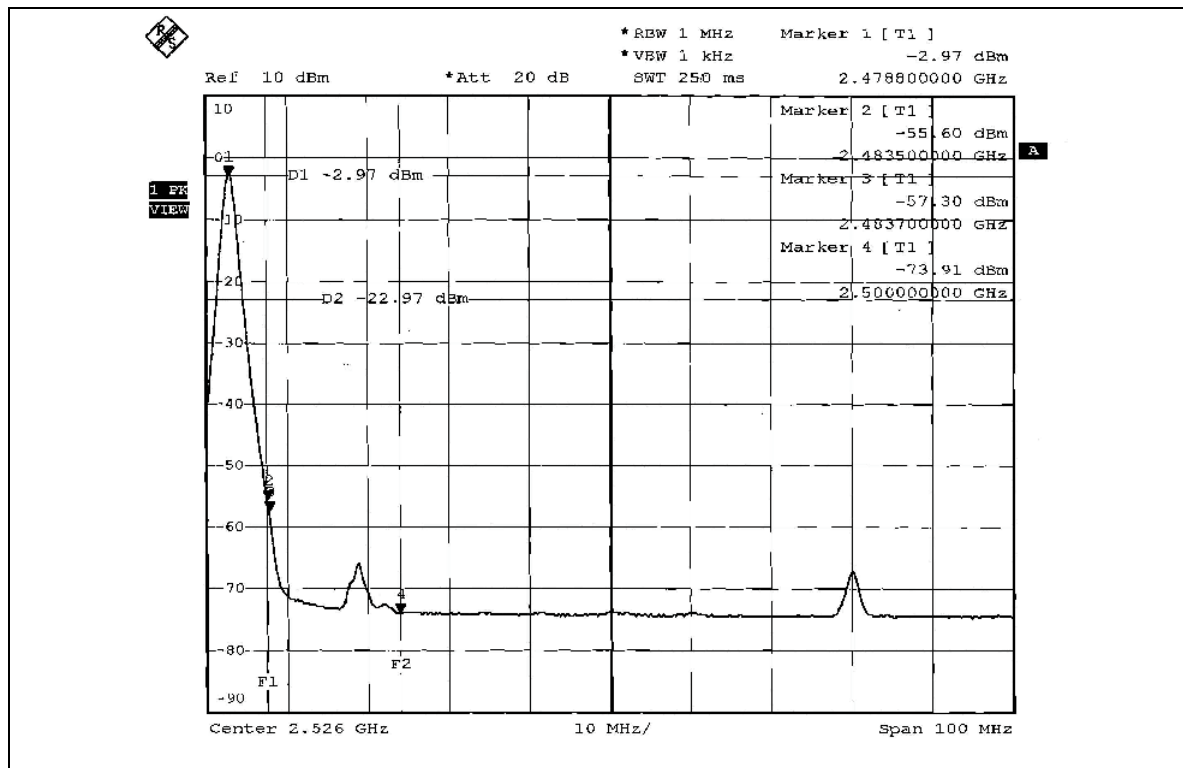



## **4.7 ANTENNA REQUIREMENT**

### **4.7.1 STANDARD APPLICABLE**

For intentional device, according to FCC 47 CFR Section 15.203, an intentional radiator shall be designed to ensure that no antenna other than that furnished by the responsible party shall be used with the device. And according to FCC 47 CFR Section 15.247 (b), if transmitting antennas of directional gain greater than 6dBi are used, the power shall be reduced by the amount in dB that the directional gain of the antenna exceeds 6dBi.

### **4.7.2 ANTENNA CONNECTED CONSTRUCTION**

The antenna used in this product is Strip antenna without connector. The maximum Gain of the antenna is  $-3.92\text{dBi}$ .

## 5. PHOTOGRAPHS OF THE TEST CONFIGURATION

### RADIATED EMISSION TEST (Mode A)



## RADIATED EMISSION TEST (Mode B)





## 6. INFORMATION ON THE TESTING LABORATORIES

We, ADT Corp., were founded in 1988 to provide our best service in EMC, Radio, Telecom and Safety consultation. Our laboratories are accredited and approved by the following approval agencies according to ISO/IEC 17025.

<b>USA</b>	FCC, UL, A2LA
<b>Germany</b>	TUV Rheinland
<b>Japan</b>	VCCI
<b>Norway</b>	NEMKO
<b>Canada</b>	INDUSTRY CANADA , CSA
<b>R.O.C.</b>	CNLA, BSMI, NCC
<b>Netherlands</b>	Telefication
<b>Singapore</b>	PSB, GOST-ASIA(MOU)
<b>Russia</b>	CERTIS(MOU)

Copies of accreditation certificates of our laboratories obtained from approval agencies can be downloaded from our web site:

[www.adt.com.tw/index.5/phtml](http://www.adt.com.tw/index.5/phtml). If you have any comments, please feel free to contact us at the following:

**Linko EMC/RF Lab:**

Tel: 886-2-26052180  
Fax: 886-2-26051924

**Hsin Chu EMC/RF Lab:**

Tel: 886-3-5935343  
Fax: 886-3-5935342

**Hwa Ya EMC/RF/Safety Telecom Lab:**

Tel: 886-3-3183232  
Fax: 886-3-3185050

**Web Site:** [www.adt.com.tw](http://www.adt.com.tw)

The address and road map of all our labs can be found in our web site also

## **APPENDIX-A**

### **MODIFICATIONS RECORDERS FOR ENGINEERING CHANGES TO THE EUT BY THE LAB**

No any modifications are made to the EUT by the lab during the test.