



A D T

FCC TEST REPORT

REPORT NO.: RF140430D04
MODEL NO.: KT-1408
FCC ID: E8HKT-1408
RECEIVED: Apr. 30, 2014
TESTED: May 8 ~ 21, 2014
ISSUED: May 22, 2014

APPLICANT: Chicony Electronics Co., Ltd.

ADDRESS: NO. 25, Wu-Gong 6th Rd., Wugu Dist., New Taipei City 248, Taiwan, R.O.C.

ISSUED BY: Bureau Veritas Consumer Products Services (H.K.) Ltd., Taoyuan Branch

LAB LOCATION: No. 47, 14th Ling, Chia Pau Vil., Lin Kou Dist., New Taipei City, Taiwan (R.O.C.)

This report should not be used by the client to claim product certification, approval, or endorsement by TAF or any government agencies.



This report is for your exclusive use. Any copying or replication of this report to or for any other person or entity, or use of our name or trademark, is permitted only with our prior written permission. This report sets forth our findings solely with respect to the test samples identified herein. The results set forth in this report are not indicative or representative of the quality or characteristics of the lot from which a test sample was taken or any similar or identical product unless specifically and expressly noted. Our report includes all of the tests requested by you and the results thereof based upon the information that you provided to us. You have 60 days from date of issuance of this report to notify us of any material error or omission caused by our negligence, provided, however, that such notice shall be in writing and shall specifically address the issue you wish to raise. A failure to raise such issue within the prescribed time shall constitute your unqualified acceptance of the completeness of this report, the tests conducted and the correctness of the report contents. Unless specific mention, the uncertainty of measurement has been explicitly taken into account to declare the compliance or non-compliance to the specification



Table of Contents

RELEASE CONTROL RECORD.....	4
1. CERTIFICATION	5
2. SUMMARY OF TEST RESULTS.....	6
2.1 MEASUREMENT UNCERTAINTY	6
3. GENERAL INFORMATION	7
3.1 GENERAL DESCRIPTION OF EUT.....	7
3.2 DESCRIPTION OF TEST MODES.....	8
3.2.1 TEST MODE APPLICABILITY AND TESTED CHANNEL DETAIL	9
3.3 DESCRIPTION OF SUPPORT UNITS	12
3.3.1 CONFIGURATION OF SYSTEM UNDER TEST	13
3.4 GENERAL DESCRIPTION OF APPLIED STANDARDS	14
4. TEST TYPES AND RESULTS	15
4.1 CONDUCTED EMISSION MEASUREMENT	15
4.1.1 LIMITS OF CONDUCTED EMISSION MEASUREMENT.....	15
4.1.2 TEST INSTRUMENTS	15
4.1.3 TEST PROCEDURES.....	16
4.1.4 DEVIATION FROM TEST STANDARD	16
4.1.5 TEST SETUP	17
4.1.6 EUT OPERATING CONDITIONS.....	17
4.1.7 TEST RESULTS.....	18
4.2 RADIATED EMISSION AND BANDEDGE MEASUREMENT.....	22
4.2.1 LIMITS OF RADIATED EMISSION AND BANDEDGE MEASUREMENT	22
4.2.2 TEST INSTRUMENTS	23
4.2.3 TEST PROCEDURES.....	25
4.2.4 DEVIATION FROM TEST STANDARD	25
4.2.5 TEST SETUP	26
4.2.6 EUT OPERATING CONDITIONS.....	27
4.2.7 TEST RESULTS.....	28
4.3 NUMBER OF HOPPING FREQUENCY USED	37
4.3.1 LIMIT OF HOPPING FREQUENCY USED	37
4.3.2 TEST SETUP	37
4.3.3 TEST INSTRUMENTS	37
4.3.4 TEST PROCEDURES.....	37
4.3.5 DEVIATION FROM TEST STANDARD	37
4.3.6 TEST RESULTS.....	37
4.4 DWELL TIME ON EACH CHANNEL	39
4.4.1 LIMIT OF DWELL TIME USED.....	39
4.4.2 TEST SETUP	39
4.4.3 TEST INSTRUMENTS	39
4.4.4 TEST PROCEDURES.....	39
4.4.5 DEVIATION FROM TEST STANDARD	39
4.4.6 TEST RESULTS.....	40
4.5 CHANNEL BANDWIDTH.....	41
4.5.1 LIMITS OF CHANNEL BANDWIDTH.....	41



4.5.2	TEST SETUP	41
4.5.3	TEST INSTRUMENTS	41
4.5.4	TEST PROCEDURE	41
4.5.5	DEVIATION FROM TEST STANDARD	41
4.5.6	EUT OPERATING CONDITION	41
4.5.7	TEST RESULTS	42
4.6	HOPPING CHANNEL SEPARATION	43
4.6.1	LIMIT OF HOPPING CHANNEL SEPARATION	43
4.6.2	TEST SETUP	43
4.6.3	TEST INSTRUMENTS	43
4.6.4	TEST PROCEDURES	43
4.6.5	DEVIATION FROM TEST STANDARD	43
4.6.6	TEST RESULTS	44
4.7	MAXIMUM OUTPUT POWER	45
4.7.1	LIMITS OF MAXIMUM OUTPUT POWER MEASUREMENT	45
4.7.2	TEST SETUP	45
4.7.3	TEST INSTRUMENTS	45
4.7.4	TEST PROCEDURES	45
4.7.5	DEVIATION FROM TEST STANDARD	45
4.7.6	EUT OPERATING CONDITION	45
4.7.7	TEST RESULTS	46
4.8	CONDUCTED OUT OF BAND EMISSION MEASUREMENT	47
4.8.1	LIMITS OF CONDUCTED OUT OF BAND EMISSION MEASUREMENT	47
4.8.2	TEST INSTRUMENTS	47
4.8.3	TEST PROCEDURE	47
4.8.4	DEVIATION FROM TEST STANDARD	47
4.8.5	EUT OPERATING CONDITION	47
4.8.6	TEST RESULTS	47
5.	PHOTOGRAPHS OF THE TEST CONFIGURATION	49
6.	INFORMATION ON THE TESTING LABORATORIES	50
7.	APPENDIX A - MODIFICATIONS RECORDERS FOR ENGINEERING CHANGES TO THE EUT BY THE LAB	51



A D T

RELEASE CONTROL RECORD

ISSUE NO.	REASON FOR CHANGE	DATE ISSUED
RF140430D04	Original release	May 22, 2014



1. CERTIFICATION

PRODUCT: Bluetooth Keyboard
BRAND NAME: TOSHIBA
MODEL NO.: KT-1408
APPLICANT: Chicony Electronics Co., Ltd.
TESTED: May 8 ~ 21, 2014
TEST SAMPLE: ENGINEERING SAMPLE
STANDARDS: **FCC Part 15, Subpart C (Section 15.247)**
ANSI C63.10-2009

The above equipment has been tested by **Bureau Veritas Consumer Products Services (H.K.) Ltd., Taoyuan Branch**, and found compliance with the requirement of the above standards. The test record, data evaluation & Equipment Under Test (EUT) configurations represented herein are true and accurate accounts of the measurements of the sample's EMC characteristics under the conditions specified in this report.

PREPARED BY : Celia Chen , **DATE:** May 22, 2014
(Celia Chen / Senior Specialist)

APPROVED BY : Rex Lai , **DATE:** May 22, 2014
(Rex Lai / Assistant Manager)

2. SUMMARY OF TEST RESULTS

The EUT has been tested according to the following specifications:

APPLIED STANDARD: FCC Part 15, Subpart C			
STANDARD SECTION	TEST TYPE AND LIMIT	RESULT	REMARK
15.207	AC Power Conducted Emission	PASS	Meet the requirement of limit. Minimum passing margin is -10.59dB at 0.50741MHz.
15.247(a)(1) (iii)	Number of Hopping Frequency Used	PASS	Meet the requirement of limit.
15.247(a)(1) (iii)	Dwell Time on Each Channel	PASS	Meet the requirement of limit.
15.247(a)(1)	1. Hopping Channel Separation 2. Spectrum Bandwidth of a Frequency Hopping Sequence Spread Spectrum System	PASS	Meet the requirement of limit.
15.247(b)	Maximum Peak Output Power	PASS	Meet the requirement of limit.
15.205 & 15.209	Transmitter Radiated Emissions	PASS	Meet the requirement of limit. Minimum passing margin is -3.1dB at 9920.00MHz.
15.247(d)	Band Edge Measurement	PASS	Meet the requirement of limit. Minimum passing margin is -19.9dB at 2400.00MHz.
15.247(d)	Antenna Requirement	PASS	No antenna connector is used.

NOTE: If The Frequency Hopping System operating in 2400-2483.5MHz band and the output power less than 125mW. The hopping channel carrier frequencies separated by a minimum of 25kHz or two-thirds of the 20dB bandwidth of hopping channel whichever is greater.

2.1 MEASUREMENT UNCERTAINTY

Where relevant, the following measurement uncertainty levels have been estimated for tests performed on the EUT as specified in CISPR 16-4-2:

Measurement	Frequency	Uncertainty
Conducted emissions	150kHz ~ 30MHz	3.43 dB
Radiated emissions	30MHz ~ 1GHz	4.00 dB
	Above 1GHz	3.36 dB

This uncertainty represents an expanded uncertainty expressed at approximately the 95% confidence level using a coverage factor of k=2.

3. GENERAL INFORMATION

3.1 GENERAL DESCRIPTION OF EUT

EUT	Bluetooth Keyboard
MODEL NO.	KT-1408
POWER SUPPLY	3.7Vdc (from battery) or 5.0Vdc (from host equipment or USB adapter)
MODULATION TYPE	GFSK
MODULATION TECHNOLOGY	FHSS
TRANSFER RATE	723.2Kbps
OPERATING FREQUENCY	2402 ~ 2480MHz
NUMBER OF CHANNEL	79
MAX. OUTPUT POWER	0.7mW
ANTENNA TYPE	PCB antenna with -4.59dBi gain
ANTENNA CONNECTOR	NA
I/O PORTS	Micro USB port
DATA CABLE	NA
ACCESSORY DEVICES	NA

NOTE:

1. The EUT is a Bluetooth keyboard with Micro USB interface.
2. The USB function on this product is for battery charging only, no data transmitting and/or receiving function involved.
3. The above EUT information is declared by manufacturer and for more detailed features description, please refer to the manufacturer's specifications or User's Manual.



3.2 DESCRIPTION OF TEST MODES

79 channels are provided to this EUT:

CHANNEL	FREQ. (MHz)	CHANNEL	FREQ. (MHz)	CHANNEL	FREQ. (MHz)	CHANNEL	FREQ. (MHz)
0	2402	20	2422	40	2442	60	2462
1	2403	21	2423	41	2443	61	2463
2	2404	22	2424	42	2444	62	2464
3	2405	23	2425	43	2445	63	2465
4	2406	24	2426	44	2446	64	2466
5	2407	25	2427	45	2447	65	2467
6	2408	26	2428	46	2448	66	2468
7	2409	27	2429	47	2449	67	2469
8	2410	28	2430	48	2450	68	2470
9	2411	29	2431	49	2451	69	2471
10	2412	30	2432	50	2452	70	2472
11	2413	31	2433	51	2453	71	2473
12	2414	32	2434	52	2454	72	2474
13	2415	33	2435	53	2455	73	2475
14	2416	34	2436	54	2456	74	2476
15	2417	35	2437	55	2457	75	2477
16	2418	36	2438	56	2458	76	2478
17	2419	37	2439	57	2459	77	2479
18	2420	38	2440	58	2460	78	2480
19	2421	39	2441	59	2461		



3.2.1 TEST MODE APPLICABILITY AND TESTED CHANNEL DETAIL

EUT CONFIGURE MODE	APPLICABLE TO				DESCRIPTION
	RE ³ 1G	RE<1G	PLC	APCM	
A	√	√	√	√	Operating + Charging (EUT with Notebook)
B	√	√	Note 2	-	Operating (EUT only)
C	-	√	√	-	Operating + Charging (EUT with Adapter)

Where **PLC**: Power Line Conducted Emission **RE³1G**: Radiated Emission above 1GHz
RE<1G: Radiated Emission below 1GHz **APCM**: Antenna Port Conducted Measurement

NOTE: 1. "-" means no effect.

2. No need to concern of Conducted Emission due to the EUT is powered by battery.

RADIATED EMISSION TEST (ABOVE 1 GHz):

- Pre-Scan has been conducted to determine the worst-case mode from all possible combinations between available modulations, antenna ports (if EUT with antenna diversity architecture) and packet type.
- Following channel(s) was (were) selected for the final test as listed below.

EUT CONFIGURE MODE	AVAILABLE CHANNEL	TESTED CHANNEL	MODULATION TECHNOLOGY	MODULATION TYPE	PACKET TYPE
A & B	0 to 78	0, 39, 78	FHSS	GFSK	DH5

RADIATED EMISSION TEST (BELOW 1 GHz):

- Pre-Scan has been conducted to determine the worst-case mode from all possible combinations between available modulations, antenna ports (if EUT with antenna diversity architecture) and packet type.
- Following channel(s) was (were) selected for the final test as listed below.

EUT CONFIGURE MODE	AVAILABLE CHANNEL	TESTED CHANNEL	MODULATION TECHNOLOGY	MODULATION TYPE	PACKET TYPE
A ~ C	0 to 78	78	FHSS	GFSK	DH5



POWER LINE CONDUCTED EMISSION TEST:

- Pre-Scan has been conducted to determine the worst-case mode from all possible combinations between available modulations, antenna ports (if EUT with antenna diversity architecture) and packet types.
- Following channel(s) was (were) selected for the final test as listed below.

EUT CONFIGURE MODE	AVAILABLE CHANNEL	TESTED CHANNEL	MODULATION TECHNOLOGY	MODULATION TYPE	PACKET TYPE
A & C	0 to 78	78	FHSS	GFSK	DH5

BANDEDGE MEASUREMENT:

- Pre-Scan has been conducted to determine the worst-case mode from all possible combinations between available modulations, antenna ports (if EUT with antenna diversity architecture), and packet types.
- Following channel(s) was (were) selected for the final test as listed below.

EUT CONFIGURE MODE	AVAILABLE CHANNEL	TESTED CHANNEL	MODULATION TECHNOLOGY	MODULATION TYPE	PACKET TYPE
A	0 to 78	0, 78	FHSS	GFSK	DH5

ANTENNA PORT CONDUCTED MEASUREMENT:

- This item includes all test value of each mode, but only includes spectrum plot of worst value of each mode.
- Pre-Scan has been conducted to determine the worst-case mode from all possible combinations between available modulations, antenna ports (if EUT with antenna diversity architecture), and packet types.
- Following channel(s) was (were) selected for the final test as listed below.

EUT CONFIGURE MODE	AVAILABLE CHANNEL	TESTED CHANNEL	MODULATION TECHNOLOGY	MODULATION TYPE	PACKET TYPE
A	0 to 78	0, 39, 78	FHSS	GFSK	DH5



A D T

TEST CONDITION:

APPLICABLE TO	EUT CONFIGURE MODE	ENVIRONMENTAL CONDITIONS	INPUT POWER	TESTED BY
RE ³ 1G	A	23deg. C, 76% RH	120Vac, 60Hz (System)	Joey Liu
	B	23deg. C, 76% RH	3.7Vdc	Joey Liu
RE<1G	A	23deg. C, 76% RH	120Vac, 60Hz (System)	Joey Liu
	B	23deg. C, 76% RH	3.7Vdc	Joey Liu
	C	23deg. C, 76% RH	120Vac, 60Hz	Joey Liu
PLC	A	24deg. C, 73% RH	120Vac, 60Hz (System)	Joey Liu
	C	23deg. C, 71% RH	120Vac, 60Hz	Dalen Dai
APCM	A	25deg. C, 60% RH	120Vac, 60Hz (System)	Saxon Lee



3.3 DESCRIPTION OF SUPPORT UNITS

The EUT has been tested as an independent unit together with other necessary accessories or support units. The following support units or accessories were used to form a representative test configuration during the tests.

NO.	PRODUCT	BRAND	MODEL NO.	SERIAL NO.	FCC ID
1	Notebook	DELL	E5410	BW33YM1	FCC DoC Approved
2	Adapter	Chicony	W12-010N3A	N/A	FCC DoC Approved

NO.	SIGNAL CABLE DESCRIPTION OF THE ABOVE SUPPORT UNITS
1	1.0m shielded USB cable (provided by client)

- Note:**
1. The support unit 2 was provided by client.
 2. Rating of support unit 2 was listed as below:
AC I/P: 100-240V, 50/60Hz, 0.3A
DC O/P: 5V/2A

3.3.1 CONFIGURATION OF SYSTEM UNDER TEST

FOR MODE A:

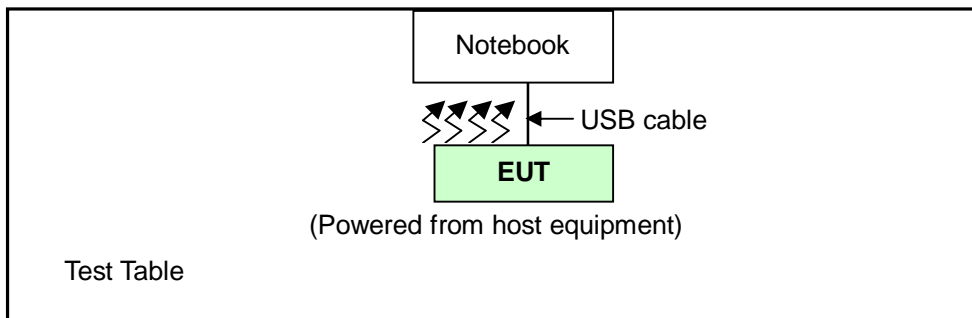

FOR MODE B:

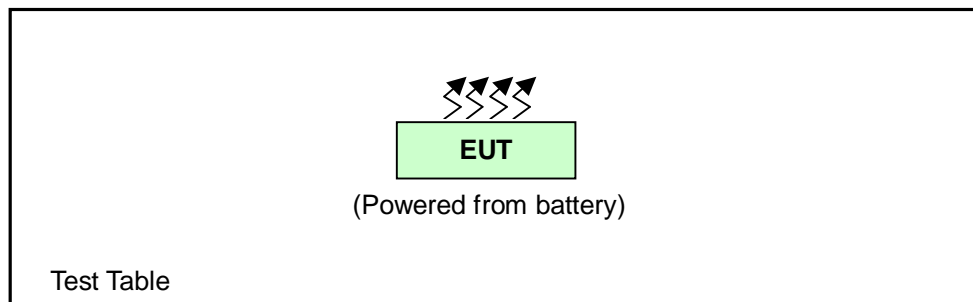

FOR MODE C:

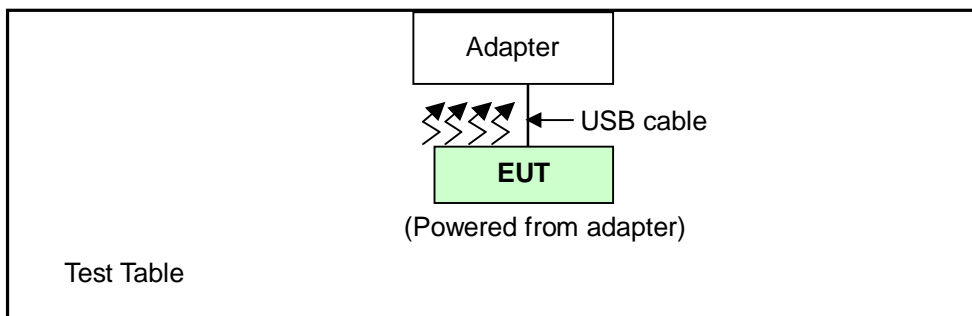



3.4 GENERAL DESCRIPTION OF APPLIED STANDARDS

The EUT is a RF Product. According to the specifications of the manufacturer, it must comply with the requirements of the following standards:

FCC Part 15, Subpart C. (15.247)

ANSI C63.10-2009

All test items have been performed and recorded as per the above standards.

4. TEST TYPES AND RESULTS

4.1 CONDUCTED EMISSION MEASUREMENT

4.1.1 LIMITS OF CONDUCTED EMISSION MEASUREMENT

FREQUENCY OF EMISSION (MHz)	CONDUCTED LIMIT (dB μ V)	
	Quasi-peak	Average
0.15 ~ 0.5	66 to 56	56 to 46
0.5 ~ 5	56	46
5 ~ 30	60	50

NOTE: 1. The lower limit shall apply at the transition frequencies.

2. The limit decreases in line with the logarithm of the frequency in the range of 0.15 to 0.50MHz.

4.1.2 TEST INSTRUMENTS

Description & Manufacturer	Model No.	Serial No.	Cal. Date	Cal. Due
ROHDE & SCHWARZ TEST RECEIVER	ESCS 30	100276	Apr. 18, 2014	Apr. 17, 2015
ROHDE & SCHWARZ Artificial Mains Network (for EUT)	ESH3-Z5	100219	Nov. 17, 2013	Nov. 16, 2014
LISN With Adapter (for EUT)	AD10	C10Ada-001	Nov. 17, 2013	Nov. 16, 2014
ROHDE & SCHWARZ Artificial Mains Network (for peripherals)	ESH3-Z5	100218	Nov. 25, 2013	Nov. 24, 2014
SCHWARZBECK Artificial Mains Network (For EUT)	NNLK8129	8129229	May 08, 2014	May 07, 2015
Software	ADT_Cond_V7.3.7	NA	NA	NA
RF cable (JYEBAO)	5D-FB	Cable-C10.01	Feb. 18, 2014	Feb. 17, 2015
SUHNER Terminator (For ROHDE & SCHWARZ LISN)	65BNC-5001	E1-011484	May 23, 2013	May 22, 2014
Isolation Transformer (Erika Fiedler)	D-65396	017	Jul. 29, 2013	Jul. 28, 2014

Notes: 1. The calibration interval of the above test instruments is 12 months and the calibrations are traceable to NML/ROC and NIST/USA.

2. The test was performed in Shielded Room No. 10.

3. The VCCI Site Registration No. C-1852.

4.1.3 TEST PROCEDURES

- a. The EUT was placed 0.4 meters from the conducting wall of the shielded room with EUT being connected to the power mains through a line impedance stabilization network (LISN). Other support units were connected to the power mains through another LISN. The two LISNs provide 50 ohm/ 50uH of coupling impedance for the measuring instrument.
- b. Both lines of the power mains connected to the EUT were checked for maximum conducted interference.
- c. The frequency range from 150kHz to 30MHz was searched. Emission levels under (Limit - 20dB) was not recorded.

NOTE: All modes of operation were investigated and the worst-case emissions are reported.

4.1.4 DEVIATION FROM TEST STANDARD

No deviation.

4.1.5 TEST SETUP

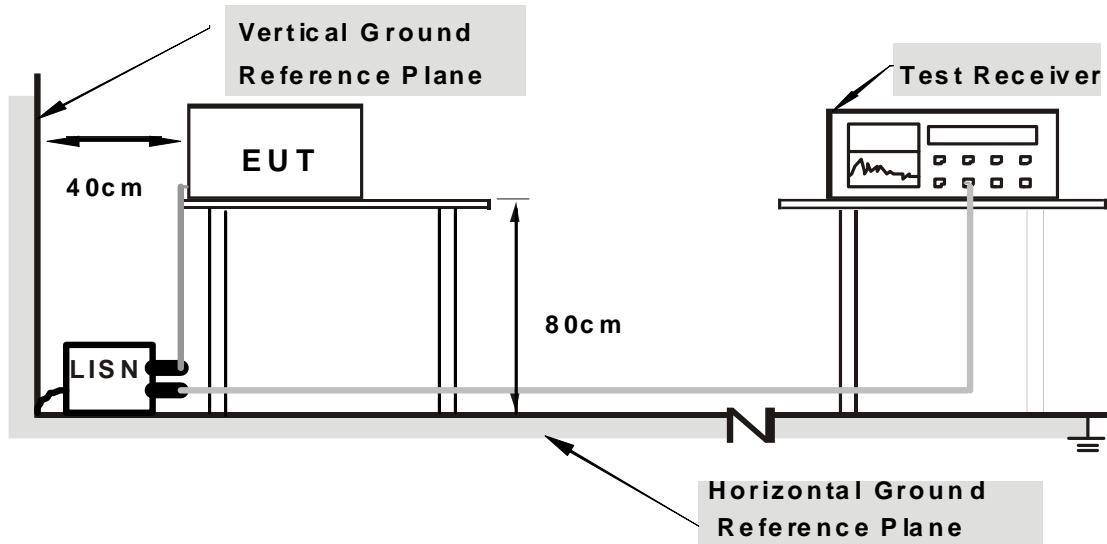

Note: Support units were connected to second LISN.

For the actual test configuration, please refer to the attached file (Test Setup Photo).

4.1.6 EUT OPERATING CONDITIONS

For Mode A

- Turn on the power of all equipment.
- Notebook ran a test program (provided by manufacture) to enable EUT under transmitting condition at specific channel continuously.
- Set the EUT under transmitting and charging condition.

For Mode C

- Connected EUT with adapter via USB cable.
- Turn on the power of all equipment.
- Set the EUT under transmitting and charging condition.



A D T

4.1.7 TEST RESULTS

CONDUCTED WORST-CASE DATA

PHASE	Line 1	6dB BANDWIDTH	9kHz
CHANNEL	78	TEST MODE	A

No	Freq. [MHz]	Corr. Factor (dB)	Reading Value [dB (uV)]		Emission Level [dB (uV)]		Limit [dB (uV)]		Margin (dB)	
			Q.P.	AV.	Q.P.	AV.	Q.P.	AV.	Q.P.	AV.
			1	0.25594	0.16	39.68	31.78	39.84	31.94	61.56
2	0.50741	0.17	45.24	35.05	45.41	35.22	56.00	46.00	-10.59	-10.78
3	0.62034	0.17	43.32	31.15	43.49	31.32	56.00	46.00	-12.51	-14.68
4	0.88631	0.17	40.50	27.83	40.67	28.00	56.00	46.00	-15.33	-18.00
5	1.66016	0.19	34.42	23.67	34.61	23.86	56.00	46.00	-21.39	-22.14
6	15.78125	0.91	34.89	26.56	35.80	27.47	60.00	50.00	-24.20	-22.53

REMARKS:

1. Q.P. and AV. are abbreviations of quasi-peak and average individually.
2. The emission levels of other frequencies were very low against the limit.
3. Margin value = Emission Level – Limit value
4. Correction Factor = Insertion loss + Cable loss
5. Emission Level = Correction Factor + Reading Value

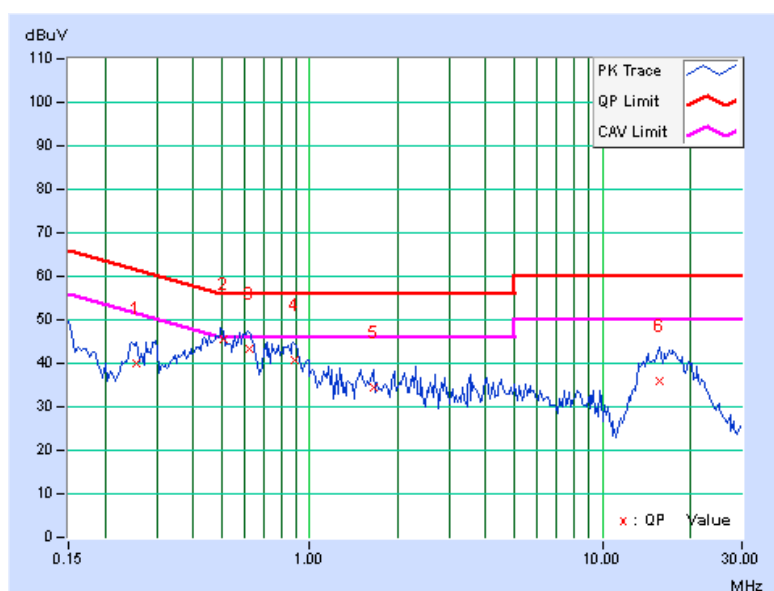



A D T

PHASE	Line 2	6dB BANDWIDTH	9kHz
CHANNEL	78	TEST MODE	A

No	Freq. [MHz]	Corr. Factor (dB)	Reading Value [dB (uV)]		Emission Level [dB (uV)]		Limit [dB (uV)]		Margin (dB)	
			Q.P.	AV.	Q.P.	AV.	Q.P.	AV.	Q.P.	AV.
1	0.29453	0.54	39.95	23.93	40.49	24.47	60.40	50.40	-19.91	-25.93
2	0.50938	0.54	43.88	33.77	44.42	34.31	56.00	46.00	-11.58	-11.69
3	0.63250	0.54	41.09	32.83	41.63	33.37	56.00	46.00	-14.37	-12.63
4	0.88828	0.55	39.45	26.76	40.00	27.31	56.00	46.00	-16.00	-18.69
5	2.13672	0.57	30.50	21.04	31.07	21.61	56.00	46.00	-24.93	-24.39
6	15.07813	0.97	34.76	27.13	35.73	28.10	60.00	50.00	-24.27	-21.90

REMARKS:

1. Q.P. and AV. are abbreviations of quasi-peak and average individually.
2. The emission levels of other frequencies were very low against the limit.
3. Margin value = Emission Level – Limit value
4. Correction Factor = Insertion loss + Cable loss
5. Emission Level = Correction Factor + Reading Value

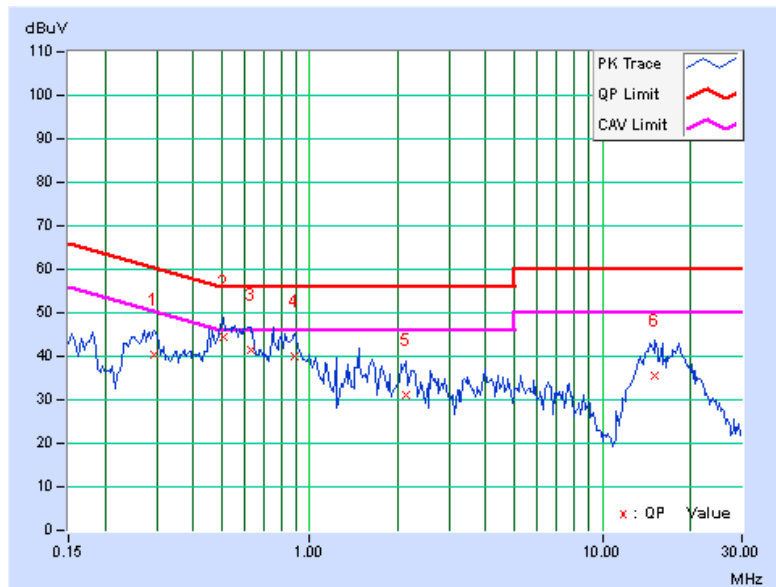



PHASE	Line 1	6dB BANDWIDTH	9kHz
CHANNEL	78	TEST MODE	C

No	Freq. [MHz]	Corr. Factor (dB)	Reading Value [dB (uV)]		Emission Level [dB (uV)]		Limit [dB (uV)]		Margin (dB)	
			Q.P.	AV.	Q.P.	AV.	Q.P.	AV.	Q.P.	AV.
			1	0.15000	0.15	29.82	25.14	29.97	25.29	66.00
2	0.18516	0.16	41.22	40.66	41.38	40.82	64.25	54.25	-22.87	-13.43
3	0.40000	0.17	27.18	18.81	27.35	18.98	57.85	47.85	-30.50	-28.87
4	0.48984	0.17	35.82	26.55	35.99	26.72	56.17	46.17	-20.18	-19.45
5	0.81016	0.17	21.97	12.11	22.14	12.28	56.00	46.00	-33.86	-33.72
6	1.48438	0.18	18.97	9.04	19.15	9.22	56.00	46.00	-36.85	-36.78

REMARKS:

1. Q.P. and AV. are abbreviations of quasi-peak and average individually.
2. The emission levels of other frequencies were very low against the limit.
3. Margin value = Emission Level – Limit value
4. Correction Factor = Insertion loss + Cable loss
5. Emission Level = Correction Factor + Reading Value

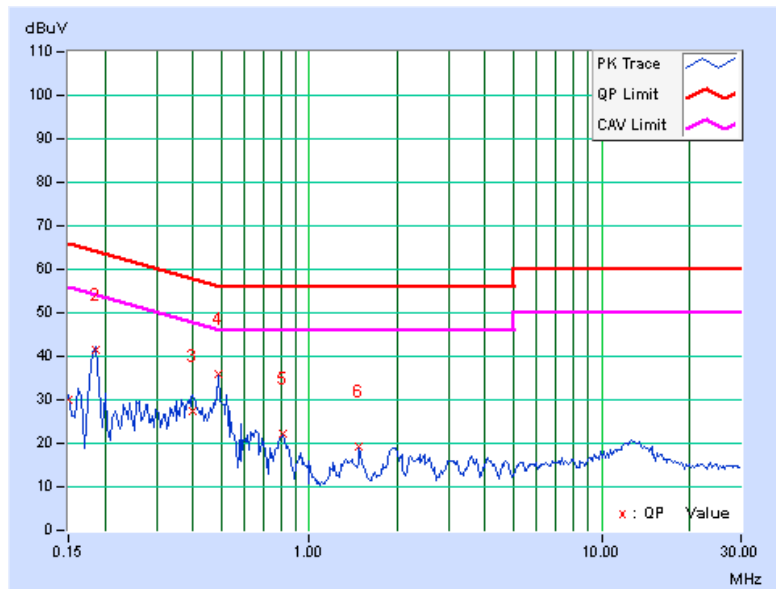



A D T

PHASE	Line 1	6dB BANDWIDTH	9kHz
CHANNEL	78	TEST MODE	C

No	Freq. [MHz]	Corr. Factor (dB)	Reading Value [dB (uV)]		Emission Level [dB (uV)]		Limit [dB (uV)]		Margin (dB)	
			Q.P.	AV.	Q.P.	AV.	Q.P.	AV.	Q.P.	AV.
			1	0.15000	0.55	30.67	26.89	31.22	27.44	66.00
2	0.18516	0.54	42.80	42.75	43.34	43.29	64.25	54.25	-20.91	-10.96
3	0.30625	0.53	25.55	18.13	26.08	18.66	60.07	50.07	-33.99	-31.41
4	0.50156	0.54	29.58	18.43	30.12	18.97	56.00	46.00	-25.88	-27.03
5	0.62266	0.54	23.81	12.24	24.35	12.78	56.00	46.00	-31.65	-33.22
6	2.31250	0.56	13.45	6.82	14.01	7.38	56.00	46.00	-41.99	-38.62

REMARKS:

1. Q.P. and AV. are abbreviations of quasi-peak and average individually.
2. The emission levels of other frequencies were very low against the limit.
3. Margin value = Emission Level – Limit value
4. Correction Factor = Insertion loss + Cable loss
5. Emission Level = Correction Factor + Reading Value

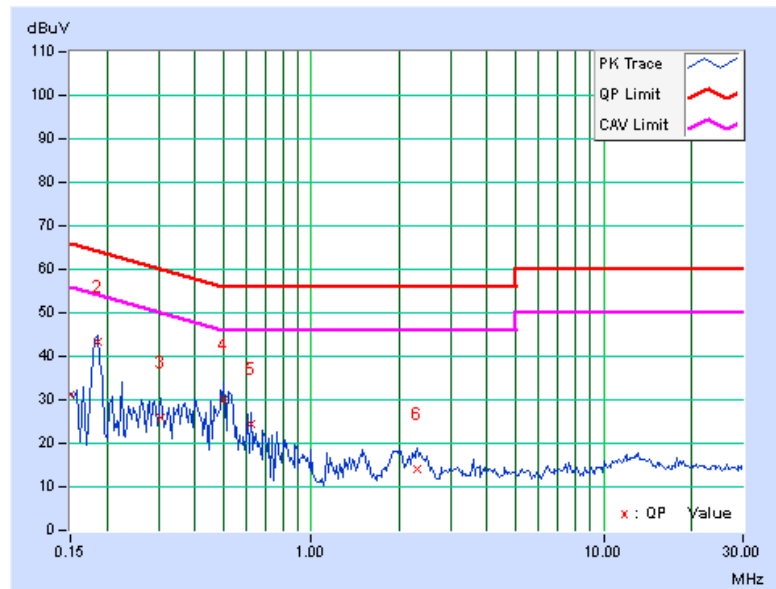

4.2 RADIATED EMISSION AND BANDEDGE MEASUREMENT

4.2.1 LIMITS OF RADIATED EMISSION AND BANDEDGE MEASUREMENT

Radiated emissions which fall in the restricted bands must comply with the radiated emission limits specified as below table. Other emissions shall be at least 20dB below the highest level of the desired power:

FREQUENCIES (MHz)	FIELD STRENGTH (microvolts/meter)	MEASUREMENT DISTANCE (meters)
0.009 ~ 0.490	2400/F(kHz)	300
0.490 ~ 1.705	24000/F(kHz)	30
1.705 ~ 30.0	30	30
30 ~ 88	100	3
88 ~ 216	150	3
216 ~ 960	200	3
Above 960	500	3

NOTE:

1. The lower limit shall apply at the transition frequencies.
2. Emission level (dBuV/m) = 20 log Emission level (uV/m).
3. For frequencies above 1000MHz, the field strength limits are based on average detector, however, the peak field strength of any emission shall not exceed the maximum permitted average limits, specified above by more than 20dB under any condition of modulation.



A D T

4.2.2 TEST INSTRUMENTS

For Mode A & B

DESCRIPTION & MANUFACTURER	MODEL NO.	SERIAL NO.	CALIBRATED DATE	CALIBRATED UNTIL
HP Preamplifier	8447D	2432A03504	Feb. 26, 2014	Feb. 25, 2015
HP Preamplifier	8449B	3008A01201	Feb. 26, 2014	Feb. 25, 2015
Agilent TEST RECEIVER	N9038A	MY51210129	Jan. 18, 2014	Jan. 17, 2015
Schwarzbeck Antenna	VULB 9168	139	Feb. 24, 2014	Feb. 23, 2015
Schwarzbeck Antenna	VHBA 9123	480	May 29, 2013	May 28, 2015
ADT. Turn Table	TT100	0306	NA	NA
ADT. Tower	AT100	0306	NA	NA
Software	ADT_Radiated_V 7.6.15.9.4	NA	NA	NA
SUHNER RF cable	SF102	CABLE-CH6	Aug. 16, 2013	Aug. 15, 2014
Schwarzbeck Horn Antenna	BBHA 9120-D1	D130	May 13, 2013	May 12, 2014
Highpass filter Wainwright Instruments	WHK 3.1/18G-10SS	SN 8	NA	NA
ROHDE & SCHWARZ Spectrum Analyzer	FSP 40	100036	May 17, 2013	May 16, 2014
Anritsu Power Sensor	MA2411B	0738404	Apr. 21, 2014	Apr. 20, 2015
Anritsu Power Meter	ML2495A	0842014	Apr. 21, 2014	Apr. 20, 2015

- NOTE:** 1. The calibration interval of the above test instruments is 12/24 months. And the calibrations are traceable to NML/ROC and NIST/USA.
2. The horn antenna and HP preamplifier (model: 8449B) are used only for the measurement of emission frequency above 1GHz if tested.
3. The test was performed in Chamber No. 6.
4. The Industry Canada Reference No. IC 7450E-6.
5. The FCC Site Registration No. is 447212.
6. Tested Date: May 9, 2014.



For Mode C

DESCRIPTION & MANUFACTURER	MODEL NO.	SERIAL NO.	CALIBRATED DATE	CALIBRATED UNTIL
HP Preamplifier	8447D	2432A03504	Feb. 26, 2014	Feb. 25, 2015
HP Preamplifier	8449B	3008A01201	Feb. 26, 2014	Feb. 25, 2015
Agilent TEST RECEIVER	N9038A	MY51210129	Jan. 18, 2014	Jan. 17, 2015
Schwarzbeck Antenna	VULB 9168	139	Feb. 24, 2014	Feb. 23, 2015
Schwarzbeck Antenna	VHBA 9123	480	May 29, 2013	May 28, 2015
ADT. Turn Table	TT100	0306	NA	NA
ADT. Tower	AT100	0306	NA	NA
Software	ADT_Radiated_V 7.6.15.9.4	NA	NA	NA
SUHNER RF cable	SF102	CABLE-CH6	Aug. 16, 2013	Aug. 15, 2014
EMCO Horn Antenna	3115	00028257	Sep. 27, 2013	Sep. 26, 2014
Highpass filter Wainwright Instruments	WHK 3.1/18G-10SS	SN 8	NA	NA
ROHDE & SCHWARZ Spectrum Analyzer	FSP 40	100036	May 17, 2014	May 16, 2015
Anritsu Power Sensor	MA2411B	0738404	Apr. 21, 2014	Apr. 20, 2015
Anritsu Power Meter	ML2495A	0842014	Apr. 21, 2014	Apr. 20, 2015

- NOTE:** 1. The calibration interval of the above test instruments is 12/24 months. And the calibrations are traceable to NML/ROC and NIST/USA.
 2. The horn antenna and HP preamplifier (model: 8449B) are used only for the measurement of emission frequency above 1GHz if tested.
 3. The test was performed in Chamber No. 6.
 4. The Industry Canada Reference No. IC 7450E-6.
 5. The FCC Site Registration No. is 447212.
 6. Tested Date: May 21, 2014.

4.2.3 TEST PROCEDURES

- a. The EUT was placed on the top of a rotating table 0.8 meters above the ground at a 3 meter semi-anechoic chamber. The table was rotated 360 degrees to determine the position of the highest radiation.
- b. The EUT was set 3 meters away from the interference-receiving antenna, which was mounted on the top of a variable-height antenna tower.
- c. The antenna is a broadband antenna, and its height is varied from one meter to four meters above the ground to determine the maximum value of the field strength. Both horizontal and vertical polarizations of the antenna are set to make the measurement.
- d. For each suspected emission, the EUT was arranged to its worst case and then the antenna was tuned to heights from 1 meter to 4 meters and the rotatable table was turned from 0 degrees to 360 degrees to find the maximum reading.
- e. The test-receiver system was set to Peak Detect Function and Specified Bandwidth with Maximum Hold Mode.
- f. If the emission level of the EUT in peak mode was lower than the limit specified, then testing could be stopped and the peak values of the EUT would be reported. Otherwise the emissions would be re-tested one by one using peak, quasi-peak or average method as specified and then reported in a data sheet.

NOTE:

1. The resolution bandwidth and video bandwidth of test receiver/spectrum analyzer is 120kHz for Quasi-peak detection at frequency below 1GHz.
2. The resolution bandwidth of test receiver/spectrum analyzer is 1 MHz and video bandwidth is 3MHz for Peak detection at frequency above 1GHz.
3. All modes of operation were investigated and the worst-case emissions are reported.

4.2.4 DEVIATION FROM TEST STANDARD

No deviation.

4.2.5 TEST SETUP

<Frequency Range 30MHz ~ 1GHz >

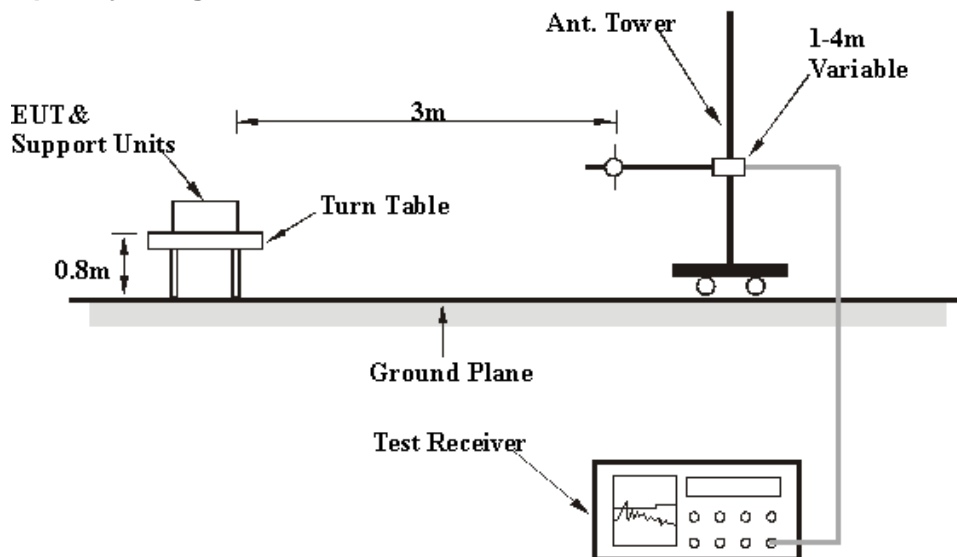

<Frequency Range above 1GHz>

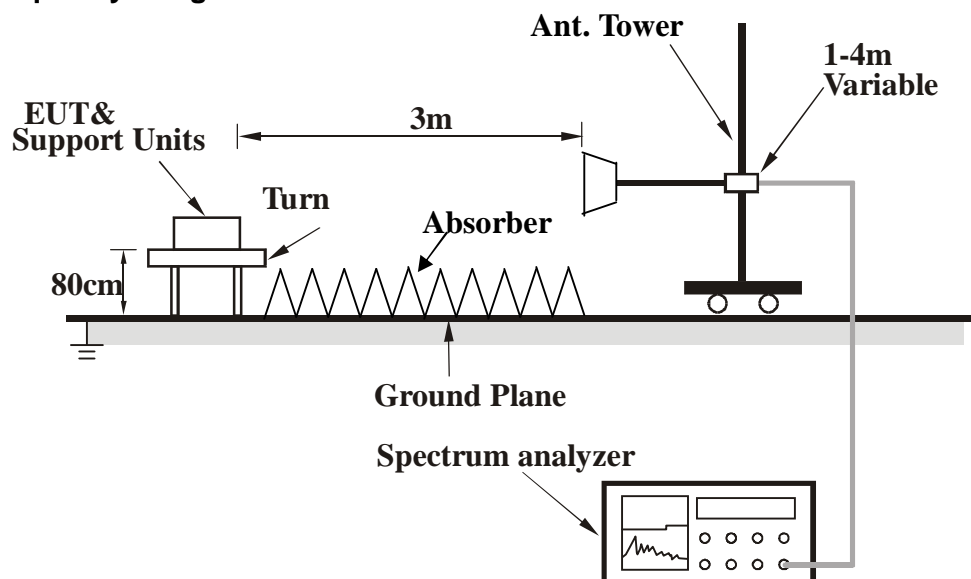

For the actual test configuration, please refer to the attached file (Test Setup Photo).

4.2.6 EUT OPERATING CONDITIONS

For Mode A:

- a. Turn on the power of all equipment.
- b. Notebook ran a test program (provided by manufacture) to enable EUT under transmitting condition at specific channel continuously.
- c. Set the EUT under transmitting and charging condition.

For Mode B:

Set the EUT under transmission/receiving condition continuously at specific channel frequency.

For Mode C

- a. Connected EUT with adapter via USB cable.
- b. Turn on the power of all equipment.
- c. Set the EUT under transmitting and charging condition.



A D T

4.2.7 TEST RESULTS

ABOVE 1GHz DATA

CHANNEL	TX Channel 0	DETECTOR	Peak (PK)
FREQUENCY RANGE	1GHz ~ 25GHz	FUNCTION	Average (AV)
TEST MODE	A		

ANTENNA POLARITY & TEST DISTANCE: HORIZONTAL AT 3 M								
NO.	FREQ. (MHz)	EMISSION LEVEL (dBuV/m)	LIMIT (dBuV/m)	MARGIN (dB)	ANTENNA HEIGHT (m)	TABLE ANGLE (Degree)	RAW VALUE (dBuV)	CORRECTION FACTOR (dB/m)
1	2390.00	42.2 PK	74.0	-31.8	1.00 H	58	46.85	-4.67
2	2390.00	27.4 AV	54.0	-26.6	1.00 H	58	32.08	-4.67
3	2400.00	45.2 PK	74.0	-28.8	1.00 H	58	49.81	-4.62
4	2400.00	30.6 AV	54.0	-23.4	1.00 H	58	35.26	-4.62
5	*2402.00	74.8 PK			1.00 H	58	79.41	-4.61
6	*2402.00	74.4 AV			1.00 H	58	78.96	-4.61
7	4804.00	44.5 PK	74.0	-29.5	1.58 H	239	42.41	2.11
8	4804.00	32.2 AV	54.0	-21.9	1.58 H	239	30.04	2.11
9	7206.00	50.2 PK	74.0	-23.8	1.58 H	4	41.52	8.67
10	7206.00	39.3 AV	54.0	-14.7	1.58 H	4	30.58	8.67
11	9608.00	55.8 PK	74.0	18.2	1.58 H	345	43.26	12.50
12	9608.00	44.2 AV	54.0	-9.8	1.58 H	345	31.73	12.50
13	12010.00	60.8 PK	74.0	-13.2	1.58 H	329	43.86	16.91
14	12010.00	47.6 AV	54.0	-6.5	1.58 H	329	30.64	16.91

ANTENNA POLARITY & TEST DISTANCE: VERTICAL AT 3 M								
NO.	FREQ. (MHz)	EMISSION LEVEL (dBuV/m)	LIMIT (dBuV/m)	MARGIN (dB)	ANTENNA HEIGHT (m)	TABLE ANGLE (Degree)	RAW VALUE (dBuV)	CORRECTION FACTOR (dB/m)
1	2390.00	40.9 PK	74.0	-33.1	1.02 V	94	45.59	-4.67
2	2390.00	27.6 AV	54.0	-26.4	1.02 V	94	32.24	-4.67
3	2400.00	48.7 PK	74.0	-25.3	1.02 V	97	53.28	-4.62
4	2400.00	34.1 AV	54.0	-19.9	1.02 V	97	38.67	-4.62
5	*2402.00	80.2 PK			1.02 V	97	84.83	-4.61
6	*2402.00	79.8 AV			1.02 V	97	84.36	-4.61
7	4804.00	49.5 PK	74.0	-24.5	1.01 V	6	47.41	2.11
8	4804.00	40.6 AV	54.0	-13.4	1.01 V	6	38.46	2.11
9	7206.00	53.2 PK	74.0	-20.8	1.01 V	45	44.50	8.67
10	7206.00	39.9 AV	54.0	-14.1	1.01 V	45	31.22	8.67
11	9608.00	58.5 PK	74.0	-15.5	1.02 V	268	46.03	12.50
12	9608.00	44.7 AV	54.0	-9.3	1.02 V	268	32.17	12.50
13	12010.00	62.2 PK	74.0	-11.8	1.01 V	104	45.27	16.91
14	12010.00	49.5 AV	54.0	-4.5	1.01 V	104	32.62	16.91

REMARKS:

1. Emission Level(dBuV/m) = Raw Value(dBuV) + Correction Factor(dB/m)
2. Correction Factor(dB/m) = Antenna Factor(dB/m) + Cable Factor(dB) – Pre-Amplifier Factor(dB)
3. The other emission levels were very low against the limit.
4. Margin value = Emission Level – Limit value
5. " * ": Fundamental frequency.



A D T

CHANNEL	TX Channel 39	DETECTOR FUNCTION	Peak (PK)
FREQUENCY RANGE	1GHz ~ 25GHz		Average (AV)
TEST MODE	A		

ANTENNA POLARITY & TEST DISTANCE: HORIZONTAL AT 3 M								
NO.	FREQ. (MHz)	EMISSION LEVEL (dBuV/m)	LIMIT (dBuV/m)	MARGIN (dB)	ANTENNA HEIGHT (m)	TABLE ANGLE (Degree)	RAW VALUE (dBuV)	CORRECTION FACTOR (dB/m)
1	*2441.00	75.7 PK			1.03 H	107	80.11	-4.46
2	*2441.00	75.3 AV			1.03 H	107	79.72	-4.46
3	4882.00	44.7 PK	74.0	-29.3	1.58 H	236	42.34	2.34
4	4882.00	32.5 AV	54.0	-21.5	1.58 H	236	30.16	2.34
5	7323.00	50.7 PK	74.0	-23.3	1.50 H	72	41.54	9.17
6	7323.00	39.4 AV	54.0	-14.6	1.50 H	72	30.23	9.17
7	9764.00	57.3 PK	74.0	-16.7	1.58 H	234	44.57	12.74
8	9764.00	44.9 AV	54.0	-9.1	1.58 H	234	32.18	12.74
9	12205.00	58.6 PK	74.0	-15.4	1.56 H	255	42.12	16.47
10	12205.00	45.8 AV	54.0	-8.2	1.56 H	255	29.35	16.47

ANTENNA POLARITY & TEST DISTANCE: VERTICAL AT 3 M								
NO.	FREQ. (MHz)	EMISSION LEVEL (dBuV/m)	LIMIT (dBuV/m)	MARGIN (dB)	ANTENNA HEIGHT (m)	TABLE ANGLE (Degree)	RAW VALUE (dBuV)	CORRECTION FACTOR (dB/m)
1	*2441.00	81.6 PK			1.02 V	97	86.06	-4.46
2	*2441.00	81.2 AV			1.02 V	97	85.64	-4.46
3	4882.00	47.7 PK	74.0	-26.3	1.01 V	14	45.34	2.34
4	4882.00	39.0 AV	54.0	-15.0	1.01 V	14	36.65	2.34
5	7323.00	52.9 PK	74.0	-21.1	1.01 V	121	43.71	9.17
6	7323.00	39.3 AV	54.0	-14.7	1.01 V	121	30.11	9.17
7	9764.00	57.5 PK	74.0	-16.5	1.02 V	266	44.71	12.74
8	9764.00	44.8 AV	54.0	-9.2	1.02 V	266	32.07	12.74
9	12205.00	60.1 PK	74.0	-13.9	1.00 V	102	43.59	16.47
10	12205.00	47.5 AV	54.0	-6.6	1.00 V	102	30.98	16.47

REMARKS:

1. Emission Level(dBuV/m) = Raw Value(dBuV) + Correction Factor(dB/m)
2. Correction Factor(dB/m) = Antenna Factor(dB/m) + Cable Factor(dB) – Pre-Amplifier Factor(dB)
3. The other emission levels were very low against the limit.
4. Margin value = Emission Level – Limit value
5. " * ": Fundamental frequency.



A D T

CHANNEL	TX Channel 78	DETECTOR FUNCTION	Peak (PK)
FREQUENCY RANGE	1GHz ~ 25GHz		Average (AV)
TEST MODE	A		

ANTENNA POLARITY & TEST DISTANCE: HORIZONTAL AT 3 M

NO.	FREQ. (MHz)	EMISSION LEVEL (dBuV/m)	LIMIT (dBuV/m)	MARGIN (dB)	ANTENNA HEIGHT (m)	TABLE ANGLE (Degree)	RAW VALUE (dBuV)	CORRECTION FACTOR (dB/m)
1	*2480.00	76.6 PK			1.14 H	107	80.92	-4.32
2	*2480.00	76.0 AV			1.14 H	107	80.33	-4.32
3	2483.50	40.9 PK	74.0	-33.1	1.14 H	107	45.18	-4.31
4	2483.50	27.1 AV	54.0	-26.9	1.14 H	107	31.37	-4.31
5	4960.00	45.0 PK	74.0	-29.0	1.44 H	229	42.57	2.42
6	4960.00	33.0 AV	54.0	-21.0	1.44 H	229	30.60	2.42
7	7440.00	51.3 PK	74.0	-22.7	1.42 H	221	42.15	9.11
8	7440.00	37.5 AV	54.0	-16.5	1.42 H	221	28.41	9.11
9	9920.00	60.2 PK	74.0	-13.8	1.57 H	319	47.34	12.82
10	9920.00	49.8 AV	54.0	-4.2	1.57 H	319	36.94	12.82
11	12400.00	57.0 PK	74.0	-17.0	1.23 H	286	41.52	15.44
12	12400.00	44.0 AV	54.0	-10.0	1.23 H	286	28.59	15.44

ANTENNA POLARITY & TEST DISTANCE: VERTICAL AT 3 M

NO.	FREQ. (MHz)	EMISSION LEVEL (dBuV/m)	LIMIT (dBuV/m)	MARGIN (dB)	ANTENNA HEIGHT (m)	TABLE ANGLE (Degree)	RAW VALUE (dBuV)	CORRECTION FACTOR (dB/m)
1	*2480.00	81.4 PK			1.00 V	24	85.69	-4.32
2	*2480.00	81.0 AV			1.00 V	24	85.32	-4.32
3	2483.50	41.4 PK	74.0	-32.7	1.00 V	24	45.66	-4.31
4	2483.50	27.2 AV	54.0	-26.8	1.00 V	24	31.47	-4.31
5	4960.00	47.2 PK	74.0	-26.8	1.00 V	13	44.76	2.42
6	4960.00	38.1 AV	54.0	-15.9	1.00 V	13	35.71	2.42
7	7440.00	51.0 PK	74.0	-23.0	1.00 V	245	41.86	9.11
8	7440.00	38.1 AV	54.0	-15.9	1.00 V	245	28.95	9.11
9	9920.00	60.3 PK	74.0	-13.7	1.00 V	163	47.52	12.82
10	9920.00	50.8 AV	54.0	-3.2	1.00 V	163	37.98	12.82
11	12400.00	56.8 PK	74.0	-17.3	1.00 V	162	41.31	15.44
12	12400.00	44.4 AV	54.0	-9.7	1.00 V	162	28.91	15.44

REMARKS:

1. Emission Level(dBuV/m) = Raw Value(dBuV) + Correction Factor(dB/m)
2. Correction Factor(dB/m) = Antenna Factor(dB/m) + Cable Factor(dB) – Pre-Amplifier Factor(dB)
3. The other emission levels were very low against the limit.
4. Margin value = Emission Level – Limit value
5. " * ": Fundamental frequency.



A D T

CHANNEL	TX Channel 0	DETECTOR	Peak (PK)
FREQUENCY RANGE	1GHz ~ 25GHz	FUNCTION	Average (AV)
TEST MODE	B		

ANTENNA POLARITY & TEST DISTANCE: HORIZONTAL AT 3 M

NO.	FREQ. (MHz)	EMISSION LEVEL (dBuV/m)	LIMIT (dBuV/m)	MARGIN (dB)	ANTENNA HEIGHT (m)	TABLE ANGLE (Degree)	RAW VALUE (dBuV)	CORRECTION FACTOR (dB/m)
1	2390.00	42.1 PK	74.0	-31.9	1.00 H	60	46.78	-4.67
2	2390.00	27.5 AV	54.0	-26.5	1.00 H	60	32.13	-4.67
3	2400.00	45.2 PK	74.0	-28.8	1.00 H	60	49.85	-4.62
4	2400.00	30.7 AV	54.0	-23.3	1.00 H	60	35.34	-4.62
5	*2402.00	74.8 PK			1.00 H	60	79.42	-4.61
6	*2402.00	74.4 AV			1.00 H	60	78.96	-4.61
7	4804.00	44.7 PK	74.0	-29.3	1.52 H	242	42.63	2.11
8	4804.00	32.3 AV	54.0	-21.7	1.52 H	242	30.21	2.11
9	7206.00	50.3 PK	74.0	-23.7	1.56 H	5	41.66	8.67
10	7206.00	39.4 AV	54.0	-14.6	1.56 H	5	30.73	8.67
11	9608.00	56.0 PK	74.0	-18.0	1.57 H	349	43.53	12.50
12	9608.00	44.1 AV	54.0	-9.9	1.57 H	349	31.64	12.50
13	12010.00	60.5 PK	74.0	-13.5	1.58 H	330	43.61	16.91
14	12010.00	47.7 AV	54.0	-6.3	1.58 H	330	30.83	16.91

ANTENNA POLARITY & TEST DISTANCE: VERTICAL AT 3 M

NO.	FREQ. (MHz)	EMISSION LEVEL (dBuV/m)	LIMIT (dBuV/m)	MARGIN (dB)	ANTENNA HEIGHT (m)	TABLE ANGLE (Degree)	RAW VALUE (dBuV)	CORRECTION FACTOR (dB/m)
1	2390.00	41.0 PK	74.0	-33.0	1.02 V	95	45.67	-4.67
2	2390.00	27.7 AV	54.0	-26.3	1.02 V	95	32.33	-4.67
3	2400.00	48.8 PK	74.0	-25.2	1.02 V	95	53.37	-4.62
4	2400.00	34.1 AV	54.0	-19.9	1.02 V	95	38.76	-4.62
5	*2402.00	80.3 PK			1.02 V	95	84.86	-4.61
6	*2402.00	79.8 AV			1.02 V	95	84.38	-4.61
7	4804.00	49.6 PK	74.0	-24.4	1.02 V	8	47.52	2.11
8	4804.00	40.6 AV	54.0	-13.4	1.02 V	8	38.53	2.11
9	7206.00	53.3 PK	74.0	-20.7	1.02 V	50	44.61	8.67
10	7206.00	40.0 AV	54.0	-14.0	1.02 V	50	31.36	8.67
11	9608.00	58.5 PK	74.0	-15.5	1.02 V	273	46.01	12.50
12	9608.00	44.8 AV	54.0	-9.2	1.02 V	273	32.28	12.50
13	12010.00	62.4 PK	74.0	-11.6	1.02 V	110	45.45	16.91
14	12010.00	49.1 AV	54.0	-4.9	1.02 V	110	32.16	16.91

REMARKS:

1. Emission Level(dBuV/m) = Raw Value(dBuV) + Correction Factor(dB/m)
2. Correction Factor(dB/m) = Antenna Factor(dB/m) + Cable Factor(dB) – Pre-Amplifier Factor(dB)
3. The other emission levels were very low against the limit.
4. Margin value = Emission Level – Limit value
5. " * ": Fundamental frequency.



A D T

CHANNEL	TX Channel 39	DETECTOR FUNCTION	Peak (PK)
FREQUENCY RANGE	1GHz ~ 25GHz		Average (AV)
TEST MODE	B		

ANTENNA POLARITY & TEST DISTANCE: HORIZONTAL AT 3 M								
NO.	FREQ. (MHz)	EMISSION LEVEL (dBuV/m)	LIMIT (dBuV/m)	MARGIN (dB)	ANTENNA HEIGHT (m)	TABLE ANGLE (Degree)	RAW VALUE (dBuV)	CORRECTION FACTOR (dB/m)
1	*2441.00	75.8 PK			1.05 H	110	80.21	-4.46
2	*2441.00	75.4 AV			1.05 H	110	79.85	-4.46
3	4882.00	44.9 PK	74.0	-29.1	1.56 H	245	42.52	2.34
4	4882.00	32.7 AV	54.0	-21.3	1.56 H	245	30.36	2.34
5	7323.00	50.8 PK	74.0	-23.2	1.56 H	70	41.62	9.17
6	7323.00	39.5 AV	54.0	-14.5	1.56 H	70	30.34	9.17
7	9764.00	57.4 PK	74.0	-16.6	1.55 H	240	44.62	12.74
8	9764.00	45.1 AV	54.0	-8.9	1.55 H	240	32.38	12.74
9	12205.00	58.7 PK	74.0	-15.3	1.55 H	256	42.21	16.47
10	12205.00	45.9 AV	54.0	-8.1	1.55 H	256	29.41	16.47

ANTENNA POLARITY & TEST DISTANCE: VERTICAL AT 3 M								
NO.	FREQ. (MHz)	EMISSION LEVEL (dBuV/m)	LIMIT (dBuV/m)	MARGIN (dB)	ANTENNA HEIGHT (m)	TABLE ANGLE (Degree)	RAW VALUE (dBuV)	CORRECTION FACTOR (dB/m)
1	*2441.00	81.8 PK			1.02 V	100	86.24	-4.46
2	*2441.00	81.3 AV			1.02 V	100	85.72	-4.46
3	4882.00	47.9 PK	74.0	-26.1	1.02 V	15	45.53	2.34
4	4882.00	39.1 AV	54.0	-14.9	1.02 V	15	36.72	2.34
5	7323.00	53.0 PK	74.0	-21.0	1.02 V	133	43.84	9.17
6	7323.00	39.4 AV	54.0	-14.6	1.02 V	133	30.24	9.17
7	9764.00	57.4 PK	74.0	-16.6	1.02 V	270	44.62	12.74
8	9764.00	44.9 AV	54.0	-9.1	1.02 V	270	32.12	12.74
9	12205.00	60.1 PK	74.0	-13.9	1.02 V	102	43.62	16.47
10	12205.00	47.5 AV	54.0	-6.5	1.02 V	102	31.01	16.47

REMARKS:

1. Emission Level(dBuV/m) = Raw Value(dBuV) + Correction Factor(dB/m)
2. Correction Factor(dB/m) = Antenna Factor(dB/m) + Cable Factor(dB) – Pre-Amplifier Factor(dB)
3. The other emission levels were very low against the limit.
4. Margin value = Emission Level – Limit value
5. " * ": Fundamental frequency.



A D T

CHANNEL	TX Channel 78	DETECTOR FUNCTION	Peak (PK)
FREQUENCY RANGE	1GHz ~ 25GHz		Average (AV)
TEST MODE	B		

ANTENNA POLARITY & TEST DISTANCE: HORIZONTAL AT 3 M

NO.	FREQ. (MHz)	EMISSION LEVEL (dBuV/m)	LIMIT (dBuV/m)	MARGIN (dB)	ANTENNA HEIGHT (m)	TABLE ANGLE (Degree)	RAW VALUE (dBuV)	CORRECTION FACTOR (dB/m)
1	*2480.00	76.6 PK			1.15 H	110	80.92	-4.32
2	*2480.00	76.0 AV			1.15 H	110	80.31	-4.32
3	2483.50	41.0 PK	74.0	-33.0	1.15 H	110	45.32	-4.31
4	2483.50	27.1 AV	54.0	-26.9	1.15 H	110	31.42	-4.31
5	4960.00	45.1 PK	74.0	-28.9	1.50 H	234	42.64	2.42
6	4960.00	32.8 AV	54.0	-21.2	1.50 H	234	30.37	2.42
7	7440.00	51.4 PK	74.0	-22.6	1.40 H	221	42.31	9.11
8	7440.00	37.7 AV	54.0	-16.3	1.40 H	221	28.62	9.11
9	9920.00	60.2 PK	74.0	-13.8	1.53 H	331	47.33	12.82
10	9920.00	39.8 AV	54.0	-14.2	1.53 H	331	27.01	12.82
11	12400.00	57.1 PK	74.0	-16.9	1.25 H	291	41.62	15.44
12	12400.00	44.1 AV	54.0	-9.9	1.25 H	291	28.63	15.44

ANTENNA POLARITY & TEST DISTANCE: VERTICAL AT 3 M

NO.	FREQ. (MHz)	EMISSION LEVEL (dBuV/m)	LIMIT (dBuV/m)	MARGIN (dB)	ANTENNA HEIGHT (m)	TABLE ANGLE (Degree)	RAW VALUE (dBuV)	CORRECTION FACTOR (dB/m)
1	*2480.00	81.4 PK			1.01 V	25	85.72	-4.32
2	*2480.00	81.0 AV			1.01 V	25	85.36	-4.32
3	2483.50	41.4 PK	74.0	-32.6	1.02 V	25	45.72	-4.31
4	2483.50	27.3 AV	54.0	-26.7	1.02 V	25	31.62	-4.31
5	4960.00	47.1 PK	74.0	-26.9	1.01 V	21	44.68	2.42
6	4960.00	38.3 AV	54.0	-15.7	1.01 V	21	35.92	2.42
7	7440.00	50.8 PK	74.0	-23.2	1.01 V	244	41.66	9.11
8	7440.00	38.2 AV	54.0	-15.8	1.01 V	244	29.13	9.11
9	9920.00	60.4 PK	74.0	-13.6	1.01 V	168	47.62	12.82
10	9920.00	50.9 AV	54.0	-3.1	1.01 V	168	38.03	12.82
11	12400.00	56.8 PK	74.0	-17.2	1.01 V	166	41.33	15.44
12	12400.00	44.5 AV	54.0	-9.5	1.01 V	166	29.02	15.44

REMARKS:

1. Emission Level(dBuV/m) = Raw Value(dBuV) + Correction Factor(dB/m)
2. Correction Factor(dB/m) = Antenna Factor(dB/m) + Cable Factor(dB) – Pre-Amplifier Factor(dB)
3. The other emission levels were very low against the limit.
4. Margin value = Emission Level – Limit value
5. " * ": Fundamental frequency.



A D T

BELOW 1GHz WORST-CASE DATA

CHANNEL	TX Channel 78	DETECTOR FUNCTION	Quasi-Peak (QP)
FREQUENCY RANGE	30MHz ~ 1GHz		
TEST MODE	A		

ANTENNA POLARITY & TEST DISTANCE: HORIZONTAL AT 3 M								
NO.	FREQ. (MHz)	EMISSION LEVEL (dBuV/m)	LIMIT (dBuV/m)	MARGIN (dB)	ANTENNA HEIGHT (m)	TABLE ANGLE (Degree)	RAW VALUE (dBuV)	CORRECTION FACTOR (dB/m)
1	117.01	28.8 QP	43.5	-14.7	1.37 H	269	44.96	-16.16
2	200.53	30.5 QP	43.5	-13.0	1.28 H	308	46.71	-16.20
3	366.06	32.4 QP	46.0	-13.6	1.19 H	262	43.30	-10.90
4	499.14	30.0 QP	46.0	-16.0	1.64 H	207	38.70	-8.72
5	665.64	34.6 QP	46.0	-11.4	1.37 H	240	40.37	-5.79
6	830.15	36.2 QP	46.0	-9.9	1.28 H	260	39.38	-3.23
ANTENNA POLARITY & TEST DISTANCE: VERTICAL AT 3 M								
NO.	FREQ. (MHz)	EMISSION LEVEL (dBuV/m)	LIMIT (dBuV/m)	MARGIN (dB)	ANTENNA HEIGHT (m)	TABLE ANGLE (Degree)	RAW VALUE (dBuV)	CORRECTION FACTOR (dB/m)
1	106.53	30.5 QP	43.5	-13.0	1.34 V	131	47.71	-17.21
2	199.60	28.7 QP	43.5	-14.8	1.28 V	340	44.93	-16.20
3	497.35	32.5 QP	46.0	-13.5	1.16 V	281	41.25	-8.73
4	662.10	36.6 QP	46.0	-9.4	1.37 V	279	42.44	-5.83
5	831.41	35.8 QP	46.0	-10.2	1.67 V	93	39.03	-3.23
6	920.70	34.5 QP	46.0	-11.5	1.22 V	269	36.32	-1.84

REMARKS:

1. Emission Level(dBuV/m) = Raw Value(dBuV) + Correction Factor(dB/m)
2. Correction Factor(dB/m) = Antenna Factor(dB/m) + Cable Factor(dB) – Pre-Amplifier Factor(dB)
3. The other emission levels were very low against the limit.
4. Margin value = Emission Level – Limit value



A D T

CHANNEL	TX Channel 78	DETECTOR FUNCTION	Quasi-Peak (QP)
FREQUENCY RANGE	30MHz ~ 1GHz		
TEST MODE	B		

ANTENNA POLARITY & TEST DISTANCE: HORIZONTAL AT 3 M								
NO.	FREQ. (MHz)	EMISSION LEVEL (dBuV/m)	LIMIT (dBuV/m)	MARGIN (dB)	ANTENNA HEIGHT (m)	TABLE ANGLE (Degree)	RAW VALUE (dBuV)	CORRECTION FACTOR (dB/m)
1	46.30	13.6 QP	40.0	-26.4	1.07 H	101	27.38	-13.80
2	129.04	14.1 QP	43.5	-29.4	1.13 H	315	29.15	-15.05
3	162.02	14.8 QP	43.5	-28.7	1.21 H	193	28.33	-13.49
4	263.09	13.4 QP	46.0	-32.6	1.05 H	293	26.86	-13.50
5	290.93	14.4 QP	46.0	-31.6	1.00 H	181	26.78	-12.38
6	403.11	16.3 QP	46.0	-29.7	1.04 H	214	26.76	-10.46
ANTENNA POLARITY & TEST DISTANCE: VERTICAL AT 3 M								
NO.	FREQ. (MHz)	EMISSION LEVEL (dBuV/m)	LIMIT (dBuV/m)	MARGIN (dB)	ANTENNA HEIGHT (m)	TABLE ANGLE (Degree)	RAW VALUE (dBuV)	CORRECTION FACTOR (dB/m)
1	45.33	14.7 QP	40.0	-25.3	1.17 V	124	28.53	-13.81
2	162.02	15.9 QP	43.5	-27.6	1.37 V	77	29.35	-13.49
3	291.75	13.4 QP	46.0	-32.6	1.28 V	138	25.73	-12.36
4	309.60	14.8 QP	46.0	-31.2	1.16 V	14	26.65	-11.89
5	350.44	15.1 QP	46.0	-30.9	1.34 V	112	26.49	-11.40
6	429.79	17.9 QP	46.0	-28.1	1.08 V	100	27.65	-9.72

REMARKS:

1. Emission Level(dBuV/m) = Raw Value(dBuV) + Correction Factor(dB/m)
2. Correction Factor(dB/m) = Antenna Factor(dB/m) + Cable Factor(dB) – Pre-Amplifier Factor(dB)
3. The other emission levels were very low against the limit.
4. Margin value = Emission Level – Limit value



A D T

CHANNEL	TX Channel 78	DETECTOR FUNCTION	Quasi-Peak (QP)
FREQUENCY RANGE	30MHz ~ 1GHz		
TEST MODE	C		

ANTENNA POLARITY & TEST DISTANCE: HORIZONTAL AT 3 M

NO.	FREQ. (MHz)	EMISSION LEVEL (dBuV/m)	LIMIT (dBuV/m)	MARGIN (dB)	ANTENNA HEIGHT (m)	TABLE ANGLE (Degree)	RAW VALUE (dBuV)	CORRECTION FACTOR (dB/m)
1	38.00	20.0 QP	40.0	-20.0	1.17 H	223	34.48	-14.44
2	71.86	18.6 QP	40.0	-21.5	1.25 H	118	34.46	-15.91
3	105.13	21.2 QP	43.5	-22.3	1.37 H	180	38.61	-17.41
4	133.40	21.1 QP	43.5	-22.4	1.56 H	84	35.59	-14.51
5	280.31	24.3 QP	46.0	-21.7	1.07 H	354	36.95	-12.64
6	510.05	27.7 QP	46.0	-18.3	1.02 H	328	36.10	-8.41

ANTENNA POLARITY & TEST DISTANCE: VERTICAL AT 3 M

NO.	FREQ. (MHz)	EMISSION LEVEL (dBuV/m)	LIMIT (dBuV/m)	MARGIN (dB)	ANTENNA HEIGHT (m)	TABLE ANGLE (Degree)	RAW VALUE (dBuV)	CORRECTION FACTOR (dB/m)
1	71.90	22.5 QP	40.0	-17.5	1.17 V	82	38.38	-15.92
2	104.64	27.3 QP	43.5	-16.2	1.25 V	327	44.74	-17.47
3	167.98	22.0 QP	43.5	-21.5	1.09 V	322	35.64	-13.63
4	238.79	25.9 QP	46.0	-20.1	1.16 V	357	40.58	-14.66
5	280.31	24.5 QP	46.0	-21.5	1.25 V	169	37.15	-12.64
6	450.01	24.8 QP	46.0	-21.2	1.17 V	48	34.07	-9.25

REMARKS:

1. Emission Level(dBuV/m) = Raw Value(dBuV) + Correction Factor(dB/m)
2. Correction Factor(dB/m) = Antenna Factor(dB/m) + Cable Factor(dB) – Pre-Amplifier Factor(dB)
3. The other emission levels were very low against the limit.
4. Margin value = Emission Level – Limit value

4.3 NUMBER OF HOPPING FREQUENCY USED

4.3.1 LIMIT OF HOPPING FREQUENCY USED

At least 15 channels frequencies, and should be equally spaced.

4.3.2 TEST SETUP

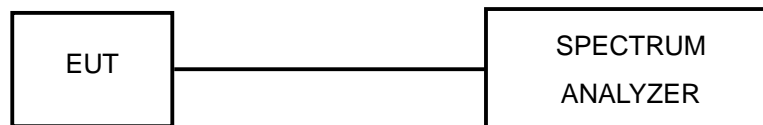

4.3.3 TEST INSTRUMENTS

Refer to section 4.2.2 to get information of above instrument.

4.3.4 TEST PROCEDURES

- Check the calibration of the measuring instrument (SA) using either an internal calibrator or a known signal from an external generator.
- Turn on the EUT and connect its antenna terminal to measurement via a low loss cable. Then set it to any one measured frequency within its operating range and make sure the instrument is operated in its linear range.
- Set the SA on MaxHold Mode, and then keep the EUT in hopping mode. Record all the signals from each channel until each one has been recorded.
- Set the SA on View mode and then plot the result on SA screen.
- Repeat above procedures until all frequencies measured were complete.

4.3.5 DEVIATION FROM TEST STANDARD

No deviation.

4.3.6 TEST RESULTS

There are 79 hopping frequencies in the hopping mode. Please refer to next two pages for the test result. On the plots, it shows that the hopping frequencies are equally spaced.



A D T

Mode A

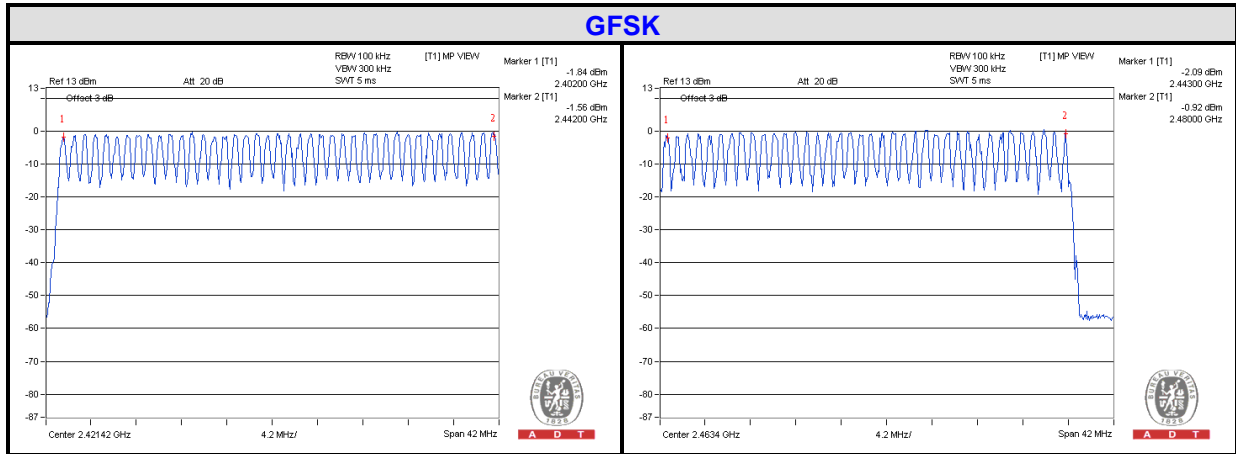

4.4 DWELL TIME ON EACH CHANNEL

4.4.1 LIMIT OF DWELL TIME USED

The average time of occupancy on any channel shall not be greater than 0.4 seconds within a period of 0.4 seconds multiplied by the number of hopping channels employed.

4.4.2 TEST SETUP

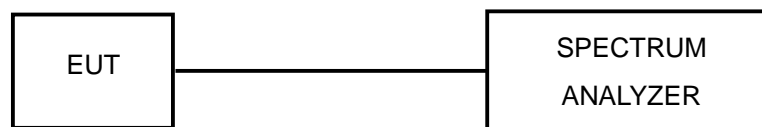

4.4.3 TEST INSTRUMENTS

Refer to section 4.2.2 to get information of above instrument.

4.4.4 TEST PROCEDURES

- a. Check the calibration of the measuring instrument (SA) using either an internal calibrator or a known signal from an external generator.
- b. Turn on the EUT and connect its antenna terminal to measurement via a low loss cable. Then set it to any one measured frequency within its operating range and make sure the instrument is operated in its linear range.
- c. Adjust the center frequency of SA on any frequency be measured and set SA to zero span mode. And then, set RBW and VBW of spectrum analyzer to proper value.
- d. Measure the time duration of one transmission on the measured frequency. And then plot the result with time difference of this time duration.
- e. Repeat above procedures until all different time-slot modes have been completed.

4.4.5 DEVIATION FROM TEST STANDARD

No deviation.



A D T

4.4.6 TEST RESULTS

Mode A

Mode	Number of transmission in a 31.6 (79Hopping*0.4)	Length of transmission time (msec)	Result (msec)	Limit (msec)
DH1	50 (times / 5 sec) * 6.32 = 316.00times	0.471	148.84	400
DH3	25 (times / 5 sec) * 6.32 = 158.00 times	1.731	273.50	400
DH5	16 (times / 5 sec) * 6.32 = 101.12 times	2.975	300.83	400

NOTE: Test plots of the transmitting time slot are shown on below.

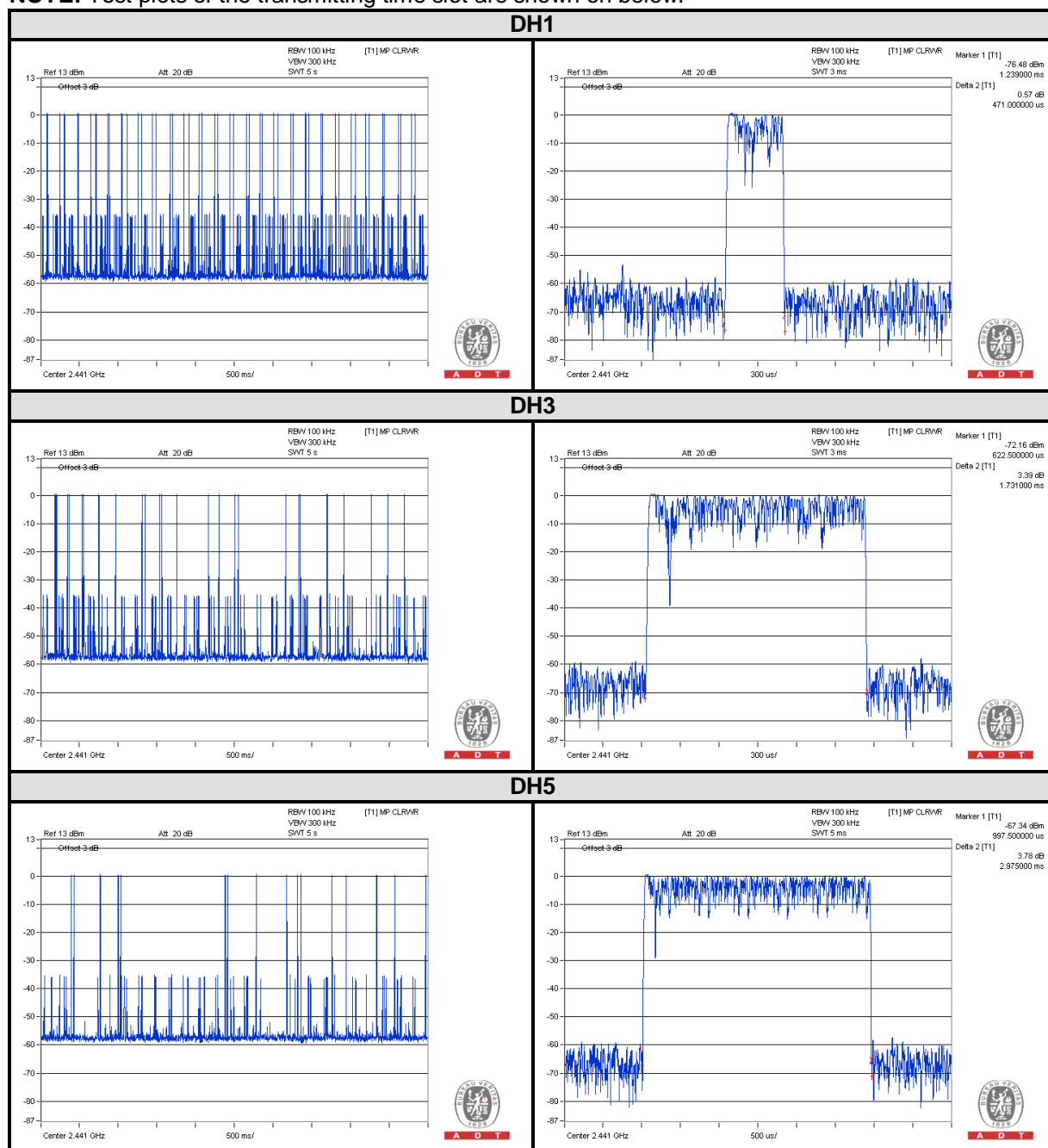

4.5 CHANNEL BANDWIDTH

4.5.1 LIMITS OF CHANNEL BANDWIDTH

For frequency hopping system operating in the 2400-2483.5MHz, If the 20dB bandwidth of hopping channel is greater than 25kHz, two-thirds 20dB bandwidth of hopping channel shall be a minimum limit for the hopping channel separation.

4.5.2 TEST SETUP

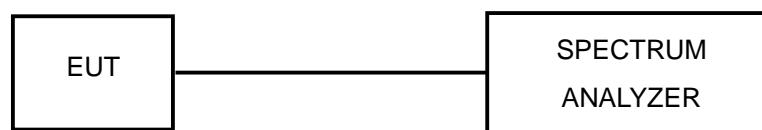

4.5.3 TEST INSTRUMENTS

Refer to section 4.2.2 to get information of above instrument.

4.5.4 TEST PROCEDURE

- a. Check the calibration of the measuring instrument using either an internal calibrator or a known signal from an external generator.
- b. Turn on the EUT and connect it to measurement instrument. Then set it to any one convenient frequency within its operating range. Set a reference level on the measuring instrument equal to the highest peak value.
- c. Measure the frequency difference of two frequencies that were attenuated 20dB from the reference level. Record the frequency difference as the emission bandwidth.
- d. Repeat above procedures until all frequencies measured were complete.

4.5.5 DEVIATION FROM TEST STANDARD

No deviation.

4.5.6 EUT OPERATING CONDITION

The software provided by client enabled the EUT to transmit and receive data at lowest, middle and highest channel frequencies individually.



A D T

4.5.7 TEST RESULTS

Mode A

CHANNEL	FREQUENCY (MHz)	20dB BANDWIDTH (MHz)
0	2402	1.10
39	2441	1.04
78	2480	1.03

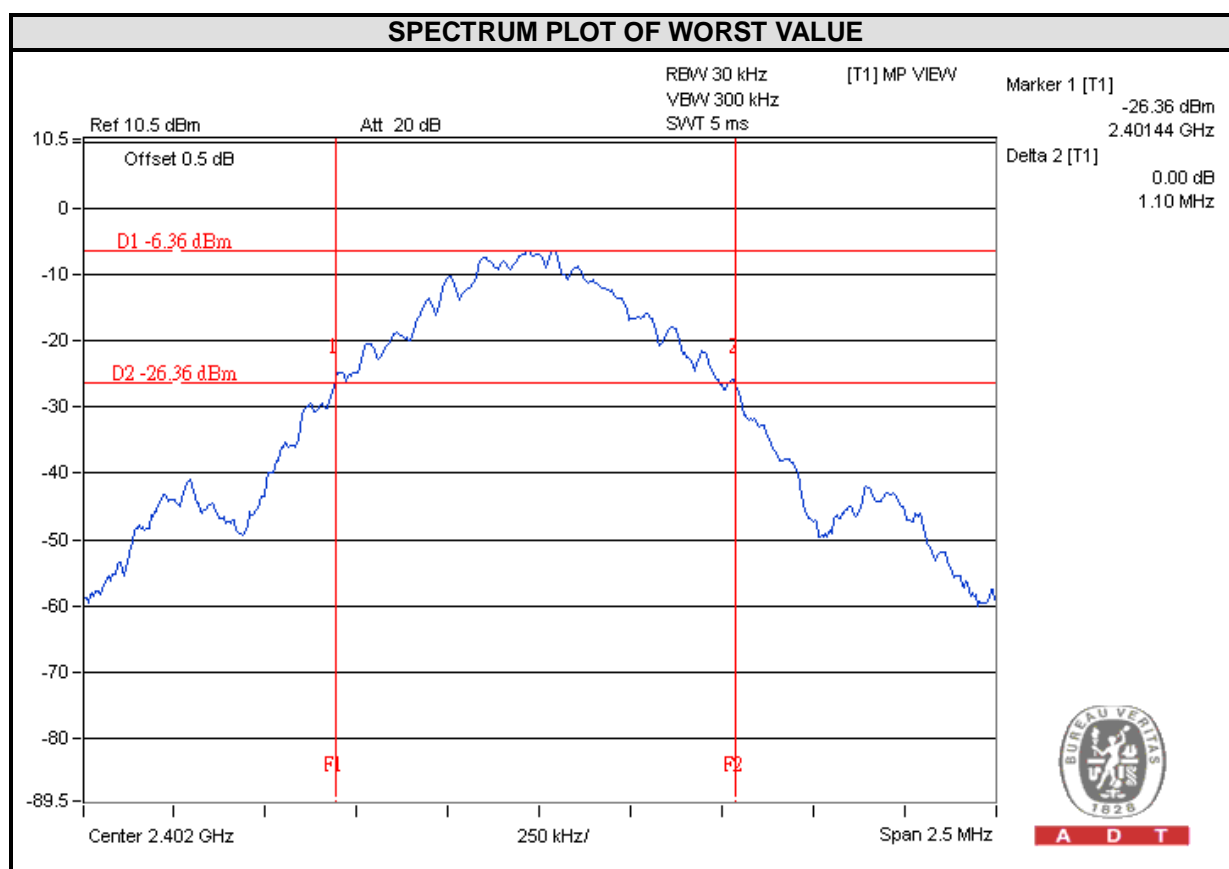

A D T

4.6 HOPPING CHANNEL SEPARATION

4.6.1 LIMIT OF HOPPING CHANNEL SEPARATION

At least 25kHz or two-third of 20dB hopping channel bandwidth (whichever is greater).

4.6.2 TEST SETUP

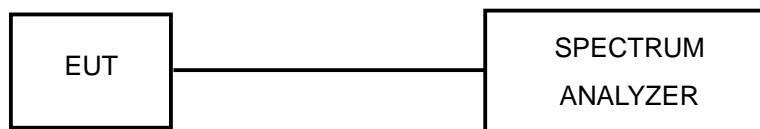

4.6.3 TEST INSTRUMENTS

Refer to section 4.2.2 to get information of above instrument.

4.6.4 TEST PROCEDURES

- a. Check the calibration of the measuring instrument using either an internal calibrator or a known signal from an external generator.
- b. Turn on the EUT and connect it to measurement instrument. Then set it to any one convenient frequency within its operating range.
- c. By using the MaxHold function record the separation of two adjacent channels.
- d. Measure the frequency difference of these two adjacent channels by SA MARK function. And then plot the result on SA screen.
- e. Repeat above procedures until all frequencies measured were complete.

4.6.5 DEVIATION FROM TEST STANDARD

No deviation.



A D T

4.6.6 TEST RESULTS

Mode A

CHANNEL	FREQUENCY (MHz)	ADJACENT CHANNEL SEPARATION (MHz)	20dB BANDWIDTH (MHz)	MINIMUM LIMIT (MHz)	PASS / FAIL
0	2402	1.00	1.10	0.73	PASS
39	2441	1.00	1.04	0.69	PASS
78	2480	1.00	1.03	0.69	PASS

NOTE: The minimum limit is two-third 20dB bandwidth.

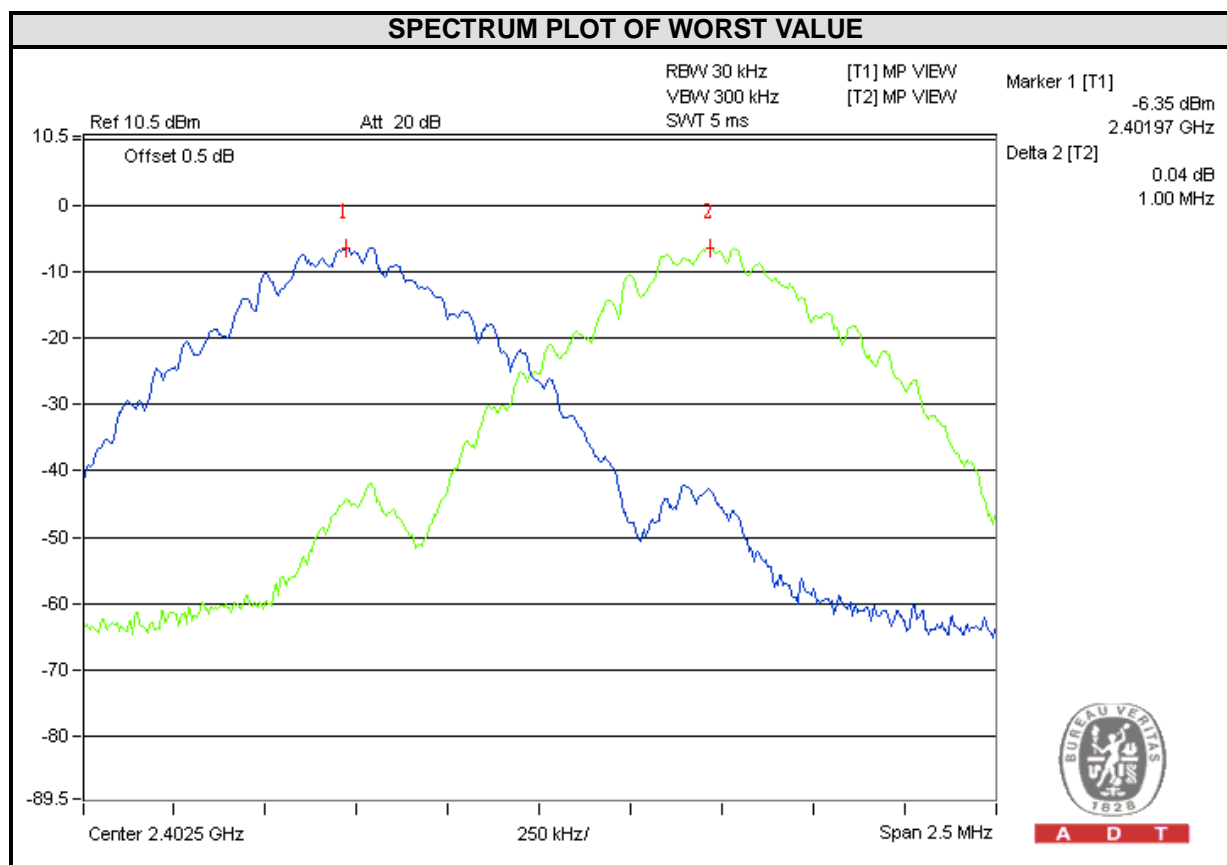

4.7 MAXIMUM OUTPUT POWER

4.7.1 LIMITS OF MAXIMUM OUTPUT POWER MEASUREMENT

The Maximum Output Power Measurement is 125mW.

4.7.2 TEST SETUP

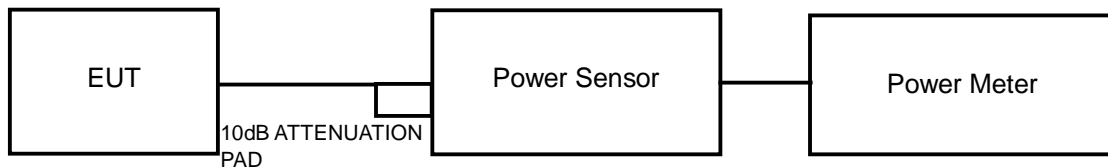

4.7.3 TEST INSTRUMENTS

Refer to section 4.2.2 to get information of above instrument.

4.7.4 TEST PROCEDURES

A peak / average power sensor was used on the output port of the EUT. A power meter was used to read the response of the peak / average power sensor. Record the peak power level.

4.7.5 DEVIATION FROM TEST STANDARD

No deviation.

4.7.6 EUT OPERATING CONDITION

The software provided by client enabled the EUT to transmit and receive data at lowest, middle and highest channel frequencies individually.



A D T

4.7.7 TEST RESULTS

Mode A

CHANNEL	FREQUENCY (MHz)	OUTPUT POWER (dBm)	OUTPUT POWER (mW)	POWER LIMIT (mW)	PASS / FAIL
0	2402	-1.55	0.7	125	PASS
39	2441	-1.48	0.7	125	PASS
78	2480	-1.52	0.7	125	PASS

4.8 CONDUCTED OUT OF BAND EMISSION MEASUREMENT

4.8.1 LIMITS OF CONDUCTED OUT OF BAND EMISSION MEASUREMENT

Below -20dB of the highest emission level of operating band (in 100KHz RBW).

4.8.2 TEST INSTRUMENTS

Refer to section 4.2.2 to get information of above instrument.

4.8.3 TEST PROCEDURE

The transmitter output was connected to the spectrum analyzer via a low loss cable. Set both RBW and VBW of spectrum analyzer to 100 kHz & 300 kHz with suitable frequency span including 100 MHz bandwidth from band edge. The band edges was measured and recorded.

4.8.4 DEVIATION FROM TEST STANDARD

No deviation.

4.8.5 EUT OPERATING CONDITION

The software provided by client enabled the EUT to transmit and receive data at lowest, middle and highest channel frequencies individually.

4.8.6 TEST RESULTS

The spectrum plots are attached on the following images. D1 line indicates the highest level, D2 line indicates the 20dB offset below D1. It shows compliance with the requirement.



A D T

Mode A

Hopping disabled_ Low Channel

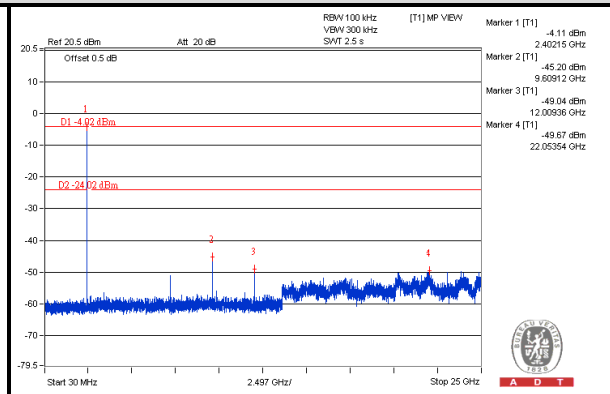
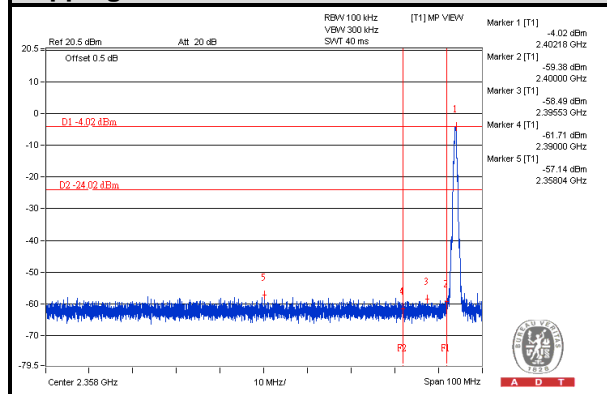

Hopping disabled_ High Channel

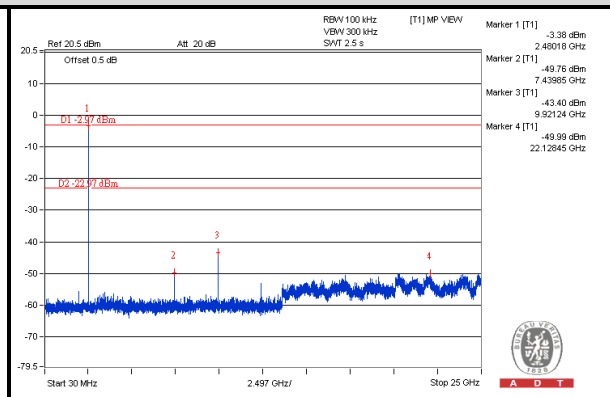
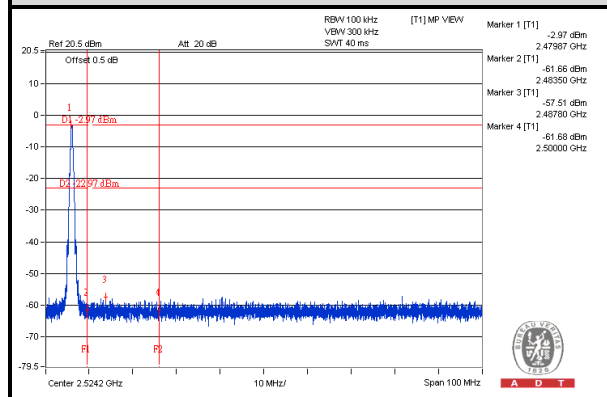

Hopping enabled_ Low Channel

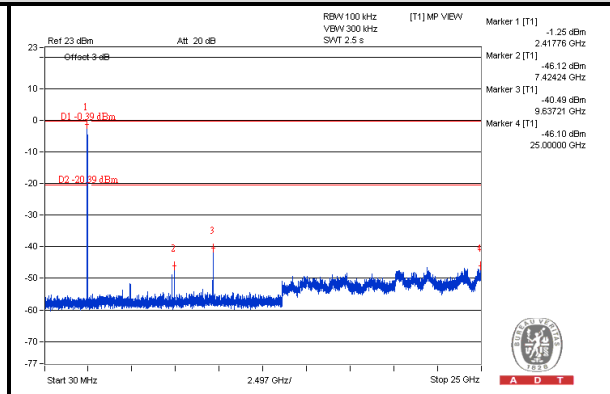
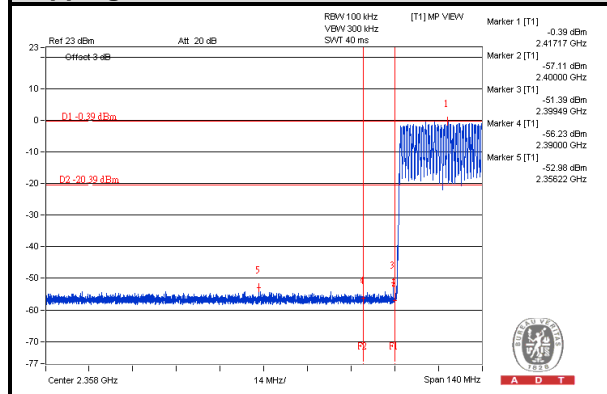

Hopping enabled_ High Channel

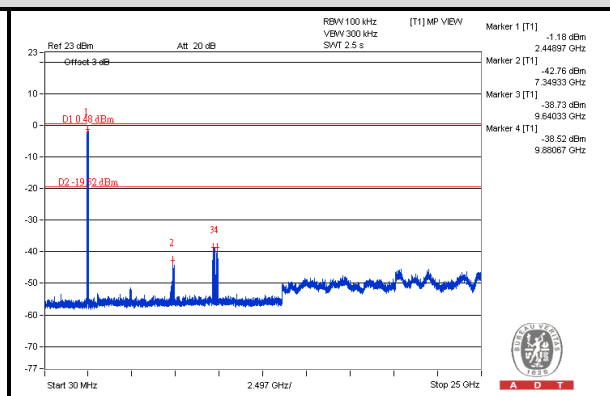
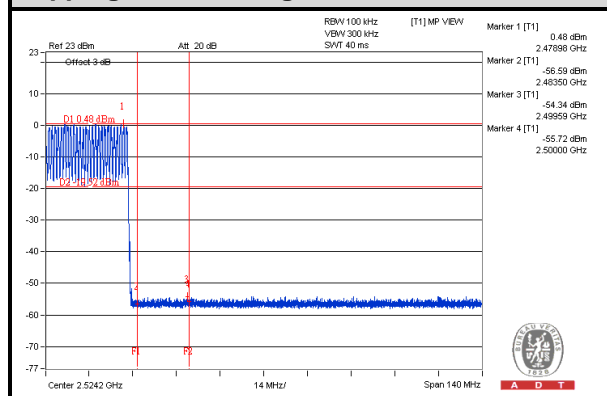



A D T

5. PHOTOGRAPHS OF THE TEST CONFIGURATION

Please refer to the attached file (Test Setup Photo).



6. INFORMATION ON THE TESTING LABORATORIES

We, Bureau Veritas Consumer Products Services (H.K.) Ltd., Taoyuan Branch, were founded in 1988 to provide our best service in EMC, Radio, Telecom and Safety consultation. Our laboratories are accredited and approved according to ISO/IEC 17025.

If you have any comments, please feel free to contact us at the following:

Linko EMC/RF Lab:

Tel: 886-2-26052180

Fax: 886-2-26051924

Hsin Chu EMC/RF Lab:

Tel: 886-3-5935343

Fax: 886-3-5935342

Hwa Ya EMC/RF/Safety Telecom Lab:

Tel: 886-3-3183232

Fax: 886-3-3270892

Email: service.adt@tw.bureauveritas.com

Web Site: www.bureauveritas-adt.com

The address and road map of all our labs can be found in our web site also.



A D T

7. APPENDIX A - MODIFICATIONS RECORDERS FOR ENGINEERING CHANGES TO THE EUT BY THE LAB

No modifications were made to the EUT by the lab during the test.

--- END ---