

# TEST REPORT

## CERTIFICATE OF CONFORMITY

**Standard:** 47 CFR FCC Part 15, Subpart C (Section 15.247)

**Report No.:** RFBEBU-WTW-P22120823

**FCC ID:** E8HKC-2227

**Product:** Gaming Keyboard

**Brand:** ALIENWARE, DELL

**Model No.:** AW920K

**Received Date:** 2022/12/28

**Test Date:** 2022/12/27 ~ 2023/1/10

**Issued Date:** 2023/1/30

**Applicant:** Chicony Electronics Co., Ltd.

**Address:** No.69, Sec. 2, Guangfu Rd., Sanchong Dist., New Taipei City 241, Taiwan(R.O.C.)

**Issued By:** Bureau Veritas Consumer Products Services (H.K.) Ltd., Taoyuan Branch  
Lin Kou Laboratories

**Lab Address:** No. 47-2, 14th Ling, Chia Pau Vil., Lin Kou Dist., New Taipei City, Taiwan

**Test Location:** No. 47-2, 14th Ling, Chia Pau Vil., Lin Kou Dist., New Taipei City, Taiwan

**FCC Registration /** 198487 / TW2021

**Designation Number:**

**Approved by:** Jeremy Lin, **Date:** 2023/1/30  
Jeremy Lin / Project Engineer

This test report consists of 48 pages in total. It may be duplicated completely for legal use with the approval of the applicant. It should not be reproduced except in full, without the written approval of our laboratory. The test results in the report only apply to the tested sample. The test results in this report are traceable to the national or international standards.



Prepared by : Jessica Cheng / Senior Specialist

This report is governed by, and incorporates by reference, the Conditions of Testing as posted at the date of issuance of this report at <http://www.bureauveritas.com/home/about-us/our-business/cps/about-us/terms-conditions/> and is intended for your exclusive use. Any copying or replication of this report to or for any other person or entity, or use of our name or trademark, is permitted only with our prior written permission. This report sets forth our findings solely with respect to the test samples identified herein. The results set forth in this report are not indicative or representative of the quality or characteristics of the lot from which a test sample was taken or any similar or identical product unless specifically and expressly noted. Our report includes all of the tests requested by you and the results thereof based upon the information that you provided to us. Measurement uncertainty is only provided upon request for accredited tests. Statements of conformity are based on simple acceptance criteria without taking measurement uncertainty into account, unless otherwise requested in writing. You have 60 days from date of issuance of this report to notify us of any material error or omission caused by our negligence or if you require measurement uncertainty; provided, however, that such notice shall be in writing and shall specifically address the issue you wish to raise. A failure to raise such issue within the prescribed time shall constitute your unqualified acceptance of the completeness of this report, the tests conducted and the correctness of the report contents.

## Table of Contents

<b>Release Control Record</b> .....	<b>4</b>
<b>1 Certificate</b> .....	<b>5</b>
<b>2 Summary of Test Results</b> .....	<b>6</b>
2.1 Measurement Uncertainty .....	6
2.2 Supplementary Information .....	6
<b>3 General Information</b> .....	<b>7</b>
3.1 General Description .....	7
3.2 Antenna Description of EUT .....	8
3.3 Channel List .....	9
3.4 Test Mode Applicability and Tested Channel Detail .....	10
3.5 Duty Cycle of Test Signal .....	11
3.6 Test Program Used and Operation Descriptions .....	12
3.7 Connection Diagram of EUT and Peripheral Devices .....	12
3.8 Configuration of Peripheral Devices and Cable Connections .....	14
<b>4 Test Instruments</b> .....	<b>15</b>
4.1 RF Output Power .....	15
4.2 Power Spectral Density .....	15
4.3 6 dB Bandwidth .....	15
4.4 Conducted Out of Band Emissions .....	15
4.5 AC Power Conducted Emissions .....	16
4.6 Unwanted Emissions below 1 GHz .....	17
4.7 Unwanted Emissions above 1 GHz .....	18
<b>5 Limits of Test Items</b> .....	<b>19</b>
5.1 RF Output Power .....	19
5.2 Power Spectral Density .....	19
5.3 6 dB Bandwidth .....	19
5.4 Conducted Out of Band Emissions .....	19
5.5 AC Power Conducted Emissions .....	19
5.6 Unwanted Emissions below 1 GHz .....	19
5.7 Unwanted Emissions above 1 GHz .....	20
<b>6 Test Arrangements</b> .....	<b>21</b>
6.1 RF Output Power .....	21
6.1.1 Test Setup .....	21
6.1.2 Test Procedure .....	21
6.2 Power Spectral Density .....	21
6.2.1 Test Setup .....	21
6.2.2 Test Procedure .....	21
6.3 6 dB Bandwidth .....	22
6.3.1 Test Setup .....	22
6.3.2 Test Procedure .....	22
6.4 Conducted Out of Band Emissions .....	22
6.4.1 Test Setup .....	22
6.4.2 Test Procedure .....	22
6.5 AC Power Conducted Emissions .....	23
6.5.1 Test Setup .....	23
6.5.2 Test Procedure .....	23
6.6 Unwanted Emissions below 1 GHz .....	24
6.6.1 Test Setup .....	24
6.6.2 Test Procedure .....	25
6.7 Unwanted Emissions above 1 GHz .....	26
6.7.1 Test Setup .....	26
6.7.2 Test Procedure .....	26
<b>7 Test Results of Test Item</b> .....	<b>27</b>



7.1	RF Output Power .....	27
7.2	Power Spectral Density .....	28
7.3	6 dB Bandwidth .....	29
7.4	Conducted Out of Band Emissions .....	30
7.5	AC Power Conducted Emissions .....	31
7.6	Unwanted Emissions below 1 GHz .....	39
7.7	Unwanted Emissions above 1 GHz .....	43
<b>8</b>	<b>Pictures of Test Arrangements .....</b>	<b>47</b>
<b>9</b>	<b>Information of the Testing Laboratories .....</b>	<b>48</b>



## Release Control Record

Issue No.	Description	Date Issued
RFBEBU-WTW-P22120823	Original release.	2023/1/30

## 1 Certificate

**Product:** Gaming Keyboard

**Brand:** ALIENWARE, DELL

**Test Model:** AW920K

**Sample Status:** Engineering sample

**Applicant:** Chicony Electronics Co., Ltd.

**Test Date:** 2022/12/27 ~ 2023/1/10

**Standard:** 47 CFR FCC Part 15, Subpart C (Section 15.247)

**Measurement** ANSI C63.10-2013

**procedure:** KDB 558074 D01 15.247 Meas Guidance v05r02

The above equipment has been tested by **Bureau Veritas Consumer Products Services (H.K.) Ltd., Taoyuan Branch**, and found compliance with the requirement of the above standards. The test record, data evaluation & Equipment Under Test (EUT) configurations represented herein are true and accurate accounts of the measurements of the sample's RF characteristics under the conditions specified in this report.

## 2 Summary of Test Results

47 CFR FCC Part 15, Subpart C (Section 15.247)			
Standard / Clause	Test Item	Result	Remark
15.247(b)	RF Output Power	Pass	Meet the requirement of limit.
15.247(e)	Power Spectral Density	Pass	Meet the requirement of limit.
15.247(a)(2)	6 dB Bandwidth	Pass	Meet the requirement of limit.
15.247(d)	Conducted Out of Band Emissions	Pass	Meet the requirement of limit.
15.207	AC Power Conducted Emissions	Pass	Minimum passing margin is -12.46 dB at 0.15687 MHz
15.205 / 15.209 / 15.247(d)	Unwanted Emissions below 1 GHz	Pass	Minimum passing margin is -10.9 dB at 383.86 MHz
15.205 / 15.209 / 15.247(d)	Unwanted Emissions above 1 GHz	Pass	Minimum passing margin is -8.0 dB at 2483.50 MHz
15.203	Antenna Requirement	Pass	No antenna connector is used.

Note: Determining compliance based on the results of the compliance measurement, not taking into account measurement instrumentation uncertainty.

### 2.1 Measurement Uncertainty

Where relevant, the following measurement uncertainty levels have been estimated for tests performed on the EUT as specified in CISPR 16-4-2:

Measurement	Specification	Expanded Uncertainty (k=2) (±)
Conducted Out of Band Emissions	9 kHz ~ 40 GHz	2.63 dB
AC Power Conducted Emissions	150 kHz ~ 30 MHz	3.00 dB
Unwanted Emissions below 1 GHz	9 kHz ~ 30 MHz	2.38 dB
	30 MHz ~ 1 GHz	5.7 dB
Unwanted Emissions above 1 GHz	1 GHz ~ 6 GHz	4.83 dB
	6 GHz ~ 18 GHz	5.37 dB
	18 GHz ~ 40 GHz	5.24 dB

The other instruments specified are routine verified to remain within the calibrated levels, no measurement uncertainty is required to be calculated.

### 2.2 Supplementary Information

There is not any deviation from the test standards for the test method, and no modifications required for compliance.

### 3 General Information

#### 3.1 General Description

Product	Gaming Keyboard
Brand	ALIENWARE, DELL
Test Model	AW920K
Status of EUT	Engineering sample
Power Supply Rating	3.8Vdc from battery or 5Vdc from host equipment
Modulation Type	GFSK
Modulation Technology	DTS
Transfer Rate	Up to 1 Mbps
Operating Frequency	2.402 GHz ~ 2.48 GHz
Number of Channel	40
Output Power	2.004 mW (3.02 dBm)

Note:

1. The EUT uses following accessories.

<b>Shielded USB Cable 2.0m</b>		
<b>Extender</b>		
Brand	Model	
ALIENWARE	771-02227L-A01	
<b>Dongle</b>		
Brand	Model	FCC ID
ALIENWARE, DELL	UD2402c	E8HRG-2227

2. There are Bluetooth and GFSK technology used for the EUT.
3. Bluetooth and GFSK technology can not transmit at same time.
4. EUT without Extender via connect USB cable will become charging mode only.
5. The above EUT information is declared by manufacturer and for more detailed features description, please refer to the manufacturer's specifications or User's Manual.

### 3.2 Antenna Description of EUT

1. The antenna information is listed as below.

Gain (dBi)	Antenna Type	Connector Type
5.78	Monopole	N/A

\* Detail antenna specification please refer to antenna datasheet and/or antenna measurement report.



### 3.3 Channel List

40 channels are provided for BT-LE:

Channel	Frequency (MHz)	Channel	Frequency (MHz)	Channel	Frequency (MHz)	Channel	Frequency (MHz)
0	2402	10	2422	20	2442	30	2462
1	2404	11	2424	21	2444	31	2464
2	2406	12	2426	22	2446	32	2466
3	2408	13	2428	23	2448	33	2468
4	2410	14	2430	24	2450	34	2470
5	2412	15	2432	25	2452	35	2472
6	2414	16	2434	26	2454	36	2474
7	2416	17	2436	27	2456	37	2476
8	2418	18	2438	28	2458	38	2478
9	2420	19	2440	29	2460	39	2480

### 3.4 Test Mode Applicability and Tested Channel Detail

Pre-Scan:	<p>1. For Unwanted Emission below 1 GHz has EUT only/ EUT with Extender+Dongle+USB Cable+NB/ EUT with Extender+Dongle+USB Cable+Adapter mode of power supply. Pre-scan these modes and find the worst case as a representative test condition.</p> <p>2. For Unwanted Emission below 1 GHz Charging mode has EUT with USB Cable+NB /EUT with USB Cable+Adapter. Pre-scan these modes and find the worst case as a representative test condition.</p> <p>3. For Unwanted Emission above 1 GHz has EUT only/ EUT with Extender+Dongle+USB Cable+NB mode of power supply. Pre-scan these modes and find the worst case as a representative test condition</p>
Worst Case:	<p>1. For Unwanted Emission below 1 GHz: EUT with Extender+Dongle+USB Cable+NB.</p> <p>2. For Unwanted Emission below 1 GHz Charging mode: EUT with USB Cable+NB.</p> <p>3. For Unwanted Emission above 1 GHz: EUT with Extender+Dongle+USB Cable+NB.</p>

Following channel(s) was (were) selected for the final test as listed below:

Test Item	EUT Configure Mode	Mode	Tested Channel	Modulation	Data Rate Parameter
RF Output Power / Power Spectral Density	A	BT-LE 1M	0, 19, 39	GFSK	1Mb/s
6 dB Bandwidth / Conducted Out of Band Emissions	A	BT-LE 1M	0, 19, 39	GFSK	1Mb/s
AC Power Conducted Emissions	A	BT-LE 1M	39	GFSK	1Mb/s
	B	BT-LE 1M	39	GFSK	1Mb/s
	C	BT-LE 1M	-	-	-
	D	BT-LE 1M	-	-	-
Unwanted Emissions below 1 GHz	A	BT-LE 1M	39	GFSK	1Mb/s
	C	BT-LE 1M	-	-	-
Unwanted Emissions above 1 GHz	A	BT-LE 1M	0, 19, 39	GFSK	1Mb/s
EUT Configure Mode:	A	EUT with Extender+Dongle+USB Cable+NB			
	B	EUT with Extender+Dongle+USB Cable+Adapter			
	C	EUT with USB Cable+NB (Charging mode)			
	D	EUT with USB Cable+Adapter (Charging mode)			

### 3.5 Duty Cycle of Test Signal

#### Mode A

**BT-LE 1M:** Duty cycle =  $0.395 \text{ ms} / 0.625 \text{ ms} \times 100\% = 63.2\%$ , duty factor =  $10 * \log (1/\text{Duty cycle}) = 1.99 \text{ dB}$

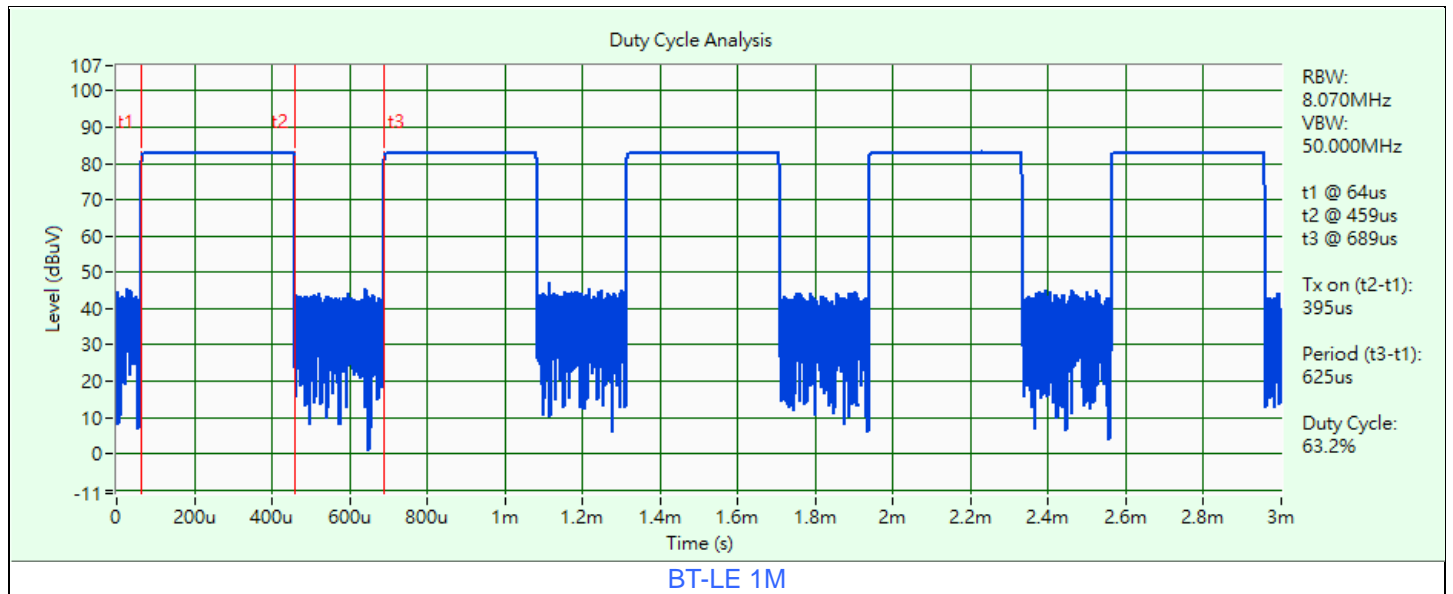

### 3.6 Test Program Used and Operation Descriptions

Controlling software (nRFgo Studio v1.17.0.3211) has been activated to set the EUT under transmission condition continuously at specific channel frequency.

### 3.7 Connection Diagram of EUT and Peripheral Devices

Mode A

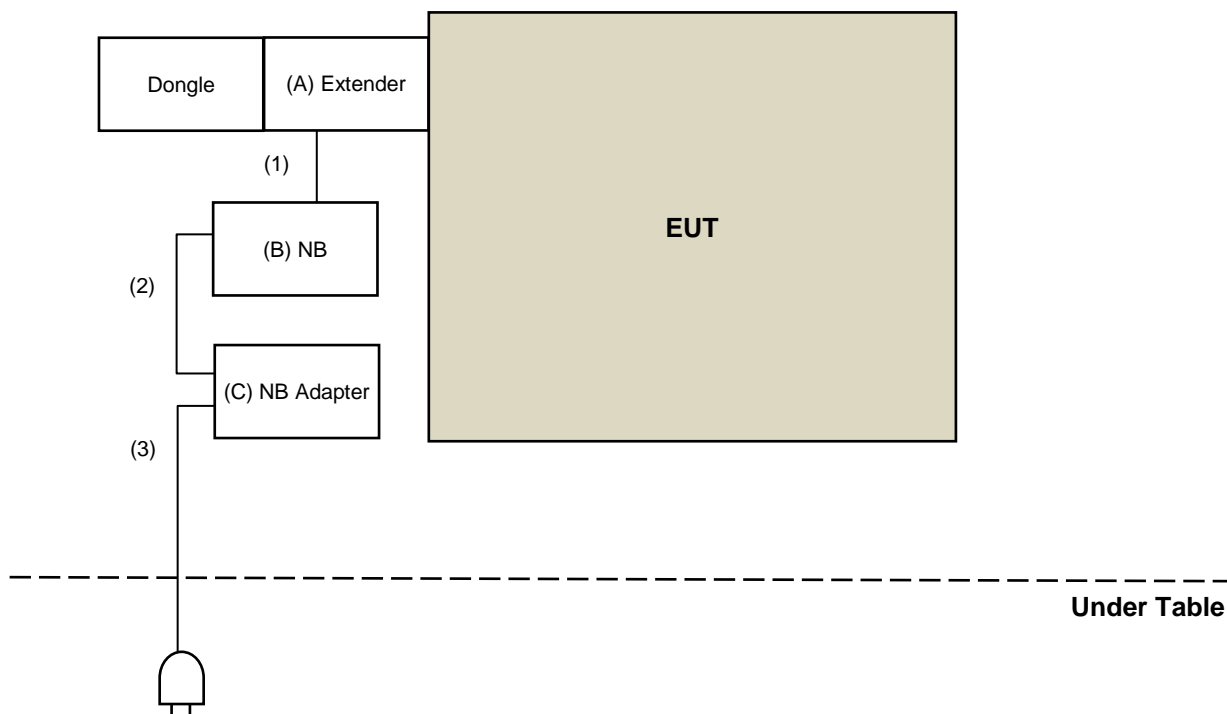

Mode B

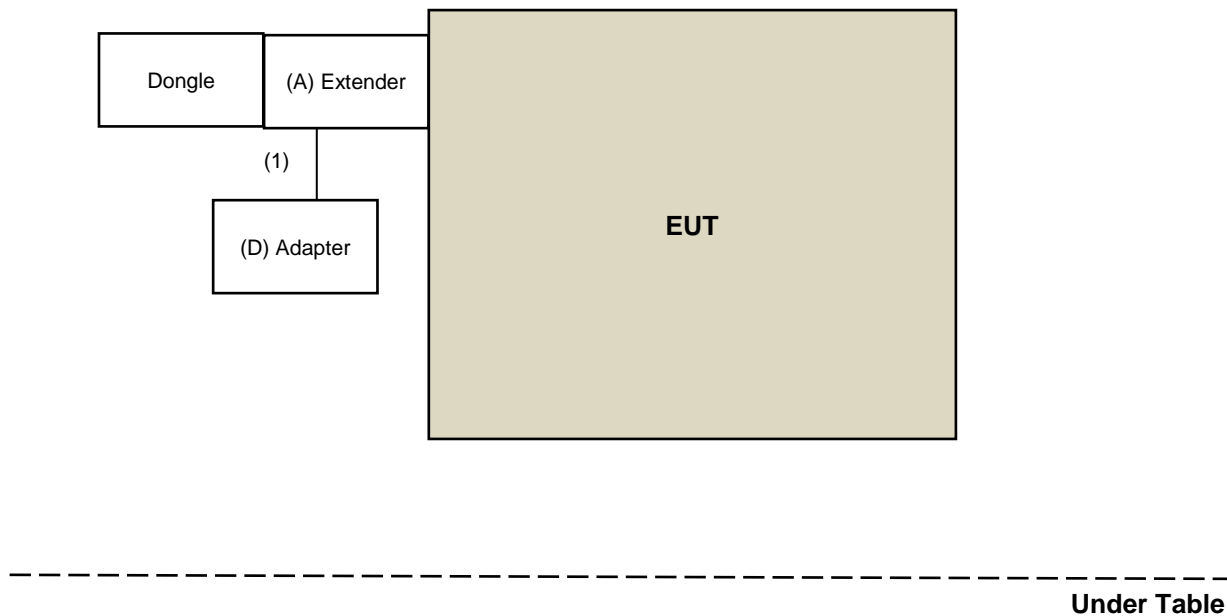

Mode C

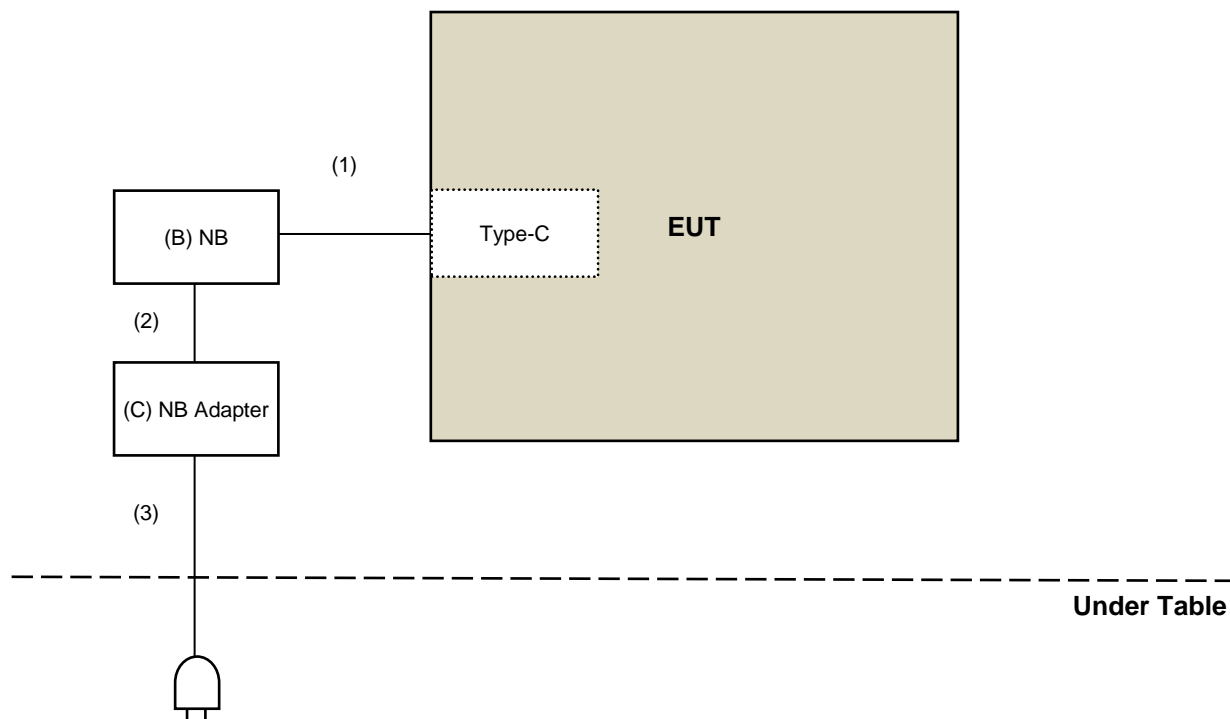

Mode D

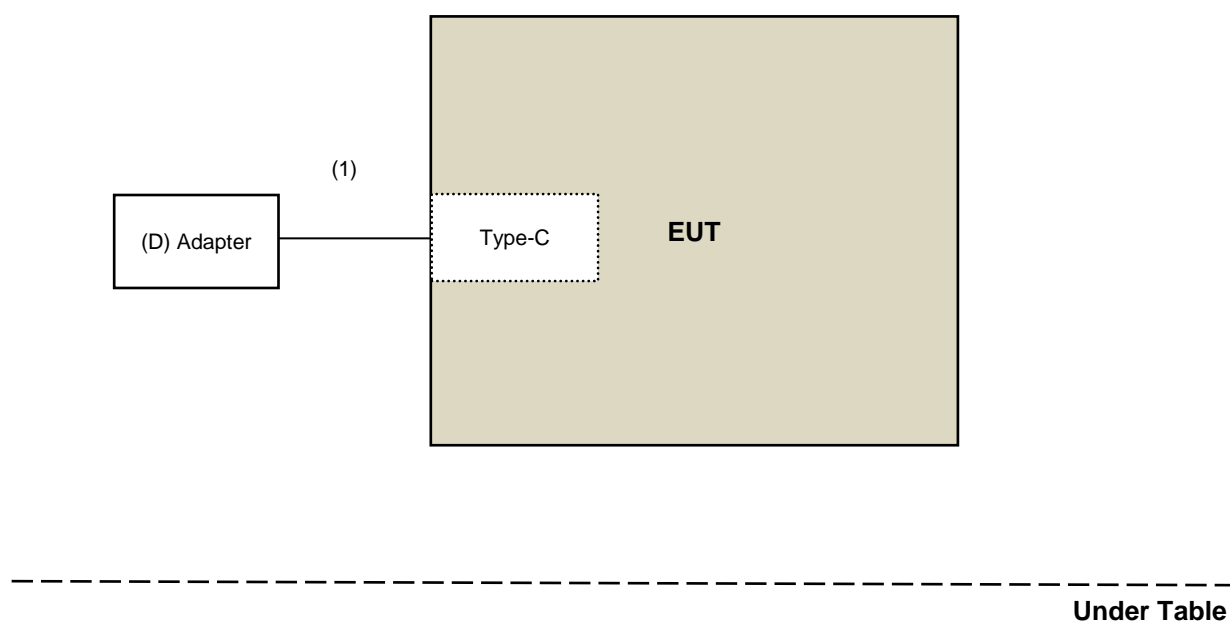

### 3.8 Configuration of Peripheral Devices and Cable Connections

ID	Product	Brand	Model No.	Serial No.	FCC ID	Remarks
A	Extender	ALIENWARE	771-02227L-A01	N/A	N/A	Supplied by applicant
B	NB	DELL	Latitude 5420	N/A	N/A	Provided by Lab
C	NB Adapter	Dell	HA65NM190	N/A	N/A	Provided by Lab
D	Adapter	Apple	A1385	N/A	N/A	Provided by Lab

ID	Cable Descriptions	Qty.	Length(m)	Shielding(Yes/No)	Cores(Qty.)	Remarks
1	USB cable	1	2.0	Y	0	Supplied by applicant
2	DC Cable	1	1.8	Y	0	Provided by Lab
3	AC Cable	1	1	N	0	Provided by Lab

## 4 Test Instruments

The calibration interval of the all test instruments are 12 months and the calibrations are traceable to NML/ROC and NIST/USA.

### 4.1 RF Output Power

Description Manufacturer	Model No.	Serial No.	Calibrated Date	Calibrated Until
MIMO Powermeasurement Test set (4X4) KEYSIGHT	U2021XA	U2021XA_001	2022/6/13	2023/6/12
MXG Vector Signal Generator KEYSIGHT	N5182B	MY53052658	2022/5/9	2023/5/8
Peak Power meter Anritsu	ML2495A	0842014	2022/4/27	2023/4/26
Pulse Power Sensor Anritsu	MA2411B	0738404	2022/4/27	2023/4/26
Spectrum Analyzer KEYSIGHT	N9030A	MY54490260	2022/7/14	2023/7/13
Spectrum Analyzer R&S	FSV40	101042	2022/9/5	2023/9/4
		101544	2022/5/9	2023/5/8
Temperature & Humidity Chamber TERCHY	MHU-225AU	920409	2022/6/27	2023/6/26
Voltage Meter FLUKE	179	89610322	2022/10/3	2023/10/2

Notes:

1. The test was performed in LK - Oven
2. Tested Date: 2023/1/10

### 4.2 Power Spectral Density

Refer to section 4.1 to get information of the instruments.

### 4.3 6 dB Bandwidth

Refer to section 4.1 to get information of the instruments.

### 4.4 Conducted Out of Band Emissions

Refer to section 4.1 to get information of the instruments.

#### 4.5 AC Power Conducted Emissions

Description Manufacturer	Model No.	Serial No.	Calibrated Date	Calibrated Until
50 ohm terminal LYNICS	0900510	E1-011285	2022/9/19	2023/9/18
		E1-011286	2022/9/19	2023/9/18
50 Ohms Terminator LYNICS	0900510	E1-01-305	2022/2/9	2023/2/8
Attenuator STI	STI02-2200-10	NO.4	2022/9/2	2023/9/1
DC LISN R&S	ESH3-Z6	100219	2022/8/2	2023/8/1
		844950/018	2022/8/2	2023/8/1
DC LISN Schwarzbeck	NNLK 8121	8121-808	2022/4/29	2023/4/28
High Voltage Probe Schwarzbeck	TK9420	00982	2022/12/14	2023/12/13
Isolation Transformer Erika Fiedler	D-65396	017	2022/9/8	2023/9/7
LISN R&S	ENV216	101196	2022/5/24	2023/5/23
LISN Schwarzbeck	NNLK 8121	8121-00759	2022/8/18	2023/8/17
		8121-731	2022/5/26	2023/5/25
	NNLK8129	8129229	2022/6/8	2023/6/7
	NNLK 8128	8128-244	2022/11/8	2023/11/7
RF Coaxial Cable Commate	5D-FB	Cable-CO5-01	2022/1/28	2023/1/27
Software BVADT	Cond_V7.3.7.4	N/A	N/A	N/A
Test Receiver R&S	ESR3	102412	2022/12/21	2023/12/20

Notes:

1. The test was performed in Linkou Conduction 5.
2. Tested Date: 2022/12/29



#### 4.6 Unwanted Emissions below 1 GHz

Description Manufacturer	Model No.	Serial No.	Calibrated Date	Calibrated Until
* LOOP ANTENNA EMCI	LPA600	270	2021/9/2	2023/9/1
Bi_Log Antenna Schwarzbeck	VULB 9168	137	2022/10/21	2023/10/20
Coupling/Dcoupling Network Schwarzbeck	CDNE-M2	00097	2022/6/1	2023/5/31
	CDNE-M3	00091	2022/6/1	2023/5/31
Pre_Amplifier EMCI	EMC001340	980269	2022/6/28	2023/6/27
Pre_Amplifier HP	8447D	2432A03504	2022/2/17	2023/2/16
RF Coaxial Cable Pacific	8D-FB	Cable-CH6-02	2022/6/30	2023/6/29
Software BVADT	Radiated_V7.7.1.1.1	N/A	N/A	N/A
	Radiated_V8.7.08	N/A	N/A	N/A
Spectrum Analyzer R&S	FSV40	101544	2022/5/9	2023/5/8
Test Receiver Agilent	N9038A	MY51210129	2022/4/8	2023/4/7
		MY51210137	2022/6/9	2023/6/8
Tower ADT	AT100	0306	N/A	N/A
Turn Table ADT	TT100	0306	N/A	N/A

Notes:

- \* The calibration interval of the above test instruments is 24 months and the calibrations are traceable to NML/ROC and NIST/USA
- The test was performed in Linkou 966 Chamber 6 (CH 6).
- Tested Date: 2023/1/6

#### 4.7 Unwanted Emissions above 1 GHz

Description Manufacturer	Model No.	Serial No.	Calibrated Date	Calibrated Until
Band Pass Filter MICRO-TRONICS	BRM17690	005	2022/5/26	2023/5/25
Boresight antenna tower fixture BV	BAF-02	6	N/A	N/A
High Pass Filter Wainwright Instruments	WHK 3.1/18G-10SS	SN 8	2022/5/26	2023/5/25
Horn Antenna EMCO	3115	00028257	2022/11/13	2023/11/12
Horn Antenna ETS-Lindgren	3117-PA	00215857	2022/11/13	2023/11/12
Horn Antenna Schwarzbeck	BBHA 9170	212	2022/10/20	2023/10/19
Notch Filter MICRO-TRONICS	BRC50703-01	010	2022/5/26	2023/5/25
Pre-amplifier HP	8449B	3008A01201	2022/2/17	2023/2/16
Pre-amplifier (18GHz-40GHz) EMCI	EMC184045B	980175	2022/9/3	2023/9/2
Pre_Amplifier EMCI	EMC0126545	980076	2022/2/17	2023/2/16
	EMC184045B	980235	2022/2/17	2023/2/16
RF Coaxial Cable EM	EM102-KMKM-3.5+1M	EM102-KMKM-3.5+1M-01	2022/7/7	2023/7/6
RF Coaxial Cable EMCI	EMC104	190801	2022/7/7	2023/7/6
		190804	2022/7/7	2023/7/6
RF Coaxial Cable HUBER SUHNER	SF-104	Cable-CH6-01	2022/9/20	2023/9/19
Software BVADT	Radiated_V7.7.1.1.1	N/A	N/A	N/A
	Radiated_V8.7.08	N/A	N/A	N/A
Spectrum Analyzer R&S	FSV40	101042	2022/9/5	2023/9/4
		101544	2022/5/9	2023/5/8
Test Receiver Agilent	N9038A	MY51210129	2022/4/8	2023/4/7
Tower ADT	AT100	0306	N/A	N/A
Turn Table ADT	TT100	0306	N/A	N/A

Notes:

1. The test was performed in Linkou 966 Chamber 6 (CH 6).
2. Tested Date: 2022/12/27

## 5 Limits of Test Items

### 5.1 RF Output Power

For systems using digital modulation in the 2400–2483.5 MHz bands: 1 Watt (30 dBm)

### 5.2 Power Spectral Density

The Maximum of Power Spectral Density Measurement is 8 dBm in any 3 kHz.

### 5.3 6 dB Bandwidth

The minimum of 6 dB Bandwidth Measurement is 0.5 MHz.

### 5.4 Conducted Out of Band Emissions

Below 20 dB of the highest emission level of operating band (in 100 kHz Resolution Bandwidth).

### 5.5 AC Power Conducted Emissions

Frequency (MHz)	Conducted Limit (dBuV)	
	Quasi-peak	Average
0.15 - 0.5	66 - 56	56 - 46
0.50 - 5.0	56	46
5.0 - 30.0	60	50

Notes:

1. The lower limit shall apply at the transition frequencies.
2. The limit decreases in line with the logarithm of the frequency in the range of 0.15 to 0.50 MHz.

### 5.6 Unwanted Emissions below 1 GHz

Radiated emissions up to 1 GHz which fall in the restricted bands must comply with the radiated emission limits specified as below table. Other emissions shall be at least 20 dB below the highest level of the desired power:

Frequencies (MHz)	Field Strength (microvolts/meter)	Measurement Distance (meters)
0.009 ~ 0.490	2400/F(kHz)	300
0.490 ~ 1.705	24000/F(kHz)	30
1.705 ~ 30.0	30	30
30 ~ 88	100	3
88 ~ 216	150	3
216 ~ 960	200	3
Above 960	500	3

Notes:

1. The lower limit shall apply at the transition frequencies.
2. Emission level (dBuV/m) = 20 log Emission level (uV/m).

## 5.7 Unwanted Emissions above 1 GHz

Radiated emissions above 1 GHz which fall in the restricted bands must comply with the radiated emission limits specified as below table. Other emissions shall be at least 20 dB below the highest level of the desired power:

Frequencies (MHz)	Field Strength (microvolts/meter)	Measurement Distance (meters)
Above 960	500	3

Notes:

1. The lower limit shall apply at the transition frequencies.
2. Emission level (dBuV/m) = 20 log Emission level (uV/m).
3. For frequencies above 1000 MHz, the field strength limits are based on average detector, however, the peak field strength of any emission shall not exceed the maximum permitted average limits, specified above by more than 20 dB under any condition of modulation.

## 6 Test Arrangements

### 6.1 RF Output Power

#### 6.1.1 Test Setup

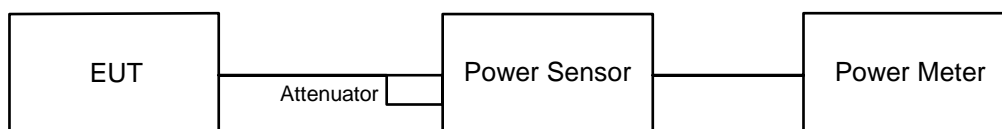

#### 6.1.2 Test Procedure

##### Peak Power:

A peak power sensor was used on the output port of the EUT. A power meter was used to read the response of the peak power sensor. Record the power level.

##### Average Power:

Average power sensor was used to perform output power measurement, trigger and gating function of wide band power meter is enabled to measure max output power of TX on burst. Duty factor is not added to measured value.

### 6.2 Power Spectral Density

#### 6.2.1 Test Setup

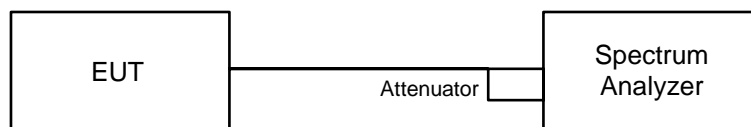

#### 6.2.2 Test Procedure

- a. Set analyzer center frequency to DTS channel center frequency.
- b. Set the span to 1.5 times the DTS bandwidth.
- c. Set the RBW to: 3 kHz.
- d. Set the VBW  $\geq 3 \times$  RBW.
- e. Detector = peak.
- f. Sweep time = auto couple.
- g. Trace mode = max hold.
- h. Allow trace to fully stabilize.
- i. Use the peak marker function to determine the maximum amplitude level within the RBW.

### 6.3 6 dB Bandwidth

#### 6.3.1 Test Setup

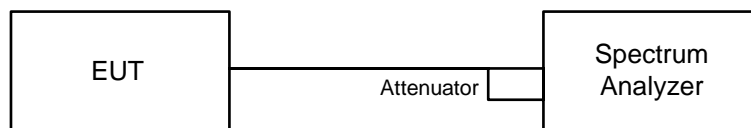

#### 6.3.2 Test Procedure

- Set resolution bandwidth (RBW) = 100 kHz.
- Set the video bandwidth (VBW)  $\geq 3 \times$  RBW, Detector = Peak.
- Trace mode = max hold.
- Sweep = auto couple.
- Measure the maximum width of the emission that is constrained by the frequencies associated with the two amplitude points (upper and lower) that are attenuated by 6 dB relative to the maximum level measured in the fundamental emission.

### 6.4 Conducted Out of Band Emissions

#### 6.4.1 Test Setup

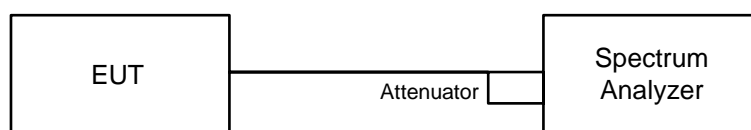

#### 6.4.2 Test Procedure

##### MEASUREMENT PROCEDURE REF

- Set the RBW = 100 kHz.
- Set the VBW  $\geq 300$  kHz.
- Detector = peak.
- Sweep time = auto couple.
- Trace mode = max hold.
- Allow trace to fully stabilize.
- Use the peak marker function to determine the maximum power level in any 100 kHz band segment within the fundamental EBW.

##### MEASUREMENT PROCEDURE OOB

- Set RBW = 100 kHz.
- Set VBW  $\geq 300$  kHz.
- Detector = peak.
- Sweep = auto couple.
- Trace Mode = max hold.
- Allow trace to fully stabilize.
- Use the peak marker function to determine the maximum amplitude level.

## 6.5 AC Power Conducted Emissions

### 6.5.1 Test Setup

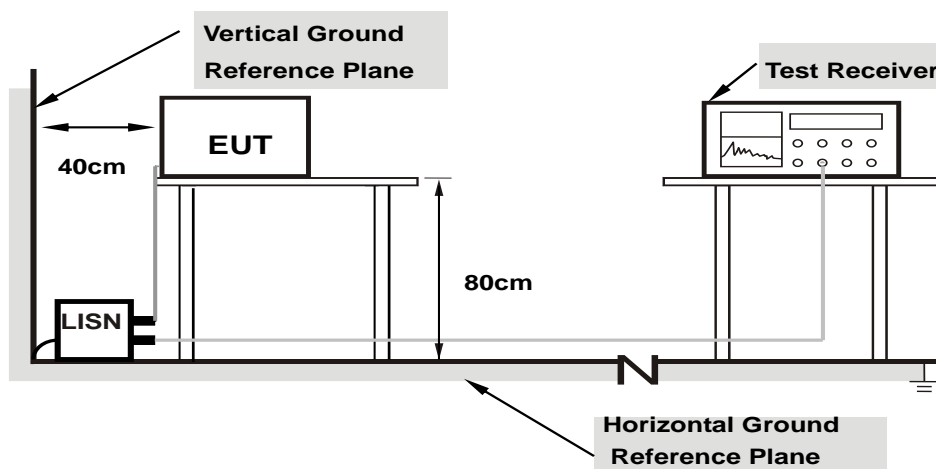

**Note: 1.Support units were connected to second LISN.**

For the actual test configuration, please refer to the attached file (Test Setup Photo).

### 6.5.2 Test Procedure

- The EUT was placed on a 0.8 meter to the top of table and placed 0.4 meters from the conducting wall of the shielded room with EUT being connected to the power mains through a line impedance stabilization network (LISN). Other support units were connected to the power mains through another LISN. The two LISNs provide 50 ohm/ 50 uH of coupling impedance for the measuring instrument.
- Both lines of the power mains connected to the EUT were checked for maximum conducted interference.
- The frequency range from 150 kHz to 30 MHz was searched. Emission levels under (Limit – 20 dB) was not recorded.

Note: The resolution bandwidth and video bandwidth of test receiver is 9 kHz for quasi-peak detection (QP) and average detection (AV) at frequency 0.15 MHz-30 MHz.

## 6.6 Unwanted Emissions below 1 GHz

### 6.6.1 Test Setup

#### For Radiated emission below 30 MHz

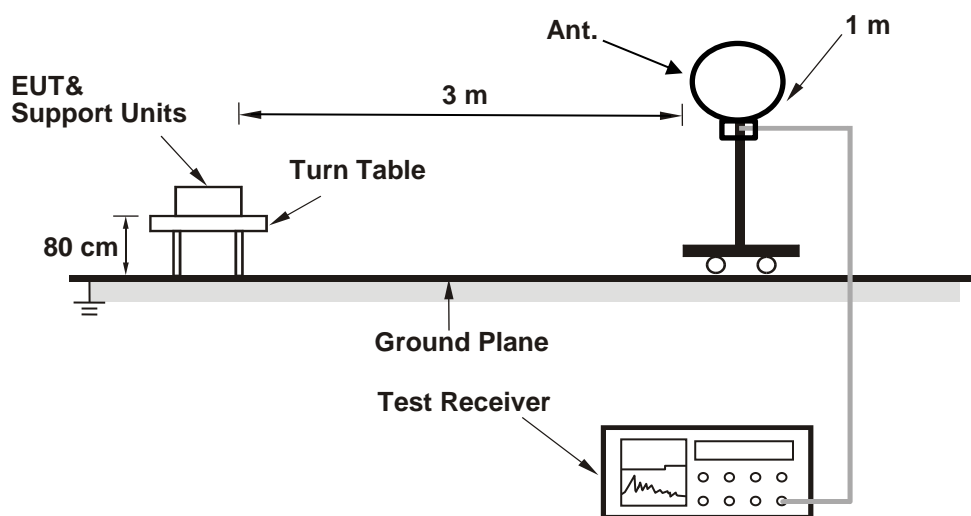

#### For Radiated emission above 30 MHz

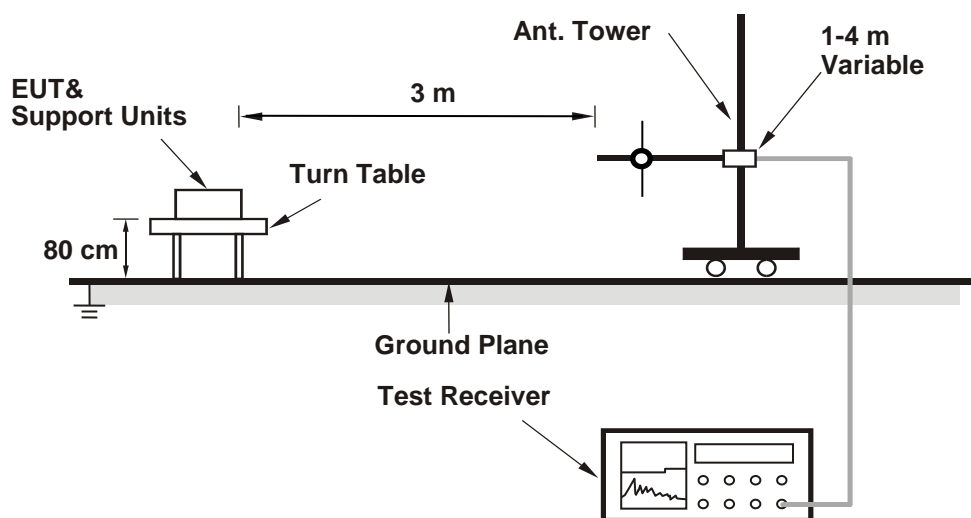

For the actual test configuration, please refer to the attached file (Test Setup Photo).



## 6.6.2 Test Procedure

### For Radiated emission below 30 MHz

- a. The EUT was placed on the top of a rotating table 0.8 meters above the ground at 3 meter chamber room for test. The table was rotated 360 degrees to determine the position of the highest radiation.
- b. The EUT was set 3 meters away from the interference-receiving antenna, which was mounted on the top of a variable-height antenna tower.
- c. Parallel, perpendicular, and ground-parallel orientations of the antenna are set to make the measurement.
- d. For each suspected emission, the EUT was arranged to its worst case and the rotatable table was turned from 0 degrees to 360 degrees to find the maximum reading.
- e. The test-receiver system was set to Quasi-Peak Detect Function and Specified Bandwidth with Maximum Hold Mode, except for the frequency band (9 kHz to 90 kHz and 110 kHz to 490 kHz) set to average detect function and peak detect function.

#### Notes:

1. The resolution bandwidth and video bandwidth of test receiver/spectrum analyzer is 200 Hz at frequency below 150 kHz.
2. The resolution bandwidth and video bandwidth of test receiver/spectrum analyzer is 9 kHz or 10 kHz at frequency (150 kHz to 30 MHz).
3. All modes of operation were investigated and the worst-case emissions are reported.

### For Radiated emission above 30 MHz

- a. The EUT was placed on the top of a rotating table 0.8 meters above the ground at 3 meter chamber room for test. The table was rotated 360 degrees to determine the position of the highest radiation.
- b. The EUT was set 3 meters away from the interference-receiving antenna, which was mounted on the top of a variable-height antenna tower.
- c. The height of antenna is varied from one meter to four meters above the ground to determine the maximum value of the field strength. Both horizontal and vertical polarizations of the antenna are set to make the measurement.
- d. For each suspected emission, the EUT was arranged to its worst case and then the antenna was tuned to heights from 1 meter to 4 meters and the rotatable table was turned from 0 degrees to 360 degrees to find the maximum reading.
- e. The test-receiver system was set to quasi-peak detect function and specified bandwidth with maximum hold mode when the test frequency is below 1 GHz.

#### Notes:

1. The resolution bandwidth and video bandwidth of test receiver/spectrum analyzer is 120 kHz for Quasi-peak detection (QP) at frequency below 1 GHz.
2. All modes of operation were investigated and the worst-case emissions are reported.

## 6.7 Unwanted Emissions above 1 GHz

### 6.7.1 Test Setup

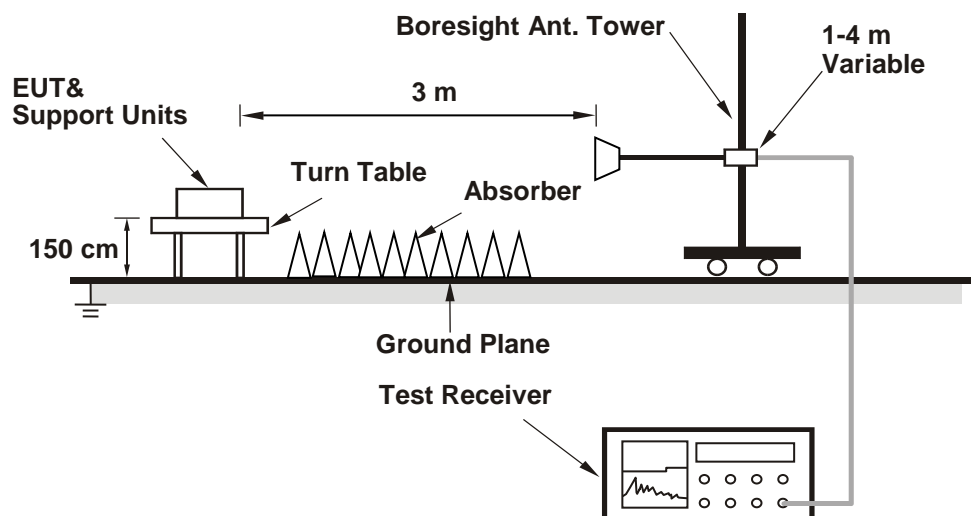

For the actual test configuration, please refer to the attached file (Test Setup Photo).

### 6.7.2 Test Procedure

- The EUT was placed on the top of a rotating table 1.5 meters above the ground at 3 meter chamber room for test. The table was rotated 360 degrees to determine the position of the highest radiation.
- The EUT was set 3 meters away from the interference-receiving antenna, which was mounted on the top of a variable-height antenna tower.
- The height of antenna is varied from one meter to four meters above the ground to determine the maximum value of the field strength. Both horizontal and vertical polarizations of the antenna are set to make the measurement.
- For each suspected emission, the EUT was arranged to its worst case and then the antenna was tuned to heights from 1 meter to 4 meters and the rotatable table was turned from 0 degrees to 360 degrees to find the maximum reading.
- The test-receiver system was set to peak and average detects function and specified bandwidth with maximum hold mode when the test frequency is above 1 GHz. If the peak reading value also meets average limit, measurement with the average detector is unnecessary.

#### Notes:

- The resolution bandwidth of test receiver/spectrum analyzer is 1 MHz and the video bandwidth is 3 MHz for Peak detection (PK) and Average detection (AV) at frequency above 1 GHz.
- For fundamental and harmonic signal measurement, the resolution bandwidth of test receiver/spectrum analyzer is 1 MHz and the video bandwidth is  $\geq 1/T$  (Duty cycle < 98%) or 10 Hz (Duty cycle  $\geq 98\%$ ) for Average detection (AV) at frequency above 1 GHz.
- All modes of operation were investigated and the worst-case emissions are reported.

## 7 Test Results of Test Item

### 7.1 RF Output Power

Input Power:	120 Vac, 60 Hz	Environmental Conditions:	25°C, 76% RH	Tested By:	Dalen Dai
--------------	----------------	---------------------------	--------------	------------	-----------

#### Mode A

#### For Peak Power

#### BT-LE 1M

Chan.	Chan. Freq. (MHz)	Peak Power (mW)	Peak Power (dBm)	Power Limit (dBm)	Test Result
0	2402	1.556	1.92	30	Pass
19	2440	1.799	2.55	30	Pass
39	2480	2.004	3.02	30	Pass

Note: The antenna gain is 5.78 dBi < 6 dBi, so the output power limit shall not be reduced.

#### For Average Power

#### BT-LE 1M

Chan.	Chan. Freq. (MHz)	Average Power (mW)	Average Power (dBm)
0	2402	1.531	1.85
19	2440	1.766	2.47
39	2480	1.963	2.93

## 7.2 Power Spectral Density

Input Power:	120 Vac, 60 Hz	Environmental Conditions:	25°C, 76% RH	Tested By:	Dalen Dai
--------------	----------------	---------------------------	--------------	------------	-----------

### Mode A

#### BT-LE 1M

TX chain	Channel	Freq. (MHz)	PSD (dBm/3kHz)	PSD Limit (dBm/3kHz)	Pass / Fail
Chain 0	0	2402	-14.3	8	Pass
	19	2440	-13.28	8	Pass
	39	2480	-12.92	8	Pass

Note: The antenna gain is 5.78 dBi < 6 dBi, so the power density limit shall not be reduced.

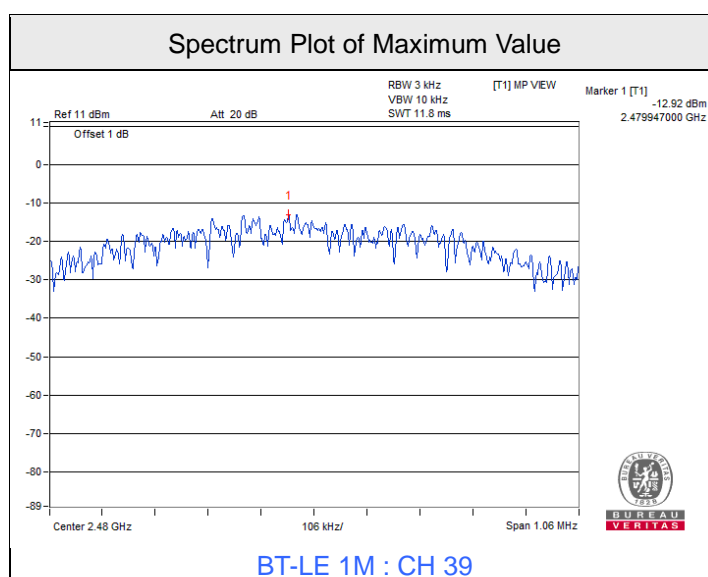

### 7.3 6 dB Bandwidth

Input Power:	120 Vac, 60 Hz	Environmental Conditions:	25°C, 76% RH	Tested By:	Dalen Dai
--------------	----------------	---------------------------	--------------	------------	-----------

#### Mode A

#### BT-LE 1M

Channel	Frequency (MHz)	6dB Bandwidth (MHz)	Minimum Limit (MHz)	Test Result
0	2402	0.7	0.5	Pass
19	2440	0.71	0.5	Pass
39	2480	0.71	0.5	Pass

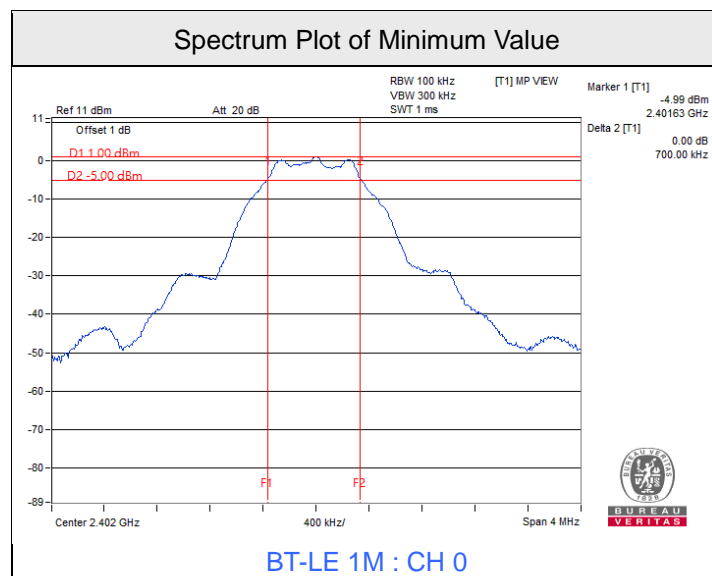



### 7.4 Conducted Out of Band Emissions

Input Power:	120 Vac, 60 Hz	Environmental Conditions:	25°C, 76% RH	Tested By:	Dalen Dai
--------------	----------------	---------------------------	--------------	------------	-----------

#### Mode A

#### BT-LE 1M

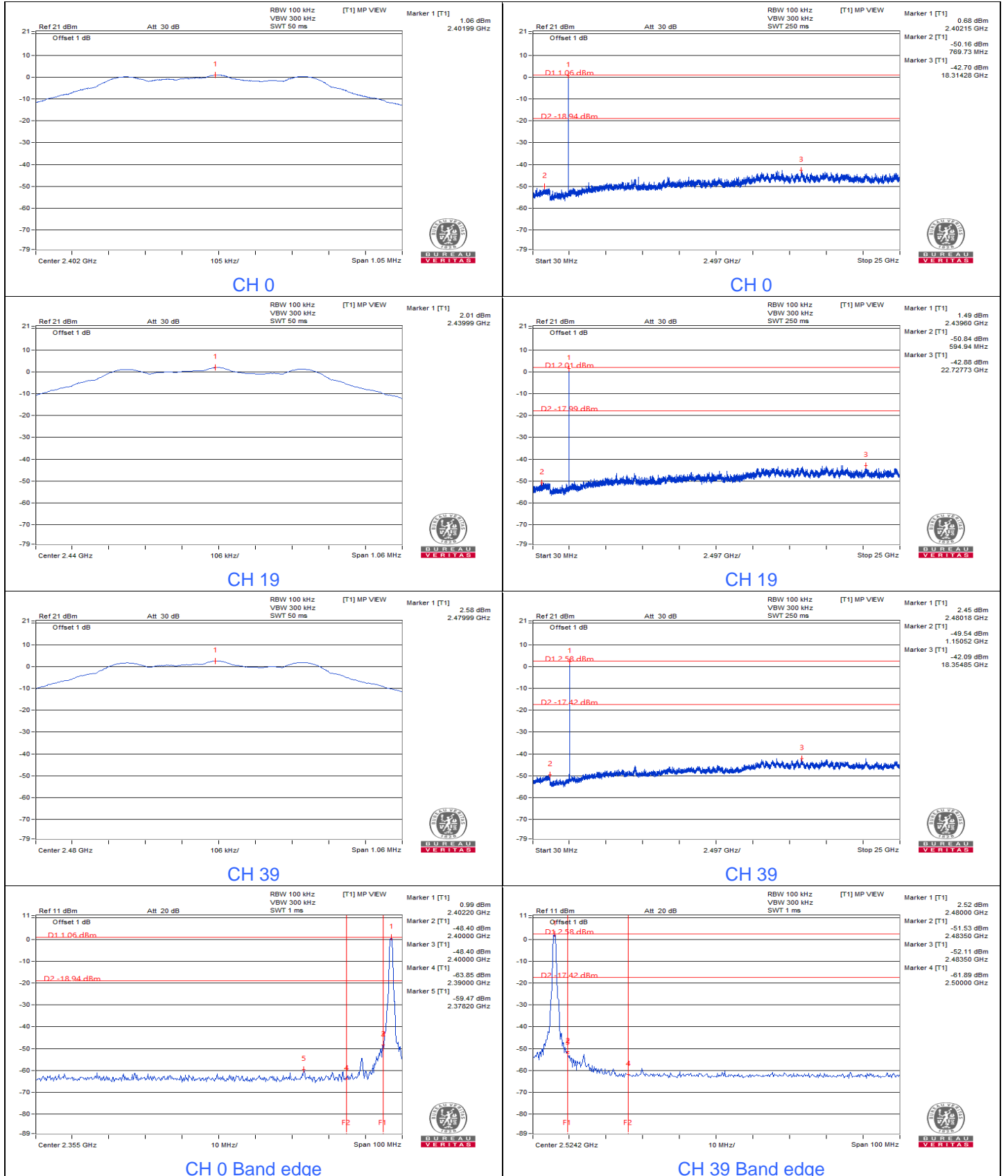

## 7.5 AC Power Conducted Emissions

### Mode A

RF Mode	BT-LE 1M	Channel	CH 39 : 2480 MHz
Frequency Range	150 kHz ~ 30 MHz	Detector Function & Resolution Bandwidth	Quasi-Peak (QP) / Average (AV), 9 kHz
Input Power	120 Vac, 60 Hz	Environmental Conditions	25°C, 75% RH
Tested By	Ian Chang		

#### Phase Of Power : Line (L)

No	Frequency (MHz)	Correction Factor (dB)	Reading Value (dBuV)		Emission Level (dBuV)		Limit (dBuV)		Margin (dB)	
			Q.P.	AV.	Q.P.	AV.	Q.P.	AV.	Q.P.	AV.
1	0.15687	9.92	43.25	24.10	53.17	34.02	65.63	55.63	-12.46	-21.61
2	0.34200	9.92	21.37	8.19	31.29	18.11	59.15	49.15	-27.86	-31.04
3	0.50000	9.92	28.52	22.65	38.44	32.57	56.00	46.00	-17.56	-13.43
4	1.50799	9.96	17.63	10.71	27.59	20.67	56.00	46.00	-28.41	-25.33
5	3.42400	9.99	23.96	13.90	33.95	23.89	56.00	46.00	-22.05	-22.11
6	9.53200	10.17	24.48	18.83	34.65	29.00	60.00	50.00	-25.35	-21.00

#### Remarks:

1. Q.P. and AV. are abbreviations of quasi-peak and average individually.
2. The emission levels of other frequencies were very low against the limit.
3. Margin value = Emission level – Limit value
4. Correction factor = Insertion loss + Cable loss
5. Emission Level = Correction Factor + Reading Value

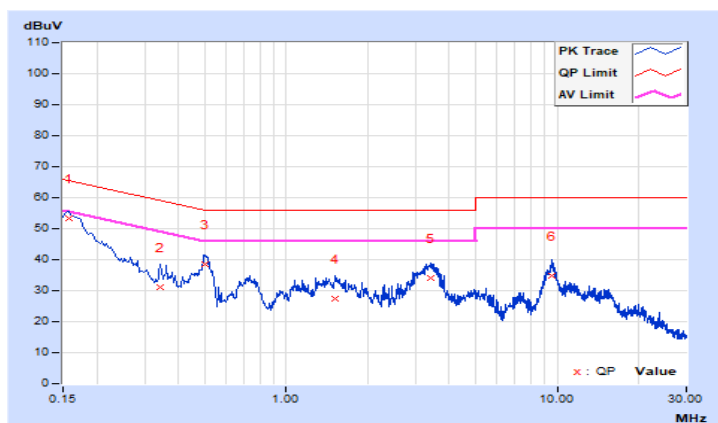

<b>RF Mode</b>	BT-LE 1M	<b>Channel</b>	CH 39 : 2480 MHz
<b>Frequency Range</b>	150 kHz ~ 30 MHz	<b>Detector Function &amp; Resolution Bandwidth</b>	Quasi-Peak (QP) / Average (AV), 9 kHz
<b>Input Power</b>	120 Vac, 60 Hz	<b>Environmental Conditions</b>	25°C, 75% RH
<b>Tested By</b>	Ian Chang		

Phase Of Power : Neutral (N)										
No	Frequency (MHz)	Correction Factor (dB)	Reading Value (dBuV)		Emission Level (dBuV)		Limit (dBuV)		Margin (dB)	
			Q.P.	AV.	Q.P.	AV.	Q.P.	AV.	Q.P.	AV.
1	0.15000	9.93	42.87	25.41	52.80	35.34	66.00	56.00	-13.20	-20.66
2	0.50000	9.93	30.86	23.33	40.79	33.26	56.00	46.00	-15.21	-12.74
3	0.77200	9.94	18.72	12.43	28.66	22.37	56.00	46.00	-27.34	-23.63
4	1.52798	9.97	19.64	12.91	29.61	22.88	56.00	46.00	-26.39	-23.12
5	3.23200	10.00	23.03	13.09	33.03	23.09	56.00	46.00	-22.97	-22.91
6	9.66800	10.18	19.73	13.78	29.91	23.96	60.00	50.00	-30.09	-26.04

**Remarks:**

1. Q.P. and AV. are abbreviations of quasi-peak and average individually.
2. The emission levels of other frequencies were very low against the limit.
3. Margin value = Emission level – Limit value
4. Correction factor = Insertion loss + Cable loss
5. Emission Level = Correction Factor + Reading Value

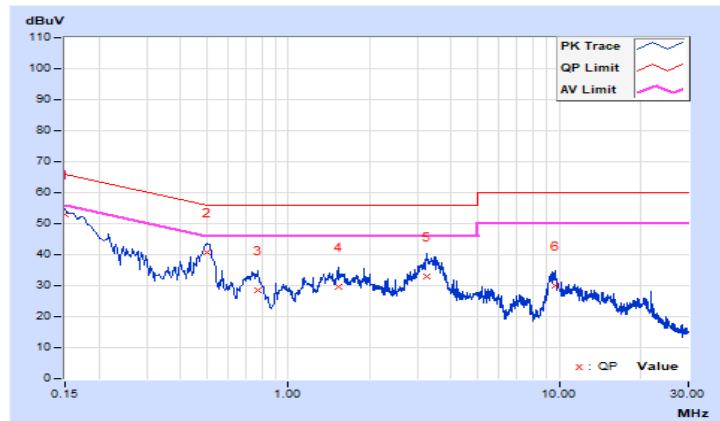



## Mode B

RF Mode	BT-LE 1M	Channel	CH 39 : 2480 MHz
Frequency Range	150 kHz ~ 30 MHz	Detector Function & Resolution Bandwidth	Quasi-Peak (QP) / Average (AV), 9 kHz
Input Power	120 Vac, 60 Hz	Environmental Conditions	25°C, 75% RH
Tested By	Ian Chang		

### Phase Of Power : Line (L)

No	Frequency (MHz)	Correction Factor (dB)	Reading Value (dBuV)		Emission Level (dBuV)		Limit (dBuV)		Margin (dB)	
			Q.P.	AV.	Q.P.	AV.	Q.P.	AV.	Q.P.	AV.
1	0.16600	9.93	36.74	18.89	46.67	28.82	65.16	55.16	-18.49	-26.34
2	0.24941	9.94	32.11	15.95	42.05	25.89	61.78	51.78	-19.73	-25.89
3	0.74400	9.96	28.38	17.59	38.34	27.55	56.00	46.00	-17.66	-18.45
4	2.05600	10.03	20.19	10.90	30.22	20.93	56.00	46.00	-25.78	-25.07
5	3.68800	10.11	19.58	10.71	29.69	20.82	56.00	46.00	-26.31	-25.18
6	8.20400	10.30	19.06	12.15	29.36	22.45	60.00	50.00	-30.64	-27.55

### Remarks:

1. Q.P. and AV. are abbreviations of quasi-peak and average individually.
2. The emission levels of other frequencies were very low against the limit.
3. Margin value = Emission level – Limit value
4. Correction factor = Insertion loss + Cable loss
5. Emission Level = Correction Factor + Reading Value

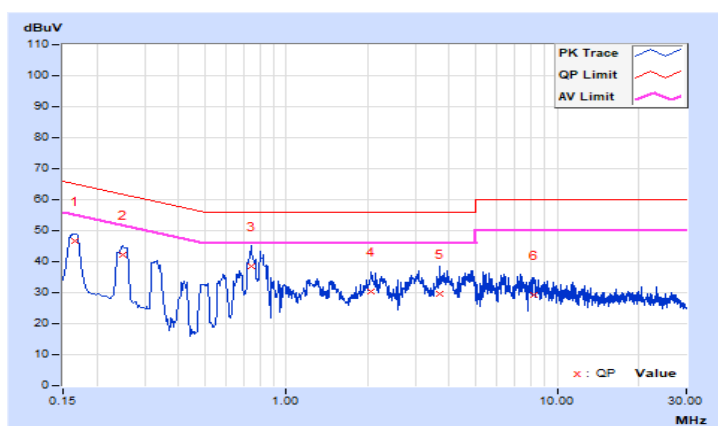

RF Mode	BT-LE 1M	Channel	CH 39 : 2480 MHz
Frequency Range	150 kHz ~ 30 MHz	Detector Function & Resolution Bandwidth	Quasi-Peak (QP) / Average (AV), 9 kHz
Input Power	120 Vac, 60 Hz	Environmental Conditions	25°C, 75% RH
Tested By	Ian Chang		

Phase Of Power : Neutral (N)										
No	Frequency (MHz)	Correction Factor (dB)	Reading Value (dBuV)		Emission Level (dBuV)		Limit (dBuV)		Margin (dB)	
			Q.P.	AV.	Q.P.	AV.	Q.P.	AV.	Q.P.	AV.
1	0.16190	9.94	36.66	16.44	46.60	26.38	65.37	55.37	-18.77	-28.99
2	0.25400	9.95	31.63	11.44	41.58	21.39	61.63	51.63	-20.05	-30.24
<b>3</b>	<b>0.74000</b>	<b>9.98</b>	<b>28.66</b>	<b>18.80</b>	<b>38.64</b>	<b>28.78</b>	<b>56.00</b>	<b>46.00</b>	<b>-17.36</b>	<b>-17.22</b>
4	1.44000	10.01	19.05	6.84	29.06	16.85	56.00	46.00	-26.94	-29.15
5	3.04000	10.09	21.35	13.19	31.44	23.28	56.00	46.00	-24.56	-22.72
6	7.18400	10.26	20.88	13.00	31.14	23.26	60.00	50.00	-28.86	-26.74

**Remarks:**

1. Q.P. and AV. are abbreviations of quasi-peak and average individually.
2. The emission levels of other frequencies were very low against the limit.
3. Margin value = Emission level – Limit value
4. Correction factor = Insertion loss + Cable loss
5. Emission Level = Correction Factor + Reading Value

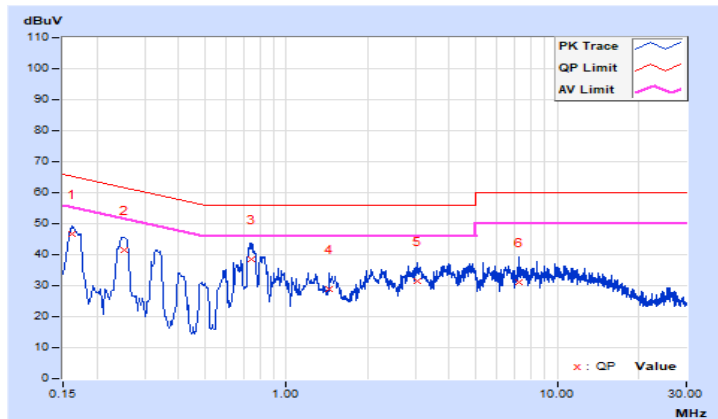

**Mode C**

<b>Frequency Range</b>	150 kHz ~ 30 MHz	<b>Detector Function &amp; Resolution Bandwidth</b>	Quasi-Peak (QP) / Average (AV), 9 kHz
<b>Input Power</b>	120 Vac, 60 Hz	<b>Environmental Conditions</b>	25°C, 75% RH
<b>Tested By</b>	Ian Chang		

Phase Of Power : Line (L)										
No	Frequency (MHz)	Correction Factor (dB)	Reading Value (dBuV)		Emission Level (dBuV)		Limit (dBuV)		Margin (dB)	
			Q.P.	AV.	Q.P.	AV.	Q.P.	AV.	Q.P.	AV.
1	0.15563	9.92	42.20	23.84	52.12	33.76	65.69	55.69	-13.57	-21.93
<b>2</b>	<b>0.50398</b>	<b>9.92</b>	<b>28.32</b>	<b>22.76</b>	<b>38.24</b>	<b>32.68</b>	<b>56.00</b>	<b>46.00</b>	<b>-17.76</b>	<b>-13.32</b>
3	0.74000	9.93	19.97	14.50	29.90	24.43	56.00	46.00	-26.10	-21.57
4	1.51995	9.96	17.41	10.36	27.37	20.32	56.00	46.00	-28.63	-25.68
5	3.34000	9.99	22.99	13.21	32.98	23.20	56.00	46.00	-23.02	-22.80
6	9.52800	10.17	23.88	18.10	34.05	28.27	60.00	50.00	-25.95	-21.73

**Remarks:**

1. Q.P. and AV. are abbreviations of quasi-peak and average individually.
2. The emission levels of other frequencies were very low against the limit.
3. Margin value = Emission level – Limit value
4. Correction factor = Insertion loss + Cable loss
5. Emission Level = Correction Factor + Reading Value

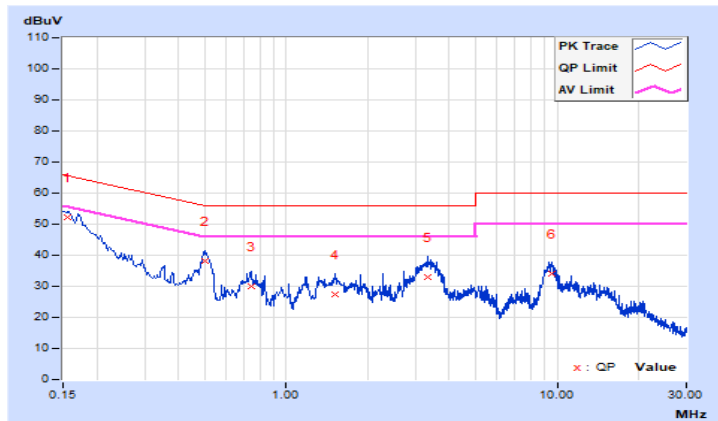

<b>Frequency Range</b>	150 kHz ~ 30 MHz	<b>Detector Function &amp; Resolution Bandwidth</b>	Quasi-Peak (QP) / Average (AV), 9 kHz
<b>Input Power</b>	120 Vac, 60 Hz	<b>Environmental Conditions</b>	25°C, 75% RH
<b>Tested By</b>	Ian Chang		

Phase Of Power : Neutral (N)										
No	Frequency (MHz)	Correction Factor (dB)	Reading Value (dBuV)		Emission Level (dBuV)		Limit (dBuV)		Margin (dB)	
			Q.P.	AV.	Q.P.	AV.	Q.P.	AV.	Q.P.	AV.
1	0.15400	9.93	40.91	25.12	50.84	35.05	65.78	55.78	-14.94	-20.73
2	0.50798	9.93	30.70	22.66	40.63	32.59	56.00	46.00	-15.37	-13.41
3	0.72000	9.94	19.43	13.70	29.37	23.64	56.00	46.00	-26.63	-22.36
4	1.86400	9.98	16.47	9.62	26.45	19.60	56.00	46.00	-29.55	-26.40
5	3.33200	10.00	23.79	13.42	33.79	23.42	56.00	46.00	-22.21	-22.58
6	9.36400	10.17	19.86	13.82	30.03	23.99	60.00	50.00	-29.97	-26.01

**Remarks:**

1. Q.P. and AV. are abbreviations of quasi-peak and average individually.
2. The emission levels of other frequencies were very low against the limit.
3. Margin value = Emission level – Limit value
4. Correction factor = Insertion loss + Cable loss
5. Emission Level = Correction Factor + Reading Value

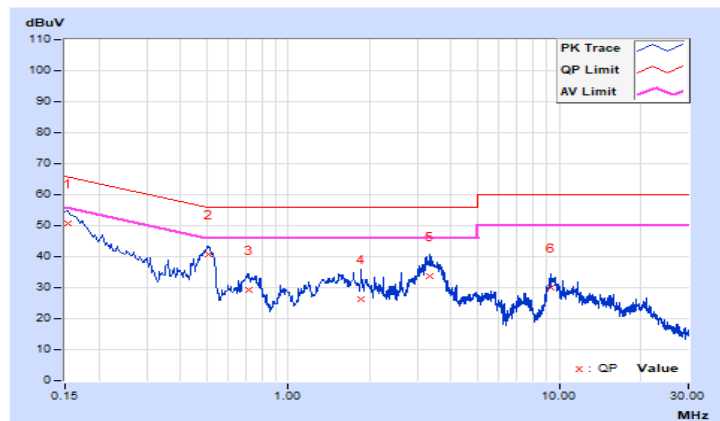

Mode D

Frequency Range	150 kHz ~ 30 MHz	Detector Function & Resolution Bandwidth	Quasi-Peak (QP) / Average (AV), 9 kHz
Input Power	120 Vac, 60 Hz	Environmental Conditions	25°C, 75% RH
Tested By	Ian Chang		

Phase Of Power : Line (L)										
No	Frequency (MHz)	Correction Factor (dB)	Reading Value (dBuV)		Emission Level (dBuV)		Limit (dBuV)		Margin (dB)	
			Q.P.	AV.	Q.P.	AV.	Q.P.	AV.	Q.P.	AV.
1	0.17000	9.93	35.08	14.94	45.01	24.87	64.96	54.96	-19.95	-30.09
2	0.24941	9.94	31.65	15.49	41.59	25.43	61.78	51.78	-20.19	-26.35
<b>3</b>	<b>0.74400</b>	<b>9.96</b>	<b>27.95</b>	<b>17.43</b>	<b>37.91</b>	<b>27.39</b>	<b>56.00</b>	<b>46.00</b>	<b>-18.09</b>	<b>-18.61</b>
4	2.08000	10.03	20.25	10.82	30.28	20.85	56.00	46.00	-25.72	-25.15
5	3.92400	10.12	19.44	11.17	29.56	21.29	56.00	46.00	-26.44	-24.71
6	6.38400	10.22	19.74	11.22	29.96	21.44	60.00	50.00	-30.04	-28.56

Remarks:

1. Q.P. and AV. are abbreviations of quasi-peak and average individually.
2. The emission levels of other frequencies were very low against the limit.
3. Margin value = Emission level – Limit value
4. Correction factor = Insertion loss + Cable loss
5. Emission Level = Correction Factor + Reading Value

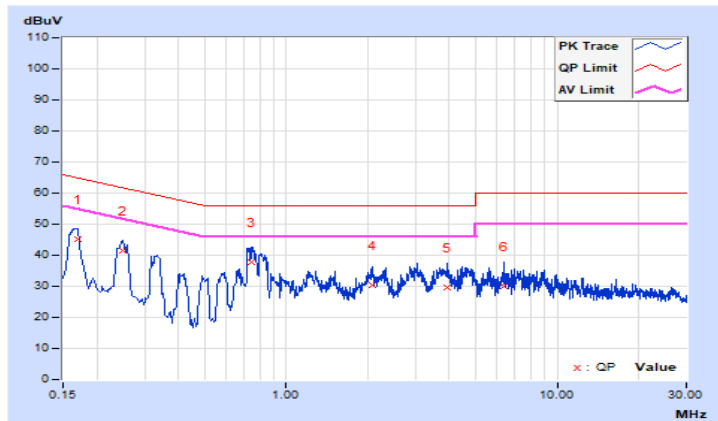

<b>Frequency Range</b>	150 kHz ~ 30 MHz	<b>Detector Function &amp; Resolution Bandwidth</b>	Quasi-Peak (QP) / Average (AV), 9 kHz
<b>Input Power</b>	120 Vac, 60 Hz	<b>Environmental Conditions</b>	25°C, 75% RH
<b>Tested By</b>	Ian Chang		

Phase Of Power : Neutral (N)										
No	Frequency (MHz)	Correction Factor (dB)	Reading Value (dBuV)		Emission Level (dBuV)		Limit (dBuV)		Margin (dB)	
			Q.P.	AV.	Q.P.	AV.	Q.P.	AV.	Q.P.	AV.
1	0.16932	9.94	34.88	14.61	44.82	24.55	64.99	54.99	-20.17	-30.44
2	0.24200	9.95	30.13	10.29	40.08	20.24	62.03	52.03	-21.95	-31.79
3	0.72400	9.98	24.93	13.94	34.91	23.92	56.00	46.00	-21.09	-22.08
4	1.46400	10.01	17.33	10.30	27.34	20.31	56.00	46.00	-28.66	-25.69
5	4.79200	10.16	21.46	14.89	31.62	25.05	56.00	46.00	-24.38	-20.95
6	9.84400	10.36	19.67	13.17	30.03	23.53	60.00	50.00	-29.97	-26.47

**Remarks:**

1. Q.P. and AV. are abbreviations of quasi-peak and average individually.
2. The emission levels of other frequencies were very low against the limit.
3. Margin value = Emission level – Limit value
4. Correction factor = Insertion loss + Cable loss
5. Emission Level = Correction Factor + Reading Value

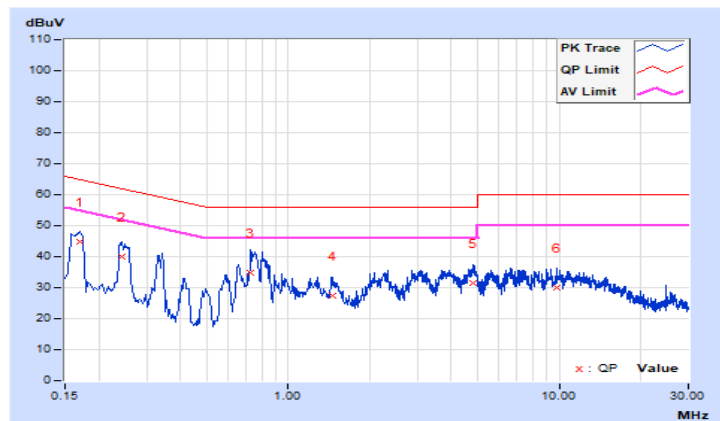

## 7.6 Unwanted Emissions below 1 GHz

### Mode A

RF Mode	BT-LE 1M	Channel	CH 39 : 2480 MHz
Frequency Range	30 MHz ~ 1 GHz	Detector Function & Bandwidth	(QP) RB = 120kHz
Input Power	120 Vac, 60 Hz	Environmental Conditions	19°C, 64% RH
Tested By	Jed Wu		

#### Antenna Polarity & Test Distance : Horizontal at 3 m

No	Frequency (MHz)	Emission Level (dBuV/m)	Limit (dBuV/m)	Margin (dB)	Antenna Height (m)	Table Angle (Degree)	Raw Value (dBuV)	Correction Factor (dB/m)
1	30.58	26.8 QP	40.0	-13.2	1.31 H	22	37.3	-10.5
2	128.26	28.4 QP	43.5	-15.1	1.64 H	178	38.3	-9.9
3	225.02	28.7 QP	46.0	-17.3	1.97 H	120	39.2	-10.5
4	300.00	34.3 QP	46.0	-11.7	1.11 H	64	40.2	-5.9
<b>5</b>	<b>383.86</b>	<b>35.1 QP</b>	<b>46.0</b>	<b>-10.9</b>	<b>1.45 H</b>	<b>122</b>	<b>38.9</b>	<b>-3.8</b>
6	475.04	32.5 QP	46.0	-13.5	1.78 H	41	34.2	-1.7

#### Remarks:

1. Emission Level(dBuV/m) = Raw Value(dBuV) + Correction Factor(dB/m)
2. Correction Factor(dB/m) = Antenna Factor(dB/m) + Cable Factor(dB) – Pre-Amplifier Factor(dB)
3. Margin value = Emission Level – Limit value
4. The other emission levels were very low against the limit of frequency range 30 MHz ~ 1 GHz.
5. The emission levels were very low against the limit of frequency range 9 kHz ~ 30 MHz: the amplitude of spurious emissions attenuated more than 20 dB below the permissible value to be report.

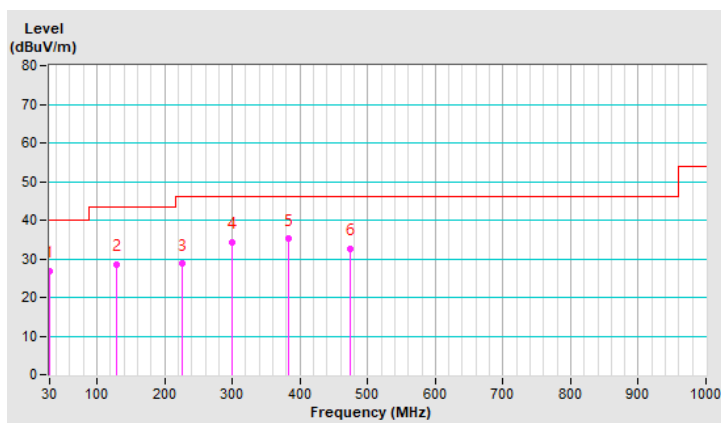

<b>RF Mode</b>	BT-LE 1M	<b>Channel</b>	CH 39 : 2480 MHz
<b>Frequency Range</b>	30 MHz ~ 1 GHz	<b>Detector Function &amp; Bandwidth</b>	(QP) RB = 120kHz
<b>Input Power</b>	120 Vac, 60 Hz	<b>Environmental Conditions</b>	19°C, 64% RH
<b>Tested By</b>	Jed Wu		

Antenna Polarity & Test Distance : Vertical at 3 m								
No	Frequency (MHz)	Emission Level (dBuV/m)	Limit (dBuV/m)	Margin (dB)	Antenna Height (m)	Table Angle (Degree)	Raw Value (dBuV)	Correction Factor (dB/m)
1	38.34	27.3 QP	40.0	-12.7	1.47 V	140	36.7	-9.4
2	165.90	24.8 QP	43.5	-18.7	1.58 V	70	32.9	-8.1
3	289.86	26.0 QP	46.0	-20.0	1.69 V	178	32.2	-6.2
4	370.18	28.0 QP	46.0	-18.0	1.71 V	111	32.2	-4.2
5	446.42	30.6 QP	46.0	-15.4	1.82 V	159	32.8	-2.2
6	531.59	32.6 QP	46.0	-13.4	1.93 V	157	33.4	-0.8

**Remarks:**

1. Emission Level(dBuV/m) = Raw Value(dBuV) + Correction Factor(dB/m)
2. Correction Factor(dB/m) = Antenna Factor(dB/m) + Cable Factor(dB) – Pre-Amplifier Factor(dB)
3. Margin value = Emission Level – Limit value
4. The other emission levels were very low against the limit of frequency range 30 MHz ~ 1 GHz.
5. The emission levels were very low against the limit of frequency range 9 kHz ~ 30 MHz: the amplitude of spurious emissions attenuated more than 20 dB below the permissible value to be report.

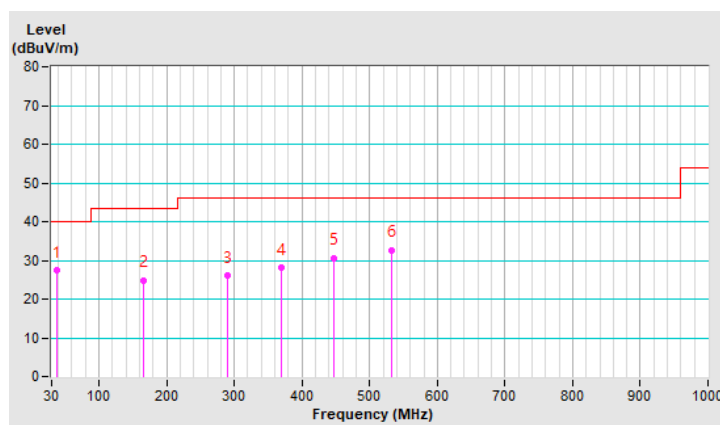



**Mode C**

<b>Frequency Range</b>	30 MHz ~ 1 GHz	<b>Detector Function &amp; Bandwidth</b>	(QP) RB = 120kHz
<b>Input Power</b>	120 Vac, 60 Hz	<b>Environmental Conditions</b>	23°C, 67% RH
<b>Tested By</b>	Jed Wu		

Antenna Polarity & Test Distance : Horizontal at 3 m								
No	Frequency (MHz)	Emission Level (dBuV/m)	Limit (dBuV/m)	Margin (dB)	Antenna Height (m)	Table Angle (Degree)	Raw Value (dBuV)	Correction Factor (dB/m)
1	42.61	24.9 QP	40.0	-15.1	1.84 H	159	33.7	-8.8
2	166.77	29.1 QP	43.5	-14.4	2.10 H	185	37.2	-8.1
3	239.52	30.6 QP	46.0	-15.4	2.39 H	213	39.0	-8.4
4	301.60	30.7 QP	46.0	-15.3	2.70 H	244	36.5	-5.8
5	368.53	28.9 QP	46.0	-17.1	2.98 H	272	33.1	-4.2
6	474.26	28.3 QP	46.0	-17.7	3.30 H	304	30.0	-1.7
7	627.52	30.6 QP	46.0	-15.4	3.84 H	357	28.8	1.8

**Remarks:**

1. Emission Level(dBuV/m) = Raw Value(dBuV) + Correction Factor(dB/m)
2. Correction Factor(dB/m) = Antenna Factor(dB/m) + Cable Factor(dB) – Pre-Amplifier Factor(dB)
3. Margin value = Emission Level – Limit value
4. The other emission levels were very low against the limit of frequency range 30 MHz ~ 1 GHz.
5. The emission levels were very low against the limit of frequency range 9 kHz ~ 30 MHz: the amplitude of spurious emissions attenuated more than 20 dB below the permissible value to be report.

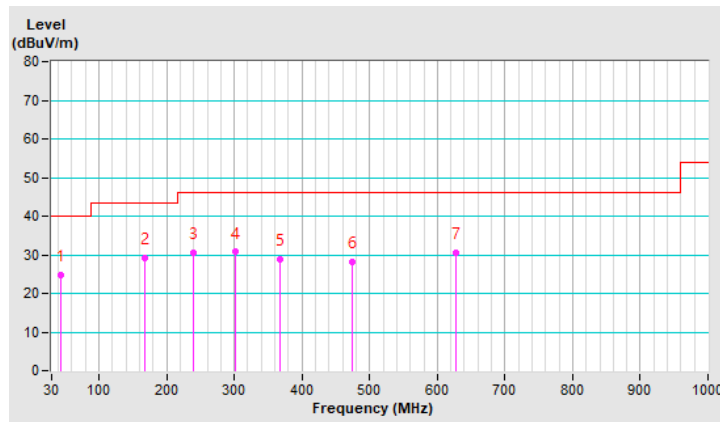

<b>Frequency Range</b>	30 MHz ~ 1 GHz	<b>Detector Function &amp; Bandwidth</b>	(QP) RB = 120kHz
<b>Input Power</b>	120 Vac, 60 Hz	<b>Environmental Conditions</b>	23°C, 67% RH
<b>Tested By</b>	Jed Wu		

Antenna Polarity & Test Distance : Vertical at 3 m								
No	Frequency (MHz)	Emission Level (dBuV/m)	Limit (dBuV/m)	Margin (dB)	Antenna Height (m)	Table Angle (Degree)	Raw Value (dBuV)	Correction Factor (dB/m)
1	48.43	25.7 QP	40.0	-14.3	1.52 V	54	33.9	-8.2
2	144.46	26.3 QP	43.5	-17.2	1.94 V	96	34.6	-8.3
3	232.73	29.8 QP	46.0	-16.2	2.35 V	137	39.4	-9.6
4	275.41	31.1 QP	46.0	-14.9	2.68 V	169	37.5	-6.4
5	399.57	30.2 QP	46.0	-15.8	3.08 V	209	33.7	-3.5
6	530.52	29.9 QP	46.0	-16.1	3.34 V	235	30.7	-0.8

**Remarks:**

1. Emission Level(dBuV/m) = Raw Value(dBuV) + Correction Factor(dB/m)
2. Correction Factor(dB/m) = Antenna Factor(dB/m) + Cable Factor(dB) – Pre-Amplifier Factor(dB)
3. Margin value = Emission Level – Limit value
4. The other emission levels were very low against the limit of frequency range 30 MHz ~ 1 GHz.
5. The emission levels were very low against the limit of frequency range 9 kHz ~ 30 MHz: the amplitude of spurious emissions attenuated more than 20 dB below the permissible value to be report.

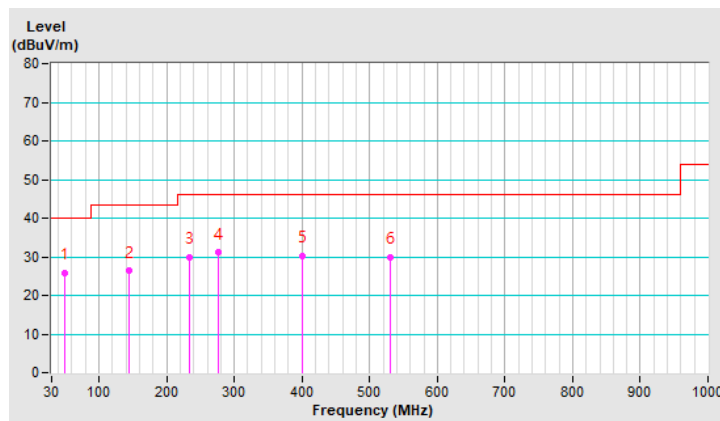

## 7.7 Unwanted Emissions above 1 GHz

### Mode A

<b>RF Mode</b>	BT-LE 1M	<b>Channel</b>	CH 0 : 2402 MHz
<b>Frequency Range</b>	1 GHz ~ 25 GHz	<b>Detector Function &amp; Bandwidth</b>	(PK) RB = 1 MHz, VB = 3 MHz (AV) RB = 1 MHz, VB = 3 kHz
<b>Input Power</b>	120 Vac, 60 Hz	<b>Environmental Conditions</b>	24°C, 69% RH
<b>Tested By</b>	Ian Chang		

Antenna Polarity & Test Distance : Horizontal at 3 m								
No	Frequency (MHz)	Emission Level (dBuV/m)	Limit (dBuV/m)	Margin (dB)	Antenna Height (m)	Table Angle (Degree)	Raw Value (dBuV)	Correction Factor (dB/m)
1	2390.00	56.8 PK	74.0	-17.2	1.01 H	351	58.1	-1.3
2	2390.00	43.1 AV	54.0	-10.9	1.01 H	351	44.4	-1.3
3	*2402.00	100.1 PK			1.01 H	351	101.4	-1.3
4	*2402.00	99.7 AV			1.01 H	351	101.0	-1.3
5	4804.00	46.5 PK	74.0	-27.5	1.13 H	42	39.9	6.6
6	4804.00	36.4 AV	54.0	-17.6	1.13 H	42	29.8	6.6
Antenna Polarity & Test Distance : Vertical at 3 m								
No	Frequency (MHz)	Emission Level (dBuV/m)	Limit (dBuV/m)	Margin (dB)	Antenna Height (m)	Table Angle (Degree)	Raw Value (dBuV)	Correction Factor (dB/m)
1	2390.00	55.1 PK	74.0	-18.9	1.06 V	268	56.4	-1.3
2	2390.00	42.4 AV	54.0	-11.6	1.06 V	268	43.7	-1.3
3	*2402.00	97.3 PK			1.06 V	268	98.6	-1.3
4	*2402.00	96.8 AV			1.06 V	268	98.1	-1.3
5	4804.00	47.5 PK	74.0	-26.5	1.41 V	354	40.9	6.6
6	4804.00	38.3 AV	54.0	-15.7	1.41 V	354	31.7	6.6

#### Remarks:

1. Emission Level(dBuV/m) = Raw Value(dBuV) + Correction Factor(dB/m)
2. Correction Factor(dB/m) = Antenna Factor(dB/m) + Cable Factor(dB) – Pre-Amplifier Factor(dB)
3. Margin value = Emission Level – Limit value
4. The other emission levels were very low against the limit.
5. " \* ": Fundamental frequency, the limit was restricted at the RF Output Power.



<b>RF Mode</b>	BT-LE 1M	<b>Channel</b>	CH 19 : 2440 MHz
<b>Frequency Range</b>	1 GHz ~ 25 GHz	<b>Detector Function &amp; Bandwidth</b>	(PK) RB = 1 MHz, VB = 3 MHz (AV) RB = 1 MHz, VB = 3 kHz
<b>Input Power</b>	120 Vac, 60 Hz	<b>Environmental Conditions</b>	24°C, 69% RH
<b>Tested By</b>	Ian Chang		

Antenna Polarity & Test Distance : Horizontal at 3 m								
No	Frequency (MHz)	Emission Level (dBuV/m)	Limit (dBuV/m)	Margin (dB)	Antenna Height (m)	Table Angle (Degree)	Raw Value (dBuV)	Correction Factor (dB/m)
1	*2440.00	100.1 PK			1.00 H	277	101.2	-1.1
2	*2440.00	99.4 AV			1.00 H	277	100.5	-1.1
3	4880.00	46.0 PK	74.0	-28.0	1.21 H	52	39.3	6.7
4	4880.00	36.6 AV	54.0	-17.4	1.21 H	52	29.9	6.7

Antenna Polarity & Test Distance : Vertical at 3 m								
No	Frequency (MHz)	Emission Level (dBuV/m)	Limit (dBuV/m)	Margin (dB)	Antenna Height (m)	Table Angle (Degree)	Raw Value (dBuV)	Correction Factor (dB/m)
1	*2440.00	97.3 PK			1.05 V	265	98.4	-1.1
2	*2440.00	96.8 AV			1.05 V	265	97.9	-1.1
3	4880.00	47.0 PK	74.0	-27.0	1.51 V	344	40.3	6.7
4	4880.00	37.9 AV	54.0	-16.1	1.51 V	344	31.2	6.7

**Remarks:**

1. Emission Level(dBuV/m) = Raw Value(dBuV) + Correction Factor(dB/m)
2. Correction Factor(dB/m) = Antenna Factor(dB/m) + Cable Factor(dB) – Pre-Amplifier Factor(dB)
3. Margin value = Emission Level – Limit value
4. The other emission levels were very low against the limit.
5. " \* " : Fundamental frequency, the limit was restricted at the RF Output Power.



<b>RF Mode</b>	BT-LE 1M	<b>Channel</b>	CH 39 : 2480 MHz
<b>Frequency Range</b>	1 GHz ~ 25 GHz	<b>Detector Function &amp; Bandwidth</b>	(PK) RB = 1 MHz, VB = 3 MHz (AV) RB = 1 MHz, VB = 3 kHz
<b>Input Power</b>	120 Vac, 60 Hz	<b>Environmental Conditions</b>	24°C, 69% RH
<b>Tested By</b>	Ian Chang		

**Antenna Polarity & Test Distance : Horizontal at 3 m**

No	Frequency (MHz)	Emission Level (dBuV/m)	Limit (dBuV/m)	Margin (dB)	Antenna Height (m)	Table Angle (Degree)	Raw Value (dBuV)	Correction Factor (dB/m)
1	*2480.00	99.2 PK			1.43 H	302	100.3	-1.1
2	*2480.00	98.7 AV			1.43 H	302	99.8	-1.1
3	2483.50	63.2 PK	74.0	-10.8	1.43 H	302	64.2	-1.0
4	<b>2483.50</b>	<b>46.0 AV</b>	<b>54.0</b>	<b>-8.0</b>	<b>1.43 H</b>	<b>302</b>	<b>47.0</b>	<b>-1.0</b>
5	4960.00	46.4 PK	74.0	-27.6	1.11 H	48	39.6	6.8
6	4960.00	36.4 AV	54.0	-17.6	1.11 H	48	29.6	6.8

**Antenna Polarity & Test Distance : Vertical at 3 m**

No	Frequency (MHz)	Emission Level (dBuV/m)	Limit (dBuV/m)	Margin (dB)	Antenna Height (m)	Table Angle (Degree)	Raw Value (dBuV)	Correction Factor (dB/m)
1	*2480.00	96.5 PK			1.13 V	258	97.6	-1.1
2	*2480.00	95.8 AV			1.13 V	258	96.9	-1.1
3	2483.50	60.3 PK	74.0	-13.7	1.13 V	258	61.3	-1.0
4	2483.50	43.4 AV	54.0	-10.6	1.13 V	258	44.4	-1.0
5	4960.00	47.0 PK	74.0	-27.0	1.52 V	355	40.2	6.8
6	4960.00	37.2 AV	54.0	-16.8	1.52 V	355	30.4	6.8

**Remarks:**

1. Emission Level(dBuV/m) = Raw Value(dBuV) + Correction Factor(dB/m)
2. Correction Factor(dB/m) = Antenna Factor(dB/m) + Cable Factor(dB) – Pre-Amplifier Factor(dB)
3. Margin value = Emission Level – Limit value
4. The other emission levels were very low against the limit.
5. " \* ": Fundamental frequency, the limit was restricted at the RF Output Power.



### Mode A\_Plot of Band Edge

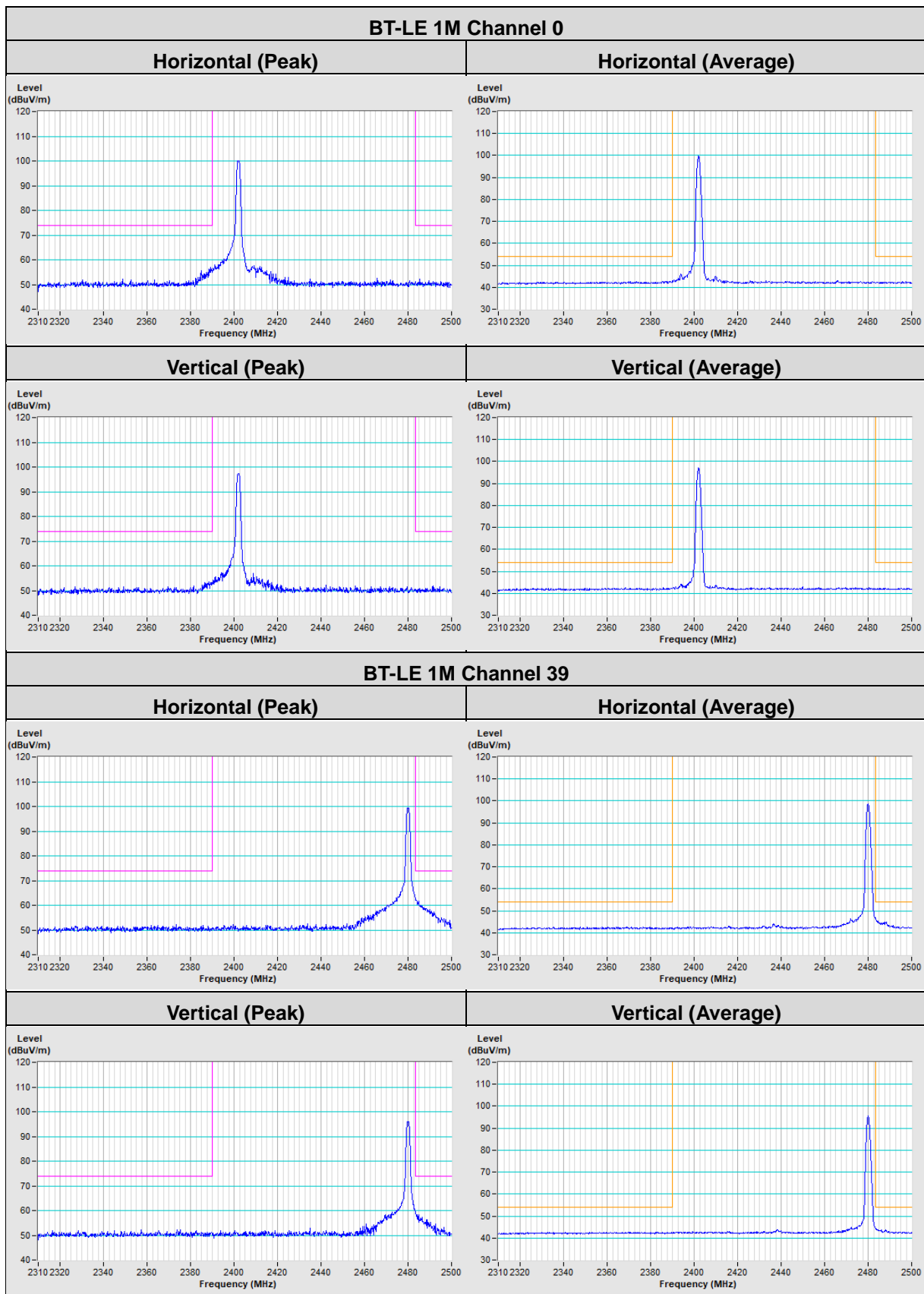

## 8 Pictures of Test Arrangements

Please refer to the attached file (Test Setup Photo)

## 9 Information of the Testing Laboratories

We, Bureau Veritas Consumer Products Services (H.K.) Ltd., Taoyuan Branch, were founded in 1988 to provide our best service in EMC, Radio, Telecom and Safety consultation. Our laboratories are FCC recognized accredited test firms and accredited according to ISO/IEC 17025.

If you have any comments, please feel free to contact us at the following:

**Lin Kou EMC/RF Lab**

Tel: 886-2-26052180

Fax: 886-2-26051924

**Hsin Chu EMC/RF/Telecom Lab**

Tel: 886-3-6668565

Fax: 886-3-6668323

**Hwa Ya EMC/RF/Safety Lab**

Tel: 886-3-3183232

Fax: 886-3-3270892

**Email:** [service.adt@bureauveritas.com](mailto:service.adt@bureauveritas.com)

**Web Site:** <http://ee.bureauveritas.com.tw>

The address and road map of all our labs can be found in our web site also.

--- END ---